

NEC

NDA-24230
DOI-E10504
ISSUE 2
STOCK # 0293884

VisuaLink 128/384

User Guide

DECEMBER, 1998

NEC America, Inc.

LIABILITY DISCLAIMER

NEC America, Inc. reserves the right to change the specifications, functions, or features, at any time, without notice.

NEC America, Inc. has prepared this document for use by its employees and customers. The information contained herein is the property of NEC America, Inc. and shall not be reproduced without prior written approval from NEC America, Inc.

Copyright 1998

NEC America, Inc.

Printed in USA

FCC REQUIREMENTS

NEC America, Inc.
VisuaLink 128/VisuaLink 384

TYPE OF SERVICE

The VisuaLink 128 and the VisuaLink 384 are stand-alone devices that allow multimedia conferencing by transmitting video, audio and data to remote locations over the ISDN Basic Rate interface. The VisuaLink 128 and VisuaLink 384 connect to the ISDN digital network through separately-registered NTI equipment. They provide POTS ports which allow a customer-provided 2500-type telephone access to the digital network.

This equipment complies with Part 68 of the FCC Rules. The equipment label will appear on the rear exterior panel of the unit and will provide the FCC Registration Number, NEC trade name, model number, serial number or date of manufacture and the country of origin.

TELEPHONE COMPANY PROCEDURES

The goal of the telephone company is to provide you with the best service it can. In order to do this, it may occasionally be necessary for them to make changes in their equipment, operations, or procedures. If these changes might affect your service or the operation of your equipment, the telephone company will give you notice, in writing, to allow you to make any changes necessary to maintain uninterrupted service.

If you have any questions about your telephone line, such as how many pieces of equipment you can connect to it, the telephone company will give you notice, in writing, to allow you to make any changes necessary to maintain uninterrupted service.

In certain circumstances, it may be necessary for the telephone company to request from you concerning the equipment which you have connected to your telephone line. Upon request of the telephone company, provide the FCC registration number and the ringer equivalence number (REN) of the equipment which is connected to your line; both of these items are listed on the equipment label. The sum of all of the REN's on your telephone lines should be less than five in order to assure proper service from the telephone company. In some cases, a sum of five may not be usable on a given line.

IF PROBLEMS ARISE

If any of your telephone equipment is not operating properly, you should immediately remove it from your telephone lines, as it may cause harm to the telephone network. If the telephone company notes a problem, they may temporarily discontinue service. When practical, they will notify you in advance of this disconnection. If advance notice is not feasible, you will be notified as soon as possible. When you are notified, you will be given the opportunity to correct the problem and informed of your right to file a complaint with the FCC.

In the event repairs are ever needed on your Visualink 128 or VisuaLink 384, they should be performed by NEC America, Inc. or an authorized representative of NEC America, Inc. For information contact:

NEC America, Inc.
1555 W. Walnut Hill Lane
Irving, Texas 75038-3797
USA
972-751-7000

FCC REQUIREMENTS FOR CONNECTION OF TELEPHONE SYSTEMS

In order to connect this system to the telephone network, provide the telephone company with:

- the quantities and USOC numbers of the required jacks (shown below);
- the sequence in which the trunks are to be connected;
- the facility interface codes by position; and
- the ringer equivalence number or service code, as applicable, by position

MFG's Port ID	USOC Jack Connector	REN/Service Code	Facility Interface Code	# CO Ports	# Stations	Registration #
VisuaLink 128	N/A	6.0P	02IS5	1	1	AY5JPN-32617-XD-N
VisuaLink 384	N/A	6.0P	02IS5	3	1	AY5JPN-32617-XD-N

CSA Requirement

To ensure that certified equipment is attached correctly, and only to the networks of participating carriers, the following statement shall accompany each unit of certified equipment offered for sale. This statement must be included conspicuously in written or electronic format, at or near the front of each copy of the operating manual, or accompany other technical information, or be included as a separate sheet. The required statement is:

CP-01, Issue 8, Part I
Section 14.1

NOTICE: The Industry Canada label identifies certified equipment. This certification means that the equipment meets certain telecommunications network protective, operational and safety requirements as prescribed in the appropriate Terminal Equipment Technical Requirements document(s). The Department does not guarantee the equipment will operate to the user's satisfaction.

Before installing this equipment, users should ensure that it is permissible to be connected to the facilities of the local telecommunications company. The equipment must also be installed using an acceptable method of connection. The customer should be aware that compliance with the above conditions may not prevent degradation of service in some situations.

Repairs to certified equipment should be coordinated by a representative designated by the supplier. Any repairs or alterations made by the user to this equipment, or equipment malfunctions, may give the telecommunications company cause to request the user to disconnect the equipment.

Users should ensure for their own protection that the electrical ground connections of the power utility, telephone lines and internal metallic water pipe system, if present, are connected together. This precaution may be particularly important in rural areas.

CAUTION: Users should not attempt to make such connections themselves, but should contact the appropriate electric inspection

MODEL	CERTIFICATE NUMBER	CERTIFICATION NUMBER
VisuaLink 128	19318	140 9004A
VisuaLink 384	19603	140 9104A



Table of Contents

Chapter 1	Introducing Your VisuaLink	1-1
	Applying for ISDN BRI	1-1
	Unpacking	1-2
Chapter 2	Introduction of VisuaLink	2-1
	About your VisuaLink	2-1
	Front Panel Description	2-2
	VisuaLink 128 Rear Panel Description	2-3
	VisuaLink 384 Rear Panel Description	2-4
	Remote Controller	2-9
Chapter 3	Initial Setting and Operation Checking	3-1
Chapter 4	Application Setup	4-1
	Guidelines	4-1
	Hardware	4-2
	Software Setup	4-23
	Setting Up your ISDN Line Information	4-24
	Optional User Settings	4-27
Chapter 5	System Parameter/Environment Setting	5-1
	Environment Setting Menu	5-1
	Video Setting	5-6
	Audio Setting	5-8
	Data Setting	5-11
	Communication Setting	5-13
	Local Setting	5-15
	Maintenance Settings	5-29
Chapter 6	About Calling	6-1
	Place a Manual Call	6-1
	Set Speed Dial Number	6-6
	End a Call	6-16
	Answer a Call	6-17
Chapter 7	Conference Mode	7-1
	How to Display the Conference Mode On-Screen Icons	7-1
	Picture-in-Picture Menu	7-4
	Camera Preset Menu	7-7
	Audio Conditioning	7-10

Chapter 8	Operation Method	8-1
	System Status	8-1
	Volume Control	8-3
	Muting Your Microphone	8-4
	Switching Monitor Screens	8-5
	Switching Camera Pictures	8-7
	PIP Functions	8-10
	Send a Snapshot	8-11
	Camera Functions	8-13
	Using Camera Preset	8-16
	Pointer Display	8-17
Chapter 9	VisuaLink Troubleshooting Guide	9-1
Appendix A	Audio/Data/Video Bit Rate Assignment Table	A-1
Appendix B	Software Upgrade Instructions	B-1
Appendix C	CALL Menu Structure	C-1
Appendix D	How to Order ISDN BRI	D-1

List of Figures

Figure 4-1: Connection Diagram for VisuaLink 128	4-2
Figure 4-2: Connection Diagram for VisuaLink 384	4-3
Figure 4-3: Connection Diagram for VisuaLink 128	4-5
Figure 4-4: Connection Diagram for VisuaLink 384	4-6
Figure 4-5: Connection Diagram for VisuaLink 128	4-9
Figure 4-6: Connection Diagram for VisuaLink 384	4-10
Figure 4-7: Equipment Placement	4-12

List of Tables

Table 1-1:	Parts List for the VL128 and VL384.....	1-2
Table 1-2:	Optional parts to be provided.....	1-3
Table 2-1:	VisuaLink 128 and VisuaLink 384 General Parameters	2-5
Table 2-2:	VisuaLink 128 and VisuaLink 384 External Interface Parameters....	2-7
Table 9-1:	Troubleshooting Guide	9-1

Chapter 1 Introducing Your VisuaLink

1.1 Applying for ISDN BRI

This device cannot be used unless a connection to **ISDN BRI Communication Line** is provided. Verify that a ISDN line exists before the CODEC is installed.

What to watch out for when filling out an ISDN BRI application:

As defined by Bellcore; the ISDN BRI simplified ordering code is EZ-ISDN1.

- The ISDN BRI protocol national ISDN-1.
- The ISDN BRI service must be tariffed and available from the customer's local central office.
- The D-Channel should not permit X.25 packet data.
- The ISDN BRI service must allow videoconferencing calls to be dialed on either B-Channel or on both simultaneously.
- Both B-Channel must carry circuit switched videoconferencing data.
- The ISDN BRI line required one or two different SPID numbers.
- The ISDN BRI service must be automatic Terminal Endpoint Identifiers (TEIs).

Voice and data features:

- Flexible calling
- Call forwarding variable
- Additional call offering
- Call number identification
- Redirecting number delivery

A **How to Order ISDN BRI Guide** has been prepared. This guide should be read thoroughly and forwarded to your Teleco provider. This document is located in the [Appendix D](#).

1.2 Unpacking

- Opening the Box

Please take out the device without giving any impact on it when opening the box. Please keep the box after opening it, since you may use it when you send the device for repair, maintenance and/or travel.

- The Contents of the Package

The VisuaLink 128 and VisuaLink 384 package contains the following items. Please verify these items are contained the box.

Table 1-1: Parts List for the VL128 and VL384



Item	Description
<p>(A) Main Unit</p> 	<p>This is the main unit of the VisuaLink 128 or VisuaLink 384.</p>
<p>(B) Remote controller and batteries</p> 	<p>This is a remote controller used to control the VisuaLink 128 or VisuaLink 384. Two AA batteries are also included.</p>
<p>(C) AC Adapter</p> 	<p>This is an AC adapter for VisuaLink 128 or VisuaLink 384.</p>
<p>(D) VisuaLink 128/384 User Guide</p>	<p>Provides procedures for installation, operations and maintenance of the VisuaLink 128 and VisuaLink 384.</p>

Table 1-1: Parts List for the VL128 and VL384 (continued)

<p>(E) Audio Video Cable</p> 	<p>This cable is used to connect peripheral devices such as camera and TV to the VisuaLink 128 or VisuaLink 384.</p>
--	--

Table 1-2: Optional parts to be provided



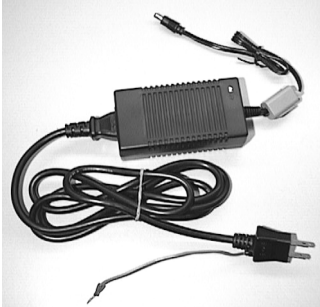



<p>(A) BRI Network Cable</p> 	<p>This cable is used to connect the VisuaLink 128 or VisuaLink 384 to an ISDN BRI network.</p> <p>Note: Three (3) cables are required for a VisuaLink 384.</p>
<p>(B) Microphone</p> 	<p>The microphone connects to the rear of the VisuaLink 128 or VisuaLink 384. There are 3 microphone inputs.</p>
<p>(C) Video Cable</p> 	<p>This cable is used to connect the VisuaLink 128 or VisuaLink 384 S-Video (output video) to a TV monitor.</p>

Table 1-2: Optional parts to be provided (continued)

<p>(D) Camera</p> 	<p>A pan/tilt zoom focus camera that provides a video image shot to the far-site.</p> <p>Note: Used in the turnkey rollabout configurations.</p>
<p>(E) PC Camera</p> 	<p>A fixed camera used to provide a one or two person shot to the far site.</p> <p>Note: Used in the desktop application.</p>
<p>(F) Monitor</p> 	<p>A TV monitor to provide for viewing of the far-site.</p> <p>Note: Provided with the turnkey rollabout configuration.</p>
<p>(G) Cabinet</p> 	<p>A equipment stand to house all the Rollabout peripherals such as the VisuaLink and NT1's.</p> <p>Note: Cabinet is used for the turnkey rollabout configuration.</p>

Chapter 2 Introduction of VisuaLink

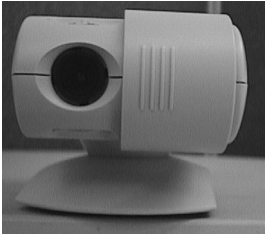
2.1 About your VisuaLink

The VisuaLink 128 and the VisuaLink 384 are devices that easily realize a multimedia conference by transmitting video, audio, and data to a remote location with the use of BRI service. The VisuaLink 128 and VisuaLink 384 provide a low-end TV conference for a small group of people when connected to a hands-free telephone. In addition, with a connection with a PC, a TV conference using data conference application such as an electric presentation will be available. The VisuaLink 128 and VisuaLink 384 also provide a high-performance model with a built-in echo canceller applicable for video conferences with microphones and speakers in a conference room.

2.1.1 The characteristics of VisuaLink 128 are

- You can use it as a high quality TV phone by connecting a TV, telephone, and video camera.
- You can use it as a serious business videoconference system by connecting optional video camera, microphone, and speakers.
- You can easily operate it from a telephone or a remote controller.
- You can connect any PC model for a conference with a PC. (However, a data conference software is required in your PC. Please contact to sales rep. to get information for what type of software is available for the data conference with the VL128.

2.1.2 The characteristics of VisuaLink 384 are the same as those for the VisuaLink 128 listed above, plus

- It has an internal IMUX.
- You can connect to three (3) NT-1s.

2.2 Front Panel Description

This section briefly describes names and features of the VisuaLink 128 and VisuaLink 384.

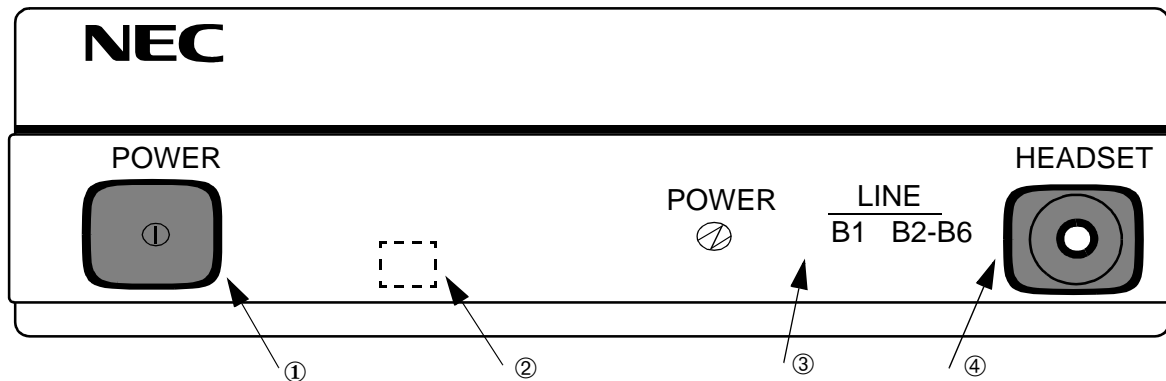

① POWER Switch

The push-button switch is used to turn on and off the main power. When the power is on, the power lamp will be lit.

② Remote controller optical receiver

This is a optical receiver, which receives signal from remote controller.

③ LED Display

Power Lamp (power) : a green light will eluminate when the power is ON.
When the VisuaLink is powered OFF, there is no light.

Line connection status lamp (LINE)

LINE B1: Flashing light indicates channel is calling to the remote end.

Steady light indicates connection/communicating with the remote end.

LINE B2-B6: Flashing light indicates channel is calling to the remote end.

Steady light indicates connection/communicating with the remote end.

④ Head set terminal

The head set jack is used to connect an optional headset.

2.3 VisuaLink 128

Rear Panel Description

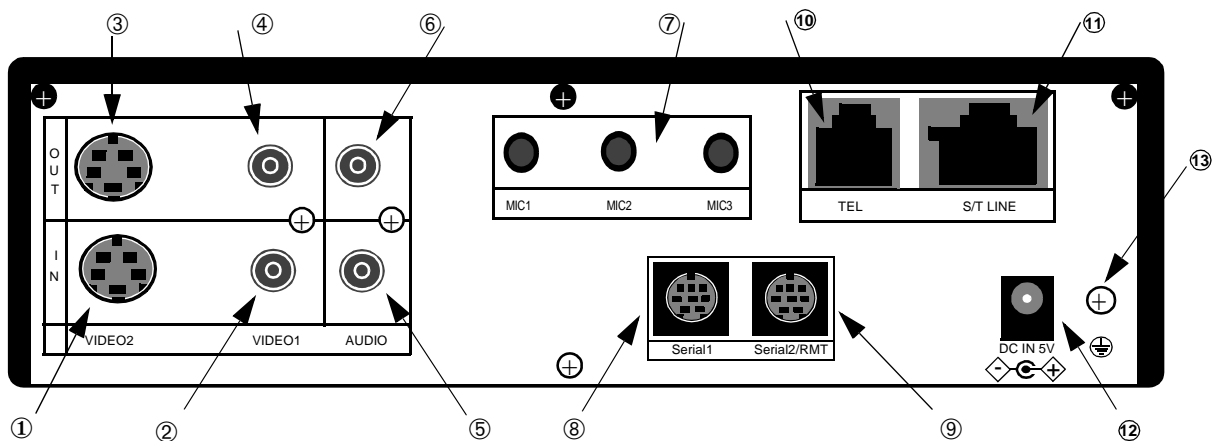

- ① VIDEO 2 IN (S-Video input): Provides an S-Video input connection for a camera or other video source.
- ② VIDEO 1 IN (NTSC input): Provides a composite input connection for a camera or other video source.
- ③ VIDEO 2 OUT (S-Video output): Provides an S-Video output connection to a monitor or other display device.
- ④ VIDEO 1 OUT (NTSC output): Provides a composite output connection to a monitor or other display device.
- ⑤ AUDIO IN: Provides a line level audio input from a VCR, audio mixer, other audio transmission device or External Echo Canceller connection.
- ⑥ AUDIO OUT (AUX output): Provides a line level audio output to an amplified speaker, other audio receiver device or External Echo Canceller connection.
- ⑦ MIC 1~3: Mini stereo phono plugs connection for one to three microphones.
- ⑧ SERIAL 1 (RS232C input): Provides a mini din connection conforming to RS232 for connection to a PC or other data device.
- ⑨ SERIAL 2/ RMT (RS232C input/output): Provides a mini din connection conforming to RS232 for connection to a PC, camera or other RS232 device.
- ⑩ TEL terminal: Provides an RJ11 jack for connecting the VoicePoint or other two wire telephone.
- ⑪ S/T LINE terminal: Provides an ISDN BRI S interface used to connect to the communication data line.
- ⑫ DC power input terminal: Provides an AC adapter interface for AC power.
- ⑬ Grounding terminal: Provides a ground connection at should be connected to earth ground.

2.4 VisuaLink 384 Rear Panel Description

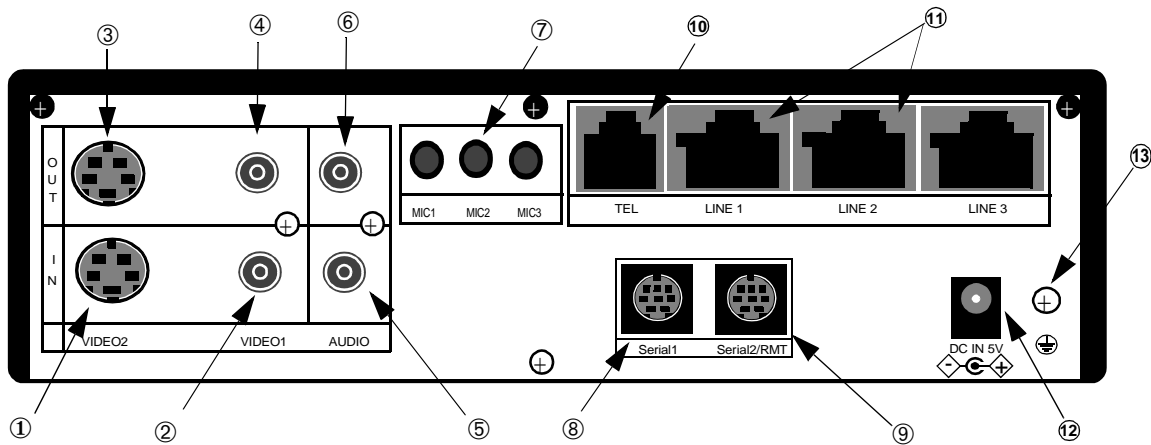

- ① VIDEO 2 IN (S-Video input): Provides an S-Video input connection for a camera or other video source.
- ② VIDEO 1 IN (NTSC input): Provides a composite input connection for a camera or other video source.
- ③ VIDEO 2 OUT (S-Video output): Provides an S-Video output connection to a monitor or other display device.
- ④ VIDEO 1 OUT (NTSC output): Provides a composite output connection to a monitor or other display device.
- ⑤ AUDIO IN: Provides a line level audio input from a VCR, audio mixer, other audio transmission device or External Echo Canceller connection.
- ⑥ AUDIO OUT (AUX output): Provides a line level audio output to an amplified speaker, other audio receiver device or External Echo Canceller connection.
- ⑦ MIC 1~3: Mini stereo phono plugs connection for one to three microphones.
- ⑧ SERIAL 1 (RS232C input): Provides a mini din connection conforming to RS232 for connection to a PC or other data device.
- ⑨ SERIAL 2/ RMT (RS232C input/output): Provides a mini din connection conforming to RS232 for connection to a PC, camera or other RS232 device.
- ⑩ TEL terminal: Provides an RJ11 jack for connecting the VoicePoint or other two wire telephone.
- ⑪ S/T LINE terminal: Provides three (3) ISDN BRI S interfaces to connect to the communication data line.
- ⑫ DC power input terminal: Provides an AC adapter interface for AC power.
- ⑬ Grounding terminal: Provides a ground connection at should be connected to earth ground.

Table 2-1: VisuaLink 128 and VisuaLink 384 General Parameters

Parameter		VisuaLink 128	VisuaLink 384
Line	Connection Line Type	Basic Rate Interface (BRI) National ISDN-1	Basic Rate Interface (BRI) National ISDN-1
	Transmission Speed	<ul style="list-style-type: none"> • TEL • 64 Kbps (B) • 2x64 Kbps (2B) • Upgradeable to 384 Kbps Note: P x 56 Kbps mode complies with B and 2B	<ul style="list-style-type: none"> • TEL • 64 Kbps (B), 2 x 64kbps (2B) • 128, 192, 256, 320, 384 Kbps • 56, 112, 168, 224, 280, 336kbps Note: P x 56kbps mode complies with B and 2B.
	Interface	One RJ-45 Modular Jack	Three RJ-45 Modular Jacks
Video	Compression	H. 261, H.263	H. 261, H.263
	Resolution	<ul style="list-style-type: none"> • CIF (resolution: 352x288) (H.261) • QCIF (resolution: 176x144) (H.263) • Annex D (720x480) still graphic transmission / reception 	<ul style="list-style-type: none"> • CIF (resolution: 352x288) (H.261) • QCIF (resolution: 176x144) (H.263) • Annex D (720x480) still graphic transmission / reception
	Input / Output Interface	<ul style="list-style-type: none"> • NTSC composite: 1 input, 1 output (RCA pin jack) • S-Video component: 1 input, 1 output (DIN 4-pin) 	<ul style="list-style-type: none"> • NTSC composite: 1 input, 1 output (RCA pin jack) • S-Video component: 1 input, 1 output (DIN 4-pin)
Camera	Protcol	H/281, NEC video method	H/281, NEC video method
	Control	VCCI, D3O	VCCI, D3O
Audio	Compression	<ul style="list-style-type: none"> • G.711 (3.4kHz) • G.722 (7kHz) • G.728 (3.4kHz) 	<ul style="list-style-type: none"> • G.711 (3.4kHz) • G.722 (7kHz) • G.728 (3.4kHz)
	Echo Control	7kHz built-in echo canceller	7kHz built-in echo canceller
	Input / Output Interface	<ul style="list-style-type: none"> • Line Audio: 1 input, 1 output (RCA pin jack) • Headset: 1 input, 1 output (stereo mini plug) • Analog phone port: 1 input 1 output (RJ-11 modular jack) • Microphone input port: 3 inputs (mono mini plug) 	<ul style="list-style-type: none"> • Line Audio: 1 input, 1 output (RCA pin jack) • Headset: 1 input, 1 output (stereo mini plug) • Analog phone port: 1 input, 1 output (RJ-11 modular jack) • Microphone input port: 3 inputs (mono mini plug)
Data	Serial	<ul style="list-style-type: none"> • Ports: 2 Serial (DIN 8-pin) • Speed: 1.2-38.4 Kbps, asynchronous • Start-Stop synchronization 	<ul style="list-style-type: none"> • Ports: 2 Serial (DIN 8-pin) • Speed: 1.2-38.4 Kbps, asynchronous • Start-Stop synchronization
	Control	<ul style="list-style-type: none"> • PC control • Camera control • T/120 data transmission • Generic data transmission 	<ul style="list-style-type: none"> • PC control • Camera control • T/120 data transmission • Generic data transmission

Table 2-1: VisuaLink 128 and VisuaLink 384 General Parameters (continued)

Parameter	VisuaLink 128	VisuaLink 384
User Interface	<ul style="list-style-type: none"> • Wireless remote control (built-in IR receiver) • PC connected (with serial port) PC software sold separately is required • Telephone (for analog line, 2-line cable, RJ-11) 	<ul style="list-style-type: none"> • Wireless remote control (built-in IR receiver) • PC connected (with serial port) PC software sold separately is required • Telephone (for analog line, 2-line cable, RJ-11)
Unit Size	<ul style="list-style-type: none"> • Dimensions: 10"(W) x 7"(D) x 2.25" (H) (254 mm x 177 mm x 57 mm) • Weight: less than 5 lbs. (3 kg.) 	<ul style="list-style-type: none"> • Dimensions: 10"(W) x 7"(D) x 2.25" (H) (254 mm x 177 mm x 57 mm) • Weight: less than 5 lbs. (3 kg.)
Power Requirements	Attached external AC adapter: <ul style="list-style-type: none"> • Input Voltage: 90-110 VAC, 50-60 Hz • Output Voltage: +5VDC @ 4.2 A (max) 	Attached external AC adapter: <ul style="list-style-type: none"> • Input Voltage: 90-110 VAC, 50-60 Hz • Output Voltage: +5VDC @ 4.2 A (max)
Operating Environment	<ul style="list-style-type: none"> • Temperature: 40°-104° F (5°-40° C) • Humidity: 20-80%, Non-condensing 	<ul style="list-style-type: none"> • Temperature: 40°-104° F (5°-40° C) • Humidity: 20-80%, Non-condensing

Table 2-2: VisuaLink 128 and VisuaLink 384 External Interface Parameters

Parameter		VisuaLink 128	VisuaLink 384
Line Interface		<ul style="list-style-type: none"> • Applicable Line: <ol style="list-style-type: none"> (1) ISDN BRI (2) High speed digital leased line • Interface: National ISDN-1 • Connector: 1 Modular jack (RJ-45) • Transmission speed: 64/56 Kbps B, 2x64/2x56 Kbps 2B 	<ul style="list-style-type: none"> • Applicable Line: <ol style="list-style-type: none"> (1) ISDN BRI (2) High speed digital leased line • Interface: National ISDN-1 • Connectors: 3 Modular jacks (RJ-45) • Transmission speed: <ol style="list-style-type: none"> 1) 64, 128 192, 256, 320, 384 Kbps 2) 56, 112, 168, 224, 280, 336kbps
Video Input	Video 1 In	<ul style="list-style-type: none"> • Standard: NTSC composite signal (525 line, 59.94Hz) • Connector: RCA pin jack 	<ul style="list-style-type: none"> • Standard: NTSC composite signal (525 line, 59.94Hz) • Connector: RCA pin jack
	Video 2 In	<ul style="list-style-type: none"> • Standard: S-Video Component signal (525 line, 59.94Hz) • Connector: DIN 4-pin 	<ul style="list-style-type: none"> • Standard: S-Video Component signal (525 line, 59.94Hz) • Connector: DIN 4-pin
Video Output	Video 1 Out	<ul style="list-style-type: none"> • Standard: NTSC composite signal (525 line, 59.94Hz) • Connector: RCA pin jack 	<ul style="list-style-type: none"> • Standard: NTSC composite signal (525 line, 59.94Hz) • Connector: RCA pin jack
	Video 2 Out	<ul style="list-style-type: none"> • Standard: S-Video Component signal (525 line, 59.94Hz) • Connector: DIN 4-pin 	<ul style="list-style-type: none"> • Standard: S-Video Component signal (525 line, 59.94Hz) • Connector: DIN 4-pin
Audio Input	Line Audio In	<ul style="list-style-type: none"> • Input level: -10dBv • Excessive Load Level:+3dB (G711, G728), +9dB (G722) • Input Impedance: High impedance, unbalanced • Connector: RCA pin jack 	<ul style="list-style-type: none"> • Input level: -10dBv • Excessive Load Level:+3dB (G711, G728), +9dB (G722) • Input Impedance: High impedance, unbalanced • Connector: RCA pin jack
	Headset Input	(Using recommended headset): <ul style="list-style-type: none"> • Microphone: Electric condenser type (power supply voltage +25V) • Input impedance: High impedance 	(Using recommended headset): <ul style="list-style-type: none"> • Microphone: Electric condenser type (power supply voltage +25V) • Input impedance: High impedance
	Microphone Input	(Using recommended microphone): <ul style="list-style-type: none"> • Number of connections: 3 • Applicable microphone: Electric condenser type (power supply voltage + 15V) • Impedance: Low impedance 	(Using recommended microphone): <ul style="list-style-type: none"> • Number of connections: 3 • Applicable microphone: Electric condenser type (power supply voltage + 15V) • Impedance: Low impedance

Table 2-2: VisuaLink 128 and VisuaLink 384 External Interface Parameters (continued)

Parameter		VisuaLink 128	VisuaLink 384
Audio Output	Line Audio Out	<ul style="list-style-type: none"> • Output level: -10dBv • Excessive Load Level: +3dB (G711, G728), +9dB (G722) • Output Impedance: Low impedance, unbalanced • Connector: RCA pin jack 	<ul style="list-style-type: none"> • Output level: -10dBv • Excessive Load Level: +3dB (G711, G728), +9dB (G722) • Output Impedance: Low impedance, unbalanced • Connector: RCA pin jack
	Headset Output	(Using recommended headset): <ul style="list-style-type: none"> • Speaker: Dynamic speaker • Impedance: Low impedance 	(Using recommended headset): <ul style="list-style-type: none"> • Speaker: Dynamic speaker • Impedance: Low impedance
Serial Port	Serial 1	<ul style="list-style-type: none"> • Connector: DIN 8-pin • Communication speed: 1.2~38.4 Kbps, start stop synchronization 	<ul style="list-style-type: none"> • Connector: DIN 8-pin • Communication speed: 1.2~38.4 Kbps, start stop synchronization
	Serial 2 / RMT	<ul style="list-style-type: none"> • Connector: DIN 8-pin • Communication speed: 1.2~38.4 Kbps, start stop synchronization 	<ul style="list-style-type: none"> • Connector: DIN 8-pin • Communication speed: 1.2~38.4 Kbps, start stop synchronization
Analog Phone Interface		<ul style="list-style-type: none"> • Connecting cable: 2-line cable • Connector: 6-pin modular jack (RJ-11) 	<ul style="list-style-type: none"> • Connecting cable: 2-line cable • Connector: 6-pin modular jack (RJ-11)
AC Adapter Interface		<ul style="list-style-type: none"> • Voltage: +5VDC • Polarity: + inside, - outside • Connector: EIAJ RC-5320A applicable 	<ul style="list-style-type: none"> • Voltage: +5VDC • Polarity: + inside, - outside • Connector: EIAJ RC-5320A applicable

2.5 Remote Controller

2.5.1 Basic Operational Buttons

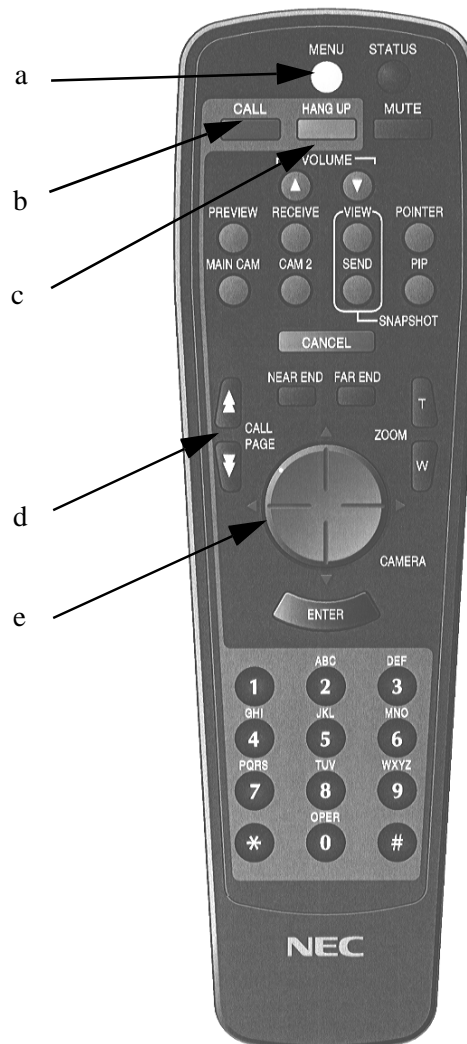

From top left to down followed by top right to down.

- (a) **MENU button**
Displays the configuration menus on-screen.
- (b) **CALL button**
Displays the line connection menu.
- (c) **HANG UP button**
Hangs-up the video conference line.
- (d) **CALL PAGE button**
Allows for scrolling of on-screen menus.
- (e) **CAMERA CONTROL button**
Provides Pan/Tilt control of the camera. In addition, provides up down/left/right control of the cursor when the menu is displayed.

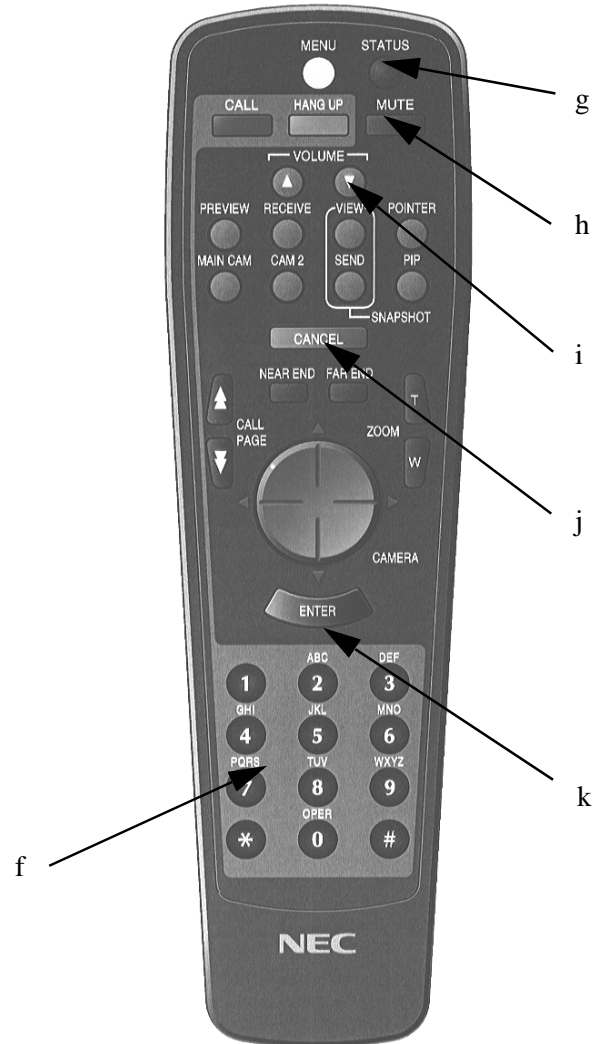

- (f) **NUMERICAL** button
Used to enter preset dialing numbers and camera presets.
- (g) **STATUS** button
Displays local time and conference status on-screen.
- (h) **MUTE** button
Toggles between muting and unmuting the local mics.
- (i) **VOLUME** button
Allows adjustment of the audio output.
- (j) **CANCEL** button
Cancel the last entered using the on-screen menus.
- (k) **ENTER** button
Stores a value set by the user.

2.5.2 Video Conference, Operational Buttons

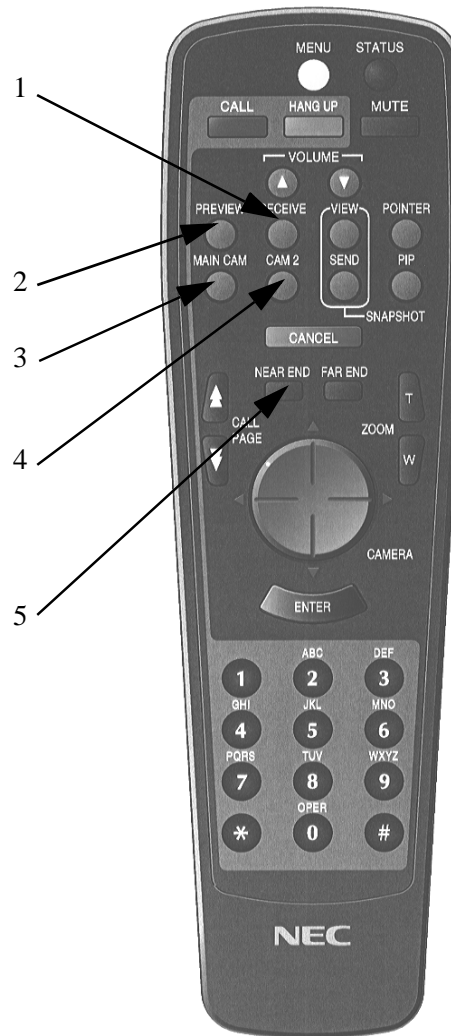

From top left to down followed by top right to down.

1. **RECEIVE** button
Displays the far-site's video on-screen.
2. **PREVIEW** button
Displays the local video on-screen.
3. **MAIN CAMERA** button
Sends video input #1 image to the far-site.
4. **CAMERA 2** button
Sends the video #2 image to the far-site.
5. **NEAR END** button
Activates local camera control.

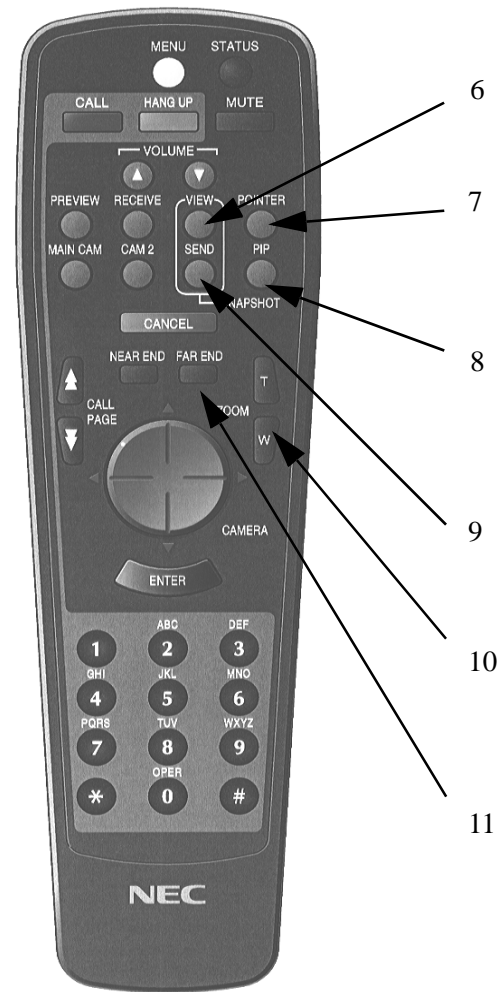

6. **SNAPSHOT VIEW** button
Displays the graphic camera image.
7. **POINTER** button
This turns on and off a pointer display.
8. **PIP** button
This turns on and off a PIP display.
9. **SNAPSHOT SEND** button
Sends a graphic image to the far-site.
10. **ZOOM** button
Allows for camera control of zoom in/out function.
11. **FAR END** button
Activates far-site camera control.

Chapter 3 Initial Setting and Operation Checking

After completing the external phase, start the initial setting of VisuaLink.

3.1 Preparation

- ① Put the attached two batteries in the attached remote controller.
- ② Turn the VisuaLink and all external equipment power in the **ON** position.
- ③ Position the TV monitor and the VisuaLink system so that they can be viewed.

3.2 Turn Power ON or OFF

The VisuaLink can be turned **ON** or **OFF** by the **POWER SWITCH** on the front.

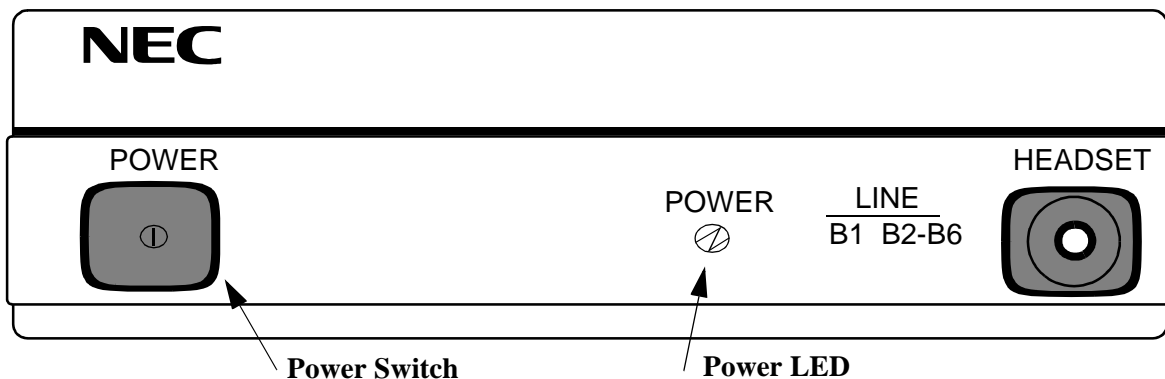

Turning on the power:

Press the **POWER SWITCH** on the front of the VisuaLink. While the unit is powering up, the green LED power lamp and Line B1 and B2-B6 light simultaneously. While the system is in an initialize state, a blue screen with the message **Please wait for a while** will be displayed on the monitor. When the VisuaLink has completed its initialization, the message will disappear and be replaced with a preview video image. In addition the B1 and B2-B6 LEDs will be extinguished.

Note 1: Unstable picture and sound may momentarily be output at the start of the initialization.

Note 2: If Line B1 B2-B6 LEDs do not extinguish after initialization (about 30 seconds), please turn power **OFF** and then back to the **ON** position.

Turning power OFF:

When the **POWER SWITCH** is pressed while the power is in the **ON** position, the power turns **OFF**. The power lamp extinguishes when the power is **OFF**.

This page is for your notes.

Chapter 4 Application Setup

4.1 Guidelines

The following are key points when installing the VisuaLink.

- (1) The VisuaLink should be installed on a flat surface. It is not recommended that the unit be installed on its side.
- (2) Please allow for 2 inches (6 centimeters) on both sides of the equipment for ventilation.
- (3) Allow the front of the unit to be visible.

The following are the specifications for the IR receiver/transmitter.

- (1) The receiver is able to receive an IR signal up to 20 feet (6 meters).
- (2) The IR receiver should be able to receive a signal at an angle of 30 degrees or less from the left to right.
- (3) The IR receiver should be able to receive a signal at an angle of 15 degrees or less from the top to bottom.

Please place only light objects on the equipment such as a telephone.

4.2 Hardware

The preceding sections will give step by step procedures for the installation of the VisuaLink system in specific applications. Pick the application and follow the instructions. This section gives a description on how to setup a VisuaLink as a stand alone.

4.2.1 VisuaLink Standalone

Parts List		
No.	Name	Note
1	VisuaLink 128 or VisuaLink 384	CODEC Engine.
2	Controllable Camera	Generic camera to allow for the transmission of video.
3	Microphone	Generic microphone to allow for transmission of audio
4	Monitor	TV monitor to display local and remote video

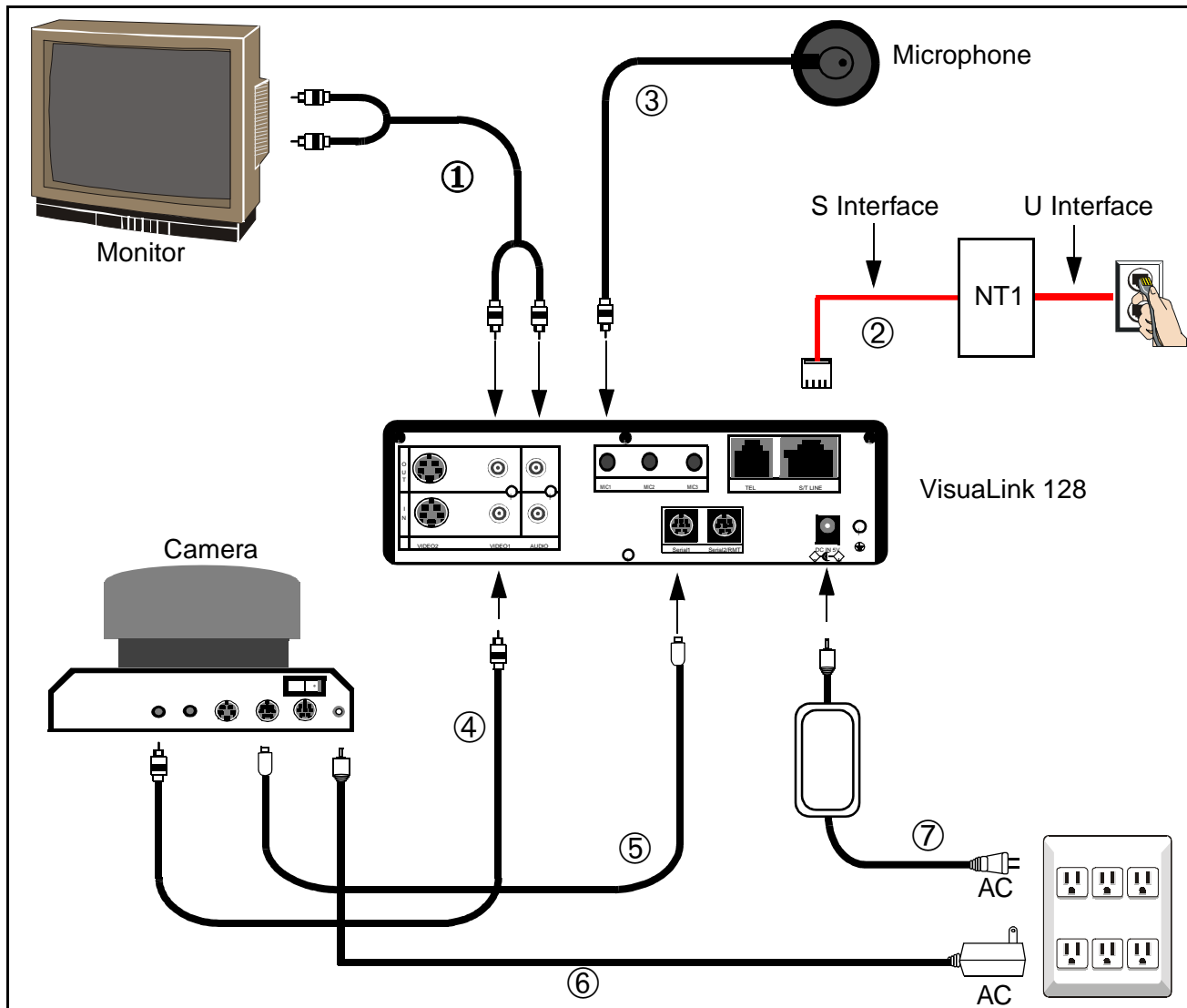

Figure 4-1: Connection Diagram for VisuaLink 128

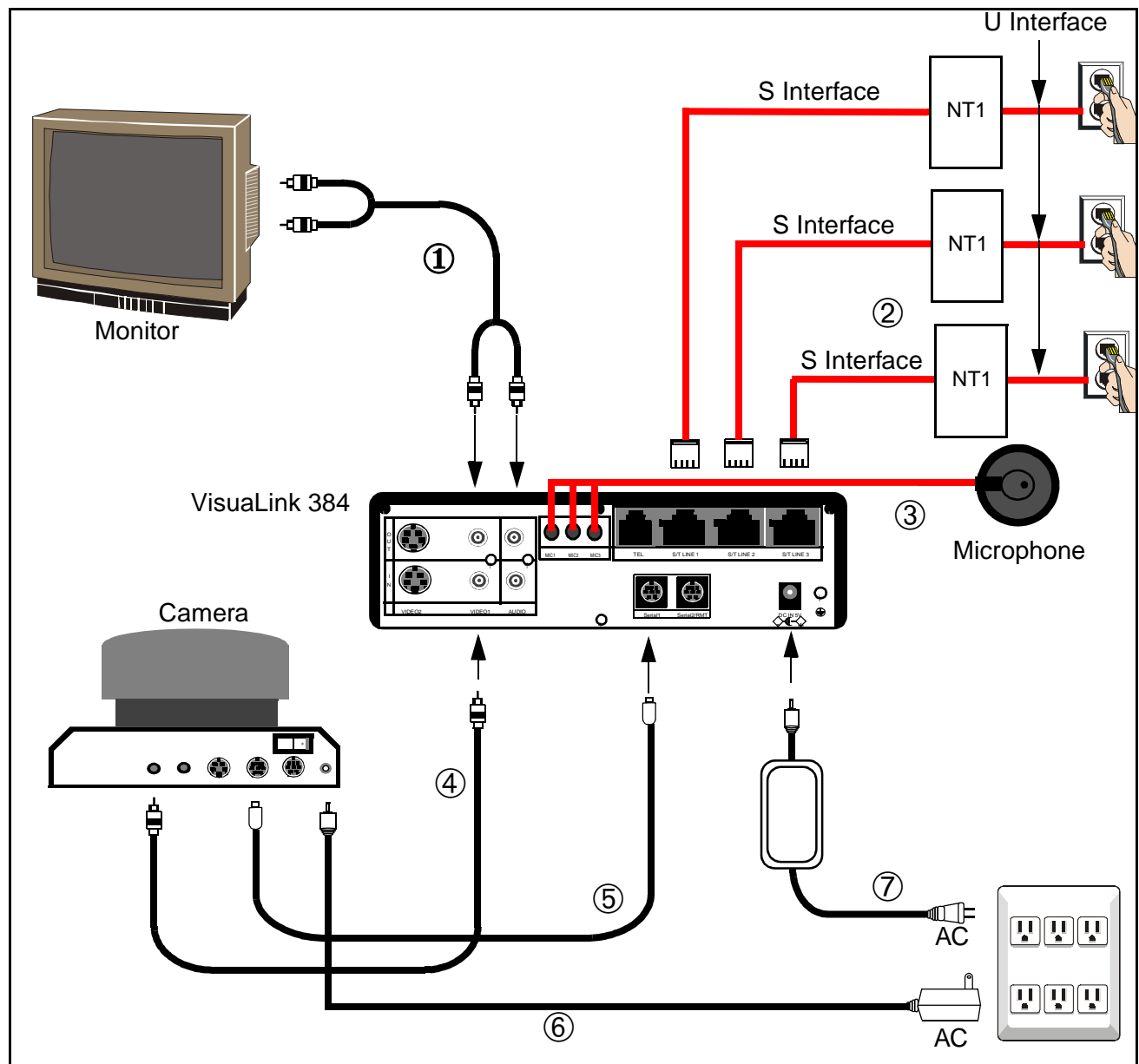

Figure 4-2: Connection Diagram for VisuaLink 384

	<p>An AC adapter has different output voltage and current depending on how it is used. Please use the power adapter that is shipped with your unit. Also, if incorrectly connected, it may damage the equipment.</p>
--	--

Connection Procedure

① ~ ⑦ indicate the procedure numbers.

① **Connect the Video Out and the audio of the VisuaLink to the Video Monitor**

Using the attached video cable, plug one side into the connection marked **VIDEO 1 IN** on the Video Monitor. Plug the other end into the connection marked **VIDEO OUT** on the VisuaLink. Using the provided audio cable, plug one end into the **AUDIO INPUT 1** of the Video Monitor. Plug the other end into the **AUDIO OUTPUT** of the VisuaLink.

Note: If a Voicepoint is used do not connect the audio output connection.

② **Connect the NT1 device to the VisuaLink.**

Using the provided data cable (RJ45 - RJ45), plug one end into the VisuaLink connection labeled **ST/LINE**. The other end of the cable, plugs into the NT1 device.

Note: If the NT1 device is located more than 300 feet (91 meters) away from the VisuaLink, set the NT1 to have a resistance of 100 Ω . This step must be repeated three (3) times for a VisuaLink 384. NT1 does not need to be installed if network terminates in a PBX. In this case connect **ST/LINE** directly into wall jack.

③ **Connect a microphone to the VisuaLink.**

Plug the 3 1/2 mini connector into the VisuaLink connection marked **MIC1**.

④ **Connect the Video Camera to the VisuaLink.**

Using the provided video cable, plug one end into the connection marked **VIDEO IN** on the D30 camera. Plug the other end of the video cable into the VisuaLink connection labeled **VIDEO IN 1**.

⑤ **Connect the camera control to the VisuaLink.**

With a 8 pin minidin to 8 pin minidin, plug one end into the D30 camera connection marked **VISCA IN**. Plug the other end into the VisuaLink connection marked **SERIAL 1**.

⑥ **Connect the camera power.**

Plug the Camera AC Power to the AC Power Strip at the bottom of the cabinet.

⑦ **Connect the VisuaLink AC Power.**

Using the provided AC transformer power cable, plug the power cable into the VisuaLink connection marked **DC-IN-5V**. Plug the other end into the AC Power Strip.

4.2.2 VisuaLink with Voicepoint+

Parts List		
No.	Name	Note
1	VisuaLink 128 or VisuaLink 384	CODEC Engine.
2	Voice Point+	AEC-50 (option), A generic hands-free phone in the market works OK.
3	Serial Control Camera	Generic camera to allow for the transmission of video.
4	TV monitor	A generic monitor with a video and audio input.

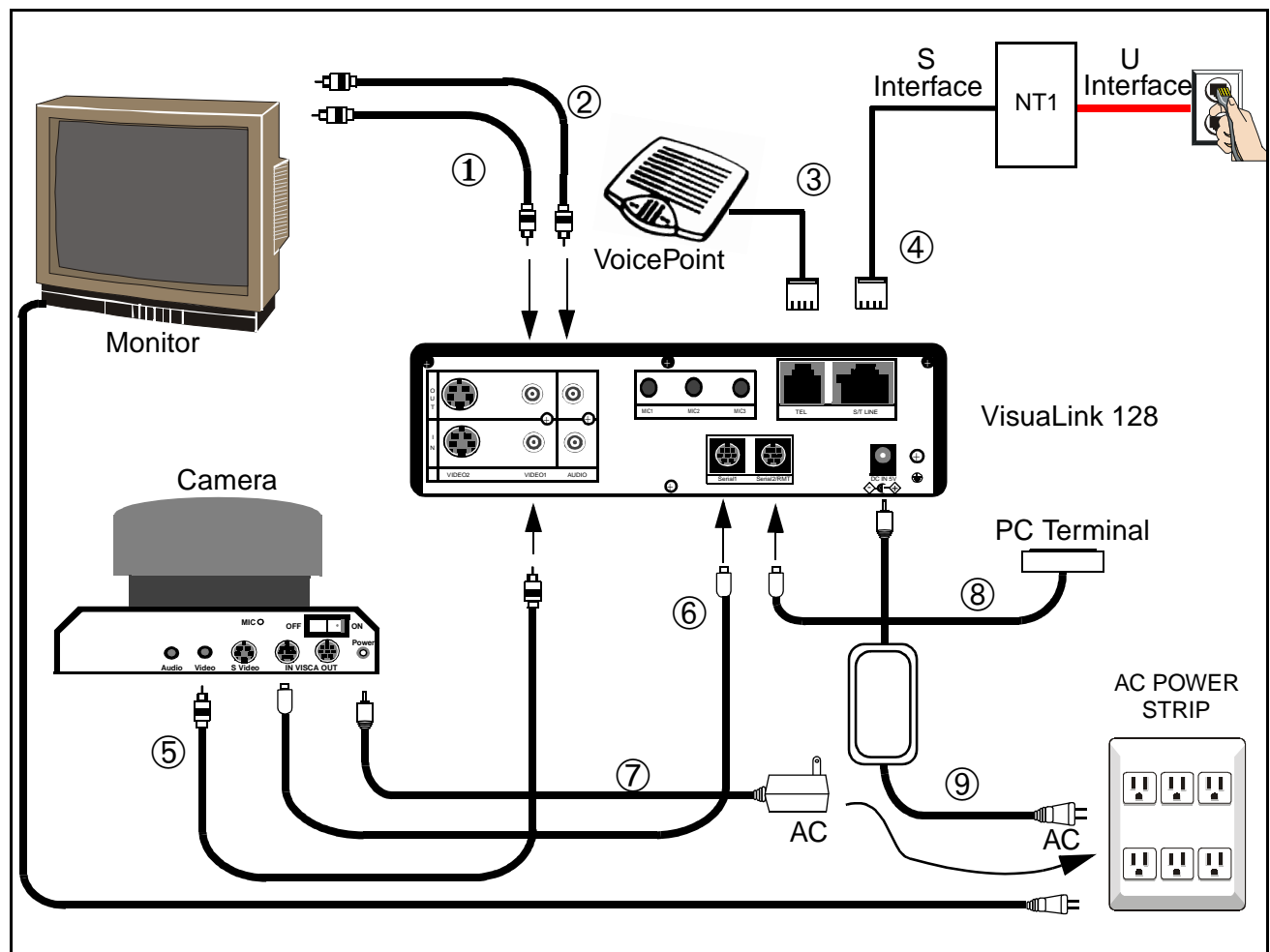

Figure 4-3: Connection Diagram for VisuaLink 128

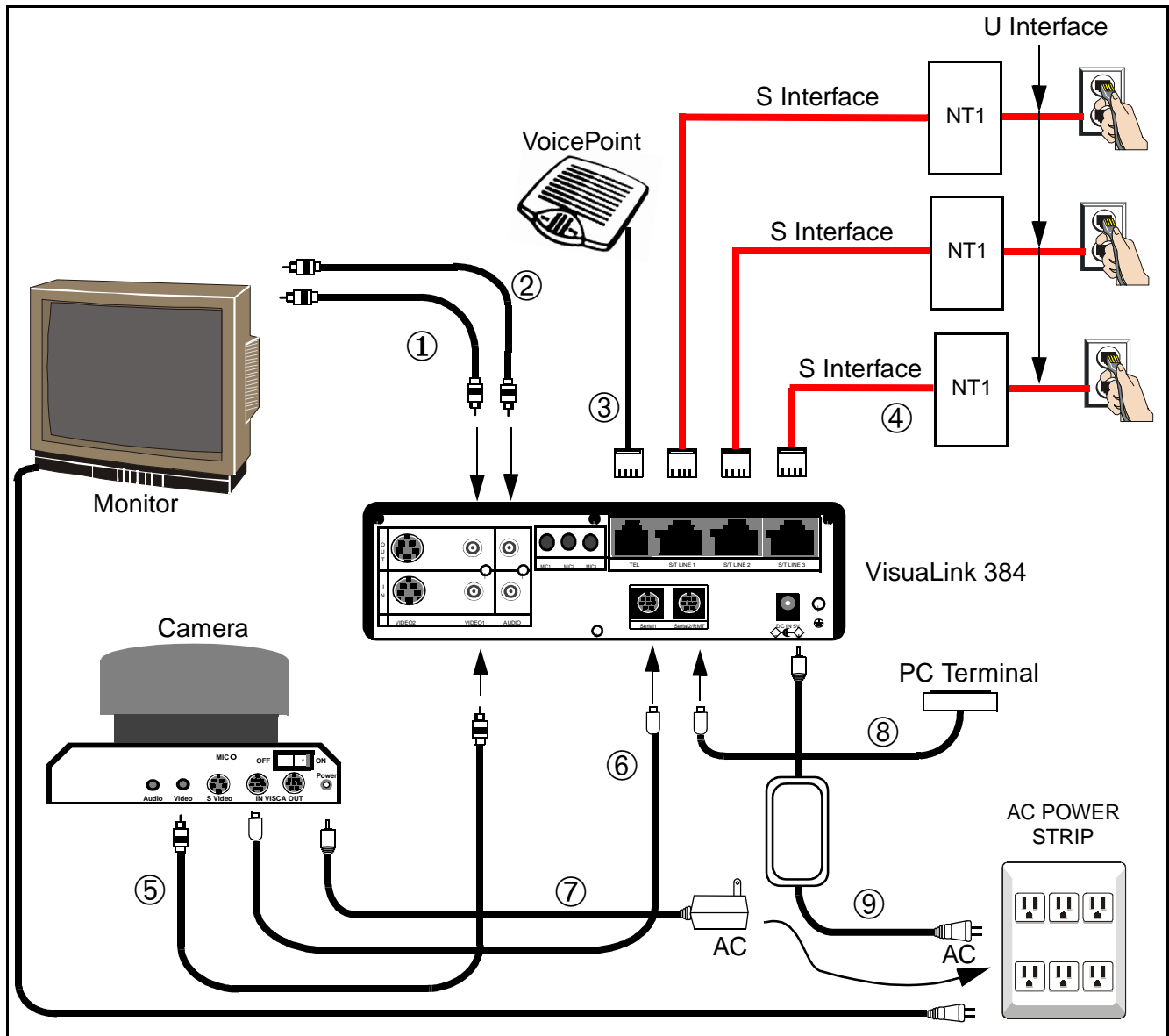

Figure 4-4: Connection Diagram for VisaLink 384



An AC adapter has different output voltage and current depending on how it is used. Please use the power adapter that is shipped with your unit. Also, if incorrectly connected, it may damage the equipment.

Connection Procedure

① ~ ⑩ indicate the procedure numbers.

① **Connect the Video Out of the VisuaLink to the TV Monitor**

Using the attached video cable, plug one side into the connection marked **VIDEO 1 IN** on the TV Monitor. Plug the other end into the connection marked **VIDEO OUT** on the VisuaLink.

② **Connect audio from the VisuaLink to the TV Monitor.**

Using the provided audio cable, plug one end into the **AUDIO INPUT 1** of the TV Monitor. Plug the other end into the **AUDIO OUTPUT** of the VisuaLink.

Note: If a Voicepoint is used do not connect the audio output connection.

③ **Connect the Voicepoint to the VisuaLink.**

Using the attached RJ11 cable of the Voicepoint, plug the open end into the VisuaLink connection labeled **TEL**.

④ **Connect the NT1 device to the VisuaLink.**

Using the provided data cable (RJ45 - RJ45), plug one end into the VisuaLink connection labeled **ST/LINE**. The other end of the cable, plugs into the NT1 device.

Note: If the NT1 device is located more than 300 feet (91 meters) away from the VisuaLink, set the NT1 to have a resistance of 100 Ω . This step must be repeated three (3) times for a VisuaLink 384. NT1 does not need to be installed if network terminates in a PBX. In this case connect **ST/LINE** directly into wall jack.

⑤ **Connect the Video Camera to the VisuaLink.**

Using the provided video cable, plug one end into the connection marked **VIDEO IN** on the D30 camera. Plug the other end of the video cable into the VisuaLink connection labeled **VIDEO IN 1**.

⑥ **Connect the camera control to the VisuaLink.**

With a 8 pin minidin to 8 pin minidin, plug one end into the D30 camera connection marked **VISC IN**. Plug the other end into the VisuaLink connection marked **SERIAL 1**.

⑦ **Connect the camera power.**

Plug the Camera AC Power to the AC Power Strip at the bottom of the cabinet.

⑧ **Connect a PC to the VisuaLink for data sharing.**

Using an 8 pin mini din to DB9 cable, plug the 8 pin end into the VisuaLink connection marked **SERIAL 2/RMT**. Plug the other end into the PC.





⑨ **Connect the VisuaLink AC Power.**

Using the provided AC transformer power cable, plug the power cable into the VisuaLink connection marked **DC-IN-5V**. Plug the other end into the **AC POWER STRIP**.

4.2.3 Desktop Configuration

Step-by-step procedures for installing the VisuaLink system in a desktop application.

Equipment to Connect

Parts List		
No.	Name	Note
1	VisuaLink 128 or VisuaLink 384	CODEC Engine.
2	Microphone	Generic Microphone to allow for the transmission of audio.
3	Stand-type Camera	Generic camera to allow for the transmission of video.
4	PC (Provided by customer)	Your personal PC with a monitor. PC should have audio input capability.
5	Video Capture Card	Allows for the input of a video image into a PC.
6	Director Software	<p>Allows for VisuaLink control via PC. Software may be downloaded from Web site:</p> <p>http://www.cng.nec.com/html/products.htm</p>  <ol style="list-style-type: none"> Click on the NTAC icon  or select SUPPORT from the menu bar at the top of the screen. At the CNG SUPPORT screen, click on the NTAC Online text. At the National Technical Assistance Center screen, click on the Downloads icon  or the Downloads text on the menu bar. At the Downloads screen, click on the Arrow icon  at the top or bottom of the screen until you come to ▶ Video-VL128/384. Click on the ▶, then click of the VisuaLink Director for VL128/VL384 text that is highlighted in blue. <p>Note: If you have a problem with this procedure, please call the NTAC support line at 1-800-852-4632.</p>

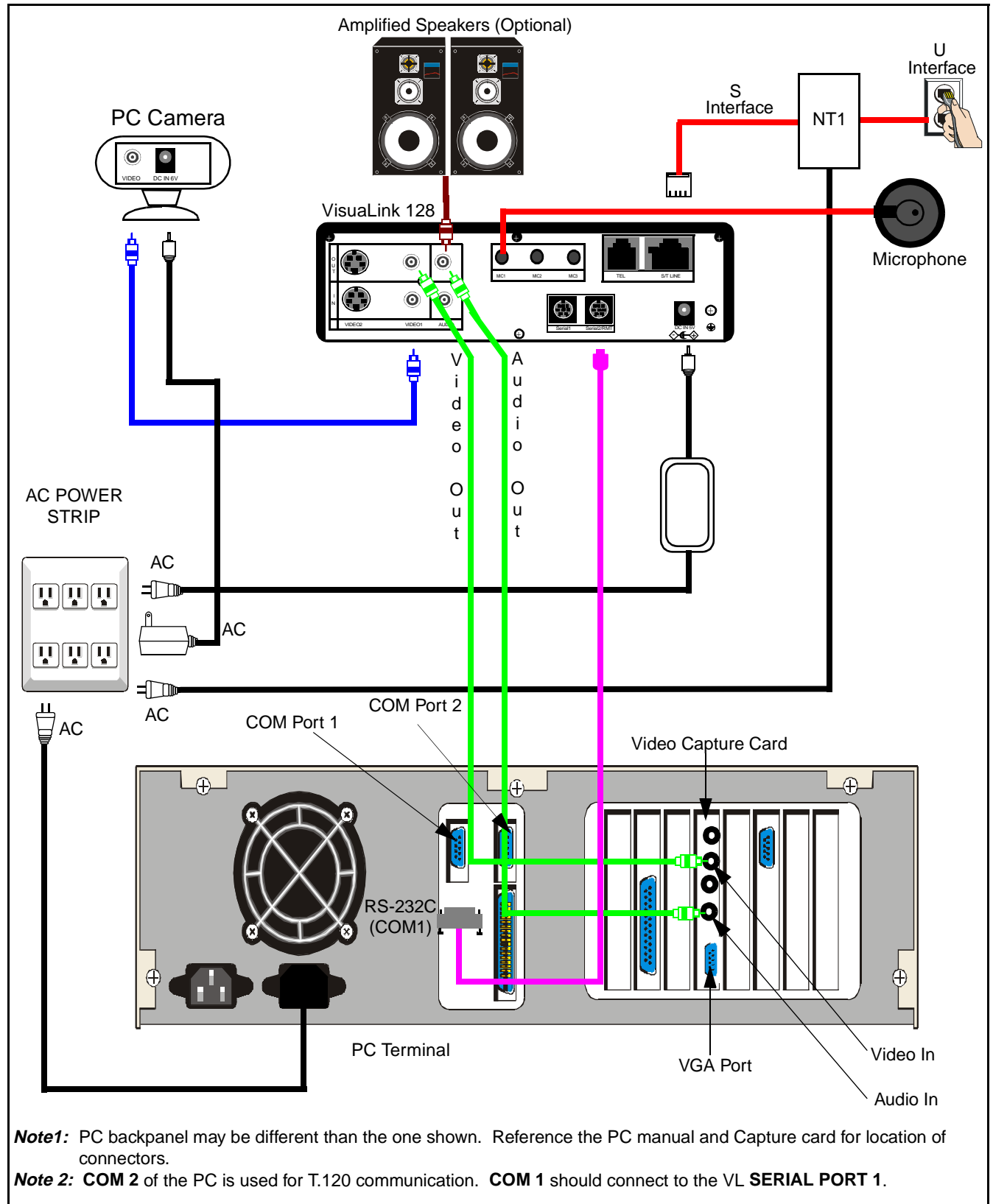

Figure 4-5: Connection Diagram for VisuaLink 128

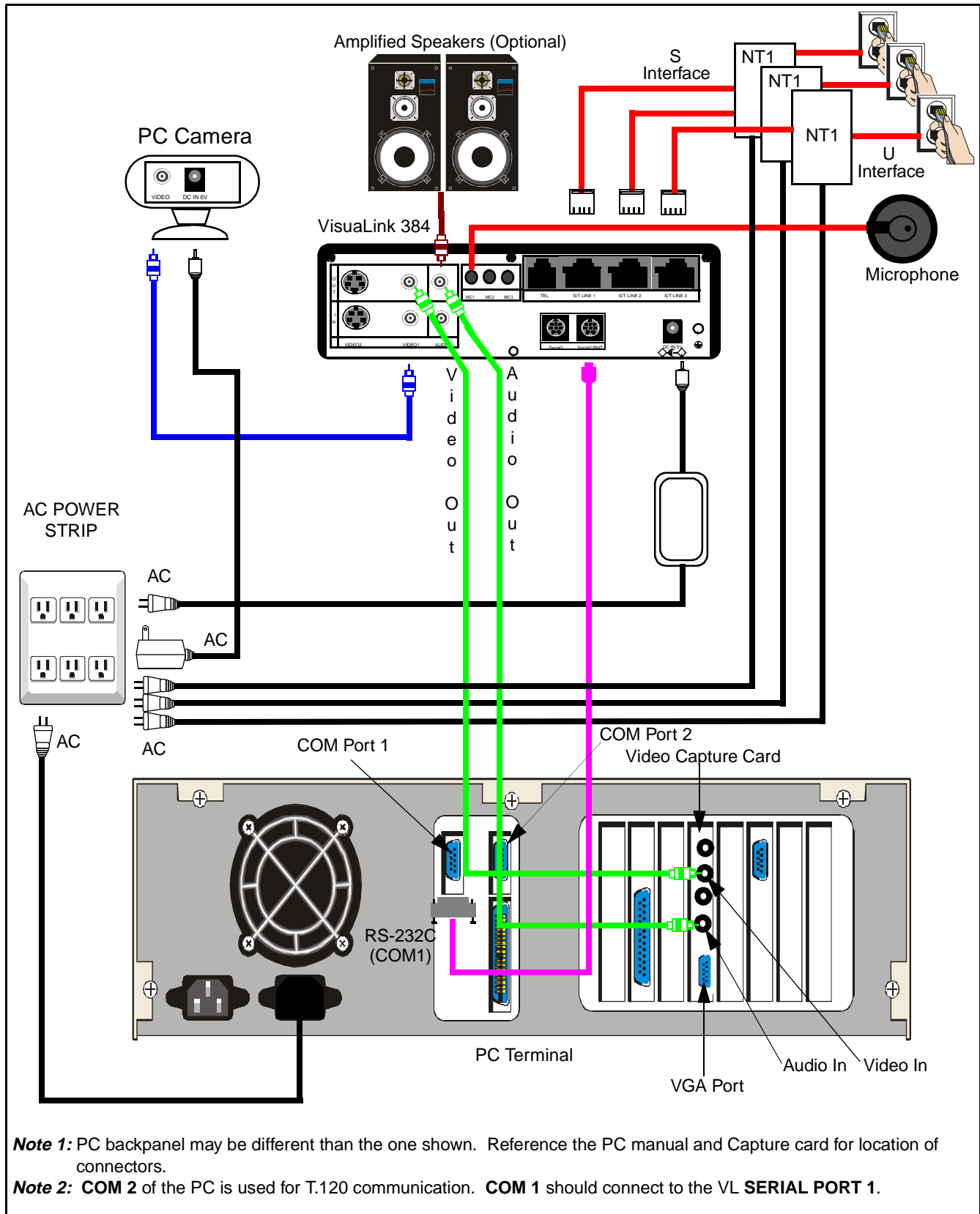



Figure 4-6: Connection Diagram for VisuaLink 384

Connection Procedure for VisuaLink 128 and VisuaLink 384

	<p>An AC adapter has different output voltage and current depending on how it is used. Please use the power adapter that is shipped with your unit. Also, if incorrectly connected, it may damage the equipment.</p>
---	--

1. Install the video capture card into the PC.

Procedure for installing video capture card are included with unit.

2. Position of the VisuaLink on desk top.

Place the VisuaLink on the desk top beside the PC.

3. Position of the PC

Center the PC on the top of the table.

4. Position of the camera

Center the camera on top or next to the PC monitor. Using the two (2) provided Velcro strips, attached the camera to the top of the PC monitor.

5. Position and connect the NT1 device

Position the NT1 to the left of the VisuaLink on the table top. Connect the cable to the **NT1 S/T** interface and to the VisuaLink **ST/LINE** interface.

Note: If the NT1 device is located more than 300 feet (91 meters) away from the VisuaLink, it is best to use the 1 foot (0.3 meter) adapter cable and set the NT1 to have a resistance of 100Ω. This step must be repeated three (3) times for a VisuaLink 384. NT1 does not need to be installed if network terminates in a PBX. In this case connect **ST/LINE** directly into **WALL JACK**.

6. Connect the audio, video and control cables

Locate the cable bundle. The bundle should contain four (4) cables tie-wrapped together. Each cable is labeled according to its connector. This label identifies the cable connection to the proper equipment interfaces.

7. Connect the peripheral equipment to the power strip

The power strip is located on the floor behind the table.

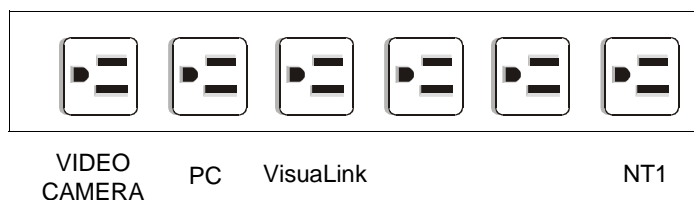

4.2.4 Rollabout Configuration

Step by step procedure for installing the VisuaLink system in a turnkey rollabout.

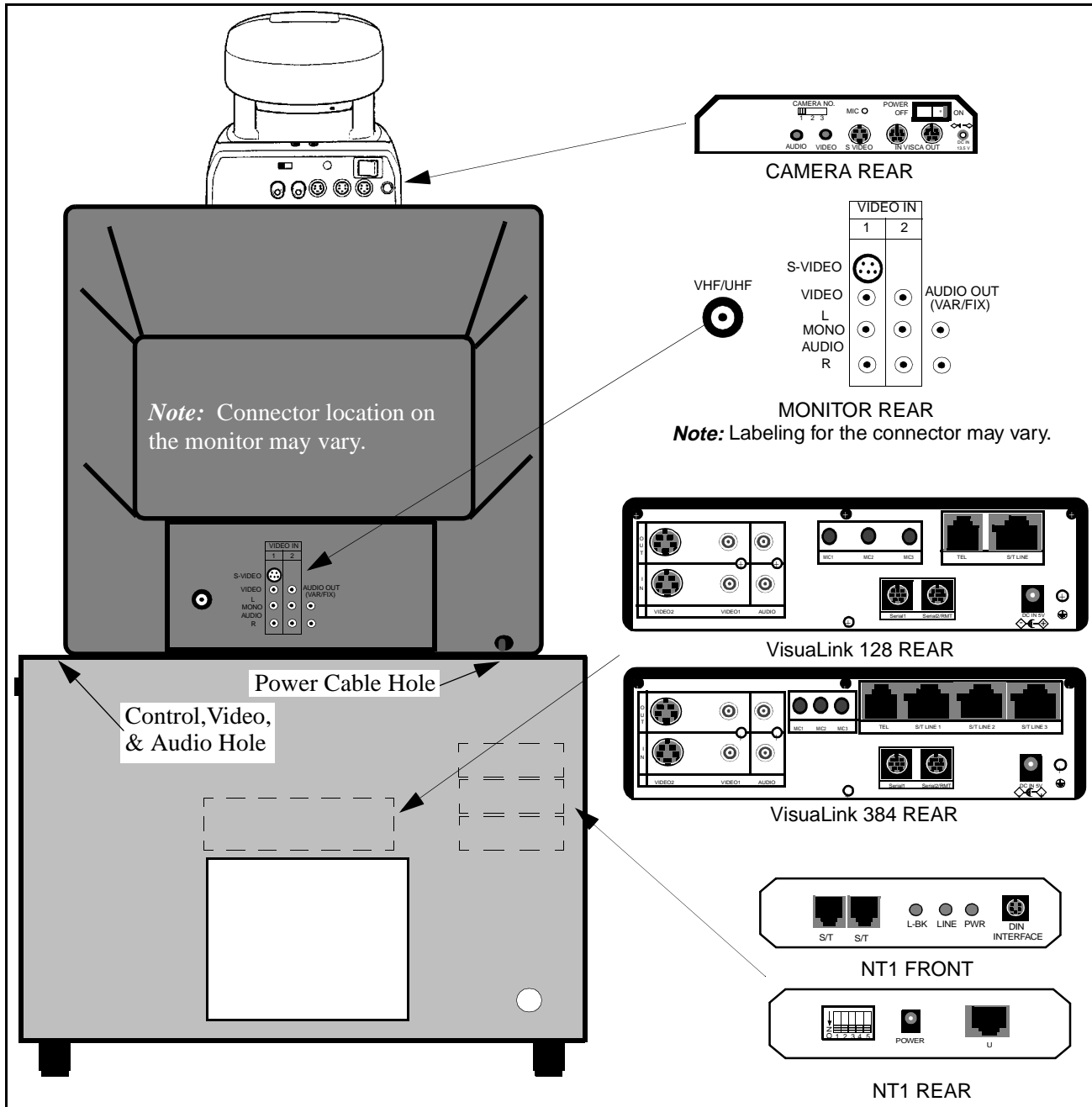
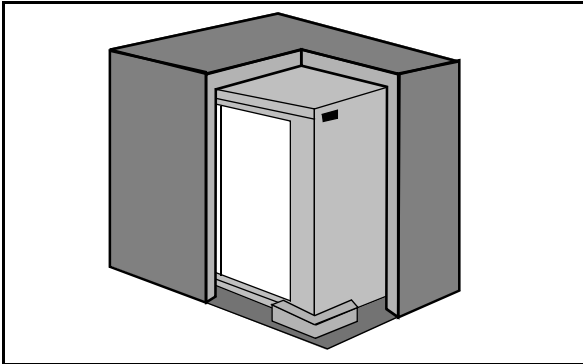
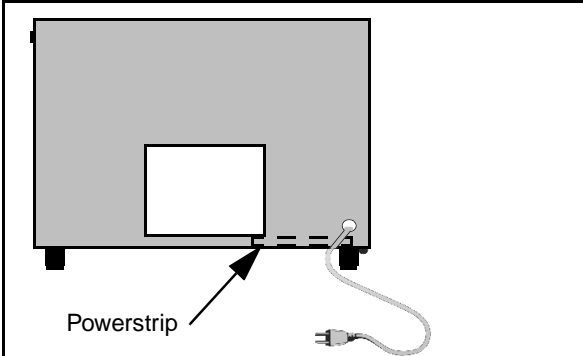
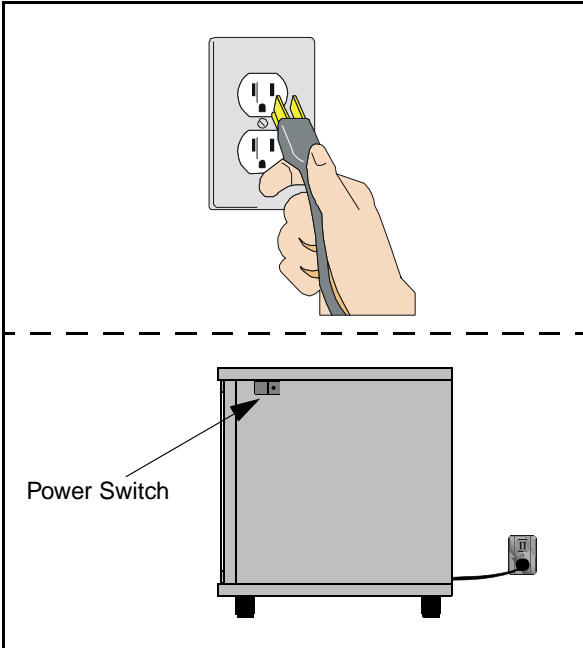
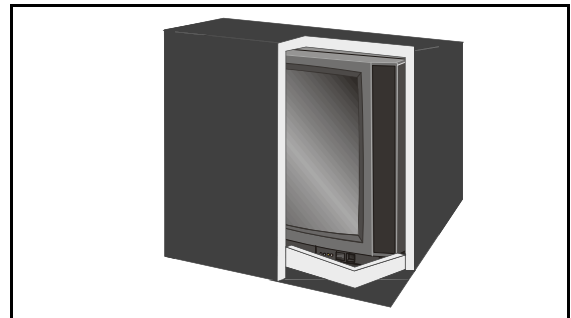
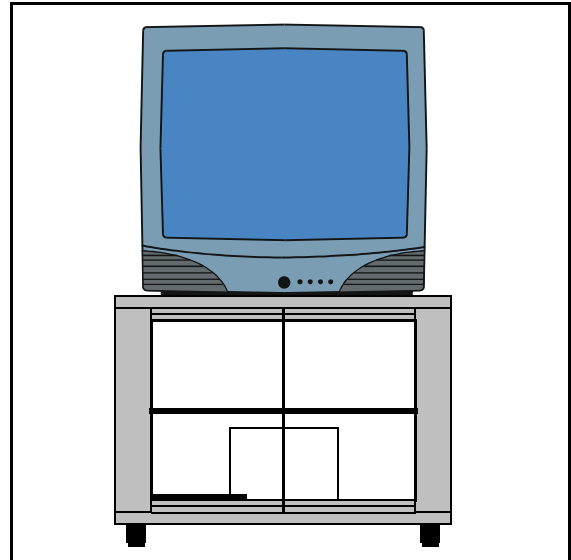
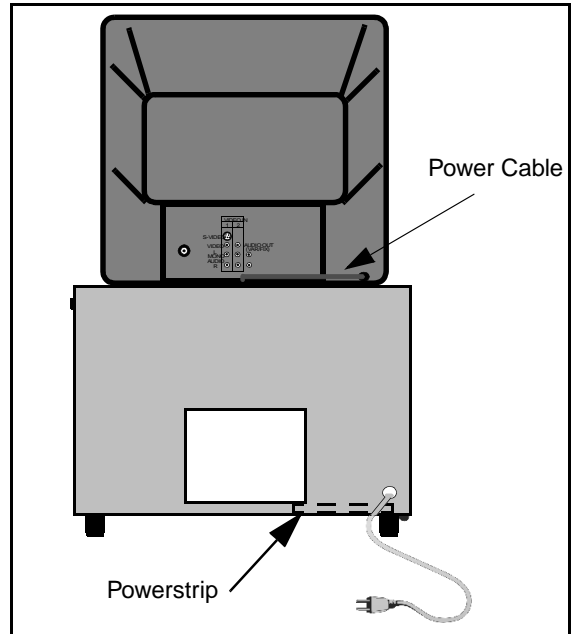

Figure 4-7: Equipment Placement

4.2.5 VisuaLink System Procedures

The following are the steps and procedures for the installation of the VisuaLink 128 or VisuaLink 384.

STEP	ACTION	DRAWING
1.	Locate and unpack the Cabinet box.	
2.	Locate Power Strip at bottom-left (looking through the front) of cabinet and feed power cable through the power opening at rear of cabinet.	
3.	Plug power strip power cable into AC outlet. Make sure the ON/OFF switch on the upper right outside of the cabinet is in the OFF position. <i>Note:</i> The power switch will be lite when in the ON position.	

STEP	ACTION	DRAWING
4.	Remove Monitor from monitor box.	
4a.	Place TV monitor on top of cabinet.	
5.	Locate monitor power cable and feed through the cable opening at the top of cabinet.	
6.	From inside the cabinet, plug the monitor power cable into power strip.	

STEP**ACTION****DRAWING**

7. Locate the cable bundle and remove from packing box. The cable bundle contains two (2) 5 in. (12 cm.) Velcro strips. Use these strips to mount the camera to the top of the monitor.
8. Locate the camera box and remove camera.

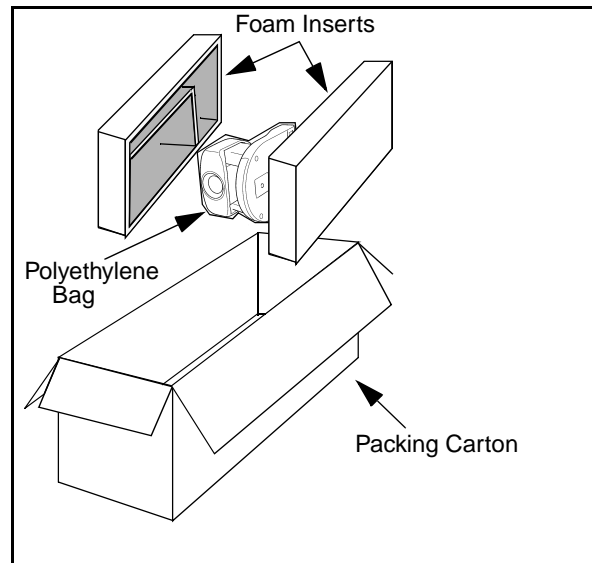

9. Set the IR switch on the Sony D30 camera to the ON position. The IR switch is located on the bottom of the Sony D30 camera. This will allow for the Sony Camera to receive the IR codes from the VisuaLink remote controller and transmit them to the VisuaLink Codec for control.

Mount the camera on the top of monitor, using the Velcro strips. Make sure the front of the camera is flush with the front of the monitor and the camera is centered.

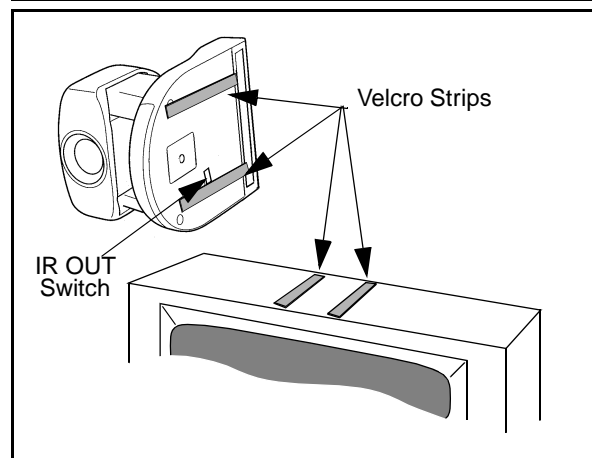

STEP**ACTION****DRAWING**

10. Locate the camera power cable. Plug the camera power cable into the power strip in cabinet, then feed cable through top of cabinet and plug into the rear of the camera.

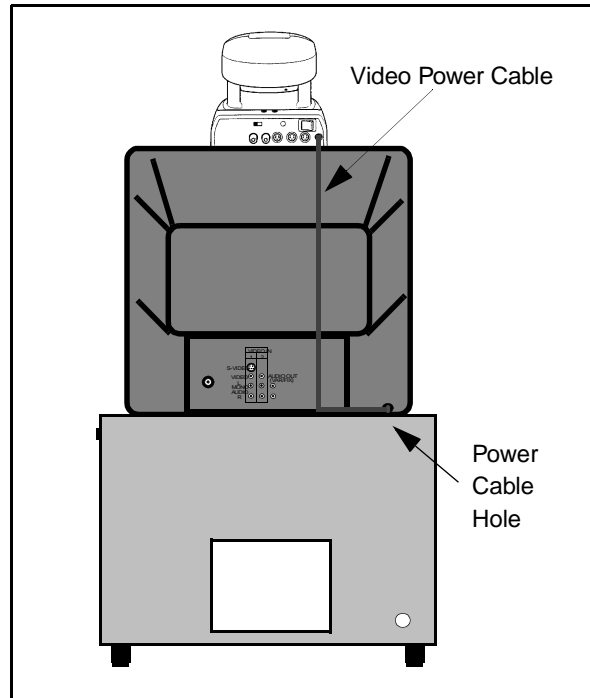

11. Locate the VisuaLink 128 or VisuaLink 384 and remove from packing box.

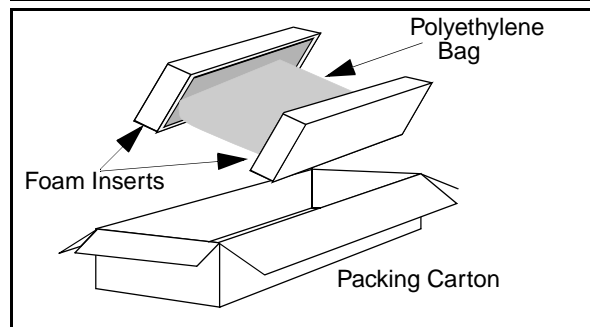

12. Place the VisuaLink 128 or VisuaLink 384 on the second shelf of the cabinet.

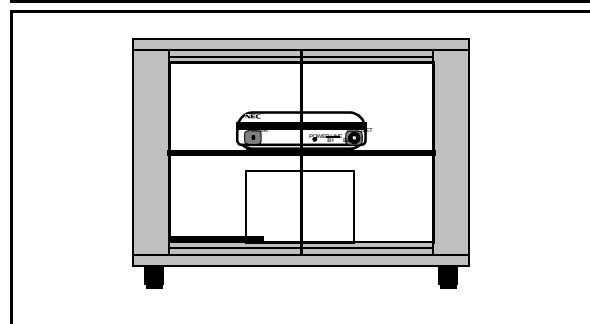

STEP

ACTION

13. Locate the VisuaLink 128 or VisuaLink 384 power cable. Plug cable into power strip at bottom of cabinet and feed cable through cable slot in rear of second shelf. Plug second end of power cable into power input at rear of the VisuaLink 128 or VisuaLink384.

DRAWING

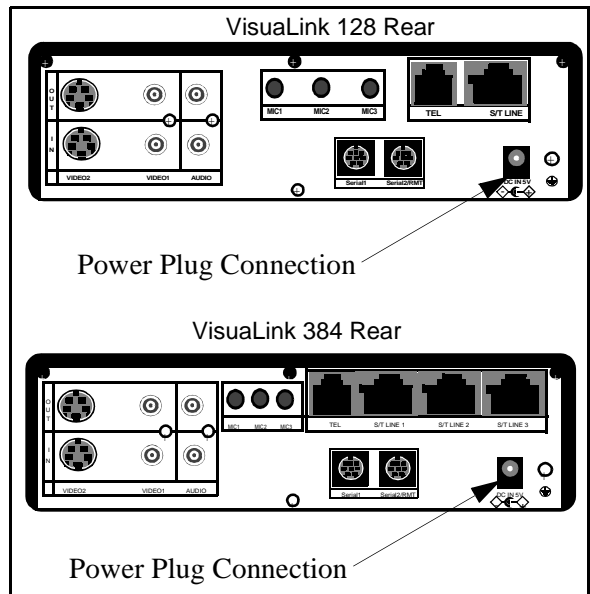

14. The cable bundle is labeled at the ends of the various connectors. Plug these connectors into the appropriate devices (camera/monitor) and feed down through opening at top of cabinet. See [Figure 4-1](#) and [Figure 4-2](#).

Note: Connector layout could vary by manufacture. Please consult their documentation if connector layout is different.

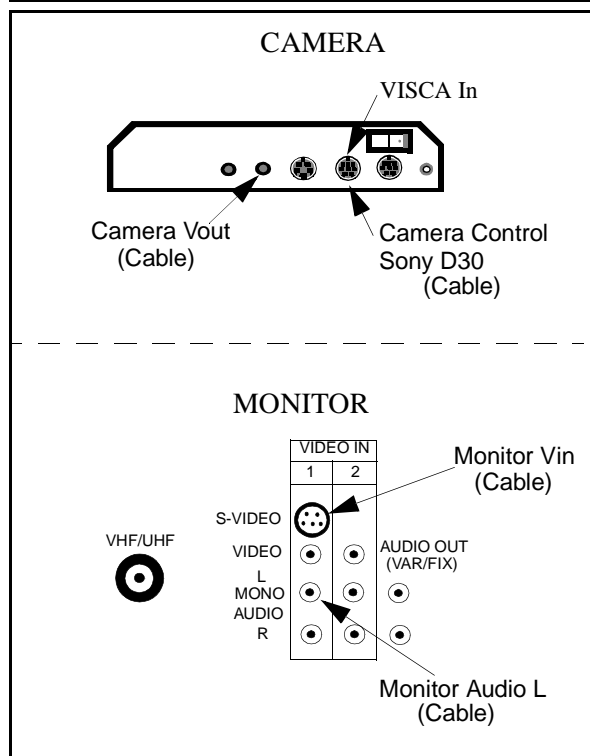

STEP

ACTION

15. Inside the cabinet, connect the other ends of the cable bundle to the VisuaLink 128 or VisuaLink 384. See Figure 4-1 and Figure 4-2.

DRAWING

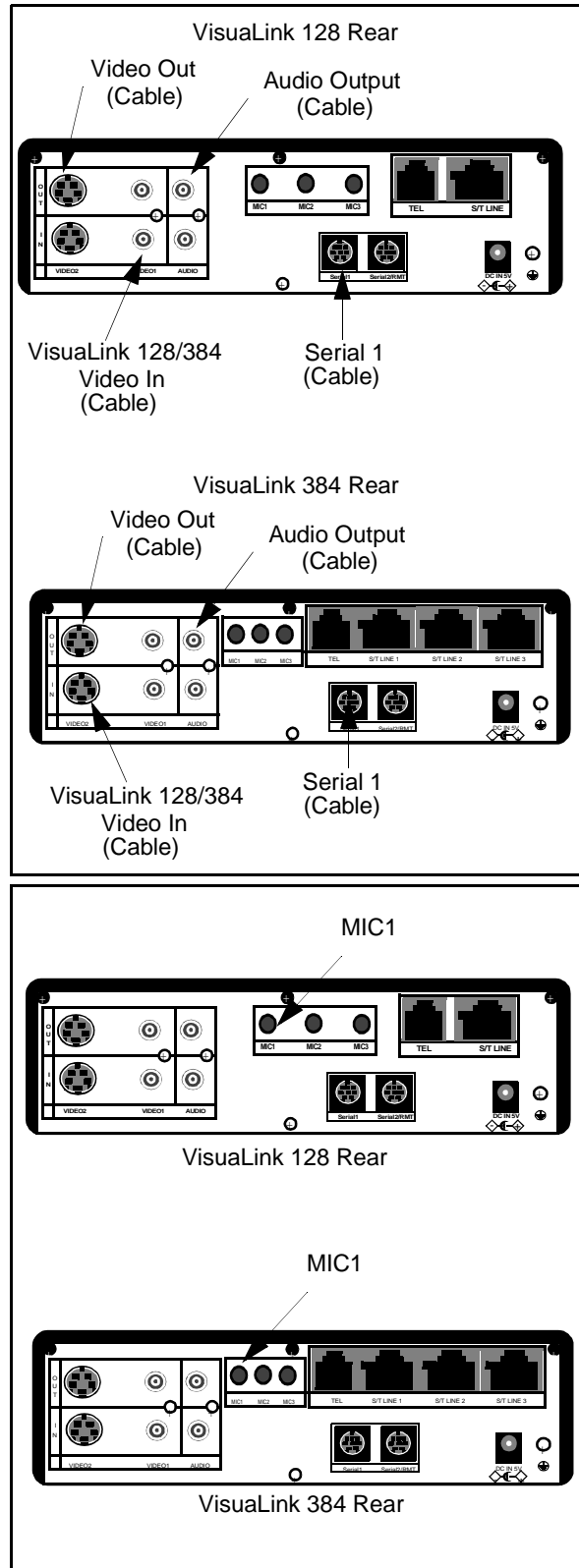

16. Locate and unpack the microphone and connect the 3 1/2 inch plug into the VisuaLink connection marked MIC1. String the MIC cable out of the rear of the cabinet. Connect the other end of the cable into the Microphone and place on table.

- STEP** **ACTION**
17. If an NT1 device has been purchased, locate the device and unpack.
Note 1: If an NT1 was not purchased go to [Step 23](#).
Note 2: Three NT1 are used for the VL384.

DRAWING

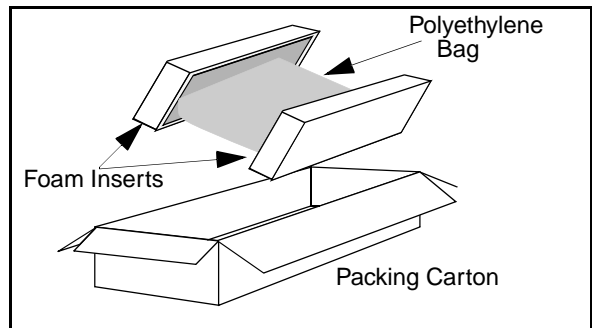

18. Locate the dip switch on the rear of the NT1 and set all to the ON position.

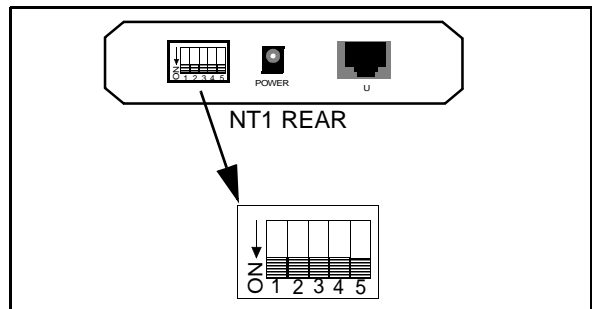

19. Place the NT1 or the three NT1s on the second shelf, to the right of the VisuaLink 128 or VisuaLink 384.

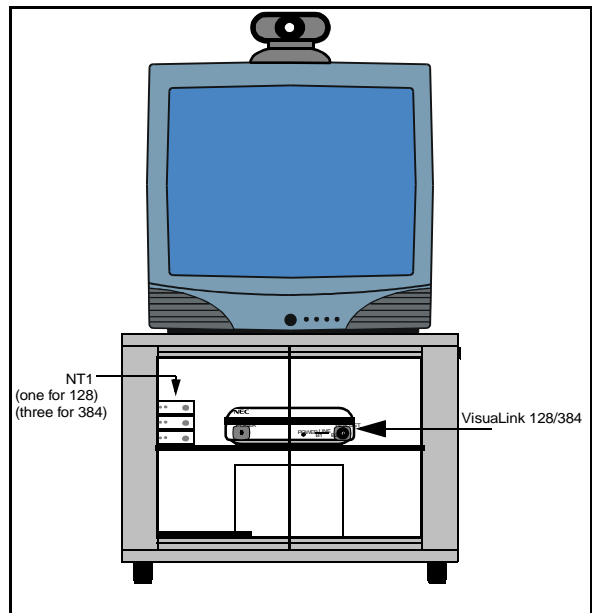

20. Locate the NT1 power cable. Plug cable into power strip at bottom of cabinet and feed cable through cable slot in rear of second shelf. Plug second end of power cable into power input at rear of the NT1.

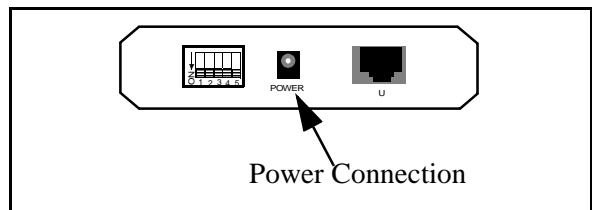

STEP ACTION

21. Locate the network cable (RJ45-RJ45) and connect one end to the S/T LINE port of the VisuaLink 128 or VisuaLink 384. Connect the other end of the network cable into the S/T interface of the NT1.
Note: RJ45-RJ45 cable that is included with the NT1 unit should be used.

DRAWING

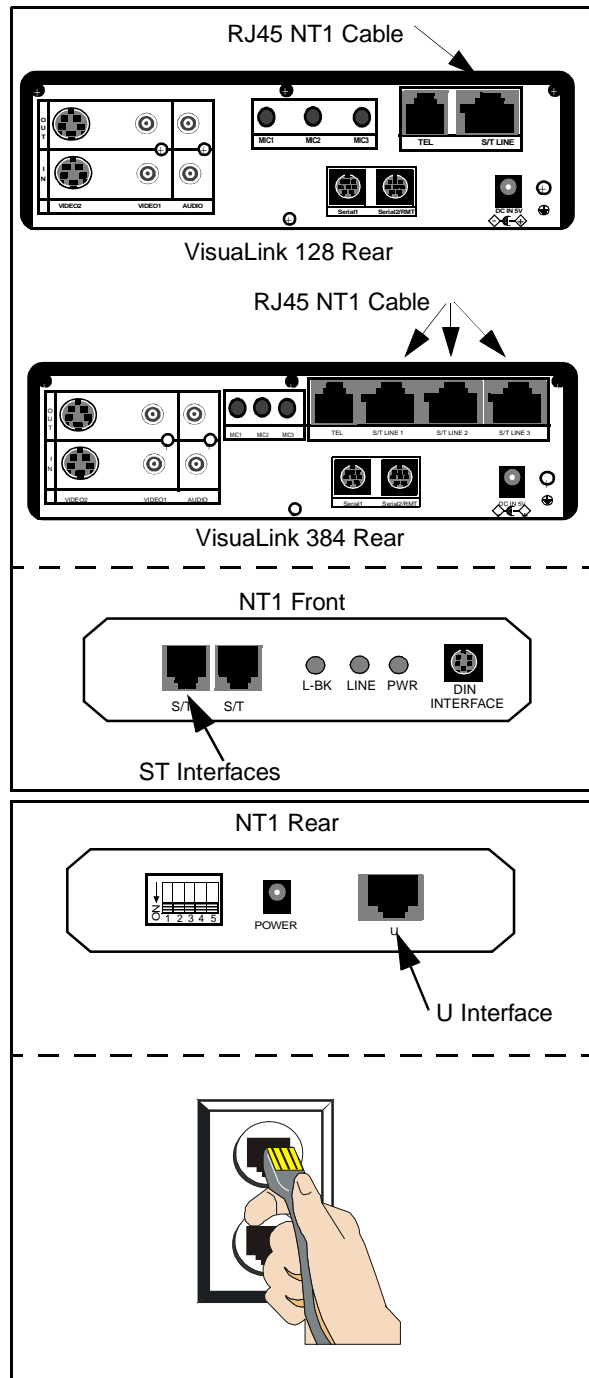

22. Connect the network cable from the U interface on the NT1 to the network jack provided on the room wall. Proceed to [Step 24](#).

Note 1: RJ45-RJ45 cable that is included with the NT1 unit should be used.

Note 2: If connecting a VisuaLink 384 system, Step 21 will have to be repeated three (3) times.

STEP ACTION

- 23. Locate the network cable (RJ45-RJ45) and connect one end to the S/T LINE port of the VisuaLink 128 or VisuaLink 384. Connect the other end of the network cable into the network interface provided in the room wall.

Note 1: If the NT1 or network switch resides 300 feet (91 meters) or more away from the VisuaLink 128 or VisuaLink 384, it is recommended that the TERM switch is set to **ON** on the VL128.

Note 2: In the case a VL384 is being installed, the network interface card must be taken out of the system and the appropriate strap must be set.

Note 3: If the VL 384 is being installed, Step 23 must be repeated three (3) times.

- 24. Locate the ON/OFF switch at the upper right outside of the cabinet. Press the switch to the **ON** position.

DRAWING

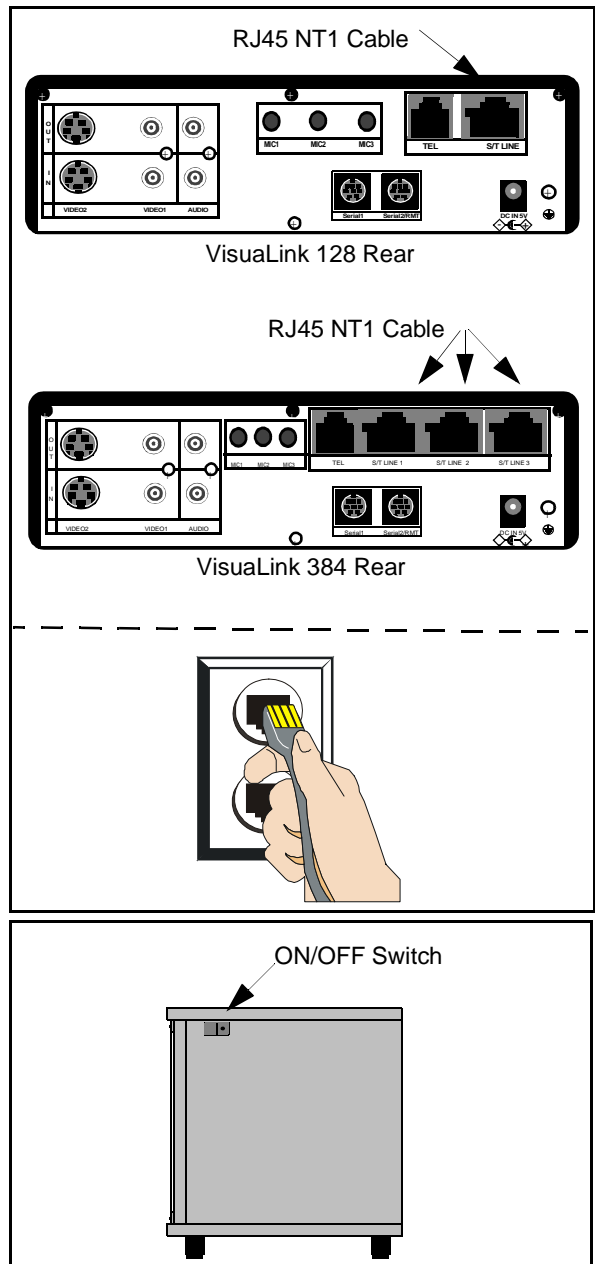

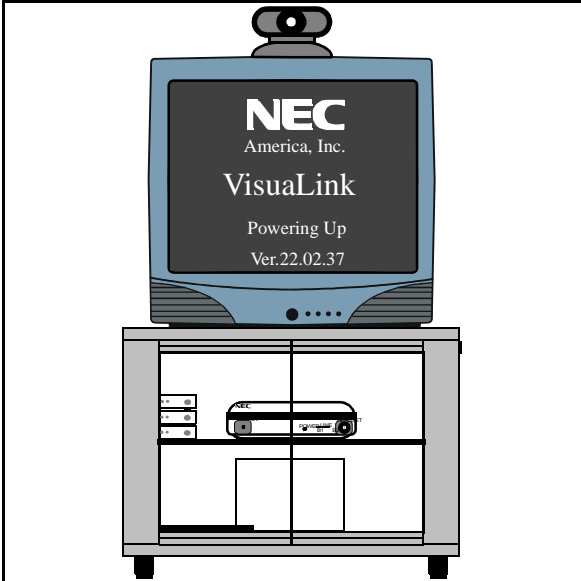
- | STEP | ACTION | DRAWING |
|------|--|---|
| 25. | Verify that all the equipment plugged into the power strip are turned to the ON position. The VisuaLink 128, VisuaLink 384, camera and monitor have their own power switches. If a device appears to be still in the OFF position, check the power connection from the Power Strip to the device. The NT1 does not have a power switch. The green LED on the front of the NT1 is an indication the unit is powered ON . |  |
| 26. | When the VisuaLink 128 or VisuaLink 384 is powered ON , a display of the NEC America, Inc logo, VisuaLink name, POWERING UP and version number will be displayed on the monitor. | |

Note: Make sure the monitor is selected for Video 1.

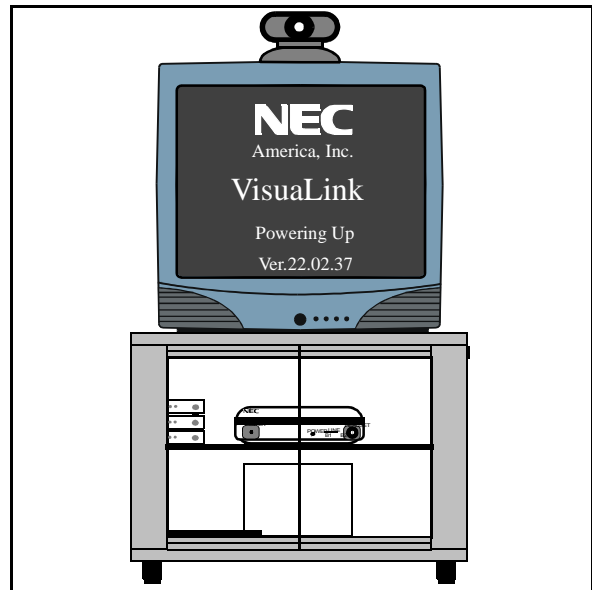

4.3 Software Setup

When you first turn on your VisuaLink, there will be an initial configuration screen. These configuration screens will have to be completed before your system becomes operational.

Start up configuration screens

The following are the startup screens that will be active on first power up or activated on demand by the user after choosing the Environmental initialize.

Welcome Screen:

This is a welcome screen for the User.

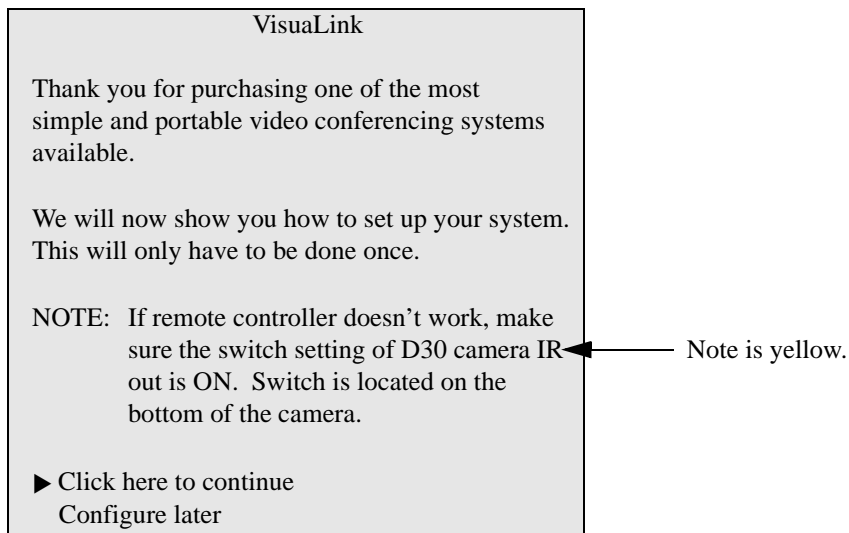

Remote Controller Directions:

Gives some general directions for configure the VisuaLink system. Using the Remote controller highlight the NEXT option to advance to the configure screen or press the lower portion of the CAMERA CONTROL key to highlight the Configure Later to advance to the normal ICON screens. If you choose to configure later, the system will have to be programmed with My numbers and SPID's in order to work correctly.

Part 1- Remote Controller Location

- Locate the CAMERA control.
The CAMERA control key is the BLUE round key. Use this key to move the Cursor up/down and Left/Right in the Configuration Screens.
- Locate the ENTER key on the Wireless remote controller.
Use the ENTER key to confirm selections and store information.

▶ Next screen
Prior screen

4.4 Setting Up your ISDN Line Information

The following is a description of BRI Line setup

Part 2- Setting up Your ISDN Line

Introduction:
When ordering BRI service, you will usually get 2 My numbers and 2 SPID numbers per BRI. A SPID normally consists of the user's 3 digit area code, 7 digit ISDN telephone number, followed by a 0101. Ex:
MY Number 1: 9727195854
SPID 1: 97271958540101

Note: The VisuaLink 128 requires 2 My numbers and 2 SPID #, while the VisuaLink 384 requires 6 My numbers and 6 SPID #.

▶ Next screen
Prior screen

Note is yellow.

Video Number 1 Screen's

Using the number pad of the wireless remote enter My Number with area code and SPID numbers associated to Line (BRI 1). Each BRI will have My numbers labeled #1 and #2 and two SPID's . All four numbers must be entered. Choose NEXT when complete.

Note: "PROCEED TO STEP 2" will only be shown on the VisuaLink 128 system. VisuaLink 384 will show " Proceed to Line 2 Setup"

Step 1--Enter My Number and SPID for BRI LINE 1	
My Number 1:	
▶ []
SPID 1:	
[]
My Number 2:	
[]
SPID 2:	
[]
Next screen	
Prior screen	
Press ENTER after choosing each item	

Step 1--Enter My Number and SPID for BRI LINE 1	
My Number 1:	
[9727195854]	
SPID 1:	
[97271958540101]	
My Number 2:	
▶ [9727195855]	
SPID 2:	
[]
Next screen	
Prior screen	
Press ENTER after choosing each item	

Video Number 2 Screens:

Using the number pad of the wireless remote enter My Number with area code and SPID numbers associated to Line (BRI 2). Each BRI will have My numbers labeled #1 and #2 and two SPID's . All four numbers must be entered. Choose NEXT when complete.

Note: This screen will only appear on the VL 384 system.

Step 1--Enter My Number and SPID for BRI LINE 2

My Number 1:
▶ []

SPID 1:
[]

My Number 2:
[]

SPID 2:
[]

Next screen
Prior screen

Press ENTER after choosing each item

Video Number 3 Screens:

Using the number pad of the wireless remote enter My Number with area code and SPID numbers associated to Line (BRI 3). Each BRI will have My numbers labeled #1 and #2 and two SPID's . All four numbers must be entered . Choose NEXT when complete.

Note: This screen will only appear on the VL 384 system.

Step 1--Enter My Number and SPID for BRI LINE 3

My Number 1:
 ► []

SPID 1:
 []

My Number 2:
 []

SPID 2:
 []

Next screen
 Prior screen

Press ENTER after choosing each item

4.5 Optional User Settings:

The following is a description for Optional Setting screen.

Part 3 - Optional User Settings

Introduction:

Site Name: Name identification for your location. Name is displayed on far-end monitor when site is viewed.

Password: Required to gain access to the VisuaLink configuration screens.

Time setting: Sets the internal clock for the VisuaLink.

► Next screen
 Prior screen

Optional information:

You may enter this optional information. The name you enter makes it easy for users to identify this particular VisuaLink. The name can be up to 20 characters long. The Password is the password needed to be entered when selecting the Utilities ICON. After entering the optional information select the NEXT to advance to the next screen.

Step 1- Optional User Settings

Your Site Name
[]

Password []

Time Setting
[12/1/1998 10:50]
Time Display: <Time only>
Auto Power Save: <OFF>

▶ Next screen
Prior screen

Press ENTER after choosing each item

Application Screen's

Using the number pad on the wireless remote controller select the application which the VisuaLink is installed. Your answer to this question will automatically configure the internal parameters for the following:

Item	Rollabout/Other	Data Conference	Gateway	Desktop
Serial Port 1	Camera EVI-D30	T.120	Camera	Camera
Serial Port 2	Console	Console	Console	Console
Audio Mode	G.722	G.728	G.722	G.722
MLP	4.0	24.0	4.0	4.0
Answer Mode	Auto	Auto	Auto	Manual
LSD	1.2	Off	1.2	1.2
Ext. Remote	Auto	Off	Off	Off
H.263	Off	Off	Off	Off
Lip Sync	On	On	On	On

Step 2—Optional User Settings

Key in the number of one of the following applications.

Applications:

1. Rollabout/Other
2. Data Conference
3. Gateway
4. Desktop

Press CANCEL to page back

Congratulations Screen

Congratulations, you have just finished setting up your VisuaLink system.

For VisuaLink software updates and general VisuaLink knowledge, visit the NEC Knowledge base web site at :

<http://www.cng.nec.com> or

<http://www.ilibrary.com/phoenix/ntachome.nsf/homepagenav?opennavigator>

- You may begin to use the video conferencing system immediately.
- Press ENTER to activate your configuration.

Press CANCEL to page back

The VisuaLink is now setup for the configuration you have entered. Press the **ENTER** button on the **REMOTE CONTROLLER**, the VisuaLink will display a blue screen and recycle. The VisuaLink should will power up to a normal state. You may begin to use the video conferencing system immediately.

Note: If there are no My Numbers entered in the configuration the VisuaLink will display the Start Up screens.

Powering Up Screen

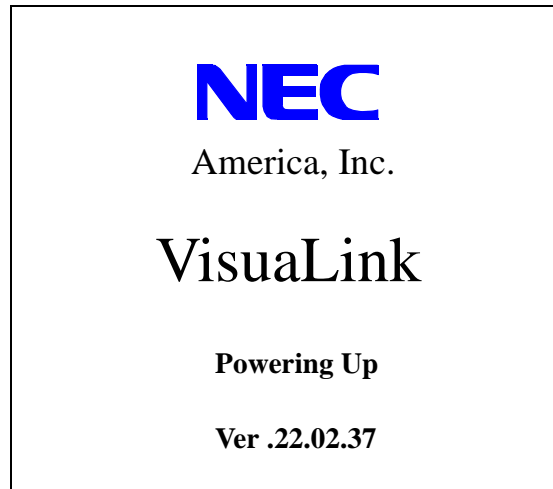

Changing the configuration

It is important that the CODEC is set up with a local number and SPID numbers. If the unit is not setup with a local number (my number) and SPID, the unit will not allow for dialing and receiving of video calls. If you have entered these numbers in the Start Up configuration, you may ignore this section. If the VisuaLink environment has changed, such as the phone number have changed, you must reconfigures the numbers in the VisuaLink.

Chapter 5 System Parameter/Environment Setting

System parameter sets the operation conditions of the VisuaLink 128 or VisuaLink 384. Environment setting can be set such as camera class, audio related, data related, line related and local office status. Loopback feature can be used as a maintenance feature.

Note 1: Make system parameter changes when the system is not connected.

Note 2: Depending on the setting for audio, data speed and bit rate, and the video has the possibility for not being transmitted. Please refer to [Appendix A: Audio/Data/Video Bit Rate Assignment Table](#) for bit rate assignment of audio, data, video bit rate.

5.1 Environment Setting Menu

5.1.1 Set an environment

- ① Press the **MENU** button to display the **MAIN MENU**.

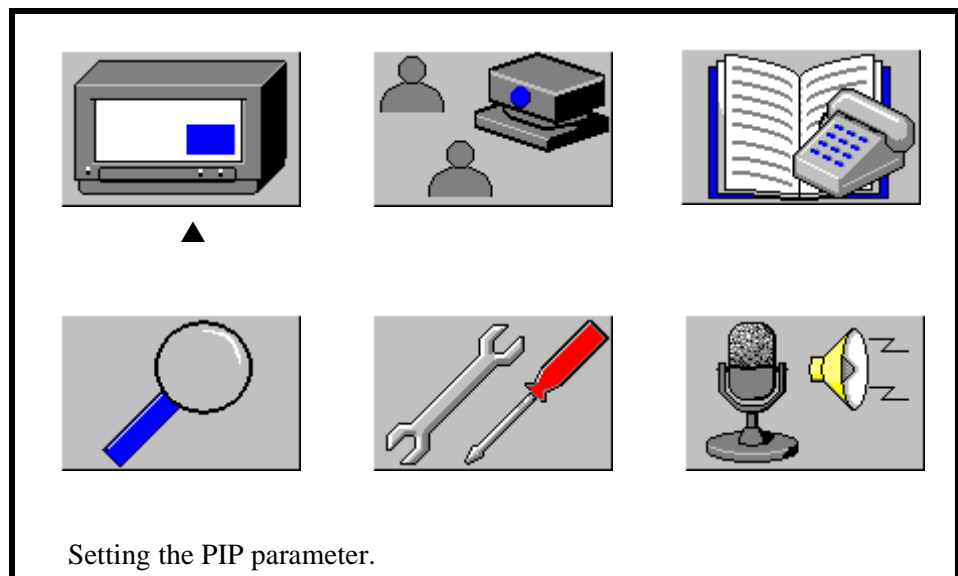
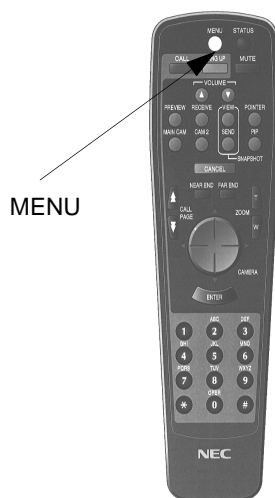

- ② Move the cursor with the **CAMERA CONTROL** button to the **ENVIRONMENT SETTING** icon.

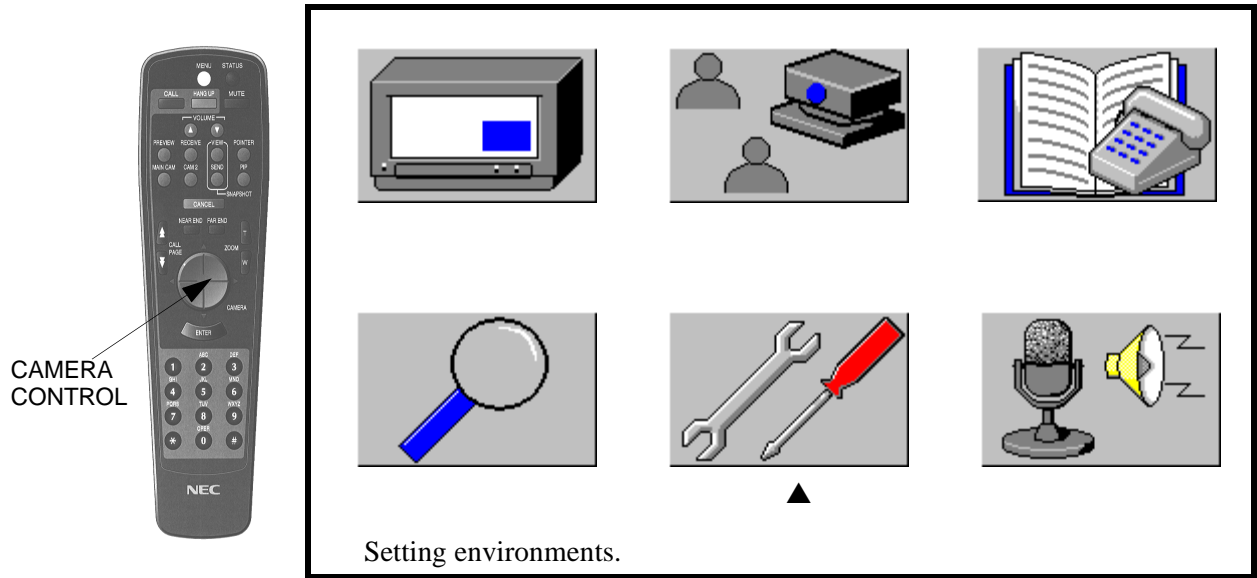

- ③ Press the **ENTER** button.

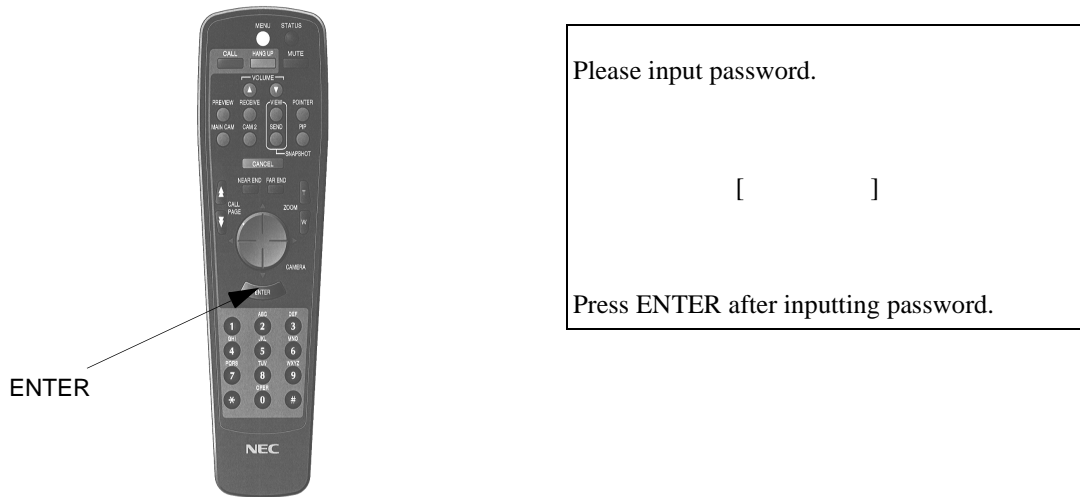

The system will not operate correctly if the environment setting are incorrect. Therefore, the system has a password so that only the person in charge of controlling video conference can change the settings. Factory default password is **1234**.

④ Enter the password.

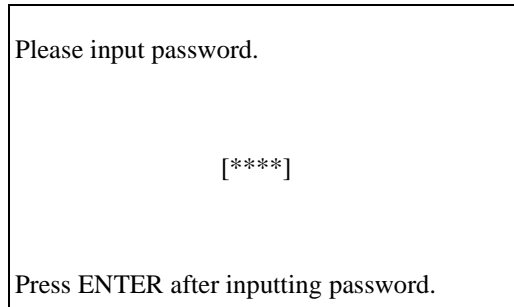
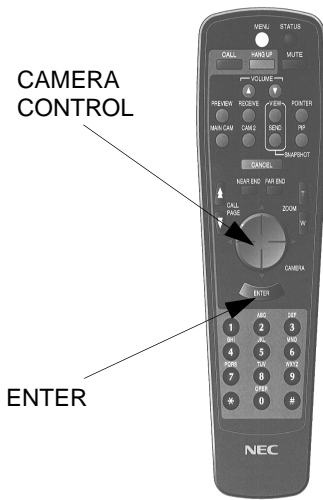



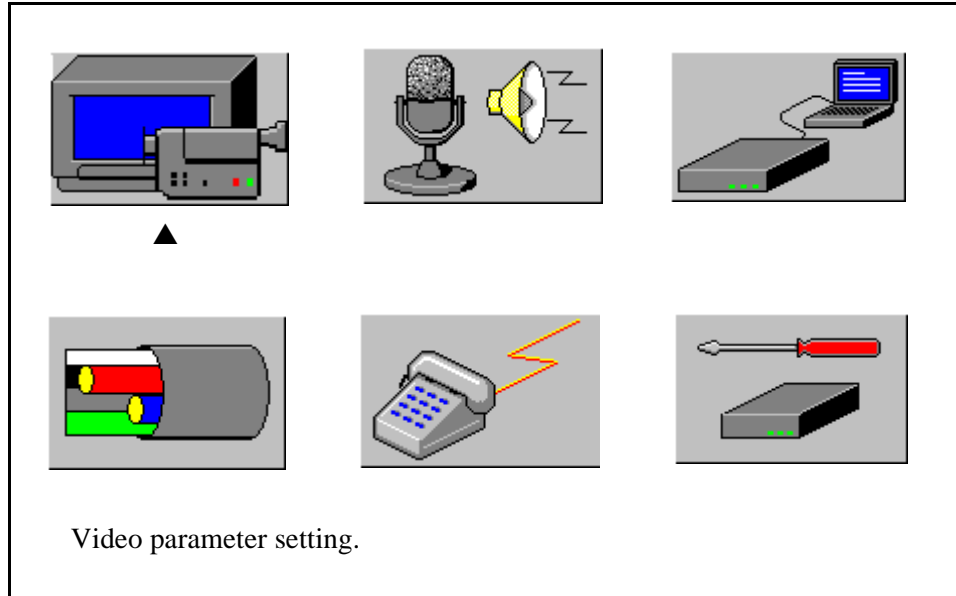
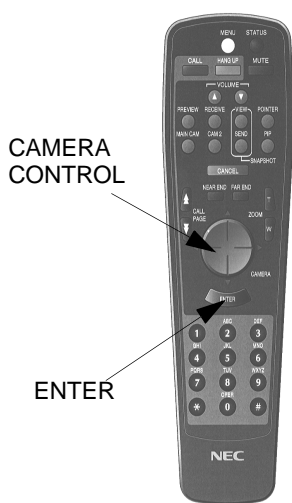

A password consists of 4-digit number. Input characters are displayed in *.

- ⑤ Press the **ENTER** button.
When a password is correctly entered: Environment setting menu is displayed.

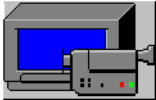

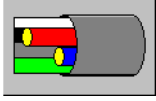
You can choose an icon with the **CAMERA CONTROL** button.

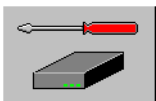
Icon	Description
	Menu icon for setting video algorithms, video coding, video priorities, camera control, and video input selection
	Menu icon for setting audio algorithms, audio delay, audio input/output port assignments, and voice activated camera control.
	Menu icon for activating data speed and serial control.
	Menu icon for setting video speed, network numbers, and call answer mode.
	Menu icon for setting the site name, my number, password, and SPIDs.
	Menu icon for activating loopbacks, also allows for the viewing of hardware, and software rev. levels and allows for initializing.

5.1.2 When a password is incorrect

It goes back to the password-entering screen.

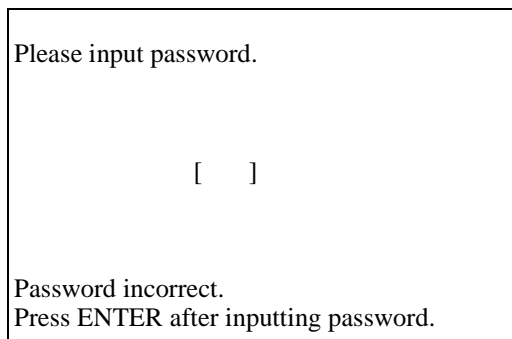

Note: Press the **CANCEL** button to get out of the menu.

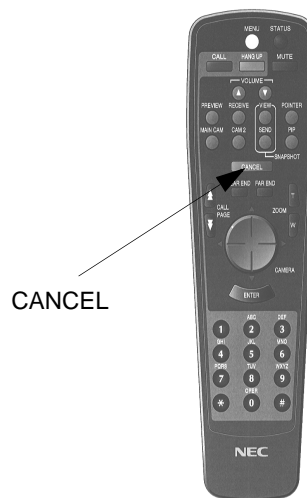

5.2 Video Setting

This sets video, algorithm, types of camera to be controlled, and video input selection.

To set video

- ① Select **VIDEO SETTING** icon in the environment setting menu.

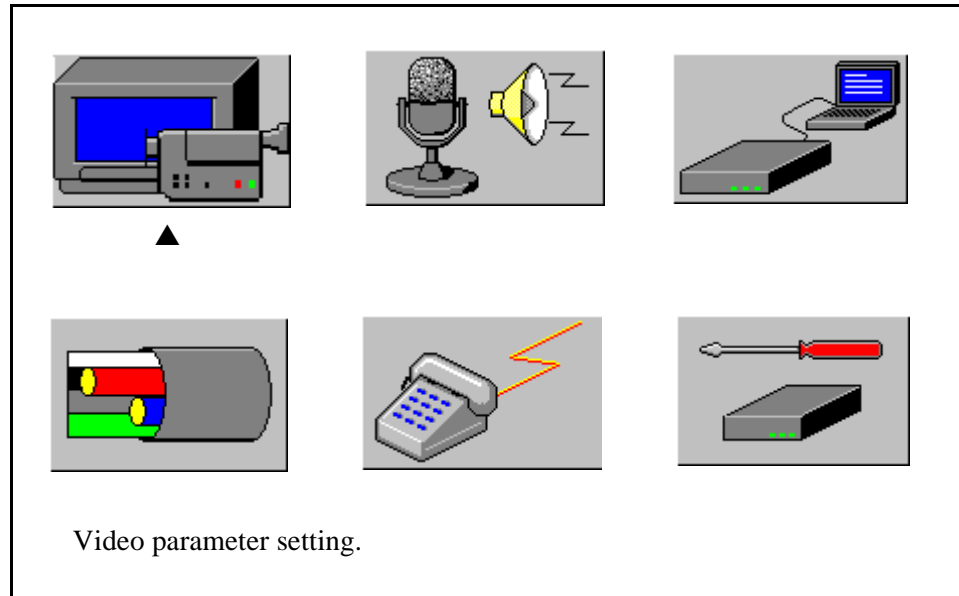
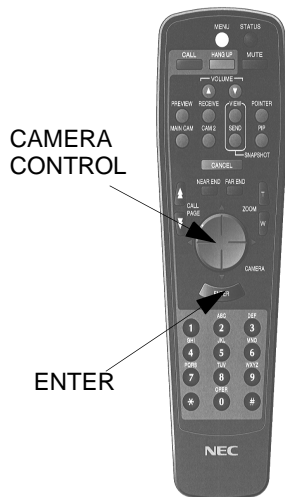

- ② Press **ENTER** button.

The setting screen is displayed. The current setting is displayed.



▶ Video format	: < FCIF >
Video coding	: < H263 >
Video priority	: < Motion >
Camera type	: < EVI-D30 >
Video source	
VIDEO1	: < Camera1 >
VIDEO2	: < Camera2 >
MUTE function	: < Audio and Video >

Press ENTER after choosing.

- Video format:** Sets the video format. Possible settings are:
FCIF:352 x 288 or QCIF:176 x 144
- Video Coding:** Sets the default coding rate. Possible settings are:
H.261 or H.263
- Video priority:** Sets the default video coding transmission rate. Possible settings are:
Motion: more of the bandwidth dedicated toward fps.
Resolution: more of the bandwidth dedicated toward resolution.
- Camera mod:** Sets the type of camera to be controlled. Possible settings are:
EVI-D30 or VC-CI
- Video 1 and 2:** Operate together. Sets which of the video inputs labeled on the back of the VisuaLink are to be camera 1 or 2.
- MUTE function** Sets the audio to a mute or sets the audio and video to mute.

Note 1: To select an item use the up and down portion of the **CAMERA CONTROL** button.

Note 2: To change a setting use the left and right portion of the **CAMERA CONTROL** button to toggle through the item.

③ Press **ENTER** button to define it after changing a setting.

Note: After changing a setting, please turn off the power and on again.

④ Press the **MENU** or **CANCEL** button three (3) times to proceed back to the video image.

5.3 Audio Setting

This icon sets the audio algorithm, audio delay, audio input/output port assignment, and voice activation camera control.

To set audio:

- ① Select audio setting icon in the environment setting menu.

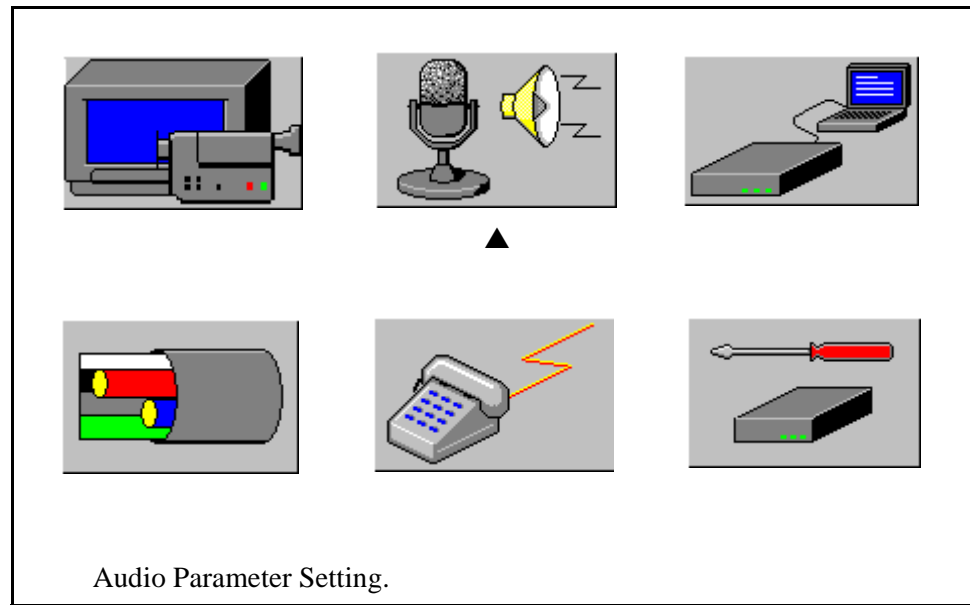
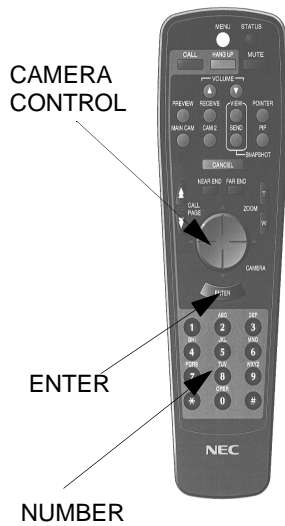

- ② Press **ENTER** button.

The setting screen is displayed. The current setting is displayed.

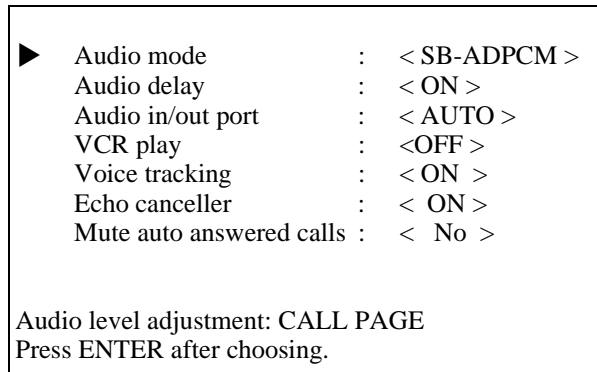

Audio mode:	Sets the default audio coding. Possible settings are: SB-ADPCM (7kHz, 48 ~ 56kbps), μ law PCM (3.5kHz, 56kbps), LD-CELP (3.5kHz, 16kbps) or OFF.
Audio delay:	Sets the audio transmission/reception delay. This allow lip sync.
Audio in/out port:	Sets the audio in and out port. Possible settings are: Auto: The VisuaLink determines which output is connected and input/output from the appropriate connector. Line: The input and output audio from the line level port labeled audio in/out on the back. Headset: The input and output audio from the headset connection on the front. Telephone: The input and output audio from the telephone connection on the back.
VCR play:	Sets the audio input port to receive a VCR audio signal.
Voice tracking:	Sets the voice activated presets on or off.
Echo canceller:	Sets the echo canceller to internal or external mode.
Mute auto answered calls:	Sets the audio to be mute or unmute at the start of communication in an automatic answer mode.

Note 1: To select an item use the up and down portion of the **CAMERA CONTROL** button.

Note 2: To change a setting use the left and right portion of the **CAMERA CONTROL** button to toggle through the item.

③ Press the **CALLPAGE** button to proceed to the **AUDIO LEVEL PAGE**.

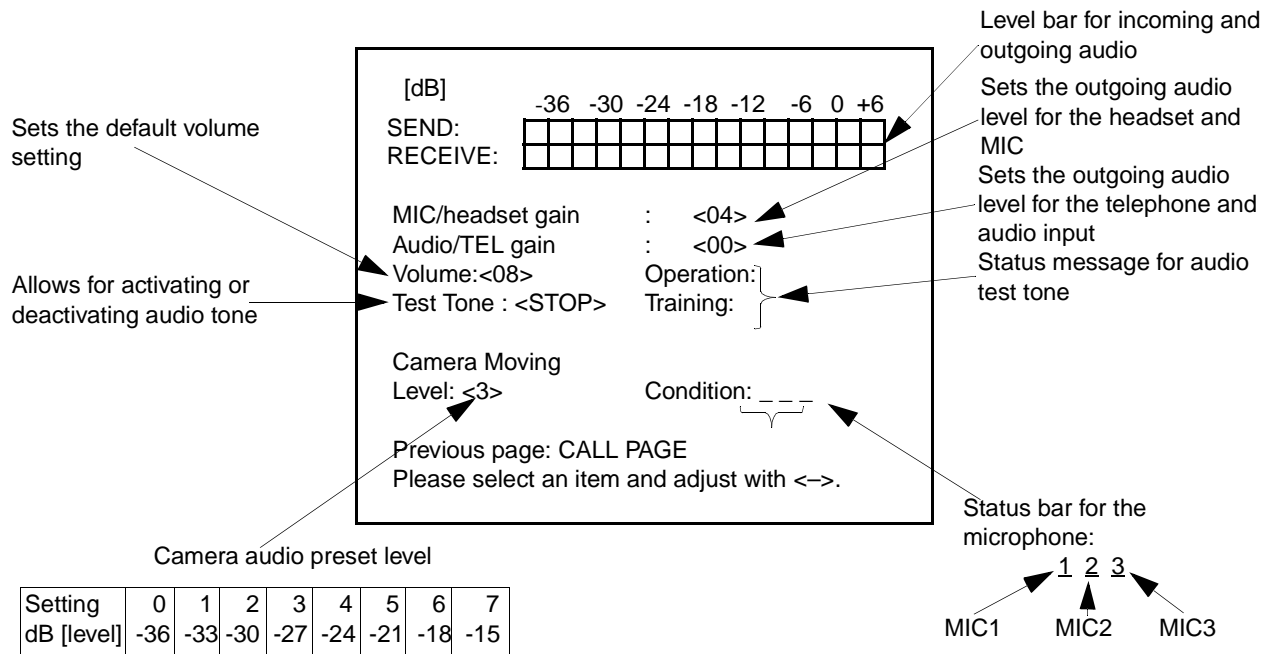

④ Press **ENTER** button to define it after changing a setting.

⑤ Press the **MENU** or **CANCEL** button three (3) times to proceed back to the video image.

5.4 Data Setting

This icon sets the data speed and serial configurations.

To set data speed:

- ① Select data setting icon in the environment setting menu.

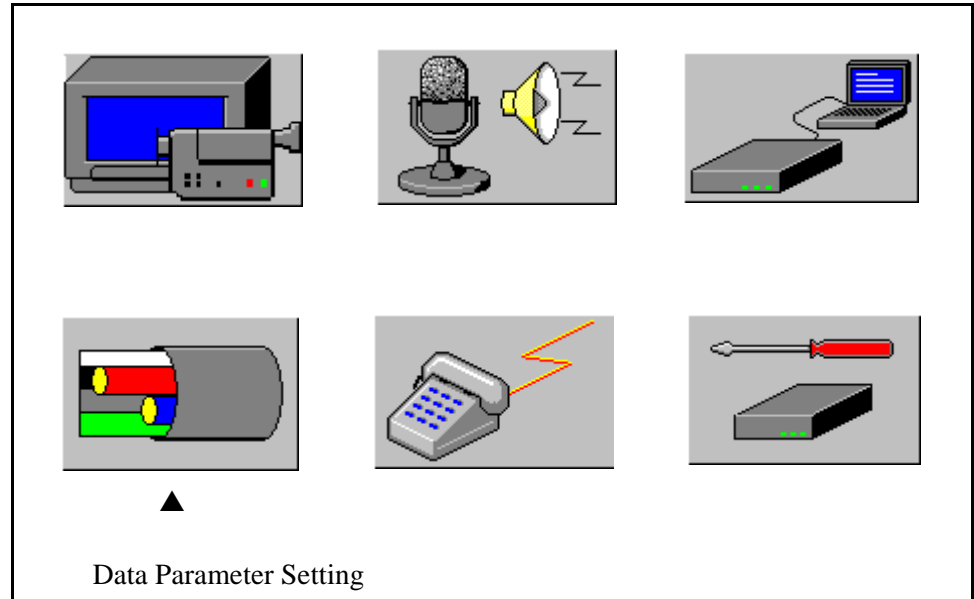
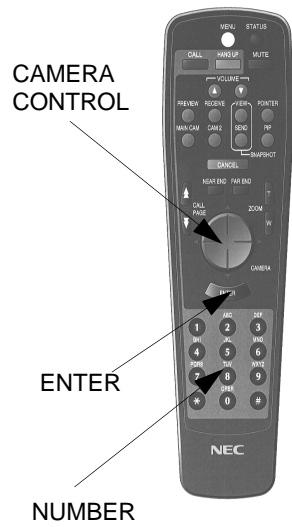

- ② Press **ENTER** button.

The setting screen is displayed. The current setting is displayed.

```

▶ MLP Speed      : < 4.0kb/s >
LSD speed       : < 1.2kb/s >
Serial port setting
  Port 1        : < Camera >
  Port 2        : < Console >
User port speed : < 9.6kb/s >
T120 port speed : < 38.4kb/s >
Console speed   : < 9.6kb/s >
Console parity  : < 8 bit none >

Press ENTER after choosing.

```

MLP:	Multi Layer data sets the speed for NEC far-end control. Note: MLP must be active in order to upgrade VL system on-line.
LSD:	Low Speed data sets the speed for far-end camera control.
Serial port setting:	Sets the type of control to be activated on the serial port.
User port speed:	Sets the data transmission rate for a point-to-point environment.
T120 port speed:	Sets the data transmission rate for a multipoint environment.
Console speed:	Sets the baud speed for a terminal which might be connected to the VisuaLink serial port.
Console parity:	Sets the parity and data length for a terminal which might be connected to the VisuaLink serial port.

Note 1: To select an item use the up and down portion of the **CAMERA CONTROL** button.

Note 2: To change a setting use the left and right portion of the **CAMERA CONTROL** button to toggle through the item.

Note 3: Appendix A is a table detailing MLP to LSD speed setting relationship.

③ Press **ENTER** button to define after changing a setting.

④ Press the **MENU** and **CANCEL** button three (3) times to proceed back to the video image.

5.5 Communication Setting

This icon sets the video speed, network type, and answer mode.

To set communication:

- ① Select communication setting icon in the environment setting menu.

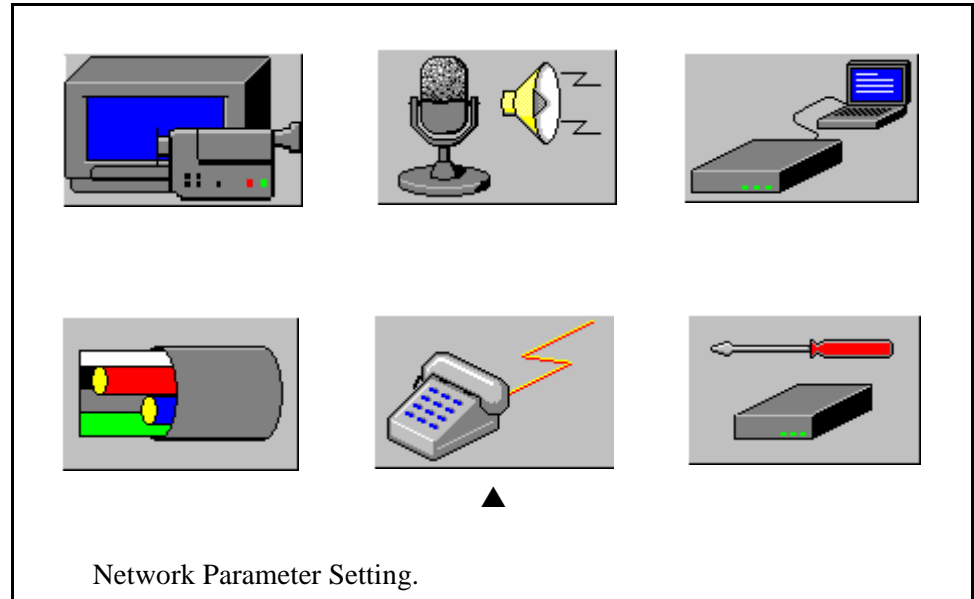
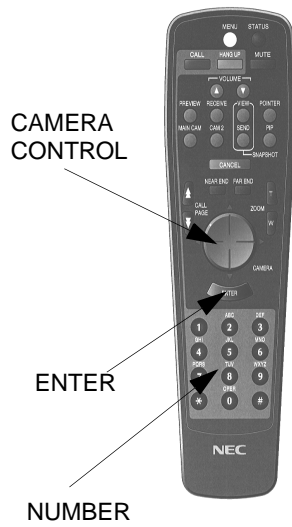

- ② Press **ENTER** button.

The setting screen is displayed. The current setting is displayed.

▶ Speed	: < 128Kb/s >
Incoming mode	: < Select >
Number of rings	: <1>
Restricted dial No.	: [2222]
Call restriction	: < No limit >
Register speed dial	: < Allowed >

Press ENTER after choosing.

- Speed:** Sets the default transmission rate. What ever rate is set, this is the rate shown in the dialing screen.
- Incoming mode:** Sets the incoming call mode. Possible settings are:
 Auto - automatically answers the call.
 Manual - the user must answer the call with the remote.
 Select - Only answers calls that are stored in the speed dial.
- Number of rings:** The number of rings required before the system answers the call.
- Restricted dial No.:** Allows the user to set caller restriction number.
- Call restriction:** Allows the user to set a call restriction. Possible settings are:
 No limit - the user can place calls with no restrictions.
 Speed dial only - the user can only place calls that are stored in the speed dial register.
 Manual dial inhibited - the user cannot place manual calls.
- Register speed dial:** Allows the user to set access level for speed dial registrations. Possible settings are:
 Allowed - allows the user the access to set speed dial.
 Disabled - the user is not allowed to access the speed dial registration.

Note 1: To select an item use the up and down portion of the **CAMERA CONTROL** button.

Note 2: To change a setting use the left and right portion of the **CAMERA CONTROL** button to toggle through the item.

- ③ Press **ENTER** button to define it after changing a setting.
- ④ Press the **MENU** or **CANCEL** button three (3) times to proceed back to the video image.

5.6 Local Setting

This icon sets the site name, my number, password, and SPIDs.

5.6.1 Display the LOCAL SETTING screen

- ① Select **LOCAL SETTING** icon in the **ENVIRONMENT SETTING** menu.

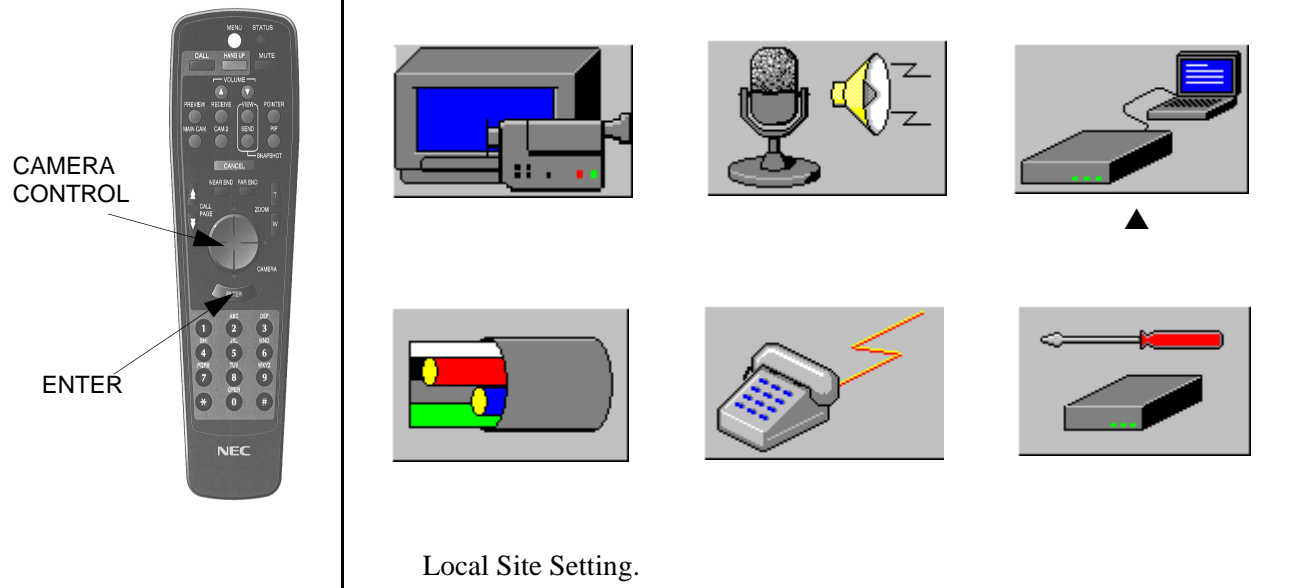

- ② Press **ENTER** button.

The setting screen (location and others) is displayed. The current setting is displayed.

Note 1: To select an item use the top and bottom portion of the **CAMERA CONTROL** button.

Note 2: To enter a number use the **NUMBER** buttons on the handheld remote.

Note 3: After entering the site telephone numbers, move cursor to **NEXT** and press the **ENTER** button. If you are setting up a VisuaLink 128, go to [Step 4](#).

Step 1. VL 128/384



Step 1 -Enter Video Number and SPID for Line 1

My Number1
 [9727190320_]
 SPID1
 [97271903200101_]
 My Number2
 [972719032_]
 SPID2
 ► []

Next screen
 Prior screen

Press ENTER after choosing each item.

Move the cursor to the **NEXT SCREEN** using the top or bottom portion of the **CAMERA CONTROL** button.

Step 1 -Enter Video Number and SPID for Line 1

My Number1
 [9727190320_]
 SPID1
 [97271903200101_]
 My Number2
 [972719032_]
 SPID2
 [9727190321010_]

► Next screen
 Prior screen

Press ENTER after choosing each item.

Note: If you are setting up a VisuaLink 128, go to [Step 4](#).

Step 2. VL 384

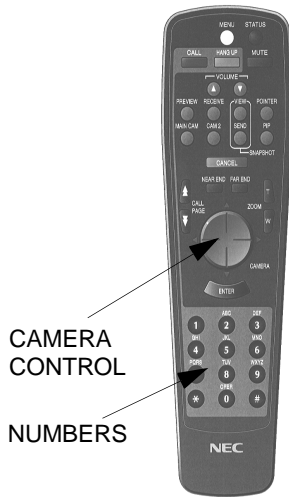

Step 2 - Enter Video Number and SPID for Line 2

My Number1
 [9727190322_]

SPID1
 [97271903220101_]

My Number2
 [9727190323_]

SPID2
 ► []

Next screen
 Prior screen

Press ENTER after choosing each item.

Move the cursor to the **NEXT SCREEN** using the top or bottom portion of the **CAMERA CONTROL** button.

Step 2 - Enter Video Number and SPID for Line 2

My Number1
 [9727190322_]

SPID1
 [97271903220101_]

My Number2
 [9727190323_]

SPID2
 [97271903230101_]

► Next screen
 Prior screen

Press ENTER after choosing each item.

Step 3. VL 384



Step 3 - Enter Video Number and SPID for Line 3

My Number1
 [9727190324_]
 SPID1
 [97271903240101_]
 My Number2
 [9727190324_]
 SPID2
 ► []

Next screen
 Prior screen

Press ENTER after choosing each item.

Move the cursor to the **NEXT SCREEN** using the top or bottom portion of the **CAMERA CONTROL** button.

Step 3 - Enter Video Number and SPID for Line 3

My Number1
 [9727190324_]
 SPID1
 [97271903240101_]
 My Number2
 [9727190324_]
 SPID2
 [97271903240101_]

► Next screen
 Prior screen

Press ENTER after choosing each item.

Step 4. VL 128/384



Step 1 - Optional User Settings

Your Site name
 ► [Irving]

Password [1234]
 Time setting
 [12/1/1998 12 : 07]
 Time display: <Time Only>
 Auto Power Save: <OFF>

Next screen
 Prior screen

Press ENTER after choosing each item.

③ To set the site name, press the **ENTER** button.

Step 5. VL 128/384

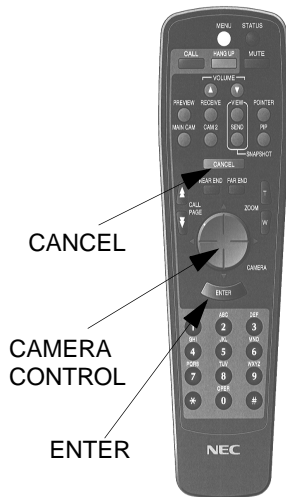

This is Remote Name Registration. Using the cursor to highlight and Press ENTER to select.

Site name: [IRVING_]

[] " # % & ' () * + . / 0 1 2 3 4 5
 6 7 8 9 : ; < = > ? @ A B C D E F G H I J K
 L M N O P Q R S T U V W X Y Z [¥] ^ _ ' a
 b c d e f g h i j k l m n o p q r s t u v w
 x y z { | } ~

Complete
 Cancel

Note: Move the cursor to the character you want to input using the left and right sides of the **CAMERA CONTROL** button and press the **ENTER** button. If incorrectly entered, delete the letter with the **CANCEL** button.

- ④ When complete, use the top and bottom portion of the **CAMERA CONTROL** button to select **COMPLETE** or **CANCEL**. You return to the optional information screen.

Step 1 - Optional User Settings

Your Site name
▶ [Irving]

Password [1234]
Time setting
[12/1/1998 12 : 07]
Time display: <Time Only>
Auto Power Save: <OFF>

Next screen
Prior screen

Press ENTER after choosing each item.

5.6.2 Change the password

- ① Select the password moving the cursor using the top and/or bottom portion of the **CAMERA CONTROL** button.

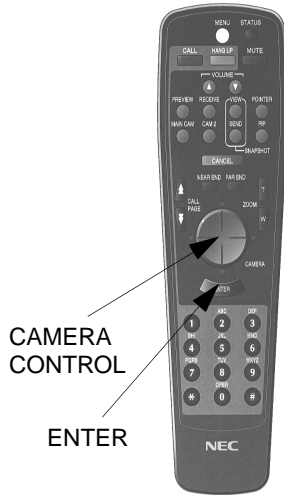

Step 1 - Optional User Settings

Your Site name
[Irving]

▶ Password [1234]
Time setting
[12/1/1998 12 : 07]
Time display: <Time Only>
Auto Power Save: <OFF>

Next screen
Prior screen

Press ENTER after choosing each item.

- ② Press the **ENTER** button to set password.

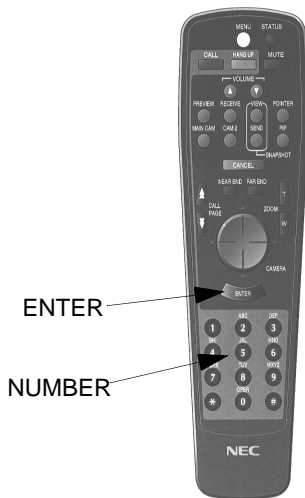

Password [1234]

Input 4-digit password.
Delete digit: CANCEL/ Register digit: ENTER

- ③ Enter a 4-digit password with **NUMBER** button.

Note: If no number is entered, the password protect will be deactivated.

- ④ Register with the **ENTER** button after completing password. You return to the optional user settings screen.

Step 1 - Optional User Settings

Your Site name
[Irving]

▶ Password [1234]
Time setting
[12/1/1998 12 : 07]
Time display: <Time Only>
Auto Power Save: <OFF>

Next screen
Prior screen

Press ENTER after choosing each item.

5.6.3 Set the date and time

- ① Move the cursor to the **TIME SETTING** using the top or bottom portion of the **CAMERA CONTROL** button.



Step 1 - Optional User Settings

Your Site name
[Irving]

Password [1234]

▶ Time setting
[12/1/1998 12 : 07]

Time display: <Time Only>

Auto Power Save: <OFF>

Next screen
Prior screen

Press ENTER after choosing each item.

- ② Press the **ENTER** button to define the time and date setting.

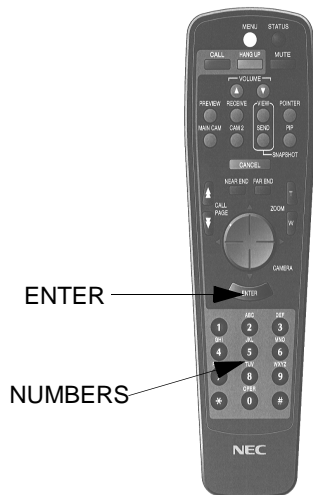

[12/ 01/ 98

12 : 48

Press ENTER after setting date and time.

- ③ Enter date and time with **NUMBER** button.

- ④ Register with the **ENTER** button. You return to the optional user settings screen.

Step 1 - Optional User Settings

Your Site name
[Irving]

Password [1234]

▶ Time setting
[12/1/1998 12 : 07]
Time display: <Time Only>
Auto Power Save: <OFF>

Next screen
Prior screen

Press ENTER after choosing each item.

5.6.4 Set the date and time display

- ① Move the cursor to the **TIME DISPLAY** using the top or bottom portion of the **CAMERA CONTROL** button.

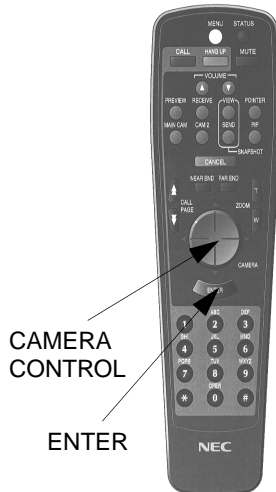

Step 1 - Optional User Settings

Your Site name
[Irving]

Password [1234]

Time setting
[12/1/1998 12 : 07]

▶ Time display: <Time Only>

Auto Power Save: <OFF>

Next screen
Prior screen

Press ENTER after choosing each item.

- ② Using the right or left portion of the **CAMERA CONTROL** button to toggle between **OFF**, **TIME ONLY** and **DATE+TIME** for the **TIME DISPLAY**.
- ③ Register with the **ENTER** button. You return to the optional user settings screen.

Step 1 - Optional User Settings

Your Site name
[Irving]

Password [1234]

▶ Time setting
[12/1/1998 12 : 07]

Time display: <Time Only>

Auto Power Save: <OFF>

Next screen
Prior screen

Press ENTER after choosing each item.

5.6.5 Set the auto power save

- ① Move the cursor to the **AUTO POWER SAVE** using the top or bottom portion of the **CAMERA CONTROL** button.

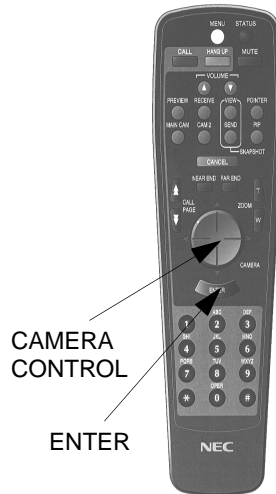

Step 1 - Optional User Settings

Your Site name
[Irving]

Password [1234]
Time setting
[12/1/1998 12 : 07]
Time display: <Time Only>
▶ Auto Power Save: <OFF>

Next screen
Prior screen

Press ENTER after choosing each item.

- ② Using the right or left portion of the **CAMERA CONTROL** button to toggle between **OFF, 1min, 2min, 3min, 4min, 5min, 6min, 7min, 8min, 9min** and **10min** for the **AUTO POWER SAVE**.
- ③ Register with the **ENTER** button. You return to the optional user settings screen.

Step 1 - Optional User Settings

Your Site name
[Irving]

Password [1234]
Time setting
[12/1/1998 12 : 07]
Time display: <Time Only>
▶ Auto Power Save: <OFF>

Next screen
Prior screen

Press ENTER after choosing each item.

- ④ Move the cursor to the **NEXT SCREEN** using the top or bottom portion of the **CAMERA CONTROL** button.

Step 1 - Optional User Settings

Your Site name
[Irving]

Password [1234]
Time setting
[12/1/1998 12 : 07]
Time display: <Time Only>
Auto Power Save: <OFF>

▶ Next screen
Prior screen

Press ENTER after choosing each item.

You must shut down and restart your unit
before the new setting will take effect.
Do you want to restart your unit now?

Yes: ENTER No: CANCEL

- ⑤ Press **ENTER** to restart the system, start up screen will be displayed. Press **CANCEL** to return to **LOCAL SITE SETTING** menu.

NEC

America, Inc.

VisuaLink

Powering Up

Ver .22.02.37

5.7 Maintenance Settings

This sets the loopback test, viewing of hardware/software revision levels and initializing of the VisuaLink.

To set the maintenance functions.

- ① Select the **MAINTENANCE** icon in the Environment Setting menu.

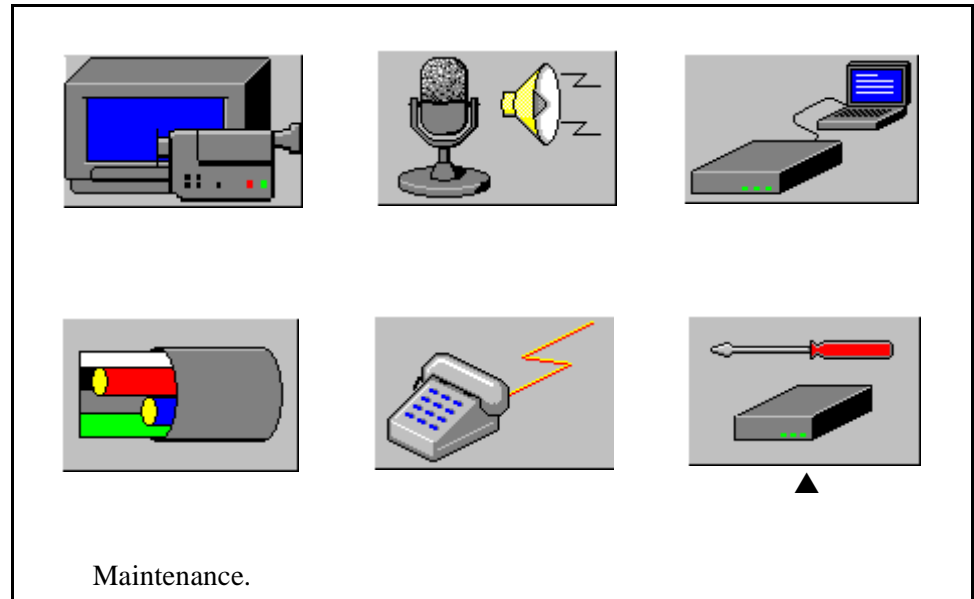
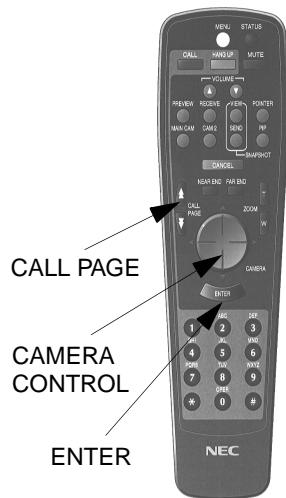

- ② Press **ENTER** button.
The current setting screen is displayed.

Software version	22 . 02 . 37	} ← Status display for software and hardware revisions
Hardware version	12 . 00 . 00	
▶ Loopback test	: < OFF >	← Loopback test setting
Next page: CALL PAGE Press ENTER after choosing.		

- ③ Press the **CALL PAGE** button to advance to the Initialize screen.

► Environment setting initialization
Clear custom register: <Speed dial>

Previous page: CALL PAGE
Press ENTER after choosing.

Note: Clear custom register options are: All, Speed dial, Redial, and Camera Preset.

- ④ Using the **CAMERA CONTROL** button highlight the appropriate initialization and press the **ENTER** button.

Note: Environment setting initialization allows the user to select preconfigured settings.

Applications

1. Rollabout/Other
2. Data Conference
3. Gateway
4. Desktop

Input application number.
Press CANCEL to page back.

SETTINGS	ROLLABOUT/ OTHERS	DESKTOP	DATA CONFERENCE	GATEWAY
Serial 1	Camera	Camera	T120	Camera
Serial 2	Console	Console	Console	Console
MLP	4.0	4.0	24.0	4.0
LSD	1.2	1.2	OFF	1.2
Audio Mode	G.722	G.722	G.728	G.722
Ent. Remote Controller	Auto	OFF	OFF	OFF
H.263	OFF	OFF	OFF	OFF
Motion/Resolution	Motion	Motion	Motion	Motion
LIP Sync	ON	ON	ON	ON
Answer Mode	Auto	Manual	Manual	Auto

Note: Custom setting initializes the entire VisuaLink. When you power the VisuaLink OFF and back ON, the start up configuration menu will appear.

- ⑤ Using the **NUMERICAL** buttons to choose the appropriate initialization. The restart screen appears.

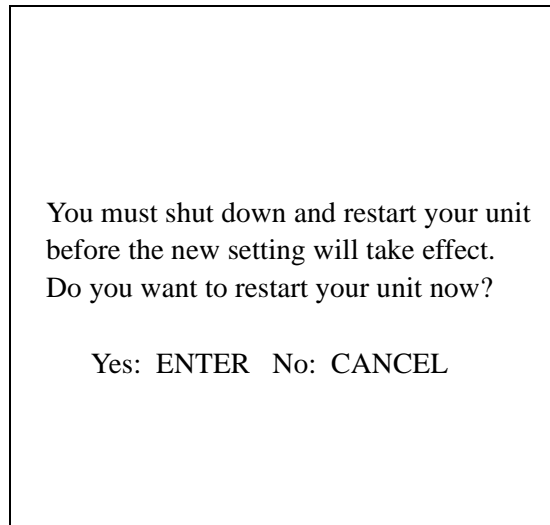

- ⑤ Press **ENTER** to restart the system, start up screen will be displayed. Press **CANCEL** to return to **LOCAL SITE SETTING** menu.

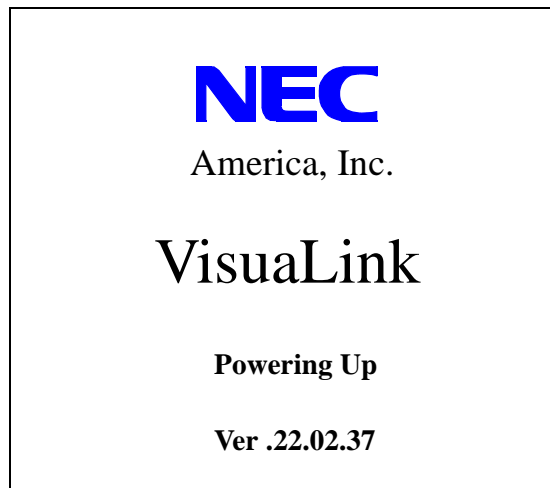

- ⑥ VisuaLink Start up screen.

This page is for your notes.

Chapter 6 About Calling

In this chapter you will learn to make and receive calls. The Dialing Directory is a phone book that you create, listing the names and phone numbers of the sites that you can call. Once you have entered these names and numbers into the Dialing Directory, you can call a site by either Directory dialing or speed dialing. The final section is how to receive a call on your VisuaLink.

6.1 Place a Manual Call

You can manually dial a call by pressing the buttons on the handheld remote the same way you dial a telephone.

- ① To manually dial a call, press the **CALL** button.

Note: With video calls, you may have to enter two (2) telephone numbers instead of one due to the ISDN BRI network connections often consist of two (2) lines within one ISDN cable.



► Place Manual Dial Call
Place Redial Call

001.
002.
003.
004.
005.

Press ENTER after choosing

- ② Make sure the ► is pointing at **PLACE MANUAL DIAL CALL**. Press the **ENTER** button.

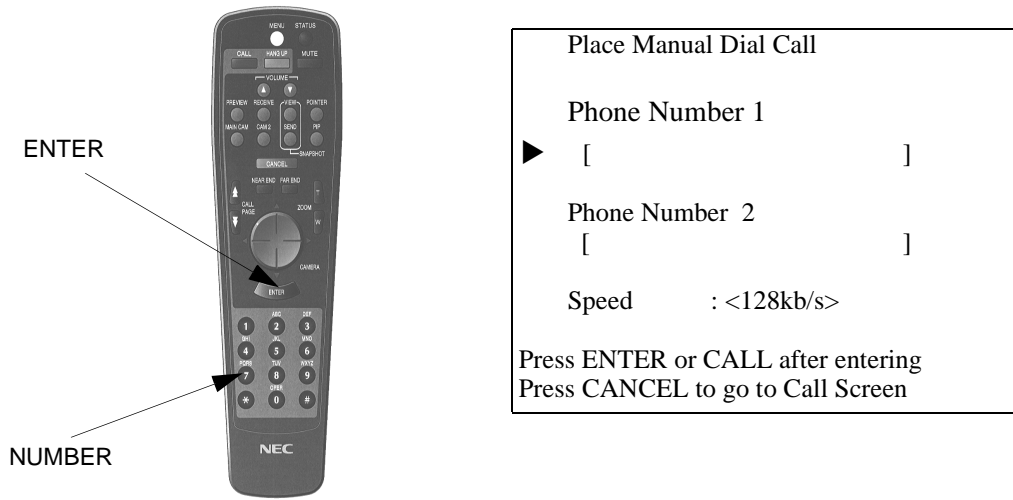

Checking Operation

Verify that local and remote sites are able to be seen and heard at the remote ends. Verify that a control from the remote controller is normal by referring to [Chapter 8 Operation Method](#).

If unable to connect to the remote site it maybe because the remote site is busy, wait and then repeat the above operation. If the operation persist, proceed to [Chapter 9 Troubleshooting](#).

③ Enter the first telephone number using the **NUMBER** buttons,.

Note 1: When pressing down side on **CAMERA CONTROL** button after the first number is completed, the number is copied to **PHONE NUMBER 2**. This is done because typically when dialing two (2) BRI numbers, the **PHONE NUMBER 2** number sometimes exactly match or is similar to the first number.

Note 2: At any time you may press the **CALL** button and **ENTER** button. This will immediately place a video call to the far-end.

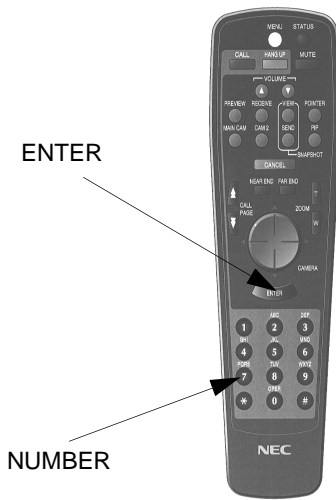

Place Manual Dial Call	
Phone Number 1	[9725185000]
▶ Phone Number 2	[9725185000]
Speed	: <128kb/s>
Press ENTER or CALL after entering Press CANCEL to go to Call Screen	

- ④ If your call needs two (2) telephone numbers, enter the second number using the **NUMBER** buttons. Press the **ENTER** button when finished. If your call needs only one (1) telephone number, skip this step.

Note: Two (2) call numbers are only needed when placing a 112/128 kbps call. All other speeds only require one (1) telephone number.

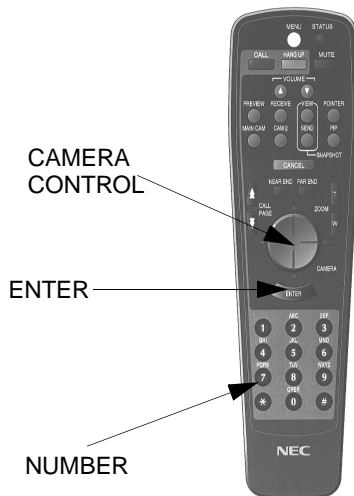

Place Manual Dial Call	
Phone Number 1	[9725185000]
▶ Phone Number 2	[9725185001]
Speed	: <128kb/s>
Press ENTER or CALL after entering Press CANCEL to go to Call Screen	

- ⑤ Press the **CAMERA CONTROL** button and the **SPEED** is chosen. Using the **CAMERA CONTROL** button, press the left or right side to scroll through the speeds until the appropriate speed is found.

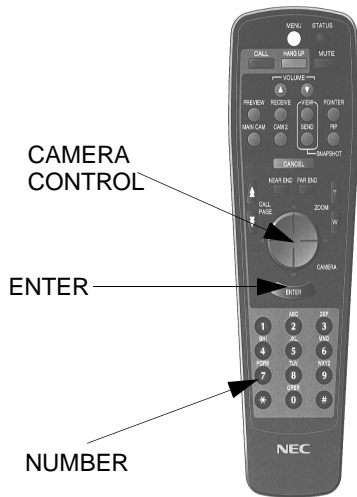

Place Manual Dial Call

Phone Number 1
[9725185000]

Phone Number 2
[9725185001]

▶ Speed : <128kb/s>

Press ENTER or CALL after entering
Press CANCEL to go to Call Screen

SPEED	PHONE NUMBERS NEED TO BE ENTERED
TEL, 56, 64	1
112, 128	2 (VL128) 1 or 2 (VL384)
168, 192	1 (VL384)
224, 256	1 (VL384)
280, 384	1 (VL384)

⑥ Press the **ENTER** button or **CALL** button to start dialing the remote site.

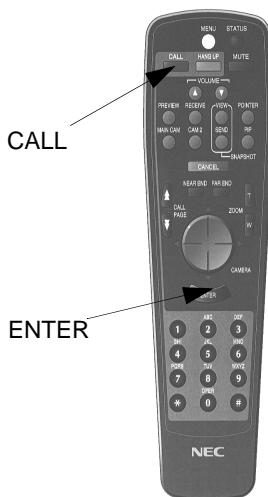

Calling Remote Site. Please wait...

Phone Number 1
[9725185000]

Phone Number 2
[9725185001]

Once the line has been connected, the screen will automatically display the remote site.

Receiving Video
from Remote Site
Connected Line Speed: 128kb/s
REC

After the lines connect a picture from the far-site appears.



6.2 Set Speed Dial Number

The Dialing Directory is a phone book that you create, listing the names and phone numbers of the remote sites. It makes dialing calls faster and easier. When you add a new directory entry, you enter the site name and the phone number. When you add an entry, the speed dial directory assigns a speed dial number for that site. The next time you want to call that site, you can simply type in the speed number or highlight the site name.

6.2.1 Adding a new entry in the Speed Dial Bin

- ① Press the **MENU** button to display the on-screen icons.

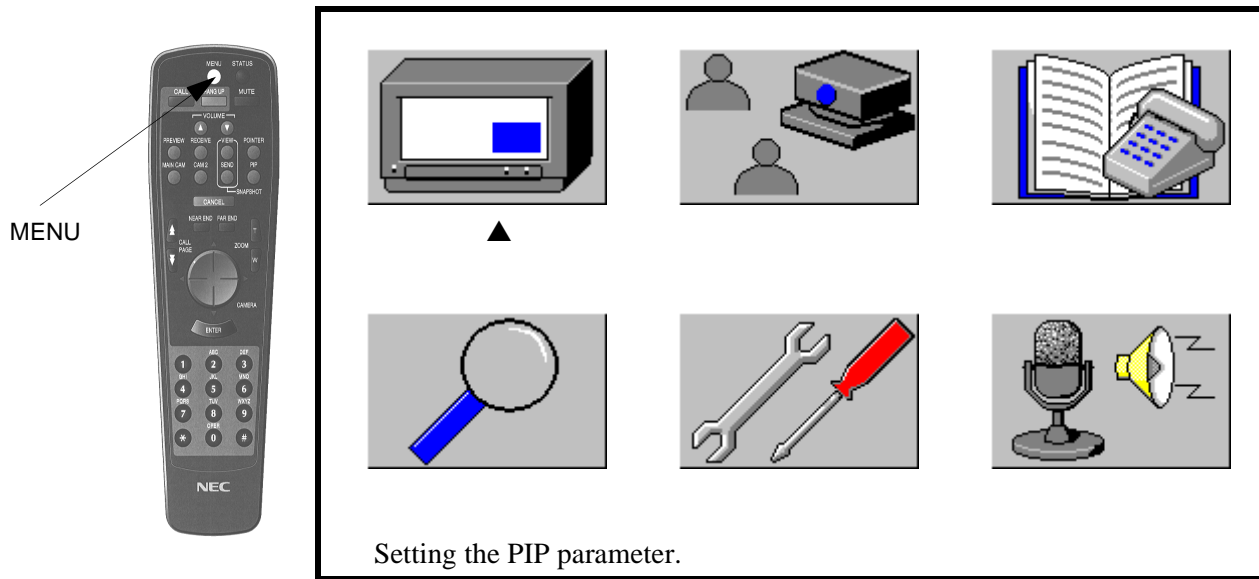

- ② Highlight the icon for Registering the Speed Dial Numbers using the **CAMERA CONTROL** button and press the **ENTER** button.

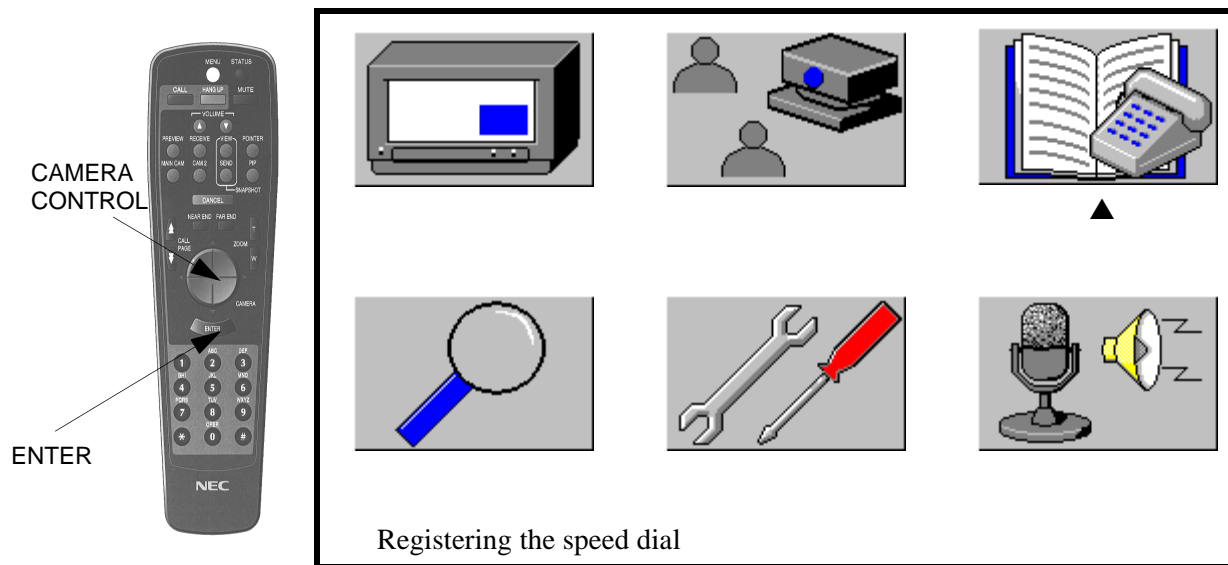

Speed Dial Menu is displayed. ► shows the selection of a number.

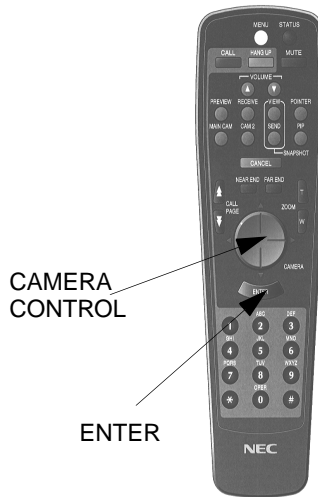

Speed dial register

► 001.
002.
003.
004.
005.

Press ENTER after choosing a number.

Note: If a name is displayed beside a number, it is already registered.

- ③ Enter the **SITE NAME** by the following steps:
 - a. Highlight the letter, number, or symbol that you want using the **CAMERA CONTROL** button.
 - b. Press the **ENTER** button to accept the letter, number, or symbol. The letter, number, or symbol appears next to the **SPEED DIAL NUMBER** at the top of the screen.
 - c. Repeat steps a and b for each letter, number, or symbol for the name.
 - d. When finished entering the site name, highlight **COMPLETE** and press the **ENTER** button.

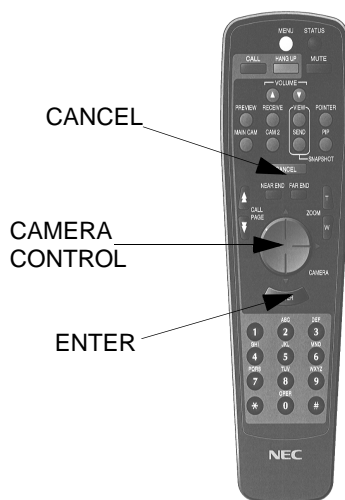

This is the Remote Site Registration. Using the cursor to highlight and press **ENTER** button to select.

001. [_]

[] " # % & ' () * + . / 0 1 2 3 4 5
6 7 8 9 : ; < = > ? @ A B C D E F G H I J K
L M N O P Q R S T U V W X Y Z [¥] ^ _ ' a
b c d e f g h i j k l m n o p q r s t u v w
x y z { | } ~
COMPLETE
CANCEL

- ④ Speed Dial setting screen is displayed.

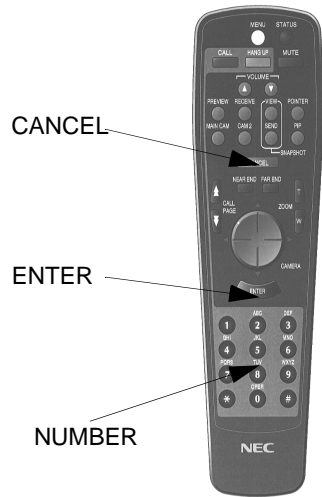

001. Irving

Phone Number 1

▶ []

Phone Number 2

[]

Speed : < 128kb/s>

Press ENTER after entering

- ⑤ Type the first telephone number using the **NUMBER** buttons. If incorrectly entered, delete a number with the **CANCEL** button.
- ⑥ Using the **CAMERA CONTROL** button, select **PHONE NUMBER 2**. Type the second telephone number.

Note: If placing a video call at rates above 128, this step maybe deleted.

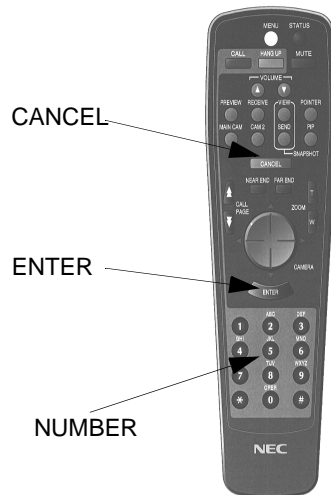

001. Irving

Phone Number 1

[9725185000]

Phone Number 2

▶ [9725185001]

Speed : < 128kb/s>

Press ENTER after entering

- ⑦ Using the **CAMERA CONTROL** button, highlight **SPEED**. Using the left and right sides of the **CAMERA CONTROL** button, set the **VIDEO SPEED**. The default is 128.

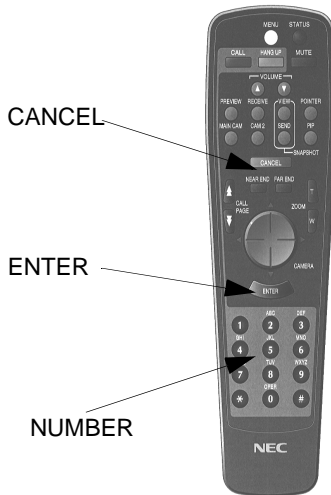

001. Irving

Phone Number 1
[9725185000]

Phone Number 2
[9725185001]

▶ Speed : < 128kb/s>

Press ENTER after entering

Two telephone numbers are needed.



SPEED DIAL CHOICES	
128	384
TEL	TEL
56	56
64	64
112	112
128	128
	168
	192
	224
	256
	280
	320
	336
	384

- ⑧ Press the **ENTER** button to return to the **SPEED DIAL** screen.

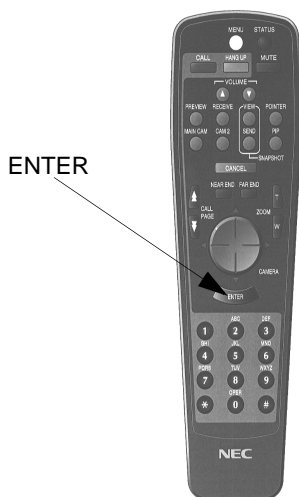

Speed dial register

- ▶ 001. Irving
- 002.
- 003.
- 004.
- 005.

Press ENTER after choosing a number.

- ⑨ Repeat ① to ⑧ to register additional **SPEED DIAL** numbers.

6.2.2 Place Speed Dial Calls

To dial a call from the dialing directory.

- ① Press the **CALL** button.



► Place Manual Dial Call
Place Redial Call

001.
002.
003.
004.
005.

Press ENTER after choosing

- ② Move the cursor to the site you want to call using **CAMERA CONTROL** button. Press the **ENTER** button.

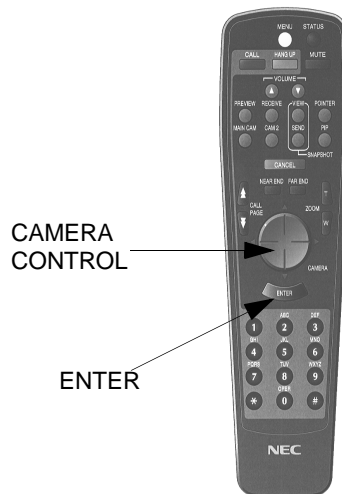

Place Manual Dial Call
Place Redial Call

► 001. Irving
002.
003.
004.
005.

Press ENTER after choosing

- ③ The following series of screens will appear on the monitor as the VisuaLink is placing the call.

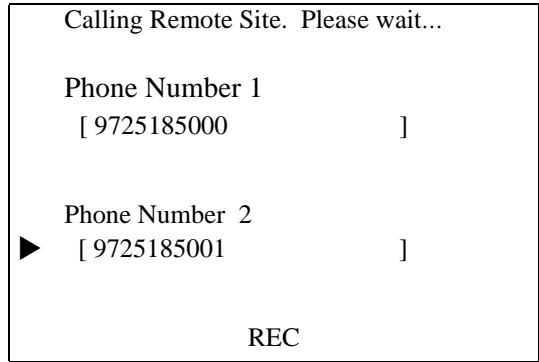
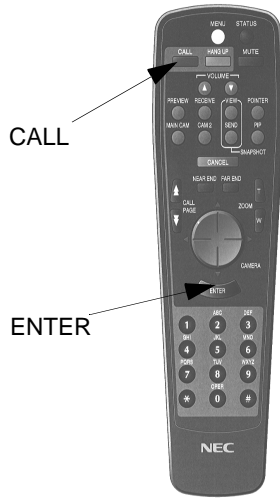

Once the line has been connected, the screen will automatically display the remote site.

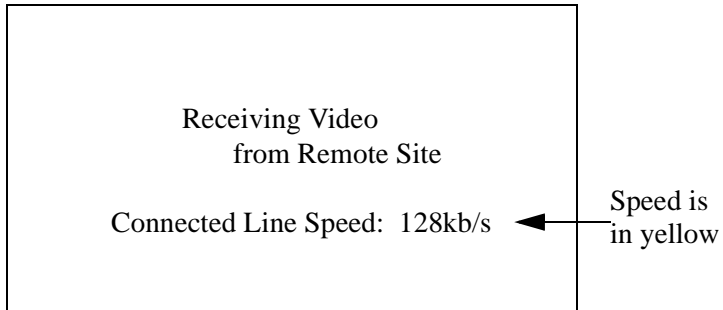

After the lines connect a picture from the far-site appears.



6.2.3 Redialing a Call

Sometimes when you place a video call, the call may not go through the first time. If this happens, you may want to redial the call. Just as with the redial feature on your telephone, the redial feature on your VisuaLink lets you automatically call the last 30 numbers that you have called or have received.

- ① Press the **CALL** button.
The Dial Directory screen appears.



- ▶ Place Manual Dial Call
- ▶ Place Redial Call

001. Irving
002.
003.
004.
005.

Press ENTER after choosing

- ② Using the **CAMERA CONTROL** button, move the cursor down to the **PLACE REDIAL CALL** and press the **ENTER** button.

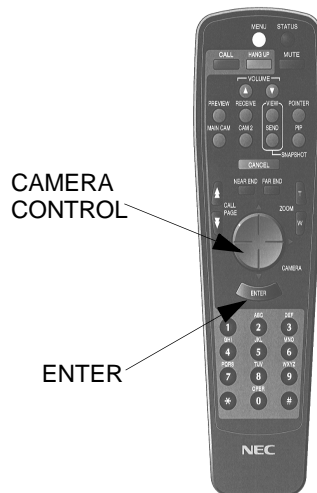

- ▶ Place Manual Dial Call
- ▶ Place Redial Call

001. Irving
002.
003.
004.
005.

Press ENTER after choosing

- ③ Select the number that you would like to redial from the menu. Use the **CAMERA CONTROL** button to scroll up or down through the 30 numbers. Press the **ENTER** button to make the call.

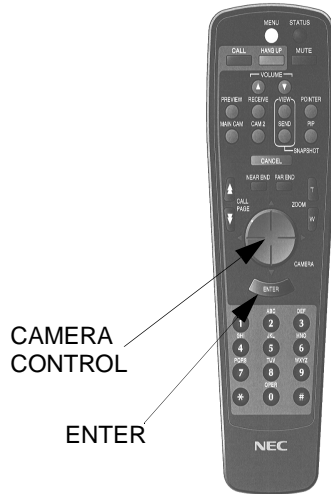

Select Number to Redial

- | | |
|-----------------------|----------|
| ▶ 001. 7190409**71904 | Calling |
| 002. 9727190409 | Incoming |
| 003. 17007307878 | Calling |
| 004. 17007346464 | Calling |
| 005. 7190411**71904 | Calling |

Press ENTER after choosing
Press CANCEL to go to Call Screen

Note 1: The redial bin stores the last 30 numbers dialed or received. The message to the right of the number indicates whether the call was incoming or called.

Note 2: All redial numbers are stored as phone numbers.

Note 3: The redial number are stored in consecutive order.

- ④ The following series of screens will appear on the monitor as the VisuaLink is placing the call.

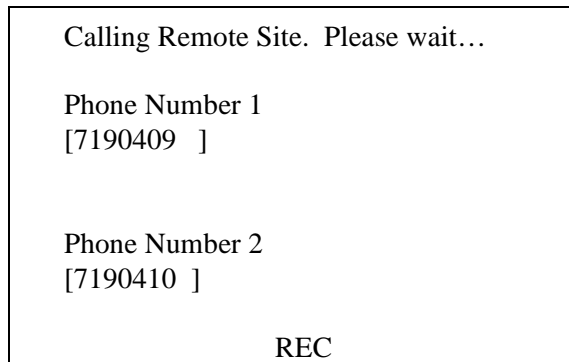
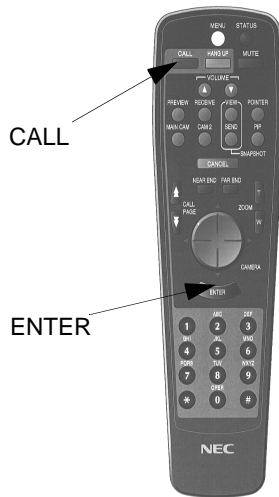

Once the line has been connected, the screen will automatically display the remote site.

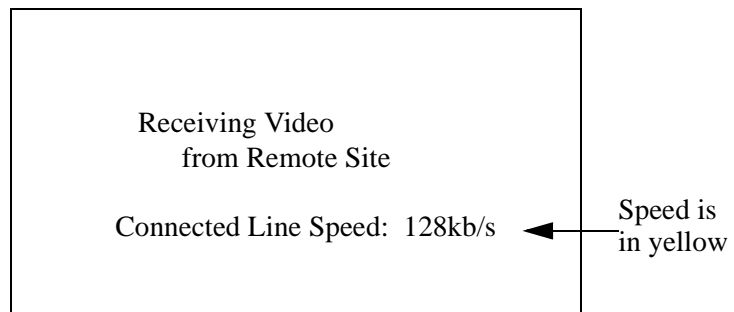

After the lines connect a picture from the far-site appears.



6.3 End a Call

Press the **HANGUP** button on the remote controller to display the menu for disconnecting the remote end.

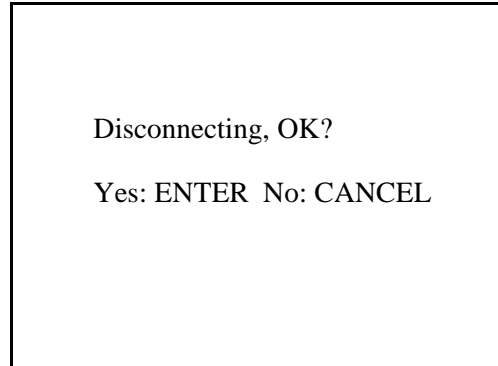
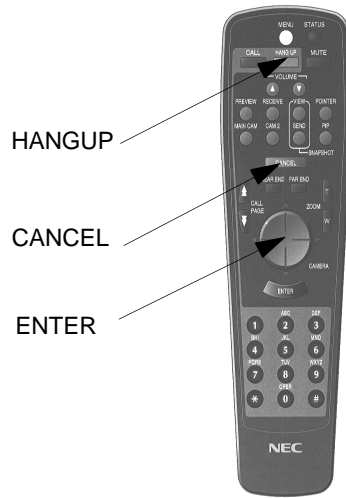

- ① Press the **ENTER** button to end the video call. Press the **CANCEL** button to continue the video call.

Note 1: If the line cannot be disconnected from the remote controller, turn off the power switch. This will force the VisuaLink to hang up the video call.

Note 2: If the far-end hangs up first, you will see the message **FAR-END HUNG UP** on your screen.

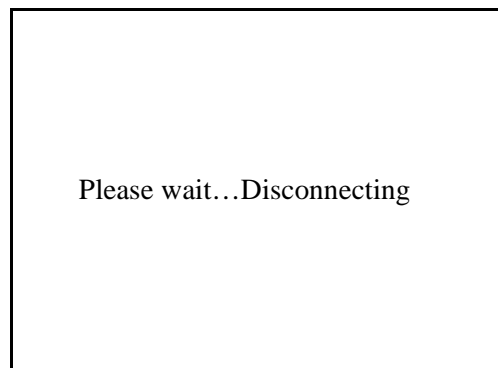

6.4 Answer a Call

The VisuaLink is able to be set to automatic answer mode or manual answer. If the VisuaLink set to an automatic answer all incoming calls will be answered by the VisuaLink without user intervention. When you receive a video call and your system is set for manual answer, your system rings just like a telephone, and you see a message like this on your screen:

INCOMING CALL, PRESS ENTER TO ANSWER.

- ① To answer the call:
Press the **ENTER** button. The following sequence will appear.

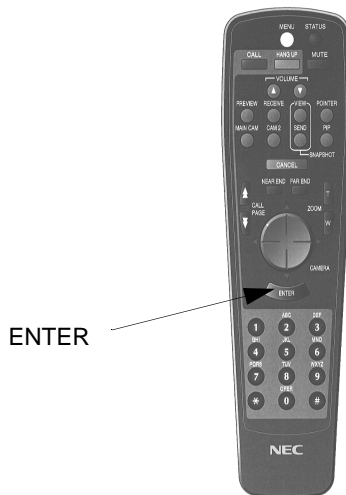

Incoming call.....

Remote Address: Irving HQ
9721234567

Accept call?

Yes: ENTER No: CANCEL

Please select a key.

- ② The following screen appears when an incoming call is received.

Accepting incoming call.....

Remote Address: Irving HQ
9721234567

Please wait.

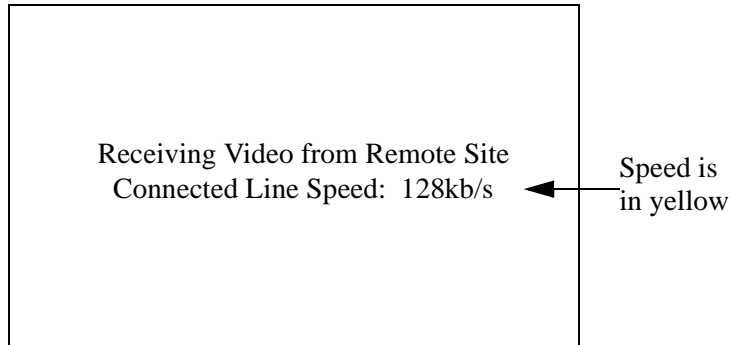

③ Press **CANCEL** button if rejecting an incoming call.

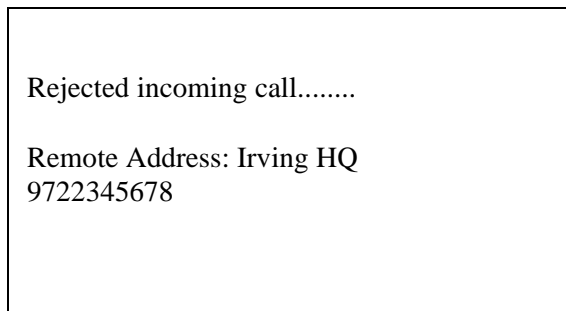
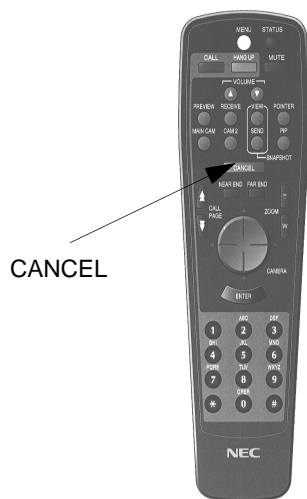

Chapter 7 Conference Mode

This chapter gives an in-depth description of the on-screen menus.

7.1 How to Display the Conference Mode On-Screen Icons

This menu will display line speed, audio mode, video format and data settings for the local site and conference mode.

- 1 Press **MENU** button to display the on-screen icons.

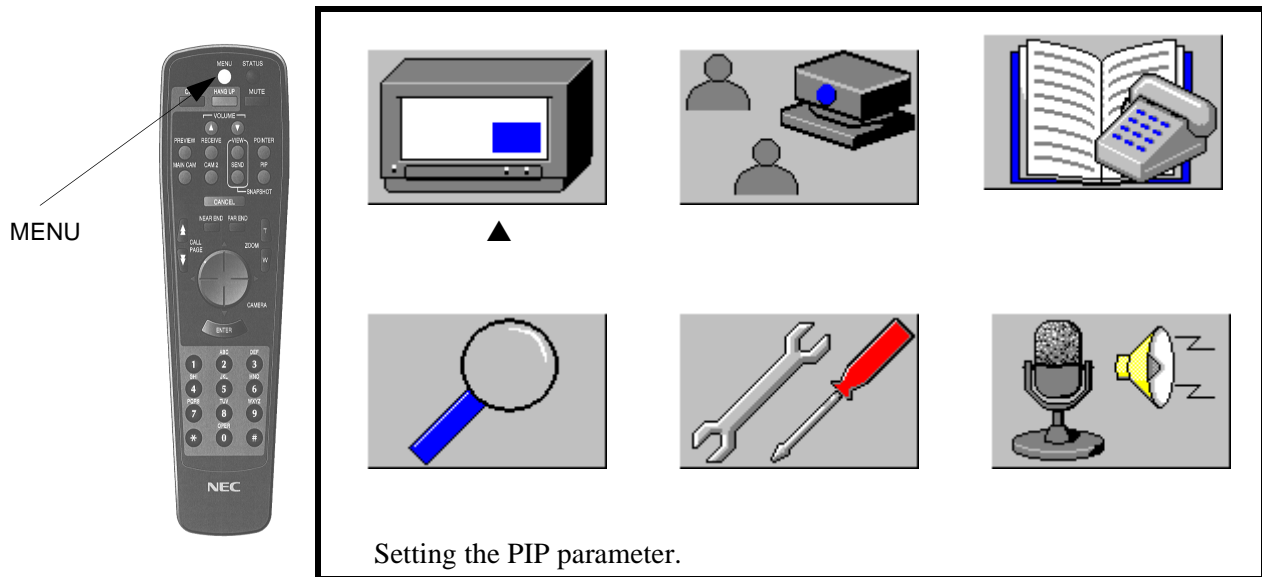

Icon

Description

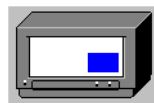

Menu screen for setting PIP position to be displayed on the screen.



Menu that lets you store the camera position.



Menu that lets you store a remote sites telephone number.



Menu that lets you view the conference settings.



Menu that allows the user to set the default condition of the VisuaLink.



Activates audio training in order to condition the room for audio.

- ② Move the cursor ▲ with **CAMERA CONTROL** button to the conference control icon and press **ENTER** button. Conference Control Menu is displayed.

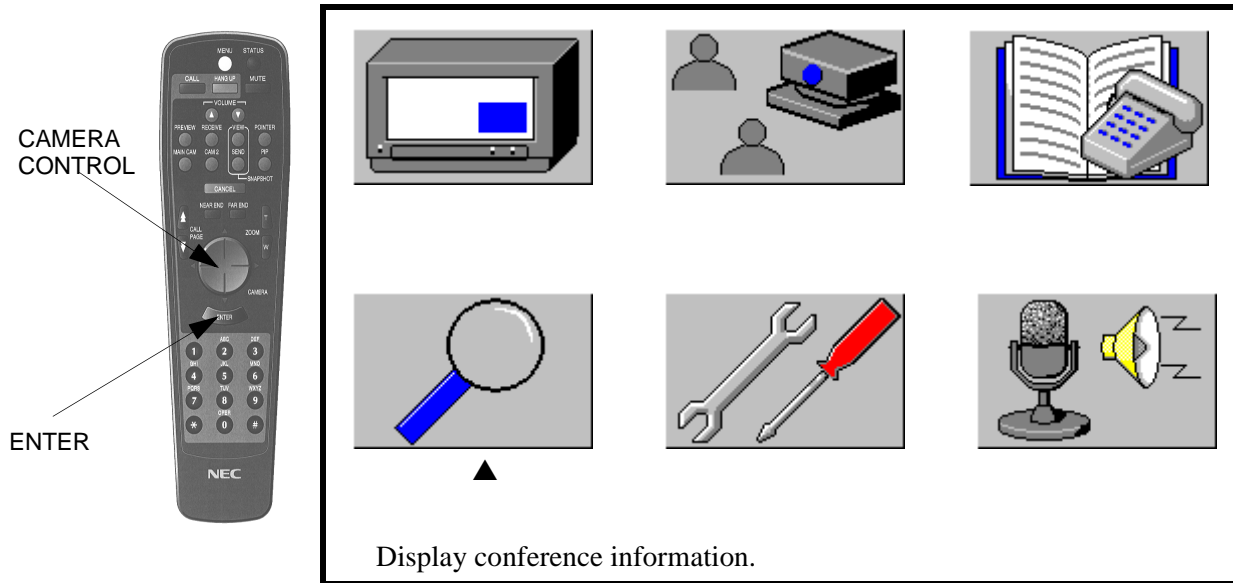

Local screen setting with no connection.

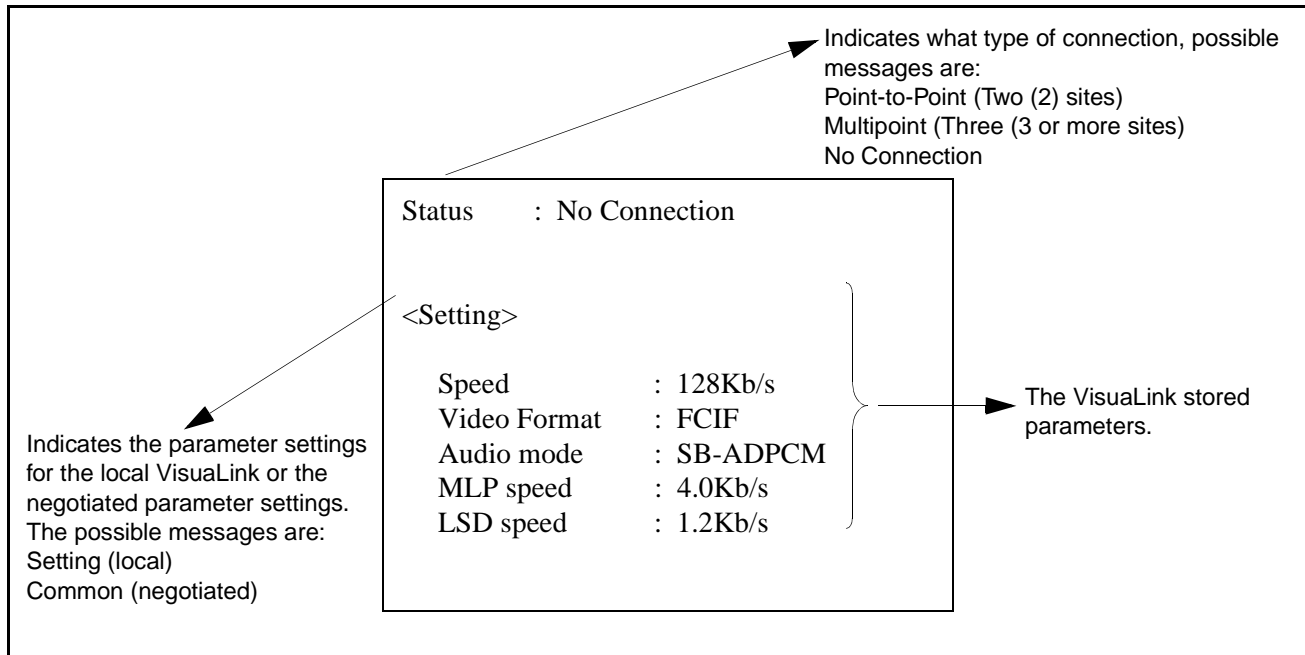

- ③ Press the **CAMERA CONTROL** button left side to see the **COMMON** settings.

Status : Point-to-Point
 Remote : 9725184380

<Common>
 Speed : 384Kb/s
 Video Format : QCIF
 Audio mode : LD-CELP
 MLP speed : OFF
 LSD speed : 2.4Kb/s

Switch <Common> or <Setting> mode using <-> key.

Far-end Telephone Number

Negotiated parameters.

Note: This **COMMON** setting screen will only appear when the VisuaLink is connected to a remote control.

- ④ Press the **CANCEL** button and/or the **MENU** button to return to the video image.

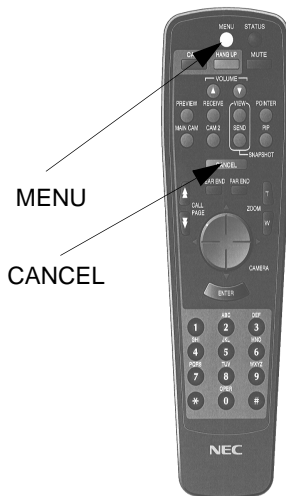

7.2 Picture-in-Picture Menu

The little window that is displayed on your screen is called the Picture-in-Picture (PIP) windows. You can make this window appear or disappear anytime during the configuration. The PIP can be displayed in any quadrant.

Set PIP display:

- ① Press the **MENU** button to display the onscreen icons.
- ② Select icon that displays a picture with a little window. The icon is called **SETTING THE PIP DISPLAY POSITION**.

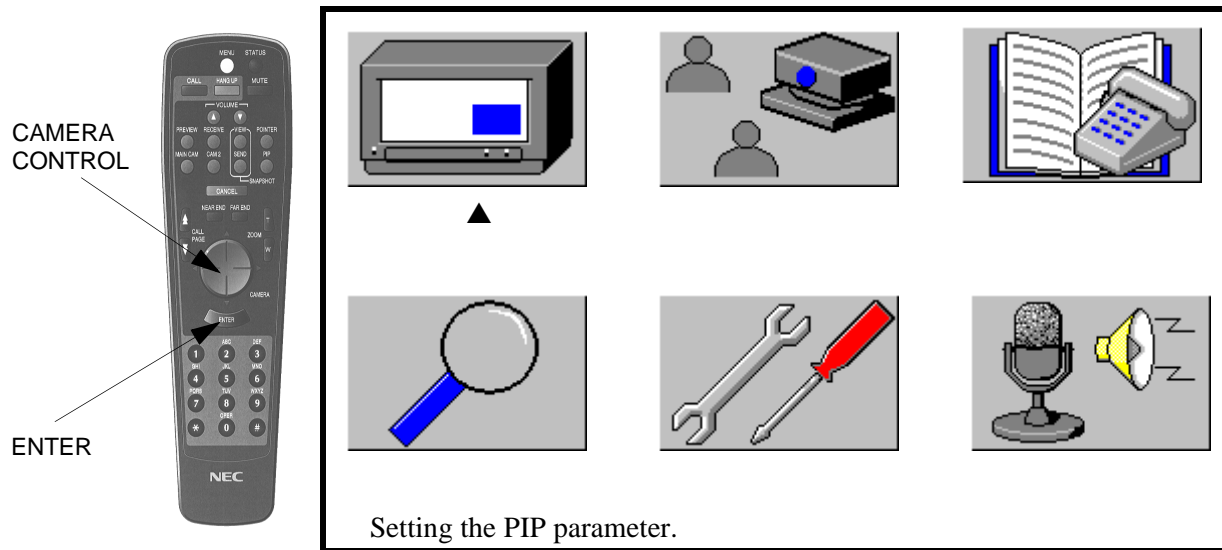

- ③ Press the **ENTER** button.

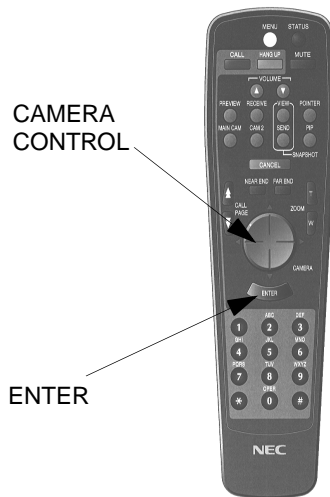

▶ PIP position	:	<Bottom right>
PIP format	:	<Mirror >
PIP of Snap	:	<Receive >

Press ENTER after choosing.

PIP position: Sets the display position for PIP on the monitor screen. Possible settings are:

Top right
 Top left
 Bottom right
 Bottom Left

PIP format: Sets the video image to be displayed in PIP.

Non_Mirror: displays the video image as is

Mirror: displays the video image as it would be seen in a mirror

PIP of Snap: Sets the display image to be shown in the PIP when a snapshot is displayed on the screen.

Send: displays the motion video image that is sent to the far-end

Receive: displays the motion video image being transmitted by the far-end

- ③ Move the cursor up and down with **CAMERA CONTROL** button to select the appropriate option.
- ④ Press the left or right side of the **CAMERA CONTROL** button to toggle through all the possible settings.

- ⑤ The PIP image is displayed if you selected **RECEIVE** in the PIP menu.

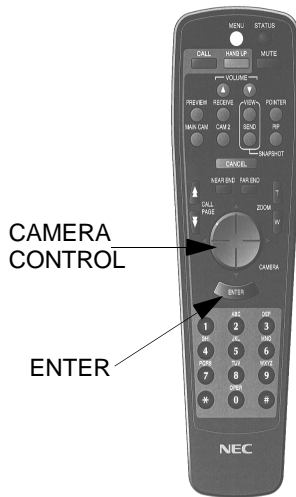

- ⑥ Press the **CANCEL** or **MENU** button twice to return to the video image.

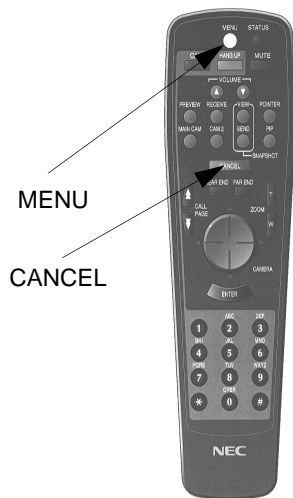

7.3 Camera Preset Menu

During a videoconference, you may want the camera to point at a particular person or location, such as at the main speaker or at a flipchart. Camera presets are buttons that let you store camera positions for the main and sub-camera. After you set a camera preset, all you have to do is press one numerical button to make the main or sub-camera move to that stored preset.

To set camera preset button:

- ① Set the camera to the desired position. Adjust the image using **CAMERA CONTROL** and **ZOOM** buttons. Keep doing this until the camera is showing the image exactly the way you want it.
- ② Press the **MENU** button to display the on-screen icons.
- ③ Select **REGISTRATING THE CAMERA PRESET POSITION** icon using the left or right side of the **CAMERA CONTROL** button.

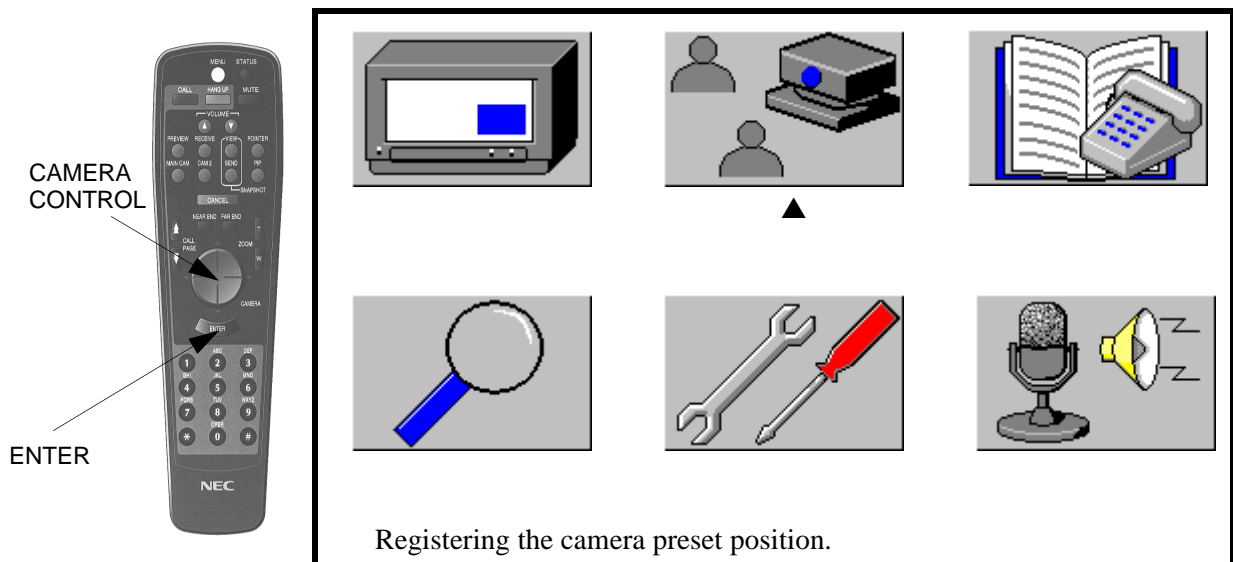

- ④ Press **ENTER** button.

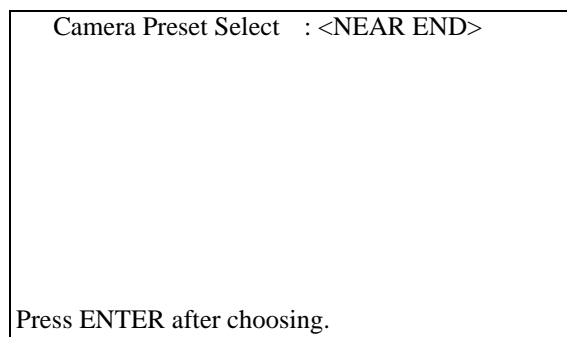

Note: Camera preset selection allows two setting: **NEAR END** and **FAR END**.

- ⑤ Select the camera that is to be preset.
The **CAMERA PRESET SELECT** option is highlighted, using the **CAMERA CONTROL** button (press left or right side) select between the **NEAR END** and **FAR END** camera options. Press the **ENTER** button when the selection is made.

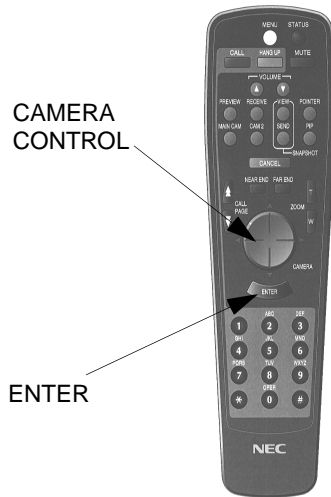

Registering NEAR END camera preset

- ▶ 1. Camera name: Name of Preset
- 2. ↓
- 3. ↓
- 4. ↓
- 5. ↓
- 6. ↓
- 7. ↓
- 8. ↓
- 9. ↓

Press ENTER after choosing.

- ⑥ Select the preset number.
To highlight the **PRESET NUMBER** option, use the **NUMBER** buttons or the **CAMERA CONTROL** button to select a preset number. Press the **ENTER** button when the selection is made.

Note: The VL allows for up to 9 camera presets. The first three of the nine presets are voice activated and are in yellow.

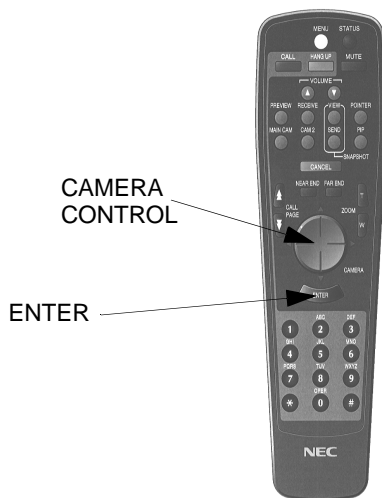

Talkers name: __

█ ! " # % & ' () * + . / 0 1 2 3 4 5
 6 7 8 9 : ; < = > ? @ A B C D E F G H I J K
 L M N O P Q R S T U V W X Y Z [\] ^ _ ' a
 b c d e f g h i j k l m n o p q r s t u v w
 x y z { | } ~

Complete
 Cancel

Using the cursor to highlight and press ENTER to select.

- ⑦ Select the talker name.
Enter the name you would like displayed everytime the preset is activated. Highlight the letter or number to be selected, press the **ENTER** button to input and use the **CANCEL** button to delete last selected option. After entering the name move cursor to **COMPLETE** and press **ENTER** button to store.

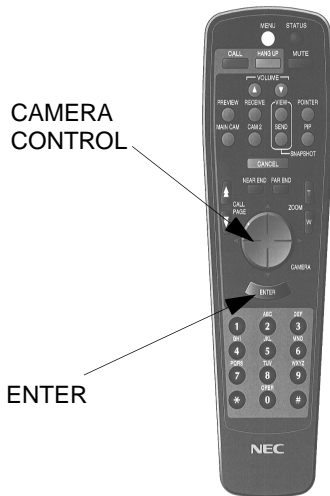

Registering NEAR END camera preset

- ▶ 1. MAIN CAM: FRONT
- 2.
- 3.
- 4.
- 5.
- 6.
- 7.
- 8.
- 9.

Press ENTER after choosing.

- ⑧ Press the **CANCEL** or **MENU** button twice to return to video image.

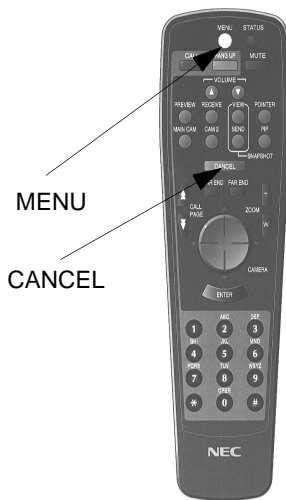

Repeat Steps ① through ⑧ for each preset camera position.

- ⑨ Repeat the Steps ① through ⑦ for the **FAR END** preset camera positions.

7.4 Audio Conditioning

Performs audio training function by generating white noise. This is to condition the room acoustically.

- ① Press the **MENU** button to display the on-screen icons.
- ② Select the **START AUDIO TRAINING** icon on the main menu using the **CAMERA CONTROL** button.

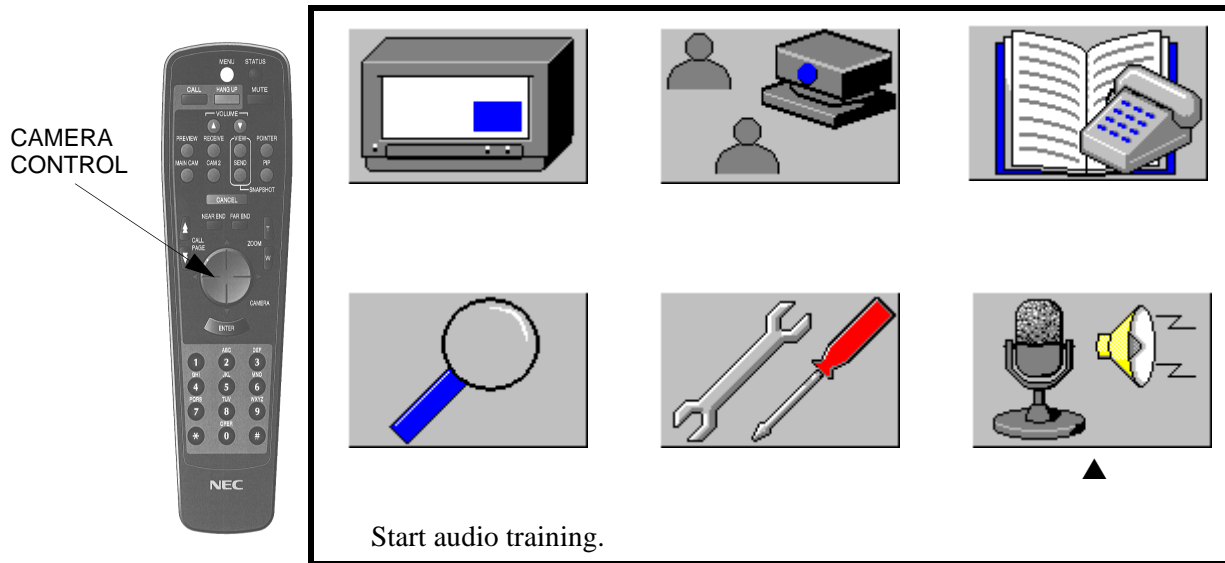

- ③ Press **ENTER** button to select **START AUDIO TRAINING**.

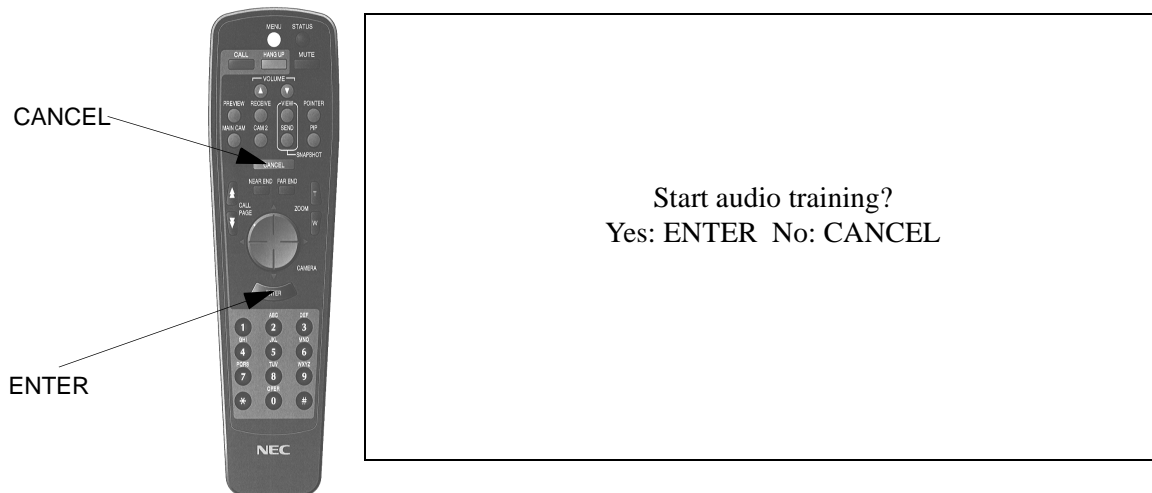

The white noise is transmitted.

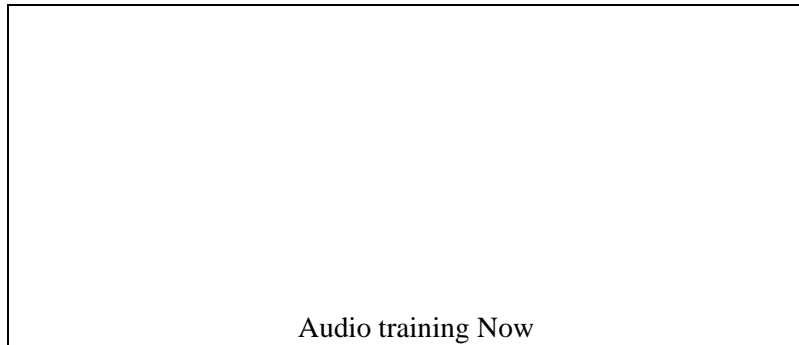

When the VisuaLink has completed its training, the white noise automatically turns off and returns to the **MAIN MENU** screen.

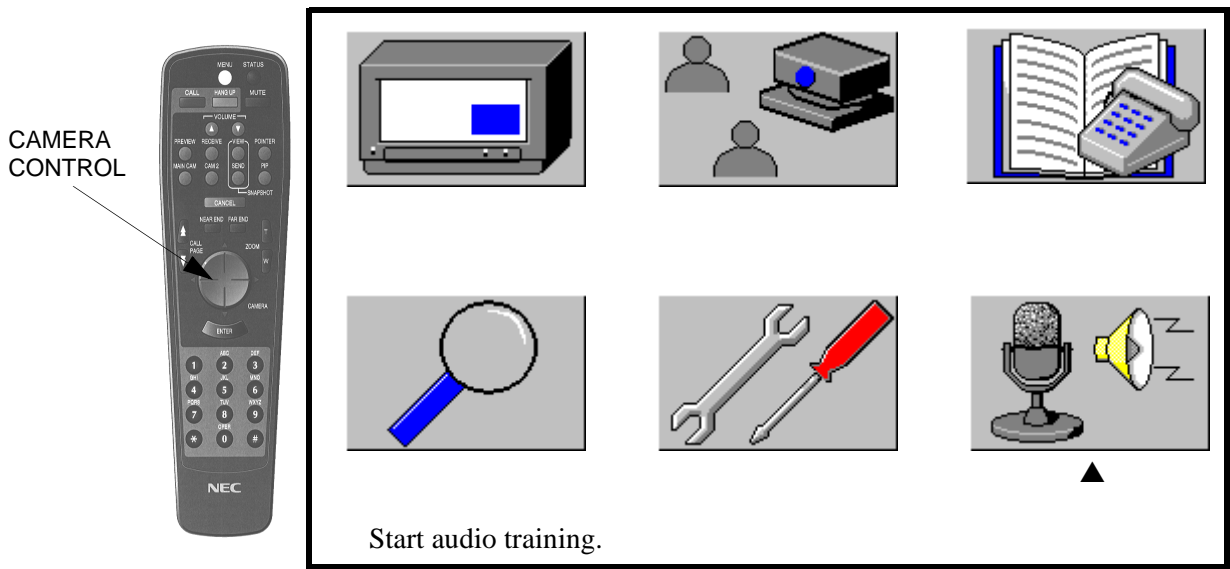

- ④ Press the **CANCEL** or **MENU** button once in order to return to the video image.

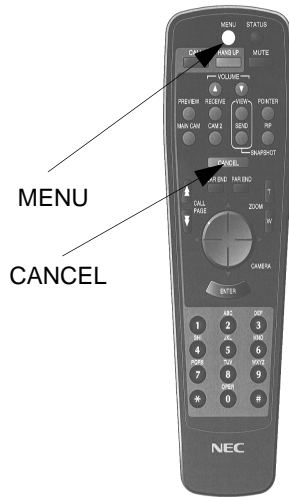

Chapter 8 Operation Method

This chapter explains how to perform basic remote control functions of the VisuaLink 128 or VisuaLink 384, such as switching monitor screens, and controlling cameras. Your system is **ON** if the light near the power display on the front of the VisuaLink unit is lit.

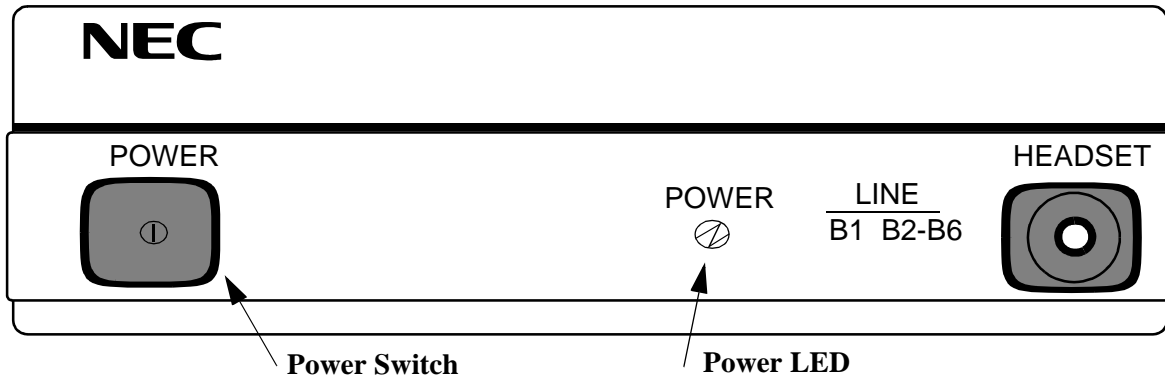

If the VisuaLink is not **ON**, press the **POWER SWITCH** on the front of the VisuaLink unit.

8.1 System Status

The **STATUS** button on the hand held remote provides information that you might want to know during your videoconference. It displays call status, which camera is currently sending the image and the time.

8.1.1 Check the system status

- ① Press **STATUS** button.

The status information appears at the top and bottom of the screen.

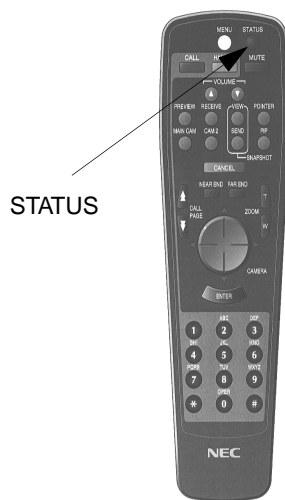

The following defines the status message:

- ① **Picture Source**
This displays the picture source (transmission/reception/still-picture) currently displayed. It displays the remote location name when displaying a received picture.
- ② **Type of camera control**
Displays the current camera control (local or remote).
- ③ **Camera display**
Displays the camera that was last selected for control (Camera 1 or Camera 2).
- ④ **Time display**
Displays the local time.

8.1.2 Remove the status information

- ① Press **STATUS** button again.

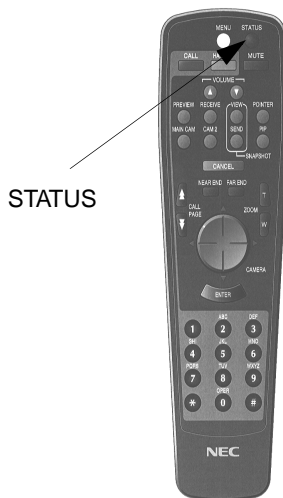

8.2 Volume Control

If the volume from the far-end is either too faint or too loud, you can adjust it with the **VOLUME** buttons on the hand held remote.

8.2.1 Increase the volume

- ① Press the **VOLUME UP** button.

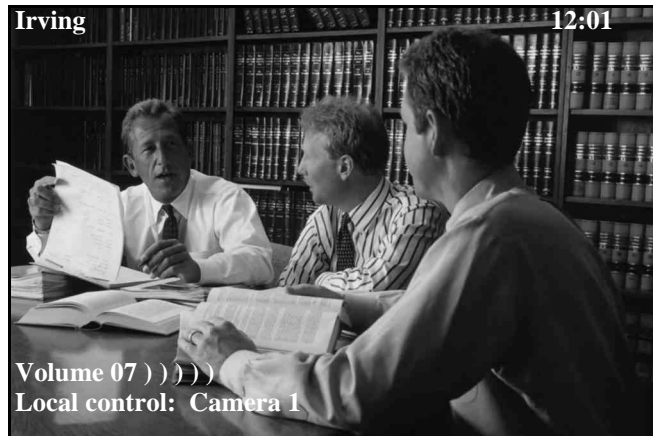
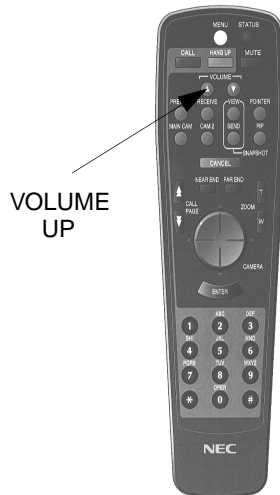

The volume bar appears on the monitor to show you the volume level. We recommend that you do not use the volume control on your monitor to adjust the volume because this may interfere with your ability to adjust the volume with the hand held remote. Also, if the volume of the monitor is too high or too low, the people at the far-end may hear echo. In general, leave the monitor volume level set to about middle position. If the far-end does hear echoes, turn the near-end monitor volume down until the echo disappears.

8.2.2 Decrease the volume

- ① Press the **VOLUME DOWN** button.

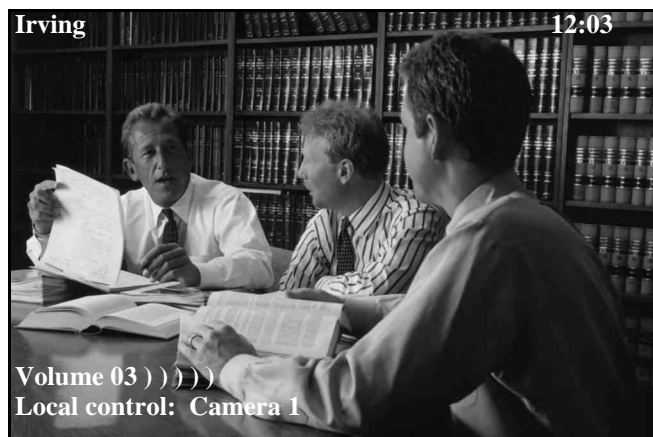
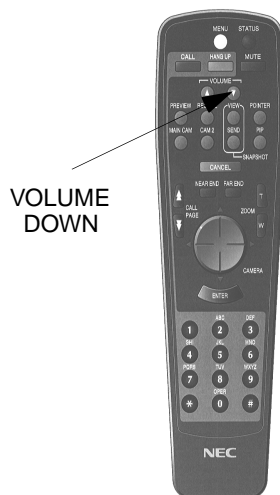

8.3 Muting Your Microphone

If you want to speak privately to someone at your site during your videoconference, you can mute your microphone.

8.3.1 Mute your microphone

- 1 Press **MUTE** button.

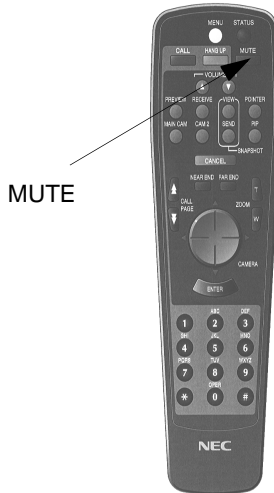

MUTE is displayed on the screen. The remote cannot hear your voice.

Note: **MUTE** is displayed when the local microphone is muted. The **MUTE** logo will blink ON/OFF.

8.3.2 Unmute your microphone

- 1 Press **MUTE** button.



MUTE message is deleted from the screen. The remote now can hear your voice.

8.4 Switching Monitor Screens

During a Video conference, you may want to see a preview of local site to transmit or a still-picture in addition to seeing pictures sent from the remote. Use the Monitor Switching Feature. The user is able to switch the picture at the local site.

8.4.1 Preview the Local image

Previewing simply means looking at the image from your main camera or your document camera so that you can make any adjustments before the videoconference starts. For example, you may want to zoom the main camera in or out or point it at a different location.

- ① Choose the camera, using the **MAIN CAM** or **CAM 2** button.
- ② Press the **PREVIEW** button.

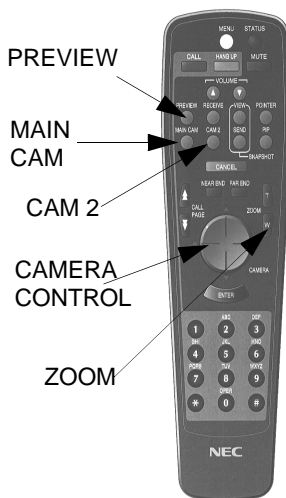

- ③ If you want to adjust the image, use the **CAMERA CONTROL** and/or **ZOOM** buttons to adjust the camera positions.

8.4.2 Display a received picture

- 1 Press the **RECEIVE** button.

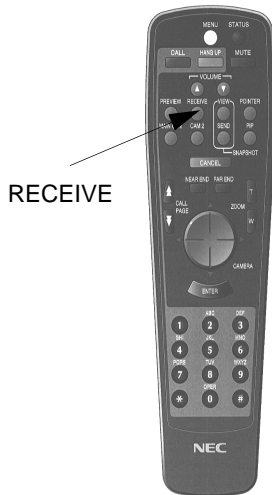

8.4.3 Recall a snapshot

Recall a snapshot simply means looking at the last snapshot that you sent or receive.

- 1 Press the **VIEW** button.

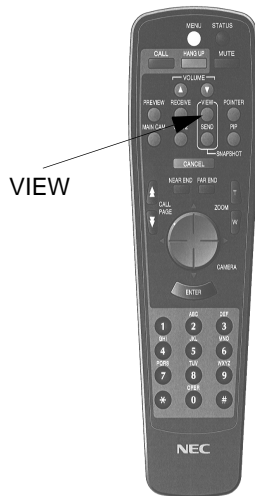

The snapshot appears on your screen again, but the people at far-end do not see it unless they recall it themselves.

8.5 Switching Camera Pictures

With your system, you can send video to the far-end from your **MAIN CAM** or **CAM 2**.

8.5.1 Local switching

Switching the video image sent to the remote site.

- ① Press the **MAIN CAM** button.



A picture of Camera 1 is sent to the remote.

Note: Image as seen by the remote-end.

8.5.2 Transmit Camera 2 picture

- ① Press **CAM 2** button.



A picture from Camera 2 is sent to the remote.

Note: Image as seen by the remote-end.

8.5.3 Remote switching

To switch the transmitted picture sent from the remote site:

- ① Press the **FAR END** button.



The system switches control from local to remote control. This is indicated by the local message.

Note: Image as seen by the local site.

- ② Press the **MAIN CAM** or **CAM 2** button.
The far site sends the camera selected.
- ③ When **CAM 2** button is pressed:

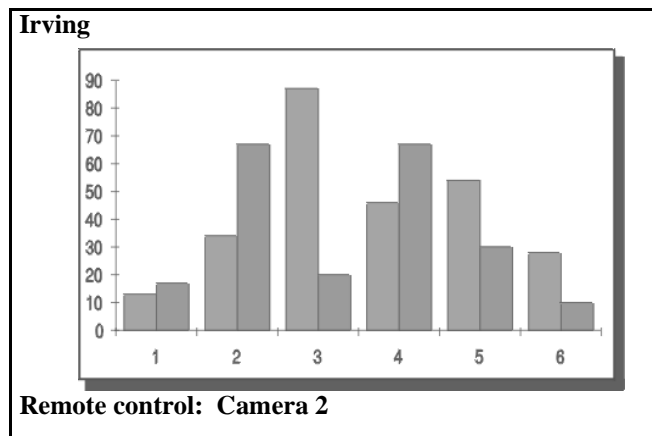
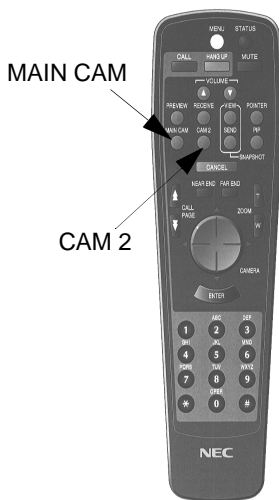

Note: Image as seen by the local site.

8.5.4 Switch back to local control

- 1 Press the **NEAR END** button.

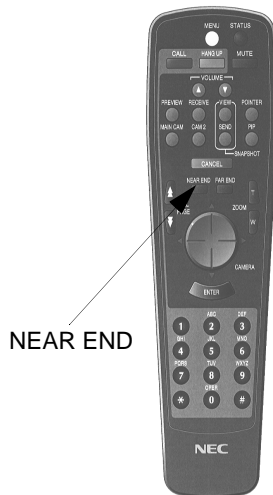

A control switches back to the local.

Note: Image as seen by the local site.

8.6 PIP Functions

The little window that appears on your screen is called the Picture-in-Picture (PIP) window. You can make this window appear or disappear anytime.

8.6.1 Display the PIP

- 1 Press the **PIP** button.

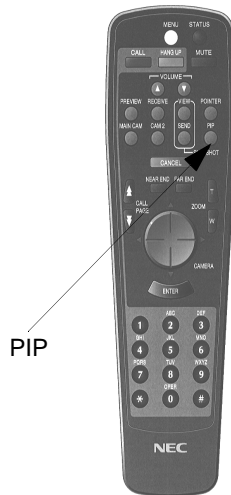

PIP is displayed.

Note 1: PIP displays the transmitting image. The image shown on the monitor could be a mirror or non-mirror image. This depends on the PIP menu setting.

Note 2: Please refer to [Section 7.2 Picture-in-Picture Menu](#) to change the PIP display position.

8.6.2 Delete the PIP

- 1 Press the **PIP** button.



The PIP that was on your screen disappears.

8.7 Send a Snapshot

During a meeting, you may want to distribute copies of a diagram or pass around an illustration so that everyone can take a closer look at what you are discussing. You can do the same in a videoconference by sending a snapshot. A snapshot is a picture like an electric photograph that you can send to the far-end.

8.7.1 Send a snapshot

- 1 Press either the **MAIN CAM** or **CAM 2** button to view the image from the camera.

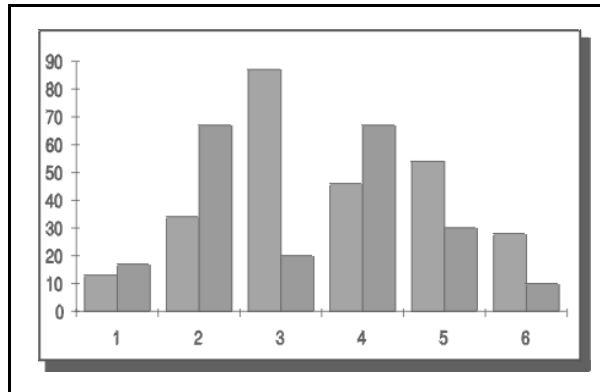
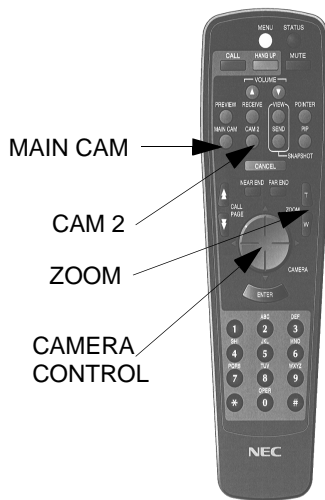

- 2 Adjust the image using the **CAMERA CONTROL** and/or **ZOOM** button; keep doing this until the camera is showing the image exactly the way you want it.
- 3 Press **SEND** button in the **SNAPSHOT** area. The snapshot appears on the far-end screen and on your screen and whatever you were viewing at the far-end appears in your PIP. Whenever a snapshot appears, you also see the message **STILL** at the upper left corner of the screen. This is your indication that a **STILL** is being shown in the monitor.

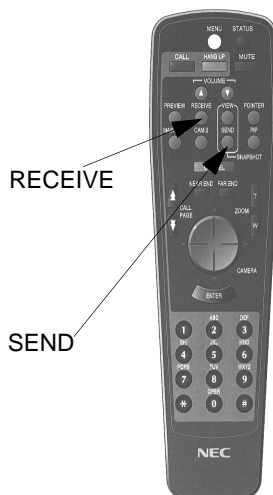

8.7.2 Switch back to the far-site viewing

- ① Press the **RECEIVE** button.

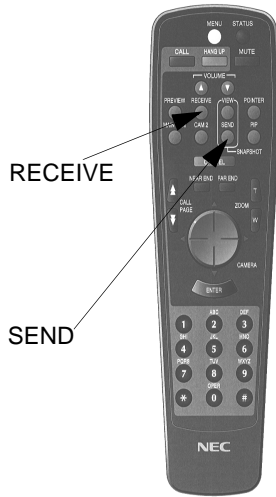

8.7.3 Receive a snap shot picture

When a snap shot picture is received, the on-screen video freezes for a second and the video images automatically change to the snap shot picture.

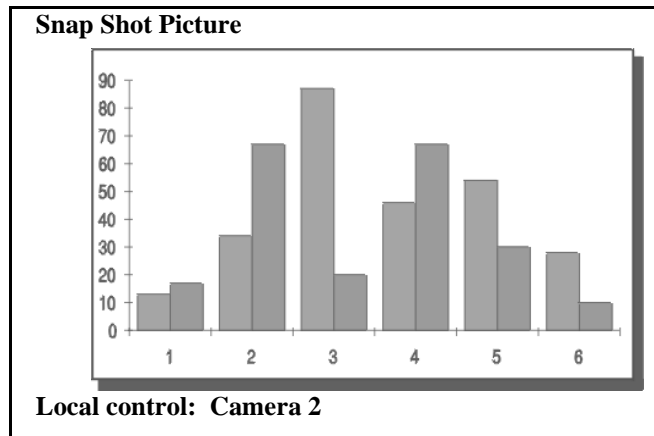

8.8 Camera Functions

During a videoconference, you might want to adjust your **MAIN CAM** or **CAM 2** to zoom in or out on a person or persons to display something else in the picture.

8.8.1 Local Control

To move your **MAIN** camera.

- ① Select the **MAIN CAM** button.
- ② Press the **ZOOM** and/or **CAMERA CONTROL** button.
Keep adjusting these buttons until the camera displays the correct image.

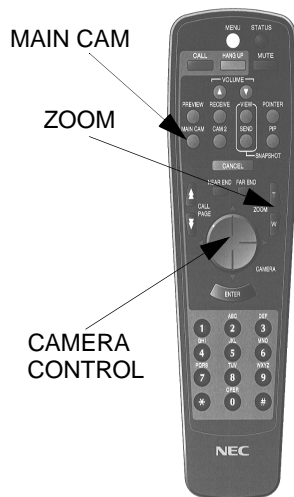

8.8.2 Adjust the CAM 2

- ① Select the CAM 2 button.

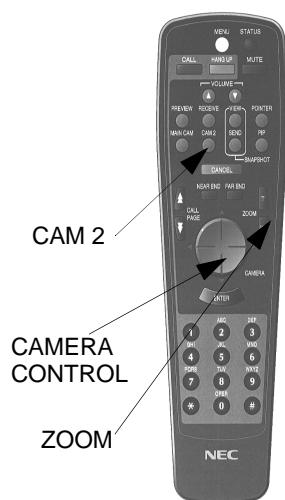

- ② Press the **ZOOM** and/or **CAMERA CONTROL** button.
Keep adjusting these buttons until the camera displays the correct image.

8.8.3 Far-End Control

Adjust far-end camera:

During a videoconference, you may want to move a far-end camera if, for example, you cannot see the person who is speaking or if you want to zoom out to see everyone in the room.

- 1 Press the **FAR END** button.



The control switches to the remote control.

- 2 Select the camera that you would like to control.

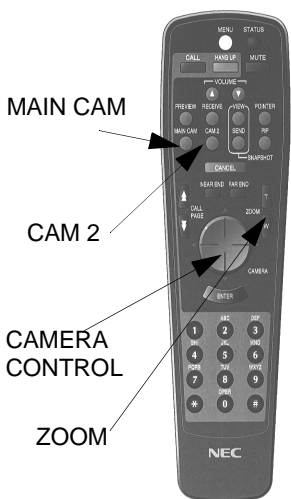

- 3 Adjust the image using the **ZOOM** and/or **CAMERA CONTROL** button. Keep adjusting these buttons until the camera displays the correct image.

8.9 Using Camera Preset

Once you have set your camera presets, you simply press one of the number buttons on the hand held remote. The camera then, moves to the preset position and the people at the far-end see that view.

8.9.1 Activate a stored camera preset

- ① Press **NUMBER** button (1 to 9).

Note 1: The camera moves to a stored position, and the speaker's name is displayed. The speaker's name is displayed not only at the local room but also on the monitor at the remote location.

Note 2: Menu cannot be displayed while the preset is activated.

The display is deleted after a period of time.



8.10 Pointer Display

Pointer is used to highlight an area on the video monitor. The pointer can be displayed on documents, diagrams and motion video. The pointer is controlled on a first come, first served bases. Control can only be surrendered when the pointer button is released.

8.10.1 Display the pointer

- ① Press **POINTER** button.

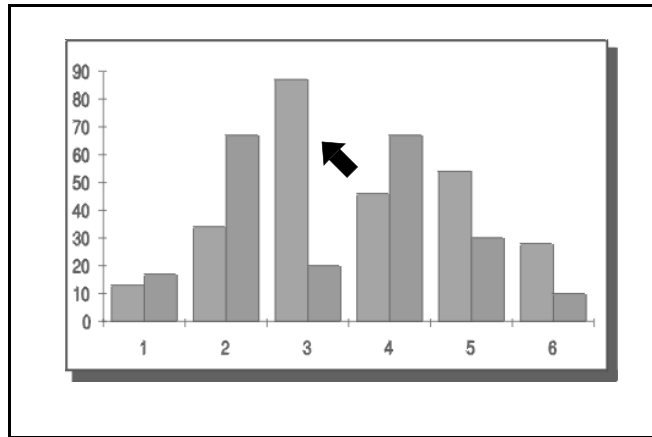
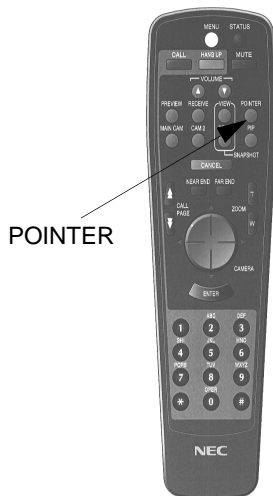

Note: A pointer is displayed on the monitor at the local and remote location.

8.10.2 Move the pointer

- ① Press **CAMERA CONTROL** button.

↖: operating side ↗: receiving side

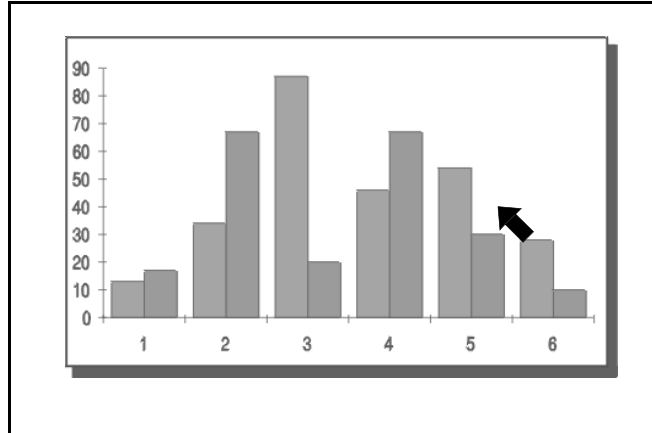

The pointer moves to the direction pressed on the button.

Note 1: The pointer on the monitor at the remote location also moves.

Note 2: A camera cannot be controlled during a pointer display.

8.10.3 Delete the pointer

- ① Press **POINTER** button.

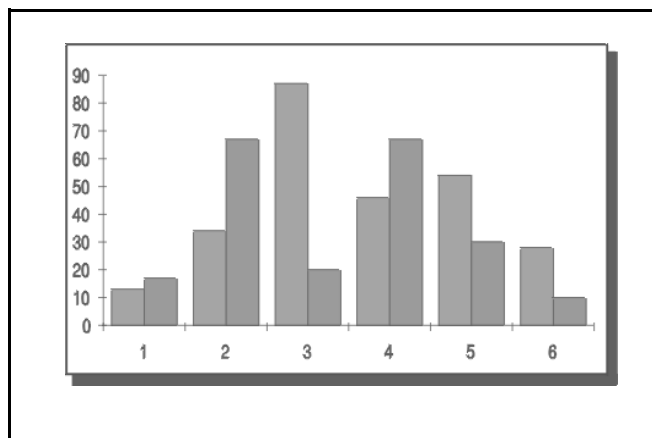
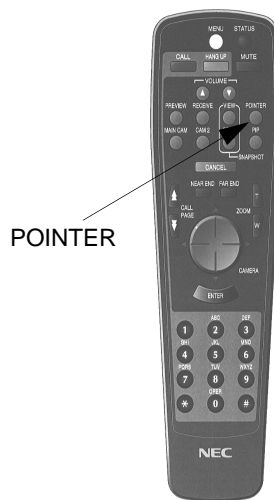

The Pointer has disappeared from the local and remote monitors.

Chapter 9 VisuaLink Troubleshooting Guide

The following table lists many common problems and likely causes and solutions.

Table 9-1: Troubleshooting Guide

Area	Condition	Check Item and Countermeasures
System Control	VL does not power on	<p>[If the power lamp does not light]</p> <ul style="list-style-type: none"> Is the power cable of VisuaLink plugged into an AC outlet? Make sure the outlet has power and not controlled by a switch.
	Remote controller does not operate	<ul style="list-style-type: none"> Replace the battery in the remote controller. Point the remote controller toward the remote controller optical receiver located on the front panel of the VL. Please place the main unit so that the optical emitted from the remote controller hits the optical receiver. <p>Note: Both batteries should be replaced at the same time.</p>
Video	No picture is displayed on the TV monitor	<p>[The power lamp is on, but the monitor shows no picture]</p> <ul style="list-style-type: none"> Check the power switch on the monitor. Is the monitor set for the correct display input? Re-check the cable between the monitor and VisuaLink. There should be a cable from the VideoOut 1 of the VL to the VideoIn 1 of the monitor. <p>[The remote picture can not be displayed]</p> <ul style="list-style-type: none"> Is the remote enabled to view the image in the PIP? Press RECEIVE key on the remote control. Is the local end connected to the remote site? <p>[The local picture is not displayed at the remote monitor] Change the monitor picture to view the transmitting picture.</p> <ol style="list-style-type: none"> Is the camera powered on? Is the camera cable correctly? Is the correct camera image being sent.? While viewing the remote room can the PIP be displayed? Is there a connection to the remote site? <p>Press MAIN CAM key and CAM 2 key.</p>
	Camera does not move	<p>[The local camera does not move]</p> <ul style="list-style-type: none"> Is the control set for local control? Press the STATUS button on the remote controller to identify what type of control has been acquired. Is the camera control cable connected? Is the camera powered ON. The camera must be powered ON when the system is turned ON. <p>[The remote camera does not move]</p> <ul style="list-style-type: none"> Is the local end connected to the remote end? Is the control set for remote control? Display indicates what type of control is acquired.

Area	Condition	Check Item and Countermeasures
Video	Picture is slow	[One channel has connected] <ul style="list-style-type: none"> ● Look at front panel and verify that both B1 and B1-B6 LEDs are lit. ● Video quality is set to Resolution handling ● Change the video quality to motion handling. This will increase the frame rate and allow more of the bandwidth to be dedicated towards the video motion
	Picture is too Blocky	[One channel has connected] <ul style="list-style-type: none"> ● Look at front panel and verify that both B1 and B1-B6 LEDs are lit. ● Video quality is set to Resolution handling ● Change the video quality to motion handling. This will increase the frame rate and allow more of the bandwidth to be dedicated towards the video motion
	Local camera does not pan/tilt	[Camera control cable is not connected] <ul style="list-style-type: none"> ● Verify the camera control cable is connected from the SERIAL output of the VisuaLink to the VISC IN of the camera. ● Camera is not a suggested manufacture. ● VisuaLink is able to control two types of cameras the VCC1 and EVI-D30.
	Far-end camera does not pan/tilt	[Camera control cable is not connected] <ul style="list-style-type: none"> ● Verify the camera control cable is connected from the SERIAL output of the VisuaLink to the VISC IN of the camera. ● Camera is not a suggested manufacture. ● VisuaLink is able to control two types of cameras the VCC1 and EVI-D30.
Audio	Audio can not be heard	<ul style="list-style-type: none"> ● Check the audio cable and volume setting.
	Transmitting audio is very low at remote end	<ul style="list-style-type: none"> ● Speaker is to far away from the microphone? ● Is the microphone cable connected? ● Increase the microphone gain setting. ● Increase the volume setting at the remote end.
	Audio from the remote end is low	[Volume setting is set to low] <ul style="list-style-type: none"> ● Using the remote controller increase the volume by selecting the volume up button ● The microphone gain level at the remote end is to low ● Increase the gain level for the microphone in the Audio setting section
	Have increased the volume and microphone gain but the audio is still low	[Check the Monitor volume knob] <ul style="list-style-type: none"> ● The monitor volume should be about half way.
	I hear an Echo	[Check the microphone to speaker distance] <ul style="list-style-type: none"> ● The microphone should be at least 6 feet (2 meters) away from the speaker. Note: Echo is always caused by the Far-end.

Area	Condition	Check Item and Countermeasures
Network	Unable to connect to a remote site	<p>[When placing a call, the line immediately hangs up]</p> <ul style="list-style-type: none"> ● Make sure the network is connected.? ● The line could be busy. Please try later. ● Verify the line conditioning setting match that for the VL. <p>[Line disconnects a few seconds/minutes after placing a call]</p> <ul style="list-style-type: none"> ● The line could be busy. Please try later. ● Remote equipment could be turned OFF. ● Verify the number called. <p>[The line is disconnects during communication]</p> <ul style="list-style-type: none"> ● Failure could have occurred on the line, which has caused the line to disconnect. Please try connecting again. <p>[Voice and picture are not received after connecting]</p> <ul style="list-style-type: none"> ● A line failure has occurred. Please disconnect and replace the call. ● A communication protocol failure with the remote address has occurred. Please disconnect, power OFF and ON the equipment to clear the status. Please try connecting again after the status has cleared. <p>[There are random errors with the voice and picture]</p> <ul style="list-style-type: none"> ● If a line error or a equipment failure occurs during communication, noise in audio and/or error in picture may occur. Please disconnect once and reconnect.
	If after everytime you try to dial a call, the system immediately ask you to redial	<p>[ISDN is not present]</p> <ul style="list-style-type: none"> ● Check the ISDN line connection. The VisuaLink has a S/T interface and requires an NT12 to be connected between the VisuaLink and your ISDN line unless the VisuaLink is connected to a PBX. ● Make sure the ISDN cable to the system is securely attached. ● SPID and/or ISDN number entered incorrect ● Check the Local Line setting ● Run a Local Line loopback from the maintenance settings.
	If you can make calls to some sites but not others.	<p>[ISDN provisioning]</p> <ul style="list-style-type: none"> ● Need to confirm ISDN provision from the Teleco.

This page is for your notes.

Appendix A Audio/Data/Video Bit Rate Assignment Table

64kbps (1B)

Selection of Audio Coding Method			G.711 m-LAW PCM	G.722 SB-ADPCM	G.728 LD-CELP	No Audio
Audio Communication Speed (kb/s)			56.0	48.0	16.0	0.0
Video Communication Speed	MLP 4kbps	LSD off	0.0	10.4	42.4	54.4
		LSD 1.2 kbps	0.0	9.2	41.2	57.2
		LSD 9.6 kbps	x	0.0	32.8	48.8
	MLP 6.4 kbps	LSD off	0.0	8.0	40.0	56.0
		LSD 1.2 kbps	x	x	x	x
		LSD 9.6 kbps	x	x	x	x

±128kbps (2B ~ 6B)

Selection of Audio Coding Method			G.711 m-LAW PCM	G.722 SB-ADPCM	G.728 LD-CELP	No Audio
Audio Communication Speed (kb/s)			56.0	48.0	16.0	0.0
Video Communication Speed	MLP 4kbps	LSD off	64.8	72.8	104.8	120.8
		LSD 1.2 kbps	63.6	71.6	103.6	119.6
		LSD 9.6 kbps	x	63.2	95.2	111.2
	MLP 6.4 kbps	LSD off	62.4	470.4	102.4	118.4
		LSD 1.2 kbps	x	x	x	x
		LSD 9.6 kbps	x	x	x	x

Note: x: Setting impossible

0.0: Setting is possible but video transmission is not possible.

This page is for your notes.

Appendix B Software Upgrade Instructions

This appendix contains instructions for upgrading your VisuaLink 128 system software. If you have any question about the upgrade, please call your videoconferencing provider.

Upgrade Instructions

To upgrade your system, all you need to do is dial into a software upgrade server from your system. The server will recognize your system and upgrade your system automatically. When the upgrade is complete, you restart your system and do an environmental initialization.

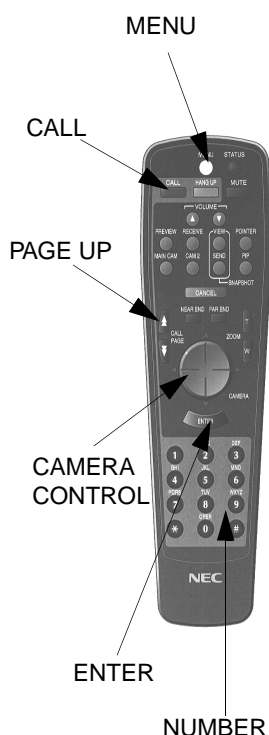

Upgrade to the latest version

1. Press **CALL** button on the wireless remote controller.
2. Select the menu item: **PLACE MANUAL DIAL CALL**.
3. Enter the Software upgrade server phone #.
 - Phone number 1: 972-719-5862
 - Phone number 2: 972-719-5863

Note: Depending on your network, you may have to enter a prefix before the number.

4. Select a speed of <128kb/s>
 - When the call connects, Call connected appears, and the update begins automatically. When the upgrade is complete, the system asks you to restart the system.
5. Press **CALL**

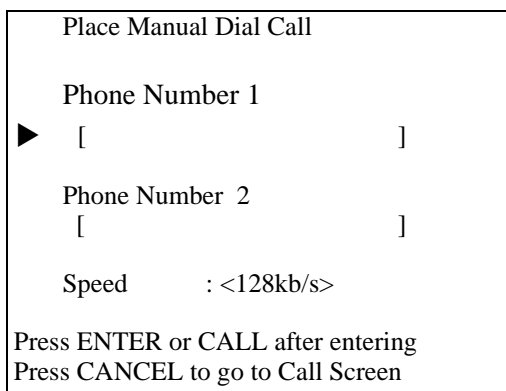

- When the call connects, Call connected appears, and the update begins automatically. When the upgrade is complete, the system asks you to restart the system
6. When the upgrade is complete, restart your system and environmental initialize.

Note: The speed setting in the CODEC should be set to 128 no matter which system is being upgraded.

Environmental Initialize



1. Press the **MENU** button on the Wireless remote controller.
2. Using the wireless remote controller select the On-Screen ICON labeled **SETTING ENVIRONMENTS**.
3. Press the **ENTER** button.
4. Enter the **PASSWORD** and then press the **ENTER** button on the wireless controller.
5. Using the wireless remote controller select the On-Screen ICON labeled **MAINTENANCE**.
6. Press the **ENTER** button.
7. Locate the **PAGE UP** button on the wireless remote controller. Press the button once.
8. Using the wireless remote controller select the Environmental Initialize.
9. When the environmental initialize is complete, the system asks you to restart the system.
10. Restart the system.

VisuaLink Software Revision History

The VisuaLink Software Revision History is located at the following Web site:

<http://www.cng.nec.com/html/products.htm>



1. Click on the NTAC icon  or select SUPPORT from the menu bar at the top of the screen.
2. At the CNG SUPPORT screen, click on the [NTAC Online](#) text.
3. At the National Technical Assistance Center screen, click on the **Knowledge Base** icon  or the **Knowledge Base** text on the menu bar.
4. At the **Knowledge Base** screen, Click on the [here](#) that is highlighted in blue on the line "For Frequently Asked Questions (FAQs), click [here](#)".
5. Click on the [VisuaLink Software Revision History](#) text that is in blue. This will take you to the revision history.

Note: If you have a problem with this procedure, please call the NTAC support line at 1-800-852-4632.

F/W download On Screen Display (OSD)

Connection to the version up center.

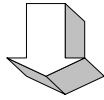

The system shouldn't be powered down when the initialize screen starts. Otherwise boot up program will be erased.

Maintenance being performed from the Center.

Please wait

Start to download program.

In case of same version.

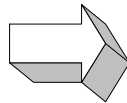

Maintenance being performed from the Center.

Please wait

Your version is the same as the Center.

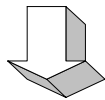

The system shouldn't be powered down when the initialize screen starts. Otherwise boot up program will be erased.

Maintenance being performed from the Center.

Please wait

Start to download program

Download in progress

--	--	--	--	--	--	--	--	--	--

100/999

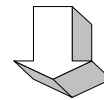

Disconnected the line.

TIME : 00H 00M 00S

016 Normal clearing

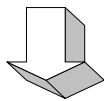

The system shouldn't be powered down when the initialize screen starts. Otherwise boot up program will be erased.

Maintenance being performed from the Center.

Please wait

Acquired program from the Center.

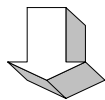

The system shouldn't be powered down when the initialize screen starts. Otherwise boot up program will be erased.

Program is being upgraded

Please wait

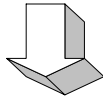

The system shouldn't be powered down when the initialize screen starts. Otherwise boot up program will be erased.

Program is being upgraded.

Please wait

--	--	--	--	--	--	--	--	--	--

Initializing now

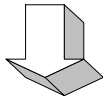

The system shouldn't be powered down when the initialize screen starts. Otherwise boot up program will be erased.

Writing Program to memory

Please wait

--	--	--	--	--	--	--	--	--	--

Writing now

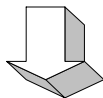

The system shouldn't be powered down when the initialize screen starts. Otherwise boot up program will be erased.

Verifying Program

Please wait

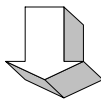
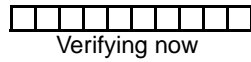

Upgrade is complete.

Please power the system off and back on.

This page is for your notes.

Appendix C CALL Menu Structure

When the **CALL** button is pressed the following screen is shown.

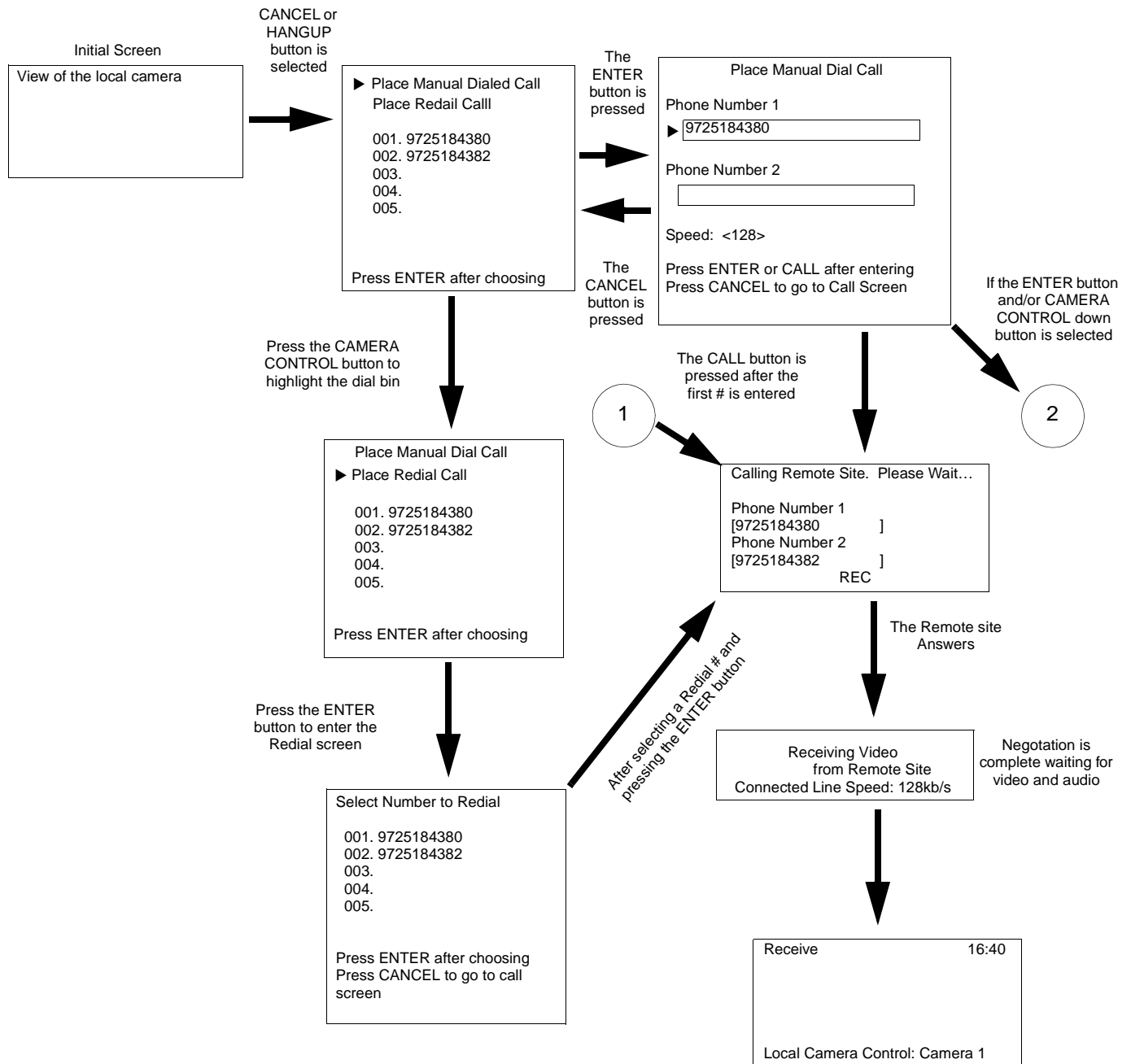

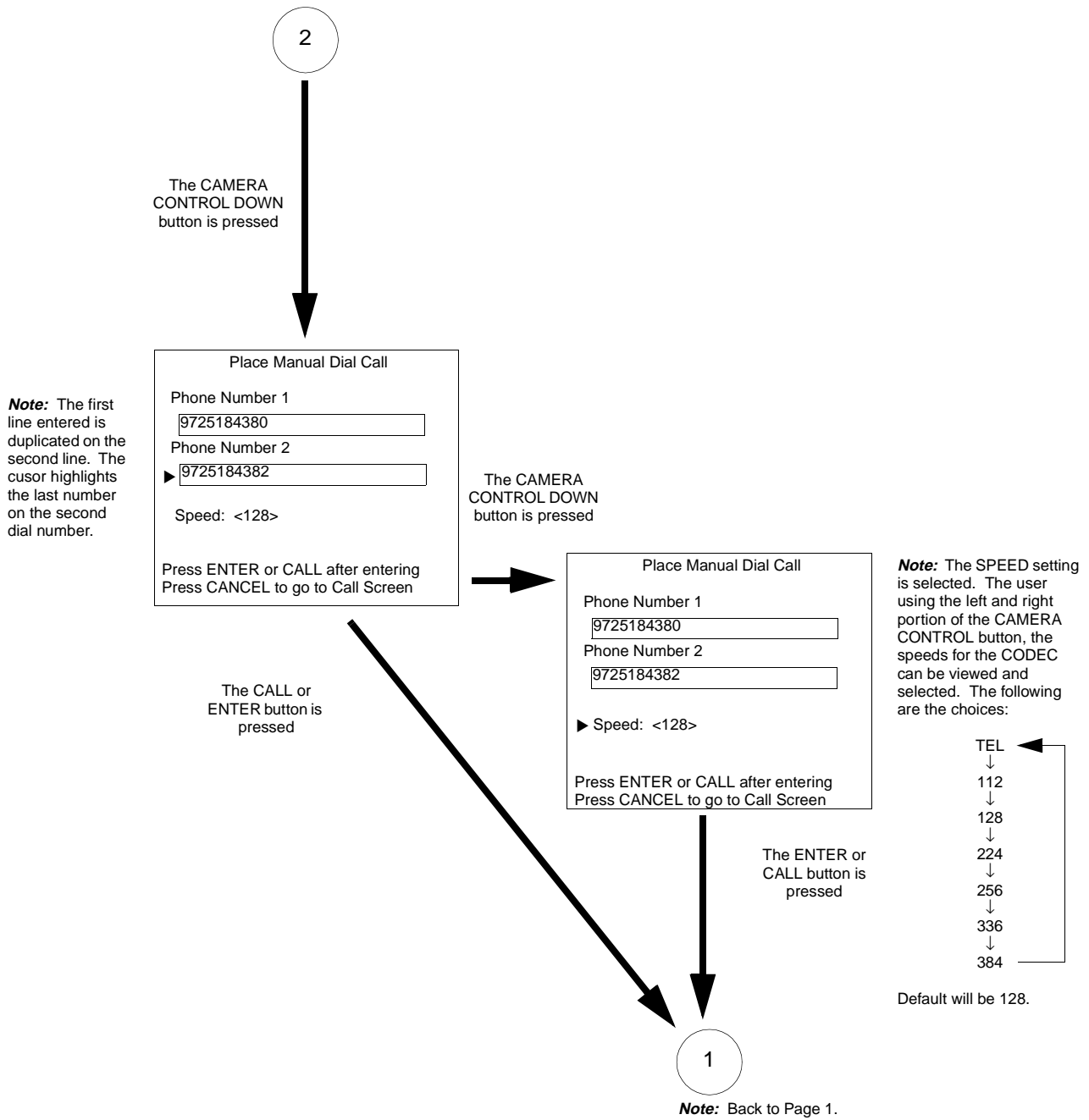

Appendix D How to Order ISDN BRI

This appendix contains the minimum ISDN BRI specification that the VisuaLink can operate. If you should have any question about the ISDN ordering procedure, please call your videoconferencing provider.

The ISDN configuration can be a complicated process. Things to remember when ordering your ISDN.

- The VisuaLink only uses one type of ISDN, BRI.
- The How to configure the ISDN BRI form provides most of the information you need to configure your system for ISDN service

How to Configure the ISDN BRI

The key to making configuration as easy as possible is getting the right information from your network service provider. In addition to providing your network service provider with the correct your specification. When ordering your ISDN NEC recommends that you go through the following ISDN ordering procedure to assure accurate information from your network service provider has been received and provided.

1. The videoconferencing user fills out the following. The user then forwards this information and the Network provider information to the Network provider.

Name:

Title:

Company:

Street:

City:

Phone:

Fax:

State/Province:

Zip:

Network Provider

The Site location where the ISDN BRI service will be installed:

Note: You will need to plug your videoconferencing system into a device called an NT1 before you plug the system into your ISDN BRI wall jack. This assumes that the ISDN BRI service will be coming directly from the Telco and not an in-house switch (such as NEAX2400 or 2000). You must identify who will be providing the NT1.

2. The network provider provisions the correct ISDN BRI and completes the following list of questions.

ISDN BRI Service Specification needed:

As defined by Bellcore; the ISDN BRI simplified ordering code is EZ-ISDN1.

- The ISDN BRI protocol National ISDN-1
 - The ISDN BRI service must be terrified and available from the customer's local central office.
 - The D channel should not permit X.25 packet data
 - The ISDN BRI service must allow videoconferencing calls to be dialed on either B channel or on both simultaneously
 - Both B channels must carry circuit-switched Videoconferencing data
 - The ISDN BRI Line requires one or two different SPID number.
 - The ISDN BRI service must be configured as a Terminal Type A
 - The ISDN BRI service must be automatic Terminal Endpoint Identifiers (TEIs)
- A. User requires an (NT1) to use the ISDN BRI service () Yes () No
- B. If Yes, the ISDN BRI network provider can () or cannot () supply it.
- C. If the ISDN BRI network provider cannot supply the needed NT1, and then who is recommended supply.
 Name;
 Company:
 Phone #:
- D. Did the ISDN BRI service pass a loop qualification test at the user site listed
 Yes () No ()

Note: The ISDN BRI must pass a loop test at the user site before installation begins.

- E. Check one of the following.
- () The users ISDN BRI line doesn't require a Service Profile Identifier (SPID) number for installation.
 - () The user's ISDN BRI line requires one SPID number and one director number (also called) Sub-Address for installation

SPID #	Sub Address #
---------------	----------------------
 - () The user's ISDN BRI line requires two SPID number and two directory numbers for installation

SPID 1 #	Sub Address 1 #
SPID 2 #	Sub Address 2#

Free Manuals Download Website

<http://myh66.com>

<http://usermanuals.us>

<http://www.somanuals.com>

<http://www.4manuals.cc>

<http://www.manual-lib.com>

<http://www.404manual.com>

<http://www.luxmanual.com>

<http://aubethermostatmanual.com>

Golf course search by state

<http://golfingnear.com>

Email search by domain

<http://emailbydomain.com>

Auto manuals search

<http://auto.somanuals.com>

TV manuals search

<http://tv.somanuals.com>