

Best Value to Meet Basic Computing Needs

POWERMATE® VT 300I SERIES



**S E R V I C E A N D R E F E R E N C E
M A N U A L**

NEC

Proprietary Notice and Liability Disclaimer

The information disclosed in this document, including all designs and related materials, is the valuable property of NEC Computer Systems Division, Packard Bell NEC, Inc. (hereinafter "NEC CSD") and/or its licensors. NEC CSD and/or its licensors, as appropriate, reserve all patent, copyright and other proprietary rights to this document, including all design, manufacturing, reproduction, use, and sales rights thereto, except to the extent said rights are expressly granted to others.

The NEC CSD product(s) discussed in this document are warranted in accordance with the terms of the Warranty Statement accompanying each product. However, actual performance of each such product is dependent upon factors such as system configuration, customer data, and operator control. Since implementation by customers of each product may vary, the suitability of specific product configurations and applications must be determined by the customer and is not warranted by NEC CSD.

To allow for design and specification improvements, the information in this document is subject to change at any time, without notice. Reproduction of this document or portions thereof without prior written approval of NEC CSD is prohibited.

As an ENERGY star partner, NEC Computer Systems Division (NEC CSD) has determined that this product meets the ENERGY star guidelines for energy efficiency.

NEC and PowerMate are registered trademarks of NEC Corporation, used under license.

ENERGY STAR is a U.S. registered trademark.

All other product, brand, or trade names used in this publication are the trademarks or registered trademarks of their respective trademark owners.

First Printing — May 1999

Copyright 1999
NEC Computer Systems Division
Packard Bell NEC, Inc.
1 Packard Bell Way
Sacramento, CA 95828-0903
All Rights Reserved

Contents

Preface	xi
Abbreviations	xiii
1 System Overview	
Configurations	1-2
Features	1-4
Front Features	1-4
Rear Features	1-5
Inside Features	1-7
Security Features	1-8
Components	1-9
System Board	1-9
Diskette Drive	1-10
Hard Drive	1-10
Power Supply	1-10
Keyboard	1-10
Mouse	1-11
AGP Board	1-11
CD-ROM Drive	1-11
Speakers	1-11
Fax/Modem Board	1-12
Network Board	1-12
PC Adapter Device	1-12
Tape Backup Unit	1-12
Zip Drive	1-13
2 System Configuration	
Interrupt Requests	2-2
System Interrupts	2-2
Parallel Port Interrupts	2-3
Serial Port Interrupts	2-4
Jumper Settings	2-4
System Board Jumper Settings	2-5
Maxtor IDE Hard Drive Jumper Settings	2-7
Seagate IDE Hard Drive Jumper Settings	2-7
NEC 32X CD-ROM Drive Jumper Settings	2-7
Lite-On 32X CD-ROM Drive Jumper Settings	2-8
Zip Drive Jumper Settings	2-8
Tape Backup Unit Jumper Settings	2-8
BIOS Setup Utility	2-9
How to Start BIOS Setup	2-9
How to Use BIOS Setup	2-10
Main Menu	2-10
Advanced Menu	2-13
Security Menu	2-17
Exit Menu	2-18
FLASH Utility	2-18
NEC OS Restore CD	2-19

Introducing OS Restore Options	2-19
Choosing a Restore Program	2-19
Launching the NEC OS Restore CD	2-20
Auto Rebuild and Restore.....	2-21
Custom Rebuild and Restore	2-22
Fixing the Operating System	2-24
NEC Application and Driver CD.....	2-25
Launching the Application and Driver CD.....	2-26
Installing Software	2-26
NEC Help Center	2-27
Installing the NEC Help Center	2-27
Uninstalling the NEC Help Center.....	2-27
Resolutions for NEC VistaScan USB Monitors.....	2-28
Cheyenne Backup.....	2-28
Intel Processor Serial Number Control Utility.....	2-29
System Requirements	2-29
Installation	2-29
Processor Serial Number	2-30
FAQs	2-30
Technical Support	2-31

3 Disassembly and Reassembly

System Unit Cover Removal	3-3
Removing the Left Side Cover.....	3-3
Replacing the Left Side Cover	3-4
Removing the Right Side Cover	3-6
Replacing the Right Side Cover.....	3-7
Expansion Board Removal	3-8
AGP Board Removal.....	3-9
Front Panel Removal.....	3-9
Blank Panel and Metal Shield Removal	3-10
DIMM Module Removal	3-11
Processor Cartridge Removal/Replacing.....	3-11
Removing the Celeron or Pentium III Processor Cartridge	3-12
Installing the Celeron or Pentium III Processor Cartridge.....	3-13
Removing the Pentium II Processor Cartridge.....	3-15
Installing the Pentium II Processor Cartridge.....	3-16
5 1/4-Inch Device Removal	3-18
3 1/2-Inch Hard Drive Removal.....	3-19
3 1/2-Inch Diskette Drive Removal.....	3-20
Power Supply Removal	3-21
System Board Removal	3-22
CMOS Battery Removal.....	3-23

4 System Board

Connectors, Jumpers, and Sockets	4-2
External Cable Connectors	4-2
Internal Connectors and Sockets	4-3
System Board Jumpers	4-3
Changing Processor Speed.....	4-4
Setting the Power On Mode	4-5
Clearing the CMOS and Password	4-6

Setting Wake-On LAN.....	4-7
Upgrade Sockets	4-8
Processor Socket.....	4-8
DIMM Sockets	4-8
Checking System Memory	4-9
Components	4-10
Processor and Secondary Cache.....	4-12
System BIOS.....	4-12
System Memory	4-13
Plug and Play	4-13
ISA Bus	4-13
PCI Local Bus.....	4-13
PCI/IDE Ports	4-14
Parallel Interface	4-14
Serial Interface.....	4-15
USB Interface.....	4-15
Graphics Capabilities	4-15
Accelerated Graphics Port.....	4-16
Graphics Controller.....	4-16
Motion Video Controller	4-16
Integrated Audio	4-17
Resources.....	4-17
Memory Map	4-18
I/O Addresses.....	4-18
DMA Settings	4-21
5 Illustrated Parts Breakdown	
Ordering Parts.....	5-2
Field Replaceable Unit List	5-3
Illustrated Parts Breakdown.....	5-5
6 Preventive Maintenance	
System Cleaning	6-2
Keyboard Cleaning.....	6-2
Mouse Cleaning	6-3
7 Troubleshooting	
Checklist.....	7-2
System Problems.....	7-2
Diskette Drive Problems.....	7-4
Monitor Problems.....	7-4
Keyboard/Mouse Problems.....	7-5
CD-ROM Drive Problems	7-5
Speaker Problems.....	7-6
Diagnostics	7-6
8 NEC CSD Information Services	
Service Telephone Numbers.....	8-2
Technical Support	8-2
NEC CSD Website.....	8-2
Email/Fax Technical Support Service.....	8-3

Technical Support Services	8-3
Product Information	8-4
NEC CSD FTP Site.....	8-4
NEC CSD Bulletin Board Service.....	8-4

9 Specifications

System Board Specifications	9-3
Keyboard Specifications.....	9-3
Mouse Specifications	9-4
Speaker Specifications.....	9-4
System Unit Specifications.....	9-5
Diskette Drive Specifications	9-5
4.3-GB Seagate Hard Drive Specifications	9-6
4.3-GB Maxtor Hard Drive Specifications	9-7
8.4-GB Fujitsu Hard Drive Specifications.....	9-8
8.4-GB Maxtor Hard Drive Specifications	9-9
12.9-GB Maxtor Hard Drive Specifications	9-10
ATX Power Supply Specifications.....	9-10
Fax/Modem Board Specifications.....	9-11
ATI Minden AGP Board Specifications.....	9-12
ATI Expert 98 AGP 8 MB Board Specifications.....	9-12
Diamond Viper V550 AGP Board Specifications.....	9-13
Lite-On 32X and 40X CD-ROM Drive Specifications	9-13
NEC 32X CD-ROM Drive Specifications.....	9-14
Hitachi 4X DVD-ROM Drive Specifications	9-15
PC Adapter Device Specifications	9-15
Tape Backup Unit Specifications.....	9-16
Zip Drive Specifications.....	9-17
Environmental and Safety Specifications	9-18
Compliance.....	9-18

A Release Notes

General Notes.....	A-2
Installing Applications and Online Documentation	A-2
Setting Boot Order in BIOS.....	A-3
Configuring the System for Microsoft Internet Explorer	A-3
Changing Network Settings.....	A-3
Installing Cheyenne Backup	A-4
Installing LapLink Application Not Supported.....	A-5
Installing PartitionMagic	A-5
Getting CD-ROM Support in Command Prompt Only Mode	A-5
Installing Internet Explorer 4.01 Add-On Components from the NEC Driver CD.....	A-6
Identifying the Pentium III Processor.....	A-6
SCSI Drive Limitations	A-6
Bootting from a CD.....	A-6
Using the NEC OS Restore CD with a SCSI Drive	A-7
LS-120 SuperDisk Copy Utility.....	A-7
NEC OS Restore CD	A-8
Using the Fix OS Restore Option.....	A-8
Fixing the Operating System	A-8
PIIX4 Limitations.....	A-9
Reconfiguring Ultra DMA Support.....	A-9

Determining IDE Device Compatibility.....	A-10
New System Board Jumper Settings	A-10
Intel Processor Serial Number Control Utility.....	A-12
Identifying System Requirements	A-12
Installing the Utility	A-12
Looking at Serial Number Features.....	A-12
Getting Answers to FAQs.....	A-13
Getting Intel Technical Support.....	A-14
Windows 95 Issues.....	A-14
Controlling CD Audio	A-14
Using Cheyenne Backup to Back Up Large Drives	A-14
Restoring Software with a US Robotics 56K V.90 Modem Installed	A-15
Clicking the Product Catalog Button.....	A-15
Windows 98 Issues.....	A-15
Ejecting the NEC Application and Driver CD from a DVD-ROM Drive.....	A-15
Finding Tape Device Icons	A-15
Finding the 3Com Diagnostic Program.....	A-15
Finding No Network Neighborhood Icon on the Desktop.....	A-16
Windows NT Issues	A-16
Restoring Network Card Drivers	A-16
Installing BootMagic in a System with Windows NT.....	A-16
Configuring BootMagic	A-16
Correcting the BootMagic Configuration	A-17

Glossary

Index

Regulatory Statements

List of Figures

PowerMate VT 300i Series System Components	1-2
PowerMate VT 300i Series System Front View	1-4
PowerMate VT 300i Series System Rear View	1-6
Inside the System	1-7
Processor/Bus Speed Jumper Block SW1 Settings	2-5
Setup Main Menu	2-9
Welcome screen	2-20
Removing the Left Side Cover	3-4
Replacing the Left Side Cover	3-5
Removing the Right Side Cover	3-6
Replacing the Right Side Cover	3-7
Removing an Expansion Board	3-8
Removing the Front Panel	3-9
Removing the Blank Panel	3-10
Removing a DIMM Module	3-11
Removing the Celeron or Pentium III Processor Cartridge	3-13
Installing the Celeron or Pentium III Processor Cartridge	3-14
Removing the Pentium II Processor Cartridge	3-16
Installing the Pentium II Processor Cartridge	3-17
Removing a 5 1/4-Inch Device	3-19
Removing the Hard Drive	3-20
Removing the Power Supply	3-21
Removing the System Board	3-22
Locating the Battery	3-23
Removing the Battery	3-24
System Board External Cable Connector Locations	4-2
System Board Internal Connector and Socket Locations	4-3
Locating System Board Jumpers	4-4
Processor Jumper Settings	4-5
PowerMate VT 300i Series Computer Illustrated Parts Breakdown	5-5
Removing the Mouse Ball Cover	6-3

List of Tables

PowerMate VT 300i Series System Configuration	1-3
System Components	1-9
Interrupt Level Assignments	2-3
Parallel Port Interrupts	2-3
Serial Port 1 and Serial Port 2 Interrupts	2-4
Power On Mode Jumper JP1 Settings	2-6
Clear CMOS Jumper JBAT1 Settings	2-6
Wake-On LAN Jumper JWOL Settings	2-6
Maxtor IDE Hard Drive Jumper Settings	2-7
Seagate IDE Hard Drive Jumper Settings	2-7
NEC 32X CD-ROM Drive Jumper Settings	2-7
Lite-On 32X CD-ROM Drive Jumper Settings	2-8
Zip Drive Jumper Settings	2-8
Tape Backup Unit Jumper Settings	2-8
Navigation Keys	2-10
Main Menu Items	2-10
Advanced Menu - Advanced CMOS Setup	2-13
Advanced Menu - Advanced Chipset Setup	2-14
Advanced Menu - Power Management Setup	2-14
Advanced Menu - PCI/Plug and Play Setup	2-16
Advanced Menu - Peripheral Setup	2-16
Advanced Menu - Change Language Setting	2-17
Security Menu Items	2-17
Exit Menu Items	2-18

Resolutions for 15 and 17 Inch NEC VistaScan USB Monitors	2-28
PowerMate VT 300i Series Disassembly Sequence	3-2
Supported DIMMs	4-9
Sample DIMM Upgrade Paths.....	4-9
System Board Components	4-11
Parallel Port Addresses.....	4-14
Serial Port 1 and Serial Port 2 I/O Addresses	4-15
System Memory Map.....	4-18
I/O Address Map	4-18
DMA Settings.....	4-21
Ordering Parts.....	5-2
PowerMate VT 300i Series System FRU List	5-3
Problems and Solutions.....	7-6
NEC CSD Service and Support Telephone Numbers	8-2
System Specifications	9-2
System Board Specifications	9-3
Keyboard Specifications	9-3
Mouse Specifications	9-4
Speaker Specification.....	9-4
System Unit Specifications.....	9-5
Diskette Drive Specifications	9-5
4.3-GB Seagate Hard Drive Specifications	9-6
4.3-GB Maxtor DiamondMax Hard Drive Specifications	9-7
8.4-GB Fujitsu Hard Drive Specifications.....	9-8
8.4-GB Maxtor DiamondMax Hard Drive Specifications.....	9-9
12.9-GB Maxtor DiamondMax Hard Drive Specifications	9-10
Power Supply Specifications	9-10
Fax/Modem Board Specifications.....	9-11
ATI Minden (Rage IIC) AGP Board Specifications	9-12
ATI Expert 98 (Rage PRO) AGP Board Specifications	9-12
Diamond Viper V550 AGP Board Specifications.....	9-13
Lite-On 32X and 40X CD-ROM Drive Specifications	9-13
NEC 32X CD-ROM Drive Specifications.....	9-14
Hitachi 4X DVD-ROM Drive Specifications	9-15
PC Adapter Device Specifications	9-15
Tape Backup Unit Specifications.....	9-16
Zip Drive Specification	9-17
Specifications	9-18
System Compliance	9-18

Preface

This manual contains technical information for servicing and repairing the NEC PowerMate® VT 300i Series computers manufactured by NEC Computer Systems Division, Packard Bell NEC, Inc. The manual contains hardware and interface information for users who need an overview of system design. The manual includes system setup information, disassembly procedures, and an illustrated parts list. The manual is prepared for NEC CSD trained customer engineers, system analysts, service center personnel, and dealers.

The manual is organized as follows.

Section 1 — System Overview, provides an overview of system features and includes brief descriptions of system components.

Section 2 — System Configuration, includes information on system IRQs, jumpers, and BIOS. The section also contains information on video modes and power management features. Also included is information on system utilities, including the BIOS update utility and NEC OS Restore CD.

Section 3 — Disassembly and Reassembly, provides computer disassembly and reassembly procedures. Each procedure is supported by detailed disassembly illustrations.

Section 4 — System Board, includes information on cable and board connector locations, jumper settings, and upgrade sockets. Also provided is information on board components and memory map.

Section 5 — Illustrated Parts Breakdown, includes an exploded view diagram (illustrated parts breakdown) and a parts list for field-replaceable parts.

Section 6 — Preventive Maintenance, provides recommended maintenance information for maintaining the system in top condition.

Section 7 — Troubleshooting, includes information for solving possible computer problems and their solutions.

Section 8 — NEC CSD Information Services, lists telephone numbers for obtaining service. The section also includes information on NEC CSD technical support, website, and bulletin board service.

Section 9 — Specifications, provides specifications for the major components in the system, including the system board, power supply, diskette drive, and hard drives.

Appendix A — NEC PowerMate VT 300i Series Release Notes, describes recommended operating procedures not documented in other PowerMate VT 300i Series documentation.

Abbreviations

A	ampere	dB	decibels
AC	alternating current	DC	direct current
ACK	acknowledge	DCC	direct cable connection
AGP	accelerated graphics port	DCE	data communications equipment
ASIC	application-specific integrated circuit	DDC	Display Data Channel
AT	advanced technology (IBM PC)	DIMM	Dual In-Line Memory Module
ATA	AT attachment	DIP	dual in-line package
ATAPI	AT attachment packet interface	DMA	direct memory access
ATM	asynchronous transfer mode	DMAC	DMA controller
BBS	Bulletin Board Service	DMI	Desktop Management Interface
BCD	binary-coded decimal	DOS	disk operating system
BCU	BIOS Customized Utility	DRAM	dynamic RAM
BIOS	basic input/output system	DVD	digital versatile disc
bit	binary digit	ECC	error checking and correction
BUU	BIOS Upgrade Utility	ECP	extended capabilities port
bpi	bits per inch	EDO	extended data output
bps	bits per second	EGA	Enhanced Graphics Adapter
C	capacitance	EISA	enhanced ISA
C	centigrade	email	electronic mail
Cache	high-speed buffer storage	EMI	electromagnetic interference
CAM	constantly addressable memory	EPP	enhanced parallel port
CAS	column address strobe	EPROM	erasable and programmable ROM
CD-ROM	compact disk-ROM	ESD	electrostatic discharge
CH	channel	EVGA	Enhanced Video Graphics Array
clk	clock	F	Fahrenheit
cm	centimeter	FAX	facsimile transmission
CMOS	complementary metal oxide semiconductor	FCC	Federal Communications Commission
COM	communication	FG	frame ground
CONT	contrast	FM	frequency modulation
CPGA	ceramic pin grid array	FP	fast page
CPU	central processing unit	FRU	field-replaceable unit
DAC	digital-to-analog converter	FSB	front side bus
DACK	DMA acknowledge	ftp	file transfer protocol

GB	gigabyte	MHz	megahertz
GND	ground	MIDI	musical instrument digital interface
HEX	hexadecimal	mm	millimeter
HGA	Hercules Graphics Adapter	MMX	multimedia extensions
Hz	hertz	modem	modulator/demodulator
IC	integrated circuit	MOS	metal-oxide semiconductor
ID	identification	MPEG	Motion Picture Experts Group
IDE	intelligent device electronics	ms	millisecond
IDTR	interrupt descriptor table register	MSB	most-significant bit
in.	inch	NC	not connected
INTA	interrupt acknowledge	NIC	networked information center
I/O	input/output	NMI	Non-maskable Interrupt
IPB	illustrated parts breakdown	ns	nanosecond
IPC	integrated peripheral controller	OCR	optical character recognition
ips	inches per second	OS	operating system
IR	infrared	PAL	programmable array logic
IrDA	Infrared Data Association	PC	personal computer
IRR	Interrupt Request register	PCB	printed circuit board
ISA	Industry Standard Architecture	PCI	Peripheral Component Interconnect
ISP	internet service provider	PDA	personal digital assistant
IRQ	interrupt request	PFP	plastic flat package
K	kilo (1024)	PIO	parallel input/output
k	kilo (1000)	pixel	picture element
KB	kilobyte	PLCC	plastic leaded chip carrier
kg	kilogram	PLL	phase lock loop
kHz	kilohertz	POST	Power-On Self-Test
lb	pound	p-p	peak-to-peak
LAN	local area network	PPI	programmable peripheral interface
LED	light-emitting diode	PROM	programmable ROM
LDCM	LANDesk Client Manager	PS/2	personal system/2
LSB	least-significant bit	QFP	quad flat pack
LSI	large-scale integration	R	read
M	mega (million)	RAM	random-access memory
mA	milliamps	RAMDAC	RAM digital-to-analog converter
max	maximum	RAS	row address strobe
MB	megabyte	RGB	red green blue
MFM	modified frequency modulation	RGBI	red green blue intensity

rms	root mean square	VESA	video electronics standards association
ROM	read-only memory	VFC	VESA-compliant feature connector
rpm	revolutions per minute	VGA	Video Graphics Array
RTC	real-time clock	VHF	very high frequency
R/W	read/write	VLSI	very large scale integration
S	slave	VRAM	video RAM
SCSI	Small Computer System Interface	W	watt
SDRAM	synchronous dynamic random access memory	WAN	wide area network
S.E.C.	single edge contact cartridge	WRAM	Windows RAM
SG	signal ground	W	write
SGRAM	synchronous graphics random access memory	www	world wide web
SIMM	single inline memory module		
S/N	signal to noise ratio		
SNMP	simple network management protocol		
SPM	standard page mode		
SRAM	static random access memory		
SRS	Sound Retrieval System		
SSI	small scale integration		
SVGA	Super Video Graphics Array		
SW	switch		
T&D	test and diagnostics		
TSC	Technical Support Center		
TTL	transistor/transistor logic		
tpi	tracks per inch		
UART	universal asynchronous receiver/transmitter		
UHF	ultra high frequency		
UL	Underwriter's Laboratories		
UMA	unified memory architecture		
UPS	uninterruptible power supply		
URL	uniform resource locator		
USB	universal serial bus		
V	volt		
Vac	volts, alternating current		
VCR	video cassette recorder		
Vdc	volts, direct current		
VDT	video display terminal		

1

System Overview

- Configurations
- Features
- Components

This section provides an overview of the NEC PowerMate® VT 300i Series microtower computer system configurations. The section highlights system hardware features, computer front, back, and inside features, and system security features. Also included are brief descriptions of the major components comprising the system.

Configurations

NEC PowerMate VT 300i Series computer systems are built-to-order systems for commercial offices. The systems feature an Intel® Celeron®, Pentium® II, or Pentium III processor, two dual inline memory module (DIMM) sockets, synchronous dynamic random access memory (SDRAM), and a plug and play input/output (I/O) controller.

The system also features two universal serial bus (USB) ports, two serial ports, and a parallel port. Ultra direct memory access (DMA), remote wakeup (“Wake-On LAN”), accelerated graphics port (AGP), and power management are supported.

Build choices include intelligent device electronics (IDE) hard drives ranging from 4.3 gigabyte (GB) to 12.9 GB. System memory is provided in 32-megabyte (MB) (minimum), 64-MB, or 128-MB DIMM modules. Memory configurations range from 32 MB to 256 MB.

Additional build choices include fax/modem, sound, video, and peripheral devices such as CD-ROM drives.

The following figure shows the components comprising the PowerMate VT 300i Series system (the monitor and speakers are optional).

PowerMate VT 300i Series System Components

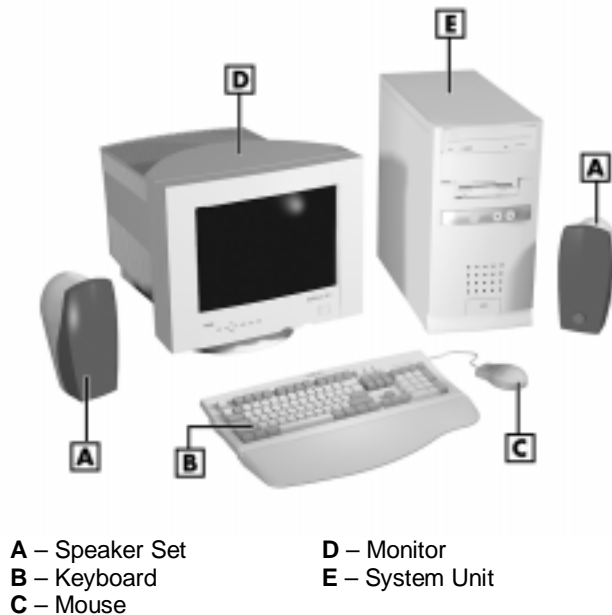

The following table lists the PowerMate VT 300i series system configuration.

PowerMate VT 300i Series System Configuration

Component	Description
System Board	Micro-Star International MS-6156 μ ATXZX
CPU*	<p><i>Celeron</i></p> <p>300A MHz, 66 MHz Front Side Bus (FSB) 333 MHz, 66 MHz FSB 366 MHz, 66 MHz FSB 400 MHz, 66 MHz FSB 433 MHz, 66 MHz FSB</p> <p><i>Pentium II</i></p> <p>350 MHz, 100 MHz FSB 400 MHz, 100 MHz FSB 450 MHz, 100 MHz FSB</p> <p><i>Pentium III</i></p> <p>450 MHz, 100 MHz FSB 500 MHz, 100 MHz FSB</p>
System RAM*	32 MB (minimum) to 256 MB of SDRAM in 2 DIMM sockets
Hard Drive*	IDE Ultra DMA/33: 4.3 GB (Maxtor) 4.3 GB (Seagate) 8.4 GB (Fujitsu) 8.4 GB (Maxtor) 12.9 GB (Maxtor)
Cache	Celeron: 128 KB Pipeline Burst SRAM integrated on processor cartridge Pentium II and III: 512-KB Pipeline Burst SRAM integrated on processor cartridge
AGP Slot	AGP slot on system board supports AGP-compatible graphics boards
Graphics Memory	Graphics board: 4-MB, 8-MB, or 16-MB SDRAM (depending on board installed)
Audio	Creative [®] ES1371/1373 audio chip integrated on system board
Diskette Drive	Samsung 3.5-inch 1.44-MB (SFD-321B)
Power Supply	90 watt or 145 watt
Keyboard	Chicony 6923
Mouse	Microsoft [®] 3D Mouse
CD-ROM Drive**	NEC CDR-3000A 32X Lite-On LTN-301 32X Lite-On LTN-382 40X
DVD-ROM Drive**	Hitachi GD2500 4X DVD-ROM/24X CD-ROM
Fax/Modem Board**	3Com [®] U.S. Robotics [®] Python, 56 Kbps V.90/Voice (ISA) Diamond MDM100D 56 Kbps V90 TTU Modem (PCI) Aztec MDM100A 56 Kbps V90 TTU Modem (PCI) GVC MDM100G 56 Kbps V90 TTU Modem (PCI)
AGP Board**	ATI [®] Minden RAGE IIC 4-MB AGP ATI XPERT 98 RagePRO 8-MB AGP Diamond Viper V550 Tnt 16-MB AGP
Zip Drive**	Iomega [®] 100-MB Zip Drive

PowerMate VT 300i Series System Configuration

Component	Description
Tape Backup Drive**	Seagate Travan 4/8-GB Tape Backup Device
LS-120 Drive**	Imation® SuperDisk® LS-120 Diskette Drive
Speakers**	Harman/Kardon 10-watt

* Component varies by system

** Built-to-order component

Features

The system front, back, and inside features are described in the following paragraphs. Also included are descriptions of system security features.

Front Features

The following figure identifies the components, lamps, and controls on the front of the system. Brief descriptions of the components follow the figure.

PowerMate VT 300i Series System Front View

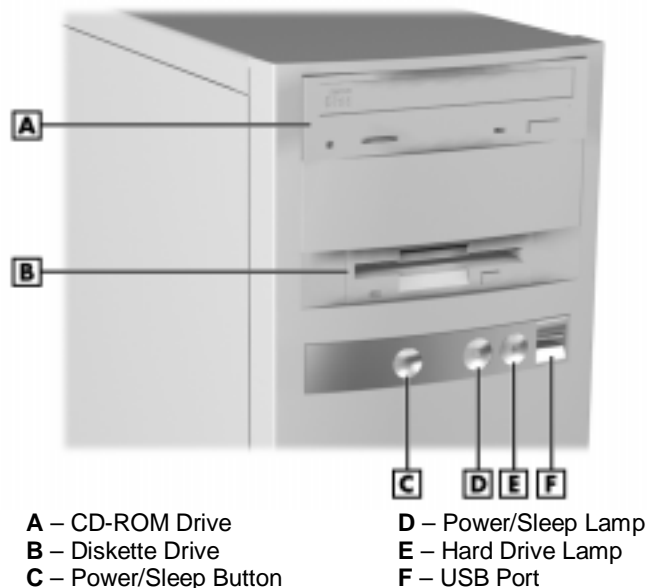

The system has the following devices, controls, and lamps on the front of the system (see the above figure for device, control, and lamp locations).

- CD-ROM drive — load and start programs from a compact disc (CD) and to play audio CDs.

-
- Diskette drive — copy data files to and from a diskette or as a bootable drive for loading and starting programs from a diskette.
 - Power/Sleep button — press this button to turn power on. To turn off the system, press the button and hold in for several seconds before releasing.

Lightly press and immediately release the power button to suspend system operation and go into the power saving mode.

An amber power/sleep lamp indicates that the system is in a power saving mode.

Press any key or move the mouse to resume system operation.

- Power/Sleep lamp — indicates if system power is on or off. Also indicates if the system is operating in a power saving mode.

A steady green lamp indicates that power is on. A steady amber lamp indicates that the system is in Sleep mode with full power reduction.

- Hard drive lamp — when lit, indicates that the hard drive is active. A lit lamp indicates that the hard drive is reading or writing data.
- USB port — use this port to connect plug and play universal serial bus (USB) devices without opening the system. A second port is on the rear of the system.

Rear Features

The rear of the computer contains external connectors, a power socket, and expansion board slots. The following figure identifies the connectors on the back of the system. Brief descriptions of each connector follow the figure.

PowerMate VT 300i Series System Rear View

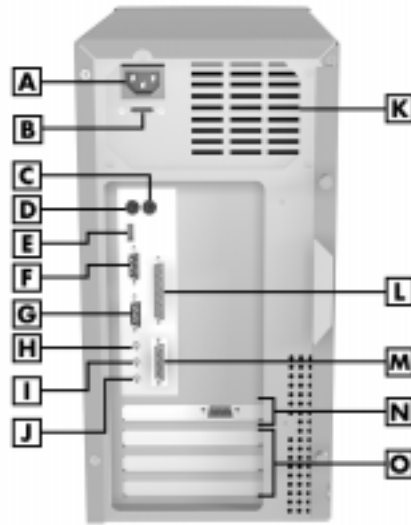

- | | |
|-----------------------------|---------------------------|
| A – Power Socket | I – Line In Jack |
| B – Voltage Selector Switch | J – Microphone In Jack |
| C – Mouse Port | K – Fan |
| D – Keyboard Port | L – Printer Port |
| E – USB Port | M – MIDI Port |
| F – Serial Port 1 | N – VGA Monitor Connector |
| G – Serial Port 2 | O – Expansion Slots |
| H – Line Out Jack | |

External connectors allow the attachment of peripheral devices such as a monitor, keyboard, mouse, and printer. The system has the following external connectors.

- Audio connectors — The following audio connectors are on the back of the system:
 - microphone in jack. This jack allows the connection of a microphone for recording audio information in data files.
 - line in jack. This jack allows the connection of a stereo audio device such as a stereo amplifier, cassette, or minidisc player for playback or recording.
 - line out jack. This jack allows the connection of an amplified output device such as powered speakers, stereo tape recorder, or an external amplifier for audio output. Use this jack for ordered speakers.
- USB ports — Each of the two USB ports permits the connection of up to 127 USB configured peripheral devices such as printers, monitors, modems, mouse, and game pads/joysticks.

- Serial ports — Serial port 1 (COM1) and serial port 2 (COM2) allow the connection of serial devices with 9-pin connectors. The devices include a pointing device, serial printer, or modem.
- Keyboard port — Attach a keyboard (PS/2[®]-compatible, 101-key or 102-key) with a 6-pin mini DIN connector to this port.
- Mouse port — Attach a mouse (PS/2-compatible) to this port.
- Printer port — Attach a parallel printer with a 25-pin connector to this port.
- VGA monitor connector — Attach a video graphics array (VGA)-compatible monitor (NEC MultiSync[®] monitor or other VGA-compatible monitor) with a 15-pin connector to this AGP board connector.
- Expansion board slots — Use these slots to install up to four optional boards (graphics, fax/modem, SCSI).
- Fax/modem ports — Some systems come with a 56-Kbps fax/modem board in an expansion slot. The board allows the connection of a phone line to the system for fax and data communications.

Inside Features

The following figure shows the interior of the computer and its major areas. A list of features follow the figure.

Inside the System

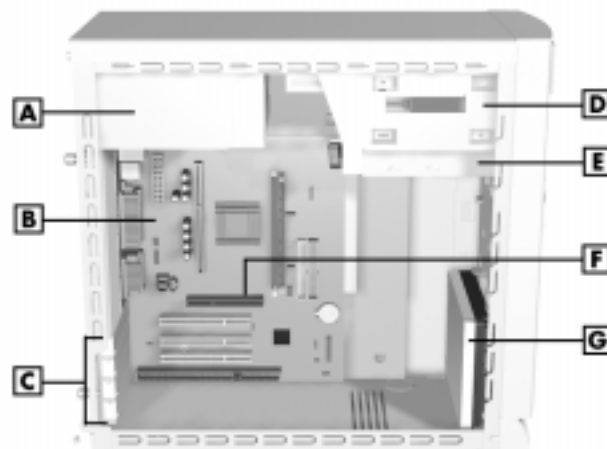

- | | |
|-----------------------------------|--------------------------------|
| A – Power Supply | E – Diskette Drive |
| B – System Board | F – AGP Board Connector |
| C – Expansion Slots | G – Hard Drive |
| D – Accessible Device Bays | |

The inside of the system has the following features:

- system board with connectors for the Celeron or Pentium processor single edge contact (S.E.C.) cartridge, DIMM memory, AGP board, and external devices
- system board with two IDE connectors, diskette drive connector, five expansion board connectors, and internal signal and power connectors
- AGP board (a built-to-order component)
- two accessible 5 1/4-inch slots for expansion (one slot contains the CD-ROM drive)
- one accessible 3 1/2-inch diskette drive slot (contains 1.44-MB diskette drive)
- two 3 1/2-inch internal device slots (contains one or two hard drives)
- 90- or 145-watt power supply.

For more information on the above features, see “Components” in this section.

Security Features

The system has hardware, software, and mechanical security features that offer protection against unauthorized access to the system and data. The following security features are available:

- **Password Security**

The BIOS Setup utility includes a feature that allows a user to set either a user or supervisor password, or both.

The user password controls booting of the system and controls access to the Setup utility and the keyboard. User access to the BIOS Setup utility is limited when a supervisor password is set. The supervisor password allows full access to the system and the BIOS.

See Section 2, “System Configuration,” for further information on setting and using passwords.

- **Windows Network Security Features**

The Windows Network Security feature is available through the Windows operating system. Check the Windows documentation for details.

- **Locking Tab**

The system has a locking tab on the rear of the chassis. The tab fits through a slot on the rear edge of the chassis cover when the cover is on. When a padlock is used in the tab, the system is physically protected from chassis intrusion.

Components

The major system components are listed in the following table, along with the page number where each component is briefly described.

System Components

Component	Go to Page
System Board	1-9
Diskette Drive	1-10
Hard Drive*	1-10
Power Supply	1-10
Keyboard	1-10
Mouse	1-11
AGP Board**	1-11
CD-ROM Drive**	1-11
Speakers**	1-11
Fax/Modem Board**	1-12
PC Adapter Device**	1-12
Tape Backup Unit**	1-12
Zip Drive**	1-13

* Component varies by system

** Built-to-order component

System Board

The system board contains the Celeron, Pentium II, or Pentium III processor mounted in a S.E.C. cartridge, system DIMM memory, Intel 440ZX AGPset, Winbond® W83977TF super I/O controller, and Creative® ES1373 PCI audio controller.

Internal connectors on the system board include two DIMM sockets, S.E.C. cartridge socket (slot 1 connector), and AGP board connector.

External connectors on the system board include two serial connectors, a parallel connector, two USB ports, keyboard port, mouse port, and external audio connectors.

The system board supports the standard 1.44-MB diskette drive, and up to four IDE devices such as a hard drive, CD-ROM drive, and Zip drive.

For further information on the system board, see Section 4, “System Board.”

Diskette Drive

A single diskette drive is supported in the system. The installed 1.44-MB 3 1/2-inch diskette drive is connected by a ribbon cable with three connectors. The diskette drive cable plugs directly into the system board. There are no switches or jumpers that need to be set and the diskette drive is terminated.

Diskette drive specifications are given in Section 9, "Specifications."

Hard Drive

All systems ship with one internal 3 1/2-inch hard drive (1-inch high, thin-height) installed in the bottom of the two internal drive slots, at the front of the system. Drives are available in 4.3-GB, 8.4-GB, and 12.9-GB IDE Ultra DMA models.

The system board has two IDE/PCI interface connectors (primary and secondary) for connecting IDE storage devices. A three-connector IDE cable connects to the IDE hard drive and the primary connector on the system board. A second three-connector IDE cable connects to the IDE CD-ROM drive and the secondary connector on the system board. Each connector supports up to two IDE devices.

An optional second IDE hard drive can be added to the primary channel. If the second hard drive is installed, it connects to the middle connector on the IDE cable.

Hard drive jumper settings are given in Section 2, "System Configuration." Connector locations for the IDE hard drive connectors on the system board are given in Section 4, "System Board." Hard drive specifications are given in Section 9, "Specifications."

Power Supply

The 90-watt or 145-watt power supply is mounted inside the system unit. It supplies power to the system board, option boards, diskette drive, hard drives, CD-ROM drive, DVD-ROM drive, keyboard, mouse, and other internal options. A fan inside the power supply provides system ventilation.

Power supply connector locations on the system board are given in Section 4, "System Board." Power supply specifications are given in Section 9, "Specifications."

Keyboard

The PS/2-compatible ergonomic keyboard is standard equipment for the system. The keyboard provides a numeric keypad, separate cursor control keys, 12 function keys, and is capable of up to 48 functions. Key status lamps on the keyboard include Num (Numeric) Lock, Caps (Capital) Lock, and Scroll Lock.

The keyboard's six-pin connector plugs into the back of the system. Keyboard specifications are given in Section 9, "Specifications."

Mouse

The system ships with a Microsoft® IntelliMouse® PS/2-compatible mouse or a Logitech® PS/2-compatible mouse as standard equipment. The mouse has two buttons and a cursor control wheel. The mouse has a self-cleaning mechanism that prevents a buildup of dust or lint around the mouse ball and tracking mechanism.

The six-pin mouse cable connector plugs into the back of the system. Mouse specifications are given in Section 9, “Specifications.”

AGP Board

All systems come with a graphics accelerator board preinstalled in the AGP slot. The board provides an integrated, advanced MPEG (Motion Picture Experts Group), 3D and 2D graphics and video accelerator for exceptional graphics and superior quality full-screen, full-motion video.

Included on the board is a standard VGA output connector for connecting a VGA-compatible monitor.

Graphics modes are given in Section 2, “System Configuration.” Graphics board specifications are given in Section 9, “Specifications.”

CD-ROM Drive

All systems come with a 32X or 40X CD-ROM drive. The drive features up to 32-speed or 40-speed technology, affording faster data transfer and smoother animation and video. The CD-ROM drive comes with an Enhanced IDE (EIDE) interface. The drive is fully compatible with Kodak Multisession Photo CDs™, CD-I, FMV, and CD Plus, as well as standard CDs. The CD-ROM drive can also play audio CDs (for systems with sound capabilities).

A three-connector IDE cable connects the IDE drive to the secondary IDE/PCI channel on the system board. The drive is connected as the master device on the secondary channel. An optional second device can be added to the secondary channel using the free connector on the three-connector cable.

CD-ROM jumper settings are included in Section 2, “System Configuration.” Specifications for the CD-ROM drive are given in Section 9, “System Specifications.”

Speakers

Some systems come with a high-quality 10-watt stereo speaker set, an AC adapter, and connecting cables. One speaker has a power on/off/volume control. Volume can also be controlled by the Windows sound software. The speaker set connects to the speaker line out jack on the back of the system.

Speaker specifications are given in Section 9, “Specifications.”

Fax/Modem Board

Some systems come with a fax/modem board preinstalled. The board operates as a fax system and data modem according to the operating system and software installed. The modem board offers a full-duplex speakerphone and 56,600 bits per second (bps) data/14,400 bps fax communications.

The fax/modem board is Plug and Play compatible. There are no switches or jumpers to set if the system is running the Windows 95 operating system. The fax/modem default settings are COM2, IRQ3 for Windows 95. Systems running the Windows NT 4.0 operating system must be configured for COM2 and IRQ3.

See Section 2, "System Configuration," for information on setting Windows NT jumpers. Section 4, "System Board," includes cable connection information for the fax/modem. Fax/modem board specifications are provided in Section 9, "Specifications."

Network Board

Some systems come with a 10/100 network board installed in a PCI slot. Specifications for the network board are given in Section 9, "Specifications."

PC Adapter Device

Some systems come with a PC Adapter Device. The PC adapter provides twin PC card slots, which support two Type I/II cards, or one Type I/II card and one Type III. The adapter supports ISA Plug and Play, and allows cards of mixed voltage to be used in the same system. PC cards can provide the system with memory, storage, fax/modem capabilities, video capabilities, or a serial port interface. The PC adapter driver enables full diskette drive or hard disk emulation on flash cards compatible with all compression and PC-utilities software.

The adapter is comprised of a "SwapBox" installed in a 5 1/4-inch accessible slot, a PC ISA adapter card, and a dual cable that connects them to the PC adapter bus.

PC adapter device connector locations are given in Section 4, "System Board." PC adapter device specifications are given in Section 9, "Specifications."

Tape Backup Unit

Some systems come with a tape backup unit. The tape backup unit is a high-capacity, high-performance data storage device that can compress and write data to and read and uncompress data from tape. The unit also comes with backup software used to tailor the backup process so that some or all of the files on the system can be backed up to a tape cartridge. Files backed up to a tape backup unit are compressed to conserve space and to speed up the backup process.

The tape backup unit installs in a 5 1/4-inch accessible slot. The installed tape backup unit is connected to an IDE cable that connects to the system board. The PCI/IDE channel, and the master/slave configuration of the unit depend on the specific configuration of the system.

Tape backup unit connector locations on the system board are given in Section 4, "System Board." Tape backup unit specifications are given in Section 9, "Specifications."

Zip Drive

Some systems come with a Zip drive. The Zip drive is a high-capacity, high-performance data storage device that writes data on and reads data from Zip disks. A Zip disk is flexible media contained in a durable plastic cartridge. The Zip drive supports removable Zip disks with a formatted capacity of 100 MB. The Zip drive can be used to back up work, archive old files, and transport work between computers.

The Zip drive is installed in a 5 1/4-inch accessible slot. The installed Zip drive is connected to an IDE cable that connects to the system board. The PCI/IDE channel and the master/slave configuration of the drive depend on the specific configuration of the system.

Zip drive cable connections are given in Section 4, "System Board." Zip drive specifications are given in Section 9, "Specifications."

2

System Configuration

- Interrupt Requests
- Jumper Settings
- BIOS Setup
- Video Modes
- Utilities

This section provides information for configuring the system. The section includes:

- system interrupt request (IRQ) assignments
- system jumper settings
- procedures for using the BIOS Setup utility to configure the system
- descriptions of video modes
- information on power management
- descriptions and procedures for using the following utilities and applications
 - BIOS Update utility
 - NEC OS Restore CD
 - NEC Application and Driver CD
 - Cheyenne Backup
 - Intel Processor Serial Number Control utility.

Interrupt Requests

The following paragraphs list the system interrupts (IRQs), parallel addresses and interrupts, and serial addresses and interrupts. Section 4, “System Board,” includes information on system resources (memory map, I/O addresses, and DMA settings).

System Interrupts

The system has 16 IRQs (IRQ 0 through 15) assigned to different devices (for example, printer, modem, keyboard, mouse). Initial IRQ settings are assigned at the factory, with settings dependent on the installed device(s). Several IRQs are unassigned for the installation of add-on devices. See “BIOS Setup” utility in this section for information on using the utility to assign or change the interrupts.

The following table lists the IRQ settings. Note that assignments 0 through 15 are in order of decreasing priority.

Interrupt Level Assignments*

Interrupt Priority	Interrupt Device
NMI	I/O Channel Check
IRQ00	System Timer
IRQ01	Keyboard
IRQ02	Programmable Interrupt Cascade
IRQ03	COM2*
IRQ04	COM1*
IRQ05	LPT2 (plug and play option)/Audio integrated on system board/User available
IRQ06	Diskette Drive Controller
IRQ07	Parallel Port 1
IRQ08	Real-Time clock
IRQ09	User Available
IRQ10	User Available
IRQ11	User Available (used by network board if present)*
IRQ12	Mouse
IRQ13	Reserved, Math Coprocessor
IRQ14	Primary IDE
IRQ15	Secondary IDE

* In Plug and Play systems, these interrupts are typical but may vary by configuration.

Parallel Port Interrupts

The parallel port I/O interrupts are given in the following table. The table lists all of the possible configurations but the port only uses one set. Any interrupts used for the built-in parallel port are not available for ISA parallel ports.

Parallel Port Interrupts

Port	Interrupt
LPT1	IRQ05
LPT2	IRQ05
LPT3	IRQ05
LPT1	IRQ07
LPT2	IRQ07
LPT3	IRQ07

Serial Port Interrupts

The interrupts for serial port 1 and serial port 2 are given in the following table. Any interrupts used for the built-in serial ports are not available for ISA parallel ports. Also, if serial ports share an interrupt, verify that hardware and software added to the system can share these interrupts without problems.

Serial Port 1 and Serial Port 2 Interrupts

Port	Interrupt
COM1	IRQ04
COM2*	IRQ03
COM3	IRQ04
COM4	IRQ03
COM1	IRQ03
COM2	IRQ04
COM3	IRQ03
COM4	IRQ04

Jumper Settings

Jumpers on the boards and devices in the system are used to set the system configuration. Boards and devices using jumpers include:

- system board
- CD-ROM drive
- fax/modem board
- Zip drive
- tape backup unit.

The following paragraphs list the jumpers and their factory settings.

 **Note:** Jumpers are set correctly at the factory for the system configuration. If a jumper change is required, change only the setting for that condition (see Section 4 for procedures on setting jumpers).

System Board Jumper Settings

The system board has four jumper blocks: Processor/Bus Speed jumper block SW1, Power On Mode jumper block JP1, Clear CMOS jumper block JBAT1, and Wake-Up on LAN jumper block JWOL. Each is briefly described in the following paragraphs. Procedures for setting the jumpers are included in Section 4. Specifications for the system board are included in Section 9.

CAUTION

Jumpers are set correctly at the factory for the system configuration. Only change (or check) the appropriate jumper settings. Otherwise, keep the jumpers at their factory settings.

Jumper block SW1 is a four-pin pair jumper block for setting the system processor/speed for a specific processor. The settings are shown in the following figure.

Processor/Bus Speed Jumper Block SW1 Settings

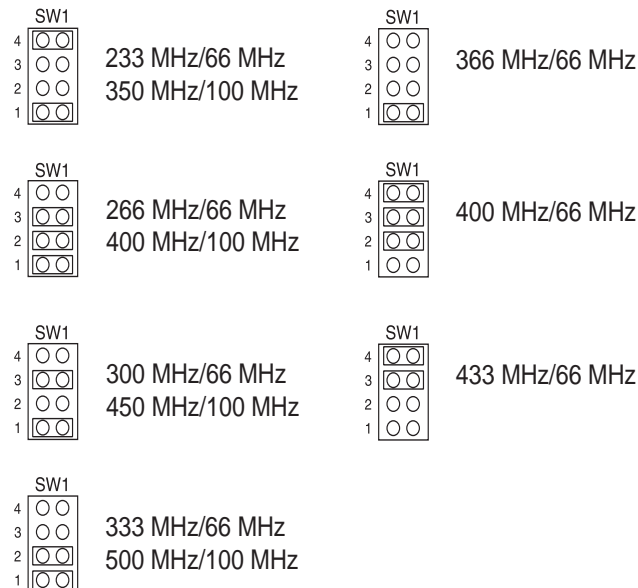

Power On Mode jumper JP1 is a two-pin block for setting how the system powers up. Depending on the jumper setting, the system powers up when the power button is pressed or when the power cord is connected. The factory settings are shown in the following table.

Power On Mode Jumper JP1 Settings

Function	Jumper Pins	Description
Power Button Boot	1 and 2	Enables system power on when the power button is pressed. Factory setting: pins 1 and 2 jumpered.
Power Cord Boot	Open	Enables system power on when the power cord is connected.

Clear CMOS jumper JBAT1 is a three-pin block for clearing the CMOS and system password. The factory settings are shown in the following table.



To prevent damage to the system board, do not clear CMOS and password while power is on.

Clear CMOS Jumper JBAT1 Settings

Function	Jumper Pins	Description
Normal	1 and 2	Disables Clear CMOS and Password function. Factory setting: pins 1 and 2 jumpered.
Clear CMOS and Password	2 and 3	Enables Clear CMOS and Password function.

Wake-On LAN jumper JWOL is a three-pin jumper block for use with a network board. The factory settings are shown in the following table.

Wake-On LAN Jumper JWOL Settings

Function	Jumper Pins	Description
Enable	1 and 2	Enables onboard Wake-On LAN. Factory setting: pins 1 and 2 jumpered.
Disable	2 and 3	Disables onboard Wake-On LAN.

Maxtor IDE Hard Drive Jumper Settings

The factory settings for the jumpers on the Maxtor IDE hard drive are shown in the following table. The settings are for a single drive installed in the system. Specifications for the hard drive are included in Section 9.

Maxtor IDE Hard Drive Jumper Settings

Function	Jumper Pins	Description
Master Device	J50-1 and J50-2	Sets hard drive as master device in single drive system. Factory setting: pins J50-1 and J50-2 jumpered.
Slave Device	J50-1 and J50-2	Sets hard drive as slave.
Cable Select (CSEL)	J48-1 and J48-2	Not used. Factory setting: pins J48-1 and J48-2 open.
Cylinder Limitation	J46-1 and J46-2	Not used. Factory setting: pins J46-1 and J46-2 open.

Seagate IDE Hard Drive Jumper Settings

The factory settings for the jumpers on the Seagate IDE hard drive are shown in the following table. The settings are for a single drive installed in the system. Specifications for the hard drive are included in Section 9.

Seagate IDE Hard Drive Jumper Settings

Function	Jumper Pins	Description
Master Device	5 and 6	Sets hard drive as master device in single drive system. Factory setting: pins 5 and 6 jumpered.
Slave Device	Open	Sets hard drive as slave.
Cable Select (CSEL)	3 and 4	Not used. Factory setting: pins 3 and 4 open.

NEC 32X CD-ROM Drive Jumper Settings

The factory settings for the jumpers on the NEC 32X CD-ROM drive are shown in the following table. The drive is set as the master device on the secondary channel. Specifications for the CD-ROM drive are included in Section 9.

NEC 32X CD-ROM Drive Jumper Settings

Jumper	Jumper Pin Settings
Cable Select (CS)	Not used.
Slave Present (SL)	Disabled, pin 2 open (factory default). Enabled, pin 2 jumpered.
Master Select (MA)	Enabled, pin 3 jumpered (factory default). Disabled, pin 3 open.

Lite-On 32X CD-ROM Drive Jumper Settings

The factory settings for the jumpers on the Lite-On 32X CD-ROM drive are shown in the following table. The drive is set as the master device on the secondary channel. Specifications for the CD-ROM drive are included in Section 9.

Lite-On 32X CD-ROM Drive Jumper Settings

Jumper	Jumper Pin Settings
Cable Select (CS)	Disabled, pins open (factory default). Enabled, pins jumpered.
Slave Present (SL)	Disabled, pins open (factory default). Enabled, pins jumpered.
Master Select (MA)	Enabled, pins jumpered (factory default). Disabled, pins open.

Zip Drive Jumper Settings

The factory settings for the jumpers on the Zip drive are shown in the following table. The settings description applies when looking at the back of the drive, with the IDE connector to the left of the jumper block. The drive is set as the slave device on the primary channel. Specifications for the Zip drive are included in Section 9.

Zip Drive Jumper Settings

Jumper	Jumper Pin Settings
Drive 0 Select (Master Drive Select)	Right two pin sets jumpered.
Drive 1 Select (Slave Drive Select)	Right-most pin set jumpered.
Cable Select Mode	All three pin sets jumpered.

Tape Backup Unit Jumper Settings

The factory settings for the jumpers on the tape backup unit are shown in the following table. Specifications for the unit are included in Section 9.

Tape Backup Unit Jumper Settings

Jumper	Jumper Pin Settings
Cable Select (CS)	Not used (pins 1-2 open).
Master Device (DS)	Enabled, DS (pins 5-6) jumpered. Disabled, DS (pins 5-6) open (factory default).
Slave Device (SL)	Disabled, SL (pins 3-4) open (factory default). Enabled, SL (pins 3-4) jumpered.

BIOS Setup Utility

The AMI BIOS Setup utility program is used to configure the main components of the computer.

The computer ships from the factory with the correct system parameters for the configuration. Unless optional hardware is added, it's not necessary to run the BIOS Setup utility to operate the system. However, the Setup utility should be run to set features that customize the system, such as security features.

System configuration information is stored in a nonvolatile memory device. The device retains its data when system power is turned off. Nonvolatile memory is stored in a complementary metal-oxide semiconductor (CMOS) memory chip backed up by a battery on the system board. The battery supplies continuous power to CMOS memory and maintains configuration information when system power is off (see "Battery Replacement" in Section 3).

NEC CSD recommends that the current BIOS Setup parameters be printed out or written down and the information stored in a safe place. This lets you restore the system to the current parameters if replacing the battery.

How to Start BIOS Setup

Follow these steps to start the BIOS Setup utility.

1. Turn on or reboot the system.
2. Press **F2** as soon as you see the following message at the bottom of the NEC startup screen.

Press F2 to enter BIOS Setup

You have about five seconds to press **F2** before the system boot continues.

3. Setup's Main Menu appears and looks similar to the following screen.

Setup Main Menu

Main Menu			
Main	Advanced	Security	Exit
BIOS Version		VI.xxxx	◀◀ Setup Help ▶▶
Processor Type		Pentium	
Processor Speed		333 MHz	Month: Jan-Dec
Cache RAM		512 KB	Day: 01-31
Total Memory		32 Mb	Year: 1901-2099
DRAM Bank 0		SDRAM	
DRAM Bank 1		None	
System Date		Wed Jan 20 1999	
System Time		10:17:59	
Floppy Drive A		1.44 MB 3 1/2	
Floppy Drive B		Not Installed	
Primary IDE Master		Auto	↑ Previous Item
Primary IDE Slave		Auto	↓ Next Item
Secondary IDE Master		Auto	↔ Select Menu
Secondary IDE Slave		Auto	
Esc: Exit Enter: Select F5: Setup Defaults F6: Original Values F10: Save & Exit			

How to Use BIOS Setup

Use the keys shown on the bottom of the Main menu to make your selections or exit the current menu. The following table describes the navigation keys.

Navigation Keys

Key	Function
Esc	Exits the menu.
Enter	Executes Command or brings up a submenu.
F5	Loads the Default Configuration values for this menu.
F6	Selects the Original Values for the field.
F10	Saves changes and Exits the BIOS Setup utility.
↑ or ↓ arrow keys	Moves cursor up and down in the menu.
← or → arrow keys	Selects next menu.

Help Setup information displays on the right side of the Setup screen.

Main Menu

The BIOS Setup utility usually comes up displaying the Main Menu. If BIOS is displaying another menu, choose the Main Menu by selecting Main in the legend bar.

See “How to Start BIOS Setup” for a look at a typical Main Menu screen.

Main Menu options are available by selecting submenus. Use the arrow keys to select a Main Menu option. Press **Enter** to display the submenu. Explanations of typical Main Menu options and suboptions appear in the following tables. Actual explanations and settings may vary between systems.

Main Menu Items

Menu Item	Settings (default is bold)
BIOS Version	This field is read-only and cannot be changed from the BIOS Setup utility. Example: V1.001
Processor Type	This field is read-only and cannot be changed from the BIOS Setup utility. Example: Celeron
Processor Speed	This field is read-only and cannot be changed from the BIOS Setup utility. Example: 333 MHz

Main Menu Items

Menu Item	Settings (default is bold)
Cache RAM	<p>This field is read-only and cannot be changed from the BIOS Setup utility.</p> <p>Example: 128 KB</p>
Total Memory	<p>This field is read-only and cannot be changed from the BIOS Setup utility.</p> <p>Example: 32 MB</p>
DRAM Bank 0 DRAM Bank 1	<p>These fields are read-only and cannot be changed from the BIOS Setup utility.</p> <p>Example: DRAM Bank 0 32 MB SDRAM DRAM Bank 1 None</p>
System Date	<p>Set system date in this field. Press Tab or Enter to move between month, date, and year fields.</p> <p>Example: Jan 20 1999</p>
System Time	<p>Set system time in this field. Press Tab or Enter to move between hour, minute, and second fields.</p> <p>Example: 09:30:00</p>
Floppy Drive A:	<p>Disabled 360 KB 5 1/4" 1.2 MB 5 1/4" 720 KB 3 1/2" 1.44/1.25 MB 3 1/2" 2.88 MB 3 1/2"</p>
Floppy Drive B	Not Installed
Primary IDE Master Primary IDE Slave Secondary IDE Master Secondary IDE Slave	<p>Device type, Auto Device type, Auto Device type, Auto Device type, Auto</p> <p>Each device menu item displays the Hard drive or CD-ROM identifier if a device is installed.</p> <p>If you install a hard drive that does not feature auto IDE type detection or your IDE hard drive was formatted on another system with parameters different from those reported by the drive, enter a parameter for each of the fields in the device submenu.</p> <p>Bring up a device submenu by pressing Enter. The submenus include Type, Cylinders, Write Precompensation, Heads, Sectors, LBA Mode, Block Mode, Fast Programmed I/O Modes, and 32-Bit Transfer Mode. Each mode is briefly described in the following.</p>

Main Menu Items

Menu Item	Settings (default is bold)
Type	None, CD-ROM, IDE Removable, User, ATAPI Removable, Auto Defaults to Disabled and changes at boot time based on auto-detection. When set to Auto, the values for Cylinders, Heads, Sectors, and Maximum Capacity are displayed but are read only. When set to Auto, the BIOS detects what the drive is capable of, not the translation mechanism that was used to format the drive. If a drive is run in a mode other than the mode in which it was partitioned and formatted, unpredictable results may occur, including data loss.
Cylinders	When Type is Auto, value in the Cylinders field is auto-detected and field is read only.
Write Precompensation	When Type is Auto, value in the Write Precompensation field is auto-detected and field is read only.
Heads	When Type is Auto, value in Heads field is auto-detected and field is read only.
Sectors	When Type is Auto, value in Sectors field is auto-detected and field is read only.
Maximum Capacity	xxxx MB
LBA Mode	On , Off When On is selected, it causes logical block addressing to be used in place of cylinders, heads, and sectors. When Type is set to Auto, the value in the LBA Mode field is auto-detected and the field is read only.
Block Mode	On , Off When On is selected, it allows block mode data transfers. When Type is set to Auto, the value in the Block Mode field is auto-detected and the field is read only.
Fast Programmed I/O Modes	Auto, 1, 2, 3, 4 , 5. Sets the Advanced PIO mode.
32 Bit Transfer Mode	ON , Off When On, allows 32 bit data transfers.

Advanced Menu

The Advanced Menu is a top-level menu in the BIOS Setup utility. Choose the Advanced Menu by selecting Advanced in the legend bar.

Advanced Menu options are available by selecting submenus. Use the arrow keys to select an Advanced Menu option. Press **Enter** to display the submenu. Settings of the Advanced Menu options and suboptions appear in the following tables.



CAUTION

Setting items on this menu to incorrect values can cause your system to malfunction.

Advanced Menu - Advanced CMOS Setup

Menu Item	Settings (default is bold)
Event Log Capacity	Status only. Press Enter to view the capacity.
Event Log Validity	Status only. Press Enter to view the validity of events.
View DMI Event Log	Status only. Press Enter to view the DMI log.
Clear all DMI Events Logs	No , Yes Selecting No prevents clearing out the DMI events logs.
Event Logging	Enabled , Disabled Selecting Enabled permits event logging.
ECC Event Logging	Enabled , Disabled Selecting Enabled permits ECC event logging.
Quick Boot	Enabled , Disabled When Enabled, the BIOS does not test system memory above 1 MB or wait for ready signals, allowing a quick boot.
1 st Boot Device	Disabled, IDE-0, IDE-1, IDE-2, IDE-3, Floppy , LS-120, ATAPI Zip, CDROM, SCSI, Network Sets the hard drive as the first boot device.
2 nd Boot Device	Disabled, IDE-0, IDE-1, IDE-2, IDE-3, Floppy, LS-120, ATAPI Zip, CDROM , SCSI, Network Sets the diskette drive as the second boot device.
3 rd Boot Device	Disabled, IDE-0 , IDE-1, IDE-2, IDE-3, Floppy, LS-120, ATAPI Zip, CDROM, SCSI, Network Sets the CD-ROM drive as the third boot device.

Advanced Menu - Advanced CMOS Setup

Menu Item	Settings (default is bold)
Quiet Boot	Enabled , Disabled When Enabled, displays the NEC splash screen, with settings for displaying POST or entering the BIOS setup.
S.M.A.R.T. for Hard Disks	Disabled , Enabled Select Enabled to use the Self Monitoring Analysis and Reporting Technology (S.M.A.R.T.) for reporting server system information over a network.
PS/2 Mouse Support	Enabled , Disabled Select Enabled to allow use of a PS/2 mouse.
CPU Serial Number	Disabled , Enabled

Advanced Menu - Advanced Chipset Setup

Menu Item	Settings (default is bold)
Graphics Aperture Size	4 MB, 8 MB, 16 MB, 32 MB, 64 MB , 128 MB, 256 MB Determines the effective size of the graphics aperture used in the particular PAC configuration.
USB Keybd/Mouse Legacy Support	Disabled, Enabled Select Enabled to enable the BIOS USB functions for legacy keyboards and mice.

Advanced Menu - Power Management Setup

Menu Item	Settings (default is bold)
Power Management/APM	Enabled , Disabled The Enabled setting enables Power Management and Advanced Power Management (APM).
Video Power Down Mode	Disabled, Standby, Suspend Specifies the power conserving state that the VESA VGA video subsystem enters after a specified period of display inactivity has expired.
Hard Disk Power Down Mode	Disabled, Standby , Suspend Specifies the power conserving state that the hard disk drive enters after a specified period of inactivity has expired.
Standby Time Out (Minutes)	Disabled , 1, 2, 4, 8, 10, 20, 30, 40, 50, 60 Specifies the length of time of system inactivity while in full power on state before entering Standby state.

Advanced Menu - Power Management Setup

Menu Item	Settings (default is bold)
Suspend Time Out (Minutes)	Disabled , 1, 2, 4, 8, 10, 20, 30, 40, 50, 60 Specifies the length of time of system inactivity while in Standby state before entering Suspend power state.
Power Button Function	Sleep/Suspend Sleep/Suspend sets the power switch for Suspend (Sleep) mode. With power on, pressing the switch once places the system in sleep mode. Pressing and holding the switch in for 4 seconds turns power off.
Restore on AC/Power Loss	Stay Off , Power On, Last State The Power On setting turns power on after a power loss. Jumper JP1 must be set for Power On (see "Setting System Board Jumpers" for procedures on setting JP1).
Ring Resume from Soft Off	Disabled , Enabled The Disabled setting causes the system to ignore any incoming call from a modem. Enabled allows the system to boot up on an incoming telephone call. Not supported on Windows 98 systems.
LAN Resume from Soft Off	Disabled , Enabled The Disabled setting causes the system to ignore any incoming signal from the LAN network board. Enabled allows the system to boot up on an incoming LAN signal from the network board.
RTC Alarm Resume from Soft Off	Disabled , Enabled When Enabled, you can choose the date and time the system boots up (see the following date and time settings).
RTC Alarm Date	Sets the day that the system boots up (RTC Alarm Resume Enabled).
RTC Alarm Hour	Sets real time clock alarm hour (RTC Alarm Resume Enabled).
RTC Alarm Minute	Sets real time clock alarm minute (RTC Alarm Resume Enabled).
RTC Alarm Second	Sets real time clock alarm second (RTC Alarm Resume Enabled).

Advanced Menu - PCI/Plug and Play Setup

Menu Item	Settings (default is bold)
Plug and Play Aware O/S	No for Win NT, Yes for Win 9x Select Yes if the system's operating system is Plug and Play compliant.
Primary Graphics Adapter	PCI, AGP Select AGP if the graphics board is AGP. Select PCI if the graphics board is PCI.
PCI VGA Palette Snoop	Disabled , Enabled Set to Enabled if an ISA adapter board requires VGA palette snooping.
PCI IDE Bus Master	Disabled, Enabled Set to Enabled to specify that the IDE controller on the PCI local bus includes a bus mastering device.

Advanced Menu - Peripheral Setup

Menu Item	Settings (default is bold)
Onboard Sound Chip	Disabled, Enabled The Enabled setting allows use of onboard sound.
Onboard FDC	Auto , Disabled, Enabled Select Auto to automatically detect FDC devices.
Onboard Serial Port A	Auto, Disabled, 3F8h, 2F8h , 3E8h, eE8h
Onboard Serial Port B	Auto, Disabled , 3F8h, 2F8h, 3E8h, eE8h
IR I/O Pin Location Select	SINB/SOUTB , IRRX/IRTX
Serial Port B Mode	Normal , IrDA, ASK IR Selecting Normal sets the port for normal use, not for IR use.
IR Duplex Mode	N/A
IrDa Protocol	N/A
Onboard Parallel Port	Auto, Disabled, 378 , 3BC Select Auto to allow the BIOS to automatically assign the parallel port to an available parallel port IRQ.
Parallel Port Mode	Normal, Bi-Dir , EPP, ECP Use this mode to choose the operating mode of the onboard parallel port.
EPP Version	Use this setting (1.7 or 1.9) to select the EPP version.

Advanced Menu - Peripheral Setup

Menu Item	Settings (default is bold)
Parallel Port IRQ	Parallel port 7 Setting depends on setting of Parallel Port Mode. If not set at auto, you can select the interrupt line for the onboard parallel port.
Parallel Port DMA Channel	This option allows you to choose DMA channel 1 to 3 for the onboard parallel port in ECP mode.
Onboard IDE	Disabled, Primary, Secondary, Both The Both setting enables both the primary and secondary IDE controllers.
Hard Disk Delay Time	Disabled, 3 sec., 6 sec. , 9 sec., 12 sec., 15 sec., 21 sec., 30 sec. The hard disk delay time gives the hard disk time to spin up before the system boots.

Advanced Menu - Change Language Setting

Menu Item	Settings (default is bold)
Language	English

Security Menu

The Security Menu is a top-level menu in the BIOS Setup utility. Choose the Security Menu by selecting Security in the legend bar.

Security Menu options are available by selecting submenus. Use the arrow keys to select a Security Menu option. Press **Enter** to display the submenu. Settings of the Security Menu options and suboptions appear in the following table.

Security Menu Items

Menu Item	Settings (default is bold)
Password Check	Setup , Always
Set Supervisor Password	[Enter] Use this field to set or change the supervisor password. Press Enter to bring up a dialog box where the password can be entered and confirmed.
Set User Password	[Enter] Use this field to set or change the user password. Press Enter to bring up a dialog box where the password can be entered and confirmed.

Exit Menu

The Exit Menu is a top-level menu in the BIOS Setup utility. Choose the Exit Menu by selecting Exit in the legend bar.

Exit Menu options are available by selecting submenus. Use the arrow keys to select an Exit Menu option. Press **Enter** to display the submenu. Explanations of the Exit Menu options and suboptions appear in the following table.

Exit Menu Items

Menu Item	Settings (default is bold)
Exit Saving Changes	Implements the changes just made, and exits BIOS.
Exit Discarding Changes	Reverts to the settings from before the BIOS session.
Load Optimal Settings	Reverts to the factory set optimal settings.
Load Fail Safe Settings	Reverts to the factory set fail safe settings.
Load Original Values	Reverts to the factory-shipped settings.

FLASH Utility

The system BIOS resides on a ROM chip in the system and is updated using the following procedure. Before starting the BIOS update, NEC recommends that you first contact NEC CSD for assistance (see Section 8 for contacts).

Update the Flash ROM with a BIOS flash diskette. You can get the diskette from NEC CSD or download the BIOS from the NEC CSD website or Bulletin Board System (BBS). See Section 8 for download, website, and bulletin board system information.

Update the BIOS from the BIOS flash diskette as follows.

1. Write down the BIOS Setup parameters currently set on your system, then turn off the system.
2. Put the flash diskette in drive A and turn on the system.
3. At the flash upgrade menu, type **Y** (without parenthesis) when prompted to save the existing BIOS.
 - When asked for a file name for the existing BIOS, choose a name easily recognized and with no more than eight characters. An extension is not required but, if desired, you can use **.rom** (without parenthesis).
 - Press **Enter** to save the existing BIOS file.
4. At the prompt asking for a file name for the BIOS update:
 - Use the form **biosname.rom** where biosname represents the BIOS filename of the BIOS update on the diskette.

-
- Press **Enter**.
 - 5. At the message EPROM programming is ready to start, type **Y** (without parenthesis) to continue. After the upgrade completes, remove the diskette.
 - 6. Reboot the system and start the Setup program. Press **F5** to reset the BIOS defaults. Use the recorded Setup selections you made at the beginning of this procedure to set the parameters.

If you receive the message “CMOS Setting Wrong”, with options to run Setup or load default settings, press **F1** to load default settings.

NEC OS Restore CD

The following procedures describe how to use the NEC OS Restore CD that ships with the system.

Read the following subsections in their entirety before using the NEC OS Restore CD to restore the Windows operating system or factory-installed drivers on the system.

Introducing OS Restore Options

The NEC OS Restore CD contains the Windows 95, Windows 98, or Windows NT operating system and device drivers for the hardware that was factory-installed in the system. Use this CD to restore the system to its working state if a problem occurs that causes data loss or corruption.

After restoring the operating system, use the NEC Application and Driver CD to install applications, optional drivers, and online documents.

 **Note:** Use the NEC Application and Driver CD to install or restore applications, optional drivers, and online documents (see “NEC Application and Driver CD” later in this section).

Choosing a Restore Program

The OS Restore program allows you to reinstall the Windows 95, Windows 98, or Windows NT operating system. Restore can be done in the following ways:

- **Auto**, which reformats and repartitions the hard drive before restoring the Windows OS and factory-shipped drivers (see “Auto Rebuild and Restore”)
- **Custom**, which reformats the hard drive with the option to repartition before restoring the Windows OS and factory-shipped drivers (see “Custom Rebuild and Restore”)
- **Fix OS** for Windows 95 and Windows 98 systems, which reinstalls the Windows OS while leaving data files intact. This restores the system to where you can back up data files. This option is intended as a precursor to a full format and restore (see “Fixing the Operating System”).

The operating system and factory-shipped drivers are always restored regardless of which program was chosen.

See “NEC Application and Driver CD” for instructions on installing any of the applications or online documents, or to install device drivers that did not come with the system.

Launching the NEC OS Restore CD

Launch the NEC OS Restore CD as follows.

CAUTION

The OS Restore program deletes all the data on the hard drive. If possible, back up all data before performing an OS restore.

1. Power on or restart the system and immediately insert the NEC OS Restore CD into the CD-ROM drive. The Operating System Restore Welcome screen appears (see the following figure).

Welcome screen



2. Click **Continue** to continue (or **Exit** to exit the program).

A License Agreement screen appears with three options: **Back**, **Reject**, and **Accept**.

3. Read the license agreement and click **Accept** to continue.

The Restore Mode screen appears with four options: **Back**, **Auto**, **Custom**, and **Fix OS**.

See one of the following sections to continue with the restore.

- “Auto Rebuild and Restore”
- “Custom Rebuild and Restore”
- “Fixing the Operating System”

Auto Rebuild and Restore

Reformat and repartition the hard drive as follows.



CAUTION

The OS Restore program deletes all the data on your hard drive. If possible, back up all data before performing an OS restore.

1. Launch the NEC OS Restore CD and follow the prompts to get to the Restore Mode screen (see “Launching the OS Restore CD”).
2. Click **Auto** to repartition and reformat the hard drive.
 - If running Windows NT 4.0, go to step 4.
 - If running Windows 95 or Windows 98, the Partition Information screen appears.
3. The Partition Information screen that appears in Windows 95 or Windows 98 has three options (**Back**, **FAT 16**, and **FAT 32**) and lets you select the File Allocation Table (FAT) type you want to use for the operating system restore.
 - Click **Back** to return to the Operating Mode screen.
 - Click **FAT 16** to select the FAT 16 allocation table (current FAT type).
 - Click **FAT 32** to select the FAT 32 allocation table (available for Windows 95 or Windows 98 systems only).

 **Note:** Some older software may not work in a Windows 95 or Windows 98 system configured for FAT 32. In addition, select FAT16 if a dual-boot system (with Windows 95 or Windows 98 and Windows NT 4.0) is desired.

4. A FAT 16 or FAT 32 Partition warning screen appears indicating that the system is about to partition and format the hard drive using the FDISK program. This warning screen contains three options: **Back**, **Exit**, and **Continue**.

5. Click **Continue**. The following steps should take place.

- System performs FDISK.
- System reboots.
- Partitions are formatted.
- OS and drivers load from the CD.

The “Operating System Restore Completed” screen appears when all files have been restored.

6. Remove the CD from the CD tray.

7. Click **OK** to reboot.

This completes the Auto Rebuild and Restore procedure.

See “NEC Application and Driver CD” for instructions on installing any of the applications or online documents, or to install device drivers that did not come with the system.

Restore any application or driver that was not provided by NEC by using the vendor diskette(s) or CD-ROM(s) included in its original packaging.

Custom Rebuild and Restore

Format the hard drive with choices on repartitioning the drive as follows.

1. Launch the NEC OS Restore CD and follow the prompts to get to the Restore Mode screen (see “Launching the OS Restore CD”).
2. Click **Custom** to repartition and/or reformat the hard drive before reinstalling the operating system.

After clicking **Custom**, the integrity of the system’s existing FAT table is verified.

- If the table is functional, a Partitioning the Hard Drive screen appears with options allowing you to retain the present partition structure or partition the hard disk using FAT16 or FAT32.
 - If the existing partition table is not functional, the system performs an “Auto” restore as described in “Auto Rebuild and Restore.”
3. If partitioning and reformatting the hard drive, go to step 6. Otherwise, click **Skip** to retain the present partition structure on the hard drive.

The Format Mode screen appears with four options: **Back**, **Quick**, **Full**, and **Exit**.

- Click **Back** to return to the Partition Information screen.
- Click **Quick** to do a quick hard drive format.

-
- Click **Full** to do a full hard drive format.
 - Click **Exit** to terminate the restore process.
4. After you select the type of hard drive format you want to do (Quick or Full), the Formatting Drive(s) screen appears with a status bar showing the progress of the formatting.

After the drive is reformatted, the Installing Applications screen appears, indicating the status as the operating system loads from the CD.

The drivers and other software components required for the operating system are also loaded from the CD.

After the OS finishes loading, the “Operating System Restore Completed” screen appears. Go to step 6.

5. To partition the hard drive, click **Continue** on the Partitioning the Hard Drive screen. The Partition Information screen appears (in Windows 95 and Windows 98 systems; in Windows NT 4.0 systems, the FAT16 Partition warning appears as described in step 7).
6. The Partition Information screen has three options and lets you select the File Allocation Table (FAT) type to use for the operating system restore.
- Click **Back** to return to the Operating Mode screen.
 - Click **FAT 16** to select the FAT16 allocation table (current FAT type).
 - Click **FAT 32** to select the FAT32 allocation table (available for Windows 95 and Windows 98 systems only).

 **Note:** Some older software may not work in a Windows 95 or Windows 98 system configured for FAT 32.

 **Note:** In Windows NT 4.0 systems, the Partition Information screen does not appear. Instead, the FAT16 Partition warning appears. This screen is described in the following paragraph.

7. After selecting the FAT type, a FAT 16 or FAT 32 Partition warning screen appears indicating that the system is about to partition and format the hard drive using the FDISK program. This warning screen contains three options: **Back**, **Exit**, and **Continue**.
8. Click **Continue**. The following steps should take place.
- System performs FDISK using the FAT type selected.
 - System reboots.

-
- Partitions are formatted.
 - OS and drivers load from the CD.

The “Operating System Restore Completed” screen appears when all files have been restored.

9. Remove the CD from the CD tray.

10. Click **OK** to reboot.

This completes the Custom Rebuild and Restore procedure.

See “NEC Application and Driver CD” for instructions on installing any of the applications or online documents, or to install device drivers that did not come with your system.

Restore any application or driver that was not provided by NEC by using the vendor diskette(s) or CD-ROM(s) included in its original packaging.

Fixing the Operating System

Follow these steps to restore the operating system to a state for retrieving and backing up data without repartitioning or reformatting the hard drive. Once all data is backed up, perform another NEC OS Restore using the **Auto** or **Custom** mode.

CAUTION

The Auto and OS Restore programs delete all the data on your hard drive. If possible, back up your data before performing an OS restore with these options.

1. Launch the NEC OS Restore CD and follow the prompts to get to the Restore Mode screen (see “Launching the OS Restore CD”).
2. Click **Fix OS** to do a basic operating system restore. The Fix OS screen appears and displays two options (Back and Continue).
3. Click **Continue**. The Installing Applications screen appears, showing the status of the restore. It also displays the version of Windows OS being installed. The installation can take from 5 to 10 minutes.

 **Note:** The drivers and other software components required for the operating system are also loaded from the CD.

After the OS finishes loading, the “Operating System Restore Completed” screen appears.

4. Remove the CD from the CD tray.
5. Click **OK** to reboot.

This completes the OS Restore (or “Fix OS”) procedure. The system is now in a state where data can be backed up. System settings previously located in the C:\WINDOWS directory are now in a backup directory C:\WINDOWS.ORG.



CAUTION

Some or all applications might not exhibit full functionality after the Fix OS is performed. To restore the system to its factory-installed state, perform another OS Restore using the **Auto** or **Custom** option.



CAUTION

Using the **Fix OS** option repetitively without using the **Auto** or **Custom** option afterward might cause unpredictable results.

To restore the system to its factory-installed state, perform another NEC OS Restore using the **Auto** or **Custom** option (see “Launching the OS Restore CD”).

NEC Application and Driver CD

The system comes with an NEC Application and Driver CD. Use this CD to install any or all of the software that comes with your system, including

- applications
- utilities device drivers
- NEC Help Center (online documentation)
- Healthy Environment online brochure.



Note: If you restore the operating system, the drivers that were factory-shipped are automatically installed.

Should a problem occur that causes data loss or corruption, you can restore these files to the computer using one of the programs on the CD.

Launching the Application and Driver CD

Use the Application and Driver CD to install applications, drivers, utilities, Internet browsers, and the online NEC Help Center.

 **CAUTION**

Do not select and install drivers for any hardware that is not currently installed on the system. Doing so can damage the operating system.

In Windows, launch the Application and Driver CD by inserting the CD into the CD-ROM drive.

The Application and Driver Installation Utility dialog box appears. See “Installing Software” for further instructions.

Installing Software

The Application and Driver Installation Utility dialog box consists of the following components:

- Selection Tabs — Located just below the title bar, each tab represents a software category. The selection tabs include applications, drivers, utilities, Internet browsers, and the online NEC Help Center.
- Description — Located in the bottom portion of the dialog box, the text describes the selected or highlighted software category or application, driver, etc.
- Install — Clicking the Install button installs the selected software.
- Exit — Clicking the Exit button closes the Application and Driver Installation Utility dialog box.

Once the Application and Driver Installation Utility dialog box appears, follow these steps to install the desired software.

1. Click the selection tab of your choice.
2. Click the desired application, driver, or utility.

 **CAUTION**

Do not select and install drivers for any hardware that is not currently installed on the system. Doing so can damage the operating system.

-
3. Click **Install** to install the selection.

Follow the on-screen instructions to install the selection.

4. Click **Exit** to close the Application and Driver Installation Utility dialog box.

Remove the CD from the CD-ROM drive when the installation is complete.

NEC Help Center

NEC CSD provides an online NEC Help Center. The Help Center comes on the NEC Application and Driver CD. It's easy to install and it provides an overview of the computer.

To install the NEC Help Center, see the following section "Installing the NEC Help Center." To uninstall the NEC Help Center, follow the instructions in "Uninstalling the NEC Help Center."

Installing the NEC Help Center

Install Microsoft Internet Explorer 4.01 on the system before installing the NEC Help Center. The Help Center requires Microsoft Internet Explorer 4.01 to run and it cannot be installed using the NEC OS Restore program unless Internet Explorer 4.01 has already been installed.

 **Note:** Install Microsoft Internet Explorer (IE) 4.01 on the system *before* installing the NEC Help Center. The Help Center requires IE 4.01 to run and it cannot be installed unless IE 4.01 has already been installed.

Internet Explorer 4.01 comes preinstalled on systems with the Windows 98 operating system.

Follow the instructions in the previous section, "Installing Applications," to install the NEC Help Center online documentation. The NEC Help Center is in the list of applications that appear when the NEC Application and Driver CD is started. Install it in the same manner as the applications and drivers in the list.

Uninstalling the NEC Help Center

Uninstall the NEC Help Center as follows.

1. Access the C:\Program Files\nechlpct directory.
2. Double click the **Unwise.exe** icon. All files related to the NEC Help Center and the **C:\Program Files\nechlpct** directory are removed from the system.

To reinstall the NEC Help Center, use the NEC Application and Driver CD and follow the instructions in "Installing the NEC Help Center."

Resolutions for NEC VistaScan USB Monitors

The following table lists the supported resolutions for NEC PowerMate Series systems with 15-inch and 17-inch NEC VistaScan™ USB monitors.



CAUTION

Setting resolutions other than the rates listed in the following table generates a "black" monitor screen.

Resolutions for 15 and 17 Inch NEC VistaScan USB Monitors

Mode	Resolution	Horizontal Frequency (KHz)	Vertical Frequency (Hz)
1	720 x 400	31.47	70
2	640 x 480	31.47	60
3	800 x 600	35.16	56
4	1024 x 768	35.52	87
5	640 x 480	37.50	75
6	800 x 600	37.88	60
7	640 x 480	43.3	85
8	800 x 600	46.88	75
9	1024 x 768	48.36	60
10	800 x 600	53.67	85
11	1024 x 768	60.02	75
12	1280 x 1024	63.98	60
13	1024 x 768	68.68	85

Cheyenne Backup

Cheyenne Backup is a data management and backup program, available on systems running the Windows 95 operating system. If hard drive performance degrades due to bad sectors or other internal problems, the Smart Hard Drive utility automatically invokes the Cheyenne Backup program and backs up the entire file system to a Zip drive or to a network drive.

 **Note:** Cheyenne Backup does not work in conjunction with an ATAPI tape drive.

Cheyenne Backup can also do regularly scheduled backups and scan files for viruses during a backup operation.

Intel Processor Serial Number Control Utility

The Intel Processor Serial Number Control utility is a Windows program that enables or disables the reading of the Pentium III processor serial number by software. This function lets you control which software programs or websites have permission to read the processor serial number. When installed, the utility runs automatically each time the system powers on.

 **Note:** The Intel Processor Serial Number Control Utility is for use with systems shipping with the Intel Pentium III processor. Installing this utility on a system which does not contain a Pentium III processor generates an error message.

This utility places an icon in the Windows system tray. The icon provides a visual status of the processor serial number. You have the option of hiding the system tray icon. You can disable the processor serial number at any time. However, enabling the serial number requires restarting the system.

The following information describes:

- system requirements
- installation procedures
- processor serial number features
- FAQs
- errata
- technical support.

System Requirements

The Intel Processor Serial Number Control utility requires:

- Pentium III processor-based system
- Windows 95, Windows 98, or Windows NT[®] 4.0 (or later)
- 2 megabytes of hard drive space.

Installation

The Intel Processor Serial Number Control Utility (version 1.0) comes on the NEC Application and Driver CD. See the user's guide for information about using the NEC Application and Driver CD. Run **setup.exe** from the directory where you unzip the file.

Processor Serial Number

The Intel processor serial number, a new feature of the Pentium III processor, is an identifier for the processor. The processor serial number is designed to be unique, and when used in conjunction with other identification methods, can be used to identify the system or user. This number can be used in a wide variety of applications which benefit from stronger forms of system and user identification.

The processor serial number is analogous to a conventional serial number, with these important differences:

- A software application can read the processor serial number.
- You can disable the reading of the serial number via utility programs such as this one, or via the BIOS, depending on the system configuration.

For additional information about the Pentium III processor and the processor serial number, please visit www.intel.com/pentiumiii.

FAQs

What are the benefits of the processor serial number?

You can use the processor serial number in applications which benefit from stronger forms of system and user identification.

Why would I want to turn off my processor serial number?

Intel believes the processor serial number can provide compelling benefits to users. They are developing features in conjunction with the processor serial number to allow responsible service providers to provide services which maintain your privacy. However, if you are concerned that a given application/service using your processor number might impact your privacy, you can turn off the processor serial number using the utility.

What is the default state of the processor serial number?

The default state of the processor serial number is on, until the Processor Serial Number Control utility is installed. Once the Processor Serial Number Control utility is installed, it turns the processor serial number off by default. You can use the utility to turn on the processor serial number.

Can a website read my serial number without my knowledge?

No, generally not. Websites cannot read serial numbers unless you allow them to download a program which can read the processor serial number. Almost all browsers are configured to warn users whenever they download executable software. Unless you disable the warning in the browser, you should receive a notification.

Does Intel track serial numbers?

Generally not, other than related to the manufacturing process. Intel does not, in the absence of advance and express consent of a user, collect serial number data which is otherwise identified with a user.

Which programs and/or websites currently use the processor serial number?

You can find a complete list of programs which can take advantage of the processor serial number and other new capabilities of the Pentium III processor at <http://www.intel.com/pentiumiii/utility.htm>.

How can I tell if my processor serial number is turned on?

The vast majority of Pentium III processor-based systems ship with the processor serial number enabled. The control utility allows you to check the status by:

- Viewing the icon itself. The disabled icon shows a red circle with a white “x.”
- Clicking the task tray icon and selecting the “Status” menu item. Or you can select the menu from the tool tip shown when you position the mouse over the task tray icon.

Technical Support

For world wide 7 days a week, 24 hours a day technical support, please visit the Intel support website at <http://support.intel.com>.

Email: support@intel.com

In the United States, call **800-628-8686** from 5:00 a.m. to 5:00 p.m. Pacific Standard Time.

For world wide phone contacts, please see <http://support.intel.com/support/feedback.htm>.

3

Disassembly and Reassembly

- System Unit Cover Removal
- Expansion Board Removal
- AGP Board Removal
- Front Panel Removal
- Blank Panel and Metal Shield Removal
- DIMM Module Removal
- Processor Cartridge Removal
- 5 1/4-Inch Device Removal
- 3 1/2-Inch Hard Drive Removal
- 3 1/2-Inch Diskette Drive Removal
- Power Supply Removal
- System Board Removal
- CMOS Battery Removal

This section contains step-by-step disassembly procedures for the system unit. A simplified disassembly illustration is provided with most procedures. Section 5 includes a parts list and an illustrated parts breakdown showing an exploded view of the system.

A Phillips-head screwdriver is the only required tool. For complete disassembly of the system unit, follow the disassembly order listed in the following table. To reassemble, follow the table and procedures in reverse order. Where reassembly is not readily apparent, reassembly procedures are provided.

PowerMate VT 300i Series Disassembly Sequence

Sequence	Part Name	See Page
1	System unit covers	3-3
2	Expansion board	3-8
3	AGP Board	3-9
4	Front panel	3-9
5	Blank panel and metal shield	3-10
6	DIMM memory module	3-11
7	Processor cartridge	3-11
8	5 1/4-inch device	3-18
9	3 1/2-inch hard drive	3-19
10	3 1/2-inch diskette drive	3-19
11	Power supply	3-21
12	System board	3-22
13	CMOS battery	3-23

When disassembling the system unit, follow these general rules.

- Before opening the system or handling boards or chips, touch the frame to discharge static.
- Disconnect all peripherals before disassembling the system unit.
- Do not disassemble parts other than those specified in the procedure.
- All screws are Phillips-head, unless otherwise specified.
- Label any connector before removing it. Note where the connector goes and in what position it was installed.

On completion of any reassembly, perform a power-on test. If a fault occurs, verify that the reassembly was performed correctly.



CAUTION

Before handling boards or chips, ground yourself to release static.

System Unit Cover Removal

The following subsections describe how to remove and replace the system unit left side cover and right side cover.



CAUTION

Electrostatic discharge can damage computer components. Discharge static electricity by touching a metal object before removing the left side cover.

Removing the Left Side Cover

Remove the left side cover as follows.



WARNING

Before removing the left side cover, turn off the power and unplug the system power cable. Power is removed only when the power cable is unplugged.

1. Turn off and unplug the system unit.
2. Unplug the keyboard, mouse, monitor, and any other device (such as a printer) connected to the back of the system.
3. If a padlock is installed in the chassis locking tab on the back of the chassis, remove it.
4. Remove the two thumb screws holding the left side cover to the rear of the chassis (see the following figure).
5. Grasp the handle on the left side cover and slide the cover towards the rear of the chassis about an inch.
6. Pull the top of the side cover away from the chassis about one-half inch, then lift the cover up and off the system.

Removing the Left Side Cover

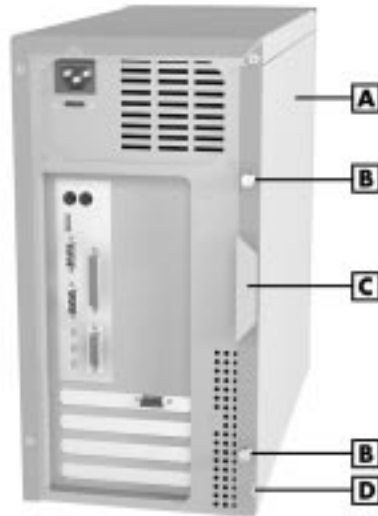

A – Left Side Cover C – Handle
B – Thumb Screws D – Lock Tab

Replacing the Left Side Cover

Replace the left side cover as follows.

 **Note:** To prevent damage to system cables, carefully position the cables out of the path of the cover.

1. Position the left side cover over the side of the chassis so that the back edge of the cover is about an inch beyond the back edge of the chassis (see the following figure).
2. Fit the flange on the bottom of the cover over the rail along the bottom edge of the chassis.
3. Align the lock tab slot at the bottom rear of the cover with the lock tab.
4. Align the tabs on the top of the cover with the top slots on the chassis.
5. Firmly press the cover against the chassis and slide the cover towards the front of the chassis until it locks in place.

 **Note:** If the left side cover does not slide all the way to the front of the chassis, check that the cover tabs at the front of the cover are properly inserted into their slots in the chassis.

Replacing the Left Side Cover



A – Tab Slots C – Chassis Rail
B – Left Side Cover D – Lock Tab

6. Replace the two thumb screws, and install the security lock (if used).
7. Reconnect all external peripherals.
8. Plug in all power cords.

Removing the Right Side Cover

Remove the right side cover as follows.

WARNING

Before removing the right side cover, turn off the power and unplug the system power cable. Power is removed only when the power cable is unplugged.

1. Turn off and unplug the system unit.
2. Unplug the keyboard, mouse, monitor, and any other device (such as a printer) connected to the back of the system.
3. Remove the left side cover as previously described.
4. Remove the three screws holding the right side cover to the rear of the chassis.
5. Grasp the handle on the right side cover and slide the cover towards the rear of the chassis about one-half inch.

Removing the Right Side Cover

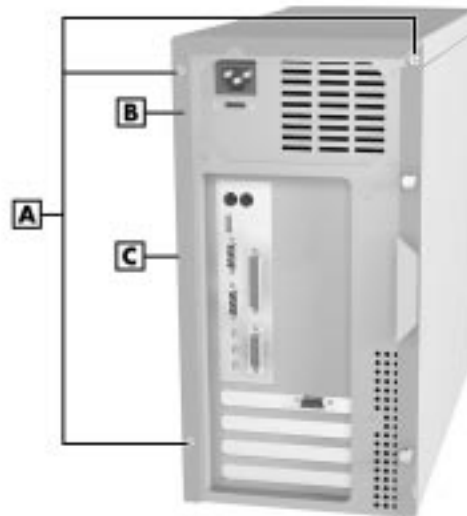

A – Screws
B – Handle

C – Right Side Cover

6. Pull out the bottom of the cover and tilt the cover towards the left side of the chassis until it releases from the chassis.
7. Remove the cover from the chassis.

Replacing the Right Side Cover

Replace the right side cover as follows.

1. Position the right side cover over the chassis, about a half-inch from the front panel.
2. Align the tabs on the inside of the top of the cover with the tab slots on the left side of the chassis.
3. Fit the flange along the bottom of the cover over the rail along the bottom edge of the chassis.

Replacing the Right Side Cover



A – Right Side Cover
B – Flange
C – Rail

D – Tabs
E – Tab Slots

4. Firmly press the cover against the chassis and slide the cover towards the front of the chassis until it locks in place.

 **Note:** If the right side cover does not slide all the way to the front of the chassis, check that the cover tabs at the front of the cover are properly inserted into their slots in the chassis.

5. Replace the three previously removed screws.
6. Replace the left side cover as previously described.
7. Reconnect all external peripherals.
8. Plug in all power cables.

Expansion Board Removal

Remove any installed expansion board(s) as follows.

1. Remove the left side cover (see “Removing the Left Side Cover” earlier in this section).
2. Label and disconnect any cables connected to the expansion board.
3. Remove and save the screw securing the board to the support bracket.
4. Pull the expansion board out of its connector and expansion slot. Set the board on an antistatic surface or store in an antistatic bag.

Removing an Expansion Board

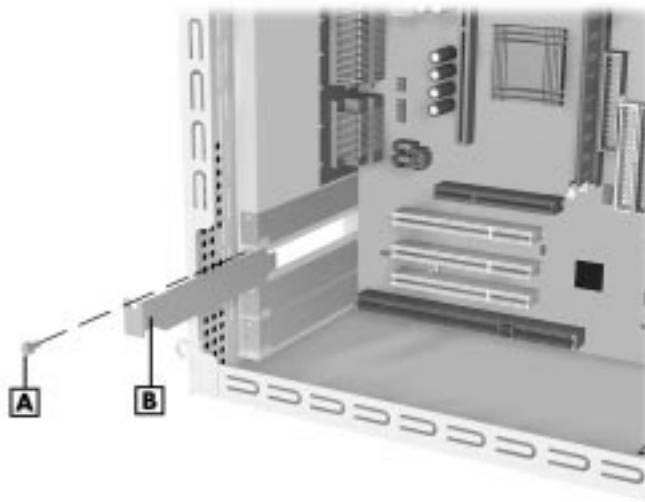

A – Screw C – System Board
B – Expansion Board

5. Install a new board or, if not installing a board, install the previously removed slot cover.
6. Place the slot cover over the slot and secure it with the slot cover screw.
7. Replace the left side cover (see “Replacing the Left Side Cover” earlier in this section).

AGP Board Removal

Remove the AGP board as follows.

1. Remove the left side cover (see “Removing the Left Side Cover” earlier in this section).
2. Remove the screw holding the AGP board in its expansion slot.
3. Pull the AGP board out of its connector on the system board and out of the system.
4. If not replacing the AGP board, install the previously removed slot cover.

Front Panel Removal

Remove the front panel from the chassis as follows.

1. Remove the left side cover (see “Removing the Left Side Cover” earlier in this section).
2. Remove the front panel from the chassis by grasping the edges at the bottom of the panel and evenly pulling out on the panel until its locking plugs release.

Removing the Front Panel

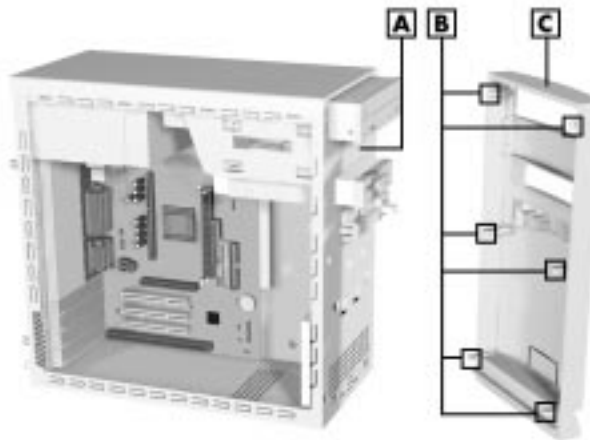

A – Metal Shield
B – Plugs

C – Front Panel

Blank Panel and Metal Shield Removal

Remove the blank panel from the front panel and the metal shield covering the accessible device bay as follows.

1. Remove the front panel (see “Front Panel Removal” earlier in this section).
2. Remove the blank panel from the selected slot in the front panel by pressing the blank panel tabs and pushing the blank panel out.

Removing the Blank Panel

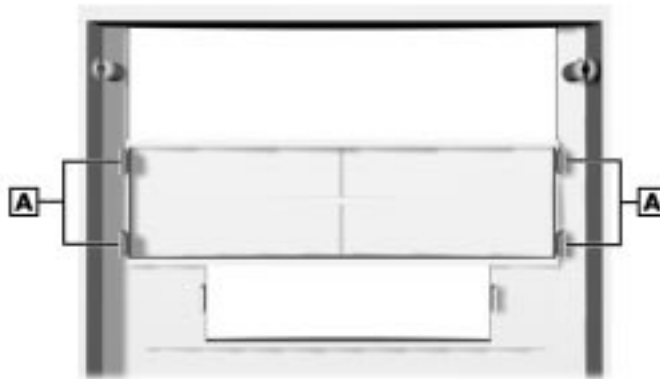

A – Blank Panel Tabs

3. Remove the metal shield from the accessible bay on the front of the chassis. (See the previous figure “Removing the Front Panel” for location of the metal shield.)
 - Insert a screwdriver into one of the holes in the metal shield.
 - Twist the shield with the screwdriver until the shield comes loose.

DIMM Module Removal

Remove a DIMM module from the system board as follows.

1. Remove the left side cover (see “Removing the Left Side Cover” earlier in this section).
2. Locate the DIMM module sockets on the system board.
3. Eject the DIMM module by pressing the plastic clips at the outer edges of the DIMM socket away from the module.

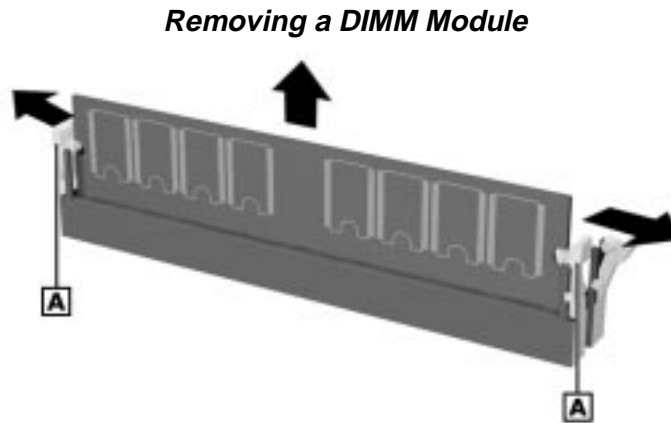

A – Plastic Clips

Processor Cartridge Removal/Replacing

The system board has a Slot 1 connector and a universal retention mechanism for securing in place a Celeron, Pentium II, or Pentium III processor cartridge (depending on system model).

To remove or replace a processor cartridge, refer to the appropriate procedure in the following subsections:

- “Removing the Celeron or Pentium III Processor Cartridge”
- “Replacing the Celeron or Pentium III Processor Cartridge”
- “Removing the Pentium II Processor Cartridge”
- “Replacing the Pentium II Processor Cartridge.”

Removing the Celeron or Pentium III Processor Cartridge

Remove the Celeron processor cartridge or the Pentium III processor cartridge from the universal retention mechanism and system board as follows.



CAUTION

Before handling components, reduce static discharge by touching the chassis.

1. Power off the system.
2. Remove the left side cover (see “Removing the Left Side Cover” earlier in this section).
3. Position the system on its right side for easier access to the system board and processor cartridge.



WARNING

If the system was just running, the processor and heat sink on the system board are hot. To avoid a burn, let the components cool for 10 minutes before continuing.

4. Locate the processor cartridge on the system board. If necessary, remove any expansion board(s) blocking access to the processor cartridge.
5. If the processor cartridge has an attached cooling fan, tag and unplug the fan cable from its connector (CPUFAN) on the system board.
6. At one end of the processor cartridge (see the following figure), carefully pull the locking lever away from the cartridge approximately 1/4-inch. The lever requires a strong steady pull to release the cartridge.
7. While holding the locking lever out, carefully pull up on the end of the processor cartridge to release it from the lever.
8. Repeat steps 6 and 7 for the locking lever on the opposite end of the cartridge.
9. Pull the cartridge straight up and out of the socket and universal retention mechanism. Store the cartridge in an antistatic bag.

Removing the Celeron or Pentium III Processor Cartridge

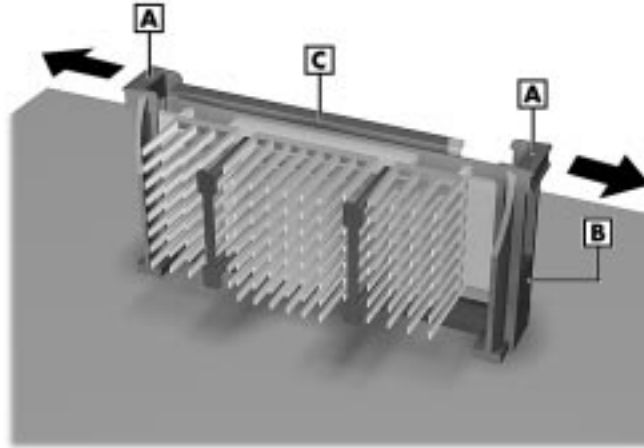

A – Locking Lever
B – Universal Retention Mechanism
C – Processor Cartridge

10. Install the replacement processor cartridge (see “Installing the Celeron or Pentium III Processor Cartridge” in the following subsection).

Installing the Celeron or Pentium III Processor Cartridge

Install the Celeron cartridge or the Pentium III processor cartridge in the universal retention mechanism and system board as follows.



CAUTION

Before handling components, reduce static discharge by touching the chassis.

1. Remove the processor currently in the system (see “Removing the Celeron or Pentium III Processor Cartridge” earlier in this section).



CAUTION

Using the wrong heat sink or no heat sink can damage the processor, system board, or both. Ensure that the replacement processor cartridge has the correct heat sink (refer to the documentation that comes with the processor). Do not use the heat sink from the removed processor cartridge.

Additional installation information can be obtained from NEC CSD (see Section 8, “NEC CSD Information Services” for information on contacting NEC CSD).

-
2. Align the replacement cartridge with the top of the retention mechanism so that the notch in the cartridge connector aligns with the key in the Slot 1 connector.

Installing the Celeron or Pentium III Processor Cartridge

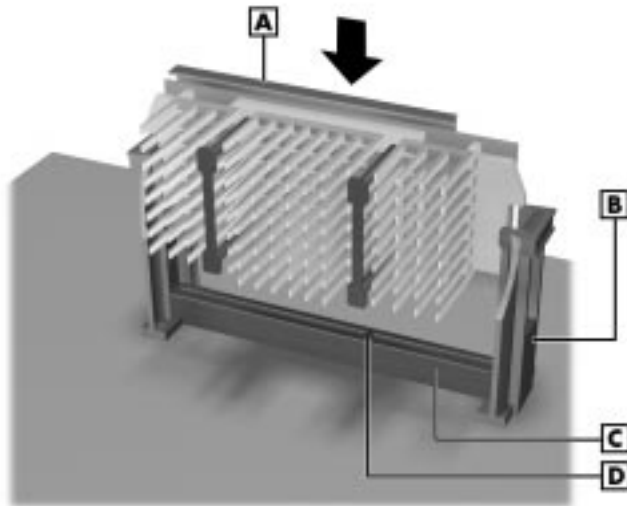

A – Processor Cartridge **C** – Slot 1 Connector
B – Retention Mechanism **D** – Key

3. Insert the cartridge into the retention mechanism and evenly press down on the cartridge until it fully seats in the Slot 1 connector.
4. If the processor cartridge has an attached cooling fan, plug the fan cable into its connector (CPUFAN) on the system board.
5. Set the processor jumpers on the system board for the processor type installed (see “Processor Jumper Settings” in Section 2).
6. Reinstall any expansion boards that may have been removed.
7. Replace the left side cover (see “Replacing the Left Side Cover” earlier in this section).
8. Connect any peripherals and power cords, and power up the system.

Removing the Pentium II Processor Cartridge

Remove the Pentium II processor cartridge from its Slot 1 socket and universal retention mechanism on the system board as follows.



CAUTION

Before handling components, reduce static discharge by touching the chassis.

1. Remove the left side cover (see “Removing the Left Side Cover” earlier in this section).
2. Position the system on its right side for easier access to the system board and processor cartridge.



WARNING

If the system was just running, the processor and heat sink on the system board are hot. To avoid a burn, let the components cool for 10 minutes before continuing.

3. Locate the processor cartridge on the system board. If necessary, remove any expansion board(s) blocking access to the processor cartridge.
4. If the processor cartridge has an attached cooling fan, tag and unplug the fan cable from its connector (CPUFAN) on the system board.
5. If the system has a plastic “top” bar holding the processor and heat sink in place, remove the bar as follows (see the following figure). If the system does not have the top bar, go to step 6.
 - Remove the DIMM memory module from DIMM socket 1 and place it on an antistatic surface (see “Removing a DIMM” earlier in this section).
 - Squeeze each end of the top bar and lift it out of the processor heat sink and retention mechanism.
 - Continue to step 6 to remove the cartridge processor.
6. Press the two locking levers in as far as they go to release the processor cartridge from the retention mechanism.
7. Carefully pull the cartridge straight up and out of the connector and retention mechanism.

Removing the Pentium II Processor Cartridge

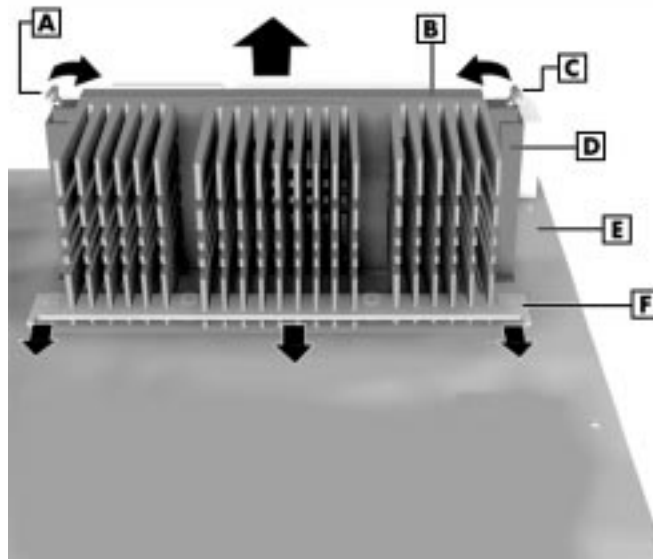

A – Locking Lever
B – Processor Cartridge
C – Locking Lever

D – Retention Mechanism
E – System Board
F – Top Bar

8. Store the processor cartridge in an antistatic bag.
9. Install the replacement Pentium II processor cartridge (see “Installing the Pentium II Processor Cartridge,” next).

Installing the Pentium II Processor Cartridge

Install the Pentium II cartridge in the universal retention mechanism and system board as follows.

CAUTION

Before handling components, reduce static discharge by touching the chassis.

1. Remove the processor cartridge currently in the system (see “Removing the Pentium II Processor Cartridge” earlier in this section).

 **CAUTION**

Using the wrong heat sink or no heat sink can damage the processor, system board, or both. Ensure that the replacement processor cartridge has the correct heat sink (refer to the documentation that comes with the processor). Do not use the heat sink from the removed processor cartridge.

Additional installation information can be obtained from NEC CSD (see Section 8, "NEC CSD Information Services" for information on contacting NEC CSD).

2. Align the replacement cartridge with the top of the retention mechanism so that the notch in the cartridge connector aligns with the key in the Slot 1 connector.
3. Insert the cartridge into the retention mechanism and evenly press down on the cartridge until it is fully seated in the Slot 1 connector.
4. Lock the cartridge in place by pressing out on the two locking levers.

Installing the Pentium II Processor Cartridge

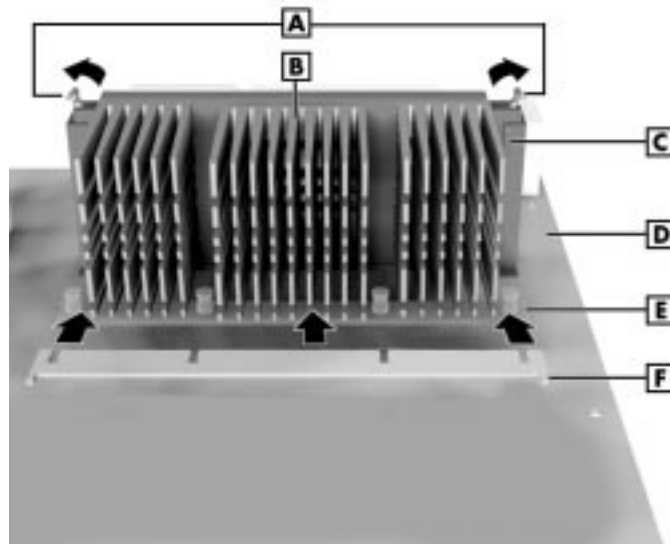

- | | |
|--------------------------------|-------------------------|
| A – Locking Levers | D – System Board |
| B – Processor Cartridge | E – Bottom Bar |
| C – Retention Mechanism | F – Top Bar |

-
5. For systems using the top bar, install it as follows.



Use caution when inserting the top bar to prevent damage to the plastic clips on the DIMM socket.

- Insert the bar into its pins on the retention mechanism and the heat sink. The flat side of the bar goes against the flat side of the bottom bar (see the above figure).
 - Install the previously removed DIMM module.
6. If the processor cartridge has an attached cooling fan, plug the fan cable into its connector (CPUFAN) on the system board.
 7. Set the processor jumpers on the system board for the processor type installed (see “Processor Jumper Settings” in Section 2).
 8. Install the left side cover (see “Replacing the Left Side Cover” earlier in this section).
 9. Connect any peripherals and power cords, and power up the system.

5 1/4-Inch Device Removal

Remove a 5 1/4-inch device from the system unit as follows.

1. Remove the system left side cover, right side cover, and front panel. (See “Removing the Left Side Cover,” “Removing the Right Side Cover,” and “Removing the Front Panel” earlier in this section.)
2. Label and unplug all signal and power cables from the 5 1/4-inch device to be removed.

If the device is a CD-ROM or DVD-ROM and the system is equipped with audio, also unplug the audio cable from the CD-ROM or DVD-ROM.

3. Remove the single screw on the right side of the chassis that secures the device to the chassis.
4. Remove the two screws on the left side that secure the device to the chassis (see the following figure).
5. Slide the device out of the front of the system unit.

Removing a 5 1/4-Inch Device

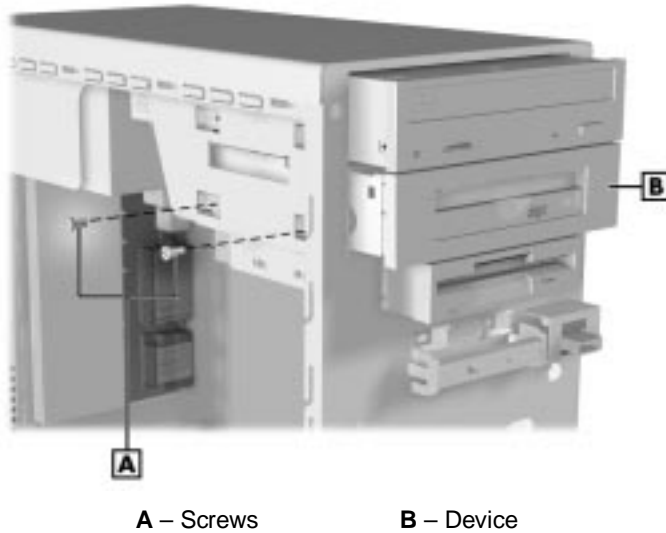

3 1/2-Inch Hard Drive Removal

Remove a 3 1/2-inch hard drive as follows.

1. Remove the left side cover and front panel (see “Removing the Left Side Cover” and “Front Panel Removal” earlier in this section).
2. While holding the hard drive, remove the four screws securing the drive to the chassis (see the following figure).
3. Remove the hard drive from the top (or bottom) bracket of the chassis and unplug the power and signal cables from the drive.

 **Note:** When reinstalling the drive, note that all power cables are keyed to fit only in the correct position.

Removing the Hard Drive

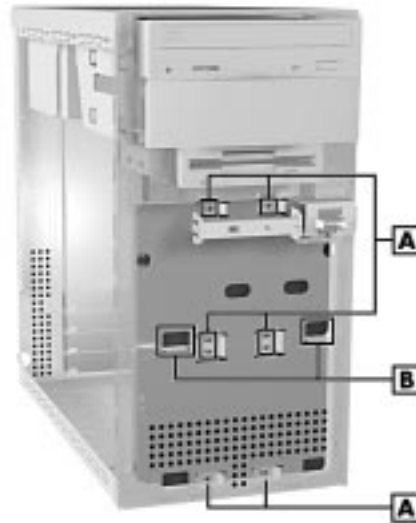

A – Screws

B – Top Bracket

3 1/2-Inch Diskette Drive Removal

Remove the 3 1/2-inch diskette drive as follows.

1. Remove the left side cover and the front panel (see “Removing the Left Side Cover” and “Front Panel Removal” earlier in this section).
2. Label and unplug the signal and power cables from the back of the diskette drive.

 **Note:** When reinstalling the diskette drive, note that all power cables are keyed to fit only in the correct position.

3. Remove the two screws holding the diskette drive to the diskette drive bracket.
4. Slide the diskette drive out of the chassis.

Power Supply Removal

Remove the power supply as follows.

WARNING

Before removing the system unit covers, turn off the power and unplug the system power cable. Power is removed only when the power cable is unplugged.

1. Remove the left side cover and the right side cover (see “Removing the Left Side Cover” and “Removing the Right Side Cover” earlier in this section).
2. Tag and unplug the power cables from all installed devices.
3. Cut any tie wraps that may be securing the power cables to the system unit.
4. Remove the four screws securing the power supply to the back of the system unit (see the following figure).
5. Slide the power supply towards the front of the chassis enough to clear the top rail (about an inch), then lift the power supply out of the chassis.

Removing the Power Supply



A – Top Rail
B – Power Supply

C – Screws

System Board Removal

Remove the system board as follows.

1. Ensure that all external cables are disconnected from the rear of the system.
2. Remove the left side cover (see “Removing the Left Side Cover” earlier in this section).
3. Remove all expansion boards and the AGP board (see “Expansion Board Removal” and “AGP Board Removal” earlier in this section).
4. Tag and unplug all cables from the system board.
5. Remove the seven screws securing the system board to the chassis.

Removing the System Board

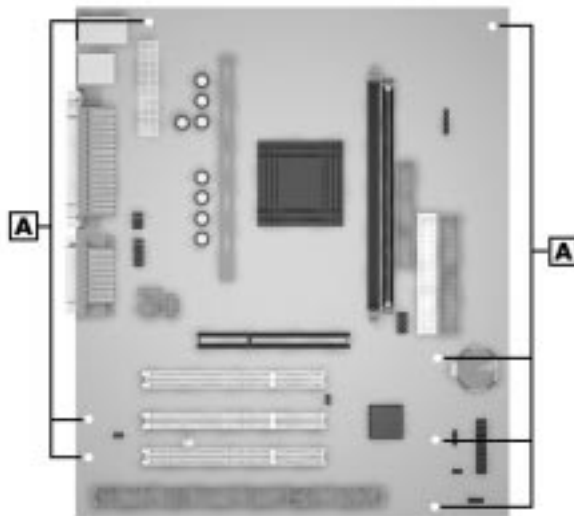

A – Screws

6. If the system board is being replaced, remove the processor cartridge and the DIMM module(s) from the board and install them on the new board.

CMOS Battery Removal

Remove the 3-volt lithium battery from the system board as follows.

1. Turn off and unplug the system unit and any external options connected to the system.



CAUTION

Removing the battery from the system board causes the computer to lose system configuration information. If possible, run Setup and record the system configuration settings before removing the battery. Use that information to restore the system after replacing the battery.

2. Remove the left side cover (see “Removing the Left Side Cover” earlier in this section).
3. Locate the battery on the system board.

Locating the Battery

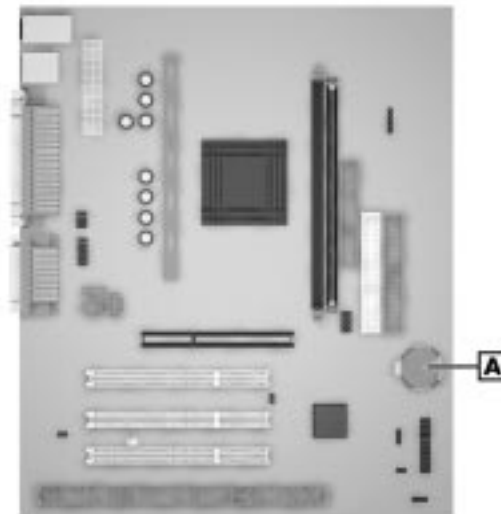

A – Battery

-
4. Press down on the battery clip to release the battery from its socket.

Removing the Battery



A – Battery

B – Clip

5. Remove the battery and discard in accordance with the manufacturer's instructions.

! WARNING

The battery can explode if it is incorrectly replaced or improperly discarded. Use only the same battery or an equivalent type recommended by the manufacturer when replacing the battery.

Lithium acts as a catalyst when exposed to water and causes spontaneous combustion on contact. Discard used batteries according to the manufacturer's instructions.

6. With the positive (+) side facing up, press the new battery into the socket.
7. Replace the left side cover (see “Replacing the Left Side Cover” earlier in this section).
8. Connect external peripherals and power cables.
9. Run Setup to reconfigure system parameters (see Section 2, “System Configuration”).

4

System Board

- Connectors, Jumpers, and Sockets
- Components
- Resources

This section describes the locations of connectors, jumpers, and sockets on the system board, including external cable connectors, internal board connectors, jumper locations, and upgrade sockets.

Included in this section are procedures for setting jumpers on the system board and a DIMM memory upgrade path for the DIMM sockets. Also included are descriptions of system board components, system memory map, and I/O addresses.

Connectors, Jumpers, and Sockets

The following paragraphs describe the system board external cable connector locations, internal board connector locations, jumper locations, and upgrade sockets. Included are procedures for setting jumpers on the system board and a table showing the upgrade path for the DIMM sockets.

External Cable Connectors

Locations of the external cable connectors on the system board at the back of the system unit are shown in the following figure. For descriptions of the connectors, see Section 1, "System Overview."

System Board External Cable Connector Locations

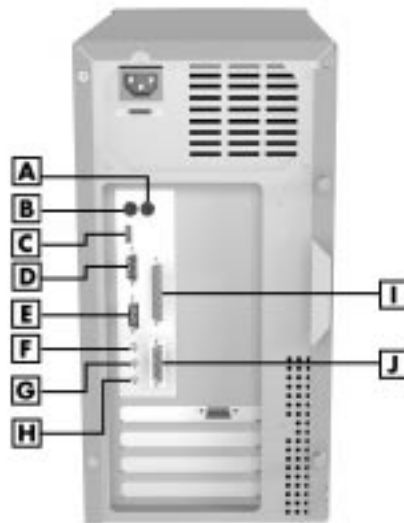

A – Mouse Port
B – Keyboard Port
C – USB Port
D – Serial Port 1
E – Serial Port 2

F – Line Out Jack
G – Line In Jack
H – Microphone In Jack
I – Printer Port
J – MIDI Port

Internal Connectors and Sockets

Locations of the internal connectors and sockets on the system board are shown in the following figure.

System Board Internal Connector and Socket Locations

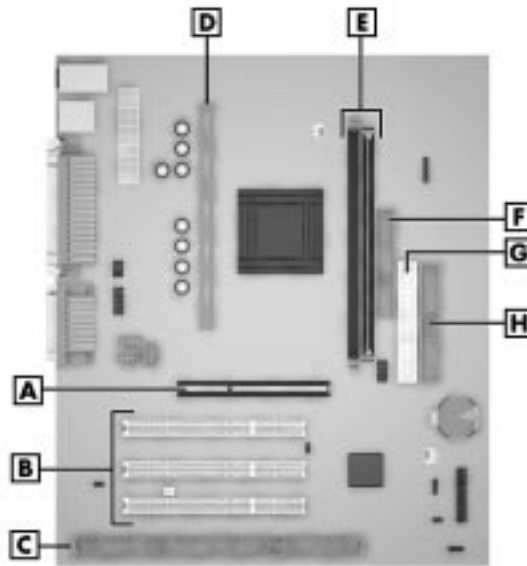

- | | |
|--------------------------------|-------------------------------------|
| A – AGP Board Connector | E – Memory Sockets 1 and 2 |
| B – PCI Connectors | F – Diskette Drive Connector |
| C – ISA Connector | G – Secondary IDE Connector |
| D – Processor Socket | H – Primary IDE Connector |

System Board Jumpers

The system board contains four configuration jumper blocks:

- Processor/Bus Speed jumper block SW1
- Power On Mode jumper block JP1
- Clear CMOS jumper block JBAT1
- Wake-Up on LAN jumper block JWOL.

The following figure shows the location of the jumper blocks on the system board. To reset the jumper blocks, see the following paragraphs. (The factory-set jumper settings are included in Section 2, “System Configuration.”)

Locating System Board Jumpers

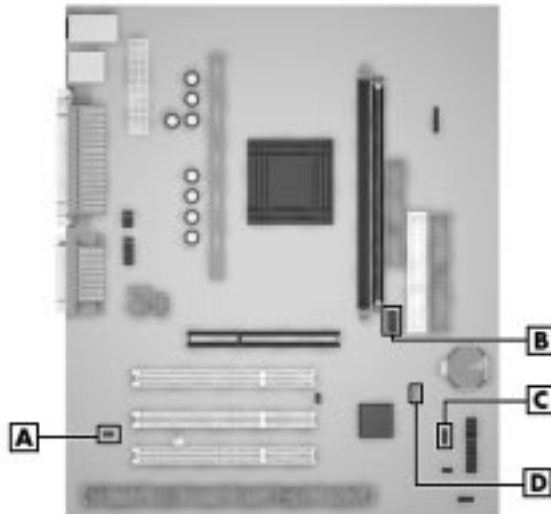

A – Power On Mode Jumper JP1
B – Processor/Bus Speed Jumpers SW1

C – Clear CMOS Jumper JBAT1
D – Wake-On LAN Jumper JWOL

Changing Processor Speed

To change processor speed, the system must be jumpered for the correct processor/bus speed. Use the following steps to change the processor/bus speed after installing an upgrade processor.

CAUTION

Jumpers are set correctly at the factory for the system configuration. Only change (or check) the appropriate jumper setting if upgrading the processor.

1. Power off and unplug the system and any external options.

WARNING

System power must be off before changing a jumper setting.

2. Remove the left side cover (see “Removing the Left Side Cover” in Section 3).
3. Locate jumper block SW1 on the system board.
4. Use needle nose pliers to move the jumpers according to the settings shown in the following figure.

Processor Jumper Settings

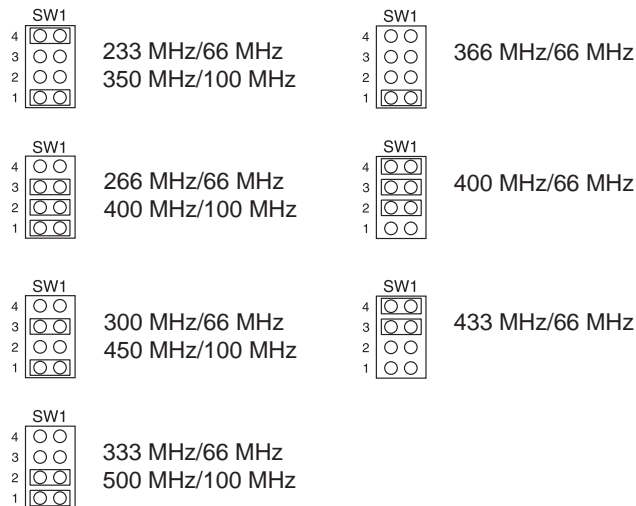

5. Replace the left side cover (see “Replacing the Left Side Cover” in Section 3).
6. Connect system power cables and external options.
7. Power on the system and run the BIOS Setup utility to check the configuration of the system.

Setting the Power On Mode

The system can be jumpered to start up in one of the following modes:

- when the power button is pressed or
- when the power cord is plugged in (“Immediate Boot Up”).

Set Power On Mode jumper JP1 as follows.

1. Power off and unplug the system and any peripherals.

WARNING

The system power must be off before removing the cover and changing a jumper setting.

2. Remove the left side cover (see “Removing the Left Side Cover” in Section 3).
3. Locate jumper block JP1 on the system board.

-
4. Set jumper JP1 as follows.
 - Set the jumper on pins 1 and 2 to allow system boot up when the power button is pressed.
 - Remove the jumper from pins 1 and 2 for immediate system boot up when the power cord is plugged into a power source. Park the jumper on one pin to prevent loss.
 5. Replace the left side cover (see “Replacing the Left Side Cover” in Section 3).
 6. Connect any peripherals and power cords and power up the system.
 7. Press **F2** to open the BIOS Setup utility.
 8. Set the BIOS for the power option you jumpered (see “Advanced Menu - Power Management Setup” in this section).

Clearing the CMOS and Password

If the CMOS needs to be restored to its factory state or the password needs to be cleared and reset, set jumper block JBAT1 as follows.



CAUTION

Jumpers are set correctly at the factory for the system configuration. Only change (or check) the appropriate jumper setting if you forgot your password or want to change the password.

1. Access the BIOS Setup utility and record any customized settings. See “BIOS Setup” in Section 2.
2. Power off and unplug the system and any peripherals.



WARNING

The system power must be off before removing the cover and changing a jumper setting.

3. Remove the left side cover (see “Removing the Left Side Cover” in Section 3).
4. Locate jumper block JBAT1 on the system board.
5. Move the jumper from pins 1 and 2 to pins 2 and 3 to clear the CMOS and password settings.
6. Move the jumper back to pins 1 and 2.
7. Replace the left side cover (see Section 3, “Replacing the Left Side Cover”).

-
8. Connect system power cables and external options.
 9. Power on the system.
 10. Run the BIOS Setup utility to check the configuration or to set a new password (see Section 2).

Setting Wake-On LAN

Wake-On LAN jumper JWOL can be set to enable the onboard Wake-On LAN function or to disable the function. Set jumper JWOL as follows.



CAUTION

Jumpers are set correctly at the factory for the system configuration. Only change (or check) the appropriate jumper setting for your application.

1. Power off and unplug the system and any peripherals.



WARNING

The system power must be off before removing the cover and changing a jumper setting.

2. Remove the left side cover (see “Removing the Left Side Cover” in Section 3).
3. Locate jumper JWOL on the system board.
4. Set jumper JWOL as follows.
 - Set the jumper on pins 1 and 2 to enable the Wake-On WAN function.
 - Set the jumper on pins 2 and 3 to disable the Wake-On WAN function.
5. Replace the left side cover (see “Replacing the Left Side Cover” in Section 3).
6. Connect any peripherals and power cords and power up the system.
7. Press **F2** to open the BIOS Setup utility, navigate to Power Management Setup, and enable the “Resume By Ring” function (see Section 2, “System Configuration”).
8. Save and close the BIOS Setup utility.

Upgrade Sockets

The system board has the following upgrade sockets:

- processor socket
- DIMM sockets.

See the following paragraphs for socket descriptions.

Processor Socket

The processor Slot 1 socket is designed for easy processor upgradeability through use of a Single Edge Contact (S.E.C.) cartridge and a universal retention mechanism. The cartridge contains the processor, second level cache, thermal plate, back cover, and heatsink.

The 242-pin edge connector Slot 1 socket on the system board holds the processor cartridge. The cartridge is held in place in the socket by the universal retention mechanism.

To remove or install a processor cartridge, see Section 3, “Disassembly and Reassembly.”

DIMM Sockets

The system board has two, 168-pin, gold-plated DIMM sockets (locations are shown on the figure at the beginning of this section). The sockets support up to 256 MB of high-speed SDRAM memory. The sockets support DIMM modules in 16-, 32-, 64-, and 128-MB unbuffered non-ECC memory configurations.

The DIMM modules

- can be installed in one or two sockets
- size can vary between sockets
- speed must match the processor bus speed (66 MHz or 100 MHz)
- can be single- and double-sided.

See the following tables for supported DIMMs and for sample DIMM upgrade paths. To determine the memory needed for a memory upgrade, see “Checking System Memory” in this section. To remove or install a DIMM, see Section 3, “Disassembly and Reassembly.”

Supported DIMMs

DIMM Size	Non-ECC Configuration
16 MB	2 Mbit x 64
32 MB	4 Mbit x 64
64 MB	8 Mbit x 64
128 MB	16 Mbit x 64

Sample DIMM Upgrade Paths*

Total Memory	DIMM 1	DIMM 2
32 MB	32 MB	--
64 MB	32 MB	32 MB
64 MB	64 MB	--
128 MB	64 MB	64 MB
128 MB	128 MB	--
256 MB	128 MB	128 MB

* The information in this table shows sample DIMM upgrade paths. It does not represent every combination of DIMMs supported in the system.

Checking System Memory

If you do not know how much memory is installed in the system, check the amount as follows.

1. On the Windows 95, Windows 98, or Windows NT 4.0 desktop, point to **My Computer** and click the right mouse button.
2. With the left mouse button, click **Properties**. Select the **General** tab to show the amount of random access memory (RAM) in the computer. For Windows 95 and Windows 98, you can also select the **Performance** tab to show the RAM memory.

 **Note:** If a discrepancy is found in the amount of memory displayed at the Power-On Self-Test or in Windows with the amount of memory installed, check that the memory modules were installed correctly.

Components

The system board has the following features:

- Intel 82443ZX AGPset used for AGP, PCI/ISA, memory, and peripheral control
- Winbond® W83977TF I/O controller (integrates standard PC I/O functions: two serial ports, one EPP/ECP-capable parallel port, floppy disk interface, real time clock, keyboard and mouse controller, and support for two USB ports)
- two dual in-line memory module (DIMM) sockets with support for up to 256 MB of SDRAM using DIMMs
- American Megatrends Inc. (AMI) BIOS in a flash memory device supporting system setup and PCI auto-configuration
- 32-KB internal dual write-back cache integrated on the processor
- pipelined 32-bit addressing
- 64-bit data
- 32 MB to 256 MB of SDRAM upgradeable with 32-MB, 64-MB, or 128-MB increments through DIMM sockets on the system board
- 512-KB (128 KB for Celeron processor) write-back secondary cache memory on processor
- System Setup utility built into the BIOS
- 2-Mb Flash ROM for fast economical BIOS upgrades
- PCI local bus for fast data transfer
- integrated sound (Creative® ES1371/ES1373 audio system)
- power management with power saving mode, featuring inactivity timer
- external connectors for connecting the following external devices:
 - VGA-compatible monitor (standard, super, high-resolution VGA) to AGP port on graphics board
 - personal system/2 (PS/2®)-style mouse
 - PS/2-style keyboard
 - bi-directional Enhanced Parallel Port (EPP) and Enhanced Capabilities Port (ECP) support for a parallel printer
 - serial devices through two buffered 16C550 UART serial ports, supporting up to 115.2 KB per second
 - two USB devices
 - speaker and microphone connectors (line in, line out, microphone in).

The following table lists the major components on the system board.

System Board Components

Component	Function
Processor (mounted in a S.E.C. cartridge)	<p><i>Celeron</i> 300-, 333-, 366-, 400-, or 433-MHz processor</p> <p><i>Pentium II</i> 350-, 400-, or 450-MHz processor</p> <p><i>Pentium III</i> 450- or 500-MHz processor</p>
Intel 82440ZX AGPSet:	
82443ZX AGP Host Bridge Controller (PAC)	<p>Provides bus control signals, address paths, and data paths for transfers between the processor's host bus, PCI bus, AGP connector, and system memory. The PAC comes in a 492-pin BGA package on the system board.</p> <p>Features include processor interface control (32-bit addressing, optimized for 100-MHz host bus frequency, supports 66 MHz bus frequency), an integrated DRAM controller (synchronous DRAM, 64/72-bit path-to-memory, auto detection of memory type) and an AGP interface (compliant with AGP specification with data transfer rates up to 133 MHz), fully synchronous minimum latency PCI bus interface (compliant with PCI specification with PCI-to-DRAM access greater than 100 MB per second).</p>
82371EB PCI ISA/IDE Xcelerator (PIIX4)	<p>Functions as a PCI to ISA bridge; PCI IDE functionality; a USB controller; integrated dual channel enhanced IDE interface with support for Ultra DMA/33; enhanced DMA controller; interrupt controller based on 82C59, with support for 15 interrupts; power management logic (sleep/resume and remote wake on LAN); real-time clock with 256-byte, battery-backed CMOS static RAM (SRAM); and 16-bit counters based on 82C54. The chip comes in a 324-pin BGA package on the system board.</p>
Winbond Multi Super I/O W83977TF controller	<p>The controller provides the following features:</p> <ul style="list-style-type: none"> Multimode parallel port <ul style="list-style-type: none"> Centronics compatible (standard mode) Enhanced capabilities port (ECP) Enhanced parallel port (EPP) Two RS-232C serial ports Integrated 8042A keyboard controller Supports industry-standard floppy controller
Creative® ES1371/ES1373 PCI chip	<p>Provides audio on system board.</p>

Processor and Secondary Cache

The system uses an Intel Celeron, Pentium II, or Pentium III processor with an internal clock speed of 300 MHz, 333 MHz, 350 MHz, 366 MHz, 400 MHz, 433 MHz, 450 MHz, or 500 MHz (depending on type of processor and model).

The processor is an advanced pipelined 32-bit addressing, 64-bit data processor designed to optimize multitasking operating systems. The 64-bit registers and data paths support 64-bit addresses and data types.

To use the processor's power, the system features an optimized 64-bit memory interface and 512 KB (128 KB for Celeron) of secondary write-back cache on the processor.

The processor is compatible with 8-, 16-, and 32-bit software written for the Intel386™, Intel486™, Pentium, and Pentium Pro processors. The processor is mounted in S.E.C. cartridge with an attaching heatsink that installs as a unit in Slot 1 on the system board.

System BIOS

The ISA- and PCI-compatible BIOS is contained in a flash memory device on the system board. The BIOS provides the Power-On Self-Test (POST), the system Setup program, a PCI and IDE auto-configuration utility, and BIOS recovery code.

The system BIOS is always shadowed. Shadowing allows any BIOS routine to be executed from fast 32-bit DRAM on the system board, instead of from the slower 8-bit flash device.

The Flash ROM allows fast, economical BIOS upgrades. The Flash ROM is a reprogrammable EPROM containing both the system and video BIOS. Using the Flash ROM to change the ROM BIOS provides the following advantages:

- the BIOS upgrade is performed quickly and easily
- the expense of replacing ROM BIOS chips is eliminated, so system maintenance costs are reduced
- there is less chance of inadvertently damaging the system board than when physically replacing ROMs
- new technology can be incorporated while maintaining corporate standards
- network administrators can exercise company-wide control of BIOS revisions.

The BIOS programs execute the Power-On Self-Test, initialize processor controllers, and interact with the display, diskette drive, hard drives, communication devices, and peripherals. The system BIOS also contains the Setup utility. The POST copies the ROM BIOS into RAM (shadowing) for maximum performance.

The Flash ROM allows the system and video BIOS to be upgraded with the BIOS Update utility, without having to physically remove the ROM (see Section 2 for further information on the BIOS Update utility). The Flash ROM supports the reprogramming of the system BIOS and the video BIOS.

System Memory

The system comes with between 32 MB and 256 MB of SDRAM installed in DIMM sockets on the system board.

The memory configuration consists of two sockets. The DIMM sockets accept 168-pin, 64-bit (non-ECC) 16-, 32-, 64-, and 128-MB DIMMs. See “DIMM Sockets” for a list of supported DIMMs.

Plug and Play

The system comes with a Plug and Play BIOS in support of Plug and Play technology. Plug and Play simplifies setup procedures for installing Plug and Play expansion boards. With Plug and Play, adding a Plug and Play expansion board is done by turning off the system, installing the board, and turning on the system. There are no jumpers to set and no system resource conflicts to resolve. Plug and Play automatically configures the board. (Some Plug and Play devices may need to be jumpered if used in a system running the Windows NT[®] operating system.)

ISA Bus

The system board uses the ISA bus for transferring data between the processor and some I/O peripherals and expansion boards. The ISA bus supports 16-bit data transfers and typically operates at 8 MHz.

PCI Local Bus

The 32-bit PCI local bus is the primary I/O bus for the system. The PCI bus is a highly integrated I/O interface that offers the highest performance local bus available for the Celeron or Pentium processor. The bus supports burst modes that send large amounts of data across the bus, allowing fast displays of high-resolution images.

The PCI local bus is a high-performance bus that provides a processor-independent data path between the CPU and high-speed peripherals. The PCI bus is a robust interconnect mechanism designed specifically to accommodate multiple high performance peripherals for graphics and full motion video.

The PCI local bus supports memory transfer rates of over 100 MB per second for reads and over 120 MB per second for writes, depending on processor configuration.

PCI/IDE Ports

The system board supports two high-performance PCI/IDE ports: a primary port and a secondary port on the system board. Each port supports up to two devices for a total of four IDE devices. The primary PCI/IDE port has an enhanced IDE interface that supports PIO Mode 4 devices with 16 MB per second 32-bit wide data transfers on the high-performance PCI local bus. Each port supports Ultra DMA/33.

The installed hard drive is connected to the primary PCI/IDE connector with a three-connector cable. If a CD-ROM drive is included in the system, it is connected to the secondary PCI/IDE port with a three-connector cable. A second device can be added to the primary PCI/IDE port.

Parallel Interface

The system has a 25-pin bidirectional parallel port on the system board. Port specifications conform to the IBM-PC standards. The port supports Enhanced Capabilities Port (ECP) and Enhanced Parallel Port (EPP) modes for devices that require ECP or EPP protocols. The protocols allow high-speed bi-directional transfer over a parallel port and increase parallel port functionality by supporting more devices.

The BIOS has automatic ISA printer port sensing that works with most devices. If the BIOS detects an ISA printer port mapped to the same address, the built-in printer port is disabled. (Verify in the BIOS Setup that printer ports mapped to the same address are enabled or disabled appropriately.) The BIOS also sets the first parallel interface port it finds as LPT1 and the second port it finds as LPT2. The interrupt is set at IRQ7 via the BIOS Setup utility. Software-selectable base addresses are 228h, 378h, and 278h.

Sets of I/O addresses for the parallel port are given in the following table (see Section 2, "System Configuration," for interrupt levels). This is a list of all possible configurations; the parallel port uses only one set.

Parallel Port Addresses

Starting I/O Address	Port
378	LPT1
278	LPT2
228	LPT3
378	LPT1
278	LPT2
228	LPT3

Parallel interface signals are output through the system board's 25-pin, D-subconnector. The connector is located at the back of the system unit.

Serial Interface

The system has two 16C550 UART compatible serial ports (COM1 and COM2) integrated on the I/O controller. The serial ports support the standard RS-232C interface. The buffered high-speed serial ports support transfer rates up to 115.2 KB. These ports allow the installation of high-speed serial devices for faster data transfer rates.

Sets of I/O addresses for the two channels are given in the following table (see Section 2, "System Configuration," for interrupt levels). Soft-selectable base addresses are 3F8h, 2F8h, 3E8h, and 2E8h.

Serial Port 1 and Serial Port 2 I/O Addresses

Starting I/O Address	Port
3F8	COM1
2F8	COM2
3E8	COM3
2E8	COM4
3F8	COM1
2F8	COM2
3E8	COM3
2E8	COM4

See Section 2, "System Configuration," for information on resetting the port through the BIOS Setup utility. See Section 9, "Specifications," for the serial interface specifications.

Serial interface signals are output through the system board's 9-pin, D-subconnectors. The connectors are located at the back of the system unit.

USB Interface

The Universal Serial Bus (USB) ports allow new Plug and Play serial devices to be added without having to open the system. One USB device may be plugged into each USB port for direct system connection. With a hub and the proper cabling, up to 127 USB devices per port can be addressed by the system. The USB determines system resources for each peripheral and assigns them without user intervention. Boot support for a USB keyboard is present so the system can be booted with a USB keyboard instead of a standard keyboard.

Graphics Capabilities

The system supports AGP boards and PCI graphics boards. A PCI graphics board installs in one of the computer's PCI expansion slots. An AGP board installs in the system board's AGP slot.

The following graphics boards are available from NEC CSD:

- ATI Minden (Rage IIC) 4-MB AGP board
This board contains 4 MB of SDRAM.
- ATI XPERT98 (RagePRO) 4-MB AGP board with 4-MB upgrade
This board contains 8 MB of SDRAM.
- Diamond Viper V550 TnT 16 MB AGP graphics board
This board contains 16 MB of video memory.

To view photorealistic images, enhance presentation graphics, and view TV-quality MPEG video, connect a standard VGA-compatible monitor to the AGP board external VGA monitor connector.

Accelerated Graphics Port

The system board contains a 132-pin accelerated graphics port (AGP) slot on the system board that supports graphics-intensive, 3D applications. The AGP operates independently of the PCI bus and supports 133-MHz data transfer rates, allowing 500 MB of data to be transmitted per second.

The AGP is Plug and Play compatible and supports the ATI Minden AGP, ATI XPERT AGP, and Diamond Viper graphics boards available from NEC CSD.

With the graphics board installed in the AGP slot, attach the display monitor to the board's VGA-compatible connector on the rear panel.

Graphics Controller

The graphics controller is specifically designed for graphics-intensive operations, including 3D and 2D effects, texture mapping, text and color pixel amplification, and video acceleration. The controller minimizes bus traffic by off-loading the tasks normally performed by the processor, providing 64-bit, high resolution performance for demanding True Color displays and other sophisticated graphics functions.

Motion Video Controller

The motion video controller integrates a Windows graphical user interface (GUI) engine and motion video playback hardware.

Support includes:

- MPEG-1 or MPEG-2
- Video for Windows
- Active Movie (Windows 95 only).

MPEG is a compression/decompression standard developed by a professional video group called the Motion Picture Experts Group. MPEG produces full-screen, 30-frames-per-second (fps), broadcast-quality digital video.

Integrated Audio

To support the increasing number of multimedia applications, a Creative ES1373 PCI audio chip is integrated on the system board. The chip provides 16-bit stereo, Sound Blaster Pro[®]-compatible audio.

The sound system provides all the digital and analog mixing functions required for playing and recording audio on personal computers. Features include stereo analog-to-digital and digital-to-analog converters, analog mixing, anti-aliasing and reconstruction filters, line and microphone level inputs, digital audio compression, and full digital control of all mixer and volume control functions.

The sound system is standard and has the following features:

- Creative ES1373 chip integrated on system board
- digital audio and analog mixing functions, including stereo analog-to-digital and digital-to-analog converters, analog mixing, anti-aliasing and reconstruction filters, line and microphone level inputs, digital audio compression, and full digital control of mixer and volume control functions
- Adlib[™], Sound Blaster Pro 2.0, Windows Sound System[®], and MPU-401 compatibility.

The Creative ES1373 audio chip includes a full Plug and Play interface. Each logical device is configured into the host environment using the Plug and Play configuration methodologies. The audio subsystem requires two DMA channels and one interrupt.

Resources

The system memory map, I/O addresses, and DMA settings are given in the following sections. System interrupt settings, parallel interrupt settings, and serial interrupt settings are included in Section 2, "System Configuration."

Memory Map

The system memory map is shown in the following table.

System Memory Map		
Memory Space	Size	Function
100000-18000000	383 MB	Extended memory
FC000-FFFFFF	16 KB	Boot block
FA000-FBFFF	8 KB	ESCD (Plug and Play Configuration and DMI)
F9000-F9FFF	4 KB	Reserved for BIOS
F8000-F8FFF	4 KB	OEM logo or Scan User Flash
E8000-E7FFF	64 KB	POST BIOS
E0000-E7FFF	32 KB	POST BIOS (currently available as UMB)
C8000-D7FFF	96 KB	Available HI DOS memory (open to ISA and PCI bus)
A0000-C7FFF	160 KB	Video memory and BIOS
9FC00-9FFFF	1 KB	Extended BIOS data (movable by memory manager software)
80000-9FBFF	127 KB	Extended conventional memory
00000-7FFFF	512 KB	Conventional memory

I/O Addresses

The processor communicates with I/O devices by I/O mapping. The hexadecimal (hex) addresses of I/O devices are listed in the following table.

 **Note:** In Plug and Play systems, these addresses are typical but may vary by configuration.

I/O Address Map

Address (Hex)	I/O Device Name
0000-000F	PIIX4 - DMA controller 1 (channel 0-3)
0020-0021	PIIX4 - interrupt controller 1
002E-002F	Super I/O controller configuration registers
0040-0043	PIIX4 - counter/timer 1
0048-004B	PIIX4 - counter/timer 2
0060	Keyboard controller byte - reset IRQ
0061	PIIX4 - NMI, speaker control
0064	Keyboard controller, command/status byte

I/O Address Map

Address (Hex)	I/O Device Name
0070, bit 7	PIIX4 - enable NMI
0070, bits 6 through 0	PIIX4 - real time clock, address
0071	PIIX4 - real time clock, data
0078-0079	Reserved - board configuration
0080-008F	PIIX4 - DMA page registers
00A0-00A1	PIIX4 - interrupt controller 2
00B2-00B3	APM control
00C0-00DE	PIIX4 - DMA controller 2
00F0	Reset numeric error (numeric data processor)
0170-0177	Secondary IDE channel
01F0-01F7	Primary IDE channel
0200-0207	Audio/game port
0220-022F	Audio (Sound Blaster compatible)
0240-024F	Audio (Sound Blaster compatible)/alternate
0278-027F	Parallel port 2
0290-0297	Hardware monitor
02E8-02EF	COM4/video (8514A)
02F8-02FF	COM2
0300-0301	MPU-401 (MIDI)/alternate
0330-0331	MPU-401 (MIDI)/alternate
0332-0333	MPU-401 (MIDI)/alternate
0334-0335	MPU-401 (MIDI)/alternate
0376	Secondary IDE channel command port
0377	Floppy channel 2 command
0377, bit 7	Floppy disk change, channel 2
0377, bits 6 through 0	Secondary IDE channel status port
0378-037F	Parallel port 1
0388-038D	AdLIB (FM synthesizer)
03B4-03B5	Video (VGA)
03BA	Video (VGA)
03BC-03BF	Parallel port 3
03C0-03CA	Video (VGA)
03CC	Video (VGA)

I/O Address Map

Address (Hex)	I/O Device Name
03CE-03CF	Video (VGA)
03D4-03D5	Video (VGA)
03DA	Video (VGA)
03E8-03EF	COM3
03F0-03F5	Floppy channel 1
03F6	Primary IDE channel command port
03F7 (write)	Floppy channel 1 command
03F7, bit 7	Floppy disk change channel 1
03F7, bit 6 through 0	Primary IDE channel status port
03F8-03FF	COM1
04D0-04D1	Edge/level triggered PIC
0530-0537	Windows Sound System
0604-060B	Windows Sound System
LPT n + 400h	ECP port, LPT n base address + 400h
0CF8-0CFB*	PCI configuration address register
0CF9**	Turbo and reset control register
0CFC-0CFF	PCI configuration data register
0E80-0E87	Windows sound system
0F40-0F47	Windows sound system
0F86-0F87	Creative Audio configuration
FF00-FF07	IDE bus master register
FFA0-FFA7	Primary bus master registers
FFA8-FFAF	Secondary bus master registers

* Only accessible by DWORD accesses.

** Byte access only.

DMA Settings

The system's DMA settings are given in the following table.

DMA Setting	Device
0	Audio
1	Audio/parallel port
2	Diskette drive
3	Parallel port (for ECP or EPP)/audio
4	Reserved — cascade channel
5	Available
6	Available
7	Available

* In Plug and Play systems, these settings are typical but may vary by configuration.

5

Illustrated Parts Breakdown

- Ordering Parts
- Field Replaceable Unit List
- Illustrated Parts Breakdown

This section contains the illustrated parts breakdown (IPB) and NEC CSD part descriptions for the PowerMate VT 300i Series Build-to-Order (BTO) systems.

The following tables list

- telephone numbers for ordering system parts and options
- field-replaceable parts for the system.

The PowerMate VT 300i Series system illustrated parts breakdown figure is at the end of this section.

Ordering Parts

Use the telephone numbers in the following table to order spare parts.

<i>Ordering Parts</i>	
Items	Telephone Number
To order spare parts (Dealers)	1-800-632-4525
To order spare parts (Customers)	In the U.S. 1-800-233-6321 In Canada 1-800-727-2787

Field Replaceable Unit List

The following table lists the field replaceable units (FRUs) for the PowerMate VT 300i Series of computers.

PowerMate VT 300i Series System FRU List

Item	Description
1a	Microsoft IntelliMouse
1b	Logitech 3-Button Mouse
2	Keyboard, Chicony, Ergo
3	Power Cable
4	Diskette Drive Signal Cable, 3-connector
5	IDE Hard Drive Cable, 3-connector
6	CD-ROM Signal Cable, 3-connector
7	Audio Cable
8	System Board (MS-6156) with Onboard Audio
9a	32-MB SDRAM (4 MB x 64) DIMM
9b	64-MB SDRAM (8 MB x 64) DIMM
9c	128-MB SDRAM (16 MB x 64) DIMM
10	Coin-cell Battery
11	Retention Mechanism Top Bar (Celeron/Pentium II only)
12a	CPU Assembly Retention Mechanism (Celeron and Pentium III)
12b	CPU Assembly Retention Mechanism (Pentium II)
13a	300-MHz Celeron Processor CPU Assembly
13b	333-MHz Celeron Processor CPU Assembly
13c	366-MHz Celeron Processor CPU Assembly
13d	400-MHz Celeron Processor CPU Assembly
13e	433-MHz Celeron Processor CPU Assembly
13f	350-MHz Pentium II Processor CPU Assembly
13g	400-MHz Pentium II Processor CPU Assembly
13h	450-MHz Pentium II Processor CPU Assembly
13i	450-MHz Pentium III Processor CPU Assembly
13j	500-MHz Pentium III Processor CPU Assembly
14a	ATI Minden RAGE IIC 4 MB AGP Graphics Board
14b	ATI XPERT98 RAGE PRO 8-MB AGP Graphics Board
14c	Diamond Viper V550 TnT 16-MB AGP Graphics Board
15a	3Com USR Python V.90 PCI, 56 Kbps Modem Board
15b	PCI Win 56 Kbps Modem Board (MDM100)
16a	3Com Hurricane 10/100 Network Board
16b	Intel Ethernet Pro 100 Network Board

PowerMate VT 300i Series System FRU List

Item	Description
16c	GVC 10/100 Network Board
17	Chassis Cover, Left Side
18	Chassis Cover, Right Side
19	Front Panel (complete assembly)
20	Plastic Blank Panel – 5-1/4 inch
21	Logo, NEC PowerMate
22	Speaker Power Adapter
23	10-Watt Speakers w/Cables and Power Adapter, Harman/Kardon
24a	Power Supply, 90 Watt
24b	Power Supply, 145 Watt
25	USB Connector Bracket
26	USB Circuit Board
27	Power Switch Assembly
28a	Lite-On 32X CD-ROM drive (LTN-301)
28b	NEC 32X Max CD-ROM Drive (CDR-3000A)
28c	Lite-On 40X CD-ROM Drive (LTN-382) (when available)
29	Diskette Drive, without Bezel
30	PCMCIA – 3.5 Inch Drive Bay Adapter
31	Iomega 100-MB Zip Drive (IDE)
32	PCMCIA – 3.5 Inch Drive
33a	Hitachi 4X DVD-ROM Drive (GD-2500)
33b	Hitachi 6X DVD-ROM Drive (when available)
34a	4.3-GB IDE Hard Drive, Maxtor Ultra DMA
34b	8.4-GB IDE Hard Drive, Maxtor Ultra DMA
34c	12.9-GB IDE Hard Drive, Seagate Ultra DMA
Not Shown	Fan Assembly
Not Shown	8-GB Tape Backup Drive, Seagate (STT8000A)
Not Shown	RJ-11 Cable
Not Shown	PowerMate VT 300i Series User's Guide

Illustrated Parts Breakdown

The following figure shows the illustrated parts breakdown (IPB) for the PowerMate VT 300i Series computers. Each FRU on the IPB is identified with a number that cross-references the FRU list.

PowerMate VT 300i Series Computer Illustrated Parts Breakdown

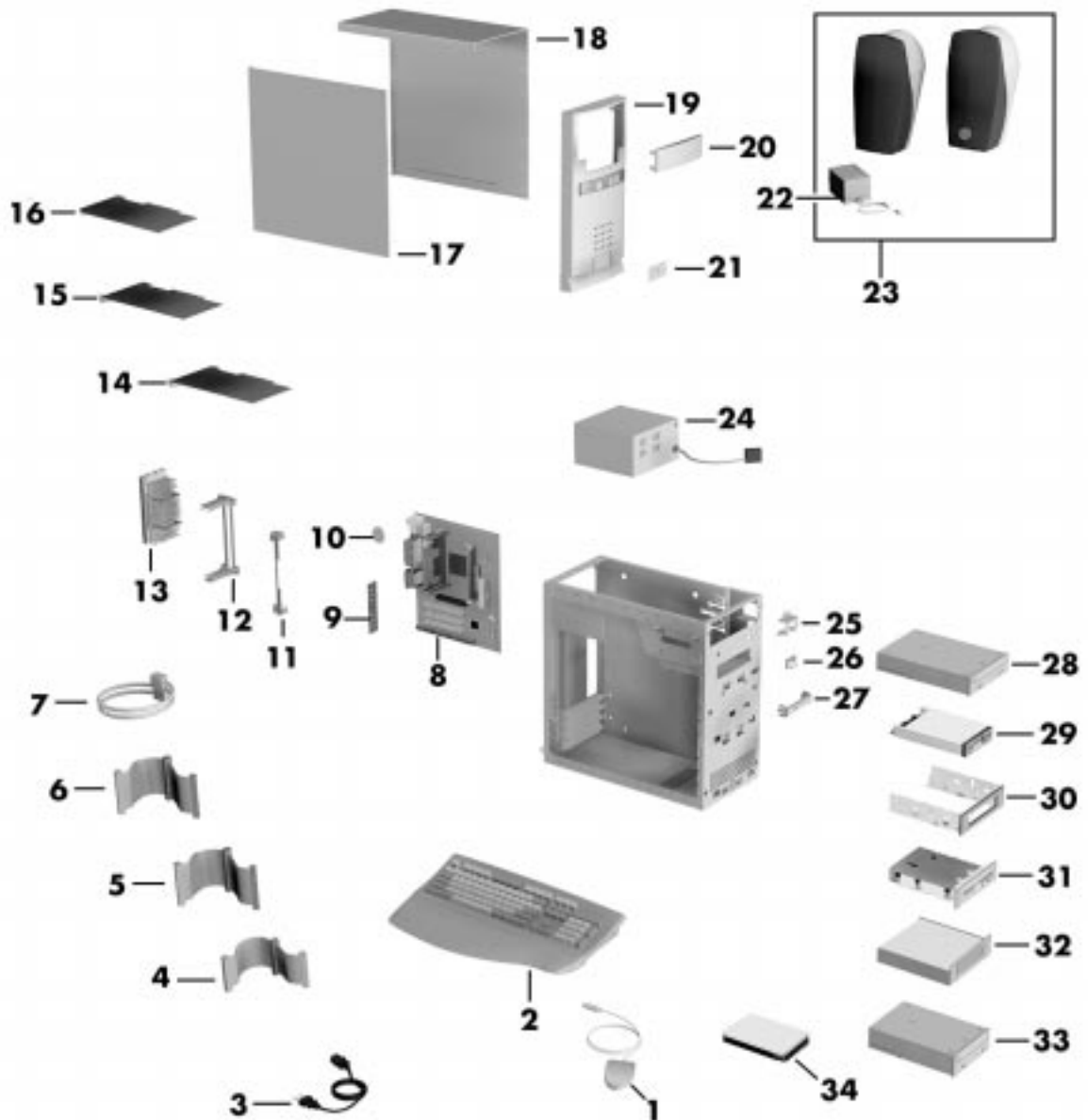

6

Preventive Maintenance

- System Cleaning
- Keyboard Cleaning
- Mouse Cleaning

This section contains general information for cleaning and checking the system, keyboard, and monitor.

The system unit, keyboard, and monitor require cleaning and checking at least once a year, and more often if operating in a dusty environment. No other scheduled maintenance is required.

 **WARNING**

Unplug all power cords before performing any maintenance. Voltage is present inside the system and monitor even after the power is off. All voltage is removed only when the power cord is unplugged.

System Cleaning

Use the following procedure for cleaning the system.

1. Power off the system and unplug all power cables.
2. Wipe the outside of the system, keyboard, mouse, and monitor with a soft, clean cloth. Remove stains with a mild detergent. Do not use solvents or strong, abrasive cleaners on any part of the system.
3. Clean the monitor screen with a commercial monitor screen cleaning kit. As an alternative, use a glass cleaner, then wipe with a clean lint-free cloth.
4. Local distributors and dealers may sell diskette drive head cleaning kits. These kits contain special diskettes and cleaning solution. Do not use the abrasive head cleaning kits (kits without cleaning solution).

Insert the diskette immediately after powering on the system, before disk bootup. Allow the diskette drive heads to clean for about 30 seconds.

Keyboard Cleaning

As necessary, inspect and clean the inside of the keyboard as follows.

1. Turn the keyboard over and remove the screws holding the keyboard enclosure together.

 **CAUTION**

The keyboard and cable together are considered a whole-unit, field-replaceable assembly. Therefore, disassembly of the keyboard is necessary only when cleaning the inside.

2. Separate the two halves of the enclosure.

-
3. Clean the enclosure and keys with a damp cloth. A small, soft-bristle brush may be used to clean between the keys.

Do not wet or dampen the keyboard's printed circuit board. If the board gets wet, thoroughly dry it before reattaching the keyboard to the system unit.

Mouse Cleaning

The mouse has a self-cleaning mechanism that prevents a buildup of dust or lint around the mouse ball and tracking mechanism under normal conditions. Periodically, however, the mouse ball must be cleaned. Use the following procedure to clean the mouse.

1. Unplug the mouse from the system.
2. Turn the mouse upside down and locate the ball cover.
3. Turn the ball cover counterclockwise and remove the cover.

Removing the Mouse Ball Cover

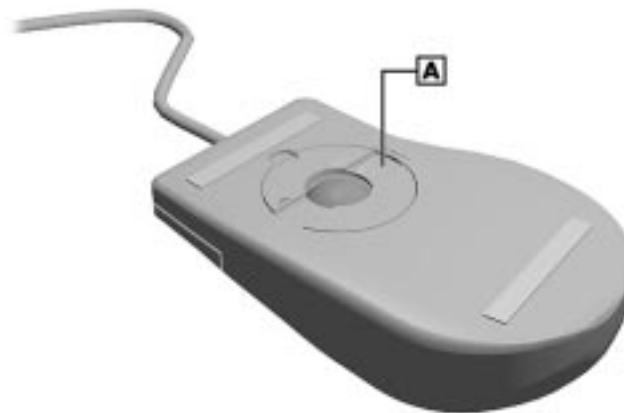

A – Mouse Ball Cover

4. Turn the mouse over and remove the ball.
5. Clean the mouse as follows:
 - Clean the mouse ball with tap water and a mild detergent, then dry it with a lint-free cloth.
 - Remove any dust and lint from the mouse socket.
6. Replace the mouse ball in its socket.
7. Replace the ball cover and turn it clockwise until it locks in place.

7

Troubleshooting

- Checklist
- Diagnostics

This section provides information to help isolate and repair system malfunctions at the field level. The system has a built-in program that automatically checks its components when the system is powered on. If there is a problem, the system displays an error message. If this happens, follow any instructions on the screen.

If screen messages do not help or an error message does not appear, refer to the information in this section to help determine and correct the problem. For the more common problems, refer to “Checklist” for assistance. If the information in the checklist does not help, refer to “Diagnostics ” for more detailed problem solving.

If disassembly is required, see Section 3, “Disassembly and Reassembly.” Jumper settings are given in Section 2, “System Configuration” and in Section 4, “System Board.”

Checklist

Check the following list for a match to the system problem and the possible cause and solution.

System Problems

- **No power and power lamp not lit.**

Check that all power switches are on.

Check that the power cable is plugged into the system power socket and that the other end is plugged into a live, properly grounded AC power outlet or surge protector.

Check the outlet or surge protector by plugging in a lamp.

- **Non-System Disk error message displays when the system is started.**

A diskette is in the diskette drive, and the diskette drive is set before the hard drive in boot order. Remove the diskette from drive A and restart the system.

- **Operating system not found error message displays when the system is started.**

If a CD is left in the CD-ROM drive, the system may not be able to boot. Try removing the CD and rebooting.

The hard drive might need more time to spin up before the system boots. Change the “Hard Disk Pre-Delay” to a higher setting from the BIOS Setup utility.

- **System does not boot and error message displayed on screen.**

Run the Setup utility (see Section 2, “System Configuration”). Check that the parameters are set correctly, particularly if you just installed an option.

- **System emits continuous beeps.**

Turn the system off, wait at least five seconds, and turn the system on. If the beeps continue, call the NEC CSD Technical Support Center.

- **System does not maintain date, time, system configuration information.**

Change the battery (see “Battery Replacement” in Section 3, “Disassembly and Reassembly”).

- **System does not boot from hard drive.**

The system usually tries to start from the diskette drive before it starts from the hard drive. Remove the diskette from the diskette drive.

Run the Setup utility (see Section 2, “System Configuration”) and set the initial Boot parameter to Hard Drive instead of Removable Device.

- **System does not boot immediately after hard drive spins up.**

The “Hard Disk Pre-Delay” in the BIOS Setup utility can be changed to a lower setting. (If a message “operating system not found” appears after changing the setting, the delay is set too low. Set the hard disk pre-delay slightly higher.)

- **System performance appears sluggish.**

Check that the system is set for optimal operation. See the operating system documentation.

Check the memory requirements of the software applications. If required, install additional DIMM memory.

If optional DIMM memory was added, check that it is correctly installed.

- **System password forgotten.**

Clear the password and reset it. See “Clearing the CMOS and Password” in Section 4, “System Board.”

- **Microsoft Windows does not recognize the Pentium III processor**

Windows incorrectly identifies the Pentium III processor as a Pentium II or Pentium Pro on the General tab of the Windows System Properties sheet. This does not effect in any way the performance of the Pentium III processor. The system BIOS correctly detects the Pentium III processor at startup. A patch can be obtained to fix the identification in the General tab. Check for the patch at Microsoft’s website (www.microsoft.com) or the NEC CSD website (www.nec-computers.com).

Diskette Drive Problems

Check the following to see the possible cause and solution.

- **Diskette won't load.**

Check that the diskette is being loaded correctly.

Check that the system and monitor power lamps are on and the power-on screen appears.

Check that the diskette is formatted. If not, format it. See the operating system documentation.

Check that the diskette size is 1.44 MB.

If the diskette drive busy lamp does not light when loading the diskette, try a different diskette. If this loads, the problem is in the software.

- **Non-System Disk or Disk Error message displayed.**

If trying to boot from the diskette drive, insert a diskette with system files into drive A.

If a bootable diskette does not boot, use the Setup utility to verify that the initial boot parameter is set to diskette drive A and not a hard drive.

Monitor Problems

Check the following problems to see the possible cause and solution.

- **Monitor screen is dark or the display is hard to read.**

Check that the monitor is on.

Check that the monitor power cable is connected to the monitor and a power outlet, the monitor signal cable is connected to the system, and the brightness and contrast controls are adjusted.

Press the space bar or move the mouse to take the system out of the power management mode.

- **Distorted image appears on the monitor screen.**

Adjust the monitor's video controls. If this does not help, turn the monitor off for several seconds, then back on.

- **There is constant movement on the screen.**

A magnetic field is affecting the monitor. Move any devices (fan, motor, another monitor) that generate magnetic fields away from the monitor.

- **The screen display is fuzzy or flickering; graphics characters or garbage appears on the screen.**

Check that the monitor is set up correctly and that all connections have been made.

Check that the video refresh rate and video driver are correct.

Click the right mouse button anywhere on the Windows desktop and a menu appears. Click **Properties** and the Display Properties window appears.

Keyboard/Mouse Problems

Check the following problem to see the possible cause and solution.

- **Mouse or keyboard does not respond.**

The mouse and keyboard may have been connected after turning on the system. Turn the system off, make sure the mouse and keyboard are connected, and turn the system back on.

- **Image appears on screen but nothing happens when using the mouse or keyboard.**

Make sure the keyboard or mouse cable is firmly connected to the rear of the system.

If this does not help, turn off the system, wait five or more seconds, and turn on the system.

CD-ROM Drive Problems

Check the following problems to see the possible cause and solution.

- **The system does not see the CD-ROM drive.**

The drive designation is wrong and should be changed. The drive designation for the CD-ROM drive depends upon the storage device configuration in the system. To find out what drive designation letter is assigned to the CD-ROM drive, double click **My Computer** on the Windows 95 or Windows NT 4.0 desktop. The drive designation is below the CD-ROM drive icon.

As an alternative, open Windows Explorer and scroll down the list of folders until you locate the CD-ROM drive icon. The drive designation is beside the icon.

- **The CD-ROM drive is not reading a disc.**

Check that the disc is inserted in the CD tray with the printed label side up.

Check that the disc is a data disc, not a music disc.

Try a different CD to see if the problem is limited to one CD.

- **The CD does not eject due to a power failure or software error.**

Turn off the system and use the CD-ROM emergency eject feature. Insert the end of a paper clip into the eject hole. Press inward on the clip to open the door.

-
- **The CD-ROM drive plays music CDs but the sound is not heard. However, .WAV and .MIDI sounds can be heard when played.**

Check that the cable connecting the CD-ROM drive to the system board CD audio connector is in place and secure.

Check the CD Audio volume setting.

Speaker Problems

Check the following problems to see the possible cause and solution.

- **No sound from the speakers.**

Check that the speaker power is on. Verify that all speaker cable connections are correct and secure.

Check that the power adapter is connected to the power source and the speaker.

- **Speaker volume is too low.**

Adjust the volume control on the speaker. If the volume is still too low, adjust the volume through the system software. See the Windows Multimedia online help.

- **Sound is only coming from one speaker.**

Balance the speaker output by adjusting the balance in the sound software. See the Windows Multimedia online help.

Diagnostics

One beep indicates that the system has completed its POST test. If intermittent beeping occurs, power off the system and try again. If the beeping persists, see the following table. The table summarizes problems that may develop during system operation and lists (in sequential order) suggested corrective actions.

Problems and Solutions

Problem	Symptom	Solution
No power	Power lamp on computer front panel does not light.	<ol style="list-style-type: none">1. Check that the power cord is plugged into the power socket on the computer. Check that the other end of the cord is plugged into a live, properly grounded AC power outlet.2. Check cable connections between the power supply and system board and between the system board and power switch.3. Systematically eliminate possible shorted PCBs by removing cables and expansion boards.

Problems and Solutions

Problem	Symptom	Solution
No power (cont'd)		<ol style="list-style-type: none"> 4. Check +5 and +12 power supply voltages. Measure voltages with system board installed. 5. Replace the power switch assembly. 6. Replace the power supply. 7. Replace the system board.
Power supply malfunction	<p>Any of the following conditions could occur:</p> <p>Front panel lamps out, diskette and/or hard drives do not spin, monitor blank, interface ports not working, and keyboard lamp out and/or cannot input from keyboard.</p>	<ol style="list-style-type: none"> 1. Perform steps 1 through 4 listed in this table under No Power. 2. Check power supply voltages. Voltages should be measured with a load on them (system board plugged in). 3. Replace the power supply.
Operating system does not boot	<p>Intermittent beeping at power-on. Computer beeps more than once and is unable to complete boot-up.</p> <p>“Invalid Configuration” message displayed.</p> <p>Computer halts during loading sequence.</p>	<ol style="list-style-type: none"> 1. Check system configuration (see Section 2). 2. Check all jumper settings and verify that drives are enabled (see Section 2). 3. Reseat DIMMs and option boards in their connectors. Inspect system board for foreign objects such as paper clips. 4. Remove option boards and reboot. 5. Replace system board. <ol style="list-style-type: none"> 1. Press F2 to run Setup and correct the parameters. 2. Replace the CMOS battery (see Section 3) if the date and time must be set each time the computer is powered on. <ol style="list-style-type: none"> 1. Power the computer off. Check for proper jumper settings (see Section 2), then power-on the computer. 2. Check condition of selected bootload device (diskette, disc, or hard disk) for bad boot track or incorrect OS files. 3. Try booting OS from diskette or disc, or recopy OS files onto hard disk. 4. Verify correct hard disk is selected.

Problems and Solutions

Problem	Symptom	Solution
Diskette drive does not work	Lamp on drive panel does not light when diskette is loaded.	<ol style="list-style-type: none">1. Check power and signal cable connections between diskette drive and power supply.2. Check diskette drive cable. Replace as necessary.3. Check power supply.4. Replace diskette drive.5. Replace system board.
Hard drive malfunction	Hard drive lamp does not light but hard drive can be accessed.	<ol style="list-style-type: none">1. Check cable connections between lamp and system board.
	Hard drive controller failure message displayed.	<ol style="list-style-type: none">1. Check that the IDE channel and hard drives are enabled in Setup (see Section 2).
	Cannot access hard drive.	<ol style="list-style-type: none">1. Check signal/power connections between hard disk, PCB, power supply.2. Check hard drive jumper settings.3. Check power supply.4. Check hard drive cable and hard drive. Replace as necessary.5. Replace system board (or hard drive controller PCB if the system board controller is not used).
Memory malfunction	Total memory not recognized.	<ol style="list-style-type: none">1. Reseat DIMMs.2. Systematically swap DIMMs.3. Check to see if the DIMM configuration is valid (see Section 4).4. Replace DIMMs.5. Replace system board.
Modem board malfunction	No output from board.	<ol style="list-style-type: none">1. Check interrupts (see Section 2).2. Check DMA channels (see Section 4).
Keyboard or mouse malfunction	Monitor has prompt, but cannot input data using keyboard or mouse.	<ol style="list-style-type: none">1. Check keyboard/mouse plugged in.2. Check password (see Section 2).3. Disable password (see Section 2).4. Replace keyboard (or mouse).5. Replace system board.

Problems and Solutions

Problem	Symptom	Solution
Monitor malfunction	Unable to synchronize display.	<ol style="list-style-type: none">1. Adjust the monitor's synchronization controls.2. Check that the monitor's resolution matches the video setting or the video driver used (see Section 2).3. Check that the utility is not selecting a refresh rate/resolution that is not supported by the monitor.4. Check that the driver used matches the capabilities of the built-in video controller and DRAM.
	Wavy display.	<ol style="list-style-type: none">1. Check that the computer and monitor are not near motors or electric fields.
	Blank display.	<ol style="list-style-type: none">1. Press any key or move the mouse to ensure power management has not blanked the display.2. Check that the monitor power ON/OFF switch is ON.3. Check that the monitor cable is attached to the video connector at the back of the system.4. Check cable connections between the AC power supply and monitor.5. Adjust brightness and contrast controls on the monitor.6. Check cable connections between the monitor connector and the graphics board.7. Replace graphics board.8. Replace monitor.
CD-ROM drive malfunction	System power not on.	<ol style="list-style-type: none">1. Turn system power on.
	Disc tray does not open.	<ol style="list-style-type: none">1. System power not on. Turn system power on.2. System power failed. Insert the end of a straightened paper clip into the emergency eject hole, then gently press inward until the tray opens.

Problems and Solutions

Problem	Symptom	Solution
CD-ROM drive malfunction (cont'd)	No sound from CDs.	<ol style="list-style-type: none">1. Check that speaker power is on and volume is adjusted.2. Check audio software settings.3. Check the CD.4. Check the CD-ROM drive audio cable connections.5. Check the CD-ROM drive audio cable. Replace as necessary.6. Replace the CD-ROM drive.7. Replace the optional sound board.8. Replace the system board.
	Cannot access CD-ROM drive.	<ol style="list-style-type: none">1. Check that the CD-ROM driver software is loaded and not corrupted.2. Check signal and power connections between the CD-ROM drive, system board, and power supply.3. Check the master/slave jumper settings (see Section 2).4. Check the IDE cable. Replace as necessary.5. Check the power supply. Replace as necessary.6. Check the system board. Replace as necessary.7. Check the sound board. Replace as necessary.
Communication error	Bad data or no data when communicating.	<ol style="list-style-type: none">1. Check cable connections between system board and device.2. Check that the interface port is selected.3. Test or replace the device and interface cable (see the device documentation for troubleshooting).4. Replace the system board.

8

NEC CSD Information Services

- Service Telephone Numbers
- Technical Support
- Product Information

This section contains the following NEC CSD service and support information:

- service and support telephone numbers
- technical support
- product information.

Service Telephone Numbers

The following table lists the telephone numbers for the NEC CSD service and support functions.

NEC CSD Service and Support Telephone Numbers

Service	Telephone Numbers
To contact NEC CSD Technical Support Center (TSC):	In the U.S. and Canada, call 1 (800) 632-4525
To order spare parts (Dealers):	Call 1 (800) 632-4525
To order spare parts (Customers):	In the U.S., call 1 (800) 233-6321 In Canada, call 1 (800) 727-2787
To contact Customer Service about service and contract warranty issues:	Call 1 (800) 632-4525
To log onto the NEC CSD Electronic Bulletin Board System (BBS) to download software drivers and the latest BIOS for ROM flashing:	Call 1 (916) 379-4499
To send technical questions by email:	tech-support@neccsd.com
To fax technical questions to customer support:	In the U.S., fax 1 (801) 981-3133
To access the NEC CSD website:	www.nec-computers.com
To access the NEC CSD FTP site:	ftp.neccsdeast.com

Technical Support

The following sections provide information for obtaining technical support from NEC CSD. With access to a telephone, modem, and/or fax machine, you can use these services to obtain information on a 24-hour basis.

NEC CSD Website

If you have a modem or a network board and an Internet Service Provider account, you can access the NEC CSD website. The NEC CSD website contains service and support information, information about NEC CSD and its products, an online store, press releases, and reviews.

Look in the Service and Support area for the following:

- technical documentation, including Frequently Asked Questions, service and reference manuals, and warranty information

-
- BIOS updates, drivers, and setup disk files to download
 - contact information, including telephone numbers for Technical Support and links to vendor websites
 - an automated email form for your technical support questions
 - a Reseller's area (password accessible).

To access the NEC CSD Home Page, enter the following Internet Uniform Resource Locator (URL) in your browser:

www.nec-computers.com

Email/Fax Technical Support Service

The NEC CSD Technical Support Center offers technical support by email over the Internet network if you have a modem. The email address is:

tech-support@neccsd.com

You can also fax technical questions to the NEC CSD Technical Support Center if you have access to a fax machine or fax/modem. The fax number is:

1 (801) 981-3133

When using the email or fax support service, please include one of the following words in the subject field for prompt response from the appropriate technical person:

- Desktop
- Monitor
- CD-ROM
- Printer
- Notebook.

Provide as much specific information in your questions as possible. Also, if sending a fax, please include your voice telephone number and your fax number with the question. You will receive a response to your questions within one business day.

Technical Support Services

NEC CSD also offers direct technical support through its Technical Support Center. (NEC CSD technical support is for U.S. and Canadian customers only; international customers should check with their sales provider.)

Direct assistance is available 24 hours a day, 7 days a week. Call the NEC CSD Technical Support Center, toll free, at **1 (800) 632-4525** (U.S. and Canada only) for the following support.

- System hardware — toll-free phone support is limited to the length of the standard warranty.

For hardware support after the standard warranty, get system hardware support for a fee.

- Preinstalled software — toll-free phone support for 90 days from the time of your first call to the NEC CSD Technical Support Center.

After the initial 90 days, get preinstalled software support for a fee.

Please have available your system's name, model number, serial number, and as much information as possible about your system's problem before calling.

For callers outside the U.S. and Canada, please contact your local NEC CSD sales provider.

Product Information

In addition to the NEC CSD website, you can find product information at the NEC CSD FTP site and through the NEC CSD Bulletin Board Service. With access to a telephone, modem, and/or fax machine, you can use these services to obtain information on a 24-hour basis.

NEC CSD FTP Site

You can use the Internet to access the NEC CSD FTP (file transfer protocol) site to download various files (video drivers, printer drivers, BIOS updates, and setup disk files). The files are essentially the same as on the NEC CSD website and the NEC CSD Bulletin Board Service.

To access the NEC CSD FTP site, enter the following Internet ftp address through your Internet Provider service:

ftp.neccsdeast.com

Once in the file menu, follow the prompts to choose and download the file(s) you want.

NEC CSD Bulletin Board Service

If you have access to a modem, you can use the NEC CSD Bulletin Board Service (BBS) to get the latest information on hardware and software. The BBS allows you to download files (video drivers, printer drivers, BIOS updates, etc.) to a diskette for system enhancements and upgrades.

 **CAUTION**

NEC CSD recommends that you download files from the Bulletin Board Service to a diskette and not to your hard drive.

Log onto the BBS as follows.

1. From the Windows desktop, click **Start**.
2. Point to **Programs**. Point to **Accessories** and then click **HyperTerminal**.
3. Double click the **Hypertrm.exe** icon. The HyperTerminal program appears.
4. Follow the instructions on the screen to set up your modem. Click the **HyperTerminal** help button for information about dialing the phone number.

If you need to check communications settings, check that the settings match the following BBS parameters.

- **Baud rate:** select any baud rate that matches your modem
 - **Parity:** none
 - **Data bits:** 8
 - **Stop bits:** 1
 - **Flow control:** Xon/Xoff (select Hardware if using 14.4 Kbps or higher).
5. Following the HyperTerminal instructions, enter the BBS phone number (**916-379-4499**). Your business phone system and/or location might require a **9 1** or **1** prefix.

 **Note:** The first time that you use the BBS, you are requested to provide information for a new user questionnaire.

6. Press **Enter** twice.
7. Enter your first name, last name, and password. Press **Enter** after each.
8. Follow the screen prompts until the Main Menu is displayed.
9. At the Main Menu, select **J** to join a conference. Select **Conference 1** for the desktop conference.
10. From the Main Menu, press **F** and **Enter** for the File menu.
11. At the File menu, select **F** for a list of downloadable files.

-
- Follow the prompts to select a file for downloading.

 **CAUTION**

Executable files automatically format your diskette when you download files from the BBS. Formatting destroys any data on the diskette. Before you download files from the BBS, check that you do not have information on the diskette that you need.

- After you complete downloading your file, log off the BBS as follows.
12. Press **Enter** (to continue).
 13. Press **G** (command for Goodbye/Hangup).
 14. Press **Enter**.

9

Specifications

- System Board
- Keyboard
- Mouse
- Speakers
- System Unit
- Diskette Drive
- Hard Drives
- Power Supply
- Fax/Modem Board
- Graphics Boards
- CD-ROM Drives
- PC Adapter Unit
- Tape Backup Unit
- Zip Drive
- Environmental and Safety

This section contains the specifications for the various components comprising the PowerMate VT 300i Series systems. The following table lists the specifications and the pages where the specifications can be found.

System Specifications

Specification	Go to Page
System board	9-3
Keyboard	9-3
Mouse	9-4
Speakers	9-4
Diskette drive	9-5
Hard drives	9-6
Power supply	9-10
Fax/modem board	9-11
Graphics boards	9-12
CD-ROM drives	9-14
PC adapter device	9-15
Tape backup unit	9-16
Zip drive	9-17
Environmental and safety	9-18

System Board Specifications

The specifications for the system board are included in the following table.

System Board Specifications

Feature	Specification
System Board	MS-1656 μ ATX board with AGP connector and integrated audio
Processor	<i>Celeron</i> 300A-, 333-, 366-, 400-, or 433-MHz processor <i>Pentium II</i> 350-, 400-, or 450-MHz processor <i>Pentium III</i> 450- or 500-MHz processor
Cache Memory	32 KB of primary cache (16-KB data, 16-KB instruction) integrated in the processor 512 KB (128 KB for Celeron) of secondary cache built-in on processor
Flash ROM	2 Mb Flash ROM
Chip Set	Intel 440ZX AGPset
I/O Controller	Winbond W83977TF Super I/O controller
System Memory	16 MB to 256 MB in two DIMM sockets on system board
Optional DIMMs	16-MB, 32-MB, 64-MB, and 128-MB (as available); 168-pin, 64-bit (non-ECC) DIMMs
Video Memory	Video Memory — 4 MB to 16 MB of 100-MHz SGRAM
Audio Chip	Creative ES1371/ES1373
Battery	Replaceable coin-type battery

Keyboard Specifications

The specifications for the keyboard are included in the following table.

Keyboard Specifications

Feature	Specification
Keyboard	Chicony KB-8923
Dimensions	Width: 19.0 inches (48.3 cm) Depth: 8.4 inches (21.3 cm) Height: 1.6 inches (4.1 cm)
Weight	3.5 to 4.0 lb. (1.6 to 1.8 kg)

Mouse Specifications

The specifications for the mouse are included in the following table.

Mouse Specifications

Feature	Specification
Mouse	Microsoft IntelliMouse
Features	2-button with cursor movement wheel X & Y encoder resolution: 400 PPI opto-mechanical Wheel Resolution: zoom resolution 18 counts per revolution
Operating Characteristics	Vin = 115 V or 230 V as appropriate Ta = 25° Thermal stabilization - 1 hour minimum
Physical Features	Length: 4.53 inches Width: 2.6 inches Height: 1.52 inches Weight: 170 grams +/- 20 grams
Temperature Range	Operating: 5° to 35° C Storage: -20° to 60° C

Speaker Specifications

The specifications for the speaker are included in the following table.

Speaker Specification

Feature	Specification
Speakers	Harman/Kardon
Features	Magnetically shielded 10-watt stereo speakers Power on/off/volume switch 15-volt AC power adapter
Performance	Frequency response, 90-20 kHz, 2 dB Sensitivity, 300 mV Output power, 4.5 watts

System Unit Specifications

The specifications for the system unit are included in the following table.

System Unit Specifications

Feature	Specification
Dimensions	Width: 8.5 inches (21.59 cm) Depth: 18 inches (45.72 cm) Height: 17 inches (43.18 cm)
Weight	Starting at 28 lb. (11.78 kg) dependent upon options
Device Slots	Two 5 1/4-inch front accessible slots One 3 1/2-inch front accessible slot Two 3 1/2-inch internal slots
Expansion Board Slots	Four slots: one AGP slot two 32-bit PCI slots one shared PCI/ISA slot
Peripheral Interface (rear panel)	PS/2-style keyboard connector PS/2-style mouse connector Two RS-232C serial ports Parallel printer port VGA monitor port Two universal serial bus ports Three audio connectors
Front Panel	Power/sleep button Power/sleep indicator lamp Hard drive busy indicator lamp

Diskette Drive Specifications

The specifications for the diskette drive are included in the following table.

Diskette Drive Specifications

Feature	Specification
Diskette Drive	Samsung Diskette Drive SFD-321B
Recording Capacity	High density mode: Unformatted: 2.00/1.00 MB Formatted: 1440 KB (512B 18 Sec) 720 KB (256B 18 Sec) Normal density mode: Unformatted: 1.00/0.50 MB Formatted: 640 KB (256B 16 Sec) 320 KB (128B 16 Sec)

Diskette Drive Specifications

Feature	Specification
Data Transfer Rate	High density mode: 500/250 Kbit/sec Normal density mode: 250/125 Kbit/sec
Disk Speed	300 rpm
Number of Tracks	160 (80 tracks x 2 sides)
Temperature	Operating: 4° to 46°
Relative Humidity	20° to 80°
Dimensions (W x H x D)	25.4 mm x 101.6 mm x 146 mm
Weight	430 grams (typical)

4.3-GB Seagate Hard Drive Specifications

The specifications for the 4.3-GB Seagate hard drive are included in the following table.

4.3-GB Seagate Hard Drive Specifications

Feature	Specification
Hard Drive	4.3-GB Seagate
Formatted Capacity	4300 GB
Nominal Rotational Speed	5,400(rpm)
Number of Disks	1
Number of R/W Heads	2
Buffer Size	512 KB
Power	+5V +/-5%; 100 mV peak-to-peak allowable ripple/noise 12V +/-10%; 250 mV peak-to-peak allowable ripple/noise
Temperature (non-condensing)	Operating: 5° to 55° C (41° to 131°F) Non-operating: -40° to 70°C (-40° to 158°F)
Humidity (non-condensing)	Operating: 5% to 90% rh, 30°C (86°F) Non-operating: 5% to 95% rh, 40°C (104°F)
Altitude	Operating: -122 m to 3,048 m (-400 to 10,000 ft.) Non-operating: -122 m to 12,192 m (-400 to 40,000 ft.)
Dimensions	Height: 1.0 inches (25.4 mm) Width: 4.0 inches (101.6 mm) Depth: 5.75 inches (146.1 mm)
Weight	0.62 Kg

4.3-GB Maxtor Hard Drive Specifications

The specifications for the 4.3-GB Maxtor DiamondMax™ hard drive are included in the following table.

4.3-GB Maxtor DiamondMax Hard Drive Specifications

Feature	Specification
Hard Drive	4.3-GB Maxtor DiamondMax 88400D3
Formatted Capacity	4320 MB
Nominal Rotational Speed	5,400 rpm
Number of Disks	1
Number of R/W Heads	2
Buffer Size	256 KB
Power	+5V +/-5%; 100 mV peak-to-peak allowable ripple/noise 12V +/-5%; 250 mV peak-to-peak allowable ripple/noise
Temperature (non-condensing)	Operating: 5° to 55° C (41° to 131°F) Non-operating: -40° to 71° C (-40° to 160°F)
Humidity (non-condensing)	Operating: 5% to 95% rh, 30°C (86°F) Non-operating: 5% to 95% rh, 40°C (104°F)
Altitude	Operating: -200 m to 3,000 m (-650 to 10,000 ft.) Non-operating: -200 m to 12,000 m (-650 to 40,000 ft.)
Dimensions	Height: 1.02 inches (25.9 mm) Width: 4.02 inches (102.1 mm) Depth: 5.77 inches (146.1 mm)
Weight	1.3 lbs (0.59 Kg)

8.4-GB Fujitsu Hard Drive Specifications

The specifications for the 8.4-GB Fujitsu hard drive are included in the following table.

8.4-GB Fujitsu Hard Drive Specifications

Feature	Specification
Hard Drive	8.4-GB Fujitsu
Formatted Capacity	8450 MB
Nominal Rotational Speed	5,400 rpm
Number of Disks	2
Number of R/W Heads	4
Buffer Size	512 KB EDO DRAM
Power	+5V +/-5%; 100 mV peak-to-peak allowable ripple/noise 12V +/-8%; 250 mV peak-to-peak allowable ripple/noise
Temperature (non-condensing)	Operating: 5° to 55° C (41° to 131°F) Non-operating: -40° to 60°C (-40° to 140°F)
Humidity (non-condensing)	Operating: 8% to 80% rh Non-operating: 5% to 85% rh
Altitude	Operating: -60 m to 3,000 m (-200 to 10,000 ft.) Non-operating: -200 m to 12,000 m (-650 to 40,000 ft.)
Dimensions	Height: 1.0 inches (26.1 mm) Width: 4.0 inches (101.6 mm) Depth: 5.75 inches (146.0 mm)
Weight	1.2 lbs (0.5 Kg)

8.4-GB Maxtor Hard Drive Specifications

The specifications for the 8.4-GB Maxtor hard drive are included in the following table.

8.4-GB Maxtor DiamondMax Hard Drive Specifications

Feature	Specification
Hard Drive	8.4-GB Maxtor
Formatted Capacity	8455 MB
Nominal Rotational Speed	5,400 rpm
Number of Disks	2
Number of R/W Heads	4
Buffer Size	256 KB
Power	+5V +/-5%; 100 mV peak-to-peak allowable ripple/noise 12V +/-5%; 250 mV peak-to-peak allowable ripple/noise
Temperature (non-condensing)	Operating: 5° to 55° C (41° to 131°F) Non-operating: -40° to 71°C (-40° to 160°F)
Humidity (non-condensing)	Operating: 5% to 85% rh, 30°C (86°F) Non-operating: 5% to 95% rh, 40°C (104°F)
Altitude	Operating: -200 m to 3,000 m (-650 to 10,000 ft.) Non-operating: -200 m to 12,000 m (-650 to 40,000 ft.)
Dimensions	Height: 1.02 inches (25.9 mm) Width: 4.2 inches (102.1 mm) Depth: 5.77 inches (146.6 mm)
Weight	1.3 lbs (0.59 Kg)

12.9-GB Maxtor Hard Drive Specifications

The specifications for the 12.9-GB Maxtor hard drive are included in the following table.

12.9-GB Maxtor DiamondMax Hard Drive Specifications

Feature	Specification
Hard Drive	12.9-GB Maxtor
Formatted Capacity	1290 MB
Nominal Rotational Speed	5,400 rpm
Number of Disks	3
Number of R/W Heads	6
Buffer Size	512 KB
Power	+5V +/-5%; 100 mV peak-to-peak allowable ripple/noise 12V +/-5%; 250 mV peak-to-peak allowable ripple/noise
Temperature (non-condensing)	Operating: 5° to 55° C (41° to 131°F) Non-operating: -40° to 71°C (-40° to 160°F)
Humidity (non-condensing)	Operating: 5% to 85% rh, 30°C (86°F) Non-operating: 5% to 95% rh, 40°C (104°F)
Altitude	Operating: -200 m to 3,000 m (-650 to 10,000 ft.) Non-operating: -200 m to 12,000 m (-650 to 40,000 ft.)
Dimensions	Height: 1.02 inches (25.9 mm) Width: 4.02 inches (102.1 mm) Depth: 5.77 inches (146.6 mm)
Weight	1.3 lbs (0.59 Kg)

ATX Power Supply Specifications

The specifications for the ATX 90-watt and 145-watt power supplies are included in the following table.

Power Supply Specifications

Feature	Specification
Power Supply	90-Watt and 145-Watt Power Supplies
Operating Characteristics	Vin = 115 V or 230 V as appropriate Ta = 25° Thermal stabilization - 1 hour minimum
Temperature Range	Operating: 10° to 50° C Storage: -40° to 70° C

Fax/Modem Board Specifications

The specifications for the fax/modem boards are included in the following table.

Fax/Modem Board Specifications

Feature	Specification
Fax/Modem Board	U.S. Robotics Python V.90 56.6 Kbps ISA Modem Diamond MDM100D V90 56 Kbps TTU PCI Modem Aztech MDM100A V90 56 Kbps TTU PCI Modem GVC MDM100G V90 56 Kbps TTU PCI Modem
Data (maximum speed)	V90 ITU 56 Kbps ITU-T V.34+ ITU-T V.34 ITU-T V.32bis ITU-T V.32 ITU-T V.23 ITU-T V.22bis ITU-T V.22 Bell 212A Bell 103
Error Control and Data Compression	ITU-T V.42 ITU-T V.42bis MNP5
Fax Modulation Schemes	ITU-T V.17 ITU-T V.29 ITU-T V.27ter ITU-T V.21
Fax Standards	EIA 578 Class 1 Fax EIA 592 Class 2.0 Fax 14.4 Kbps Send and Receive

ATI Minden AGP Board Specifications

The specifications for the ATI Minden (Rage IIC) 4 MB AGP board are included in the following table.

ATI Minden (Rage IIC) AGP Board Specifications

Feature	Specification
AGP Board	ATI Minden (Rage IIC) AGP Board
Controller	ATI 3D Rage IIC 64 bit graphics accelerator
Bus Type	AGP 2X Compliant
Video BIOS	64 K (AGP Compliant)
Memory	4-MB SDRAM on AGP board
Vertical Refresh	75 Hz – 200 Hz
Maximum Dot (Pixel) Rate	170 MHz
Connectors	VGA DB-15 with DDC support for plug and play monitors 132-pin standard AGP bus connector 144-pin SO-DIMM connector

ATI Expert 98 AGP 8 MB Board Specifications

The specifications for the ATI Expert 98 (Rage PRO) 8 MB AGP board are included in the following table.

ATI Expert 98 (Rage PRO) AGP Board Specifications

Feature	Specification
AGP Board	ATI Expert 98 (Rage PRO) AGP Board
Controller	ATI 2D/3D/video RagePRO Turbo 64 bit graphics accelerator (supports DVD playback)
Bus Type	AGP 2X Compliant
Video BIOS	64 K (AGP Compliant)
Memory	8-MB SDRAM on AGP board
Vertical Refresh	75 Hz – 200 Hz
Maximum Dot (Pixel) Rate	170 MHz
Connectors	VGA DB-15 with DDC support for plug and play monitors 132-pin standard AGP bus connector 144-pin SO-DIMM connector

Diamond Viper V550 AGP Board Specifications

The specifications for the Diamond Viper V550 AGP 2D/3D graphics board are included in the following table.

Diamond Viper V550 AGP Board Specifications

Feature	Specification
AGP Board	Diamond Viper V550 AGP Board
Controller	NVIDIA RIVA TNT™ chipset, true 128 bit
Resolutions	Up to 1920 by 1200
Bus Type	AGP 2X Compliant
Memory	16-MB 125 MHz SDRAM on board
Vertical Refresh	60 Hz – 200 Hz
Connectors	VGA DB-15 with DDC support for plug and play monitors 132-pin standard AGP bus connector

Lite-On 32X and 40X CD-ROM Drive Specifications

The specifications for the Lite-On 32X and 40X CD-ROM drives are included in the following table.

Lite-On 32X and 40X CD-ROM Drive Specifications

Feature	Specification
32X and 40 XCD-ROM Drive	Lite-On CD-ROM drive
Interface	ATAPI/EIDE Supports PIO Mode4, DMA Mode 2, and Ultra DMA
Average Access Time	<80 ms (typical)
Applicable Disc Format	Mixed Mode (Audio and Data Combined) ISO9660, CD-DA, Mode 1 (basic format), Mode 2 form 1 and form 2, Photo-CD (Single and Multisession), CD-I/FMV, CD-Extra, Video CD, CD-DA, CD-RW
Data Transfer Rate/Sustained Data Transfer Rate	
32X (24X average)	2100 - 4800 Kbytes/sec
40X (30X average)	2550 - 6000 Kbytes/sec
Voltage tolerance	+5V DC +/-5%; +12V DC +/-10%

Lite-On 32X and 40X CD-ROM Drive Specifications

Feature	Specification
Temperature	Operating: 5° to 45° Non-operating: -20° to 60°
Humidity	Operating: 20% to 80% (non-condensing) Non-operating: 20% to 90% (non-condensing)
Physical Dimensions	H x W x L: 41.3 x 145.8 x 190.5 mm max
Weight	1.2 Kg (typical)

NEC 32X CD-ROM Drive Specifications

The specifications for the NEC 32X CD-ROM drive are included in the following table.

NEC 32X CD-ROM Drive Specifications

Feature	Specification
32X CD-ROM Drive	NEC CDR-1900A/PBM
Data Transfer Rate	2550 - 6000 Kbytes
Memory Buffer	128 Kbytes
Supported Modes	CD-Audio, CD-ROM (Mode 1 and Mode 2), CD-XA (Mode 2, form 1 and form 2), CD-I (FMV), Video CD, CD Extra, CW-RW, CD-Text, Multisession Photo CD™, Single Session Photo CD™
Capacity	656 MB (Mode 1) 748 MB (Mode 2)
Weight	.971 Kg
Temperature	5°C to 45°C (Operating) -20°C to +60°C (Non-operating)
Humidity	30% to 70% relative humidity (Operating) 30% to 90% relative humidity (Non-operating)

Hitachi 4X DVD-ROM Drive Specifications

The specifications for the Hitachi 4X DVD-ROM drive are included in the following table.

Hitachi 4X DVD-ROM Drive Specifications

Feature	Specification
4X DVD-ROM Drive	Hitachi GD-2500
Data Transfer Rate	DVD, 5.52 MB DVD-R, 2.76 MB CD, 3.6 MB
Interface	Enhanced IDE (ATAPI)
Memory Buffer	512 Kbytes
Supported Modes	CD-Audio, CD-ROM (Mode 1 and Mode 2), CD-XA (Mode 2, form 1 and form 2), CD-I (FMV), Video CD, CD Extra, CW-RW, CD-Text, Multisession Photo CD™, Single Session Photo CD™
Capacity	DVD, 4.7 GB (single-layer disc) or 8.5 GB (double-layer disc) CD, 650 MB
Temperature	5°C to 45°C (Operating) -20°C to +60°C (Non-operating)
Humidity	15% to 85% relative humidity (Operating) 10% to 90% relative humidity (Non-operating)
Weight	1 Kg (2.2 lb.)
Dimensions	146 mm wide, 41.3 mm high, 190 mm depth

PC Adapter Device Specifications

The specifications for the PC adapter device are included in the following table.

PC Adapter Device Specifications

Feature	Specification
PCMCIA device	SCM SwapBox™ PC Card Host SBI-D2P
Hardware	PnP 16-bit PC-AT interface card connecting to a 3.5-inch drive bay with twin PC Card sockets
Card Sockets	2
Card Configurations	Two Type I/II cards <i>or</i> One Type I/II card and one Type III
Controller	ExCA-compatible PCMCIA VG469 controller; Intel register, step B compatible

PC Adapter Device Specifications

Feature	Specification
Software	SwapFit Flash Filing system driver enabling full floppy disk or hard drive emulation on flash cards; compatible with all compression and PC-utilities software
	Single drive letter designator for all memory cards
	Graphical installation and formatting utilities
Functionality	Supports ISA Plug and Play
	Supports mixed voltage (3V) cards
	Vcc and Vpp Matrix: Micrel MTC2563

Tape Backup Unit Specifications

The specifications for the tape backup unit are included in the following table.

Tape Backup Unit Specifications

Feature	Specification
Tape Backup Unit	Seagate CTT8000 IDE Minicartridge Drive
Capacity	4.0 GB (900 Oe 740' Travan cartridge, uncompressed) 8.0 GB (900 Oe 740' Travan cartridge, compressed)
Effective Backup Rate	30 MB/min typical native 45 MB/min typical compressed
Data Transfer Rate	300/450/600 KB/second Fast Sense
Tape Speed	
Read/Write	33, 51, or 77 ips
Search/Rewind	90 ips max
Recording Method	Serpentine
Recording Format	QIC-3095-MC
Recording Media	900 Oe 740' Travan TR-4
Cartridge Size	3.2 in. x 2.4 in. x 0.4 in. (81 mm x 61 mm)
Data Density	67,733 bpi
Tracks	72 data tracks, one directory track
Synchronous Transfer Rate (Burst)	5 MBytes/sec maximum
Asynchronous Transfer Rate (Burst)	5 MBytes/sec maximum
Voltage Tolerance	+5V +/-5%; +12V +/-10%

Tape Backup Unit Specifications

Feature	Specification
Temperature	Operating: 5° to 45° Non-operating: -40° to 65°
Humidity	Operating: 20% to 80% (non-condensing) Non-operating: 5% to 95% (non-condensing)
Altitude	Operating: -1,000 to 15,000 feet Non-operating: -1,000 to 50,000 feet

Zip Drive Specifications

The specifications for the Zip drive are included in the following table.

Zip Drive Specification

Feature	Specification
Zip Drive	Iomega Zip 100 ATA Drive
Sustained Data Transfer Rate	Up to 11.2 Mbits/sec
Burst Transfer Rate	Up to 26.7 Mbits/sec
Minimum Seek	4.0 ms
Average Seek	29.0 ms
Maximum Seek	55.0 ms
Average Latency	10.2 ms
Spindle Speed	2941 rpm
Track-to-Track Access Time	5.0 ms
Average Head Switch Time	8.0 ms
Head Reload Time	200.0 ms
Average Start/Stop Time	3/2 seconds
Removable Zip Cartridge Capacity	100 MB formatted
Error Correction	Reed-Solomon
Height	1.00 in. (25.4 mm)
Width	3.99 in. (101.4 mm)
Depth	6.44 in. (163.6 mm)
Weight	13.2 ounces (374.22 grams)
Relative Humidity (Noncondensing)	10% to 80% (operating)
Operating Temperature	10°C to 32°C

Environmental and Safety Specifications

The system environmental and safety specifications are included in the following table.

Specifications

Feature	Specification
Recommended Operating Environment	Temperature: 50°F to 95°F (10°C to 35°C) Relative Humidity: 20% to 80%
Administrative Compliance	UL 1950 - safety CSA C22.2 No. 950-m89 TUV EN60950: 1988 FCC part 15, Subpart J, Class B - emissions FCC part 68 IEC 950 - safety VDE 0871/6.78, Class B - emissions

Compliance

The system meets the compliance standards listed in the following table.

System Compliance

Usage	Standard
Domestic	FCC CFR 47 Part 15, Subpart B UL 1950 3 rd edition
Canadian	C-UL C22.2 No. 950-95 ICES-003 Issue 2, Revision 1
European	CD EMC Directive 89/336 EEC EN55022:1993 Class B EN50082-1:1997 CD LVD Directive 73/23 EEC EN60950
Energy Star	All modes are Energy Star Compliant

The system meets all requirements in the European Waste Regulation Ordinance for packaging and scrap.

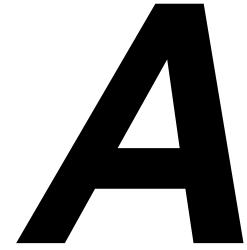

Release Notes

- General Notes
- SCSI Drive Limitations
- LS-120 SuperDisk Copy Utility
- NEC OS Restore CD
- PIIX4 Limitations
- New System Board Jumper Settings
- Intel Processor Serial Number Control Utility
- Windows 95 Issues
- Windows 98 Issues
- Windows NT Issues

The *PowerMate VT 300i Series Release Notes* provide up-to-date information on installing the applications that come with your computer. These notes also provide additional valuable information about your computer that was not included in the printed user's guide or online NEC Help Center.

Please read these notes in their entirety.

General Notes

The following notes describe general system behaviors and recommended operating procedures not documented in other PowerMate VT 300i Series documentation.

Installing Applications and Online Documentation

The system comes with the operating system preloaded. Microsoft® Internet Explorer® 4.01 also comes preinstalled on systems with the Windows® 98 operating system. All other applications and online documentation are installed from the NEC Application and Driver CD. Microsoft Internet Explorer also comes on the NEC Application and Driver CD for systems with the Windows 95 or Windows NT® operating system.

Launch the NEC Application and Driver CD as follows:

- In systems running the Windows NT operating system, insert the NEC Application and Driver CD after the system reboots and you have chosen the Windows NT Workstation Version 4.00 operating system. Be sure to insert the CD before Windows NT actually completes its boot and displays the NT logon screen.

 **Note:** Install the optional software located on the NEC Select Install CD after your first logon to Windows NT.

- For systems running the Windows 95 or Windows 98 operating system, insert the NEC Application and Driver CD after the system reboots.

The CD autorun feature loads the NEC Application and Driver Installation Utility program.

Follow these guidelines when you install applications and the NEC Help Center online documentation:

- For systems with the Windows 95 or Windows NT operating system, install Microsoft Internet Explorer *first* and alone, *before* installing any other application from the NEC Application and Driver CD.

Internet Explorer 4.01 already comes preinstalled on systems with the Windows 98 operating system.

-
- Once Internet Explorer is installed, other applications can be installed during the same installation session and in any order. Internet Explorer comes preinstalled on systems with the Windows 98 operating system.

 **Note:** Install the NEC Help Center *after* installing Microsoft Internet Explorer 4.01 on the system. Installation of the NEC Help Center requires Internet Explorer 4.01 installed on the system. The Help Center cannot run without Microsoft Internet Explorer 4.01.

See “NEC Application and Driver CD” in Chapter 3 of the *PowerMate VT 300i Series User’s Guide* for detailed information about installing applications from the Application and Driver CD.

Setting Boot Order in BIOS

To use the CD-ROM drive as a boot device, the BIOS must list it as the first device. Otherwise, the CD-ROM drive should be second in the boot order.

The system does not boot from a Zip[®] drive if it is listed as the first boot device.

Configuring the System for Microsoft Internet Explorer

TCP/IP must be enabled before Microsoft Internet Explorer 4.01 can be used. See the next section, “Changing Network Settings,” for instructions on enabling TCP/IP. (Internet Explorer is installed from the NEC Application and Driver CD.)

 **Note:** Internet Explorer 4.01 comes preinstalled on systems with the Windows 98 operating system.

Changing Network Settings

All systems are configured with the NetBEUI and NWLink protocols enabled. However, before you connect a system to your network you might need to:

- enable a different network protocol
- disable unneeded protocols for enhanced system performance
- add or change network, domain, and gateway information.

The following procedure describes how to disable the NetBEUI and NWLink protocols, enable TCP/IP, and provide network, domain, and gateway information. (If a different protocol is enabled, the menu choices may differ from those described in the procedure.)

1. From the Windows desktop, click **Start** on the taskbar, point to **Settings**, and click **Control Panel**.

-
2. Double click the **Network** icon in the Control Panel window.
 3. Click the **Protocols** tab. In the Protocols display, the following protocols are loaded:
 - NetBEUI Protocol
 - NWLink IPXSPX-Compatible Transport
 - NWLink NetBIOS
 4. Highlight **NWLink IPXSPX-Compatible Transport** and click **Remove**. A warning window appears asking for confirmation to continue.
 5. Click **Yes**. The NWLink IPXSPX-Compatible Transport and NWLink NetBIOS lines disappear from the Protocols display.
 6. Repeat steps 4 and 5 to remove the **NetBEUI** Protocol.
 7. Click **Add**. The Select Network Protocol window appears.
 8. Highlight **TCP/IP Protocol** and click **OK**. The TCP/IP Setup window appears. If there is a DHCP server on the network, click **Yes**; otherwise click **No**.
 9. Change the path in the window to **C:\I386**. Click **Continue**. The Network window appears. If Yes was clicked in step 8, skip to step 16. If No was clicked in step 8, the Windows Setup window appears.
 10. Click **Close**. The Microsoft TCP/IP Properties Box appears.
 11. Fill in the **IP Address**, the **Subnet Mask**, and the **Default Gateway** in the “Specify an IP address” area.
 12. Click the **DNS** tab and enter the host and domain name in the DNS display.
 13. Click the **Identification** tab and change the Computer Name if appropriate.
 14. Click the **WINS** tab and enter the WINS address if appropriate.
 15. Click the **Routing** tab and enable IP forwarding if appropriate.
 16. Click **OK**. When prompted to restart the system, click **Yes**.

Installing Cheyenne Backup

After installing the Cheyenne[®] Backup utility on the system and rebooting the system, an “Unable to connect to Group” error message is displayed. This message indicates that a backup tape unit is not installed. Installing a tape unit or reconfiguring the Cheyenne Backup utility removes this message.

See “Using Cheyenne Backup” for issues related to using the utility in Windows 95.

Installing LapLink Application Not Supported

The LapLink application included on the NEC Application and Driver CD is not supported. This version of LapLink can cause problems when installed. When released, a new version will be available on the NEC CSD website (<http://www.nec-computers.com>). On the website, select **Service & Support** and then choose **PowerMate**.

Installing PartitionMagic

Install PartitionMagic™ files from the NEC Application and Driver CD. Select the PartitionMagic software from the Applications tab in the Installation utility menu. The utility loads files from the NEC Application and Driver CD to **C:\Program Files\PowerQuest\PartitionMagic4**. You can find setup and documentation files in the following folders:

- Btmagic
- Diskette
- Setup
- Userinfo.

If the PartitionMagic setup program asks you for a serial number, enter the following number:

PM400ENOEMCD-673785

See the documentation in the Userinfo folder for information about using PartitionMagic, BootMagic™, and the recovery diskette program. Reading the Userinfo files requires the Adobe® Acrobat reader. Install the Adobe Acrobat reader from the NEC Application and Driver CD. Select the Adobe Acrobat software from the Applications tab. To load the reader, run **Ar32e301.exe** from the **C:\Acrobat3** folder.

 **Note:** If you are installing BootMagic in a system with the Windows NT operating system, see “Installing BootMagic in a System with Windows NT” at the end of this document.

Getting CD-ROM Support in Command Prompt Only Mode

CD-ROM support is not available when you select **F8** at the “Starting Windows 9x” prompt and select the **Command Prompt Only** option. To initiate CD-ROM support in the Command Prompt Only mode, run **DOSSTART.BAT** which is located in the C:\WINDOWS directory.

Installing Internet Explorer 4.01 Add-On Components from the NEC Driver CD

Choosing the Installing Internet Explorer 4.01 Add-On Components option on the NEC Driver CD results in a file opening error message. Due to the space these components require, the component files are not included on the NEC Driver CD. NEC CSD recommends that you run Internet Explorer 4.01, click the Help menu, and select Product Update. This procedure takes you to the Microsoft Internet Explorer 4.01 website where you can install these components.

Identifying the Pentium III Processor

NEC computer systems with the Intel® Pentium® III processor come equipped with the most advanced Intel Pentium processor available.

Because the new Pentium III processor was introduced after the release of Microsoft® Windows® 98, Windows 95, and Windows NT® operating systems, these operating systems are not able to correctly identify the processor. These operating systems might identify the Pentium III processor as a Pentium II or Pentium Pro processor.

Windows identifies the processor on the General tab of the Windows System Properties sheet. You can get to System Properties in either of the following ways:

- Right click the My Computer icon on the Windows desktop and select **Properties** from the drop-down menu.
- Select **Settings** from the Windows Start menu, click **Control Panel**, double click the System icon.

The Windows System Properties processor identification does not effect in any way the performance of the Pentium III processor. At bootup, the system BIOS detects the Pentium III processor.

You can obtain a patch to fix the Windows processor identification once Microsoft releases the patch. Check for the patch on the Microsoft website (www.microsoft.com) or NEC CSD website (www.nec-computers.com).

SCSI Drive Limitations

The following procedures and operating limitations apply to systems whose only hard drive is a SCSI device.

Booting from a CD

In systems with only a SCSI hard drive, it is not possible to boot from an IDE CD-ROM drive.

Using the NEC OS Restore CD with a SCSI Drive

If a situation arises in which a full operating system restore must be performed using the NEC OS Restore CD, first boot the system from the bootable diskette. (This might be necessary, for example, if the system does not boot from the hard drive.) The bootable diskette comes with all systems that have a SCSI hard drive. After the system boots, proceed with the NEC OS Restore procedure.

LS-120 SuperDisk Copy Utility

Using the LS-120 SuperDisk™ Copy utility on 1.44-MB or 120-MB media intermittently causes system lockups and diskette eject failures. This condition only occurs when you use the SuperDisk Copy utility supplied with the SuperDisk Tools diskette shipped with the system.

To safely copy a 1.44-MB diskette, NEC CSD recommends using the standard Microsoft® Disk Copy program supplied with the Microsoft Windows® operating system. You can find the Microsoft Disk Copy program by double clicking **My Computer** and right clicking the **LS-120** icon. The context menu displays Copy Disk as one of the available items. Using this Copy Disk program allows the LS-120 SuperDisk drive to copy 1.44-MB diskettes without system lockups and allows the drive to eject the 1.44-MB diskette. However, this utility does not copy 120-MB media.

If you need to duplicate 120-MB media, you must use the SuperDisk Copy utility. To avoid data loss, make sure you save all data and close all applications before you attempt to copy 120-MB diskettes with the SuperDisk Copy utility. To recover from a diskette eject failure or a system lockup after completing the SuperDisk Copy, restart the system by pressing the power button to turn off the system. Then press the power button again to turn on system power.

LS-120 SuperDisk Copy issues are currently under investigation and will be fixed in the next version of the SuperDisk Utilities. Please check the NEC CSD website below for updates.

<http://support.neccsdeast.com/products/PowerMate/index.asp>

NEC OS Restore CD

The following sections provide information about the “Fix OS” Restore option on the NEC OS Restore CD. Please use this information in place of the Fix OS information in the Chapter 3 “NEC OS Restore” sections of your *PowerMate VT 300i Series User’s Guide*.

Using the Fix OS Restore Option

“Fix OS” is a Restore option on the NEC OS Restore CD for Windows 95 and Windows 98 systems. The Fix OS restore option reinstalls the Windows operating system while leaving data files intact. It allows you to restore your system to the point where you can back up your data files. This option is intended as a precursor to a full format and restore. See the next section, “Fixing the Operating System,” to perform this restore procedure.

Fixing the Operating System

Use the following procedure to restore the operating system to a state for retrieving and backing up data without repartitioning or reformatting the hard drive. Once all data is backed up, perform another NEC OS Restore using the **Auto** or **Custom** mode.

CAUTION

The Auto and Custom OS Restore programs delete all the data on your hard drive. If possible, back up your data before performing an OS Restore with these options.

1. Launch the NEC OS Restore CD and follow the prompts to get to the Restore Mode screen (see “Launching the OS Restore CD” in Chapter 3 of the *PowerMate VT 300i Series User’s Guide*).
2. Click **Fix OS** to do a basic operating system restore. The Fix OS screen appears and displays two options (Back and Continue).
3. Click **Continue**. The Installing Applications screen appears, showing the status of the restore. It also displays the version of the Windows OS being installed. The installation can take from 5 to 10 minutes.

 **Note:** The drivers and other software components required for the operating system are also loaded from the CD.

After the OS finishes loading, the “Operating System Restore Completed” screen appears.

4. Remove the CD from the CD tray.
5. Click **OK** to reboot.

This completes the OS Restore (or “Fix OS”) procedure. The system is now in a state where data can be backed up. System settings previously located in the C:\WINDOWS directory are now in a backup directory C:\WINDOWS.ORG.



CAUTION

Some or all applications might not exhibit full functionality after the Fix OS is performed. To restore the system to its factory-installed state, perform another OS Restore using the **Auto** or **Custom** option.



CAUTION

Using the **Fix OS** option repetitively without using the **Auto** or **Custom** option afterward might cause unpredictable results.

To restore the system to its factory-installed state, perform another NEC OS Restore using the **Auto** or **Custom** option (see “Launching the OS Restore CD” in Chapter 3 of the *PowerMate VT 300i Series User’s Guide*).

PIIX4 Limitations

The following operating limitations apply to PIIX4 (PCI ISA IDE Xcelerator).

Reconfiguring Ultra DMA Support

The PCI IDE interface on the PowerMate VT 300i Series system supports the latest ATA ULTRA DMA/33 interface. In order to do so, the PIIX4 component that was recently released from Intel Corporation was incorporated in the system. However, standard versions of Windows® 95 were released prior to the release of PIIX4; these versions do not recognize the PIIX4 as capable of supporting ULTRA DMA/33.

Several information files (.INF files) need to be added to standard versions of Windows 95 so the operating system can incorporate PIIX4 features. NEC CSD already includes these .INF files in the preinstalled software that comes with your system. NEC CSD recommends that customers use the version of Windows 95 that is included with their system.



Note: NEC CSD recommends that customers use the version of Windows 95 that is included with their system because this version is already configured for Ultra DMA/33.

When users install their own version of Windows 95, ULTRA DMA/33 does not function without the addition of these files. These .INF files can be added to a new install of Windows 95 by using the NEC OS Restore CD. This results in full ULTRA DMA/33 support.

Determining IDE Device Compatibility

The new PIIX4 component contains a small change in the IDE interface. This change to lower voltage levels on one signal has no effect on most of the IDE hard drives on the market. A small number of older drives fail to function with this new setting. If you have a concern about an older drive that you would like to use with your PowerMate VT 300i Series system, NEC CSD Technical Support Services can help you determine if there might be a problem.

New System Board Jumper Settings

The system board configuration label attached to the system chassis does not contain a complete listing of jumper settings for this system. See the following figure for updated jumper setup information.

PowerMate® VT 300i Series System Board Configuration

⚠ WARNING

Turn off and unplug the system unit before adding options or changing jumper settings.

Note: See your *PowerMate VT 300i Series User's Guide* for detailed option installation information.

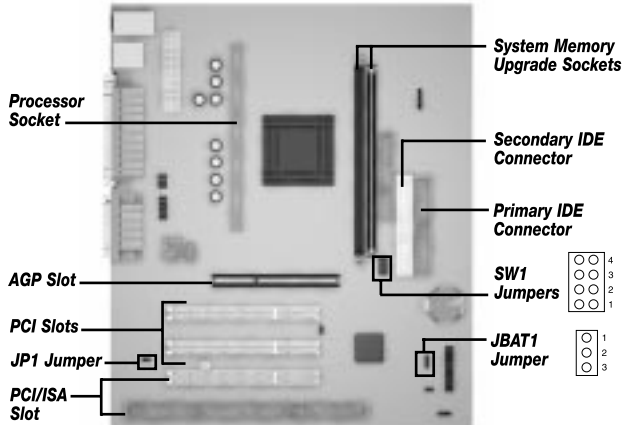

Memory Upgrade

- Maximum memory supported: 256 MB; minimum memory required: 32 MB.
- Memory type and size can vary between sockets.
 - Note:** Memory speed must match processor bus speed.
- System supports 168-pin, 66-MHz or 100-MHz non-ECC SDRAM modules in 32-MB, 64-MB, and 128-MB configurations.
 - Use NEC memory upgrade kits for the best compatibility with your system. For memory compatibility information, call NEC CSD Technical Support.
- Single- or double-sided DIMMS are supported.
- No jumper setting required.

Jumper Settings

Power On Mode



Factory setting. Boots up system when power button is pressed.



Boots up system immediately when power cable is connected. Returns system power to its state (power on or power off) before an AC power loss.

CMOS Clear



Factory setting. Maintains system board configuration in CMOS RAM with onboard battery.



Clears CMOS while system power is off. Return jumper to pins 1 and 2 before powering system on.
Caution: To prevent damage to the system board, avoid clearing CMOS while power is on.

Processor/Bus Speed



233 MHz/66 MHz
350 MHz/100 MHz



266 MHz/66 MHz
400 MHz/100 MHz



300 MHz/66 MHz
450 MHz/100 MHz



333 MHz/66 MHz
500 MHz/100 MHz



366 MHz/66 MHz



400 MHz/66 MHz



433 MHz/66 MHz

NEC CSD Website: <http://www.nec-computers.com>
 NEC CSD Technical Support: 800-632-4525

NEC
409-00018-001

Intel Processor Serial Number Control Utility

The Intel® Processor Serial Number Control utility is a Windows® program that enables or disables the reading of the Pentium® III processor serial number by software. This function lets you control which software programs or websites have permission to read the processor serial number. When installed, the utility runs automatically each time the system powers on.

This utility places an icon in the Windows system tray. The icon provides a visual status of the processor serial number. You have the option of hiding the system tray icon. You can disable the processor serial number at any time. However, enabling the serial number requires restarting the system.

The following information describes:

- system requirements
- installation procedures
- processor serial number features
- answers to frequently asked questions
- Intel technical support.

Identifying System Requirements

The Intel Processor Serial Number Control utility requires:

- a Pentium III processor-based system
- Windows 95, Windows 98, or Windows NT® 4.0 (or later)
- 2 megabytes of hard drive space.

Installing the Utility

The Intel Processor Serial Number Control Utility (version 1.0) comes on the NEC Application and Driver CD. See your *PowerMate VT 300i Series User's Guide* for information about using the NEC Application and Driver CD.

Run **setup.exe** from the directory where you unzip the file.

 **Note:** Installing this utility on a system which does not contain a Pentium III processor generates an error message.

Looking at Serial Number Features

The Intel processor serial number, a new feature of the Pentium III processor, is an identifier for the processor. The processor serial number is designed to be unique, and when used in conjunction with other identification methods, can be used to identify the system or user. This number can be used in a wide variety of applications which benefit from stronger forms of system and user identification.

The processor serial number is analogous to a conventional serial number, with these important differences:

- A software application can read the processor serial number.
- You can disable the reading of the serial number via utility programs such as this one, or via the BIOS, depending on the system configuration.

For additional information about the Pentium III processor and the processor serial number, please visit www.intel.com/pentiumiii.

Getting Answers to FAQs

See the following answers to questions about the processor serial number.

What are the benefits of the processor serial number?

You can use the processor serial number in applications which benefit from stronger forms of system and user identification.

Why would I want to turn off my processor serial number?

Intel believes the processor serial number can provide compelling benefits to users. They are developing features in conjunction with the processor serial number to allow responsible service providers to provide services which maintain your privacy. However, if you are concerned that a given application/service using your processor number might impact your privacy, you can turn off the processor serial number using the utility.

What is the default state of the processor serial number?

The default state of the processor serial number is on, until the Processor Serial Number Control utility is installed. Once the Processor Serial Number Control utility is installed, it turns the processor serial number off by default. You can use the utility to turn on the processor serial number.

Can a website read my serial number without my knowledge?

No, generally not. Websites cannot read serial numbers unless you allow them to download a program which can read the processor serial number. Almost all browsers are configured to warn users whenever they download executable software. Unless you disable the warning in the browser, you should receive a notification.

Does Intel track serial numbers?

Generally not, other than related to the manufacturing process. Intel does not, in the absence of advance and express consent of a user, collect serial number data which is otherwise identified with a user.

Which programs and/or websites currently use the processor serial number?

You can find a complete list of programs which can take advantage of the processor serial number and other new capabilities of the Pentium III processor at <http://www.intel.com/pentiumiii/utility.htm>.

How can I tell if my processor serial number is turned on?

The vast majority of Pentium III processor-based systems ship with the processor serial number enabled. The control utility allows you to check the status by:

- Viewing the icon itself. The disabled icon shows a red circle with a white "x."
- Clicking the task tray icon and selecting the "Status" menu item. Or you can select the menu from the tool tip shown when you position the mouse over the task tray icon.

Getting Intel Technical Support

For world wide 7 days a week, 24 hours a day technical support, please visit the Intel support website at <http://support.intel.com>.

Email: support@intel.com.

In the United States, call **800-628-8686** from 5:00 a.m. to 5:00 p.m. Pacific Standard Time.

For world wide phone contacts, please see <http://support.intel.com/support/feedback.htm>.

Windows 95 Issues

The following material describes information specific to systems running the Microsoft® Windows 95® operating system.

Controlling CD Audio

CD audio volume is not controlled by the Windows 95 taskbar Volume Control.

To control CD audio volume, access your CD player program. Move the volume slider bars up or down to increase or decrease CD audio volume.

Using Cheyenne Backup to Back Up Large Drives

When Cheyenne Backup is set to automatically back up a drive to a network drive, and the system drive being backed up is greater than 2.1 GB, multiple instances of the Copy program may be launched, according to how many drive letters are assigned to the hard drive. The first instances end with an indication that no data was transferred. The last instance completes the backup successfully. See also "Installing Cheyenne Backup" earlier in this document.

Restoring Software with a US Robotics 56K V.90 Modem Installed

If your system has a US Robotics 56K V.90 Modem installed and you restore the Windows 95 operating system, the system might display a message indicating it cannot load the Modem.inf file. If this message appears, follow the instructions in “Installing Applications and Online Documents” in this document. Select the US Robotics 56K modem from the appropriate Operating System section of the NEC Application and Driver CD.

Clicking the Product Catalog Button

When a computer running the Windows 95 operating system is first booted, a Welcome screen appears. If the **Product Catalog** button is clicked, the user is prompted to insert the Windows 95 CD. Click **Cancel** to clear the message.

Windows 98 Issues

The following material describes information specific to systems running the Microsoft® Windows 98® operating system.

Ejecting the NEC Application and Driver CD from a DVD-ROM Drive

If your system has a Hitachi DVD-ROM drive (4X GD-2500) and you manually load applications or drivers from the NEC Application and Driver CD, a dialog box appears with the message “Reminder: Please remove CD-ROM.”

Pressing the eject button on the DVD-ROM drive displays another dialog box with the message: “Eject request to Drive in Use: An Eject request was received for a drive that is in use, continue with eject operation?”

Click **OK** to eject the CD from the DVD-ROM drive. The first dialog box is displayed. Click **OK** to complete the software loading operation.

Finding Tape Device Icons

Windows 98 displays tape device detection icons in Control Panel and Device Manager when no tape devices are installed in the system. This is normal for the chipset used on the PowerMate VT 300i Series system board. The Windows 98 operating system indicates that support for a tape device is available.

Finding the 3Com Diagnostic Program

The 3Com Windows user diagnostic program is not available on the Windows Start/Programs menu. If you need to run the 3Com Diagnostics program, use the MS-DOS-based programs on the Driver CD that comes with your system.

Finding No Network Neighborhood Icon on the Desktop

The Windows 98 desktop does not display a Network Neighborhood icon when you boot the system into Windows 98. The 3Com 3C905B-TX drivers are preinstalled on the system and no protocols are loaded. This configuration does not display the Network Neighborhood icon on the desktop. See “Changing Network Settings” in this document to configure your system.

Windows NT Issues

The following material describes information specific to systems running the Microsoft® Windows NT® operating system.

Restoring Network Card Drivers

If you are running a system with the Windows NT operating system, use the following procedure to install either the **Intel® Pro 100** or **3Com® 3C905B-TX** drivers from the NEC Application and Driver CD.

1. Locate the entire directory for the network card you are installing in your system. Copy the entire directory to a local temporary directory.
2. In the Windows NT Control Panel, select **network** and click **adapters**.
3. Select **ADD** and click the **HaveDisk** button. A dialog box is displayed.
4. In the Path windows, type the name of the temporary directory for the network card files you copied. Click **OK**. Windows NT installs the driver files for the network card.

Installing BootMagic in a System with Windows NT

BootMagic™ is a utility included in the PowerQuest PartitionMagic™ software. See “Installing PartitionMagic” earlier in this document for general installation information.

If you have a Windows NT operating system, use the information in the following section to correctly configure BootMagic.

If you already installed BootMagic and the configuration resulted in an error message, see “Correcting the BootMagic Configuration” later in this document.

Configuring BootMagic

If you have a system with the Windows NT operating system, use the following procedure to correctly configure BootMagic.

1. Follow the instructions in the PartitionMagic Userinfo folder to install BootMagic. When the “BootMagic Configuration” box appears at the end of the installation, continue to the next step.

2. Configure BootMagic.

- If you want to use BootMagic:
Click the **ENABLE BOOTMAGIC** button. The BootMagic menu appears during the next bootup sequence and lets you select Windows NT as the operating system.
- If you do not want to use BootMagic:
Do *not* select the **ENABLE BOOTMAGIC** button. The BootMagic menu does not appear at bootup.

3. Select **SAVE/EXIT** in the BootMagic Configuration box to complete the configuration process. Either choice, to enable BootMagic or to not enable BootMagic, requires the **SAVE/EXIT** selection.



CAUTION

To correctly complete the BootMagic configuration, you must select **SAVE/EXIT** from the BootMagic Configuration box, even if you do not want to use BootMagic. Omitting this step results in an error message.

Correcting the BootMagic Configuration

If you installed BootMagic in a system with the Windows NT operating system and the installation resulted in an error message, use the following procedure to correct the configuration information.

1. In the Windows Start menu, select **Programs, PowerQuest BootMagic, and BootMagic Configuration**. The BootMagic Configuration box appears.
Nothing should be listed under the MENU NAME heading in the center of the box.
2. Click **ADD**. The “Bootmagic Add OS” box appears. This is the only option listed and it is already highlighted.
3. Click **OK**. Click **OK** again. The main BootMagic Configuration screen appears with “Windows NT” listed under MENU NAME.
4. Check the BootMagic configuration.
 - If you want to use BootMagic:
Click the **ENABLE BOOTMAGIC** button. The BootMagic menu appears during the next bootup sequence and lets you select Windows NT as the operating system.
 - If you do not want to use BootMagic:
Do *not* select the **ENABLE BOOTMAGIC** button. The BootMagic menu does not appear at bootup.

-
5. Select **SAVE/EXIT** in the BootMagic Configuration box. Either choice, to enable BootMagic or to not enable BootMagic, requires the **SAVE/EXIT** selection.



CAUTION

To correctly complete the BootMagic configuration, you must select **SAVE/EXIT** from the BootMagic Configuration box, even if you do not want to use BootMagic. Omitting this step results in an error message.

Glossary

A

access time

The time period between the supply of an access signal and the output or acceptance of the data by the addressed system. Examples are the access times for DRAMs, SRAMs, hard drives, and CD-ROM drives. Hard drive access time is the time it takes for a computer to get data from the drive. A hard drive with an 11 ms access time is fast. A CD-ROM drive with a 280-ms access time is fast.

ACPI

Advanced Configuration and Power Interface. A power management specification developed by Intel, Microsoft, and Toshiba. When installed on the system, ACPI enables the operating system to control the amount of power given to each device attached to the computer. With ACPI, the operating system can turn off peripheral devices (such as CD-ROM drives) when they are not in use. As another example, ACPI enables manufacturers to produce computers that automatically power up as soon as you touch the keyboard.

adapter

An expansion board or component on the system board that communicates with peripherals (such as the display monitor or network devices).

address

A hexadecimal number that represents a location in storage or memory. Also used to identify communication ports. To communicate with a storage device.

AGP

Accelerated Graphics Port. A high-speed, high-performance video standard supported by a dedicated connector on the system board. The connector allows the connection of an AGP board to the system board's AGP bus. AGP boards feature 64- or 128-bit graphics acceleration with an integrated digital video engine and accelerated 3-D graphics, texture mapping, and shading functions. Fast refresh rates, high resolution, and color depth allow for incredible graphics suitable for multimedia and graphic intensive applications.

algorithm

Any set of instructions to be followed in order.

anti-aliasing

Making jagged edges look smoother by filling in the jags with an intermediate color. Usually used in reference to the edges of shapes, especially letters, on a computer screen.

API

Application Programming Interface. An API is a series of functions that programs can use to make the operating system do routine or repetitive tasks. Using Windows APIs, for example, a program can open windows, files, and message boxes (as well as perform more complicated tasks) by passing a single instruction. Windows has several classes of APIs that deal with telephony, messaging, and other issues.

APM

Advanced Power Management. An API developed by Intel and Microsoft that allows developers to include power management in the BIOS. APM defines a layer between the hardware and the operating system that effectively shields the programmer from hardware details.

application programs

Software designed to perform specific functions or a group of functions, like solving business or mathematical problems. Examples of applications include word processing, communications, or database management.

architecture

A general term for the design and construction of computer systems, particularly hardware, but also operating systems and networks. The circuitry within a chip is called its architecture; for example, Intel architecture can refer to a computer based on the Intel Celeron, Pentium II, or Pentium III chips.

archive

Copying one or more files to a different location for long-term data storage, especially for backup and security purposes. Files can then be added to or deleted from the archive. Also refers to the location where data is stored.

ASIC

Application Specific Integrated Circuit. A chip designed for use on a particular circuit board, or for a very narrow range of use. The digital signal processor chip on a modem is an ASIC.

asynchronous

Refers to operations that do not require the clocks of communicating devices to be coordinated. Instead, the devices send signals to each other indicating readiness to receive or send. Compare synchronous.

asynchronous cache

The slowest, most inexpensive type of secondary SRAM cache, running at speeds of 15 to 20 ns.

ATA

AT Attachment. A standard for connecting hard drives or other devices to an AT bus; synonymous with IDE.

AT bus

The AT bus system with support chips (DMA, PIC, etc) and a 16-bit bus slot. The AT bus is strictly defined by ISA.

audio

Relating to or capable of producing sound. Multimedia computers make extensive use of audio.

AVI

A digital movie format created by Microsoft. AVI is short for “audio/video interleave,” a method of including a digital movie and its accompanying sound in the same file. Files in the AVI format have the .AVI extension.

B**bad sector**

Part of a hard drive or diskette drive storage medium that doesn't hold data. Formatting generally detects and marks these areas so they won't be used. Certain utility programs do, too, and it is a good idea to run this type of utility occasionally to prevent data loss if the condition of the drive changes.

bandwidth

A measure of how much information something can carry. Specifically, data path times frequency. For example, the ISA bus has a data path of 16 bits (it can send 16 bits at a time) and typically operates at 8.33 MHz, so it has a bandwidth of 133.28 megabits per second (Mbps).

base RAM

Area of system memory between 0 and 640 kilobytes available to the user for operating system and application programs.

batch file

A file that contains a series of DOS commands. Batch files have the extension .bat. If you execute a batch file, DOS attempts to carry out all the commands in the file, in order.

baud

A unit of measure for modem speed. Literally, the number of voltage transitions per second. Phone line limitations limit the actual baud rate of modems to 2400 baud, although the data transmission rate (bps) may be higher because of data compression.

BBS

Short for Bulletin Board Service. Software that serves as a communication and information source for computers that communicate by modem.

BIOS

Basic Input/Output System. A program or set of programs permanently stored in ROM chips installed on the system board. The BIOS contains functions that control the real-time clock, keyboard, disk drives, video display, and other peripheral devices. For example, the BIOS Setup utility program is contained in the BIOS, and when you change the drive type, you change the BIOS.

bit

Binary digit. The smallest unit of computer data. A single digital piece of information, generally represented by the numeral 0 or 1. Usually the transition between the states of +5V and -5V within a computer, the charge of a transistor in an integrated circuit, or the change in polarity of a magnetic region on a disk. See byte. Data compression schemes can enable the transmission of more than one bit per voltage transition.

bit block transfer

Moving part of a screen image as a single block rather than moving a pixel at a time. Bit block transfers are much faster than moving the same pixels individually, and it is common in accelerated video cards.

bitBLT

Bit Block Transfer.

bitmap

Any occurrence where a single location in memory and a single pixel correspond. Usually applies to screen or printer output. .BMP files are bitmapped graphics files.

bits per second

(bps) A unit of transmission. Also called baud rate.

block

A contiguous section of bits considered as a whole, especially in memory. On a disk, the data in one sector; in modem data transfer, the bits between checksums.

board

Printed circuit board. Board onto which computer components are soldered and thin wires are printed to connect the components.

boot

To start up a computer. The computer is generally booted in one of three ways: by turning on the power switch (cold boot), by pressing the reset switch, or by simultaneously pressing the Ctrl, Alt, and Del keys (warm boot). Booting the system after it has already been powered up and booted is referred to as rebooting. Also the process of booting itself. Boot is from "bootstrap," a reference to a computer's ability to set itself up, or pull itself up by its own 'bootstraps.' See cold boot and warm boot.

bootable device

Any type of hardware that carries the information (software) required by the computer to start properly. This device must also have the capacity to be recognized by the computer in the first stages of the boot process.

boot block

The part of a disk that contains the software (such as the operating system loader) that enables the computer to start.

boot sector

The part of the boot block that contains the operating system loader, a program that starts by itself and loads the operating system.

bps

Bits per second. The number of bits of data that can be transmitted in one second. Because data compression schemes enable more than one bit per voltage transition, bps is equivalent to baud only if no compression is used.

buffer

A place, especially in RAM, for the temporary storage of data for the purpose of speeding up an operation such as printing or drive access. Data from a buffer is available more quickly than data from where the buffer got it. Typically buffers get data before it is needed so it is ready quickly when needed. Similar to cache.

burst mode

When a device seizes control of the bus, sends data, then relinquishes control of the bus. Any time a device sends data without interruption instead of taking turns with other devices.

bus

A parallel electrical pathway on the system board, connecting and shared by the parts of a computer system (especially the CPU, its support circuitry, memory, and expansion cards), used for transmitting data or electrical power from one device to another. Typically the lines in a bus are dedicated to specific functions, such as control lines, address lines, and data lines. Different bus architectures have different numbers and arrangements of these lines, and different names (for example, ISA, PCI). The most useful way of distinguishing bus architectures is by the number of simultaneous data bits they can carry. The ISA is a 16-bit bus, while PCI is a 32-bit bus.

bus master

The ability of an expansion card to control the bus without needing intervention from the CPU.

byte

Group of eight contiguous bits. Frequently written as an eight-digit binary number or a two-digit hexadecimal number. One letter of the alphabet in ASCII code takes one byte.

C**cache**

A special block of fast memory used for temporary storage of frequently used data for quick retrieval. A memory cache, sometimes called a cache store or RAM cache, is a portion of memory made of high-speed static RAM (SRAM) instead of the slower and cheaper dynamic RAM (DRAM) used for system memory. Memory caching is effective because most programs access the same data or instructions over and over. By keeping as much of this information as possible in SRAM, the computer avoids accessing the slower DRAM. See “write-back” and “write-through.”

chassis

The metal frame to which the electronic components of the computer (such as the system board, power supply, and drive bays) are attached. The chassis goes inside the system unit cover.

checksum

A number, calculated from a block of data, used to verify the integrity of that data. For example, a modem could send a block of data and include the number of 1's that occur in the block. The receiving modem could count the number of 1's it receives and compare its own number with the transmitted number. If the numbers are the same, the transmission was probably OK.

clock

Electronic timer (oscillator) used to synchronize computer operations. The oscillator generates the timing pulses that coordinate and enable the flow of data within a digital device. Also a circuit powered by battery that keeps track of the date and time for human and various system requirements.

clock speed

The frequency at which a clock oscillates. In microcomputers, measured in MHz. The faster the clock, the faster the computer can compute.

CMOS

Complementary Metal Oxide Semiconductor. A chip on the system board that contains nonvolatile memory. CMOS is backed up by an internal lithium battery that preserves clock/calendar data and system configuration parameters stored in CMOS.

codec

Coder-decoder. Used primarily with Internet phone and video conferencing products, this software compresses digitized data and decompresses it at the other end, allowing for faster data transfer and less delays

cold boot

Process of starting up the computer by turning on the power. If power is already on, the process means to turn off the computer and turn it on again. A cold boot reinitializes all devices.

compression

Any scheme for recording data with fewer bits. For example, stating how many times something occurs can be shorter than stating each occurrence. It is shorter to say "print a million white pixels" than to say "print white pixel number one, print white pixel number two . . ."

D**default**

The system's factory setting for a specific device feature or system function. A setting that a computer uses if it has not been modified by a user.

DIMM

Dual Inline Memory Module. Circuit board with pins connecting to different memory chips on both sides of the board, which allows for wider and faster data transfer (128-bit). See SIMMs.

DMA

Direct Memory Access. A method for transferring data, usually between memory and a disk drive, without going through the CPU.

DMI

Desktop Management Interface. A standard for PCs that allows manipulation of PC components over a network from a centralized location.

DRAM

Dynamic Random Access Memory. Memory used to store data in most computers. DRAM is temporary and must be continually refreshed. It is only active when the computer is turned on.

driver

A software program that enables peripheral devices (for example, printer, monitor, mouse, CD-ROM drive) to work with computers.

DVD

Digital versatile disc or digital video disc. A type of CD-ROM that holds a minimum of 4.7 GB, enough for a full-length movie. The DVD specification supports disks with capacities of from 4.7 GB to 17 GB and access rates of 600 Kbps to 1.3 Mbps. One of the features of DVD drives is that they are backward-compatible with CD-ROM disks. This means that DVD players can play old CD-ROMs, CD-I disks, and video CDs, as well as new DVD-ROMs. Newer DVD players can also read CD-R disks. DVD uses MPEG-2 to compress video data. See MPEG.

E**ECC memory**

Error Checking and Correcting memory. Advanced type of memory that can find and correct certain types of single-bit memory errors, providing greater data integrity. Advanced ECC can correct some double-bit errors.

ECP

Extended Capabilities Port. A parallel-port standard for PCs that supports bidirectional communication between the PC and attached devices (such as a printer). ECP is about 10 times faster than the older Centronics standard. Another modern parallel port for PCs that offers similar performance is the EPP (Enhanced Parallel Port).

EDO memory

Extended Data Out memory. A faster type of asynchronous computer memory that holds its last-requested data in a cache after releasing it. EDO memory is designed for use with the Intel Pentium processors.

EIDE

Extended Integrated Drive Electronics. The EIDE specification is an enhanced version of IDE that allows for faster transfer rates and supports larger hard drive sizes

enhanced VGA

A video interface that offers more colors or higher resolution than VGA.

EPP

Enhanced Parallel Port, a parallel port standard for PCs that supports bidirectional communication between the PC and attached device (such as a printer). EPP is about 10 times faster than the older Centronics standard. Another modern parallel port for PCs that offers similar performance is the ECP (Extended Capabilities Port).

extended RAM

The area of RAM above the first megabyte of memory in the system available for enhancing system performance.

F**FAT**

File Allocation Table. A table near the beginning of a drive that identifies the location of everything on the drive.

flash ROM

Method in which a computer's BIOS ROM can be upgraded without replacing the ROM BIOS chip.

FTP

File Transfer Protocol. A method of transferring files between two computers on a TCP/IP network (such as the Internet). "Anonymous FTP" (the most common usage on the Internet) allows a user to download files without having an account at the remote computer.

function key

The set of keys on the keyboard (usually F1 through F12) that let you get help and error message information or quickly select frequently used commands.

G**graphics accelerator**

A term referring to a higher end video controller that handles high-speed graphics and usually contains several megabytes of onboard video memory.

GUI

Graphical User Interface. Method of presenting information on a computer screen utilizing icons, pull-down menus, and a mouse.

H

hertz

(Hz) A unit of frequency equal to one cycle per second.

hexadecimal

A number system that uses 16 as the base. (Place value indicates powers of 16.) It uses the digits 0-9 and A-F. Used around computers because a byte (eight binary digits) easily converts to a two digit hexadecimal number. Hexadecimal numbers are often indicated with the letter H, a dollar sign, or a subscripted 16 after the number. Compare binary, decimal.

host adapter

An expansion board that serves as a controller for SCSI devices.

hot key

Combination of two or three keys (such as **Ctrl-Alt-D**) that you press simultaneously for a particular function.

hot plugging

The ability to add and remove devices to a computer while the computer is running and have the operating system automatically recognize the change. The Universal Serial Bus (see USB) external bus standard supports hot plugging. This is also a feature of PCMCIA. Hot plugging is also called hot swapping.

I

IDE

Intelligent Drive Electronics. A hard drive type that has controller electronics built into the drive and delivers high throughput.

interface

A connection that enables two devices to communicate.

interrupt

A signal from part of a system, such as an I/O device, asking to use the CPU. Interrupts are hierarchical, which prevents interrupts from interrupting each other. (Whichever interrupt has higher priority makes the other interrupt wait.) When the CPU receives an interrupt signal, it saves what it is doing, processes the routine associated with the interrupt, then returns to what it was doing.

I/O address

Input-Output address. How the CPU sees an I/O port. It puts data into this address or reads the data in it. The device at the other end of the I/O port gets the data from that address or puts the data there, respectively.

IRQ

Interrupt Request. A signal that, when received by the CPU, makes it stop what it is going to do something else. An interrupt is a way in which a particular device in a computer communicates with the CPU. PCs have 16 IRQ lines that can be assigned to different devices (for example, printers, scanners, modems). No two devices can have the same IRQ address. See interrupt.

ISA

Industry Standard Architecture. The bus architecture used in the IBM PC/XT and PC/AT. The AT version of the bus is called the AT bus and has become an industry standard. The apparent successor is the PCI local bus architecture found in most of today's computers. Most modern computers include both an AT bus for slower devices and a PCI local bus for devices that need better bus performance. In 1993, Intel and Microsoft introduced a new version of the ISA specification called Plug and Play ISA. Plug and Play ISA enables the operating system to configure expansion boards automatically so that users do not need to fiddle with DIP switches and jumpers. See plug and play.

isochronous

A form of data transmission in which individual characters are only separated by a whole number of bit-length intervals.

K

kilobyte

(KB) 1024 bytes.

L

L2 cache

Refers to "level 2" or "secondary" cache. A type of cache that resides on the motherboard except when referring to a Pentium machine, where it resides on the CPU module.

LAN

Local Area Network.

LPT1

Name assigned to the parallel port by the Windows operating system. A second parallel device is assigned LPT2 (if there is another parallel port). Also called the printer port.

M

master

Part of a two-sided communication that initiates commands (to a "slave" that carries out the commands).

megabyte

(MB) 1,048,576 bytes.

memory

Electronic storage area in a computer that retains information and programs. A computer has two types of memory: read-only memory (ROM) and random access memory (RAM).

microprocessor

A semiconductor central processing unit that is the principal component of a microcomputer. Usually contained on a single chip that includes an arithmetic logic unit, control logic, and control-memory unit.

MIDI

Musical Instrument Digital Interface. An interface for connecting suitably equipped musical instruments to suitably equipped computers.

MIF

Management Information File. A file stored on a PC that holds system data such as a model ID and serial number that can be manipulated over a network from a centralized location.

MMX

A processor architecture that enhances multimedia and communications. This technology processes multiple data elements in parallel, speeding up such things as image processing, motion video, speech synthesis, telephony, and 3-D graphics.

modem

MOdulator-DEModulator. A device that links computers over a telephone line.

MPC

Multimedia Personal Computer, a software and hardware standard developed by a consortium of computer firms led by Microsoft. There are three MPC standards, called MPC, MPC2, and MPC3, respectively. Each specifies a minimum hardware configuration for running multimedia software.

MPEG

Motion Pictures Expert Group. Audio/Video technology that allows for better than VHS quality video and almost CD quality audio by using advanced compression techniques. MPEG files allow for more realistic motion with a smaller file size than earlier formats, making it a popular format for digital full-length movies. Files in the MPEG format have an .MPG extension.

N**nonvolatile memory**

Storage media that retains its data when system power is turned off. Nonvolatile memory is a complementary metal oxide semiconductor (CMOS) chip that is backed up by an internal battery. The backup battery preserves the clock/calendar data and system configuration parameters stored in CMOS. See volatile memory.

O**operating system**

Set of programs that manage the overall operation of the computer.

overwrite

Storing information at a location where information is already stored, thus destroying the original information.

P**page**

A type of message transmission in which a message is sent or received via modem to a paging device from a computer (with paging communications software) or telephone.

parallel interface

Interface that communicates eight bits at a time.

parallel printer

A printer with a parallel interface.

parameter

A characteristic of a device or system determined by a command or setting whose purpose is to define or limit the characteristic.

password

A string of characters that the user must enter before the system allows access or system privileges.

PCI

Peripheral Component Interface/Interconnect. A self-configuring personal computer local bus designed by Intel. Most modern PCs include a PCI bus in addition to a more general ISA expansion bus. PCI is a 32-bit bus, but supports a 64-bit extension for new processors, such as the Pentium II. It can run at clock speeds of 33 or 66 MHz. At 32 bits and 33 MHz, it yields a throughput rate of 133 megabits per second. 64-bit implementations running at 66 MHz provide 524 Mbps. See ISA.

peripheral

Input or output device not under direct computer control. A printer is a peripheral device.

pixels

Picture elements. Tiny dots that make up a screen image. A pixel is the smallest spot on the screen that a computer can address.

plug and play

Refers to the ability of a computer system to automatically configure expansion boards and other devices. This enables a user to plug in a device and use it, without worrying about setting DIP switches, jumpers, and other configuration elements.

port

Any connection by which data can enter or leave a computer or peripheral. Provides the means for an interface between the microprocessor and external devices. A cable connector is usually plugged into the port to attach the device to the computer.

processor

In a computer, a functional unit that interprets and executes instructions.

prompt

A special symbol indicating the beginning of an input line. Also a message that appears on the screen indicating that the user must take a certain action.

R**RAM**

Random Access Memory. A storage device into which data is entered and from which data is retrieved in a nonsequential manner. On the system board, RAM is semiconductor-based memory that can be read and written to by the microprocessor or other hardware devices. In RAM, data can be directly and randomly read or written (with any choice for the address). It's the storage location for data that needs to be immediately available for every application in use on your computer.

read

To extract data from a storage device such as a diskette.

ROM

Read-Only Memory. Memory in which stored data cannot be modified by the user except under special conditions.

reset

The process of returning a device to zero or to an initial or arbitrarily selected condition.

resolution

The degree of screen image clarity. Video display resolution is determined by the number of pixels on the screen. Resolution is usually specified in pixels by scan lines, for example, 640 by 480. See pixels.

RS-232C

Standard interface for serial devices.

S**SEC**

Single-Edge Contact. The SEC cartridge containing the Pentium processor. See Slot 1.

serial interface

An interface that communicates information one bit at a time.

serial printer

A printer with a serial interface.

SGRAM

Synchronous Graphic Random Access Memory. A type of DRAM used increasingly on video adapters and graphics accelerators. Like SDRAM, SGRAM can synchronize itself with the CPU bus clock at speeds of up to 100 MHz. In addition, SGRAM uses several other techniques, such as masked writes and block writes, to increase bandwidth for graphics-intensive functions. Unlike VRAM and WRAM, SGRAM is single-ported (it can only be accessed by one device at a time). However, it can open two memory pages at once, which simulates the dual-port nature of other video RAM technologies (access by two different devices simultaneously). See VRAM and WRAM.

SIMM

Single Inline Memory Module. A small circuit board holding a group of memory chips. Typically, SIMMs hold up to nine RAM chips. On PCs, the ninth chip is for parity error checking. Unlike memory chips, SIMMs are measured in bytes rather than bits. In today's SIMMs, each chip holds 2 MB, so a single SIMM holds 16 MB. SIMMs are easier to install than individual memory chips. The bus from a SIMM to the actual memory chips is 32 bits wide. A newer technology, called dual in-line memory module (DIMM), provides a 64-bit bus. To take advantage of the 64-bit bus on Pentium processors, use either DIMMs or pairs of SIMMs. See DIMMs.

Slot 1

The form factor for Intel Pentium processors. The Slot 1 package replaces the Socket 7 and Socket 8 form factors used by previous Pentium processors. Slot 1 is a 242-pin daughter card slot that accepts a processor packaged as a Single Edge Contact (SEC) cartridge. A system board can have one or two Slot 1s. See SEC.

SMART

Self-Monitoring Analysis and Reporting Technology. A hard drive feature that works in conjunction with system software (for example, LANdesk Client Manager, NEC Auto Backup) for identifying a potential problem on the hard drive and automatically backing up system files to a user-specified device, such as a tape or Zip drive.

sound card

An expansion card designed for sound input and output. Sound cards can record and play back digital audio. Most also have a MIDI synthesizer, which means they can play MIDI files; some also have MIDI inputs and outputs.

super video graphics array (SVGA)

A color bit-mapped graphics display standard that provides a resolution of 1024x 768 with up to 256 colors displayed simultaneously.

synchronous

Refers to protocols that require the clocks of the communicating machines to be coordinated.

system board

The main printed circuit board inside the system unit into which other boards and major chip components, such as the system microprocessor, are connected.

T**tpi**

Tracks per inch.

track

Any of many concentric circular regions on a disk for storing data. Tracks are divided into sectors. One measure of storage density of a disk is tpi.

U**Ultra DMA**

A protocol developed by Quantum Corporation and Intel that supports burst mode data transfer rates of 33.3 MBps. This is twice as fast as the previous disk drive standard for PCs, and is necessary to take advantage of new, faster Ultra ATA disk drives. The official name for the protocol is Ultra DMA/33.

USB

Universal Serial Bus. An external bus standard that supports data transfer rates of 12 Mbps (12 million bits per second). A single USB port can be used to connect up to 127 peripheral devices, such as mice, modems, and keyboards. USB also supports Plug-and-Play installation and hot plugging. It is expected to eventually replace serial and parallel ports.

V**VESA**

Video Electronics Standards Association. The source of a SuperVGA standard used on many video boards.

virus

Software that copies itself onto hard drives and diskettes without user intervention, usually when a diskette is placed into the drive of a computer. Viruses usually trigger a harmless or destructive occurrence on the system, activated by some preset condition. Viruses are frequently written with antisocial intent.

VGA

Video Graphics Array. Graphics technology that supports up to 256 K colors and a graphics resolution of 640 by 480 pixels.

volatile memory

Storage media that loses its data when system power is turned off. Standard memory and memory added to the system are volatile memory. See nonvolatile memory.

VRAM

Video RAM. VRAM is special-purpose memory used by video adapters. Unlike conventional RAM, VRAM can be accessed by two different devices simultaneously. This enables a video adapter to access the VRAM for screen updates at the same time that the CPU provides new data. VRAM yields better graphics performance but is more expensive than normal RAM. A special type of VRAM, called Windows RAM (WRAM), yields even better performance than conventional VRAM. See SGRAM and WRAM.

W

warm boot

Process of resetting the computer without turning off the power through keyboard input (pressing **Ctrl**, **Alt**, and **Del** keys simultaneously) or the reset button. The system returns to an initial or arbitrarily selected condition.

WRAM

Windows RAM. A type of RAM that supports two ports. This enables a video adapter to fetch the contents of memory for display at the same time that new bytes are being pumped into memory. This results in much faster display than is possible with conventional single-port RAM. WRAM is similar to VRAM, but achieves even faster performance at less cost because it supports addressing of large blocks (windows) of video memory. See VRAM and SGRAM.

write

To record or store information to a storage device.

write-back

Also called copy back. A cache strategy where write operations to data stored in the internal microprocessor L1 cache aren't copied to system memory until absolutely necessary. In contrast, a write-through cache performs all write operations in parallel; data is written to system memory and the L1 cache simultaneously. Write-back caching yields somewhat better performance than write-through caching because it reduces the number of write operations to main memory. See cache and write-through.

write-through

Also write-thru. Write-through characterizes a cache strategy where data is always written into system memory when data is written by the CPU. See cache and write back.

Index

A

- Addresses
 - parallel port, 2-3
- Advanced menu (BIOS), 2-13
- AGP board, 1-11
 - features, 4-16
 - removal, 3-9
- Application and Driver CD
 - using, 2-26
- Audio
 - features, 4-17

B

- Battery
 - removal, 3-23
- BBS, 8-4
- BIOS
 - features, 4-12
- BIOS Setup utility
 - Advanced menu, 2-13
 - Exit menu, 2-18
 - Main menu, 2-9, 2-10
 - navigation keys, 2-10
 - Security menu, 2-17
 - starting, 2-9
 - uses, 2-10
- BIOS updates, 2-18
- Blank panel
 - removal, 3-10
- Bulletin board service, 8-4

C

- Cables
 - external connector locations, 4-2
 - internal connector and socket locations, 4-3
- Cache
 - secondary, 4-12
- CD-ROM drive jumpers
 - Lite-On CD-ROM, 2-8
 - NEC CD-ROM, 2-7
- CD-ROM drives
 - cabling, 1-11
 - features, 1-11
 - Lite-On 32X/40X specifications, 9-13
 - NEC 32X specifications, 9-14
- Cheyenne Backup, 2-28
- CMOS battery
 - removal, 3-23

- CMOS clear
 - setting jumper, 4-6
- Components, 1-9
 - AGP board, 1-11
 - CD-ROM drive, 1-11
 - fax/modem board, 1-12
 - hard drive, 1-10
 - keyboard, 1-10
 - local area network, 1-12
 - mouse, 1-11
 - pc adapter device, 1-12
 - power supply, 1-10
 - speakers, 1-11
 - system board, 1-9
 - tape backup unit, 1-12
 - Zip drive, 1-13

- Configuration
 - BIOS Setup utility, 2-9
 - FLASH utility, 2-18
- Configuration jumper
 - settings, 2-5
- Configurations, 1-2, 1-3

D

- Device removal
 - 3 1/2-inch diskette drive, 3-20
 - 3 1/2-inch hard disk, 3-19
 - 5 1/4-inch device, 3-18
- DIMM module
 - removal, 3-11
- Disassembly
 - 3 1/2-inch diskette drive, 3-20
 - 3 1/2-inch hard drive, 3-19
 - 5 1/4-inch device, 3-18
 - AGP board, 3-9
 - blank panel, 3-10
 - CMOS battery, 3-23
 - DIMM module, 3-11
 - expansion board, 3-8
 - front panel, 3-9
 - general rules, 3-2
 - left side cover, 3-3
 - metal slot cover, 3-10
 - power supply, 3-21
 - right side cover, 3-6
 - system board, 3-22
- Diskette
 - flash, 2-18

Diskette drive, 1-10
removal, 3-20
specifications, 9-5

DMA settings
functions, 4-21

Documentation, online
NEC Help Center, 2-27

DVD-ROM drives
Hitachi 4X specifications, 9-15

E

Email/fax technical support, 8-3

Environmental and safety
specifications, 9-18

Exit menu (BIOS), 2-18

Expansion board
removal, 3-8

F

Fax/modem board, 1-12
specifications, 9-11

Features
back, 1-5
security, 1-8
system board, 4-10

Field replaceable units list, 5-3

FLASH diskette, 2-18

Front features, 1-4

Front panel
removal, 3-9

FRU list, 5-3

FTP site, 8-4

Fujitsu hard drive
8.4-GB hard drive specifications, 9-8

G

Graphics
AGP board, 1-11
ATI Expert 98 AGP board specifications,
9-12
ATI Minden AGP board specifications,
9-12
Diamond Viper board specifications, 9-13

Graphics boards
features, 4-15

Graphics controller
features, 4-16

H

Hard drive, 1-10
removal, 3-19

Hard drive jumpers
Maxtor hard drive, 2-7
Seagate hard drive, 2-7

I

I/O addresses
map, 4-18

Illustrated parts breakdown
IPB, 5-5
parts lists, 5-2

Inside features, 1-7

Installing
NEC Help Center, 2-27

Integrated audio
features, 4-17

Intel processor serial number control utility,
2-29

Interrupts
parallel port, 2-3
serial port, 2-4
system IRQs, 2-2

IPB, 5-5

IRQs, 2-2

ISA bus
features, 4-13

J

Jumpers
clear CMOS, 4-3
configuration select, 2-5
Lite-On CD-ROM, 2-8
Maxtor IDE hard drive, 2-7
NEC CD-ROM, 2-7
power on mode, 4-3
processor speed, 4-3
Seagate IDE hard drive, 2-7
settings, 2-4
system board, 4-3
tape backup unit, 2-8
Zip drive, 2-8

K

Keyboard, 1-10
cleaning, 6-2
specifications, 9-3

L

Left side cover
disassembly, 3-3
replacing, 3-4

Lite-On CD-ROM drive jumpers, 2-8

M

Main menu (BIOS), 2-9, 2-10

Maintenance
keyboard cleaning, 6-2
mouse cleaning, 6-3
system cleaning, 6-2

-
- Maxtor hard drive
 - 12.9-GB hard drive specifications, 9-10
 - 4.3-GB hard drive specifications, 9-7
 - 8.4-GB hard drive specifications, 9-9
 - Memory
 - checking system, 4-9
 - features, 4-13
 - upgrade sockets, 4-8
 - Memory map
 - functions, 4-18
 - Metal slot cover
 - removal, 3-10
 - Motion video controller
 - features, 4-16
 - Mouse, 1-11
 - cleaning, 6-3
 - specifications, 9-4
 - N**
 - NEC CD-ROM drive jumpers, 2-7
 - NEC CSD service and support
 - bulletin board service (BBS), 8-4
 - email/fax technical support, 8-3
 - FTP site, 8-4
 - product information, 8-4
 - technical support services, 8-3
 - telephone numbers, 8-2
 - website, 8-2
 - NEC CSD service and support information, 8-2
 - NEC Help Center, 2-27
 - installing, 2-27
 - uninstalling, 2-27
 - Network, 1-12
 - O**
 - Online documentation
 - NEC Help Center, 2-27
 - OS Restore CD, 2-19
 - P**
 - Parallel interface
 - features, 4-14
 - Parallel port
 - addresses, 2-3
 - interrupts, 2-3
 - Parts
 - FRU list, 5-3
 - ordering, 5-2
 - Password
 - clear and reset, 4-6
 - security, 1-8
 - PC adapter device, 1-12
 - specifications, 9-15
 - PCI local bus
 - features, 4-13
 - PCI/IDE ports
 - features, 4-14
 - Plug and play
 - features, 4-13
 - Power on mode
 - setting jumper, 4-5
 - Power supply, 1-10
 - removal, 3-21
 - specifications, 9-10
 - Preventive maintenance
 - keyboard cleaning, 6-2
 - mouse cleaning, 6-3
 - system cleaning, 6-2
 - Problems
 - diagnosing and solving, 7-6
 - Processor
 - Celeron installation, 3-13
 - Celeron removal, 3-12
 - features, 4-12
 - Pentium II installation, 3-16
 - Pentium II removal, 3-15
 - Pentium III installation, 3-13
 - Pentium III removal, 3-12
 - removal/replacing, 3-11
 - setting speed, 4-4
 - upgrade socket, 4-8
 - Product information, 8-4
 - R**
 - Reassembly
 - left side cover replacement, 3-4
 - right side cover replacement, 3-7
 - Release notes
 - general notes, A-2
 - Intel processor serial number control utility, A-12
 - LS-120 SuperDisk Copy, A-7
 - NEC OS Restore CD, A-8
 - new system board jumper settings, A-10
 - PIIX4 limitations, A-9
 - SCSI drive limitations, A-6
 - Windows 95 issues, A-14
 - Windows 98 issues, A-15
 - Windows NT issues, A-16
 - Resources
 - DMA settings, 4-21
 - I/O addresses, 4-18
 - memory map, 4-18

-
- Right side cover
 - disassembly, 3-6
 - replacing, 3-7
 - S**
 - Seagate IDE hard drive
 - 4.3-GB drive specifications, 9-6
 - Security
 - features, 1-8
 - locking tab, 1-8
 - Security menu (BIOS), 2-17
 - Serial interface
 - features, 4-15
 - Serial port
 - addresses, 2-4
 - interrupts, 2-4
 - Sockets
 - processor and memory upgrade, 4-8
 - Speakers
 - set, 1-11
 - specifications, 9-4
 - Specifications
 - 12.9-GB Maxtor hard drive, 9-10
 - 4.3-GB Maxtor hard drive, 9-7
 - 4.3-GB Seagate hard drive, 9-6
 - 8.4-GB Fujitsu hard drive, 9-8
 - 8.4-GB Maxtor hard drive, 9-9
 - ATI Expert 98 AGP board, 9-12
 - ATI Minden AGP board, 9-12
 - Diamond Viper graphics board, 9-13
 - diskette drive, 9-5
 - environmental and safety, 9-18
 - fax/modem board, 9-11
 - Hitachi 4X DVD-ROM, 9-15
 - keyboard, 9-3
 - Lite-On 32X/40X CD-ROM, 9-13
 - mouse, 9-4
 - NEC 32X CD-ROM, 9-14
 - PC adapter device, 9-15
 - power supply, 9-10
 - speaker, 9-4
 - system, 9-2
 - system board, 9-3
 - system unit, 9-5
 - tape backup unit, 9-16
 - Zip drive, 9-17
 - Starting BIOS Setup utility, 2-9
 - System
 - cleaning, 6-2
 - System board, 1-9
 - features, 4-10
 - major components, 4-11
 - removal, 3-22
 - specifications, 9-3
 - System components, 1-9
 - AGP board, 1-11
 - CD-ROM drive, 1-11
 - diskette drive, 1-10
 - fax/modem board, 1-12
 - hard drive, 1-10
 - keyboard, 1-10
 - local area network, 1-12
 - mouse, 1-11
 - pc adapter device, 1-12
 - power supply, 1-10
 - speakers, 1-11
 - system board, 1-9
 - tape backup unit, 1-12
 - Zip drive, 1-13
 - System configuration
 - interrupt requests, 2-2
 - jumper settings, 2-4
 - System configurations, 1-2, 1-3
 - System features
 - back, 1-5
 - inside features, 1-7
 - security, 1-8
 - System interrupts, 2-2
 - System overview, 1-2
 - configurations, 1-2, 1-3
 - front features, 1-4
 - System specifications, 9-2
 - System unit specifications, 9-5
 - T**
 - Tape backup unit
 - features, 1-12
 - jumpers, 2-8
 - specifications, 9-16
 - Technical support services, 8-3
 - Telephone numbers
 - service and support, 8-2
 - Troubleshooting, 7-2
 - CD-ROM drive, 7-5
 - diskette drive, 7-4
 - keyboard/mouse, 7-5
 - monitor, 7-4
 - problem checklist, 7-2
 - problem diagnostics, 7-6
 - speakers, 7-6
 - U**
 - Uninstalling, NEC Help Center, 2-27
 - Upgrading
 - BIOS, 2-18
-

USB interface

features, 4-15

Utilities

Cheyenne Backup, 2-28

W

Wake-On Lan

setting jumper JWOL, 4-7

Website, 8-2

Windows network security, 1-8

Z

Zip drive, 1-13

jumpers, 2-8

specifications, 9-17

Regulatory Statements

- FCC Statement
- Note for Canada
- Battery Replacement
- Battery Disposal

The following regulatory statements provide information about use of the PowerMate VT 300i Series computer:

- FCC Statement (For United States Only)
- Note for Canada
- Battery Replacement
- Battery Disposal.

FCC Statement (For United States Use Only)

WARNING: Changes or modifications to this unit not expressly approved by the party responsible for compliance could void the user's authority to operate the equipment.

NOTE: This equipment has been tested and found to comply with the limits for a Class B digital device, pursuant to Part 15 of the FCC Rules. These limits are designed to provide reasonable protection against harmful interference in a residential installation. This equipment generates, uses and can radiate radio frequency energy and, if not installed and used in accordance with the instructions, may cause harmful interference to radio communications.

However, there is no guarantee that interference will not occur in a particular installation. If this equipment does cause harmful interference to radio or television reception, which can be determined by turning the equipment off and on, the user is encouraged to try to correct the interference by one or more of the following measures.

- Reorient or relocate the receiving antenna.
- Increase the separation between the equipment and receiver.
- Connect the equipment to an outlet on a circuit different from the one to which the receiver is connected.

Use shielded and properly grounded I/O cables and power cable to ensure compliance of this unit to the specified limits of the rules.

Note for Canada

This Class B digital apparatus meets all requirements of the Canadian Interference-Causing Equipment Regulations.

Cet appareil numérique de la classe B respecte toutes les exigences du Règlement sur le matériel brouilleur du Canada.

Battery Replacement

A lithium battery in some computers maintains system configuration information. In the event that the battery fails to maintain system configuration information, NEC recommends that you replace the battery. For battery replacement information, see “CMOS Battery Removal” in Section 3 of this manual or call your NEC CSD dealer or the NEC CSD Technical Support Center.

WARNING: There is a danger of explosion if the battery is incorrectly replaced. Replace only with the same or equivalent type recommended by the manufacturer. Discard used batteries according to the manufacturer’s instructions.

ATTENTION: Il y a danger d’explosion s’il y a remplacement incorrect de la batterie. Remplacer uniquement avec une batterie du même type ou d’un type recommandé par le constructeur. Mettre au rebut les batteries usagées conformément aux instructions du fabricant.

Battery Disposal

Do not place used batteries in your regular trash.

The nickel-cadmium or nickel metal-hydride batteries must be collected, recycled, or disposed of in an environmentally-approved manner.

The incineration, landfilling, or mixing of batteries with the municipal solid waste stream is **prohibited by law** in most areas.

Return batteries to a federal or state approved battery recycler. This may be where you purchased the battery or a local seller of automotive batteries.

Contact your local waste management officials for other information regarding the environmentally sound collection, recycling, and disposal of the batteries.

NEC

NEC Computer Systems Division
Packard Bell NEC, Inc.
1 Packard Bell Way
Sacramento, CA 95828-0903
www.nec-computers.com

456-00050-000SRV
5/99

Free Manuals Download Website

<http://myh66.com>

<http://usermanuals.us>

<http://www.somanuals.com>

<http://www.4manuals.cc>

<http://www.manual-lib.com>

<http://www.404manual.com>

<http://www.luxmanual.com>

<http://aubethermostatmanual.com>

Golf course search by state

<http://golfingnear.com>

Email search by domain

<http://emailbydomain.com>

Auto manuals search

<http://auto.somanuals.com>

TV manuals search

<http://tv.somanuals.com>