

# NEC



## Aspire ISDN - PRI

Technical Support Web Site:  
<http://ws1.necii.com> (registration is required)

This manual has been developed by NEC Unified Solutions, Inc. It is intended for the use of its customers and service personnel, and should be read in its entirety before attempting to install or program the system. Any comments or suggestions for improving this manual would be appreciated. Forward your remarks to:

NEC Unified Solutions, Inc.  
4 Forest Parkway  
Shelton, CT 06484  
**[www.necunifiedsolutions.com](http://www.necunifiedsolutions.com)**

Nothing contained in this manual shall be deemed to be, and this manual does not constitute, a warranty of, or representation with respect to, any of the equipment covered. This manual is subject to change without notice and NEC Unified Solutions, Inc. has no obligation to provide any updates or corrections to this manual. Further, NEC Unified Solutions, Inc. also reserves the right, without prior notice, to make changes in equipment design or components as it deems appropriate. No representation is made that this manual is complete or accurate in all respects and NEC Unified Solutions, Inc. shall not be liable for any errors or omissions. In no event shall NEC Unified Solutions, Inc. be liable for any incidental or consequential damages in connection with the use of this manual. This document contains proprietary information that is protected by copyright. All rights are reserved. No part of this document may be photocopied or reproduced without prior written consent of NEC Unified Solutions, Inc.

© 2004 by NEC Unified Solutions, Inc. All Rights Reserved  
Printed in U.S.A.

<b>Section 1</b> .....	<b>1</b>
ISDN PRI Features .....	1
<b>Introduction to ISDN</b> .....	<b>3</b>
About ISDN .....	3
<b>ISDN Features</b> .....	<b>5</b>
Primary Rate Interface (PRI) Installation .....	5
Description .....	5
Conditions .....	5
Installing the Aspire T1/PRI Interface PCB (P/N 0891009) .....	5
Primary Rate Interface (PRI), Answering Calls .....	10
Description .....	10
Conditions .....	11
Default Setting .....	11
Programming .....	12
Related Features .....	20
Operation .....	20
Primary Rate Interface (PRI), Placing Calls .....	22
Description .....	22
Conditions .....	22
Default Setting .....	22
Programming .....	23
Related Features .....	32
Operation .....	32
<b>Section 2</b> .....	<b>34</b>
ISDN PRI Programming .....	34
<b>Programming</b> .....	<b>36</b>
Before You Start Programming .....	36
Before Reading This Section .....	36
How to Use This Section .....	36
How to Enter the Programming Mode .....	37
How to Exit the Programming Mode .....	37
Using Keys to Move Around in the Programs .....	38
Programming Names and Text Messages .....	39
Using Soft Keys For Programming .....	41
What the Soft Key Display Prompts Mean .....	41

# Table of Contents

---

<b>Program 10 : System Configuration Setup</b> .....	<b>42</b>
10-03 : PCB Setup .....	42
10-08 : Pre-Ringing Setup .....	45
<b>Program 11 : System Numbering</b> .....	<b>48</b>
11-01 : System Numbering .....	48
11-09 : Trunk Access Code .....	57
<b>Program 14 : Trunk, Basic Setup</b> .....	<b>60</b>
14-01 : Basic Trunk Data Setup .....	60
14-05 : Trunk Group .....	62
14-07 : Trunk Access Map Setup .....	64
<b>Program 15 : Extension, Basic Setup</b> .....	<b>66</b>
15-01 : Basic Extension Data Setup .....	66
15-02 : Multi-Line Telephone Basic Data Setup .....	68
15-06 : Trunk Access Map for Extensions .....	70
15-07 : Programmable Function Keys .....	72
<b>Program 20 : System Option Setup</b> .....	<b>74</b>
20-02 : System Options for Multi-Line Telephones .....	74
20-06 : Class of Service for Extensions .....	76
20-08 : Class of Service Options (Outgoing Call Service) .....	78
20-09 : Class of Service Options (Incoming Call Service) .....	80
20-13 : Class of Service Options (Supplementary Service) .....	82
20-15 : Ring Cycle Setup .....	84
20-19 : System Options for Caller ID .....	86
<b>Program 21 : Outgoing Call Setup</b> .....	<b>87</b>
21-01 : System Options for Outgoing Calls .....	87
21-08 : Repeat Dial Setup .....	88
21-12 : ISDN Calling Party Number Setup for Trunks .....	90
21-13 : ISDN Calling Party Number Setup for Extensions .....	92
21-15 : Individual Trunk Group Routing for Extensions .....	94

## Table of Contents

---

<b>Program 22 : Incoming Call Setup</b> .....	<b>97</b>
22-01 : System Options for Incoming Calls .....	97
22-02 : Incoming Call Trunk Setup .....	99
22-03 : Trunk Ring Tone Range .....	101
22-04 : Incoming Extension Ring Group Assignment .....	103
22-05 : Incoming Trunk Ring Group Assignment .....	105
22-06 : Normal Incoming Ring Mode .....	107
22-08 : DIL/IRG No Answer Destination .....	109
22-11 : DID Translation Number Conversion .....	111
<b>Program 35 : SMDR Options</b> .....	<b>115</b>
35-02 : SMDR Output Options .....	115
<b>Program 81 : Basic Hardware Setup for Trunk</b> .....	<b>117</b>
81-01 : COIU Initial Data Setup .....	117
<b>Program 82 : Basic Hardware Setup for Extension</b> .....	<b>121</b>
82-01 : Incoming Ring Tone .....	121

# ***Table of Contents***

---

# **Section 1:**

# **ISDN PRI Features**

# Section 1

## *ISDN PRI Features*

---



**!! Important !!**

*ISDN is an emerging technology on the leading edge of international digital communication's networking.* Always check with your NEC Unified Solutions Technical Service Representative before setting up your ISDN application. Working together will ensure maximum compatibility and reliable ISDN performance.

This manual describes programs required for the PRI feature. Make sure to refer to the Aspire Software Manual, P/N 0893200, for complete programming information for all other Aspire features.

# Introduction to ISDN

## *About ISDN*

---

# ISDN Features

## Primary Rate Interface (PRI) Installation

---

---

### Description

Your system is compatible with ISDN Primary Rate Interface (PRI) services. The PRI services currently supported include:

- Basic PRI Call Control (BCC).
- Display of incoming caller's number (with software 1.02 or higher and when allowed by the telco).
- Routing in the system based on the number the caller dialed (Called Number Information element).
- ISDN maintenance functions (such as In Service/Out of Service Messaging).
- Speech and 3.1KHz audio.

---

### Conditions

- Each T1/PRI Interface PCB is switch selectable between T1 and PRI operation. For more on T1 trunking, refer to the T1 Trunking feature in your system's Software Manual (P/N 0893200).

---

### Installing the Aspire T1/PRI Interface PCB (P/N 0891009)

#### System Requirements:

- T1/PRI Interface PCB, P/N 0891009
- Aspire system software: Any Version
- NTCPU (P/N 0891002) with PAL Upgrade (P/N 0891039) **OR** Enhanced NTCPU (P/N 0891038)
- For DTMF receivers with such options as ANI/DNIS
- CSU/DSU Unit and interconnecting cables (see below)

The T1/PRI PCB has a single 24 channel circuit which you can configure for either T1 trunking or PRI. When set for PRI, each T1/PRI PCB provides 24 PRI (23 B & 1 D) channels with 64K Clear Channel response. Each PCB uses a single slot in the system cabinet.

Connecting the T1/PRI Interface PCB requires the following equipment.

- |   |
|---|
| <ul style="list-style-type: none"><li>● Satellite 931 CSU (P/N 85945)</li><li>● External 8-pin RJ-45 crossover cable required</li><li>● T1/PRI Interface PCB (P/N 92060A)</li></ul> |
|---|

When installed, the T1/PRI Interface PCB uses the first block of 24 consecutive trunks. For example, if you have an 8COIU PCB installed for trunks 1-8, the T1/PRI Interface PCB will automatically use trunks 9-32. If you have 8COIU PCBs installed for trunks 1-8 and 17-24, the T1/PRI PCB will use trunks 25-48. The T1/PRI Interface cannot use trunks 9-16 (even if available) since they are not part of a consecutive block of 24 trunks.

# ISDN Features

## Primary Rate Interface (PRI) Installation

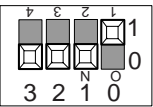
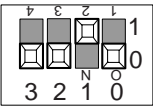
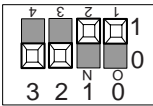
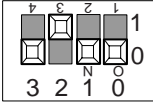
T1/PRI Interface PCB Switches		
Switch Name	Switch Position	Result
SW100	1.5M(PI/T1)	Connecting a PRI/T1 (1.544Mb/s) line.
	2M (PRI/E1)	Connecting a PRI/E1 (2.048Mb/s) line.
SW101	T	T-Bus Connection
	S	S-Bus Connection
SW3 (4 bit dip switch)		PRI (1.544Mb/s)
		T1 (1.544Mb/s)
SW3 (4 bit dip switch) (Cont'd)		PRI (2.048Mb/s)
		E1 (2.048Mb/s)
CN11	Normal	Idle
	Loop	Used with Loop Back testing only.

# ISDN Features

## Primary Rate Interface (PRI) Installation

### Connector Pin-Outs on T1/PRI PCB

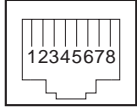
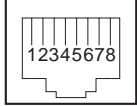
RJ45 Cable Connector - CN3 S-Bus Connection		
	Pin No.	Connection
	1	TA
	2	TB
	3	-
	4	RA
	5	RB
	6	-
	7	-
	8	-
RJ45 Cable Connector - CN3 T-Bus Connection		
	Pin No.	Connection
	1	RA
	2	RB
	3	-
	4	TA
	5	TB
	6	-
	7	-
	8	-

Network Interface Pinout for the 8-Pin RJ48C Connector	
Pin No.	Connection
1	RxD (R1)
2	RxD (T1)
4	TxD (R)
5	TxD (T)
3, 6	No Connection
7, 8	No Connection

For connection to T1 network: Use AT&T Type ABAM cable or equivalent (individually-shielded twisted pair, rated at 100 ohms at 1 MHz).

Terminal Interface Pinout for the 8-Pin RJ48C Connector	
Pin No.	Connection
1	RxD (R)
2	RxD (T)
4	TxD (R1)
5	TxD (T1)
3, 6	No Connection
7, 8	No Connection

# ISDN Features

## Primary Rate Interface (PRI) Installation

---

### To install a T1/PRI Interface PCB:

1. Attach a grounded wrist strap to your wrist and a grounded metal object (such as CEU ground).
2. To remove the front cover, loosen the two front panel retaining screws. Slide the front cover to the right then pull straight out.
3. Set the run/block switch DOWN.
4. Make sure the SW100 switch on the T1/PRI Interface PCB is set to 1.5M (PRI/T1).
5. Set the SW101 dip switches on the T1/PRI PCB for either T-Bus or S-Bus mode.
6. Set the SW3 dip switches on the T1/PRI PCB for either PRI Mode or T1 Mode.
7. Plug the T1/PRI Interface PCB into any universal slot.  
*Note that the white PCB Pull Tab should always be positioned closest to the top of the cabinet.*
8. Set the RUN/BLOCK switch UP.  
*With normal operation, the status LED will flash fast. If trouble was found during the self diagnostics routine, the status LED will flash slowly.*  
*Once connected, the ISDN Layer Link Status LEDs will be on steady when the Layer link is established. If there is no link, the LED will be off.*
9. Connect the cable from the NT1 Network Termination cable to the CN3 connector on the T1/PRI PCB.  
*The CSU connects to the network through an 8-pin RJ45/RJ48 connector. With PRI Networking, a cross-over cable must be used on the master system's T1/PRI PCB or CSU to the telco demarcation. If the systems are networked side by side and not through telco, then a straight-through cable is used.*
10. Connecting a Satellite 931 CSU (P/N 85945):
  - Connect the cable from the T1/PRI PCB to the 'LOCAL EQUIPMENT' connector on the back panel of the CSU.
  - Using the 8-pin RJ48C-RJ48C modular cable that was shipped in the box with the Satellite 931 CSU, connect the cable to the 'T1 NETWORK' connector on the back panel of the CSU.
  - Connect the opposite end of the NETWORK cable to the telco connection.
11. Replace the cover and tighten the two captive screws on the right side of the cabinet cover.

# ISDN Features

## Primary Rate Interface (PRI) Installation

Figure 1: Satellite CSU Connection

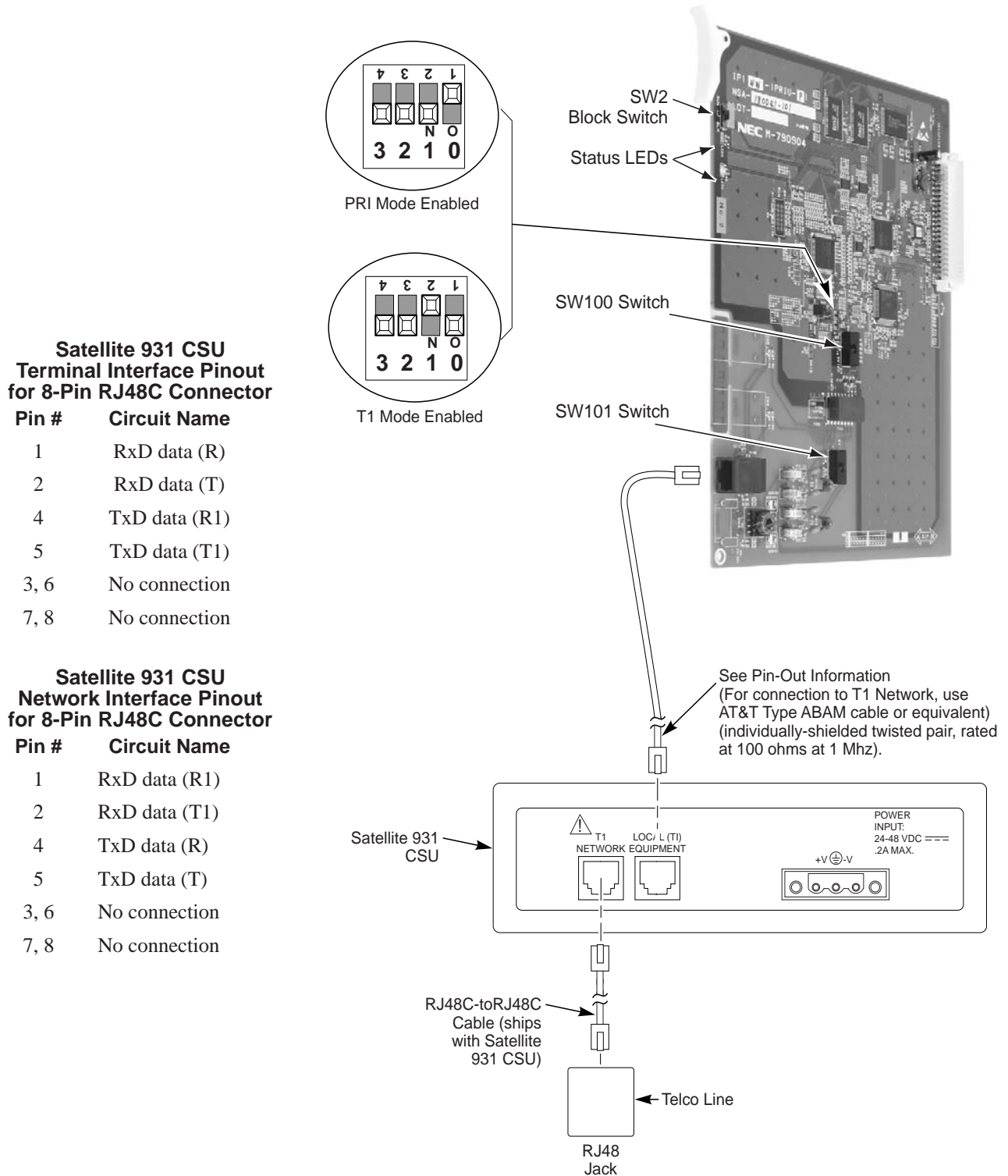

# ISDN Features

## *Primary Rate Interface (PRI) Installation*

---

- For Your Notes -



# ISDN Features

## Primary Rate Interface (PRI), Answering Calls

---

---

### Description

The system provides flexible routing of incoming PRI calls to help meet the exact site requirements. This allows PRI calls to ring and be answered at any combination of system extensions. Many of the options available to incoming analog trunk calls are also available to incoming PRI calls.

#### Delayed Ringing

Extensions in a Ring Group can have delayed ringing for PRI trunks - just like other types of trunks. If the PRI trunk is not answered at its original destination, it rings the DIL No Answer Ring Group. This could, for example, help a secretary that covers calls for their boss. If the boss doesn't answer the call, it rings the secretary's phone after a programmable time.

#### Calling Name Delivery

If provided by the telco, and depending on the version of your system software, the system can support calling name delivery in the Facility Information Element. With this information available, display telephone users can see the name of the calling party.

#### Caller ID

With Caller ID enabled, the system will provide information for ISDN calls that do not contain the Caller ID information. If the Caller ID information is restricted, the telephone display will show "PRIVATE". If the system is not able to provide Caller ID information because the telco information is not available, then the display will show "OUT OF AREA".

#### SMDR Includes Dialed Number

The SMDR report can optionally print the trunk's name (entered in system programming) or the number the incoming caller dialed (i.e., the dialed ISDN digits). This gives you the option of analyzing the SMDR report based on the number your callers dial. (This option also applies to a DID trunk as well.)

#### Calling Party Number Notification

The system can provide calling party number notification for outgoing ISDN calls. When a call is made on an ISDN line by an extension, the system will send the identification for the extension placing the call, if it's programmed. If there is no Extension Calling Number assigned, the system will send the calling number for the ISDN trunk. If both the extension and trunk information is programmed, the extension information will be sent as it takes priority.

When the option for calling party subaddress is on, the extension number will be sent as the subaddress information. Both the calling party number and calling party subaddress are sent in a SETUP message as the calling party information element and a calling party subaddress information element. Allow the system to send the subaddress by setting the following programs: 10-03-05=1, 15-01-04=1, 20-08-13=1, 21-13-01=enter number to be sent.

#### Calling Line Identification Presentation

*CLIP display available with software 1.02+.*

A Class of Service option has been added which can be used to allow the Calling Party Number IE in the Setup Message.

#### Calling Party Allowed or Prevented for Extension

*Calling Party allowed for extension with software 1.04+.*

The system allows the Calling Party Number for outgoing ISDN calls based on the extension's set up in **Program 15-01-04 : Basic Extension Data Setup - ISDN Caller ID**. If this option is to be enabled, then it must also be enabled for the BRI or PRI PCB in **10-03-05 : PCB Setup - CLIP Information**.

# ISDN Features

## Primary Rate Interface (PRI), Answering Calls

---

### How the Telco Handles PRI Trunks

In many cases, the telco will route an incoming PRI call to any of the available 23 circuits on the PRI PCB. This makes it difficult to determine the type of call by the trunk that is ringing. It also prevents using Direct Inward Lines to route incoming calls, since any call sent to the PRI PCB can appear on any circuit. During programming, *set up all trunks on the same PRI PCB in the same way*. Refer to *Programming* below.

To provide more precise routing of PRI trunks, set up PRI Direct Inward Dialing (DID). With DID, the system uses the last three or four digits of the *Called Number Information Element* to route an incoming call via the system's DID translation tables. When programming PRI trunks for DID, refer to the Aspire Software Manual (P/N 0893200) for additional DID programming.

In addition, in areas where ISDN is not uniformly implemented, many ISDN calls may route to the 3.1 KHz Audio Ring Group. This can occur if the telco automatically designates a call as 3.1 KHz when it is from a non-ISDN telephone. To provide uniform treatment of incoming PRI calls, consider having the Ring Group assignments for both normal PRI calls and 3.1KHz Audio calls. Refer to *Programming* below for more information.

### How the Telephone System Handles PRI Trunks

The Channel ID of an incoming SETUP message on a PRI line is related to the trunk group number. The system will create the trunk line number as the lowest trunk port number in the range of the same trunk group related to the channel number of the Channel ID information element of an incoming call's SETUP message.

For example, referring to the chart below, the system translates the call as being trunk port 4.

Trunk Number	Trunk Group	Channel Number
1	1	1
2	1	2
3	1	3
4	2	4
5	2	5
6	2	6
7	2	7
8	5	8
... 23	... 5	... 23

<--- Incoming Call

---

## Conditions

- PRI requires the installation of a T-Serve II CSU (P/N 85950) or Quad Datasmart DSU (P/N 85956). Consult your sales representative for more information.

*All 23 circuits on the PRI PCB must be identically programmed since any call sent to the PRI PCB can appear on any circuit.*

---

## Default Setting

- Once set, PRI trunks ring extension 301 and flash at all other extensions just like other trunk calls.

# ISDN Features

## Primary Rate Interface (PRI), Answering Calls

### Programming

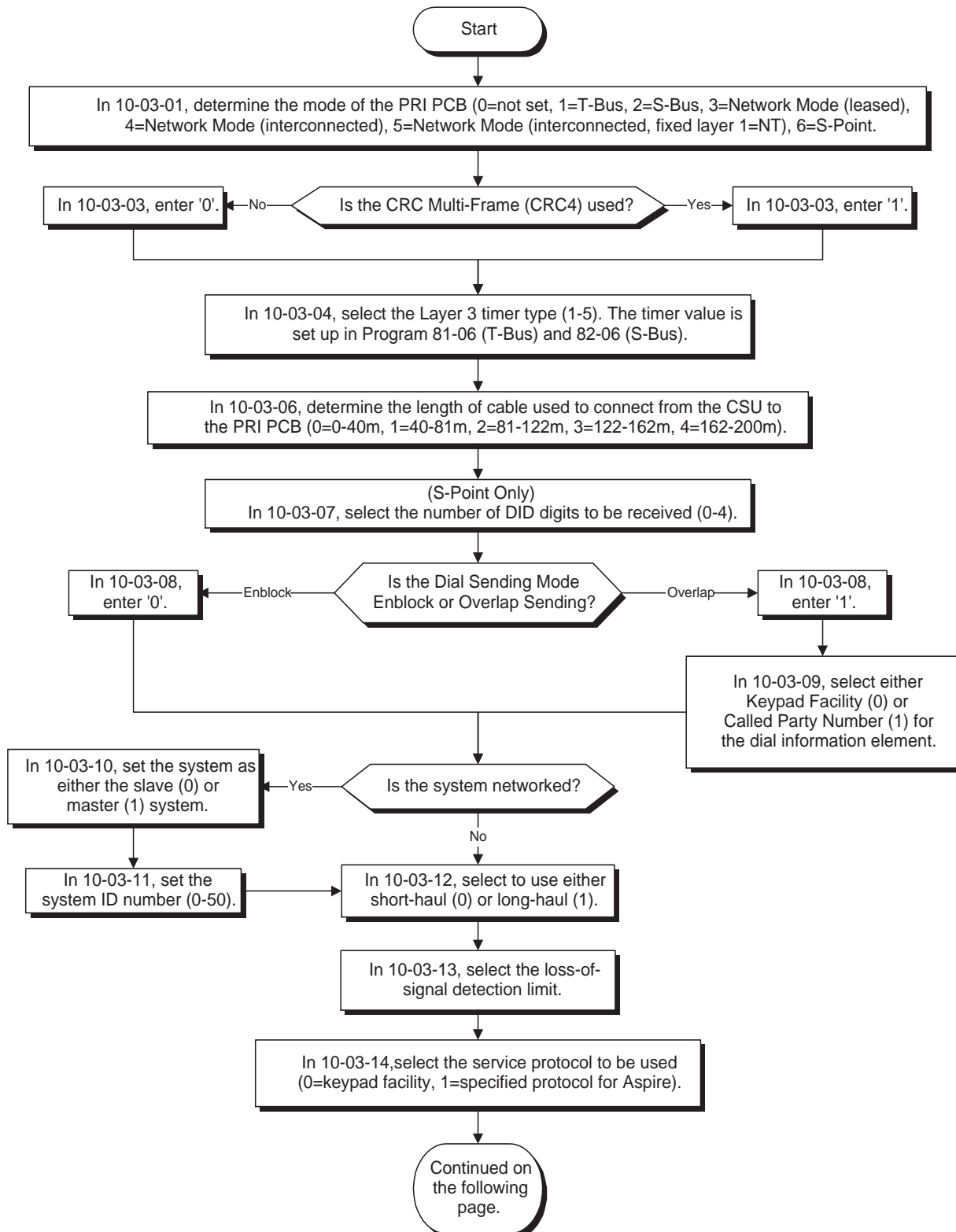

# ISDN Features

## Primary Rate Interface (PRI), Answering Calls

### Programming (Cont'd)

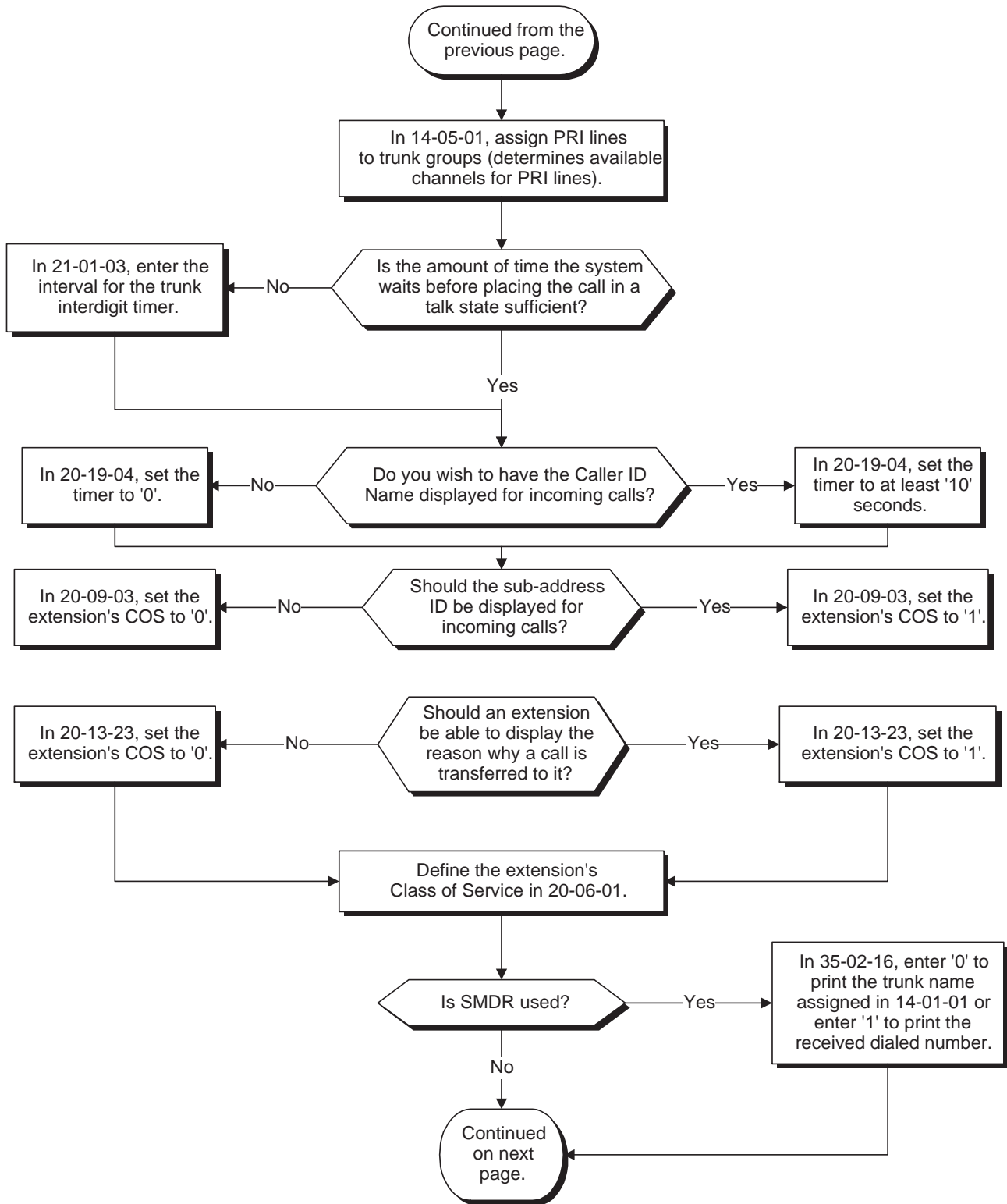

# ISDN Features

## Primary Rate Interface (PRI), Answering Calls

### Programming (Cont'd)

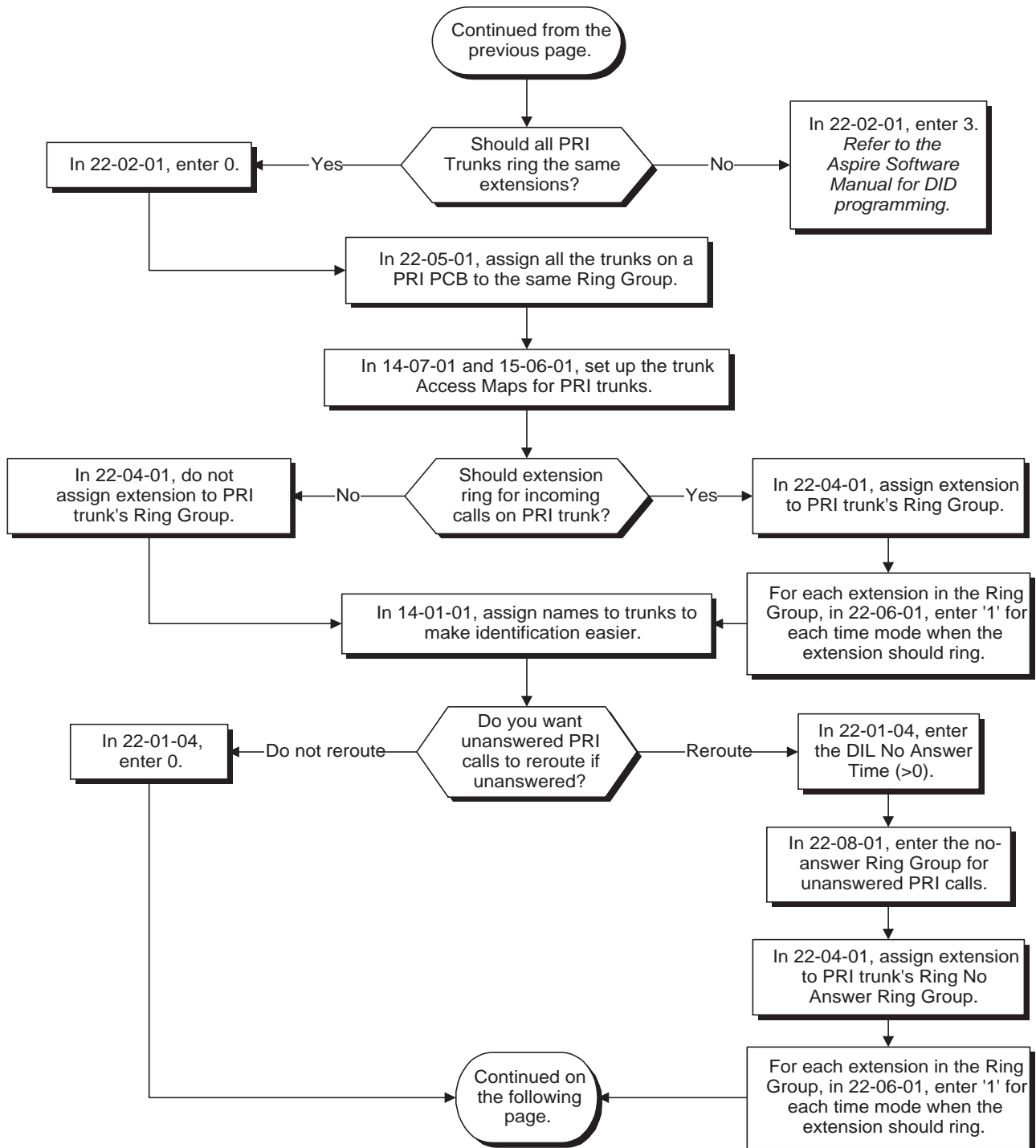

# ISDN Features

## Primary Rate Interface (PRI), Answering Calls

### Programming (Cont'd)

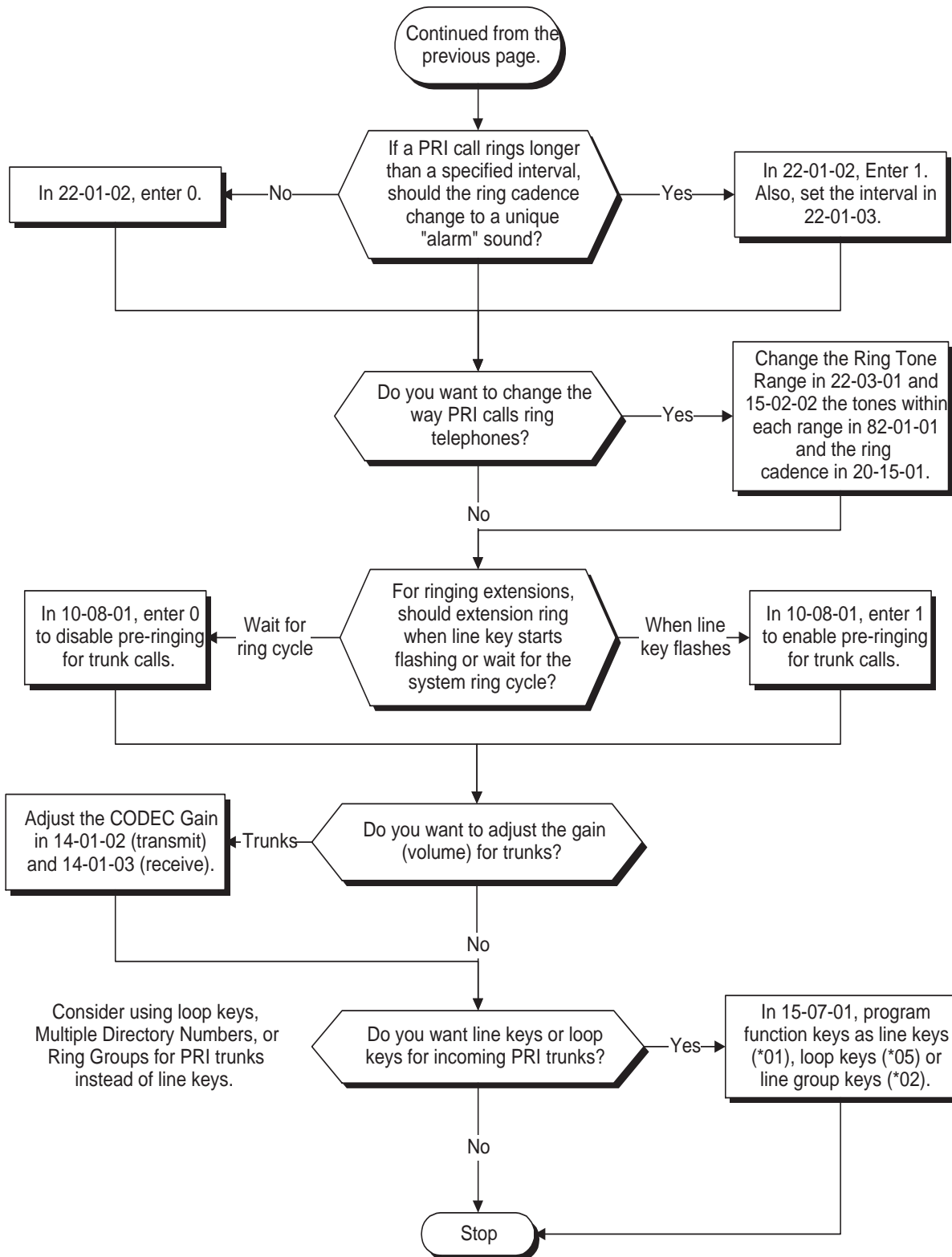

---

### Programming (Cont'd)

- ➔ **10-03-01 : PCB Setup - ISDN Line Mode**

Setup and confirm the Basic Configuration data for each PCB. This program selects the ISDN Line Mode: 0=Not set, 1=T-Bus, 2=S-Bus, 3=Network Mode (Leased Line), 4=Network Mode (Interconnected Line), 5=Network Mode (Interconnected Line, Fixed Layer 1=NT), 6=S-Point (Leased Line). The option selected here determines the clock source for a networked system. With option 3, telco sends the clock to the master and slave systems. With option 4, the master system sends the clock to telco which then sends the clock to the slave system (with no telco, the master system sends the clock directly to the slave system). With option 5, the master and slave systems both send the clock to telco.

*Default Setting: T-Bus (1).*
- ➔ **10-03-02 : PCB Setup - Logical Port Number**

Setup and confirm the Basic Configuration data for each PCB. This program displays the start port number of a PRI line. Thirty logic ports are automatically assigned to a PRI line (T-Bus = 1-200, S-Bus = 1-256).

*Default Setting: (0).*
- ➔ **10-03-03 : PCB Setup - CRC Multi-Frame (CRC4)**

Setup and confirm the Basic Configuration data for each PCB. This program determines whether or not the CRC Multi-Frame (CRC4) is used (0=off, 1=on).

*Default Setting: Off (0).*
- ➔ **10-03-04 : PCB Setup - Layer 3 Timer Type**

Setup and confirm the Basic Configuration data for each PCB. This program selects the Layer 3 timer type (1-5). Each timer value of Layer 3 is set up for each type in Program 81-06 (T-Bus) and Program 82-06 (S-Bus).

*Default Setting: Layer 3 Timer Type (1).*
- ➔ **10-03-06 : PCB Setup - Length of Cable**

Setup and confirm the Basic Configuration data for each PCB. Select the length of cable to be used (0=0-40m, 1=40-81m, 2=81-122m, 3=122-162m, 4=162-200m).

*Default Setting: Cable Length 40-81m (1).*
- ➔ **10-03-07 : PCB Setup - S-Point DID Digits**

Setup and confirm the Basic Configuration data for each PCB. This program selects number of DID digits to be received (0-4).

*Default Setting: Number of DID Digits (0).*
- ➔ **10-03-08 : PCB Setup - Dial Sending Mode**

Setup and confirm the Basic Configuration data for each PCB. Select either enblock or overlap sending (0=Enblock Sending, 1=Overlap Sending).

*Default Setting: Enblock Sending (0).*
- ➔ **10-03-09 : PCB Setup - Dial Information Element**

Setup and confirm the Basic Configuration data for each PCB. If Overlap Sending is selected in Program 10-03-08, select either Keypad Facility (0) or Called Party Number (1) for the dial information element.

*Default Setting: Keypad Facility (0).*
- ➔ **10-03-10 : PCB Setup - Master/Slave System**

Setup and confirm the Basic Configuration data for each PCB. If the system is networked, set the system as either the slave (0) or master (1) system.

*Default Setting: Slave System (0).*

# ISDN Features

## Primary Rate Interface (PRI), Answering Calls

---

---

### Programming (Cont'd)

- ➔ **10-03-11 : PCB Setup - Networking System Number**  
Setup and confirm the Basic Configuration data for each PCB. If the system is networked, define the system number (0-50).  
*Default Setting: System Number (0).*
- ➔ **10-03-12 : PCB Setup - Short/Long Haul**  
Setup and confirm the Basic Configuration data for each PCB. Select either short-haul (0) or long-haul (1).  
*Default Setting: Short-Haul (0).*
- ➔ **10-03-13 : PCB Setup - Loss-of-Signal Detection Limit**  
Setup and confirm the Basic Configuration data for each PCB. Select the loss-of-signal detection limit. In short-haul mode: 0=0.91V, 1=0.74V, 2=0.59V, 3=0.42V, 4=0.32V, 5=0.21V, 6=0.16V, 7=0.10V. In long-haul mode: 0=1.70V, 1=0.84V, 2=0.84V, 3=0.45V, 4=0.45V, 5=0.20V, 6=0.10V, 7=not defined.  
*Default Setting: 0.91V (0).*
- ➔ **10-03-14 : PCB Setup - Service Protocol for S-Point**  
Setup and confirm the Basic Configuration data for each PCB. Select the service protocol to be used (0=keypad facility, 1=specified protocol for Aspire).  
*Default Setting: Keypad Facility (0).*
- ➔ **10-08-01 : Pre-ringing Setup**  
Enable (1) or disable (0) pre-ringing for outside calls. Refer to the Aspire Software Manual for more information.  
*Default Setting: Pre-ringing disabled (0).*
- ➔ **14-01-01 : Basic Trunk Data Setup - Trunk Names**  
Assign names to trunks to make identifying incoming calls easier. Keep in mind that with certain telco's you may not be able to correlate the type of PRI call with specific trunk.  
*Default Setting: Trunk names are the same as the line number (ex: Line 001).*
- ➔ **14-01-02 : Basic Trunk Data Setup - Transmit CODEC Gain Type**  
If required, adjust the transmit CODEC gains for each trunk.  
*Default Setting: 1 (0 dB transmit gain)*
- ➔ **14-01-03 : Basic Trunk Data Setup - Receive CODEC Gain Type**  
If required, adjust the transmit CODEC gains for each trunk.  
*Default Setting: 1 (0 dB receive gain)*
- ➔ **14-05-01 : Trunk Groups**  
Assign the PRI trunks to trunk groups. This determines the channels available for PRI lines.  
*Default Setting: All trunks assigned to Trunk Group 1.*
- ➔ **14-07-01 : Trunk Access Map Setup**  
Set up Trunk Access Maps (200) for PRI trunks. You must also assign extensions to Trunk Access Maps in Program 15-06-01. Note that for incoming calls, Ring Group programming overrides Access Map programming. See *How the Telco Handles PRI Trunks* on page 12 for more.  
*Default Setting: All trunks in Access Map 1 have full access (7). All trunks in the other Access Maps have no access (0).*



# ISDN Features

## Primary Rate Interface (PRI), Answering Calls

---

---

### Programming (Cont'd)

- ➔ **15-02-02 : Multi-Line Telephone Basic Data Setup - Trunk Ring Tone**  
Use this option to change the ringing pitch of incoming trunk calls to keysets.  
*Default Setting: Midrange (2)*
- ➔ **15-06-01 : Trunk Access Map for Extensions**  
Assign Trunk Access Maps (200) to extensions. You must set up the Trunk Access Maps in Program 14-07-01. See *How the Telco Handles PRI Trunks* on page 12 for more.  
*Default Setting: All extensions use Access Map 1.*
- ➔ **15-07-01 : Programmable Function Keys**  
To have incoming PRI calls ring specific keys, assign trunks to line keys (\*01 + line # [001-200]). You can also have loop keys (code \*05) and Trunk Group keys (code \*02 + Trunk Group).  
*Default Setting: Function keys 1-12 are line keys for trunks 1-12.*
- ➔ **20-06-01 : Class of Service for Extensions**  
Assign a Class of Service (1-15) to an extension.  
*Default Setting: Extension 301 has COS 15. All other extension have COS 1.*
- ➔ **20-09-03 : Class of Service Options (Incoming Call Service) - Sub-Address Identification**  
Enable (1) or disable (0) the telco's ability to display the sub-address identification.  
*Default Setting: ISDN Sub-Address Identification disabled (0).*
- ➔ **20-13-23 : Class of Service Options (Supplementary Service) - Display the Reason for Transfer**  
Enable (1) or disable (0) an extension's ability to display the reason (Call Forward, Busy, No Answer or DND) a VRS, DID, DISA, or ISDN call is being transferred to their extension.  
*Default Setting: No reason is displayed (0).*
- ➔ **20-15-01 : Ring Cycle Setup - Normal Incoming Call on Trunk**  
Use this option to change the way calls ring the telephones. Keep in mind that changing this option affects all types of trunk calls - not just PRI calls.  
*Default Setting: Outside calls ring keysets with a short ring followed by a pause (3).*
- ➔ **20-19-04 : System options for Caller ID - Wait Facility IE Timer**  
This option sets how long the system will wait for the Caller ID name (0-64800 seconds). If set to "0" no name is provided.  
*Default Setting: 10 seconds.*
- ➔ **21-01-03 : System Options for Outgoing Calls - Trunk Interdigit Time (External)**  
Set the amount of time the system must wait before placing the call in a talk state (call isn't timed until then, Voice Over and Barge-In are not allowed until after timer expires) (0-64800 seconds).  
*Default Setting: Trunk Interdigit = 5 seconds.*
- ➔ **22-01-02 : System Options for Incoming Calls - Incoming Call Ring No Answer Alarm**  
Enable (1) or disable (0) the Incoming Call RNA Alarm. If enabled, the ring cadence will change for a call that rings longer than the interval set in Program 22-01-03.  
*Default Setting: Incoming Ring No Answer Alarm disabled (0).*
- ➔ **22-01-03 : System Options for Incoming Calls - Ring No Answer Alarm Time**  
Set the Ring No Answer Alarm interval (0-64800 seconds). If a trunk rings a keyset longer than this interval, the system changes the ring cadence, if enabled in 22-01-02.  
*Default Setting: Ring No Answer Alarm Time = 60 seconds.*
- ➔ **22-01-04 : System Options for Incoming Calls - DIL No Answer Recall Time**  
If an incoming trunk call rings longer than this interval, it reroutes to the Ring Group set in Program 22-08.  
*Default Setting: DIL No Answer Time disabled (0). Calls do not reroute.*

# ISDN Features

## Primary Rate Interface (PRI), Answering Calls

---

---

### Programming (Cont'd)

- ➔ **22-02-01 : Incoming Call Trunk Setup**

Use this option to set the service type for PRI trunks using. Enter 0 (for normal operation) or 3 (to have the PRI trunk use the DID tables and route on the last three digits a caller dials). There is one item for each Night Service Mode.

*Default Setting: All trunk service types set for normal (0).*
- ➔ **22-03-01 : Trunk Ring Tone Range**

Assign Ring Tone Ranges to trunks. Customize the tones within each Ring Tone Range in Program 82-01. Trunks ring extensions according to the Ring Tone Range selected in 22-03 and the user settings made with Service Code 820. You may want your ISDN trunks to ring with a unique ring tone.

*Default Setting: Pattern 0.*
- ➔ **22-04-01 : Incoming Extension Ring Group Assignment**

To have PRI trunks ring extensions, use this program to assign extensions (up to 32 max.) to Ring Groups (1-100). You must also assign the PRI trunks to the Ring Groups in Program 22-05 below. See *How the Telco Handles PRI Trunks* on page 12 for more.

*Default Setting: All extensions are in Ring Group 1.*
- ➔ **22-05-01 : Incoming Trunk Ring Group Assignment**

To have PRI trunks ring extensions, assign trunks to Ring Groups (Ring Groups =1-100, 102 = In-Skin/External Voice Mail, 103 = Centralized Voice Mail). Normally, you should assign a trunk on a PRI PCB to the same Ring Group. You must also assign extensions to Ring Groups in Program 22-04-01 above. See *How the Telco Handles PRI Trunks* on page 12 for more.

*Default Setting: All trunks are in Ring Group 1.*
- ➔ **22-06-01 : Normal Incoming Ring Mode**

For each extension in the Ring Group assigned in 22-04-01, indicate if trunks should ring (1) or not ring (0).

*Default Setting: All extensions ring.*
- ➔ **22-08-01 : DIL/IRG No Answer Destination**

If an incoming PRI trunk call rings longer than the DIL No Answer Time (Program 22-01-04), it routes to the Ring Group you specify in this option (Ring Groups=1-100, In-Skin/External Voice Mail = 102, Centralized Voice Mail = 103).

*Default Setting: Calls reroute to Ring Group 1 based on the timer in Program 22-01-04.*
- ➔ **22-11-01 : DID Translation Table Number Conversion**

Specify for each Translation Table entry (2000):

  - The digits received by the system (eight max.)
  - The extension the system dials after translation (24 digits max.)
  - The name that should show on the dialed extension's display when it rings (twelve characters max.)
  - The Transfer Target-1 and 2
  - If the Transfer Targets are busy or receive no answer, those calls are transferred to the final transfer destination (Program 22-10).
  - Operation mode

# ISDN Features

## Primary Rate Interface (PRI), Answering Calls

---

---

### Programming (Cont'd)

→ **35-02-16 : SMDR Output Options, Trunk Name or Received Dialed Number**

If SMDR is used, this option allows you to determine how the SMDR should print incoming calls on ANI/DNIS or DID trunks (0=print trunk port name assigned in Program 14-01-01, 1=print received dialed number). On ANI/DNIS trunks, if enabled, the DNIS digits can be printed instead of the trunk name. If a call is received on a DID trunk, the received number can be printed. If the received number is not in the DID Translation Table (Program 22-11-01), then no number is printed. On ISDN trunks, the called party number can be printed for DID's, if desired.

*Default Setting: Print Trunk Port Name (0).*

→ **82-01-01 : Incoming Ring Tone**

Customize the incoming ring tone (the tones a user hears when a call rings an extension). Trunks ring extensions according to the Ring Tone Range selected in 22-03-01 and the user settings made with Service Code 820.

*Default Setting: Refer to Program 82-01-01 in the Software Manual.*

---

### Related Features

#### Direct Inward Dialing

Use DID to control the inbound routing of PRI trunks. With DID, the system will use the last three or four digits of the *Called Number Information Element* to route an incoming call via the DID translation tables. When programming PRI lines for DID, refer to the Aspire Software Manual (P/N 0893200) for further programming information.

#### Forced Trunk Disconnect

This feature only works on analog trunk. ISDN trunks do not have the Forced Trunk Disconnect available.

#### Night Service

If enabled, an extension user can dial the Universal Answer code to pick up a ringing PRI trunk.

#### Transfer

Transferred calls on DISA, DID, ISDN trunks, or from the VRS can display the reason a call is being transferred (Call Forward, Busy, No Answer, or DND).

---

### Operation

#### To answer an incoming trunk call:

1. Lift handset.
2. At keyset, press flashing line key.

*If you don't have a line or loop key for a PRI call ringing your phone, it rings an idle CALL key. If you have Ringing Line Preference, lifting the handset answers the call.*

# ISDN Features

## *Primary Rate Interface (PRI), Answering Calls*

---

- For Your Notes -

# ISDN Features

## *Primary Rate Interface (PRI), Placing Calls*

---

---

### **Description**

The system provides 23 high-speed state-of-the-art digital trunks on a double pair of wires.

**!! Important !!**

Primary Rate Interface (PRI) requires additional programming. Refer to the Programming section for more information.

---

### **Conditions**

PRI requires the installation of a CSU/DSU Unit and interconnecting cables. Consult with your sales representative for more information.

---

### **Default Setting**

- Once set, users can place calls over PRI trunks.

# ISDN Features

## Primary Rate Interface (PRI), Placing Calls

### Programming

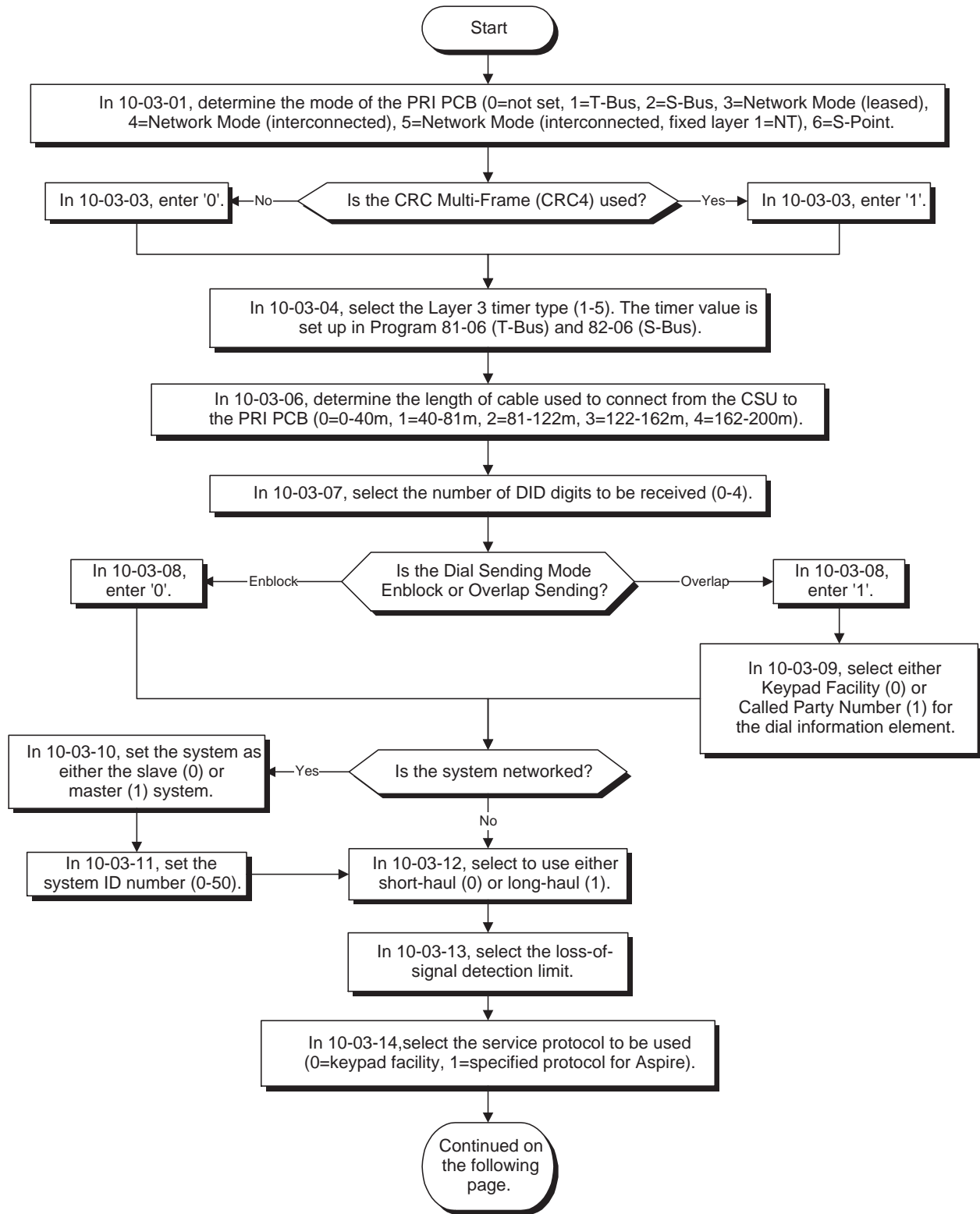

# ISDN Features

## Primary Rate Interface (PRI), Placing Calls

### Programming (Cont'd)

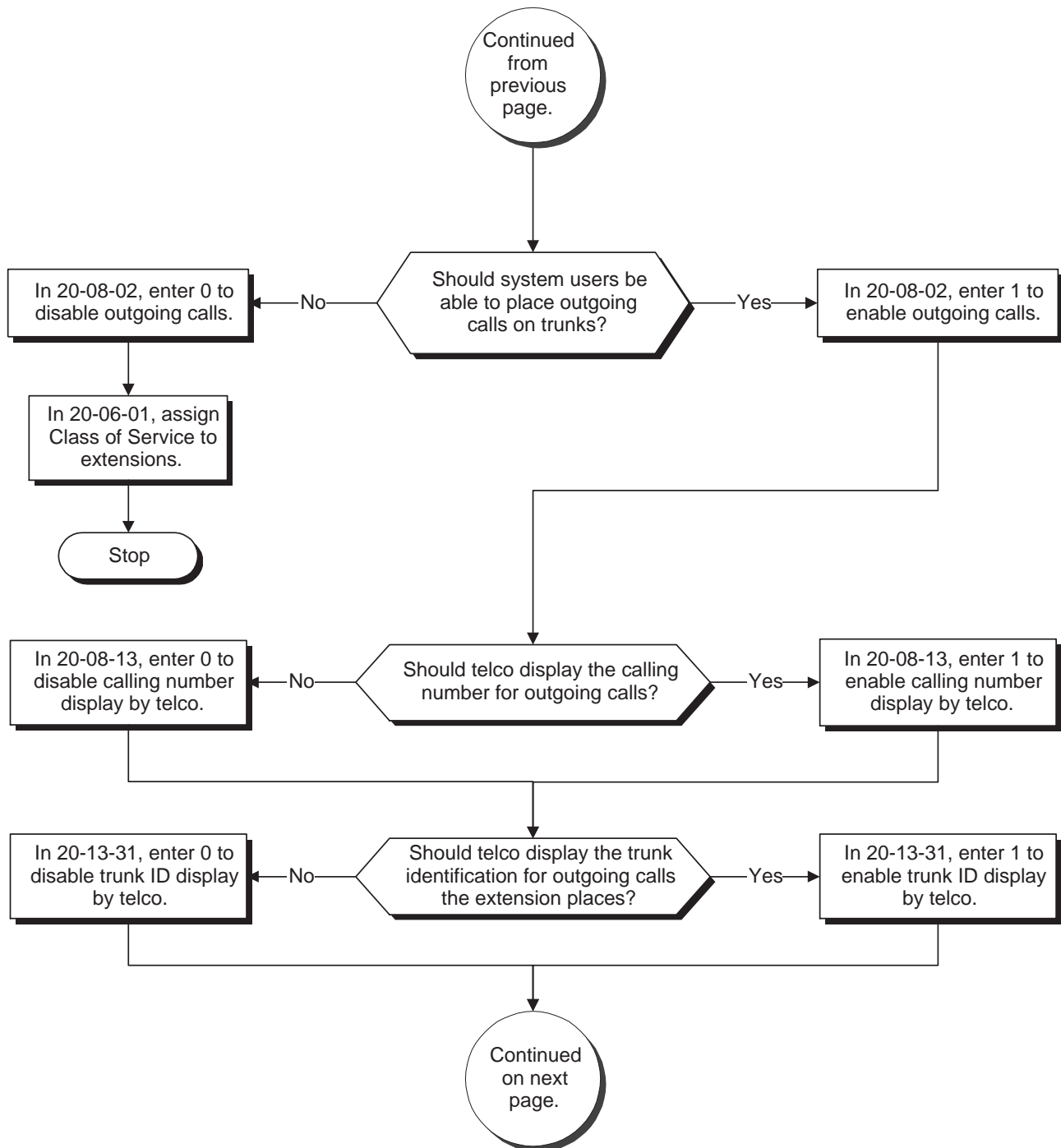

# ISDN Features

## Primary Rate Interface (PRI), Placing Calls

### Programming (Cont'd)

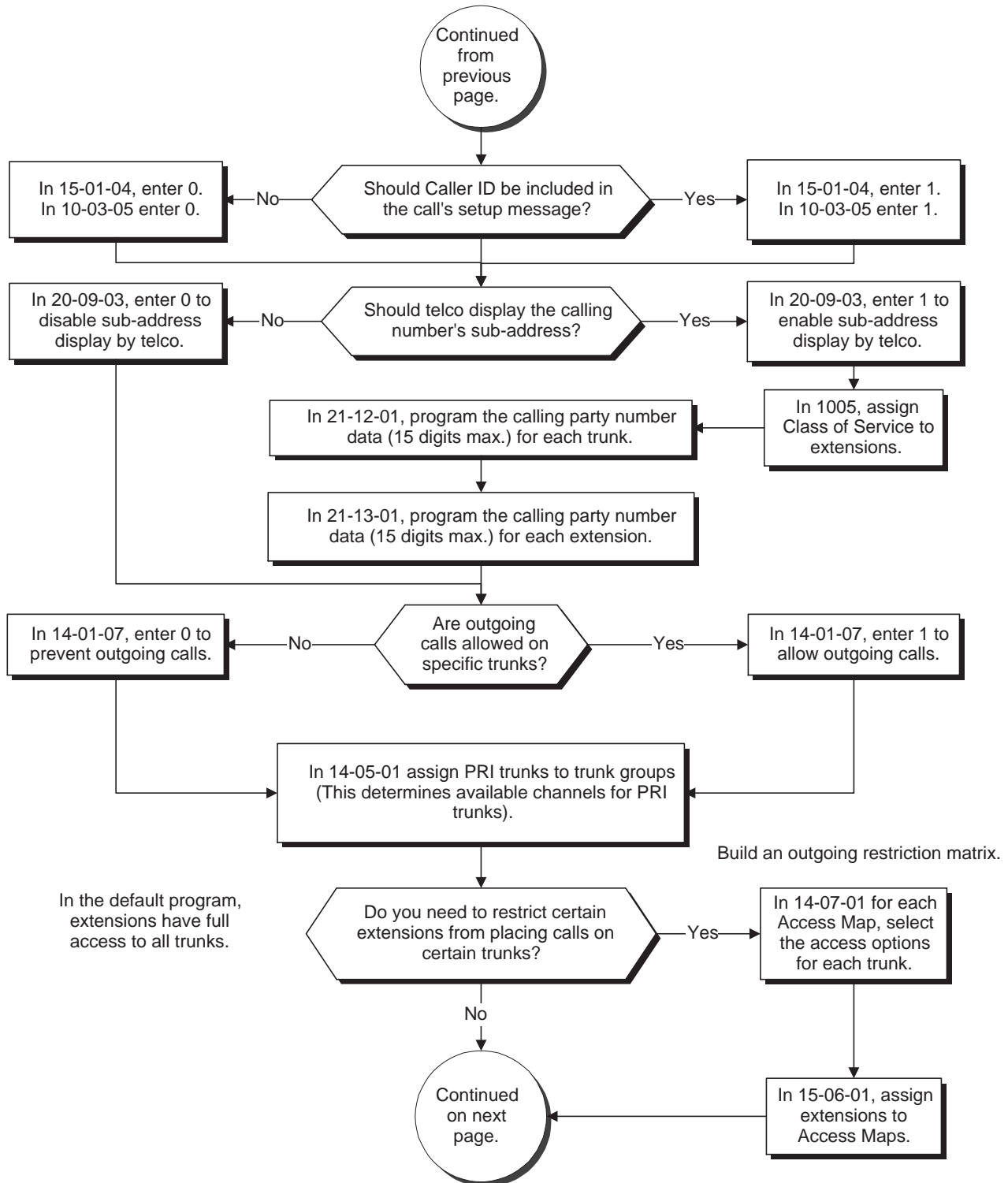



# ISDN Features

## Primary Rate Interface (PRI), Placing Calls

### Programming (Cont'd)

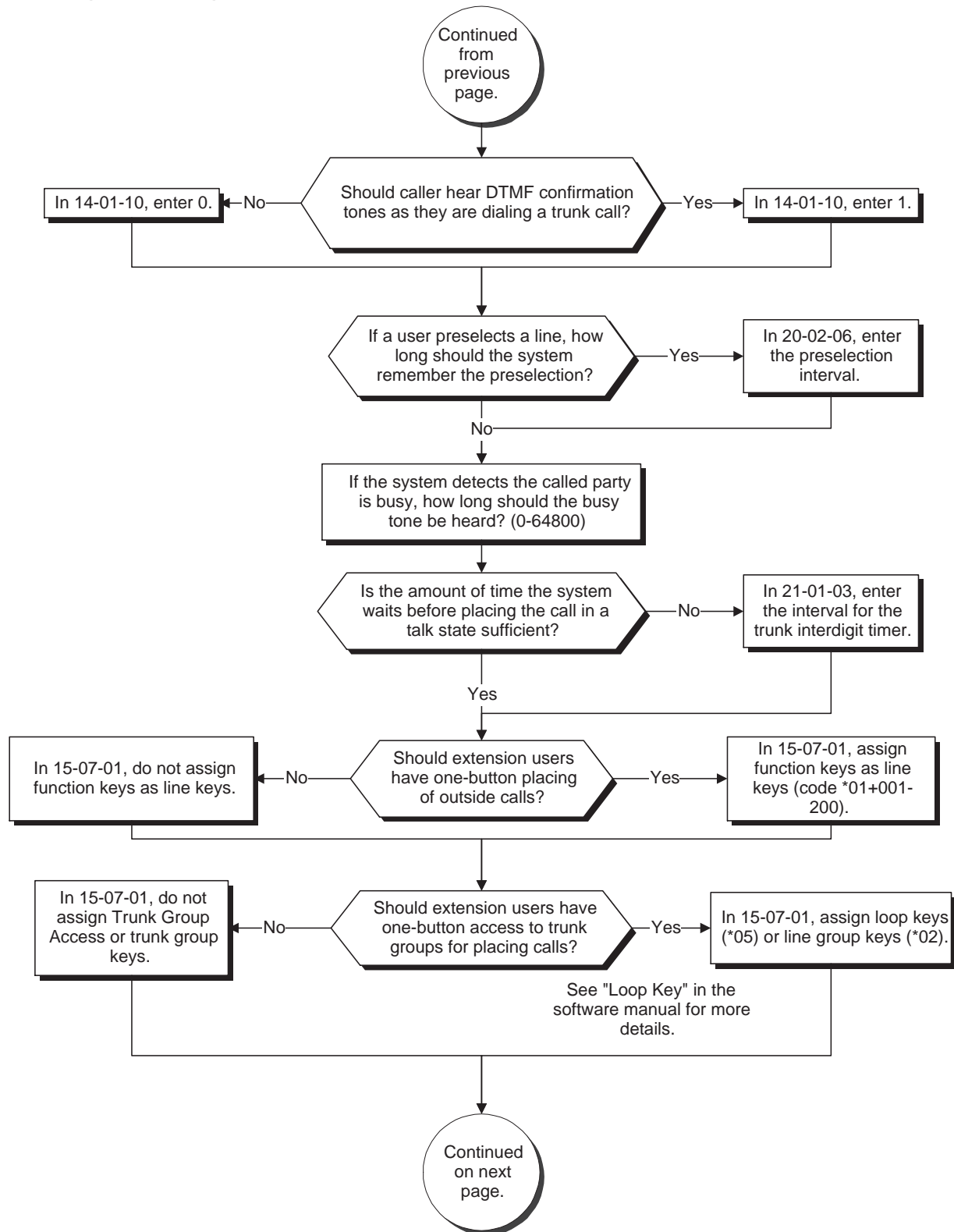

# ISDN Features

## Primary Rate Interface (PRI), Placing Calls

### Programming (Cont'd)

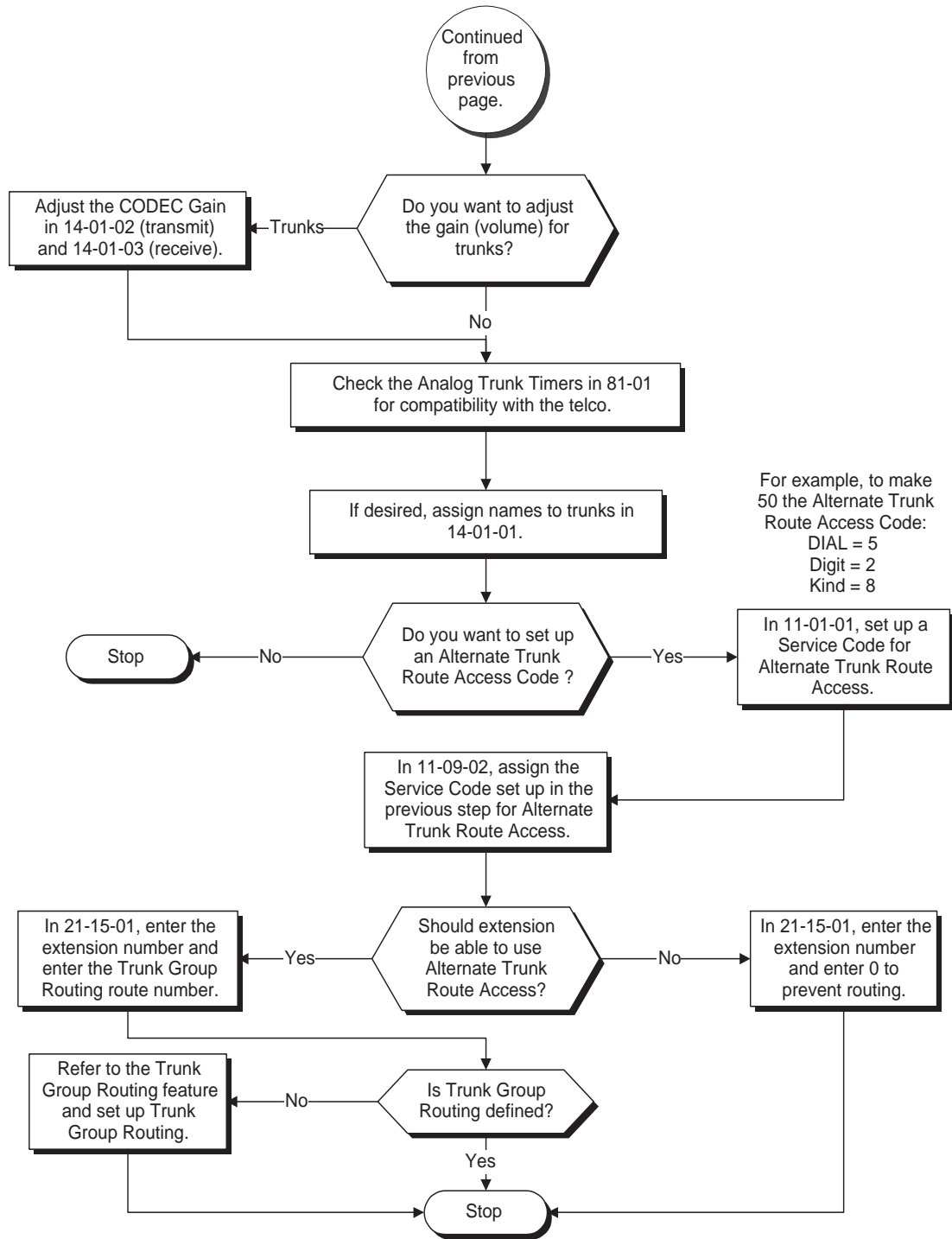

---

### Programming (Cont'd)

- ➔ **10-03-01 : PCB Setup - ISDN Line Mode**

Setup and confirm the Basic Configuration data for each PCB. This program selects the ISDN Line Mode: 0=Not set, 1=T-Bus, 2=S-Bus, 3=Network Mode (Leased Line), 4=Network Mode (Interconnected Line), 5=Network Mode (Interconnected Line, Fixed Layer 1=NT), 6=S-Point (Leased Line). The option selected here determines the clock source for a networked system. With option 3, telco sends the clock to the master and slave systems. With option 4, the master system sends the clock to telco which then sends the clock to the slave system (with no telco, the master system sends the clock directly to the slave system). With option 5, the master and slave systems both send the clock to telco.
- ➔ **10-03-02 : PCB Setup - Logical Port Number**

Setup and confirm the Basic Configuration data for each PCB. This program displays the start port number of a PRI line. Thirty logic ports are automatically assigned to a PRI line (T-Bus = 1-200, S-Bus = 1-256).
- ➔ **10-03-03 : PCB Setup - CRC Multi-Frame (CRC4)**

Setup and confirm the Basic Configuration data for each PCB. This program determines whether or not the CRC Multi-Frame (CRC4) is used (0=off, 1=on).
- ➔ **10-03-04 : PCB Setup - Layer 3 Timer Type**

Setup and confirm the Basic Configuration data for each PCB. This program selects the Layer 3 timer type (1-5). Each timer value of Layer 3 is set up for each type in Program 81-06 (T-Bus) and Program 82-06 (S-Bus).
- ➔ **10-03-05 : PCB Setup - CLIP Information**

Based on this setting, the system will include a "Presentation Allowed" (1) or "Presentation Restricted" (0) in the Setup message to allow or deny the Calling Party Number. Program 15-01-04 must also be set to a '1' if this option is enabled.
- ➔ **10-03-06 : PCB Setup - Length of Cable**

Setup and confirm the Basic Configuration data for each PCB. Select the length of cable to be used (0=0-40m, 1=40-81m, 2=81-122m, 3=122-162m, 4=162-200m).
- ➔ **10-03-07 : PCB Setup - S-Point DID Digits**

Setup and confirm the Basic Configuration data for each PCB. This program selects number of DID digits to be received (0-4).
- ➔ **10-03-08 : PCB Setup - Dial Sending Mode**

Setup and confirm the Basic Configuration data for each PCB. Select either enblock or overlap sending (0=Enblock Sending, 1=Overlap Sending).
- ➔ **10-03-09 : PCB Setup - Dial Information Element**

Setup and confirm the Basic Configuration data for each PCB. If Overlap Sending is selected in Program 10-03-08, select either Keypad Facility (0) or Called Party Number (1) for the dial information element.
- ➔ **10-03-10 : PCB Setup - Master/Slave System**

Setup and confirm the Basic Configuration data for each PCB. If the system is networked, set the system as either the slave (0) or master (1) system.
- ➔ **10-03-11 : PCB Setup - Networking System Number**

Setup and confirm the Basic Configuration data for each PCB. If the system is networked, define the system number (0-50).
- ➔ **10-03-12 : PCB Setup - Short/Long Haul**

Setup and confirm the Basic Configuration data for each PCB. Select either short-haul (0) or long-haul (1).

# ISDN Features

## Primary Rate Interface (PRI), Placing Calls

---

---

### Programming (Cont'd)

- ➔ **10-03-13 : PCB Setup - Loss-of-Signal Detection Limit**  
Setup and confirm the Basic Configuration data for each PCB. Select the loss-of-signal detection limit. In short-haul mode: 0=0.91V, 1=0.74V, 2=0.59V, 3=0.42V, 4=0.32V, 5=0.21V, 6=0.16V, 7=0.10V. In long-haul mode: 0=1.70V, 1=0.84V, 2=0.84V, 3=0.45V, 4=0.45V, 5=0.20V, 6=0.10V, 7=not defined
- ➔ **10-03-14 : PCB Setup - Service Protocol for S-Point**  
Setup and confirm the Basic Configuration data for each PCB. Select the service protocol to be used (0=keypad facility, 1=specified protocol for Aspire).
- ➔ **11-01-01 : System Numbering**  
Set up a Service Code for Alternate Trunk Route Access. You may want to use an alternate access code for your outgoing PRI trunks. Also see programs 11-09-02 and 21-15-01.  
*Default Setting: No Alternate Trunk Route Access code programmed.*
- ➔ **11-09-02 : Trunk Access Code - Alternate Trunk Route Access Code**  
Assign the Service Code set up in 11-01-01 for Alternate Trunk Route Access. You may want to use an alternate access code for your outgoing PRI trunks. Also see programs 11-01-01 and 21-15-01.  
*Default Setting: No Alternate Trunk Route Access code programmed.*
- ➔ **14-01-02 : Basic Trunk Data Setup - Transmit CODEC Gain Type**  
If required, adjust the transmit CODEC gains for each trunk.  
*Default Setting: 1 (0 dB transmit gain)*
- ➔ **14-01-03 : Basic Trunk Data Setup - Receive CODEC Gain Type**  
If required, adjust the transmit CODEC gains for each trunk.  
*Default Setting: 1 (0 dB receive gain)*
- ➔ **14-01-07 : Basic Trunk Port Setup - Outgoing Calls**  
Allow this option (1) for each PRI trunk you want to use for outgoing calls. Prevent this option (0) if the trunk will not be used for outgoing calls.  
*Default Setting: Outgoing calls allowed (1).*
- ➔ **14-01-10 : Basic Trunk Data Setup - DTMF Tones for Outgoing Calls**  
For each trunk, enable (1) or disable (0) DTMF tones for outgoing trunk calls.  
*Default Setting: DTMF tone disabled for outgoing calls (0).*
- ➔ **14-05-01 : Trunk Groups**  
Assign the PRI trunks to trunk groups. This determines the channels available for PRI lines.  
*Default Setting: All trunks assigned to Trunk Group 1.*
- ➔ **14-07-01 : Trunk Access Map Setup**  
Set up Trunk Access Maps (200) for PRI trunks. You must also assign extensions to Trunk Access Maps in Program 15-06-01.  
*Default Setting: All trunks in Access Map 1 have full access (7). All trunks in the other Access Maps have no access (0).*
- ➔ **15-01-04 : Basic Extension Data Setup - ISDN Caller ID**  
If both Program 15-01-04 and 10-03-05 are enabled (1), the system includes Caller ID in the Setup message as "Presentation Allowed". If these options are disabled (0), it will be "Presentation Restricted".

---

### Programming (Cont'd)

- ➔ **15-06-01 : Trunk Access Map for Extensions**

Assign Trunk Access Maps (200) to extensions. You must set up the Trunk Access Maps in Program 14-07-01. This allows you to control extension access to the PRI trunks.

*Default Setting: All extensions use Access Map 1.*
- ➔ **15-07-01 : Programmable Function Keys**

Assign a function key for Caller ID Block for ISDN (63) if required. To simplify placing PRI calls, assign function keys as line keys (\*01 + line # [001-200]), loop keys (code 1078) and Trunk Group keys (code 1012 + Trunk Group).

*Default Setting: Function keys 1-12 are line keys for trunks 1-12.*
- ➔ **20-02-06 : System Options for Multi-Line Telephones - Preselection Time**

Set the preselection interval (0-64800 seconds). When a keyset user preselects a line key, the system remembers the preselection for this interval.

*Default Setting: Preselection time is 5 seconds.*
- ➔ **20-06-01 : Class of Service for Extensions**

Assign a Class of Service (1-15) to each extension. Use this option in conjunction with Program 20-08-02.

*Default Setting: Extension 301 has COS 15. All other extension have COS 1.*
- ➔ **20-08-02 : Class of Service Options (Outgoing Call Service) - Trunk Calls**

In an extension's Class of Service, enable (1) or disable (0) trunk calling.

*Default Setting: Trunk calling enabled (1).*
- ➔ **20-08-13 : Class of Service Options (Outgoing Call Service) - ISDN CLIP**

Determine if the ISDN calling line identity presentation and screening indicators are to be allowed (0=disabled, 1=enabled).

*Default Setting: ISDN Calling Party Number disabled (0).*
- ➔ **20-09-03 : Class of Service Options (Incoming Call Service) - Sub-Address Identification**

Enable (1) or disable (0) the telco's ability to display the sub-address identification.

*Default Setting: ISDN Sub-Address Identification disabled (0).*
- ➔ **20-13-31 : Class of Service Options - ISDN Connected Line Identification**

Enable (1) or disable (0) the telco's ability to display trunk identification for outgoing calls the extension places.

*Default Setting: ISDN Connected Line Identification disabled (0).*
- ➔ **21-01-03 : System Options for Outgoing Calls - Trunk Interdigit Time (External)**

Set the amount of time the system must wait before placing the call in a talk state (call isn't timed until then, Voice Over and Barge-In are not allowed until after timer expires) (0-64800 seconds).

*Default Setting: Trunk Interdigit = 5 seconds.*
- ➔ **21-08-04 : Repeat Dial Setup - Time for Send Busy Tone for ISDN Trunk**

Set the length of the time the system should send a busy tone after detecting the called party is busy (by receiving either a 'RELEase complete' or 'DISConnect' message from the CO). After this timer's expires, the keyset will go to an idle status (0-64800 seconds). If '0' is entered, a caller will not hear a busy tone when the ISDN trunk detects a busy state. It will immediately go the an idle status.

*Default Setting: 0 (caller does not hear busy tone)*

# ISDN Features

## Primary Rate Interface (PRI), Placing Calls

---

---

### Programming (Cont'd)

➔ **21-12-01 : ISDN Calling Party Number Setup for Trunks**

Assign Calling Party Numbers for each trunk (maximum 16 digits per entry). When a call is made by an extension which does not have an Extension Calling Number assigned (Program 21-13-01), the system sends the calling number for the ISDN trunk defined in 21-12-01. If the Calling Party Number is assigned in both Programs 21-12-01 and 21-13-01, the system sends the data in Program 21-13-01.

*Default Setting: No digits assigned.*

➔ **21-13-01 : ISDN Calling Party Number Setup for Extensions**

Assign each extension a Calling Party Number (maximum 16 digits per entry). The calling number is the subscriber number of the dial-in number. When a call is made by an extension which does not have an Extension Calling Number assigned (Program 21-12-01), the system sends the calling number for the ISDN trunk defined in Program 21-13. If a Calling Party Number is assigned in both Programs 21-12-01 and 21-13-01, the system sends the data in Program 21-12-01.

*Default Setting: No digits assigned.*

➔ **21-15-01 : Individual Trunk Group Route for Extensions**

To better control placing calls over PRI trunks, consider setting up Alternate Trunk Route Access. Use this option to specify the Alternate Trunk Route for each extension. Also see programs 11-01-01, 11-09-02, 14-06-01.

*Default Setting: No routes assigned (00).*

➔ **22-02-01 : Incoming Call Trunk Setup**

Use this option to set the service type for PRI trunks. Enter 0 (for normal operation) or 3 (if the PRI trunk has DID type operation for incoming calls).

*Default Setting: All trunk service types set for normal (0).*

➔ **81-01-01 : COIU Initial Data Setup**

Review the Analog Trunk Timers for compatibility with the connected telco.

# ISDN Features

## Primary Rate Interface (PRI), Placing Calls

---

---

### Related Features

#### Handsfree

With Automatic Handsfree, an extension user can press a line key to place a trunk call without first lifting the handset or pressing SPK. Users without Automatic Handsfree can preselect a line key before lifting the handset or pressing SPK.

#### Repeat Redial

Repeat Dial on ISDN trunks do not use the system timer 21-08-03 : *Repeat Dial Setup - Repeat Dial Calling Timer*. The ISDN trunks can detect whether the call was busy or answered.

Repeat Dial on an analog trunk does not use this system timer 21-08-04 : *Repeat Dial Setup - Time for Send Busy Tone for ISDN Trunk*.

---

### Operation

#### To place a PRI call over a trunk group:

1. At keyset, press idle CALL key.  
**OR**  
At single line set, lift handset.
2. Dial 804.
3. Dial PRI trunk group number (001-200).
4. Dial number.

#### **OR**

1. At keyset, press trunk group key (PGM 15-07 or SC 852: \*02 + group).  
*Also see the "Loop Keys" feature in the Software Manual.*
2. Dial number.  
*Dialing # after the telephone number will speed up the dialing on PRI lines.*

#### To place a PRI call using Trunk Group Routing:

1. At keyset, press idle CALL key.  
**OR**  
At single line set, lift handset.
2. Dial 9.  
*If your system has an Alternate Trunk Route Access code for PRI trunks, you may dial that instead.*
3. Dial number.

#### **OR**

1. At keyset, press Trunk Group Routing key (PGM 15-07 or SC 852: \*02).  
*Also see the "Loop Keys" feature in the Software Manual.*
2. Dial number.

# ISDN Features

## *Primary Rate Interface (PRI), Placing Calls*

---

---

### Operation (Cont'd)

#### To place a call over a specific PRI trunk:

1. At keyset, press idle CALL key.  
*OR*  
At single line set, lift handset.
2. Dial #9.
3. Dial line PRI line number (e.g., 005 for line 5).
4. Dial number.

#### *OR*

1. At keyset, press line key (PGM 15-07 or SC 851: 001 to 200).  
*Also see the "Loop Keys" feature in the Software Manual.*
2. Dial number.



# **Section 2:**

# **ISDN PRI Programming**

## Section 2

### *ISDN PRI Programming*

---

---

### Before Reading This Section

This section provides you with detailed information about the system programs. By changing a program, you change the way the feature associated with that program works. In this section, you'll find out about each program, the features that the program affects and how to enter the program data into system memory.

**Do not start customizing your system without first reading "Section 1, ISDN PRI Features".**

When you want to customize a feature, find it in Section 1 and learn about it. Section 1 will tell you what programs you have to change to get the operation you want. Make a note of the changes on the Program Record Forms provided with your system. Then, look the program up in this section if you have any questions about how to enter the data.

---

### How to Use This Section

This section lists each program in numerical order. For example, Program 10-01 is at the beginning of the section and Program 92-01 is at the end. The information on each program is subdivided into the following headings:

**Description** describes what the program options control. The Default Settings for each program are also included. When you first install the system, it uses the Default Setting for all programs. Along with the Description are the *Conditions* which describe any limits or special considerations that may apply to the program.

The reverse type (white on black) just beneath the Description heading is the program's access level. You can only use the program if your access level meets or exceeds the level the program requires. Refer to **How to Enter the Programming Mode** (page 38) for a list of the system's access levels and passwords.

**Feature Cross Reference** provides you with a table of all the features affected by the program. You'll want to keep the referenced features in mind when you change a program. Customizing a feature may have an effect on another feature that you didn't intend.

**Telephone Programming Instructions** shows you how to enter the program's data into system memory. For example:

1. Enter the programming mode.
2. 15-07-01



```
15-07-01 TEL301
KY01 = *01
←                →
```

tells you to enter the programming mode, dial 150701 from the telephone dial pad. After you do, you'll see the message "15-07-01 TEL301" on the first line of the telephone display. This indicates the program number (15-07), item number (01), and that the options are being set for extension 301. The second row of the display "KY01 = \*01" indicates that Key 01 is being programmed with the entry of \*01. The third row allows you to move the cursor to the left or right, depending on which arrow is pressed. To learn how to enter the programming mode, see **How to Enter the Programming Mode** below.

# Programming

## Before You Start Programming

---

### How to Enter the Programming Mode

To enter the programming mode:

1. Go to any working display telephone.  
*In a newly installed system, use extension 301 (port 1).*
2. Do not lift the handset.
3. Press CALL1.
4. # \* # \*

**Password**

5. Dial the system password + HOLD.

*Refer to the following table for the default system passwords. To change the passwords, use Program 90-02.*

Password	User Name	Level	Programs at this Level
374772	NEC-I	1 (MF)	All programs
12345678	ASPIRE	2 (IN)	All programs in this section not listed below for SA and SB
0000	ADMIN1	3 (SA)	10-01, 10-02, 10-12, 10-13, 10-14, 10-15, 10-16, 10-17, 10-18, 10-22, 12-02, 12-03, 12-04, 15-01, 15-07, 15-09, 15-10, 15-11, 20-16, 21-07, 21-14, 22-04, 22-11, 25-08, 30-03, 32-02, 40-02, 41-02, 41-03, 41-04, 41-05, 41-06, 41-07, 41-08, 41-09, 41-10, 41-11, 41-12, 41-13, 41-14, 41-15, 41-16, 41-17, 41-18, 90-03, 90-04, 90-06, 90-07, 90-18, 90-19
9999	ADMIN2	4 (SB)	13-04, 13-05, 13-06

### How to Exit the Programming Mode

To exit the programming mode:

When you are done programming, you must be out of a program's options to exit (pressing the MSG key will exit the program's option).

1. Press MSG key to exit the program's options, if needed.

**Program Mode**  
**Base Service OP1 OP2**

2. Press SPK. You see, "Saving System Data" if changes to were to the system's programming.
3. The display shows "Complete Data Save" when completed and will exit the phone to an idle mode.

*To save a customer's database, a blank PC-ATA card is required. Insert the card into the NTCPU and, using Program 90-03, save the software to the PC-ATA card. (Program 90-04 is used to reload the customer data if necessary.) Note that a PC-ATA card can only hold one customer database. Each database to be saved will require its own separate card.*

## Using Keys to Move Around in the Programs

Once you enter the programming mode, use the keys in the following chart to enter data, edit data and move around in the menus.

Keys for Entering Data	
Use this key...	When you want to . . .
0-9 and *	Enter data into a program.
HOLD	Complete the programming step you just made (like pressing Enter on a PC keyboard). When a program entry displays, press HOLD to bypass the entry without changing it.
CONF	Delete the entry to the left (like pressing Backspace on a PC keyboard).
MSG	Exit one step at a time from the program window currently being viewed.  For example, if you're programming item 5 in 15-03, pressing MSG will allow you to enter a new option in program 15-03. Pressing MSG again will allow you to select a new program in the 15- series. Pressing MSG a third time will allow you to enter a new program beginning with '1'. Pressing MSG one last time will bring you to the beginning program display, allowing you to enter any program number.
FLASH	Switch extension, line, etc. being programmed by pressing FLASH. The cursor moves up to the top row of the display. Pressing FLASH again moves the cursor back to the middle row.
LINE KEYS	Use pre-programmed settings to help with the program entry. These settings vary between programs from LINE 1 = 0 (off) and LINE 2 = 1 (on) to preset values for timers where LINE 1 = 5, LINE 2 = 10, LINE 3 = 15, etc.  For programs with this option, the line key which currently matches the programmed setting will light steady.  The display may also indicate Soft Keys which will allow you to select the values as well (-1 and +1 will step through these pre-programmed settings.)
LINE KEY 1	Program a pause into an Abbreviated Dialing bin.
LINE KEY 2	Program a recall/flash into an Abbreviated Dialing bin.
LINE KEY 3	Program a @ into an Abbreviated Dialing bin.
VOL ▲	Scroll backward through a list of entry numbers (e.g., from extension 301 to 302, 303, etc.) or through entries in a table (e.g., Common Permit Table).  <i>If you enter data and then press this key, the system accepts the data before scrolling forward.</i>
VOL ▼	Scroll forward through a list of entry numbers (e.g., from extension 301 to 302, 303, etc.) or through entries in a table (e.g., Common Permit Table).  <i>If you enter data and then press this key, the system accepts the data before scrolling backward</i>

# Programming

## Before You Start Programming

### Programming Names and Text Messages

Several programs (e.g., Program 20-16: Selectable Display Messages) require you to enter text. Use the following chart when entering and editing text. When using the keypad digits, press the key once for the first character, twice for the second character, etc. For example, to enter a C, press key “2” three times. Press the key six times display the lower case letter. The name can be up to 12 digits long.

#### With Software Prior to 2.05:

Key for Entering Names	
Use this keypad digit . . .	When you want to . . .
1	Enter characters: 1 @ [ ¥ ] ^ _ ‘ {   } ← → Press repeatedly to scroll through the list. After selecting your entry, press the next letter or use the left scroll or right scroll Soft Key to move the cursor.
2	Enter characters A-C, a-c, 2. After selecting your entry, press the next letter or use the left scroll or right scroll Soft Key to move the cursor.
3	Enter characters D-F, d-f, 3. After selecting your entry, press the next letter or use the left scroll or right scroll Soft Key to move the cursor.
4	Enter characters G-I, g-i, 4. After selecting your entry, press the next letter or use the left scroll or right scroll Soft Key to move the cursor.
5	Enter characters J-L, j-l, 5. After selecting your entry, press the next letter or use the left scroll or right scroll Soft Key to move the cursor.
6	Enter characters M-O, m-o, 6. After selecting your entry, press the next letter or use the left scroll or right scroll Soft Key to move the cursor.
7	Enter characters P-S, p-s, 7. After selecting your entry, press the next letter or use the left scroll or right scroll Soft Key to move the cursor.
8	Enter characters T-V, t-v, 8. After selecting your entry, press the next letter or use the left scroll or right scroll Soft Key to move the cursor.
9	Enter characters W-Z, w-z, 9. After selecting your entry, press the next letter or use the left scroll or right scroll Soft Key to move the cursor.
0	Enter characters: 0 ! “ # \$ % & ‘ ( ) Press repeatedly to scroll through the list. After selecting your entry, press the next letter or use the left scroll or right scroll Soft Key to move the cursor.
*	Enter characters: * + , - . / : ; < = > ? Press repeatedly to scroll through the list. After selecting your entry, press the next letter or use the left scroll or right scroll Soft Key to move the cursor.
Soft Key Left/Right Arrows	Accepts an entry (only required if two letters on the same key are needed - ex: <b>TOM</b> ) and moves cursor in the arrows direction.
CONF	Clear the character entry one character at a time.
CLEAR	Clear all the entries from the point of the flashing cursor and to the right.

# Programming Before You Start Programming

**With Software 2.05+:**

Use this keypad digit . . .	When you want to . . .
1	Enter characters: 1 @ [ ¥ ] ^ _ ` {   } → ← Á À Â Ã Ç É Ê ì ó
2	Enter characters A-C, a-c, 2.
3	Enter characters D-F, d-f, 3.
4	Enter characters G-I, g-i, 4.
5	Enter characters J-L, j-l, 5.
6	Enter characters M-O, m-o, 6.
7	Enter characters P-S, p-s, 7.
8	Enter characters T-V, t-v, 8.
9	Enter characters W-Z, w-z, 9.
0	Enter characters: 0 ! “ # \$ % & ’ ( ) ô õ ú ä ö ü α ε θ
*	Enter characters: * + , - . / : ; < = > ? π ∑ σ Ω ∞ ϕ £
#	# = Accepts an entry (only required if two letters on the same key are needed - ex: <b>TOM</b> ). Pressing # again = Space. (In system programming mode, use the right arrow soft key instead to accept and/or add a space.)
CONF	Clear the character entry one character at a time.
CLEAR	Clear all the entries from the point of the flashing cursor and to the right.

When using i-Series telephones on the Aspire system, not all the same characters are available. Refer to the following chart for the i-Series characters:

Use this keypad digit . . .	When you want to . . .
1	Enter characters: 1 @ [ ¥ ] ^ _ ` {   } → ← å blank blank blank blank blank blank blank blank
2	Enter characters A-C, a-c, 2.
3	Enter characters D-F, d-f, 3.
4	Enter characters G-I, g-i, 4.
5	Enter characters J-L, j-l, 5.
6	Enter characters M-O, m-o, 6.
7	Enter characters P-S, p-s, 7.
8	Enter characters T-V, t-v, 8.
9	Enter characters W-Z, w-z, 9.
0	Enter characters: 0 ! “ # \$ % & ’ ( ) blank blank blank ä ö ü α ε θ
*	Enter characters: * + , - . / : ; < = > ? π ∑ σ Ω ∞ ϕ £
#	# = Accepts an entry (only required if two letters on the same key are needed - ex: <b>TOM</b> ). Pressing # again = Space.
CONF	Clear the character entry one character at a time.
CLEAR	Clear all the entries from the point of the flashing cursor and to the right.

# Programming

## Before You Start Programming

---

### Using Soft Keys For Programming

Each Aspire display telephone provides interactive soft keys for intuitive feature access. The options for these keys will automatically change depending on where you are in the system programming. Simply press the Soft Key located below the option you wish and the display will change accordingly.



Pressing the VOLUME ▲ or VOLUME ▼ will scroll between the menus.



### What the Soft Key Display Prompts Mean

When using a display phone in programming mode, you will see various Soft Key options displayed. These keys will allow you to easily select, scan, or move through the programs.

Soft key Display Prompts	
If you press this Soft Key . . .	The system will. . .
<b>back</b>	Go back one step in the program display.  You can press VOLUME ▲ or VOLUME ▼ to scroll forwards or backwards through a list of Programs.
↑	Scroll down through the available programs.
↓	Scroll up through the available programs.
<b>select</b>	Select the currently displayed program.
←	Move the cursor to the left.
→	Move the cursor to the right.
<b>-1</b>	Move back through the available program options.
<b>+1</b>	Move forward through the available program options.



# Program 10 : System Configuration Setup

## 10-03 : PCB Setup

<b>Level:</b>	<b>Aspire S</b>	<b>Aspire</b>
<b>IN</b>	• Available.	• Available.

### Description

Use **Program 10-03 : PCB Setup** to setup and confirm the Basic Configuration data for each PCB. When changing a defined terminal type, first set the type to '0' and then plug the new device in to have the system automatically define it or you may have to reseat the PCB.

**Note:** The items highlighted in gray are read only and cannot be changed.

### Input Data

For PRIU Unit

Item No.	Item	Input Data	Default
01	ISDN Line Mode	0 = Not set 1 = T-Bus 2 = S-Bus 3 = Network Mode (Leased Line) 4 = Network Mode (Interconnected Line) 5 = Network Mode (Interconnected Line, Fixed Layer 1=NT) 6 = S-Point (Leased Line)	1
02	Logical Port Number (see Note 1)	1 = for T-Bus 1-200 2 = for S-Bus 1-256	0
03	CRC Multi-frame(CRC4) (Only E1[30B+D] Mode)	0 = off 1 = on	0
04	Layer 3 Timer Type (see Note 2)	1-5	1
05	<b>CLIP Information</b> Based on this setting, the system will include a "Presentation Allowed" (1) or "Presentation Restricted" (0) in the Setup message to allow or deny the Calling Party Number. Program 15-01-04 must also be set to a '1' if this option is enabled.	0 = Disable 1 = Enable	1
06	Length of cable	0 = 0 40m 1 = 40 81m 2 = 81 122m 3 = 122 162m 4 = 162 200m	0
07	S-Point DID Digits	0-4	0
08	Dial Sending Mode	0 = Enblock Sending 1 = Overlap Sending	0

# Program 10 : System Configuration Setup

## 10-03 : PCB Setup

Item No.	Item	Input Data	Default
09	Dial Information Element (Only for Overlap Sending Mode)	0 = Keypad Facility 1 = Called Party Number	0
10	Master/Slave System (Network Mode only)	0 = Slave System 1 = Master System	0
11	Networking System Number (Network Mode only)	0-50	0
12	short / long-haul	0 = short-haul 1 = long-haul	0
13	Loss-Of-Signal detection limit	In short-haul mode 0 = 0.91V 1 = 0.74V 2 = 0.59V 3 = 0.42V 4 = 0.32V 5 = 0.21V 6 = 0.16V 7 = 0.10V  In long-haul mode 0 = 1.70V 1 = 0.84V 2 = 0.84V 3 = 0.45V 4 = 0.45V 5 = 0.20V 6 = 0.10V 7 = not defined	0
14	Service Protocol for S-Point	0 = Keypad Facility 1 = Specified Protocol for Aspire System	0

**Note 1.** The start port number of a PRI line is displayed. Thirty logic ports are automatically assigned to a PRI line.

**Note 2.** Each timer value of Layer3 is set up for each type in Program 81-06 (T-Bus) and Program 82-06 (S-Bus).

### Conditions

- (A.) When changing a defined terminal type, first set the type to '0' and then plug the new device in to have the system automatically define it or redefine the type manually.
- (B.) The system must have a PCB installed in order to view/change the options for that type of PCB.

---

## Feature Cross Reference

None

---

### Telephone Programming Instructions

To enter data for Program 10-03 (PCB Setup):

1. Enter the programming mode.
2. 10 03

```
10-02-01 Slot No 1
ES|port01 CH1 1 :TEL |1
back ↑ ↓ select
```

3. Enter the number of the item you want to program.

```
10-02-nn Slot No 1
nnnnn
back ↑ ↓ select
```

4. Select a slot number to be programmed by pressing the VOLUME ▲ or VOLUME ▼ keys. Or, press FLASH once to select the slot number or press FLASH twice to select a port number. Enter the slot or port number.
5. Enter data for the item you selected + HOLD.
6. Enter data for the next item in the program.  
OR  
Press MSG once to enter a new item number.  
OR  
Press MSG until you've exited that series's programming section.

# Program 10 : System Configuration Setup

## 10-08 : Pre-Ringing Setup

---

<b>Level:</b> IN	<b>Aspire S</b> • Available.	<b>Aspire</b> • Available.
---------------------	---------------------------------	-------------------------------

---

### Description

Use **Program 10-08 : Pre-Ringing Setup** to enable or disable pre-ringing for trunk calls. This sets how a trunk initially rings a telephone. With pre-ringing, a burst of ringing occurs as soon as the trunk's LED flashes. The call then continues ringing with the normal ring cadence cycle. Without pre-ringing, the call starts ringing only when the normal ring cadence cycle occurs. This may cause a ring delay, depending on when call detection occurs in reference to the ring cycle.

### Input Data

Input Data	Default
0 = disable 1 = enable	<i>Prior to 2.13 Software:</i> 1 <i>With 2.13+ Software:</i> 0

### Conditions

None

---

### Feature Cross Reference

- Central Office Calls, Answering

# Program 10 : System Configuration Setup

## 10-08 : Pre-Ringing Setup

---

---

### Telephone Programming Instructions

To enter data for Program 10-08 (Pre-Ringing Setup):

1. Enter the programming mode.
2. 10 08

```
10-08-01
Pre-ringing  1:Yes
back  ↑      ↓  select
```

3. Enter the number of the item you want to program.

```
10-08-nn
nnnnn
←  -1  +1  →
```

4. Enter data for the item you selected + HOLD.
5. Enter data for the next item in the program.  
OR  
Press MSG once to enter a new item number.  
OR  
Press MSG until you've exited that series's programming section.

# Program 10 : System Configuration Setup

## 10-08 : Pre-Ringing Setup

---

- For Your Notes -

# Program 11 : System Numbering

## 11-01 : System Numbering

<b>Level:</b> IN	<b>Aspire S</b> • Available.	<b>Aspire</b> • Available.
---------------------	---------------------------------	-------------------------------

### Description

Use **Program 11-01 : System Numbering** to set the system's internal (Intercom) numbering plan. The numbering plan assigns the first and second digits dialed and affects the digits an extension user must dial to access other extensions and features, such as service codes and trunk codes. If the default numbering plan does not meet the site requirements, use this program to tailor the system numbering to the site.

#### CAUTION

Improperly programming this option can adversely affect system operation. Make sure you thoroughly understand the default numbering plan before proceeding. If you must change the standard numbering, use the chart for **System Numbering** (page 51) to keep careful and accurate records of your changes.

*Before changing your numbering plan, use the PC Program or Web PC Program to make a backup copy of your system's data.*

Changing the numbering plan consists of three steps:

1. Enter the digits you want to change.
2. Specify the length of the code you select to change.
3. Assign a function to the code selected.

#### Step 1: Enter the digit(s) you want to change

You can make either single or two digit entries. In the Dialed Number column in the **System Numbering** (page 51) table, the nX rows (e.g., 1X) are for single digit codes. The remaining rows (e.g., 11, 12, etc.) are for two digit codes.

- Entering a single digit affects all the Dialed Number entries beginning with that digit. For example, entering 6 affects all number plan entries beginning with 6. The entries you make in step 2 and step 3 below affect the entire range of numbers beginning with 6. (For example, if you enter 3 in step 2 the entries affected would be 600-699. If you enter 4 in step 2 below, the entries affected would be 6000-6999.)
- Entering two digits lets you define codes based on the first two digits a user dials. For example, entering 60 allows you to define the function of all codes beginning with 60. In the default program, only \* and # use two-digit codes. All the other codes are single digit. If you enter a two digit code between 0 and 9, be sure to make separate entries for all the other two digit codes within the range as well. This is because in the default program all the two digit codes between 0 and 9 are undefined.

# Program 11 : System Numbering

## 11-01 : System Numbering

### Description (Cont'd)

#### Step 2: Specify the length of the code you want to change

After you specify a single or two digit code, you must tell the system how many digits comprise the code. This is the *Number of Digits Required* column in the **System Numbering** (page 51) table. In the default program, all codes from 100-999 are three digits long. Codes beginning with 0 are one digit long. Codes beginning with \* are 3 digits long and codes beginning with # are 4 digits long.

#### Step 3: Assign a function to the code selected

After entering a code and specifying its length, you must assign its function. This is the Dial Type column in the **System Numbering** (page 51) table. The choices are:

Dial Types	Dial Type Description	Related Program
0	- Not Used -	
1	Service Code	11-10 : Service Code Setup (for System Administrator) 11-11 : Service Code Setup (for Registration) 11-12 : Service Code Setup (for Service Access) 11-13 : Service Code Setup (for ACD) 11-14 : Service Code Setup (for HOTEL) 11-15 : Service Code Setup (Special access)
2	Extension Number	11-02 : Extension Numbers 11-04 : Virtual Extension Numbers 11-06 : 2PGDAD (ACI) Extension Numbers 11-07 : Department Calling Group Numbers 11-08 : 2PGDAD (ACI) Group Pilot Numbers
3	Trunk Access Code	11-09 : Trunk Access Code
4	Special Trunk Access	11-09 : Trunk Access Code
5	Operator Access	20-17 : Operator's Extension
6	ARS/F-Route Access	44-xx
8	Networking	10-03 : PCB Setup 10-12 : NTCPU Network Setup 10-20 : LAN Setup for External Equipment 10-27 : IP System IP

- Changing the *Dial Type* for a range of codes can have a dramatic affect on how your system operates. Assume, for example, the site is a hotel that has room numbers from 100-399. In order to make extension numbers correspond to room numbers, you should:
  - In Program 11-02, reassign extension numbers on each floor from 100 to 399. (Other applications might also require you to change entries in Program 11-10 through 11-16.)

### Default

See the following tables.



# Program 11 : System Numbering

## 11-01 : System Numbering

System Numbering					
Dial Types: 1=Service Code, 2=Extension Number, 3=Trunk Access, 4=Special Trunk Access, 5=Operator Access, 6=Flexible Routing, 8=Networking, 0=Not Used					
Dialed Number	Number of Digits Required		Dial Type		Network System ID [if type 8] - 0-50
	Default	New	Default	New	
1X	3		1		
11	0		0		
12	0		0		
13	0		0		
14	0		0		
15	0		0		
16	0		0		
17	0		0		
18	0		0		
19	0		0		
10	0		0		
1*	0		0		
1#	0		0		
2X	3		2		
21	0		0		
22	0		0		
23	0		0		
24	0		0		
25	0		0		
26	0		0		
27	0		0		
28	0		0		
29	0		0		
20	0		0		
2*	0		0		
2#	0		0		

# Program 11 : System Numbering

## 11-01 : System Numbering

System Numbering					
Dial Types: 1=Service Code, 2=Extension Number, 3=Trunk Access, 4=Special Trunk Access, 5=Operator Access, 6=Flexible Routing, 8=Networking, 0=Not Used					
Dialed Number	Number of Digits Required		Dial Type		Network System ID [if type 8] - 0-50
	Default	New	Default	New	
3X	3		2		
31	0		0		
32	0		0		
33	0		0		
34	0		0		
35	0		0		
36	0		0		
37	0		0		
38	0		0		
39	0		0		
30	0		0		
3*	0		0		
3#	0		0		
4X	3		2		
41	0		0		
42	0		0		
43	0		0		
44	0		0		
45	0		0		
46	0		0		
47	0		0		
48	0		0		
49	0		0		
40	0		0		
4*	0		0		
4#	0		0		

# Program 11 : System Numbering

## 11-01 : System Numbering

System Numbering					
Dial Types: 1=Service Code, 2=Extension Number, 3=Trunk Access, 4=Special Trunk Access, 5=Operator Access, 6=Flexible Routing, 8=Networking, 0=Not Used					
Dialed Number	Number of Digits Required		Dial Type		Network System ID [if type 8] - 0-50
	Default	New	Default	New	
5X	3		2		
51	0		0		
52	0		0		
53	0		0		
54	0		0		
55	0		0		
56	0		0		
57	0		0		
58	0		0		
59	0		0		
50	0		0		
5*	0		0		
5#	0		0		
6X	3		2		
61	0		0		
62	0		0		
63	0		0		
64	0		0		
65	0		0		
66	0		0		
67	0		0		
68	0		0		
69	0		0		
60	0		0		
6*	0		0		
6#	0		0		

# Program 11 : System Numbering

## 11-01 : System Numbering

System Numbering					
Dial Types: 1=Service Code, 2=Extension Number, 3=Trunk Access, 4=Special Trunk Access, 5=Operator Access, 6=Flexible Routing, 8=Networking, 0=Not Used					
Dialed Number	Number of Digits Required		Dial Type		Network System ID [if type 8] - 0-50
	Default	New	Default	New	
7X	3		2		
71	0		0		
72	0		0		
73	0		0		
74	0		0		
75	0		0		
76	0		0		
77	0		0		
78	0		0		
79	0		0		
70	0		0		
7*	0		0		
7#	0		0		
8X	3		1		
81	0		0		
82	0		0		
83	0		0		
84	0		0		
85	0		0		
86	0		0		
87	0		0		
88	0		0		
89	0		0		
80	0		0		
8*	0		0		
8#	0		0		

# Program 11 : System Numbering

## 11-01 : System Numbering

System Numbering					
Dial Types: 1=Service Code, 2=Extension Number, 3=Trunk Access, 4=Special Trunk Access, 5=Operator Access, 6=Flexible Routing, 8=Networking, 0=Not Used					
Dialed Number	Number of Digits Required		Dial Type		Network System ID [if type 8] - 0-50
	Default	New	Default	New	
9X	1		3		
91	0		0		
92	0		0		
93	0		0		
94	0		0		
95	0		0		
96	0		0		
97	0		0		
98	0		0		
99	0		0		
90	0		0		
9*	0		0		
9#	0		0		
0X	1		5		
01	0		0		
02	0		0		
03	0		0		
04	0		0		
05	0		0		
06	0		0		
07	0		0		
08	0		0		
09	0		0		
00	0		0		
0*	0		0		
0#	0		0		

# Program 11 : System Numbering

## 11-01 : System Numbering

System Numbering					
Dial Types: 1=Service Code, 2=Extension Number, 3=Trunk Access, 4=Special Trunk Access, 5=Operator Access, 6=Flexible Routing, 8=Networking, 0=Not Used					
Dialed Number	Number of Digits Required		Dial Type		Network System ID [if type 8] - 0-50
	Default	New	Default	New	
*X	2		1		
*1	0		0		
*2	0		0		
*3	0		0		
*4	0		0		
*5	0		0		
*6	0		0		
*7	0		0		
*8	0		0		
*9	0		0		
*0	0		0		
**	0		0		
*#	0		0		
#X	0		0		
#1	2		1		
#2	2		1		
#3	2		1		
#4	2		1		
#5	2		1		
#6	2		1		
#7	2		1		
#8	2		1		
#9	2		1		
#0	2		1		
#*	4		1		
##	2		1		

# Program 11 : System Numbering

## 11-01 : System Numbering

---

### Conditions

None

---

### Feature Cross Reference

- Flexible System Numbering

---

### Telephone Programming Instructions

#### To enter data for Program 11-01 (System Numbering):

1. Enter the programming mode.
2. 11 01

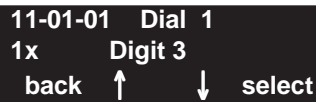

11-01-01 Dial 1  
1x Digit 3  
back ↑ ↓ select

3. Enter the number of the item you want to program.



11-01-nn  
nnnnn  
← →

4. Select the dial number to be programmed by pressing the FLASH or the VOLUME ▲ or VOLUME ▼ keys.
5. Enter data for the item you selected + HOLD.
6. Enter data for the next item in the program.  
OR  
Press MSG once to enter a new item number.  
OR  
Press MSG until you've exited that series's programming section.

# Program 11 : System Numbering

## 11-09 : Trunk Access Code

<b>Level:</b> IN	<b>Aspire S</b>	<b>Aspire</b>
	• Available.	• Available.

### Description

Use **Program 11-09 : Trunk Access Code** to assign the trunk access code (normally 9). The trunk access code can be set from 1 to 8 digits which is defined to type 3 and 4 in Program 11-01. This is the code extension users dial to access Automatic Route Selection. The Individual Trunk Access Code is used when Trunk Group Routing is desired for an outgoing line.

#### Caution

The digit 9 is defined in Program 11-01 as Dial Type 3 with the Number of Digits Required set to 1. If you change the trunk access code in Program 11-09, you must make the corresponding changes in Program 11-01.

### Input Data

Item No.	Item	Input Data	Default	Description	Related Program
01	Trunk Access Code	Dial (Up to 4 digits)	9	Use this program to assign the trunk access code (normally 9). This is the code extension users dial to access Automatic Route Selection.	<ul style="list-style-type: none"> <li>• 11-01 : System Numbering</li> <li>• 14-01 : Trunk Basic Data Setup</li> <li>• 14-05 : Trunk Group</li> <li>• 14-06 : Trunk Group Routing</li> </ul>
02	Alternate Trunk Route Access Code	Dial (Up to 4 digits)	No setting	Use this program to define additional trunk access codes. When a user dials the Alternate Trunk Route Access Code, the system routes their call to the Alternate Trunk Route.	<ul style="list-style-type: none"> <li>• 11-01 : System Numbering</li> <li>• 14-01 : Trunk Basic Data Setup</li> <li>• 14-05 : Trunk Group</li> <li>• 14-06 : Trunk Group Routing</li> <li>• 21-02 : Trunk Group Routing for Extensions</li> <li>• 21-15 : Alternate Trunk Group Routing for Extensions</li> </ul>

### Conditions

None

### Feature Cross Reference

- Automatic Route Selection
- Central Office Calls, Placing
- Trunk Group Routing



# Program 11 : System Numbering

## 11-09 : Trunk Access Code

---

---

### Telephone Programming Instructions

To enter data for Program 11-09 (Trunk Access Code):

1. Enter the programming mode.
2. 11 09



11-09-01  
Trunk\_Access\_Code0  
back ↑ ↓ select

3. Enter the number of the item you want to program.



11-09-nn  
nnnnn  
← →

4. Enter data for the item you selected + HOLD.
5. Enter data for the next item in the program.  
OR  
Press MSG once to enter a new item number.  
OR  
Press MSG until you've exited that series's programming section.

# Program 11 : System Numbering

## 11-09 : Trunk Access Code

---

- For Your Notes -

# Program 14 : Trunk, Basic Setup

## 14-01 : Basic Trunk Data Setup

<b>Level:</b> IN	<b>Aspire S</b>	<b>Aspire</b>
	• Available.	• Available.

### Description

Use **Program 14-01 : Basic Trunk Data Setup** to set the basic options for each trunk port. Refer to the chart below for a description of each option, its range and default setting.

### Input Data

Trunk port number	1-200
-------------------	-------

Item No.	Item	Input Data	Default	Related Program
01	<b>Trunk Name</b> Set the names for trunks. The trunk name displays at display keysets for incoming and outgoing calls.	Up to 12 characters	1 = Line 001   Line 200 = Line 200	
02	<b>Transmit CODEC Gain Type</b> Use this option to select the CODEC gain for the trunk. The option sets the amount of gain (signal amplification) for the trunk you are programming.	1~63 (-15.5 ~ +15.5dB in .5dB intervals)	32 (0dB)	
03	<b>Receive CODEC Gain Type</b> Use this option to select the CODEC gain for the trunk. The option sets the amount of gain (signal amplification) for the trunk you are programming.	1~63 (-15.5 ~ +15.5dB in .5dB intervals)	32 (0dB)	
07	<b>Outgoing Calls</b> Use this option to allow/prevent outgoing calls on the trunk you are programming.	0 = prevented 1 = allowed	1	
10	<b>DTMF Tones for Outgoing Calls</b> Use this option to enable (1) or disable (0) DTMF tones for outgoing trunk calls.	0 = disable 1 = enable	0	

# Program 14 : Trunk, Basic Setup

## 14-01 : Basic Trunk Data Setup

---

### Default

Trunk Port Number	Name
001	LINE 001
002	LINE 002
:	:
200	LINE 200

### Conditions

None

---

## Feature Cross Reference

Refer to features in above chart.

---

## Telephone Programming Instructions

To enter data for Program 14-01 (Basic Trunk Data Setup):

1. Enter the programming mode.
2. 14 01

```
14-01-01   Trunk1
TRK Name = LINE 001
back  ↑    ↓  select
```

3. Enter the number of the item you want to program.

```
14-01-nn   Trunknnn
nnnnnn
←          →
```

4. Select the trunk number to be programmed by pressing the FLASH or the VOLUME ▲ or VOLUME ▼ keys.
5. Enter data for the item you selected + HOLD.
6. Enter data for the next item in the program.  
OR  
Press MSG once to enter a new item number.  
OR  
Press MSG until you've exited that series's programming section.

# Program 14 : Trunk, Basic Setup

## 14-05 : Trunk Group

<b>Level:</b> IN	<b>Aspire S</b>	<b>Aspire</b>
	• Available.	• Available.

### Description

Use **Program 14-05 : Trunk Groups** to assign trunks to Trunk Groups. You can also assign the outbound priority for trunks within the group. When users dial up the trunk group, they seize the trunks in the order you specify in the outbound priority entry.

### Input Data

Trunk Port Number	001-200
-------------------	---------

Trunk Group Number	Order Number
0-100	1-200

### Default

Trunk Port	Group	Priority
1	1	1
:	:	:
200	1	200

### Conditions

None

### Feature Cross Reference

- Trunk Groups

# Program 14 : Trunk, Basic Setup

## 14-05 : Trunk Group

---

---

### Telephone Programming Instructions

To enter data for Program 14-05 (Trunk Group):

1. Enter the programming mode.
2. 14 05

```
14-05-01  Trunk1
Group No.   1
back  ↑      ↓  select
```

3. Enter the number of the item you want to program.

```
14-05-nn  Trunknnn
nnnnn
←          →
```

4. Select the trunk number to be programmed by pressing the FLASH or the VOLUME ▲ or VOLUME ▼ keys.
5. Enter data for the item you selected + HOLD.
6. Enter data for the next item in the program.  
OR  
Press MSG once to enter a new item number.  
OR  
Press MSG until you've exited that series's programming section.

# Program 14 : Trunk, Basic Setup

## 14-07 : Trunk Access Map Setup

<b>Level:</b> IN	<b>Aspire S</b>	<b>Aspire</b>
	• Available.	• Available.

### Description

Use **Program 14-07 : Trunk Access Map Setup** to set up the Trunk Access Maps. This sets an extension's access options for trunks. For example, an extension can only place outgoing calls on trunks to which it has outgoing access. There are 200 Access Maps with all 200 trunk ports programmed in Map 1 with full access.

An extension can use one of the maps you set up in this program. Use Program 15-06 to assign Trunk Access Maps to extensions. Each trunk can have one of eight access options for each Access Map.

### Input Data

Access Map Number	1-200
-------------------	-------

Trunk Port Number	Input Data
001-200	0 = No access 1 = Outgoing access only 2 = Incoming access only 3 = Access only when trunk on Hold 4 = Outgoing access and access when trunk on Hold 5 = Incoming access and access when trunk on Hold 6 = Incoming and Outgoing access 7 = Incoming access, outgoing access and access when trunk on Hold

### Default

- Access Map 1 = Trunk Ports 1-200 assigned with option '7' access (incoming and outgoing access and access when trunk is on Hold).
- Access Maps 2-200 - Trunk Ports 1-200 assigned with option '0' access (no access).

### Conditions

None

### Feature Cross Reference

- Central Office Calls, Answering
- Central Office Calls, Placing

# Program 14 : Trunk, Basic Setup

## 14-07 : Trunk Access Map Setup

---

---

### Telephone Programming Instructions

To enter data for Program 14-07 (Trunk Access Map Setup):

1. Enter the programming mode.
2. 14 07

```
14-07-01 Access Map1
TRK_001=7:OTG/INC/Hold
back ↑ ↓ select
```

3. Enter the number of the item you want to program.

```
14-07-nn Access Mapnn
nnnnn
← →
```

4. Select the Access Map number to be programmed by pressing the FLASH or the VOLUME ▲ or VOLUME ▼ keys.
5. Enter data for the item you selected + HOLD.
6. Enter data for the next item in the program.  
OR  
Press MSG once to enter a new item number.  
OR  
Press MSG until you've exited that series's programming section.



# Program 15 : Extension, Basic Setup

## 15-01 : Basic Extension Data Setup

---

<b>Level:</b>	<b>Aspire S</b>	<b>Aspire</b>
<b>SA</b>	• Available.	• Available.

---

### Description

Use **Program 15-01 : Basic Extension Data Setup** to define the basic settings for each extension.

### Input Data

Extension Number	Max. 8 digits
------------------	---------------

Item No.	Item	Input Data	Default	Related Program
04	<b>ISDN Caller ID</b> If both Program 15-01-04 and 10-03-05 are enabled, the system includes Caller ID in the Setup message as "Presentation Allowed". If these options are disabled, it will be "Presentation Restricted".	0 = Disable 1 = Enable	1	10-03-05

### Conditions

None

---

### Feature Cross Reference

Refer to chart above.

# Program 15 : Extension, Basic Setup

## 15-01 : Basic Extension Data Setup

---

---

### Telephone Programming Instructions

To enter data for Program 15-01 (Basic Extension Data Setup):

1. Enter the programming mode.
2. 15 01

```
15-01-01 TEL301
Ext.Name = EXT 301
back ↑ ↓ select
```

3. Enter the number of the item you want to program.

```
15-01-nn TELnnn
nnnnn
← →
```

4. Select the telephone number to be programmed by pressing the FLASH or the VOLUME ▲ or VOLUME ▼ keys.
5. Enter data for the item you selected + HOLD.
6. Enter data for the next item in the program.  
OR  
Press MSG once to enter a new item number.  
OR  
Press MSG until you've exited that series's programming section.

# Program 15 : Extension, Basic Setup

## 15-02 : Multi-Line Telephone Basic Data Setup

---

<b>Level:</b> <b>IN</b>	Aspire S		Aspire	
	• Available.		• Available.	
	• Item 24 available.		• Item 24 available with software 1.11+.	
	• Item 26 available.		• Item 26 available with software 1.11+.	

---

### Description

Use **Program 15-02 : Multi-Line Telephone Basic Data Setup** to set up various keyset options.

#### Input Data

Extension Number	Max. 8 digits
------------------	---------------

Item No.	Item	Input Data	Default	Related Program
02	<b>Trunk Ring Tone</b> Use this option to set the tone (pitch) of the incoming trunk ring for the extension port you are programming.	1 = High 2 = Mid range 3 = Low 4 = Ring Tone 1 5 = Ring Tone 2 6 = Ring Tone 3 7 = Ring Tone 4 8 = Ring Tone 5	2	22-03

# Program 15 : Extension, Basic Setup

## 15-02 : Multi-Line Telephone Basic Data Setup

Incoming Signal Frequency Pattern	Type	Frequency 1	Frequency 2	Modulation
External Incoming Signal Frequency (Pattern 1)	High	1100	1400	16Hz
	Middle	660	760	16Hz
	Low	520	660	16Hz
External Incoming Signal Frequency (Pattern 2)	High	1100	1400	8Hz
	Middle	660	760	8Hz
	Low	520	660	8Hz
External Incoming Signal Frequency (Pattern 3)	High	1100	1100	Envelope
	Middle	660	660	Envelope
	Low	520	520	Envelope
External Incoming Signal Frequency (Pattern 4)	High	1100	1100	No modulation
	Middle	660	660	No modulation
	Low	520	520	No modulation
Internal Incoming Signal Frequency	High	1100	1400	8Hz
	Middle	660	760	8Hz
	Low	520	660	8Hz

### Conditions

None

### Feature Cross Reference

Refer to above chart.

### Telephone Programming Instructions

To enter data for Program 15-02 (Multi-Line Telephone Basic Data Setup):

1. Enter the programming mode.
2. 15 02

```
15-02-01 TEL301
Language 1:English
back ↑ ↓ select
```

3. Enter the number of the item you want to program.

```
15-02-nn TELnnn
nnnnn
← →
```

4. Select the telephone number to be programmed by pressing the FLASH or the VOLUME ▲ or VOLUME ▼ keys.
5. Enter data for the item you selected + HOLD.
6. Enter data for the next item in the program.  
OR  
Press MSG once to enter a new item number.  
OR  
Press MSG until you've exited that series's programming section.

# Program 15 : Extension, Basic Setup

## 15-06 : Trunk Access Map for Extensions

<b>Level:</b> IN	<b>Aspire S</b>	<b>Aspire</b>
	• Available.	• Available.

### Description

Use **Program 15-06 : Trunk Access Map for Extensions** to define the trunk access map for each extension. An extension can only place outgoing calls on trunks to which it has outgoing access. Use Program 14-07 to define the available 200 access maps.

### Input Data

Extension Number	Max. 8 digits
------------------	---------------

Day/Night Mode	1-8
----------------	-----

Day/Night Mode	Trunk Access Map No.	Default	Related Program
1-8	1-200	1	14-07

### Conditions

None

### Feature Cross Reference

- Central Office Calls, Answering
- Central Office Calls, Placing

# Program 15 : Extension, Basic Setup

## 15-06 : Trunk Access Map for Extensions

---

---

### Telephone Programming Instructions

To enter data for Program 15-06 (Trunk Access Map for Extensions):

1. Enter the programming mode.
2. 15 06

```
15-06-01 TEL301
Mode1    Acc-Map 1
back ↑   ↓ select
```

3. Enter the number of the item you want to program.

```
15-06-nn TELnnn
nnnnn
←           →
```

4. Select the telephone number to be programmed by pressing the FLASH or the VOLUME ▲ or VOLUME ▼ keys.
5. Enter data for the item you selected + HOLD.
6. Enter data for the next item in the program.  
OR  
Press MSG once to enter a new item number.  
OR  
Press MSG until you've exited that series's programming section.

# Program 15 : Extension, Basic Setup

## 15-07 : Programmable Function Keys

<b>Level:</b>	<b>Aspire S</b>	<b>Aspire</b>
<b>SA</b>	• Available.	• Available.

### Description

Use **Program 15-07 : Programmable Function Keys** to set the functions of an extension's Programmable Function Key.

For certain functions, you can append data to the key's basic function. For example, the function 26 appended by data 1 makes a Group Call Pickup key for Pickup Group 1. You can also program Function Keys using Service Codes.

In order to clear any previously programmed key, press the CLEAR key to erase any displayed code.

### Input Data

Extension Number	Max. 8 digits
------------------	---------------

Line Key Number	Function Number	Additional data
1-48	0-99 (General Function Level) (Service Code 851 by default) * 00-* 99 (Appearance Function Level) (Service Code 852 by default)	Refer to the function number list.

### Default

Programmable keys 1-12 are line keys (key 1 = line 1, key 2 = line 2, etc.). All other programmable keys are undefined.

### Function Number List

#### [1] General Function Level (00 – 99) (Service Code 851)

Function Number	Function	Additional Data	LED Indication
00	Not Defined		
63	Outgoing Call Without Caller ID (ISDN)		<b>Red On:</b> Active

# Program 15 : Extension, Basic Setup

## 15-07 : Programmable Function Keys

[2] Appearance Function Level (\*00 - \*99) (Service Code 852)

Function Number	Function	Additional Data	LED Indication
*00	Not Used		
*01	Trunk Key	Trunk Number (001-200)	
*02	Trunk Group/Loop Key	Trunk Group Number (001-100)	
*05	Loop Keys	<ul style="list-style-type: none"> <li>• 0=Incoming + Trunk Group Number (001-100)</li> <li>• 1=Outgoing + Trunk Group Number (001-100)</li> <li>• 2=Both + Trunk Group Number (001-100)</li> </ul>	

### Conditions

When a key is programmed using service code 852, that key cannot be programmed with a function using the 851 code until the key is undefined (000). For example with a Park Key programmed by dialing 852 + \*04 must be undefined by dialing 852 + 000 before it can be programmed as a Voice Over key by dialing 851 + 48.

### Feature Cross Reference

Refer to chart above.

### Telephone Programming Instructions

To enter data for Program 15-07 (Programmable Function Keys):

1. Enter the programming mode.
2. 15 07

```
15-07-01 TEL301
KY01 = *01
back ↑ ↓ select
```

3. Enter the number of the item you want to program.

```
15-07-nn TELnnn
nnnnn
← →
```

4. Select the telephone number to be programmed by pressing the FLASH or the VOLUME ▲ or VOLUME ▼ keys.
5. Enter data for the item you selected + HOLD.
6. Enter data for the next item in the program.
  - OR
  - Press MSG once to enter a new item number.
  - OR
  - Press MSG until you've exited that series's programming section.



# Program 20 : System Option Setup

## 20-02 : System Options for Multi-Line Telephones

---

<b>Level:</b>	<b>Aspire S</b>	<b>Aspire</b>
<b>IN</b>	• Available.	• Available.

---

### Description

Use **Program 20-02 : System Options for Multi-Line Telephones** to set various system options for Multi-Line Telephones.

### Input Data

Item No.	Item	Input Data	Default
02	<b>Trunk Loop Access Key Operating Mode</b> Use this option to set the operating mode of the extension's trunk group keys. The keys can be for incoming access, outgoing access or both.	0 = Outgoing / Incoming 1 = Outgoing 2 = Incoming	0
06	<b>Preselection Time</b> When a keyset user preselects a line key, the system remembers the preselection for this interval.	0-64800 seconds	5

### Conditions

None

---

### Feature Cross Reference

None

# Program 20 : System Option Setup

## 20-02 : System Options for Multi-Line Telephones

---

---

### Telephone Programming Instructions

To enter data for Program 20-02 (System Options for Multi-Line Telephones):

1. Enter the programming mode.
2. 20 02

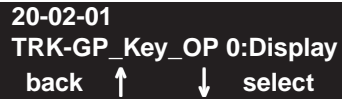

20-02-01  
TRK-GP\_Key\_OP 0:Display  
back ↑ ↓ select

3. Enter the number of the item you want to program.



20-02-nn  
nnnnn  
← →

4. Enter data for the item you selected + HOLD.
5. Enter data for the next item in the program.  
OR  
Press MSG once to enter a new item number.  
OR  
Press MSG until you've exited that series's programming section.

# Program 20 : System Option Setup

## 20-06 : Class of Service for Extensions

<b>Level:</b> IN	<b>Aspire S</b> • Available.	<b>Aspire</b> • Available.
---------------------	---------------------------------	-------------------------------

### Description

Use **Program 20-06 : Class of Service for Extensions** to assign a Class of Service to an extension. There are 15 Classes of Service that can be assigned. To specify the options in each Class of Service, refer to Programs 20-07 through 20-13. You make eight entries for Program 20-06, one for each Night Service Mode.

### Input Data

Extension Number	Max. 8 digits
<b>Day/Night Mode</b>	<b>Class of Service for Extensions</b>
1-8	1-15

### Default

- Extension number 301 is set as Class 15.
- All other extension numbers are set as Class 1.

### Conditions

None

### Feature Cross Reference

- Class of Service

# Program 20 : System Option Setup

## 20-06 : Class of Service for Extensions

---

---

### Telephone Programming Instructions

To enter data for Program 20-06 (Class of Service for Extensions):

1. Enter the programming mode.
2. 20 06

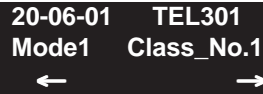

```
20-06-01 TEL301
Mode1 Class_No.1
← →
```

3. Enter the number of the item you want to program.

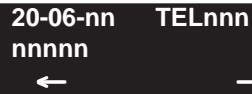

```
20-06-nn TELnnn
nnnnn
← →
```

4. Select the telephone number to be programmed by pressing the FLASH or the VOLUME ▲ or VOLUME ▼ keys.
5. Enter data for the item you selected + HOLD.
6. Enter data for the next item in the program.  
OR  
Press MSG once to enter a new item number.  
OR  
Press MSG until you've exited that series's programming section.

# Program 20 : System Option Setup

## 20-08 : Class of Service Options (Outgoing Call Service)

<b>Level:</b> <b>IN</b>	<b>Aspire S</b>	<b>Aspire</b>
	<ul style="list-style-type: none"> <li>• Available.</li> <li>• Item 17 available.</li> </ul>	<ul style="list-style-type: none"> <li>• Available.</li> <li>• Item 17 available with software 1.11+.</li> </ul>

### Description

Use **Program 20-08 : Class of Service Options (Outgoing Call Service)** to define the outgoing call feature availability for each extension's Class of Service.

### Input Data

Class of Service Number	01-15
-------------------------	-------

Item No.	Item	Input Data	Default		Related Program
			COS 01-14	COS 15	
02	<b>Trunk Calls</b> Turn off or on outgoing trunk calling for the extension.	0 = Off 1 = On	1	1	
07	<b>Repeat Redial</b> Turn off or on an extension's ability to use Repeat Redial.	0 = Off 1 = On	1	1	
12	<b>Department Group Step Calling</b> Turn off or on an extension's ability to use Department Group Step Calling	0 = Off 1 = On	1	1	
13	<b>ISDN CLIP</b> Determine if the ISDN calling line identity presentation and screening indicators are to be allowed.	0 = Off 1 = On	0	0	
14	Call Address Information	0 = Off 1 = On	0	0	
15	<b>Block Outgoing Caller ID</b> Turn off or on the system's ability to automatically block outgoing Caller ID information when a user places a call. If this option is on, the system automatically inserts the Caller ID block code *67 (defined in Program 14-01-21) before the user's dialed digits.	0 = Off 1 = On	0	0	14-01-20 14-01-21

### Conditions

None

### Feature Cross Reference

- Class of Service

# Program 20 : System Option Setup

## 20-08 : Class of Service Options (Outgoing Call Service)

---

---

### Telephone Programming Instructions

To enter data for Program 20-08 (Class of Service Options (Outgoing Call Service)):

1. Enter the programming mode.
2. 20 08

```
20-08-01 FCTN Cls1
Intercom_Call      1:On
←                  →
```

3. Enter the number of the item you want to program.

```
20-08-nn FCTN Clsnn
nnnnn
←                  →
```

4. Select the Class of Service number to be programmed by pressing the FLASH or the VOLUME ▲ or VOLUME ▼ keys.
5. Enter data for the item you selected + HOLD.
6. Enter data for the next item in the program.  
OR  
Press MSG once to enter a new item number.  
OR  
Press MSG until you've exited that series's programming section.

# Program 20 : System Option Setup

## 20-09 : Class of Service Options (Incoming Call Service)

---

<b>Level:</b>	<b>Aspire S</b>	<b>Aspire</b>
<b>IN</b>	• Available.	• Available.

---

### Description

Use **Program 20-09 : Class of Service Options (Incoming Call Service)** to define the incoming call feature availability for each extension's Class of Service.

### Input Data

Class of Service Number	01-15
-------------------------	-------

Item No.	Item	Input data	Default		Related Program
			COS 01-14	COS 15	
03	<b>Sub Address Identification</b> Define whether an extension displays the Caller Sub-Address.	0 = Off 1 = On	0	0	

### Conditions

None

---

### Feature Cross Reference

- Class of Service

# Program 20 : System Option Setup

## 20-09 : Class of Service Options (Incoming Call Service)

---

---

### Telephone Programming Instructions

To enter data for Program 20-09 (Class of Service Options (Incoming Call Service)):

1. Enter the programming mode.
2. 20 09

```
20-09-01 FCTN Cls1
2nd_Call_DDI-Ovrride0:Of
back ↑ ↓ select
```

3. Enter the number of the item you want to program.

```
20-09-nn FCTN Clsnn
nnnnn
← →
```

4. Select the Class of Service number to be programmed by pressing the FLASH or the VOLUME ▲ or VOLUME ▼ keys.
5. Enter data for the item you selected + HOLD.
6. Enter data for the next item in the program.  
OR  
Press MSG once to enter a new item number.  
OR  
Press MSG until you've exited that series's programming section.



# Program 20 : System Option Setup

## 20-13 : Class of Service Options (Supplementary Service)

---

<b>Level:</b> <b>IN</b>	<b>Aspire S</b>	<b>Aspire</b>
	<ul style="list-style-type: none"> <li>• Available.</li> <li>• Item 38 available.</li> </ul>	<ul style="list-style-type: none"> <li>• Available.</li> <li>• Item 38 available with software 1.20+.</li> </ul>

---

### Description

Use **Program 20-13 : Class of Service Options (Supplementary Service)** to define the supplementary feature availability for each extension's Class of Service.

### Input Data

Class of Service Number	01-15
-------------------------	-------

Item No.	Item	Input Data	Default	
			COS 01-14	COS 15
23	<b>Display the Reason for Transfer</b> Select whether an extension should display the reason a call is being transferred to their extension (Call Forward Busy, Call Forward No Answer, DND).	0 = Off 1 = On	0	0
31	Connected Line Identification (COLP)	0 = Off 1 = On	0	0

### Conditions

None

---

### Feature Cross Reference

- Class of Service

# Program 20 : System Option Setup

## 20-13 : Class of Service Options (Supplementary Service)

---

---

### Telephone Programming Instructions

To enter data for Program 20-13 (Class of Service Options (Supplementary Service)):

1. Enter the programming mode.
2. 20 13

```
20-13-01 FCTN Cls1
Long_Conv.Alarm 1:On
back ↑ ↓ select
```

3. Enter the number of the item you want to program.

```
20-13-nn FCTN Clsnn
nnnnn
← →
```

4. Select the Class of Service number to be programmed by pressing the FLASH or the VOLUME ▲ or VOLUME ▼ keys.
5. Enter data for the item you selected + HOLD.
6. Enter data for the next item in the program.  
OR  
Press MSG once to enter a new item number.  
OR  
Press MSG until you've exited that series's programming section.

# Program 20 : System Option Setup

## 20-15 : Ring Cycle Setup

<b>Level:</b>	<b>Aspire S</b>	<b>Aspire</b>
<b>IN</b>	• Available.	• Available.

### Description

Use **Program 20-15 : Ring Cycle Setup** to define the ringing cycles for each ring type.

#### Input Data

Item No.	Incoming Signal Type	Ringing Cycle	Default
01	Normal Incoming Call on Trunk	1-13	3
02	PBX, CES Incoming Call		8
03	Incoming Internal Call		12
04	DID/DISA/VRS		8
05	DID		8
06	Dial-In in the E&M Tie Line		12
07	Door Box Ringing for SLT		8
08	Virtual Extension Ring		8
09	Callback		11
10	Alarm for SLT		5
11	VRS Waiting Message Incoming Call		6

Number	Ringing Cycle
1	On
2	On:2.0 / Off:4.0
3	On:1.0 / Off:2.0
4	On:0.5 / Off:0.5
5	On:0.25 / Off:0.25
6	On:0.5 / Off:0.5 / On:0.5 / Off:1.5
7	On:0.25 / Off:0.25 / On:0.25 / Off:5.25
8	On:0.375 / Off:0.25 / On:0.375 / Off:2.0
9	On:0.25 / Off:0.125 / On:0.25 / Off:0.125 / On:0.25 / Off:2.0
10	On:1.0 / Off:4.0

# Program 20 : System Option Setup

## 20-15 : Ring Cycle Setup

---

Number	Ringing Cycle
11	On:0.25 / Off:0.25 / On:0.25 / Off:4.25
12	On:1.0 / Off:3.0
13	On:0.25 / Off:0.25 / On:0.25 / Off:2.25

### Conditions

None

---

### Feature Cross Reference

None

---

### Telephone Programming Instructions

To enter data for Program 20-15 (Ring Cycle Setup):

1. Enter the programming mode.
2. 20 15

```
20-15-01
TRK_INC_Ring_Cycle 3
back ↑ ↓ select
```

3. Enter the number of the item you want to program.

```
20-15-nn
nnnnn
← →
```

4. Enter data for the item you selected + HOLD.
5. Enter data for the next item in the program.  
OR  
Press MSG once to enter a new item number.  
OR  
Press MSG until you've exited that series's programming section.

# Program 20 : System Option Setup

## 20-19 : System Options for Caller ID

<b>Level:</b> IN	<b>Aspire S</b>	<b>Aspire</b>
	• Available.	• Available.

### Description

Use **Program 20-19 : System Options for Caller ID** to define the system options for the Caller ID feature.

### Input Data

Item No.	Item	Input Data	Default
04	<b>Wait Facility IE Timer</b> This option sets how long the system will wait for the Caller ID name. If set to "0", no name is provided.	0-64800 seconds	10

### Conditions

None

### Feature Cross Reference

- Caller ID

### Telephone Programming Instructions

To enter data for Program 20-19 (System Options for Caller ID):

1. Enter the programming mode.
2. 20 19

```
20-19-01
Caller-ID Format 0:Upper
back ↑ ↓ select
```

3. Enter the number of the item you want to program.

```
20-19-nn
nnnnn
← →
```

4. Enter data for the item you selected + HOLD.
5. Enter data for the next item in the program.  
OR  
Press MSG once to enter a new item number.  
OR  
Press MSG until you've exited that series's programming section.

## **Program 20 : System Option Setup**

### ***20-19 : System Options for Caller ID***

---

- For Your Notes -

# Program 21 : Outgoing Call Setup

## 21-01 : System Options for Outgoing Calls

<b>Level:</b>	<b>Aspire S</b>	<b>Aspire</b>
<b>IN</b>	• Available.	• Available.

### Description

Use **Program 21-01 : System Options for Outgoing Calls** to set the system options for Outgoing Call Service.

### Input Data

Item No.	Item	Input Data	Default	Related Program
03	<b>Trunk Interdigit Time (External)</b> The system waits for this timer to expire before placing the call in a talk state (Call Timer starts after timer expires, Voice Over and Barge-In are not allowed until after timer expires).	0-64800 Seconds	5	14-02-08

### Conditions

None

### Feature Cross Reference

- Central Office Calls, Placing

### Telephone Programming Instructions

**To enter data for Program 21-01 (System Options for Outgoing Service):**

1. Enter the programming mode.
2. 21 01

```

21-01-01
TRK_Routing  0:Prior
back  ↑      ↓  select
```

3. Enter the number of the item you want to program.

```

21-01-nn
nnnnn
←      →
```

4. Enter data for the item you selected + HOLD.
5. Enter data for the next item in the program.
  - OR
  - Press MSG once to enter a new item number.
  - OR
  - Press MSG until you've exited that series's programming section.

# Program 21 : Outgoing Call Setup

## 21-08 : Repeat Dial Setup

<b>Level:</b> IN	<b>Aspire S</b>	<b>Aspire</b>
	• Available.	• Available.

### Description

Use **Program 21-08 : Repeat Dial Setup** to define the automatic Repeat Dial data.

### Input Data

Item No.	Item	Input Data	Default	Related Program
01	<b>Repeat Redial Count</b> Set how many times a Repeat Redial will automatically repeat if the call does not go through.	0-255	3	
02	<b>Repeat Redial Interval Time</b> This timer sets the interval between Repeat Redial attempts.	0-64800	60	
03	<b>Repeat Dial Calling Timer</b> After dialing the trunk call, Repeat Redial maintains the call after this interval. After this interval, the system terminates the call, waits the Repeat Redial Time (Timer 02) and tries again.	0-64800	30	
04	<b>Time for Send Busy Tone for ISDN Trunk</b> Set the timer (sec) to send out Busy Tone with an ISDN line, when called party is in busy.	0-64800	0	

### Conditions

None

### Feature Cross Reference

None



# Program 21 : Outgoing Call Setup

## 21-08 : Repeat Dial Setup

---

---

### Telephone Programming Instructions

To enter data for Program 21-08 (Repeat Dial Setup):

1. Enter the programming mode.
2. 21 08



21-08-01  
Repeat\_Times 3  
back ↑ ↓ select

3. Enter the number of the item you want to program.



21-08-nn  
nnnnn  
← →

4. Enter data for the item you selected + HOLD.
5. Enter data for the next item in the program.  
OR  
Press MSG once to enter a new item number.  
OR  
Press MSG until you've exited that series's programming section.

# Program 21 : Outgoing Call Setup

## 21-12 : ISDN Calling Party Number Setup for Trunks

---

<b>Level:</b> IN	<b>Aspire S</b>	<b>Aspire</b>
	• Available.	• Available.

---

### Description

Use **Program 21-12 : ISDN Calling Party Number Setup for Trunks** to assign Calling Party Numbers for each trunk (maximum 16 digits per entry). When a call is made by an extension which does not have an Extension Calling Number assigned (Program 21-13), the system sends the calling number for the ISDN trunk defined in 21-12.

**Note:** If the Calling Party Number is assigned in both Programs 21-12 and 21-13, the system sends the data in Program 21-13.

### Input Data

Trunk Port Number	001-200
<b>Calling Party Number Data</b>	<b>Default</b>
1-0, *, # (Max. 16 digits)	No setting

### Conditions

None

---

### Feature Cross Reference

- ISDN Compatibility

# Program 21 : Outgoing Call Setup

## 21-12 : ISDN Calling Party Number Setup for Trunks

---

---

### Telephone Programming Instructions

To enter data for Program 21-12 (ISDN Calling Party Number Setup for Trunks):

1. Enter the programming mode.
2. 21 12

```
21-12-01 Trunk1
CLIP_No.
back ↑ ↓ select
```

3. Enter the number of the item you want to program.

```
21-12-nn Trunknnn
nnnnn
← →
```

4. Select the trunk number to be programmed by pressing the FLASH or the VOLUME ▲ or VOLUME ▼ keys.
5. Enter data for the item you selected + HOLD.
6. Enter data for the next item in the program.  
OR  
Press MSG once to enter a new item number.  
OR  
Press MSG until you've exited that series's programming section.

# Program 21 : Outgoing Call Setup

## 21-13 : ISDN Calling Party Number Setup for Extensions

---

<b>Level:</b> IN	<b>Aspire S</b>	<b>Aspire</b>
	• Available.	• Available.

---

### Description

Use **Program 21-13 : ISDN Calling Party Number Setup for Extensions** to assign each extension a Calling Party Number (maximum 16 digits per entry). The calling number is the subscriber number of the dial-in number. When a call is made by an extension which does not have an Extension Calling Number assigned (Program 21-12), the system sends the calling number for the ISDN trunk defined in Program 21-13.

**Note:** If a Calling Party Number is assigned in both Programs 21-12 and 21-13, the system sends the data in Program 21-13.

### Input Data

Extension Number	Max. 8 digits
<b>Calling Party Number Data</b>	<b>Default</b>
1-0, *, # (Max. 16 digits)	No setting

### Conditions

None

---

### Feature Cross Reference

- ISDN Compatibility

# Program 21 : Outgoing Call Setup

## 21-13 : ISDN Calling Party Number Setup for Extensions

---

---

### Telephone Programming Instructions

To enter data for Program 21-13 (ISDN Calling Party Number Setup for Extensions):

1. Enter the programming mode.
2. 21 13

```
21-13-01 TEL301
CLIP_No.
back ↑ ↓ select
```

3. Enter the number of the item you want to program.

```
21-13-nn TELnnn
nnnnn
← →
```

4. Select the telephone number to be programmed by pressing the FLASH or the VOLUME ▲ or VOLUME ▼ keys.
5. Enter data for the item you selected + HOLD.
6. Enter data for the next item in the program.  
OR  
Press MSG once to enter a new item number.  
OR  
Press MSG until you've exited that series's programming section.

# Program 21 : Outgoing Call Setup

## 21-15 : Individual Trunk Group Routing for Extensions

---

<b>Level:</b> IN	<b>Aspire S</b>	<b>Aspire</b>
	• Available.	• Available.

---

### Description

Use **Program 21-15 : Individual Trunk Group Route for Extensions** to designate the alternate trunk access route accessed when a user dials the Alternate Trunk Route Access Code. Refer to Program 11-09-02 : Alternate Trunk Access Code when setting up alternate trunk codes. Turn to Program 14-06 : Trunk Group Routing to set up the trunk routes. When entering data for this option, enter the route number or 0 to prevent routing.

### Input Data

Extension Number	Max. 8 digits
------------------	---------------

Day/Night Mode	Route table number	Default
1-8	0-100 (0 = no setting)	0

### Conditions

None

---

### Feature Cross Reference

- Central Office Calls, Placing

# Program 21 : Outgoing Call Setup

## 21-15 : Individual Trunk Group Routing for Extensions

---

---

### Telephone Programming Instructions

To enter data for Program 21-15 (Individual Trunk Group Routing for Extensions):

1. Enter the programming mode.
2. 21 15

```
21-15-01 TEL301
Mode1 -T.G.R. 0
back ↑ ↓ select
```

3. Enter the number of the item you want to program.

```
21-15-nn TELnnn
nnnnn
← →
```

4. Select the telephone number to be programmed by pressing the FLASH or the VOLUME ▲ or VOLUME ▼ keys.
5. Enter data for the item you selected + HOLD.
6. Enter data for the next item in the program.  
OR  
Press MSG once to enter a new item number.  
OR  
Press MSG until you've exited that series's programming section.

# **Program 21 : Outgoing Call Setup**

## ***21-15 : Individual Trunk Group Routing for Extensions***

---

- For Your Notes -



# Program 22 : Incoming Call Setup

## 22-01 : System Options for Incoming Calls

---

<b>Level:</b>	<b>Aspire S</b>	<b>Aspire</b>
<b>IN</b>	• Available.	• Available.

---

### Description

Use **Program 22-01 : System Options for Incoming Calls** to define the system options for incoming calls.

### Input Data

Item No.	Item	Input Data	Default	Description	Related Program
02	Incoming Call Ring No Answer Alarm	0 = Disable 1 = Enable	0	If enabled, an incoming call that rings longer than the Ring No Answer Alarm interval (22-01-03), will change to a unique ring cadence to indicate that the call has been ringing too long. If disabled, this will not occur.	22-01-03 22-01-04
03	Ring No Answer Alarm Time	0-64800 (Sec.)	60	If a trunk rings a key telephone longer than this interval, the system changes the ring cadence. This indicates to the user that the call has been ringing too long.	22-01-02
04	DIL No Answer Recall Time	0-64800 (Sec.)	0	A DIL that rings its programmed destination longer than this interval diverts to the DIL No Answer Ring Group (set in Program 22-08).	

### Conditions

None

---

### Feature Cross Reference

- Central Office Calls, Answering

# Program 22 : Incoming Call Setup

## 22-01 : System Options for Incoming Calls

---

---

### Telephone Programming Instructions

To enter data for Program 22-01 (System Options for Incoming Call Service):

1. Enter the programming mode.
2. 22 01

```
22-01-01
INC_Priority 1:Trunk
back ↑ ↓ select
```

3. Enter the number of the item you want to program.

```
22-01-nn
nnnnn
← →
```

4. Enter data for the item you selected + HOLD.
5. Enter data for the next item in the program.  
OR  
Press MSG once to enter a new item number.  
OR  
Press MSG until you've exited that series's programming section.

# Program 22 : Incoming Call Setup

## 22-02 : Incoming Call Trunk Setup

<b>Level:</b> IN	<b>Aspire S</b>	<b>Aspire</b>
	• Available.	• Available.

### Description

Use **Program 22-02 : Incoming Call Trunk Setup** to assign the incoming trunk type for each trunk. There is one item for each Night Service Mode.

### Input Data

Trunk port number	1-200
-------------------	-------

Day/Night Mode	Incoming Type	Default	Description	Related Program
1-8	0 = Normal 1 = VRS (Second dial tone if no VRS installed) 2 = DISA 3 = DID 4 = DIL 5 = E&M Tie line 6 = Delayed DID 7 = ANI/DNIS	0	Use this option to set the feature type for the trunk you are programming.	14-04

### Conditions

- (A.) When connecting to T1 trunks, after changing Program 22-02-01 to match the telco's connected T1 service type, the T1 cable or the T1 PCB must be unplugged and then reconnected in order for the T1 PCB to sync.

### Feature Cross Reference

- Central Office Calls, Answering

# Program 22 : Incoming Call Setup

## 22-02 : Incoming Call Trunk Setup

---

---

### Telephone Programming Instructions

To enter data for Program 22-02 (Incoming Service Type Setup):

1. Enter the programming mode.
2. 22 02

```
22-02-01
Mode1 =0:Normal
back  ↑   ↓  select
```

3. Enter the number of the item you want to program.

```
22-02-nn
nnnnn
←           →
```

4. Enter data for the item you selected + HOLD.
5. Enter data for the next item in the program.  
OR  
Press MSG once to enter a new item number.  
OR  
Press MSG until you've exited that series's programming section.

# Program 22 : Incoming Call Setup

## 22-03 : Trunk Ring Tone Range

Level:

IN

Aspire S	Aspire
• Available.	• Available.
• Melody 1-5 available.	• Melody 1-5 added with software 0.27+.

### Description

Use **Program 22-03 : Trunk Ring Tone Range** to select the ring tone range for the trunk. The trunk uses a ring tone within the range selected when it rings an extension. There are four ring tones available. Customize the Trunk Ring Tones in Program 82-01.

### Input Data

Trunk port number	1-200
-------------------	-------

Ring Tone Pattern	Default	Description	Related Program
0-8 (Ring Tone pattern 1-4) (Melody 1 - Melody 5)	0	Use this program to select the ring tone range for the trunk. The trunk uses a ring tone within the range selected when it rings an extension. There are four ring tones available.	15-02

Incoming Signal Frequency Pattern	Type	Frequency 1	Frequency 2	Modulation
Pattern 1	High	1100	1400	16Hz
	Middle	660	760	16Hz
	Low	520	660	16Hz
Pattern 2	High	1100	1400	8Hz
	Middle	660	760	8Hz
	Low	520	660	8Hz
Pattern 3	High	1100	1100	Envelope
	Middle	660	660	Envelope
	Low	520	520	Envelope
Pattern 4	High	1100	1100	No modulation
	Middle	660	660	No modulation
	Low	520	520	No modulation

### Conditions

None

# Program 22 : Incoming Call Setup

## 22-03 : Trunk Ring Tone Range

---

---

### Feature Cross Reference

- Selectable Ring Tones

---

### Telephone Programming Instructions

To enter data for Program 22-03 (Trunk Ring Tone Range):

1. Enter the programming mode.
2. 22 03

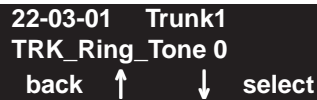

```
22-03-01 Trunk1
TRK_Ring_Tone 0
back  ↑   ↓  select
```

3. Enter the number of the item you want to program.

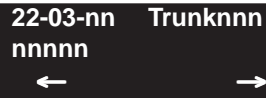

```
22-03-nn Trunknnn
nnnnn
←           →
```

4. Select the trunk number to be programmed by pressing the FLASH or the VOLUME ▲ or VOLUME ▼ keys.
5. Enter data for the item you selected + HOLD.
6. Enter data for the next item in the program.  
OR  
Press MSG once to enter a new item number.  
OR  
Press MSG until you've exited that series's programming section.

# Program 22 : Incoming Call Setup

## 22-04 : Incoming Extension Ring Group Assignment

---

<b>Level:</b>	<b>Aspire S</b>	<b>Aspire</b>
<b>SA</b>	• Available.	• Available.

---

### Description

Use **Program 22-04 : Incoming Extension Ring Group Assignment** to assign extensions to Ring Groups. Calls ring extensions according to Ring Group programming. Use Program 22-05 to assign trunks to Ring Groups and use Program 22-06 to set the ringing for the phones. IRG can have up to 32 extension numbers assigned.

### Input Data

Incoming Ring Group Number	1-100
----------------------------	-------

Incoming Ring Group No.	Extension Number	Description	Related Program
01-32	Max. 8 digits	Use this program to assign extensions to Ring Groups. Calls ring extensions according to Ring Group programming.	22-02 22-05 22-06

### Default

Extension 301 rings for incoming Ring Group 1 calls. All other extensions do not ring for incoming Ring Group 1 calls.

### Conditions

None

---

### Feature Cross Reference

- Ring Groups

# Program 22 : Incoming Call Setup

## 22-04 : Incoming Extension Ring Group Assignment

---

---

### Telephone Programming Instructions

To enter data for Program 22-04 (Incoming Extension Ring Group Assignment):

1. Enter the programming mode.
2. 22 04

```
22-04-01  INC Group1
IRG 01=301
back  ↑      ↓  select
```

3. Enter the number of the item you want to program.

```
22-04-nn  INC Groupnnn
nnnnn
←          →
```

4. Select the Incoming Ring Group number to be programmed by pressing the FLASH or the VOLUME ▲ or VOLUME ▼ keys.
5. Enter data for the item you selected + HOLD.
6. Enter data for the next item in the program.  
OR  
Press MSG once to enter a new item number.  
OR  
Press MSG until you've exited that series's programming section.



# Program 22 : Incoming Call Setup

## 22-05 : Incoming Trunk Ring Group Assignment

---

<b>Level:</b>	<b>Aspire S</b>	<b>Aspire</b>
<b>IN</b>	• Available.	• Available.

---

### Description

Use **Program 22-05 : Incoming Trunk Ring Group Assignment** to assign trunks to incoming Ring Groups.

### Input Data

Trunk Port Number	001-200
-------------------	---------

Day/Night Mode	Incoming Group Number	Default	Description	Related Program
1-8	0 (No setting) 1-100 (Incoming Group) 102 (In-Skin/External Voice Mail) 103 (Centralized Voice Mail)	1	Use this program to assign Normal Ring Trunks (22-02) to Incoming Ring Groups (22-04).	22-04 22-06

### Conditions

None

---

### Feature Cross Reference

- Ring Groups

# Program 22 : Incoming Call Setup

## 22-05 : Incoming Trunk Ring Group Assignment

---

---

### Telephone Programming Instructions

To enter data for Program 22-05 (Incoming Trunk Ring Group Assignment):

1. Enter the programming mode.
2. 22 05

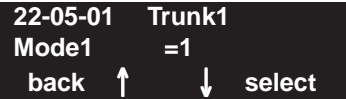

```
22-05-01 Trunk1
Mode1      =1
back  ↑      ↓  select
```

3. Enter the number of the item you want to program.



```
22-05-nn Trunknnn
nnnnn
←                →
```

4. Select the trunk number to be programmed by pressing the FLASH or the VOLUME ▲ or VOLUME ▼ keys.
5. Enter data for the item you selected + HOLD.
6. Enter data for the next item in the program.  
OR  
Press MSG once to enter a new item number.  
OR  
Press MSG until you've exited that series's programming section.

# Program 22 : Incoming Call Setup

## 22-06 : Normal Incoming Ring Mode

<b>Level:</b> IN	<b>Aspire S</b>	<b>Aspire</b>
	• Available.	• Available.

### Description

Use **Program 22-06 : Normal Incoming Ring Mode** to define whether or not an extension should ring for the Normal Incoming Ring Mode.

### Input Data

Extension Number	Max. 8 digits
------------------	---------------

Day/Night Mode	Incoming Group Number	Default	Related Program
1-8	0 = No Ring 1 = Ring	1	22-04 22-05

### Conditions

None

### Feature Cross Reference

- Central Office Calls, Answering

# Program 22 : Incoming Call Setup

## 22-06 : Normal Incoming Ring Mode

---

---

### Telephone Programming Instructions

To enter data for Program 22-06 (Normal Incoming Ring Mode):

1. Enter the programming mode.
2. 22 06

```
22-06-01 TEL301
Mode1 =1:Ring On
back ↑ ↓ select
```

3. Enter the number of the item you want to program.

```
22-06-nn TELnnn
nnnnn
← →
```

4. Select the telephone number to be programmed by pressing the FLASH or the VOLUME ▲ or VOLUME ▼ keys.
5. Enter data for the item you selected + HOLD.
6. Enter data for the next item in the program.  
OR  
Press MSG once to enter a new item number.  
OR  
Press MSG until you've exited that series's programming section.

# Program 22 : Incoming Call Setup

## 22-08 : DIL/IRG No Answer Destination

---

<b>Level:</b>	<b>Aspire S</b>	<b>Aspire</b>
<b>IN</b>	• Available.	• Available.

---

### Description

For DIL Delayed Ringing, use **Program 22-08 : DIL/IRG No Answer Destination** to assign the DIL No Answer Ring Group. An unanswered DIL rings this group after the DIL No Answer Time expires (Program 22-01-04). DIL Delayed Ringing can also reroute outside calls ringing a Ring Group.

You make eight assignments, one for each Night Service mode.

### Input Data

Trunk Port Number	001-200
-------------------	---------

Day/Night Mode	Incoming Group Number	Default
1-8	0 (No setting) 1-100 (Incoming Group) 102 (In-Skin/External Voice Mail) 103 (Centralized Voice Mail)	1

### Conditions

None

---

### Feature Cross Reference

- Direct Inward Line (DIL)
- Ring Group

# Program 22 : Incoming Call Setup

## 22-08 : DIL/IRG No Answer Destination

---

---

### Telephone Programming Instructions

To enter data for Program 22-08 (DIL/IRG No Answer Destination):

1. Enter the programming mode.
2. 22 08

```
22-08-01  Trunk1
Mode1      =1
back  ↑      ↓  select
```

3. Enter the number of the item you want to program.

```
22-08-nn  Trunknnn
nnnnn
←          →
```

4. Select the trunk number to be programmed by pressing the FLASH or the VOLUME ▲ or VOLUME ▼ keys.
5. Enter data for the item you selected + HOLD.
6. Enter data for the next item in the program.  
OR  
Press MSG once to enter a new item number.  
OR  
Press MSG until you've exited that series's programming section.

# Program 22 : Incoming Call Setup

## 22-11 : DID Translation Number Conversion

<b>Level:</b> <b>SA</b>	<b>Aspire S</b>	<b>Aspire</b>
	<ul style="list-style-type: none"> <li>• Available.</li> <li>• Option 11 available.</li> </ul>	<ul style="list-style-type: none"> <li>• Available.</li> <li>• Option 11 available with software 1.11+.</li> </ul>

### Description

Use **Program 22-11 : DID Translation Table Number Conversion** to specify for each Translation Table entry (2000):

- The digits received by the system (eight max.)
- The extension the system dials after translation (24 digits max.)
- The name that should show on the dialed extension's display when it rings (twelve characters max.)
- The Transfer Target-1 and 2  
*If the Transfer Targets are busy or receive no answer, those calls are transferred to the final transfer destination (Program 22-10).*
- Operation mode

Use the following chart when entering and editing text for names. Press the key once for the first character, twice for the second character, etc. For example, to enter a C, press "2" three times.

<b>With Software 2.05+: Key for Entering Names</b>	
<b>When entering names in the procedures below, refer to this chart. Names can be up to 12 digits long. For prior software or when using i-Series phones, refer to the charts in the Name Storing feature (page 328).</b>	
Use this keypad digit . . .	When you want to . . .
1	Enter characters: 1 @ [ ¥ ] ^ _ ` {   } → ← Á À Â Ã Ç É Ê ì ó
2	Enter characters A-C, a-c, 2.
3	Enter characters D-F, d-f, 3.
4	Enter characters G-I, g-i, 4.
5	Enter characters J-L, j-l, 5.
6	Enter characters M-O, m-o, 6.
7	Enter characters P-S, p-s, 7.
8	Enter characters T-V, t-v, 8.
9	Enter characters W-Z, w-z, 9.
0	Enter characters: 0 ! “ # \$ % & ’ ( ) ô õ ú ä ö ü α ε θ
*	Enter characters: * + , - . / : ; < = > ? π Σ σ Ω ∞ φ £
#	# = Accepts an entry (only required if two letters on the same key are needed - ex: <b>TOM</b> ). Pressing # again = Space. (In system programming mode, use the right arrow soft key instead to accept and/or add a space.)
CONF	Clear the character entry one character at a time.
CLEAR	Clear all the entries from the point of the flashing cursor and to the right.

# Program 22 : Incoming Call Setup

## 22-11 : DID Translation Number Conversion

### Input Data

Conversion Table Number	1-2000
-------------------------	--------

Item No.	Item	Input Data	Default
01	Received Number	Max. 8 digits	No setting
02	Target Number	Max. 24 digits	No setting
03	DID Name	Max. 12 characters	No setting
04	Transfer Operation Mode	0 = No transfer 1 = Busy 2 = No answer 3 = Busy / No answer	0
05	Transfer Destination Number -1	0 = No setting 1-100 = Incoming Group 101 = DSPDB Voice Mail 102 = In-Skin/External Voice Mail 103 = Centralized Voice Mail 201-264 = Extension Group 400 = DID 401 = DISA 1000-1999 = Abbreviated Number (000-999)	0
06	Transfer Destination Number -2		0
07	Call Waiting	0 = Disable 1 = Enabled	0
08	Maximum Number of DID Calls	0-200 (0 = no limit)	0
09	Music on Hold Source	0 = IC/MOH Port 1 = BGM Port 2 = ACI Port	0
10	ACI Music Source Port	When a sound source type is 2 in above : (0-96)	0
11	<p><b>Ring Group Transfer</b> Enable (1) or disable (0) each conversation tables' ability to follow the Ring Group programming defined in <b>Program 22-12-01 : DID Intercept Ring Group</b>.</p> <p>If <b>Program 22-11-05 : DID Translation Number Conversion, Transfer Destination Number 1</b> and <b>Program 22-11-06 : DID Translation Number Conversion, Transfer Destination Number 2</b> are set, the priority of transferring will be in this order: Program 22-11-05 then Program 22-11-06 then if Program 2-11-11 is enabled, Program 22-12-01.</p>	0 = Disable 1 = Enabled	1

### Conditions

None



# Program 22 : Incoming Call Setup

## 22-11 : DID Translation Number Conversion

---

---

### Feature Cross Reference

- Direct Inward Dialing (DID)

---

### Telephone Programming Instructions

To enter data for Program 22-11 (DID Translation Number Conversion):

1. Enter the programming mode.
2. 22 11

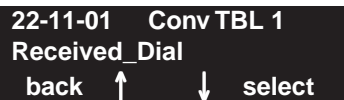

```
22-11-01  Conv TBL 1
Received_Dial
back  ↑      ↓  select
```

3. Enter the number of the item you want to program.

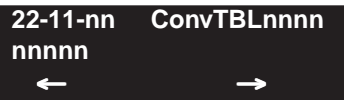

```
22-11-nn  ConvTBLnnnn
nnnnn
←          →
```

4. Select the Conversation Table number to be programmed by pressing the FLASH or the VOLUME ▲ or VOLUME ▼ keys.
5. Enter data for the item you selected + HOLD.
6. Enter data for the next item in the program.  
OR  
Press MSG once to enter a new item number.  
OR  
Press MSG until you've exited that series's programming section.

## **Program 22 : Incoming Call Setup**

### ***22-11 : DID Translation Number Conversion***

---

- For Your Notes -

# Program 35 : SMDR Options

## 35-02 : SMDR Output Options

---

<b>Level:</b>	<b>Aspire S</b>	<b>Aspire</b>
<b>IN</b>	• Available.	• Available.

---

### Description

Use **Program 35-02 : SMDR Output Options** to set the SMDR (Station Message Detail Recording) output options for each of the 8 SMDR ports. Refer to the following chart for a description of each option, its range and default setting.

### Input Data

SMDR Port Number	1-8
------------------	-----

Item No.	Item	Input Data	Default
16	<b>Trunk Name or Received Dialed Number</b> Determine how the SMDR should print incoming calls on ANI/DNIS or DID trunks. If set to (1), ANI/DNIS trunks can print DNIS digits. If set to (0) trunk names are printed instead.	0=Trunk port name 1=Received dialed number	0

### Conditions

None

---

### Feature Cross Reference

- Station Message Detail Recording

# Program 35 : SMDR Options

## 35-02 : SMDR Output Options

---

---

### Telephone Programming Instructions

To enter data for Program 35-02 (SMDR Output Options):

1. Enter the programming mode.
2. 35 02

```
35-02-01  SMDR Port1
T/R Call   1:Display
back  ↑    ↓  select
```

3. Enter the number of the item you want to program.

```
35-02-nn  SMDR Portn
nnnnn
←          →
```

4. Select the SMDR port number to be programmed by pressing the FLASH or the VOLUME ▲ or VOLUME ▼ keys.
5. Enter data for the item you selected + HOLD.
6. Enter data for the next item in the program.  
OR  
Press MSG once to enter a new item number.  
OR  
Press MSG until you've exited that series's programming section.

# Program 81 : Basic Hardware Setup for Trunk

## 81-01 : COIU Initial Data Setup

<b>Level:</b>	<b>Aspire S</b>	<b>Aspire</b>
<b>MF</b>	• Available.	• Available.

### Description

Use **Program 81-01 : COIU Initial Data Setup** to define the various basic timers for COIU PCBs.

### Input Data

Item No.	Item	Input Data	Default
01	Companding Method Type	0 = u-law 1 = A-law	0 (u-law)
02	Loop Current Detection Time	1-255 (8-2040mS)	75 (600ms)
03	Clear Signal (Open Loop) Detection Time	1-255 (8-2040mS)	90 (720ms)
04	Ringing Signal Detection Minimum Time	1-255 (8-2040mS)	13 (104ms)
05	Single Ringing Detection Minimum Time	0-255 (0,8-2040mS)	82 (656ms)
06	Double Ringing Detection Minimum off Time	0-255 (0,8-2040mS)	13 (104ms)
07	Double Ringing Detection Maximum off Time	0-255 (0,8-2040mS)	50 (400ms)
08	Ringing Signal Not Detected Minimum	1-255 (8-2040mS)	88 (704ms)
09	Abandoned Call Detection Timer	1-255 (64-16320mS)	94 (6016ms)
10	Continuous Ringing Minimum Time	0-255 (0,8-2040mS)	38 (304ms)
11	Continuous Ringing Maximum Time	0-255 (0,8-2040mS)	88 (704ms)
12	AC Impedance Timer	1-255 (64-16320mS)	4 (256ms)
13	Grounding Time	1-255 (4-1020mS)	9 (36ms)
14	<b>Flash (Hooking 1)</b> This sets the flash (Hooking 1) duration for analog trunk calls. See Program 14-02-04.	1-255 (16-4080mS)	50 (800ms)
15	<b>Flash (Hooking 2)</b> This sets the flash (Hooking 2) duration for analog trunk calls. See Program 14-02-04.	1-255 (16-4080mS)	156 (2496ms)
16	Pause Time	1-255 (16-4080mS)	16 (1024ms)
17	PFT Idle Detection Time	1-255 (64-16320mS)	47 (3008ms)
18	Grounding Start Time	1-255 (8-2040mS)	6 (48ms)
19	Grounding Start Give-Up Time	1-255 (64-16320mS)	47 (3008ms)
20	Loop Reverse Detect Minimum Time	1-255 (8-2040mS)	13 (104ms)
21	Loop Reverse Detect Maximum Time	1-255 (8-2040mS)	107 (856ms)

# Program 81 : Basic Hardware Setup for Trunk

## 81-01 : COIU Initial Data Setup

Item No.	Item	Input Data	Default
22	Loop Disconnect Detect Minimum Time	1-255 (8-2040mS)	50 (400ms)
23	Loop Disconnect Detect Maximum Time	1-255 (8-2040mS)	80 (640ms)
24	On Hook Normal Detect Time	1-255 (8-2040mS)	3 (24ms)
25	On Hook Reverse Detect Time	1-255 (8-2040mS)	2 (16ms)
26	On Hook Disconnect Detect Time	1-255 (16-4080mS)	188 (3008ms)
27	Pulse Dial Break Time (10pps)	1-255 (4-1020mS)	8 (32ms)
28	Pulse Dial Make Time (10pps)	1-255 (4-1020mS)	4 (16ms)
29	Inter-Digit Time (10pps)	1-255 (32-8160mS)	19 (608ms)
30	Pulse Dial Break Time (20pps)	1-255 (4-1020mS)	4 (16ms)
31	Pulse Dial Make Time (20pps)	1-255 (4-1020mS)	2 (8ms)
32	Inter-Digit Time (20pps)	1-255 (32-8160mS)	16 (512ms)
33	Charging Pulse Minimum Duration Time	1-255 (8-2040mS)	9 (72ms)
34	Charging Pulse Minimum Period Time	1-255 (8-2040mS)	29 (232ms)
35	Charging Pulse Minimum Interval Time	1-255 (8-2040mS)	6 (48ms)

### Conditions

None

---

### Feature Cross Reference

- Central Office Calls, Placing

# Program 81 : Basic Hardware Setup for Trunk

## 81-01 : COIU Initial Data Setup

---

---

### Telephone Programming Instructions

To enter data for Program 81-01 (COIU Initial Data Setup):

1. Enter the programming mode.
2. 81 01

```
81-01-01
Encoding Type 0: U-LAW
back ↑ ↓ select
```

3. Enter the number of the item you want to program.

```
81-01-nn
nnnnn
← →
```

4. Enter data for the item you selected + HOLD.
5. Enter data for the next item in the program.  
OR  
Press MSG once to enter a new item number.  
OR  
Press MSG until you've exited that series's programming section.

# Program 81 : Basic Hardware Setup for Trunk

## *81-01 : COIU Initial Data Setup*

---

- For Your Notes -



# Program 82 : Basic Hardware Setup for Extension

## 82-01 : Incoming Ring Tone

<b>Level:</b>	<b>Aspire S</b>	<b>Aspire</b>
<b>MF</b>	• Available.	• Available.

### Description

Use **Program 82-01 : Incoming Ring Tone** to set the incoming ring tones, which are the tones a user hears when a call rings an extension. These tones are grouped into four ring tone *Ranges* (1-4), also called patterns, that consist of a combination of frequencies. (You assign a specific *Range* to trunks in Program 22-03 and to extensions in Program 15-02.) Within each *Range* there are three frequency *Types*: High, Middle and Low. (Service Code 820 allows users to choose the *Type* for their incoming calls.) Each *Type* in turn consists of two frequencies and the modulation “played” simultaneously to make up the tone. These frequencies are determined by their Frequency Number selected in Items 1 and 2 (see below). In this program, you assign the two *Frequency Numbers* and *Modulation* for each *Type*, for each of the four *Ranges*. The chart below shows the default *Frequency Numbers* for each *Type* in each *Range*.

### Input Data

Incoming Ringing Tone Number	1 = Pattern 1 (Trunk Incoming) 2 = Pattern 2 (Trunk Incoming) 3 = Pattern 3 (Trunk Incoming) 4 = Pattern 4 (Trunk Incoming) 5 = Intercom Incoming Pattern
------------------------------	---

Ringing Tone Type Number	1 = High 2 = Mid 3 = Low
--------------------------	--------------------------------

Item No.	Item	Input Data
01	Frequency 1	1 = 520Hz 2 = 540Hz 3 = 660Hz 4 = 760Hz 5 = 1100Hz 6 = 1400Hz 7 = 2000Hz
02	Frequency 2	
03	Modulation	0 = No modulation 1 = 8Hz modulation 2 = 16Hz modulation 3 = envelope

# Program 82 : Basic Hardware Setup for Extension

## 82-01 : Incoming Ring Tone

---

### Default

Incoming Ringing Tone Number	Tone Type	Frequency 1	Frequency 2	Modulation
Pattern 1 (Trunk Incoming)	High Mid Low	1100 660 520	1400 760 660	16Hz Modulation 16Hz Modulation 16Hz Modulation
Pattern 2 (Trunk Incoming)	High Mid Low	1100 660 520	1400 760 660	8Hz Modulation 8Hz Modulation 8Hz Modulation
Pattern 3 (Trunk Incoming)	High Mid Low	1100 660 520	1100 660 520	envelope envelope envelope
Pattern 4 (Trunk Incoming)	High Mid Low	1100 660 520	1100 660 520	No modulation No modulation No modulation
Intercom Incoming Pattern	High Mid Low	1100 660 520	1400 760 660	8Hz Modulation 8Hz Modulation 8Hz Modulation
Alarm Sensor Pattern	High Mid Low	760 760 760	760 760 760	envelope envelope envelope

### Conditions

None

---

## Feature Cross Reference

- Distinctive Ringing Tones and Flash Patterns
- Selectable Ring Tones

# Program 82 : Basic Hardware Setup for Extension

## 82-01 : Incoming Ring Tone

---

---

### Telephone Programming Instructions

To enter data for Program 82-01 (Incoming Ring Tone):

1. Enter the programming mode.
2. 82 01

```
82-01-01  INC Freq  1
INC-Rng1  Freq1:5:1100Hz
back  ↑          ↓  select
```

3. Enter the number of the item you want to program.

```
82-01-nn
nnnnn
←          →
```

4. Enter data for the item you selected + HOLD.
5. Enter data for the next item in the program.  
OR  
Press MSG once to enter a new item number.  
OR  
Press MSG until you've exited that series's programming section.

# Program 82 : Basic Hardware Setup for Extension

## *82-01 : Incoming Ring Tone*

---

- For Your Notes -

# NEC

NEC Unified Solutions, Inc.  
4 Forest Parkway, Shelton, CT 06484  
Tel: 800-365-1928 Fax: 203-926-5458  
[www.necunifiedsolutions.com](http://www.necunifiedsolutions.com)

## Other Important Telephone Numbers

Sales: . . . . .	203-926-5450
Customer Service: . . . . .	203-926-5444
Customer Service FAX: . . . . .	203-926-5454
Technical Service: . . . . .	203-925-8801
Discontinued Product Service: . . . . .	900-990-2541
Technical Training: . . . . .	203-926-5430
Emergency Technical Service (After Hours) . . . . .	203-929-7920
(Excludes discontinued products)	

# NEC

NEC Unified Solutions, Inc.  
4 Forest Parkway, Shelton, CT 06484  
TEL: 203-926-5400 FAX: 203-929-0535  
[www.necunifiedsolutions.com](http://www.necunifiedsolutions.com)



0893212

July 1, 2004  
Printed in U.S.A.

## Free Manuals Download Website

<http://myh66.com>

<http://usermanuals.us>

<http://www.somanuals.com>

<http://www.4manuals.cc>

<http://www.manual-lib.com>

<http://www.404manual.com>

<http://www.luxmanual.com>

<http://aubethermostatmanual.com>

Golf course search by state

<http://golfingnear.com>

Email search by domain

<http://emailbydomain.com>

Auto manuals search

<http://auto.somanuals.com>

TV manuals search

<http://tv.somanuals.com>