



S o u n d S p a c e 5

Stereo Music System

Owner's Manual

WARNING

TO REDUCE THE RISK OF FIRE OR ELECTRIC SHOCK, DO NOT EXPOSE THIS APPLIANCE TO RAIN OR MOISTURE.



CAUTION

TO REDUCE THE RISK OF ELECTRIC SHOCK, DO NOT REMOVE COVER (OR BACK). NO USER-SERVICEABLE PARTS INSIDE. REFER SERVICING TO QUALIFIED SERVICE PERSONNEL.



The lightning flash with arrowhead symbol, within an equilateral triangle, is intended to alert the user to the presence of uninsulated "dangerous voltage" within the product's enclosure; that may be of sufficient magnitude to constitute a risk of electric shock to persons.



The exclamation point within an equilateral triangle is intended to alert the user to the presence of important operating and maintenance (servicing) instructions in the literature accompanying the appliance.

This equipment has been tested and found to comply with the limits for a Class B digital device, pursuant to part 15 of the FCC Rules. These limits are designed to provide reasonable protection against harmful interference in a residential installation. This equipment generates, uses and can radiate radio frequency energy and, if not installed and used in accordance with the instructions, may cause harmful interference to radio communications. However, there is no guarantee that interference will not occur in a particular installation. If this equipment does cause harmful interference to radio or television reception, which can be determined by turning the equipment off and on, the user is encouraged to try to correct the interference by one or more of the following measures:

- Reorient or relocate the receiving antenna.
- Increase the separation between the equipment and receiver.
- Connect the equipment into an outlet on a circuit different from that to which the receiver is connected.
- Consult the dealer or an experienced radio/TV technician for help.

WARNING

The Federal Communications Commission does not allow any modifications or changes to the unit EXCEPT as that specified by Nakamichi in this manual. Failure to comply with this government regulation could void your authority to operate the equipment.

This digital apparatus does not exceed the CLASS B limits for radio noise emissions from digital apparatus set out in the Radio Interference Regulations of the Canadian Department of Communications.

Please record the serial number in the space provided below and retain this number. The serial number is located on the rear panel of the unit.

Model Number: SoundSpace 5 _____

Serial Number : _____

Important Notice

This is applicable to sales outside the European Community.

We thank you for your purchase of this Nakamichi product and trust that it will provide you with many years of trouble-free performance. Should you be using your Nakamichi product in a country other than the one in which it was originally purchased, we ask you note the following:

- 1) The appointed Nakamichi distributor for any given country is responsible for warranty servicing only on units distributed by or through it in that country in accordance with its applicable warranty.
- 2) Should a Nakamichi product require servicing in a country other than the one in which it was originally purchased, the end user may seek to have repairs performed by the nearest Nakamichi distributor, subject to that distributor's local servicing policies, but all costs of repair (parts, labor, transportation) must be born by the owner of the Nakamichi product.

Thank you again for your purchase.

Nakamichi Corporation
Tokyo, Japan

Contents

Safety Instructions	4
Usage Precautions	6
External View	8
Installation	9
Connections	10
Basic Operation	14
CD Playback (Basic)	16
CD Playback (Advanced)	20
FM/AM Broadcast Reception	24
Other Functions	26
Troubleshooting	30
Specifications	32

Safety Instructions

The following safety instructions have been included in compliance with safety standard regulations. Please read them carefully.

1. Read Instructions – All the safety and operating instructions should be read before the appliance is operated.
2. Retain Instructions – The safety and operating instructions should be retained for future reference.
3. Heed Warnings – Adhere to all warnings on the appliance and in the operating instructions.
4. Follow Instructions – All operating and use instructions should be followed.
5. Water and Moisture – The appliance should not be used near water - for example, near a bathtub, washbowl, kitchen sink, laundry tub, in a wet basement, or near a swimming pool, etc.
6. Carts and Stands – The appliance should be used only with a cart or stand that is recommended by the manufacturer.
7. An appliance and cart combination should be moved with care. Quick stops, excessive force, and uneven surfaces may cause the appliance and cart combination to overturn.
8. Wall or Ceiling Mounting – The appliance should be mounted to a wall or ceiling only as recommended by the manufacturer.
9. Ventilation – The appliance should be situated so that its location or position does not interfere with its proper ventilation. For example, the appliance should not be situated on a bed, sofa, rug or similar surface that may block the ventilation openings; or placed in a built-in installation, such as a bookcase or cabinet that may impede the flow of air through the ventilation openings.



10. Heat – The appliance should be situated away from heat sources such as radiators, heat registers, stoves, or other appliance (including amplifier) which produce heat.
11. Power Sources – The appliance should be connected to a power supply only of the type described in the operating instructions or as marked on the appliance.
12. Grounding or Polarization – Precautions should be taken so that the grounding or polarization means of an appliance is not defeated.
13. Power-Cord Protection – Power-supply cords should be routed so that they are not likely to be walked on or pinched by items placed upon or against them, paying particular attention to cords at plugs, convenience receptacles, and the point where they exit from the appliance.
14. Cleaning – The appliance should be cleaned only as recommended away from power lines.
15. Power-Lines – An outdoor antenna should be located away from power lines.
16. Outdoor Antenna Grounding – If an outside antenna is connected to the receiver, be sure the antenna system is grounded so as to provide some protection against voltage surges and built-up static charges. Article 810 of the National Electrical Code, ANSI/NFPA 70, provides information with regard to proper grounding of the mast and supporting structure, grounding of the lead-in wire to an antenna-discharge unit, size of grounding conductors, location of antenna-discharge unit, connection to grounding electrodes, and requirements for the grounding electrode. See the next page.
17. Nonuse Periods – The power Cord of the appliance should be unplugged from the outlet when left unused for a long period of time.
18. Object and Liquid Entry – Care should be taken so that objects do not fall and liquids are not spilled into the enclosure through openings.

19. **Damage Requiring Service** – The appliance should be serviced by qualified service personnel when:
- A. The power-supply cord or the plug has been damaged; or,
 - B. Objects have been fallen, or liquid has been spilled into the appliance; or,
 - C. The appliance has been exposed to rain; or,
 - D. The appliance does not appear to operate normally or exhibits a marked change in performance; or,
 - E. The appliance has been dropped, or the enclosure damaged.
20. **Servicing** – The user should not attempt to service the appliance beyond that described in the operating instruction. All other servicing should be referred to qualified service personnel.

Caring for the Exterior Panels

Caring for the exterior panels of the unit should be limited to wiping with a soft dry cloth. Avoid using solvents or alcohol-based cleaners.

Note to CATV system installer

This reminder is provided to call the CATV system installer's attention to Article 820-40 of the NEC that provides guidelines for proper grounding and, in particular, specifies that the cable ground shall be connected to the grounding system of the building, as close to the point of cable entry as practical.

EXAMPLE OF ANTENNA GROUNDING ACCORDING TO NATIONAL ELECTRICAL CODE

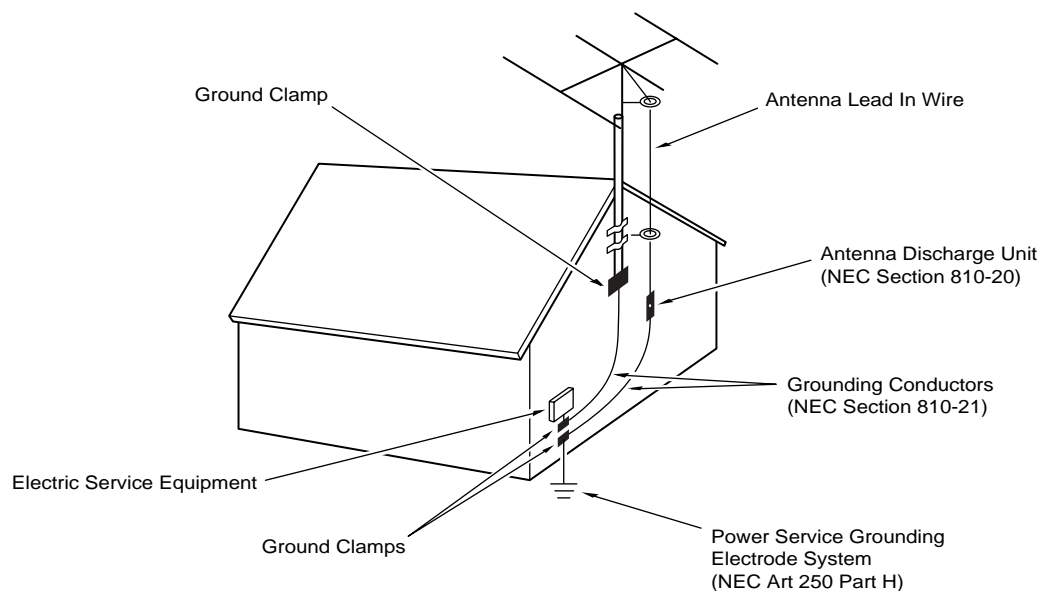

NEC – National Electrical Code

Usage Precautions

About the batteries

- Do not charge the batteries. Attempting to charge regular (non-rechargeable) batteries may cause fluid leakage or cause the batteries to explode, involving the risk of fire and injury.
- When inserting the batteries in the remote control, pay attention to proper +/- polarity as indicated in the battery compartment. Inserting batteries with wrong polarity may cause fluid leakage or cause the batteries to explode, involving the risk of fire, injury, or contamination.
- Do not use batteries other than indicated in this manual. Do not use a mixture of old and new batteries. Failure to observe this precaution may cause fluid leakage or cause the batteries to explode, involving the risk of fire, injury, or contamination.
- Do not expose batteries to heat or try to dismantle them. Do not throw batteries into fire or water. Failure to observe this precaution may cause fluid leakage or cause the batteries to explode, involving the risk of fire, injury, or contamination.
- Remove the batteries when not using the unit for a long time. Failure to observe this precaution may cause fluid leakage or cause the batteries to explode, involving the risk of fire, injury, or contamination. If fluid leakage has occurred, carefully wipe all fluid off the battery compartment and insert new batteries. If battery fluid has come into contact with skin, immediately wash thoroughly with water.

About Remote Control

Do not expose the remote control to direct sunlight or high temperatures. Failure to observe this precaution may cause deformation of the case.

.....

Cleaning

Clean the unit only by wiping it with a soft cloth. Never use any solvents, cleaning alcohol or chemical cleaners, since these may damage the finish and labelling, and lead to discoloration and deformation.

.....

Packing material

We recommend that you retain the shipping carton and packing material of the unit, since these will be useful for renewed transport.

.....

Transportation

Before moving or transporting the unit, be sure to remove all CDs to prevent the possibility of damage.

.....

Other precautions

- Do not place an amplifier, television, or other heavy object on the unit. Otherwise deformation and breakdown may occur.
- Protect the unit from shocks and vibration. Shocks or strong vibrations during CD playback may cause damage to the discs.
- To avoid the possibility of hum interference, this unit should not be placed in close vicinity to other components.
- A sudden increase in the ambient temperature can cause moisture to condense on the optical lens of the laser pickup, making correct playback impossible. Condensation can be removed by turning on the power to the unit and letting it warm up for about 30 minutes to 1 hour.

On CDs

Be sure to observe the following points concerning CD use in order to avoid CD damage, jams, sound skipping, and breakdown.

- Do not insert the 8-cm (3-inch) CDs (CD Singles).
- Do not insert discs which are not round, such as novelty discs with octagonal or heart shape.
- Do not use any commercially available CD accessories (such as adapters for 3-inch CDs, disc stabilizers, disc protectors, cleaning discs etc.).
- Use only discs with a  mark or similar, which indicates compliance with official Compact Disc standards.
- Some CDs may have a certain amount of flash (flaky plastic deposit resulting from the grinding process) near the center hole or the outer circumference. Remove any such remnants before using the disc, otherwise it may not be possible to eject the CD properly, or skipping may occur.
- CDs bearing labels or stickers with excess glue around the edges or CDs with glue residue from removed adhesive tape, stickers or similar may give problem during eject or cause other damage.
- Recordable CDs (CD-R) recorded on certain recorders cannot be played back with this unit.

Inserting the batteries

Removing the battery compartment cover (Main remote control)

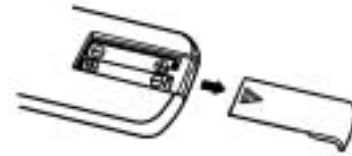

Removing the battery compartment cover (Sub remote control)

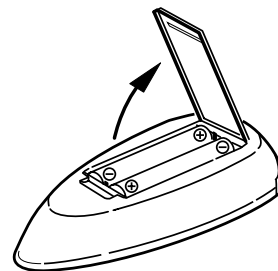

1. Remove the cover of the battery compartment on the rear of the remote control.
2. Insert the supplied two IEC R03 (size AAA) batteries into the compartment, with the polarity as shown.
3. Close the cover of the battery compartment.

External View

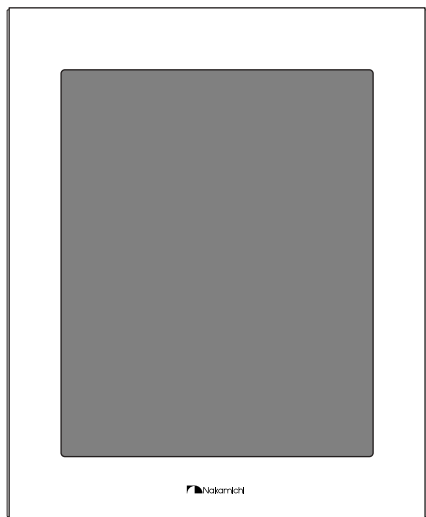

Speaker Unit (Front)

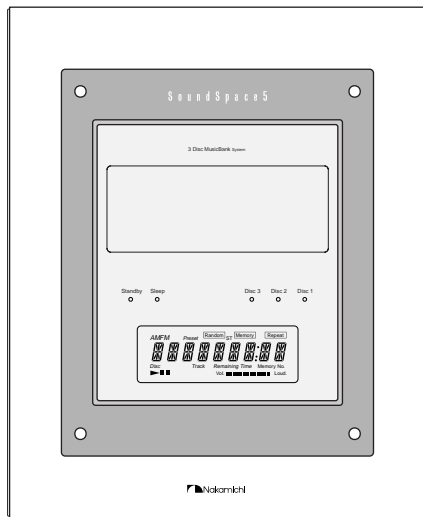

Main Unit (Front)

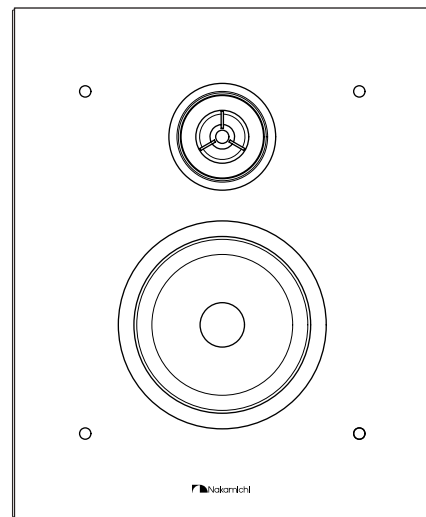

Speaker Unit (Front)
(With speaker grill removed)

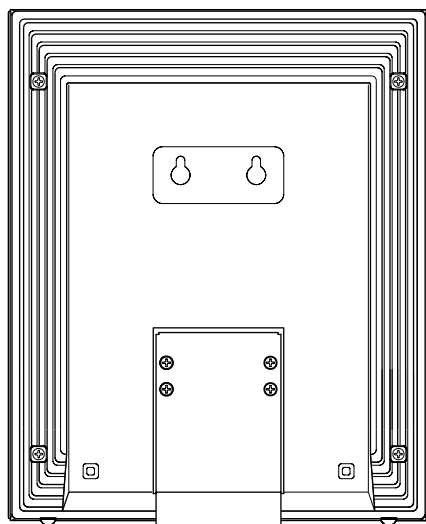

Speaker Unit (Rear)

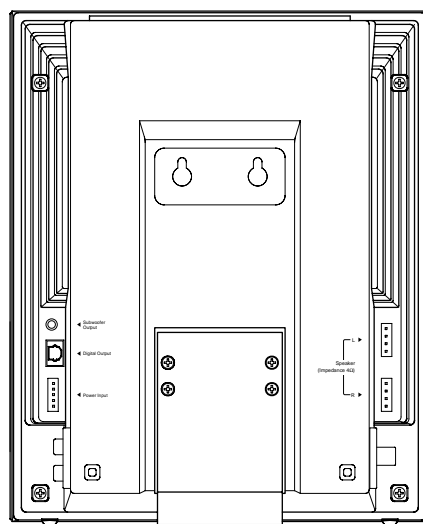

Main Unit (Rear)

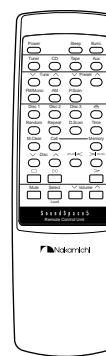

Main Remote Control



Sub Remote Control

Installation

Decide the installation locations for the main unit and the left and right speaker units before making the connections. Place each unit on furniture or the like or hang it from the wall.

Changing the speaker grill

In addition to the standard speaker grills (gray), the speakers for this system come with navy blue/green grills. The speaker grill is removed by just pulling it forward, so use the grill that best matches the atmosphere of the installation location.

Using placed on furniture

1. Paste two each of the accessory rubber feet on the bottom of the main unit, left speaker, and right speaker (total six rubber feet).
2. Pull out the main unit and speaker unit rear stays all the way out and install each unit tilted.

CAUTION

When using this system placed on some furniture, always install with the stays pulled all the way out. If you install these units with the stay not pulled out or only pulled out part way, they may fall over.

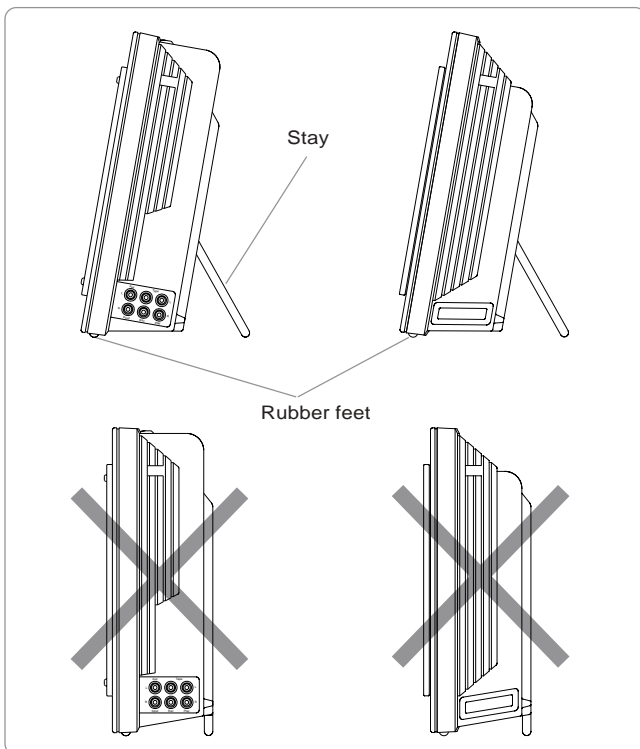

Installing on wall

You can use the main unit and speaker units fastened to a wall with the accessory screws. (When fastening to a concrete wall or other non-wooden wall, please use any commonly available screw designed for the specific wall material.)

CAUTION

When using the main unit and speaker units fastened to a wall, check that the units are close enough to each other for connection before installing them to the wall.

1. Use a drill or the like to drill 3-3.5φ diameter holes (two for each unit) on the installation surface.
2. Screw the accessory tapping screws for wall installation into the wall.
3. Hang the main unit and speaker units with their rear installation holes hanging on the screws you installed into the wall.

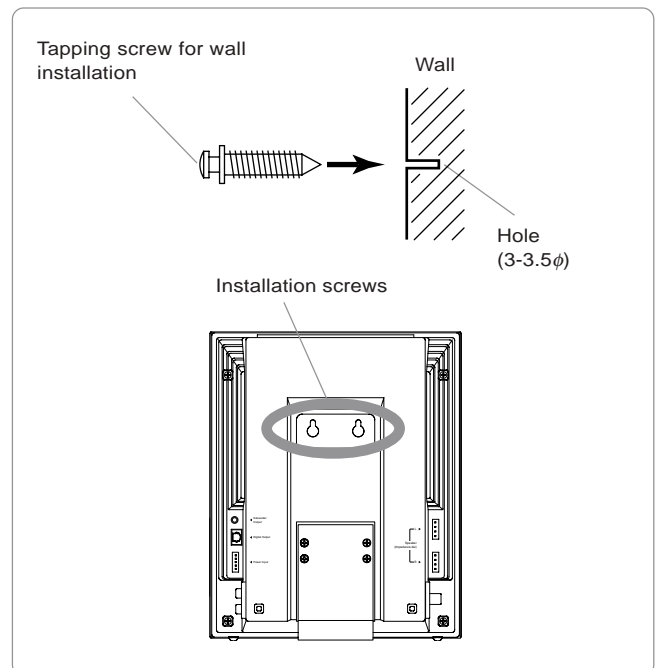

Connections

Notes

- Be sure to disconnect the power cords for this system and all other audio equipments from the AC outlets before making connections.
- Never insert shorting pins, pin cords, or the like on unused terminals. The system may cease to put out sound or shorts could cause breakdown.
- The white terminal on this system is the left channel audio terminal and the red terminal is the right channel audio terminal.

System Connections

1. Connect the cables from the rear of the speaker units to the left and right Speaker terminals on the rear of the main unit.
2. Connect the 5-pin connector for the power supply unit to the Power Input terminal of the main unit.
3. Connect the AM antenna and FM antenna. (Page 11-12.)
4. Connect the source equipment. (Page 13.)
5. When all the equipment has been connected, connect the power cable to the power supply unit and plug the power cable into a receptacle.

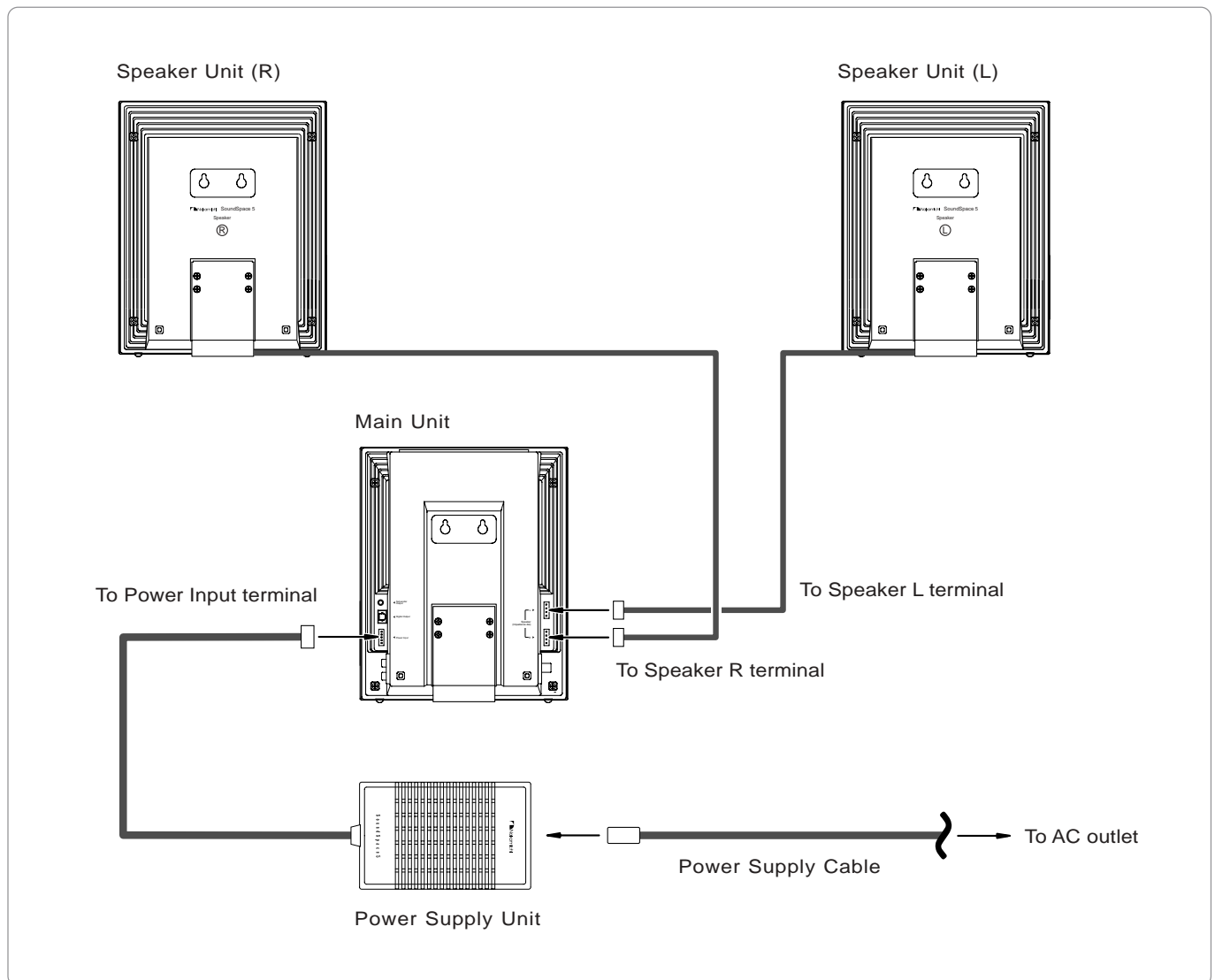

AM antenna connection

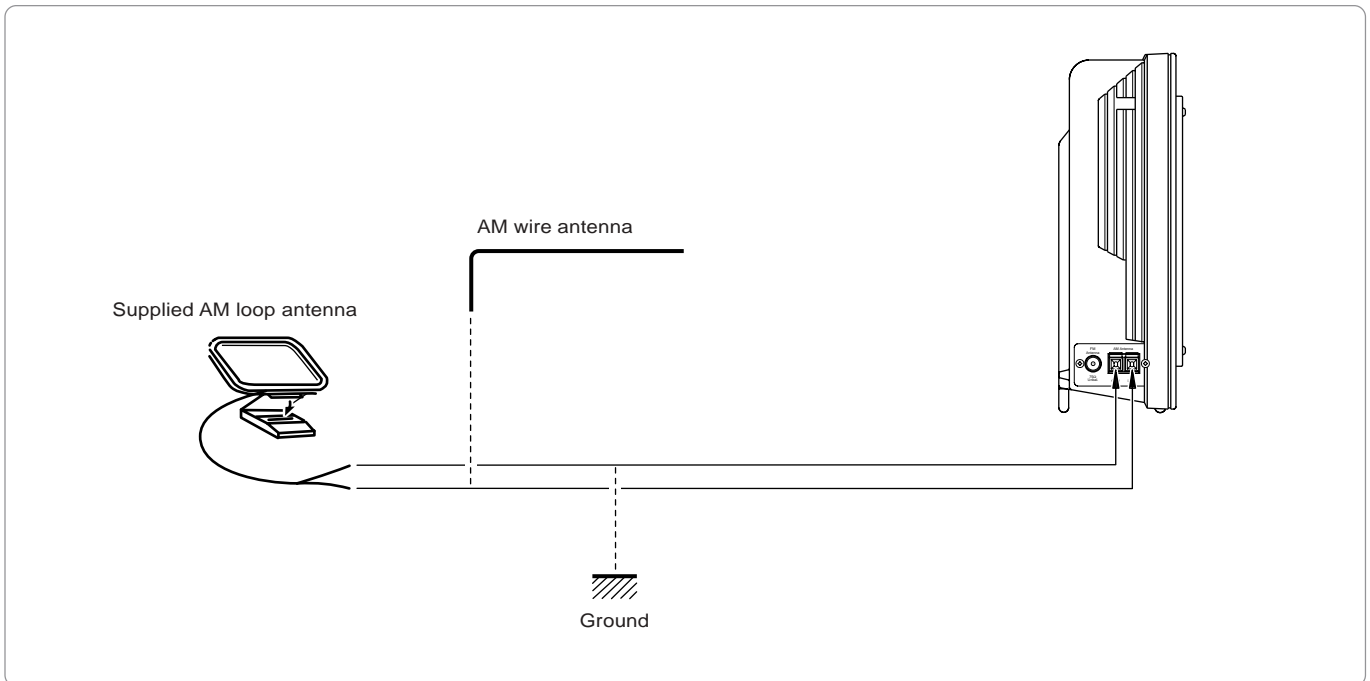

1. Assemble the supplied AM loop antenna.
2. Connect the loop antenna lead to the AM Antenna terminal.
3. Move the loop antenna around and install it in the location with optimum reception sensitivity.
 - If reception condition with the supplied AM loop antenna are not satisfactory, extend an antenna wire (ordinary vinyl-coated lead wire) about 4 to 5 meters outdoors and connect the end of the wire to the AM antenna terminal marked "AM". The loop antenna should remain connected also when using an outdoor antenna.

CAUTION

If an outdoor AM antenna is used, grounding must be provided for protection against lightning.

Establishing a ground connection

1. Provide a single-conductor wire (ordinary vinyl-coated lead wire) and connect one end of the wire to the AM antenna terminal marked "GND".
2. Connect the other end of the wire to an earth ground, for example more than 50 cm length of exposed wire or a metal bar buried in the ground, or a water pipe (lead pipe) with complete grounding.

CAUTION

Never connect the ground wire to a gas pipe to avoid explosion hazard in case of a lightning strike.

Stereo Music System

Connections

FM antenna connection

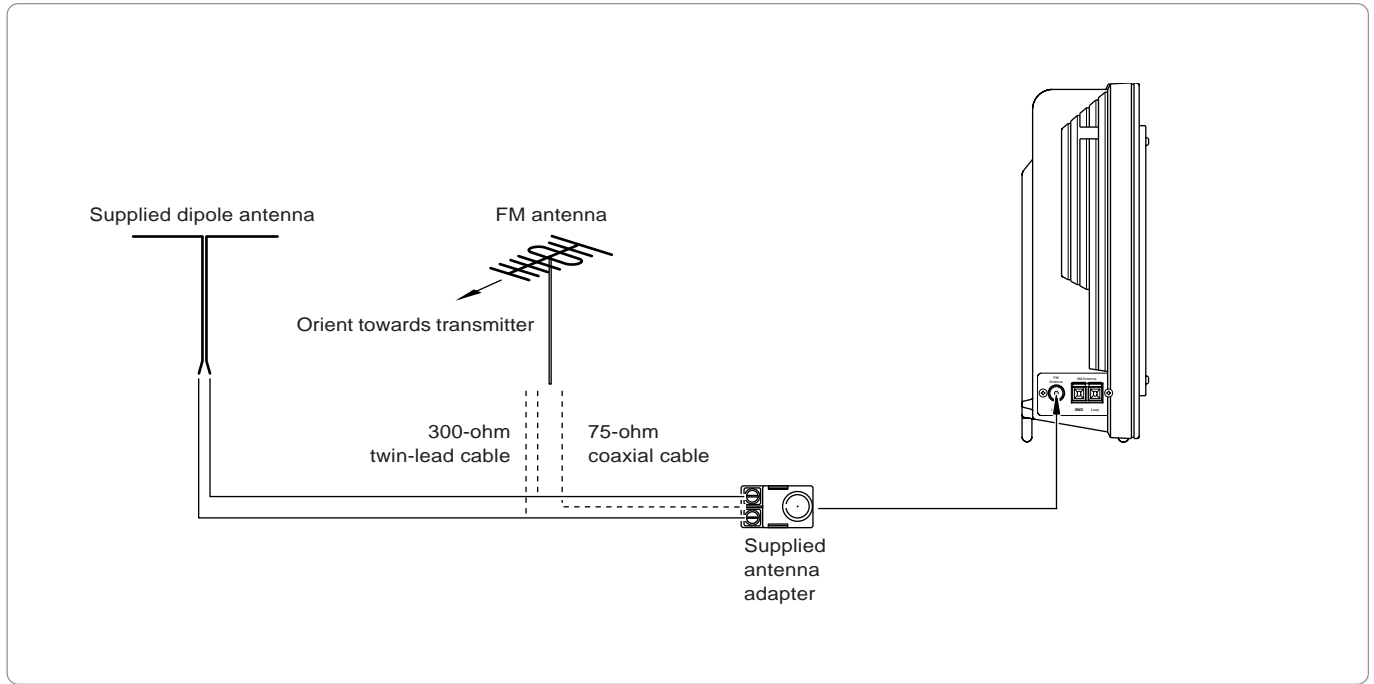

Areas in close proximity to strong stations

Extend the supplied 300-ohm twin-lead folded dipole and fix it to a wall or similar, in a position that yields best reception (highest number of signal strength indicators light up when receiving a desired station).

- Note that gain and directivity of the dipole antenna are low. Often multipath (reflections of broadcast signals by nearby buildings etc.) will occur, which degrades sound quality. Also, heavy traffic, railroads, or high-voltage power lines in the vicinity of the reception location may cause noise interference. Installation of a 3-element outdoor FM antenna is recommended in such cases.

Fringe areas in considerable distance from stations, or urban areas with numerous high-rise buildings

Use an outdoor FM antenna with 5 to 8 elements.

Areas with many noise or interference sources

Use shielded coaxial cable (5C-2V or 3C-2V) for the antenna connection.

- A long antenna cable introduces signal loss and is prone to externally induced noise. For optimum performance, you should keep the connection as short as possible.

Connecting source equipment

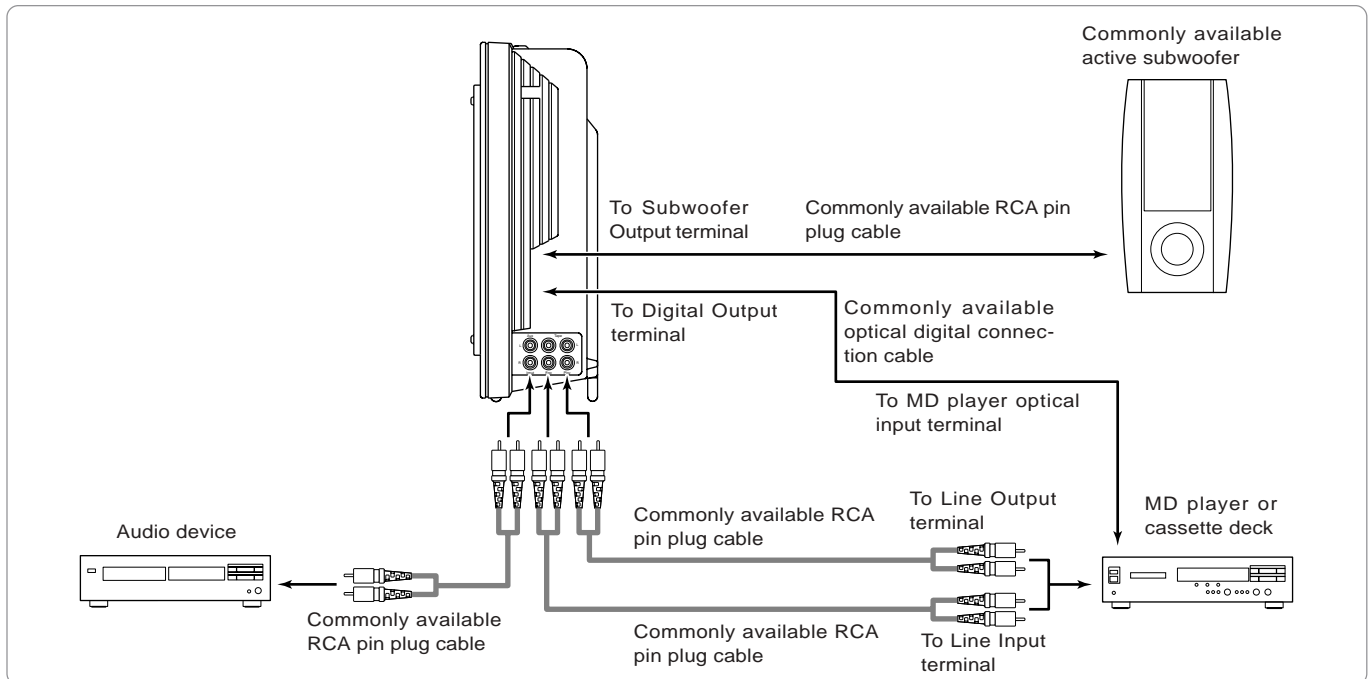

There are terminals for connecting source equipment on the right and the rear of the main unit.

- Always unplug all power cords from the receptacles before connecting any equipment.
- The white terminals on this unit are the left channel audio terminals and the red terminals are the right channel audio terminals.

Connecting an MD player

- When connecting an MD player that has digital input terminals, you can use any commonly available optic digital connection cable to record digitally from a CD to an MD.
- When connecting an MD player whose line input/output terminals are stereo mini-jacks to the main unit, use any commonly available RCA/stereo mini-plug conversion cable.

Basic Operation

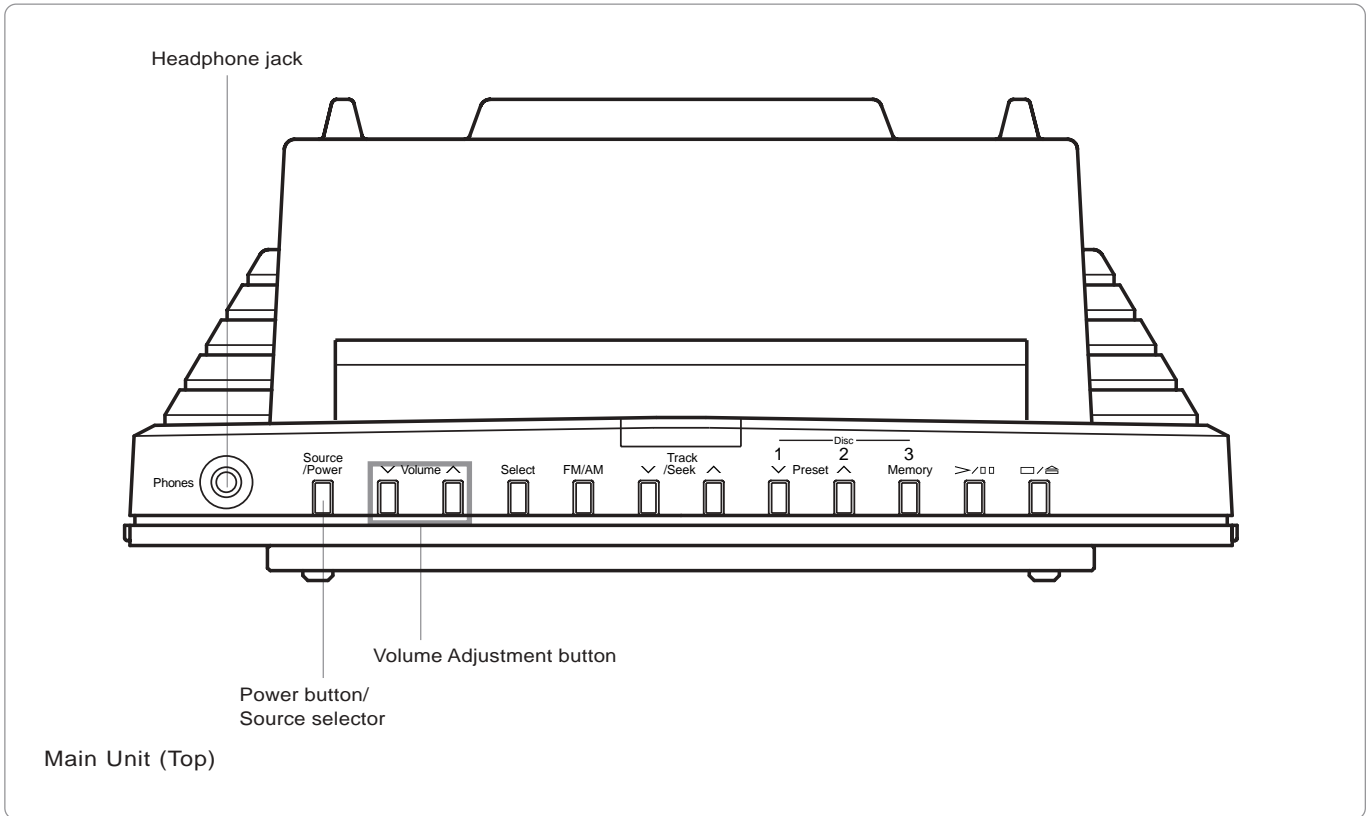

Power on

Pressing the Power button switches on the power.

- Pressing the Source selector on the main remote control will activate the unit in the desired source.
- When you press the Band selector the power is switched on in tuner mode; when you press the Play button, the power is switched on in CD mode.

Power off

Pressing the Power button on the main remote control switches off the power. The Standby indicator lights up.

- To switch off the power with the main unit/sub remote control, press and hold down the Power button on the main unit/sub remote control (for at least about 1 second).
- When you switch the power back on again after switching it off, the power comes on with the same source as when it went off.

CAUTION

Even when the power is switched off, power is supplied to some of the circuits in this system. When you will be leaving the system unused for a long time, for example when going away on a trip, be sure to unplug the power plug from the AC outlet.

Volume adjustment

You can adjust the volume with the Volume Adjustment buttons (/). You can adjust the volume at high speed by pressing and holding down a Volume Adjustment button.

Source selection

You can select the source with the Source selector.

- The main remote control can select the source directly.
- For the main unit and sub remote control, each time you press the Source selector, the system switches to the next source in the sequence: Tuner → CD → Tape → AUX (external input) → Tuner....

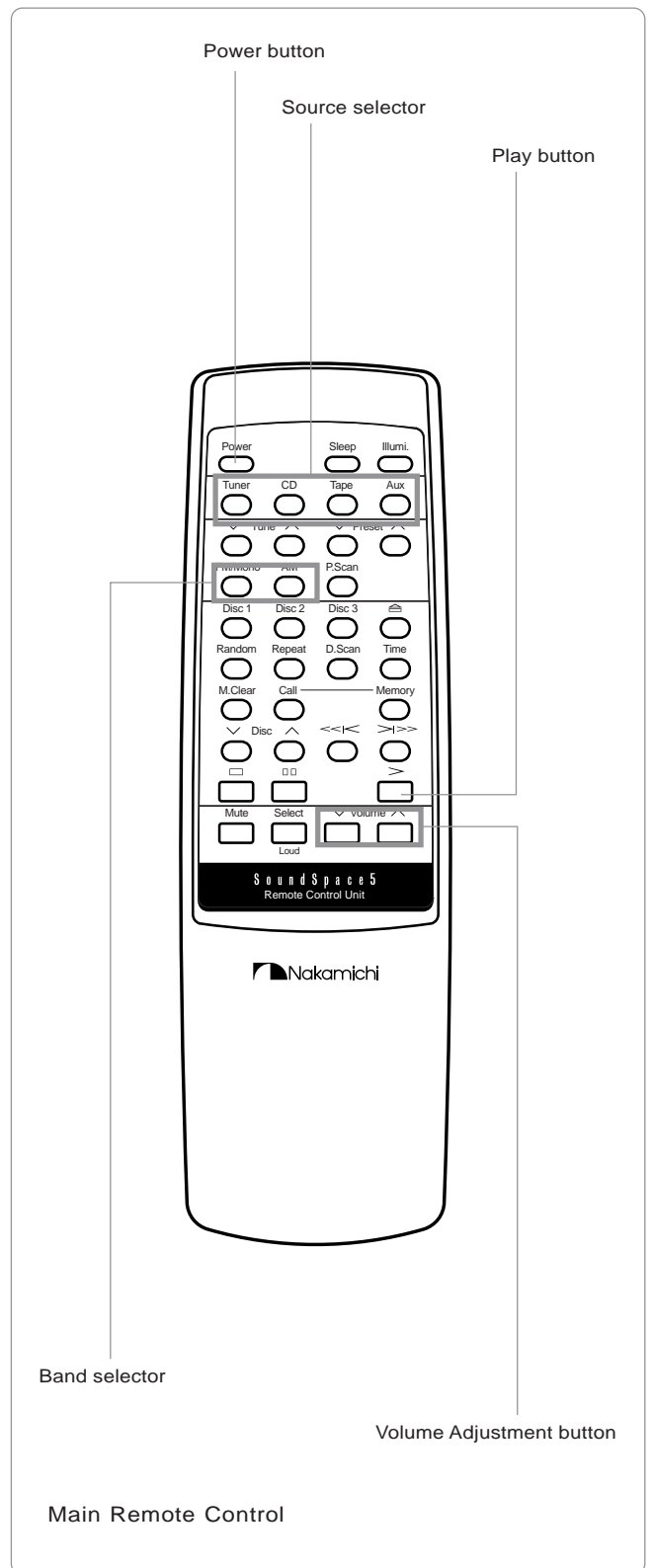
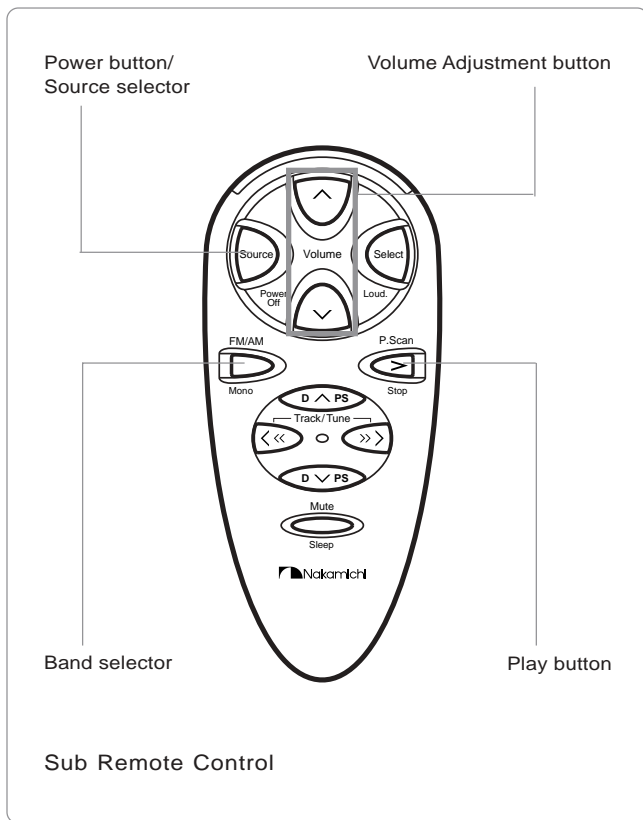

Using headphones

Connect the headphones to the headphone jack on the main unit.

CAUTION

When using headphones, be careful not to raise the volume too high. Listening for prolonged periods at volumes so high that they irritate the ears can harm your hearing.

CD Playback (Basic)

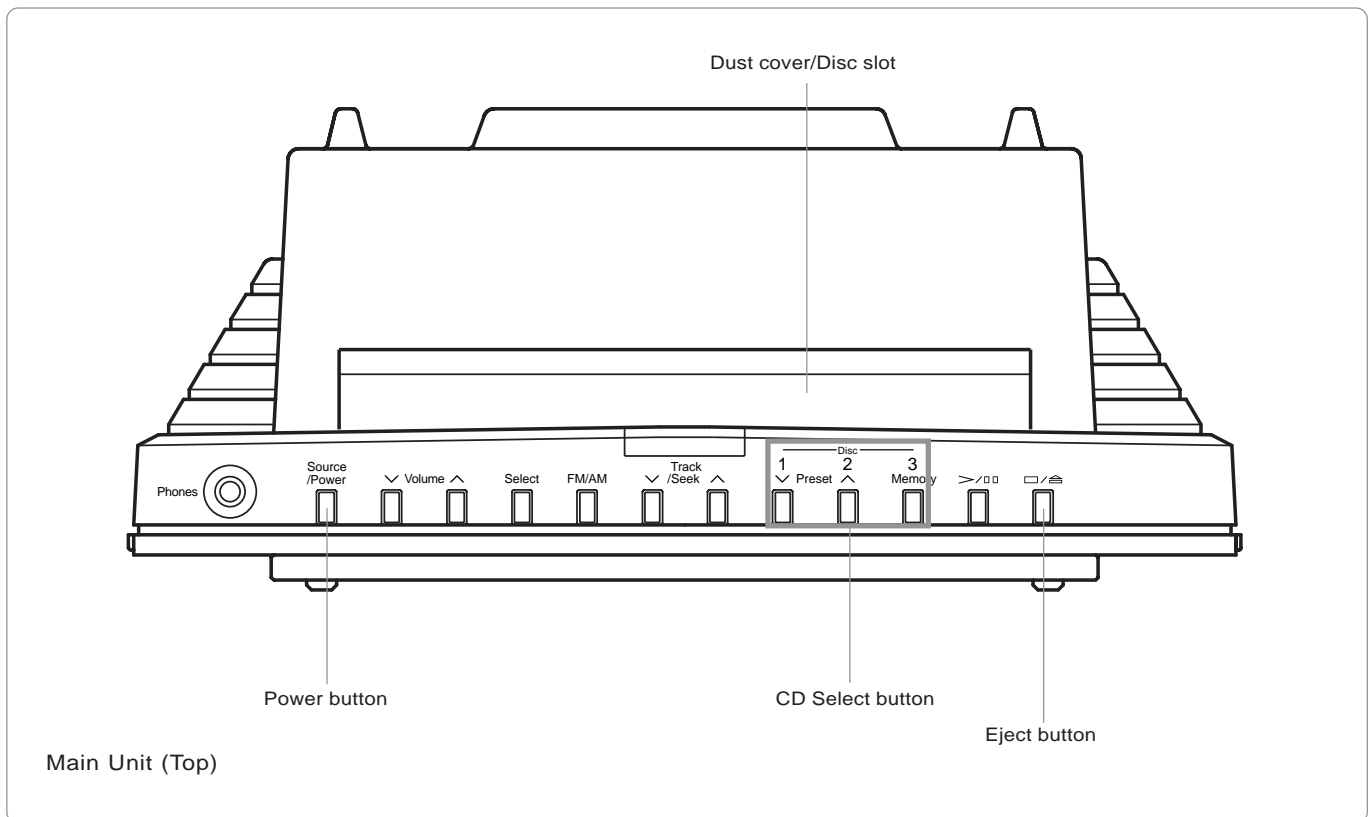

Loading the CD

Before loading the CD, press the Power button to switch on the power.

1. Press the CD Select button and select the disc number in which you wish to load the CD. (You cannot select a disc number in which no CD is loaded for CD playback. Stop playback before selecting a disc number.)
2. Press the Eject button to open the Dust cover.

CAUTION

Do not open the Dust cover by hand.

3. Gently place the disc in the Disc slot with the label side of the CD facing you. (The CD is automatically taken in, the Dust cover closes, and the Disc indicator lights.)

CAUTION

- Do not insert the 8-cm (3-inch) CDs (CD Singles).
- Do not insert discs which are not round, such as novelty discs with octagonal or heart shape.
- Do not use any commercially available CD accessories (such as adapters for 3-inch CDs, disc stabilizers, disc protectors, cleaning discs etc.).

Ejecting a CD

Before ejecting a CD, press the Power button to switch the power on. If you were playing back a CD, stop playback before ejecting the CD.

1. Press the CD Select button, then select the number of the disc that you wish to take out.
2. When you press the Eject button, the Dust cover opens and the CD is ejected.
3. Remove the CD.
4. Repeat Steps 1-3.
5. When you finish removing CDs, press the Eject button. (The Dust cover closes.)

CAUTION

Do not close the Dust cover by hand.

Disc indicator display

The display on the Disc indicator changes as follows according to CD player operation and state.

- Green: CD loaded
- Off: No CD loaded

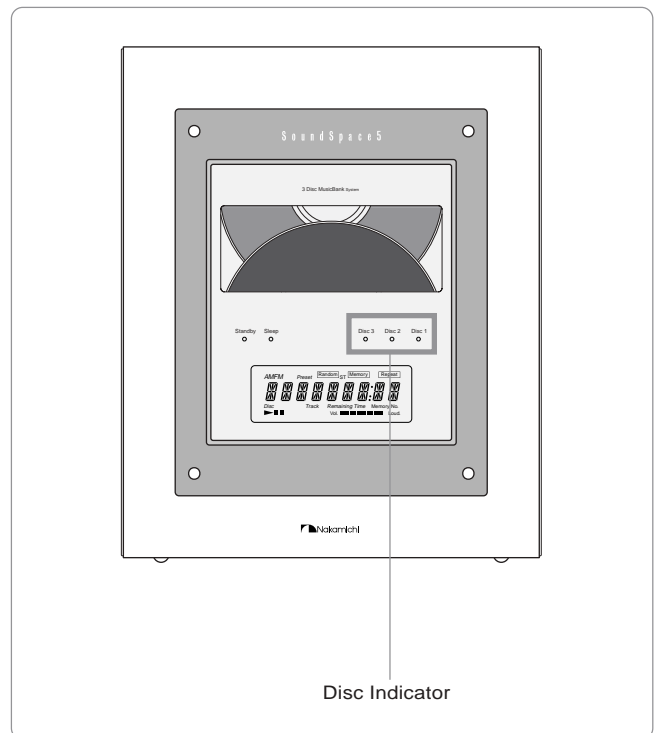

Stereo Music System

CD Playback (Basic)

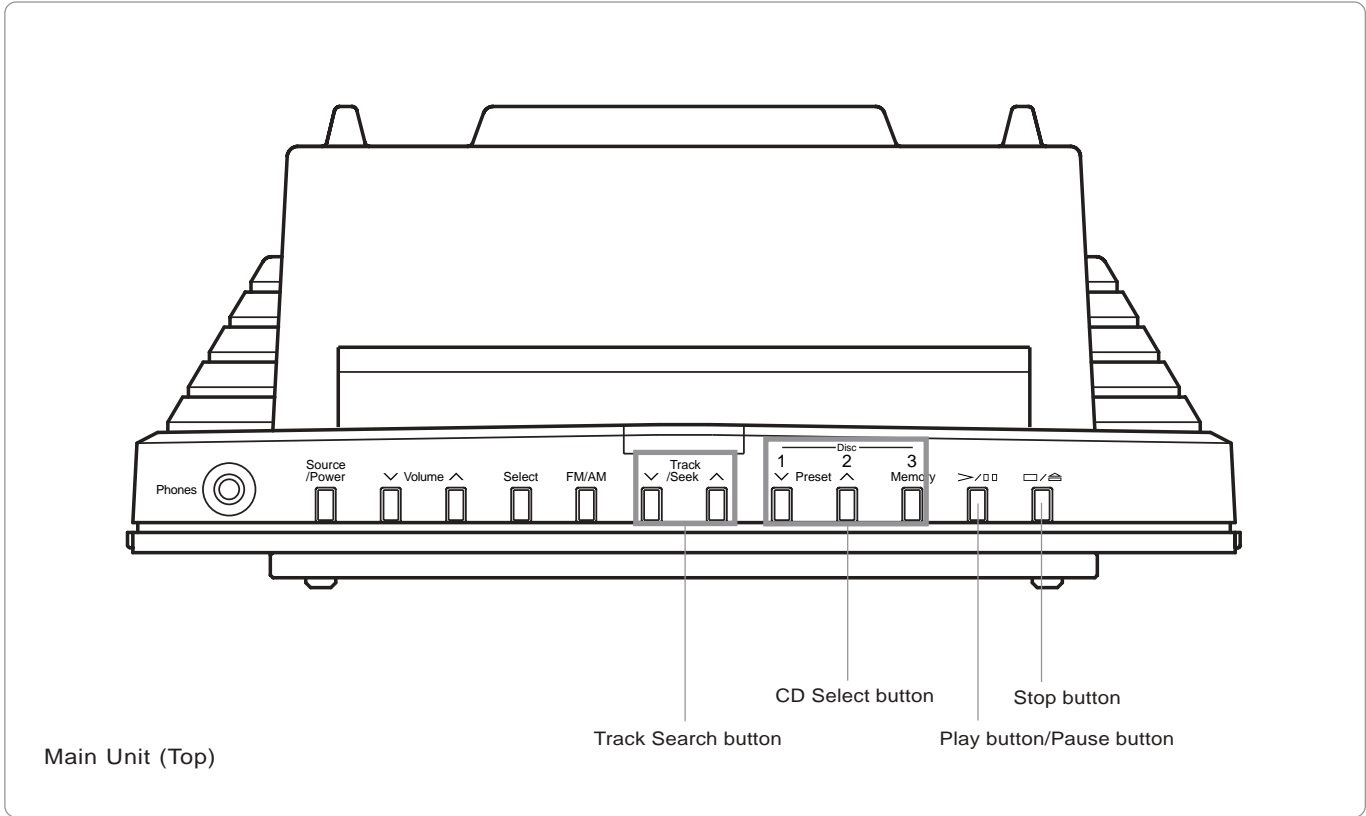

Playing back a CD

1. Select the CD you wish to listen to with the CD Select button. (The selected disc number is displayed.)
2. Press the Play button.
 - If the contents of memory have not been erased, the system goes into memory play and normal playback is not possible.
 - The disc number, the track number, and the playing time are displayed. With each push of the Time button on the main remote control, the display cycles through the following modes.
 - Service mode is displayed for about 10 seconds, then the system automatically returns to time mode.

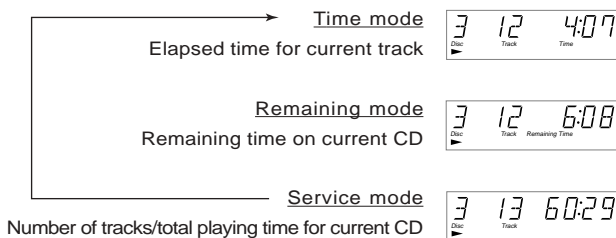

CD playback stop

- Press the Stop button.
- To stop playback with the sub remote control, press and hold down the sub remote control Stop button (for at least about 1 second.)

CD playback pause

- Press the Pause button.
- With playback paused, pressing the Play button resumes play where it paused.

Another CD playback

- With the CD Select button, select the disc number you want to play back.
- During CD playback, you cannot select a disc number for which no CD is loaded.

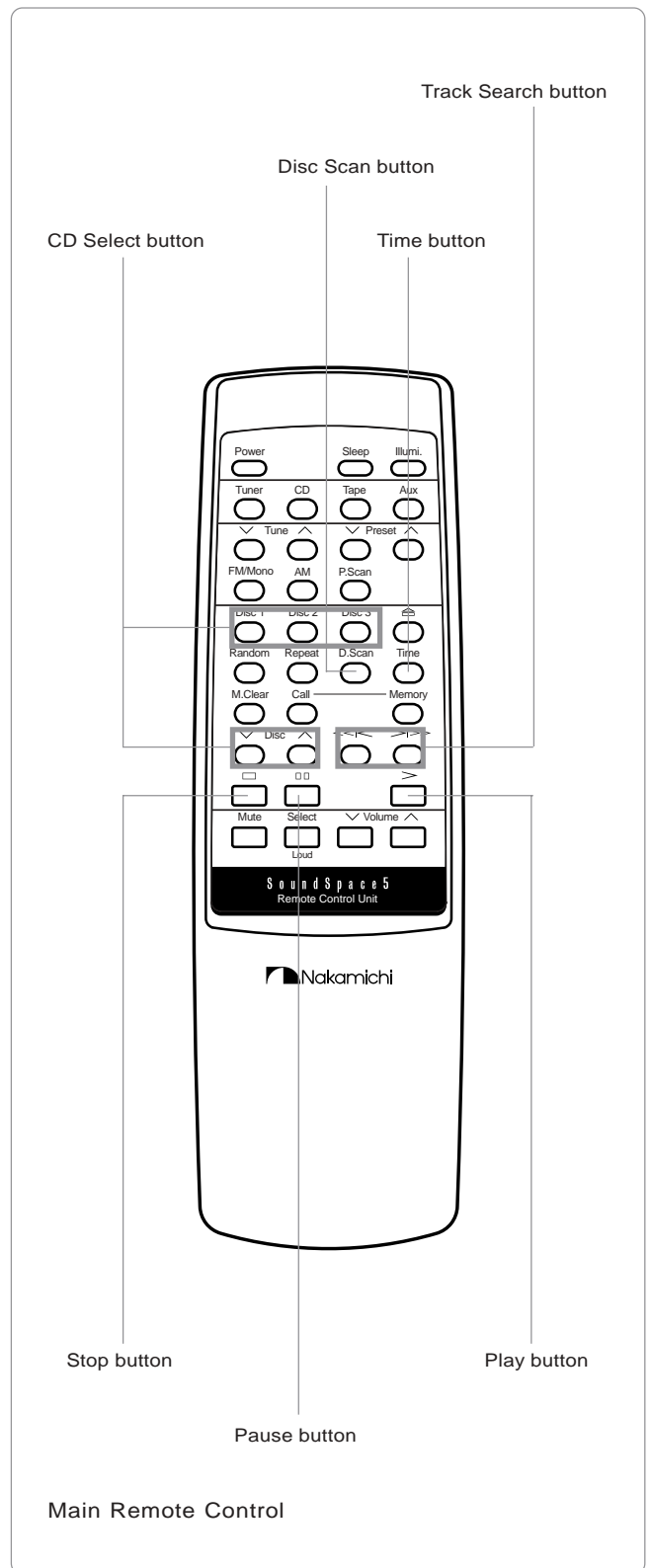
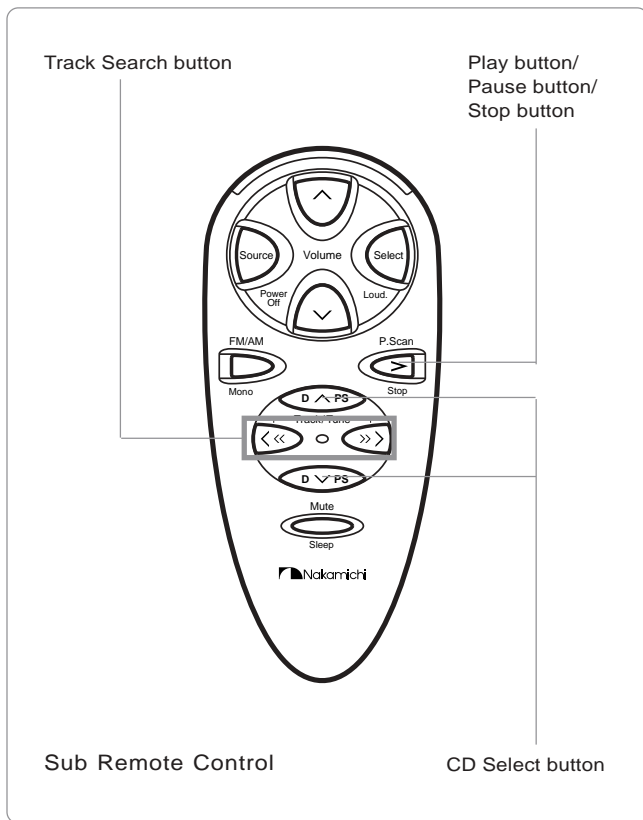

Another track playback

Select the track you want to listen to with the Track Search button.

Reverse cue/Forward cue

Press the Track Search button and hold it down (for at least about 1 second).

- Release the Track Search button to resume the playback.

Disc scan

If you press the Disc Scan button with CD playback stopped, the first approximately 8 seconds of the first track on each CD in the main unit is played back.

- When you find the disc you want, press the Disc Scan button again. That disc is played back normally.

CD Playback (Advanced)

Memory play

This unit can store up to 50 tracks in memory and play them back.

1. With the CD Select button, select the CD containing the track you wish to store into memory. (The selected disc number is displayed.)
2. With the Track Search button, select the track you want to store into memory. (The selected track number is displayed.)
3. Press the Memory button.
 - The Memory indicator and memory number are displayed.
 - When the memory number is being displayed, the total memory time is displayed while you hold down the Time button.
4. Repeat Steps 1-3 to store all the tracks you want into memory.
5. Press the Play button. (The tracks are played back in the order in which you stored them into memory.)

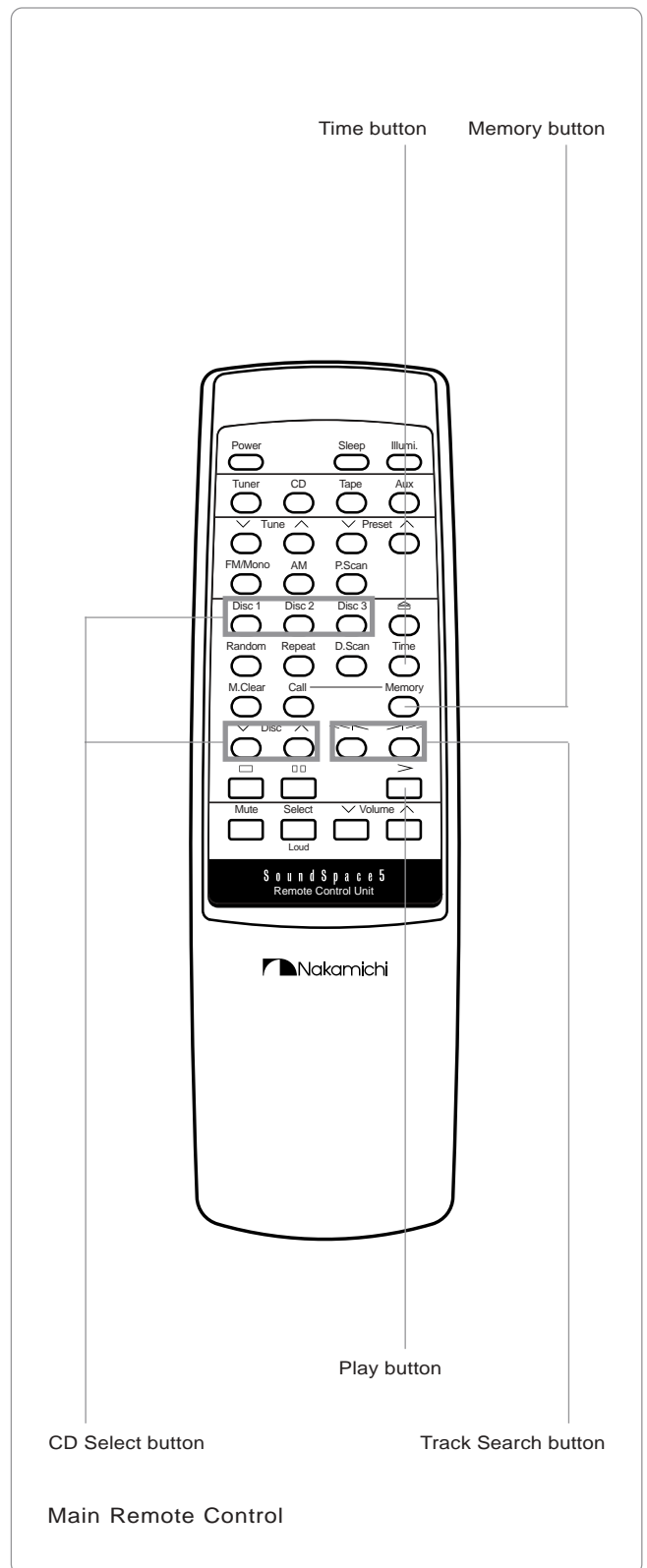

Check the contents of the program

With CD playback stopped, press the Memory Call button.

- Each time you press the Memory Call button, you can check the memory number, memory disc number, and memory track on the main unit display.
- When the memory number is displayed, the total time until then is displayed while the Time button is held down.

Change the contents of the memory number

Press the Memory Call button and display the memory number you wish to correct, then store the correct track into that memory location according to Steps 1-3 for memory play.

Clear the memory program

Press the Memory Clear button.

- The Memory indicator goes out.
- When you take out a CD, the contents of memory are automatically erased.
- If the contents of memory have not been erased, normal playback (Page 18), random play (Page 22), and all repeat play (Page 23) are not possible.

Checking the memory remaining time

During memory play, you can display the memory remaining time by pressing the Time button. To end this display, press the Time button until the display returns to time mode.

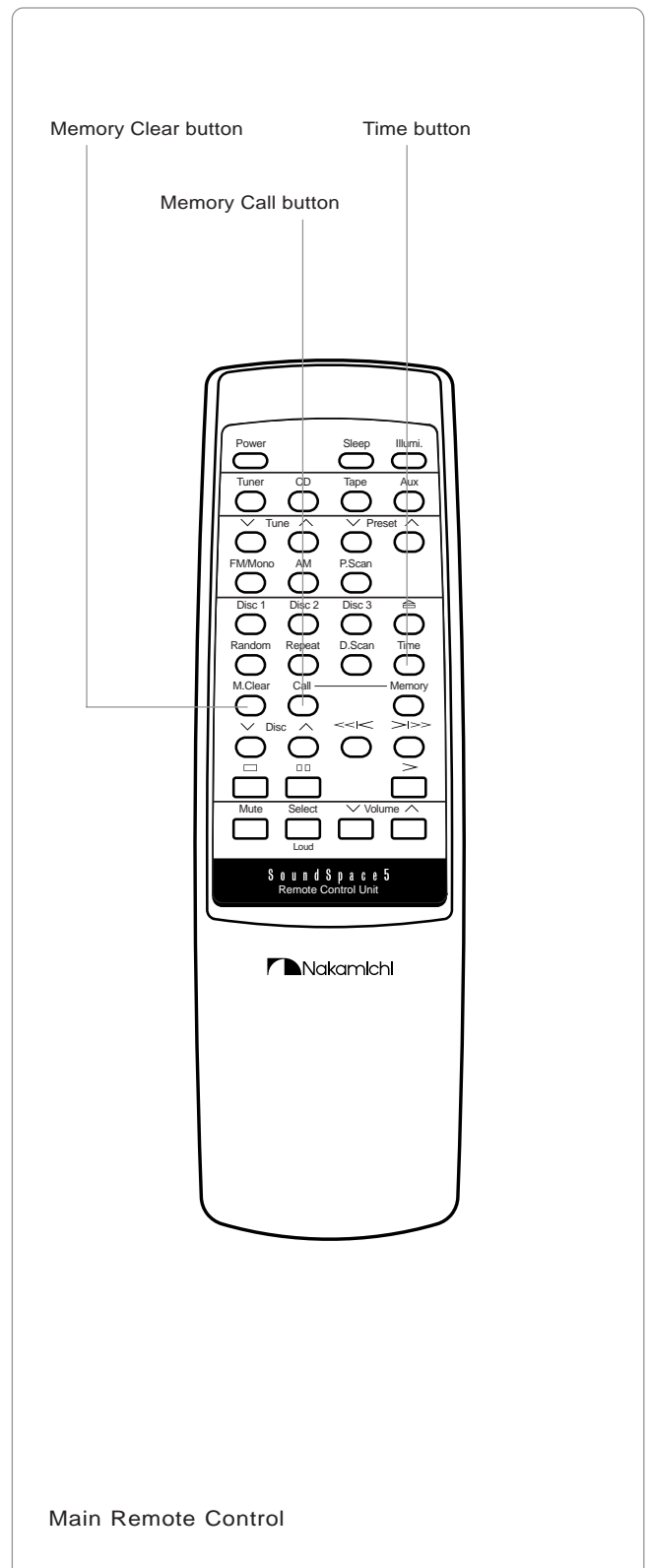

Stereo Music System

CD Playback (Advanced)

Random play

You can play back all tracks on all inserted CDs in random order.

1. Press the Stop button.
2. Press the Random button.
 - The Random indicator lights up on the display and random play starts.
 - Random play is not possible if the contents of memory have not been erased.
 - To stop random play, press the Stop button or switch the source.

Skip to the next track

If you press the Random button during random play, the rest of the current track is skipped over, the next track is selected randomly, and random play continues.

To cancel random play

Press the Stop button.

- The Random indicator on the display goes out.

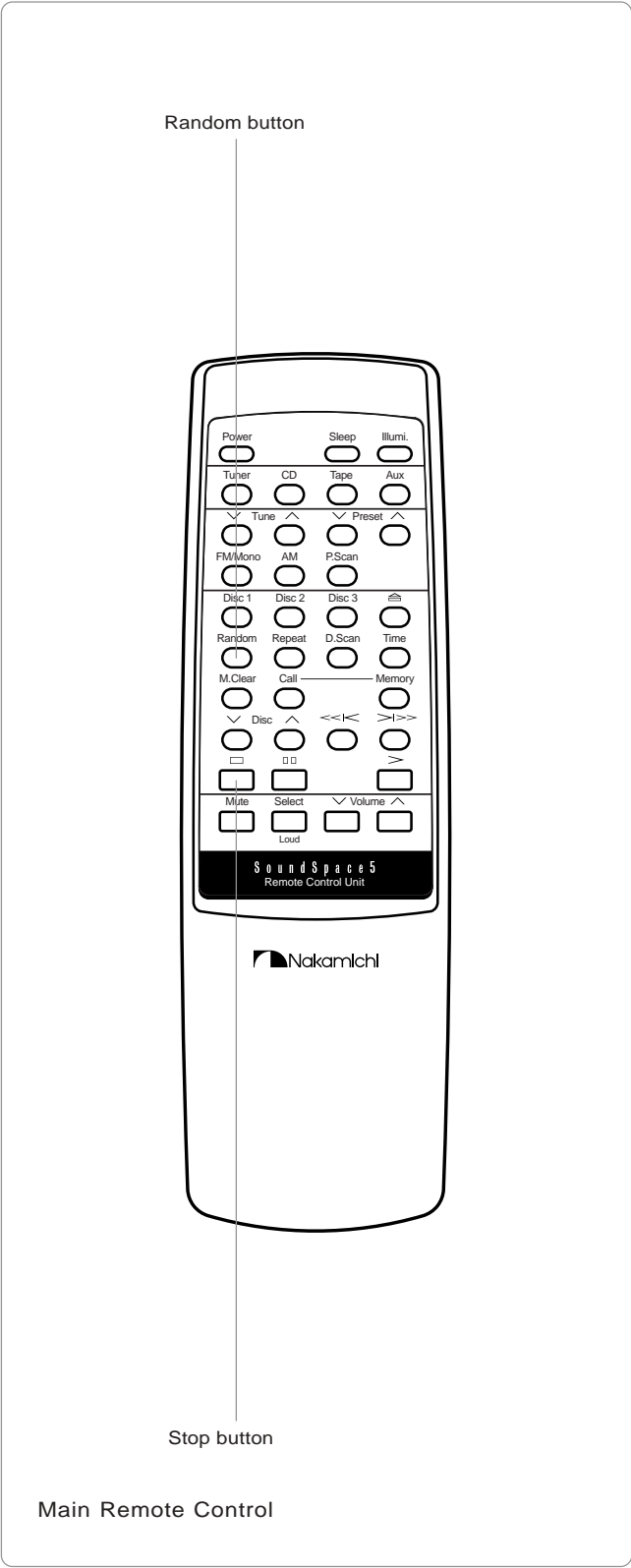

Track repeat play

The current track is played over and over.

1. Start normal playback (Page 18), memory play (Page 20), or random play (Page 22).
2. Press the Repeat button.
 - The Repeat indicator on the display lights up, the Track indicator flashes, and the current track is played back over and over.
3. To end repeat play, press the Repeat button.
 - The Repeat indicator on the display goes out and the Track indicator returns from flashing to being lit.

All repeat play

All the CDs loaded in this unit are played back over and over in order of disc number and track number.

1. Start normal playback (Page 18).
2. Press and hold down the Repeat button (for at least about 1 second).
 - The Repeat indicator lights up on the display and all repeat play starts.
3. To end all repeat play, press and hold down the Repeat button (for at least about 1 second).
 - The Repeat indicator on the display goes out.

Memory repeat play

The tracks already stored into memory are played back repeatedly.

1. Start memory play (Page 20).
2. Press and hold down the Repeat button (for at least about 1 second).
 - The Repeat indicator on the display lights up and memory repeat play starts.
3. To end memory repeat play, press and hold down the Repeat button (for at least about 1 second.)
 - The Repeat indicator on the display goes out.

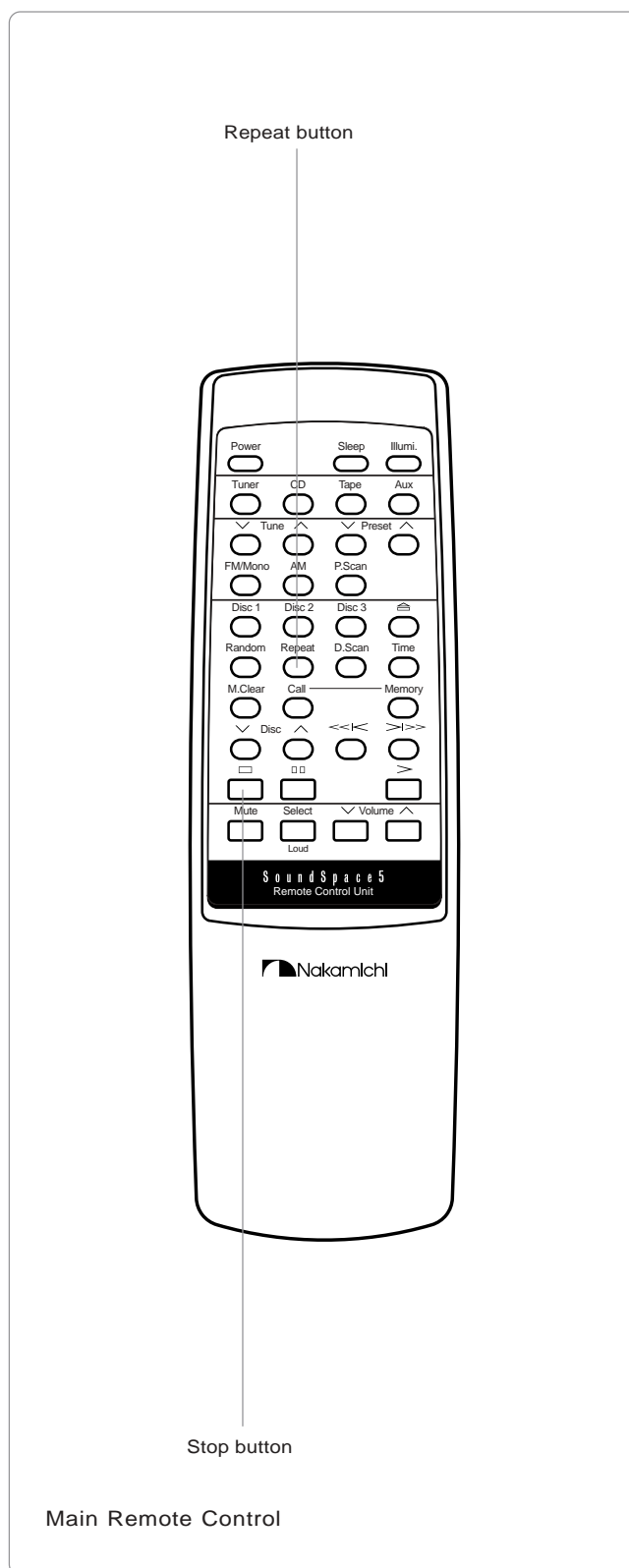

FM/AM Broadcast Reception

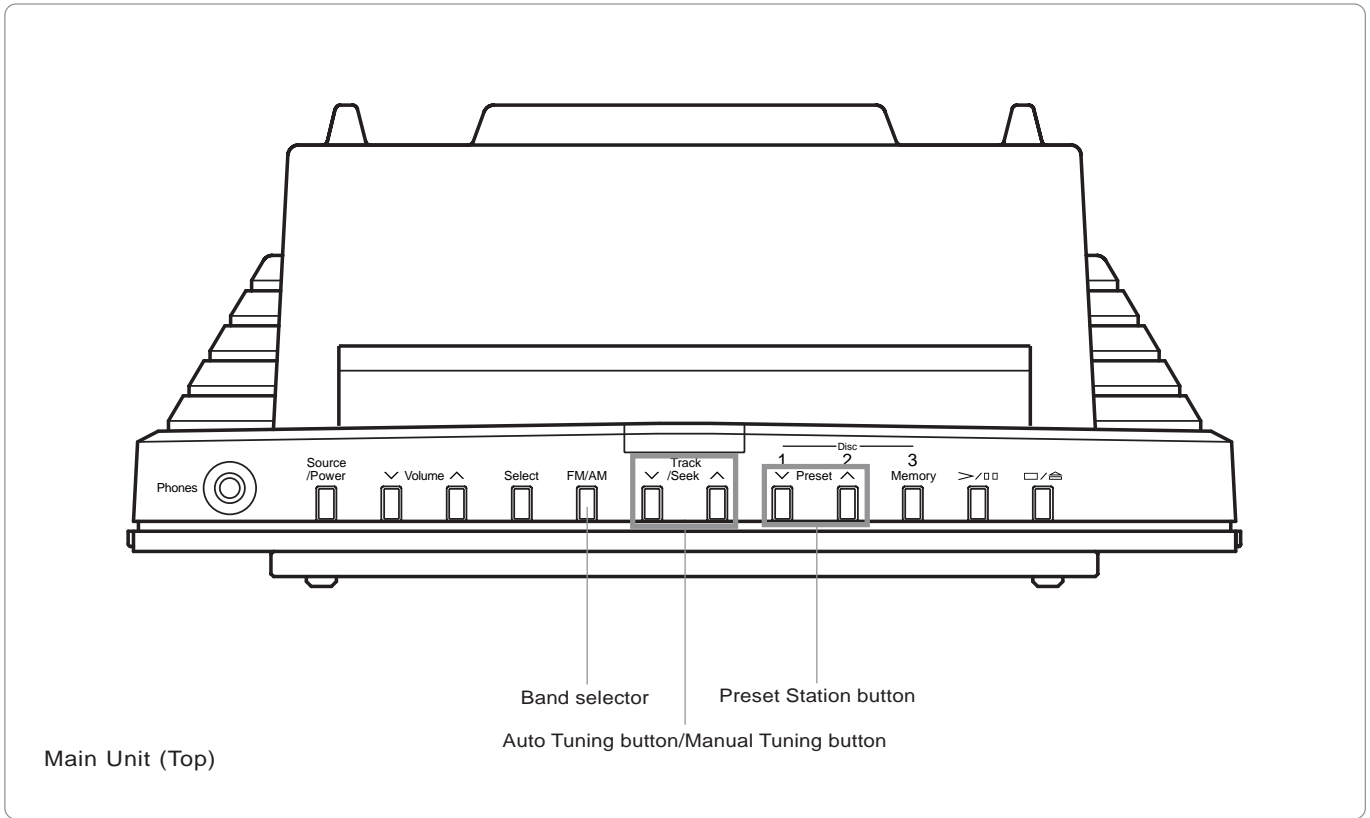

Automatic tuning

1. With the Band selector, select the desired frequency band.
2. Press and hold down the Auto Tuning button (for at least about 1 second) to start automatic tuning.
3. To continue automatic tuning, again press and hold down the Auto Tuning button (for at least about 1 second.)
 - When receiving a stereo broadcast, the ST indicator is displayed on the display.
 - Use manual tuning for stations that cannot be received with automatic tuning.

Manual tuning

1. Select the desired frequency band with the Band selector.
2. Use the Manual Tuning buttons to tune in the frequency of the station you wish to listen to.

Preset Memory

1. Use manual or automatic tuning to tune in the station you wish to preset.
2. When you press the Memory button on the main unit, the Memory indicator flashes. While the Memory indicator is flashing (about 5 seconds), select the desired preset number (1-5) with the preset station button (/).
3. Press the Memory button on the main unit again.
 - The Memory indicator on the display stops flashing and stays lit for a while. When it goes out, the memory process is complete.

Memory tuning

Select a preset station with the Preset Station buttons (/).

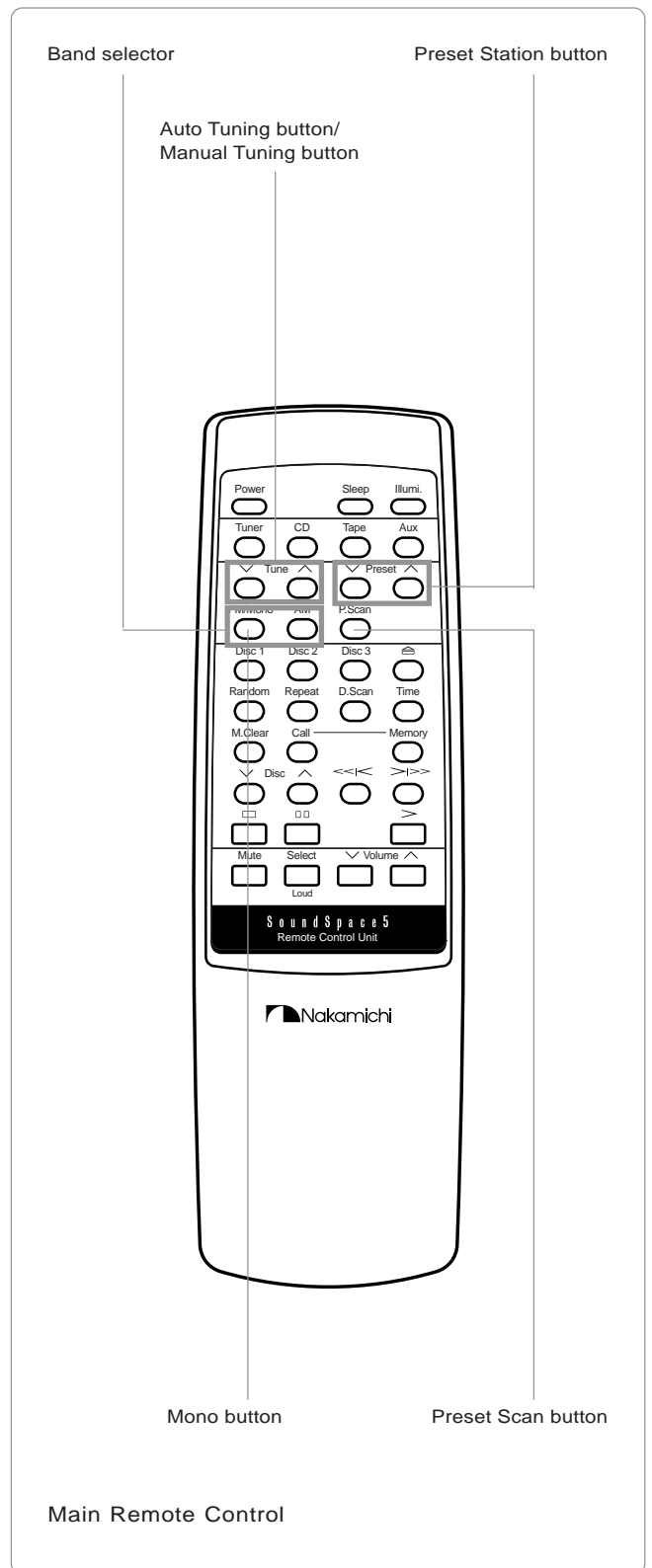
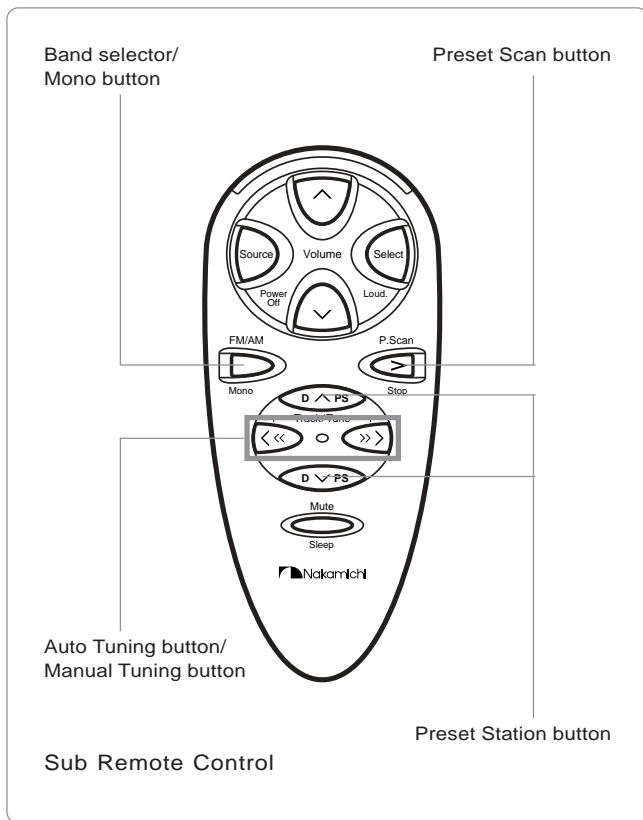

Preset scan

1. With the Band selector, select the desired frequency band (FM1, FM2, FM3, FM4, AM1, AM2).
2. Press the Preset Scan button.
 - All the stations stored in memory for the selected frequency band (FM or AM) are received for about 5 seconds each.
3. When you find the station you want, press the Preset Scan button again.
 - The preset scan stops and the selected station is received.

Stereo/mono switching

If the amount of noise in an FM broadcast you are listening to becomes bothersome, press and hold down the Mono button (for at least about 1 second) to put the unit into mono mode.

- The ST indicator on the display goes out and the audio switches to mono, which reduces the amount of noise received.
- To end mono mode, again press and hold down the Mono button (for at least about 1 second). Mono mode is also ended when you change the frequency or switch off the power.

Other Functions

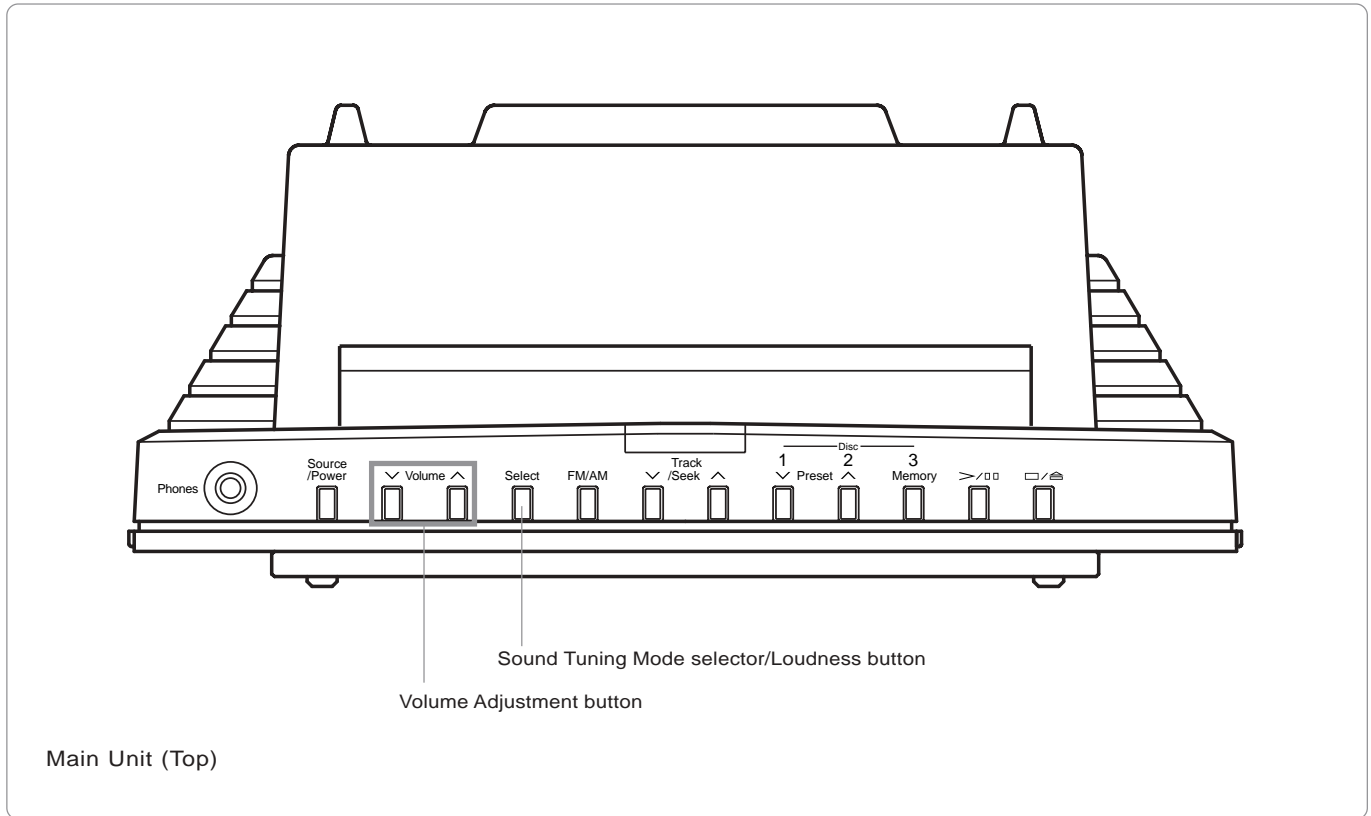

Tone/balance adjustment

Press the Sound Tuning Mode selector to display BAS (bass), MID (mid range), TRE (treble), or BAL (balance) on the display.

- Pressing the Volume Adjustment button () raises the level for the bass when BAS is displayed, for the mid range when MID is displayed, and for the high range when TRE is displayed. When BAL is displayed, pressing the () button emphasizes the right side.
- Pressing the Volume Adjustment button () lowers the level for the bass when BAS is displayed, for the mid range when MID is displayed, and for the high range when TRE is displayed. When BAL is displayed, pressing the () button emphasizes the left side.

Audio mute

Pressing the Mute button instantaneously lowers the volume.

- To end the muting, press the Mute button again.

Loudness compensation

When you press and hold down the Loudness button (for at least about 1 second), the Loud. indicator is displayed on the main unit display and the bass and treble, which tend to be impaired at low volumes, are emphasized.

- To end loudness, again press and hold down the Loudness button (for at least about 1 second).

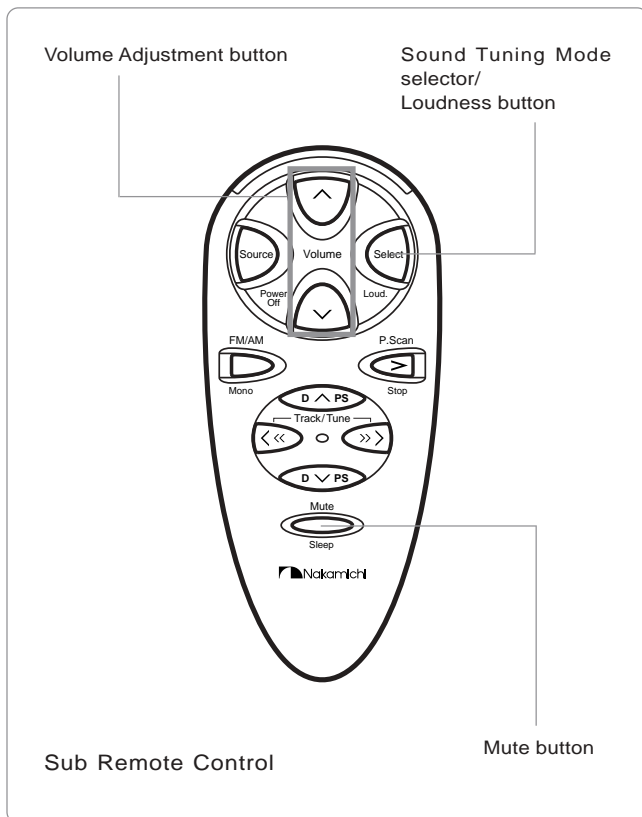

Changing the Source Display

You can change the display for AUX mode or tape mode to match the external input source. (The factory settings for these displays are "AUX" and "TAPE".)

1. Press the AUX button (Tape button).
2. With "AUX" ("TAPE") displayed on the display, press and hold down the AUX button (Tape button) (for at least about one second).
3. While the "AUX" ("TAPE") display is flashing, pressing the AUX button (Tape button) changes the display through the sequence: "TV" → "VIDEO" → "AUX" → "TV" ("MD" → "TAPE" → "MD" →).
4. While the desired source name is being displayed, press and hold down the AUX button (Tape button) (for at least 1 second). This changes the source display setting.

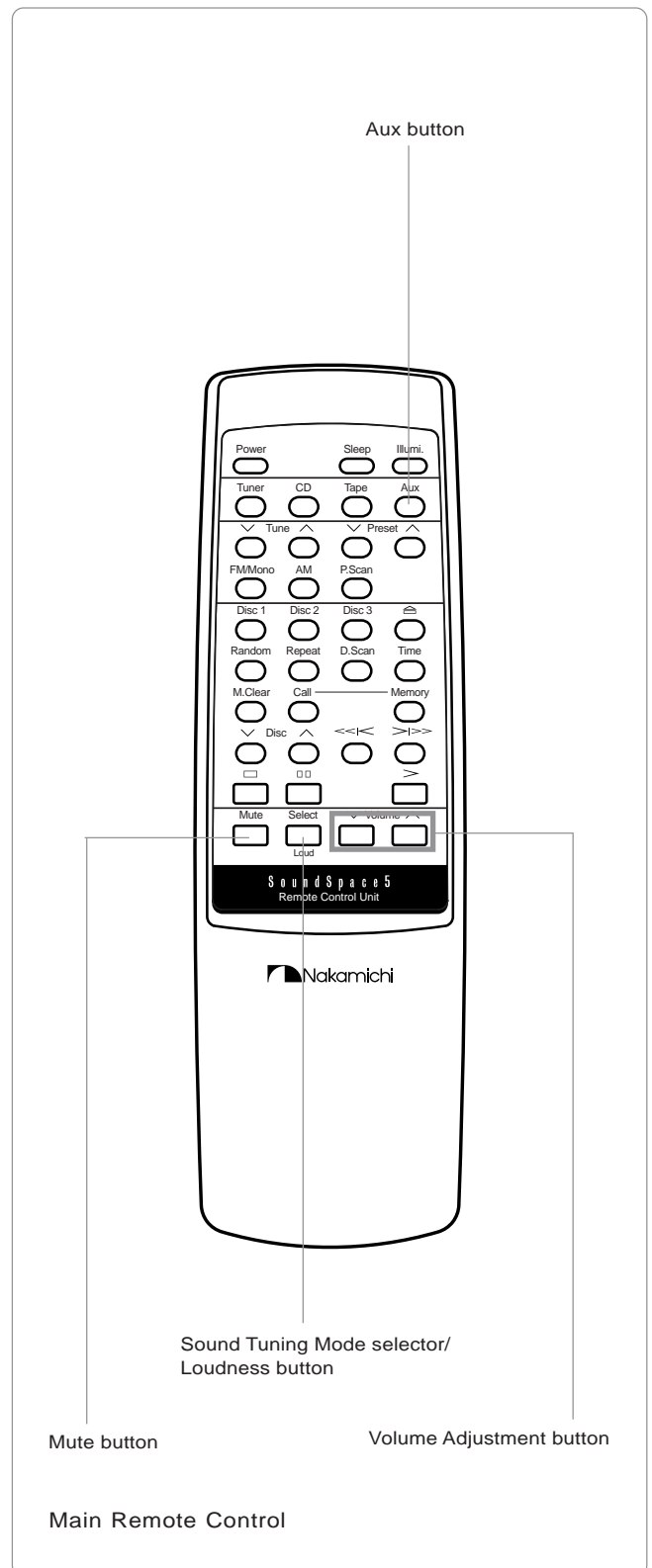

Stereo Music System

Other Functions

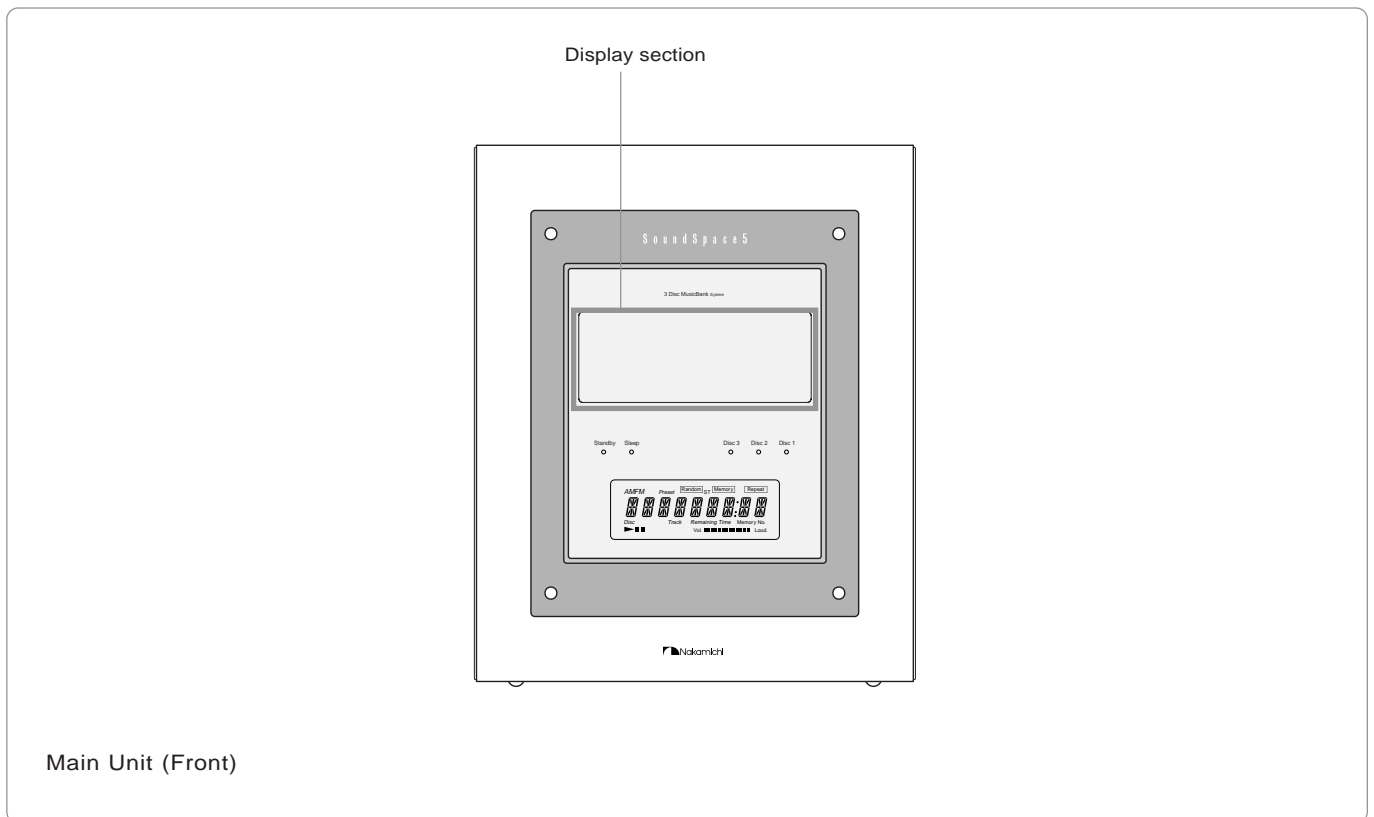

Sleep function

Each time you press the Sleep button, the time until the unit automatically goes on standby is changed to the next step in the sequence 10 minutes/20 minutes/30 minutes/60 minutes/90 minutes/120 minutes/end sleep mode.

- To end sleep mode, press the Sleep button again.
- When setting sleep with the sub remote control, press and hold down the Sleep button (for at least about 1 second). You can change the setting time by repeatedly pressing the Sleep button after the time is displayed. To end sleep mode, press and hold down the Sleep button (for at least about 1 second).

Audio timer

You can use any commercially available audio timer to switch on the power at the set time.

1. Select the source. (When selecting CD, put the CD player on playback or pause.)
 2. Adjust the volume and tone.
 3. With the audio timer, set the time at which the power will come on.
- If the audio timer is set with CD playback stopped, the power comes on with the unit in CD mode, but the CD is not played back. Be sure to set the audio timer with CD player on playback or pause.

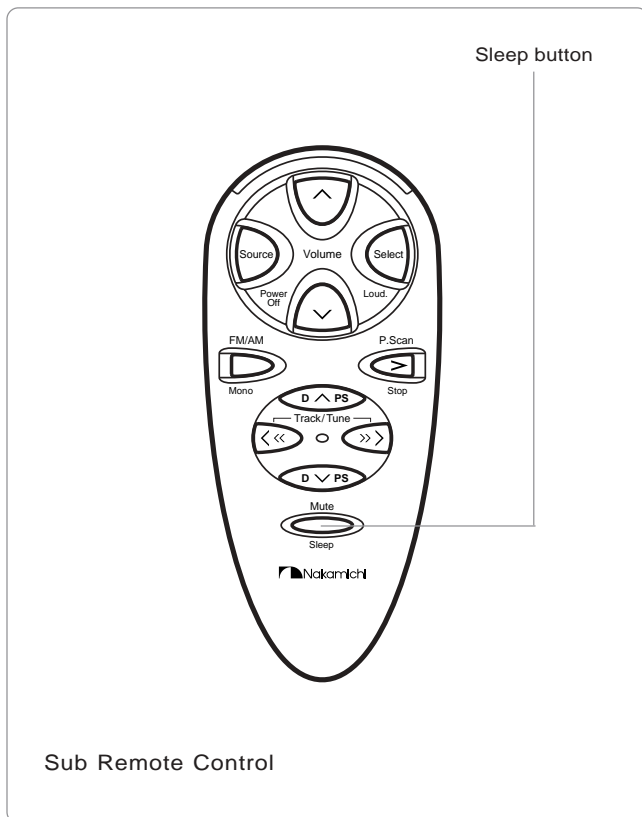

Selecting the Illumination Color

Each time you press the Illumination button, the illumination color for the window sections of the main unit toggles between green and blue.

- You can put out the window section illumination by pressing the Illumination button and holding it down (for at least 1 second). To light up the illumination again, press and hold down the illumination button again (for at least 1 second).
- The factory setting is blue illumination.

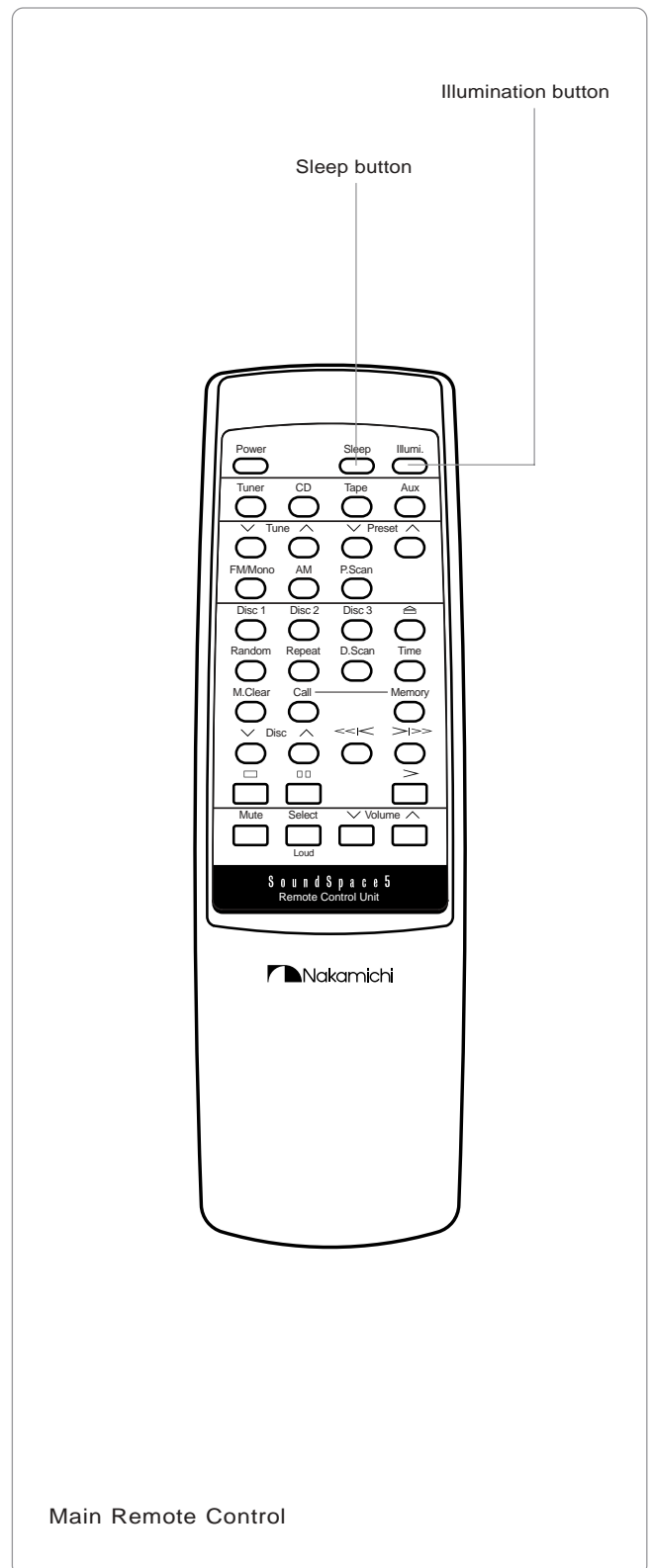

Troubleshooting

Some apparent malfunctions may be remedied by simple checks as described below. If the problem persists, please contact your dealer or an authorized Nakamichi service center.

No power.

- Verify that the plug of the power cord is plugged properly into the AC outlet.
-

No sound.

- Verify that all connections are established properly.
 - Verify that volume level is set to a suitable position.
 - Verify that mute function is disabled.
 - Verify that speakers are connected properly.
 - The protection circuitry may have been activated. Stop playback of the program source and wait a while until the amplifier automatically resets itself.
-

Some channels are interchanged.

No sound in some channels.

- Verify that audio equipment connections are established properly.
 - Verify that balance is set correctly.
-

Hum is heard.

- Verify that all connections are established properly.

After insertion, a disc is ejected again.

- The disc was inserted upside down. Insert the disc with the label facing up.
-

Disc playback is not possible, sound is unstable, or skipping occurs.

- If the disc is dirty, clean it.
 - If the disc is scratched, use another disc.
 - Turn off the CD player and other components, and check all connections.
 - Moisture may have condensed on the pickup lens. Turn the unit on and let the unit warm up for about 30 minutes to one hour.
-

Memory play is not possible.

- The contents of the memory may have been lost. Repeat the memory programming procedure.

FM broadcast is supposed to be in stereo, but sound is monaural.

- Verify that antenna is connected properly.
 - Press and hold down the Mono button (for at least 1 second) to end mono mode.
-

FM or AM broadcasts cannot be received.

- Adjust position and/or orientation of antenna.
 - Verify that antenna is connected properly.
-

FM or AM broadcast reception is noisy.

- Adjust position and/or orientation of antenna.
- Increase distance between this unit and other electrical equipment.

Remote control cannot be operated.

- Verify that power is supplied to the unit.
 - Verify that batteries are inserted properly.
 - Replace both batteries with fresh ones.
 - Point remote control at sensor when operating.
 - Remove any obstacles between remote control and the main unit.
 - Do not operate remote control units of other equipment at the same time.
-

“E-MECHA” indication appears.

- Turn the unit off and then on again.

Specifications

[Main unit]

Control Amplifier Section

Inputs 2 (Tape, Aux)
 Outputs 1 channel (Subwoofer)
 Recording Outputs 1 (Tape)
 Input Sensitivity / Impedance 250 mV / 33 kohm
 Rated Output Level / Impedance
 Line Output 500 mV / 1 kohm
 Recording Output 250 mV / 1 kohm
 Headphone Output 40mW / 40ohm
 Total Harmonic Distortion Less than 0.04 % (20 - 20,000 Hz)
 Frequency Response 10 - 50,000 Hz +0, -3 dB
 Signal-to-Noise Ratio Better than 80 dB (A-WTD, input shorted)
 Channel Separation Better than 55 dB (1 kHz, input shorted)
 Tone Controls
 Bass 20 Hz \pm 10 dB
 Mid 1 kHz \pm 10 dB
 Treble 20 kHz \pm 10 dB
 Loudness 100 Hz +7 dB, 10 kHz +5 dB

Power Amplifier Section

Continuous Sine Wave Power Output
 15 W X 2 (1 kHz, 1 % THD)
 Maximum Power output 18 W X 2
 Total Harmonic Distortion Less than 0.1 % (1 W)

AM Tuner Section

(Modulation: 400 Hz, 30 %)
 Frequency Range
 U.S.A./Canada 522 - 1,629 kHz in 9-kHz steps
 Other Area 530 - 1,710 kHz in 10-kHz steps
 or 531 - 1,602 kHz in 9 - kHz steps
 Sensitivity 55 dB μ /m
 Signal-to-Noise Ratio Better than 50 dB at 90 dB μ /m
 Total Harmonic Distortion Less than 1 % at 90 dB μ /m

FM Tuner Section

- All RF levels in microvolts given re 75-ohm antenna input.
 - Modulation: Mono 100 %, Stereo Pilot: 10 %, Stereo Audio Signal: 90 %
 Frequency Range
 U.S.A./Canada 76.0 - 90.0 MHz in 100-kHz steps
 Other Area 87.5 - 108.0 MHz in 50-kHz steps
 IHF Usable Sensitivity 14 dBf / 2.7 μ V (Mono, IHF)
 50-dB Quieting Sensitivity 22 dBf / 6.9 μ V (Mono)
 Signal-to-Noise Ratio Mono : Better than 72 dB at 65 dBf
 Stereo : Better than 68 dB at 65 dBf
 Frequency Response 30 - 15,000 Hz +1, -3 dB
 Total Harmonic Distortion Mono : Less than 0.4 % (1 kHz)
 Stereo : Less than 0.6 % (1 kHz)
 Stereo Separation Better than 30 dB (1 kHz)

CD Player Section

System Compact Disc digital audio
 Signal Readout Optical (semiconductor laser)
 Error Correction CIRC principle
 Number of channels 2 channels, stereo
 D/A Converter type 20-bit Dual D/A Converters
 with 8-times oversampling digital filter
 Sampling Frequency 44.1kHz
 Quantization 16-bit linear
 Disc Rotational Velocity Approx. 200 to 500 rpm
 (constant linear velocity)
 Wow-and-Flutter Below measurement limit
 Frequency Response 5 - 20,000 Hz \pm 0.5 dB
 Total Harmonic Distortion 0.005 % or less (1 kHz, 0 dB)
 Signal-to-Noise Ratio Better than 95 dB (IHF A-WTD)
 Dynamic Range Better than 95 dB
 Channel Separation Better than 90 dB
 Optical Digital Output 660 nm, -18 dBm

[Speaker Unit]

Enclosure	2-way bass reflex type
Speaker Unit	
Midrange/Woofers	10 cm (1 - 15/16 inches) round cone X 2
Tweeter	2.5 cm (1 inch) semi dome
Impedance	4 ohms
Rated Power Handling	10 W
Maximum Power Handling	20 W

[Remote Control Unit]

Principle	Infrared pulse system
Power Supply	DC 3 V (1.5 V X 2)
Dimensions*	
Main Remote Control	55 (W) X 19 (H) X 182 (D) mm 2 - 3/16 (W) X 3/4 (H) X 7 - 3/16 (D) inches
Sub Remote Control	49 (W) X 26 (H) X 110 (D) mm 1 - 15/16 (W) X 1 (H) X 4 - 5/16 (D) inches
Mass	
Main Remote Control	Approx. 100 g / 4 oz. (including batteries)
Sub Remote Control	Approx. 60 g / 2 oz. (including batteries)

[General]

Power Source	AC 100 V, 50/60 Hz AC 110 - 120 V or AC 220 - 240 V, 50/60 Hz (According to country of sale)
Power Consumption	95 W max.
Dimensions*	
Main Unit	220 (W) X 270 (H) X 94 (D) mm 8 - 11/16 (W) X 10 - 5/8 (H) X 3 - 11/16 (D) inches
Speaker Unit	220 (W) X 270 (H) X 95 (D) mm 8 - 11/16 (W) X 10 - 5/8 (H) X 3 - 3/4 (D) inches
Power Supply Unit	100 (W) X 88 (H) X 160 (D) mm 3 - 15/16 (W) X 3 - 7/16 (H) X 6 - 5/16 (D) inches
Mass	
Main Unit	Approx. 3.0 kg, 6 lbs. 10 oz.
Speaker Unit	Approx. 1.8 kg, 3 lbs. 15 oz.
Power Supply Unit	Approx. 2.1 kg, 4 lbs. 10 oz.
Supplied Accessories	Power supply cable X 1 AM loop antenna X 1 Dipole antenna X 1 Antenna adapter X 1 IEC R03 (size AAA) battery X 4 Rubber feet X 6 Tapping screw (M5.5x16) X 6 Speaker grill (navy blue) X 2 Speaker grill (green) X 2

- * Dimensions do not include protruding parts. Height is the panel height.
- Specifications and design are subject to change for further improvement without notice.
- MusicBank is a registered trademark of Nakamichi Corporation.

CAUTION

Adjusting the knobs, switches and controls, etc. or taking actions not specified herein may result in a harmful emission of laser beams. This Compact Disc Player must be adjusted and repaired only by qualified service personnel.

OBSERVERA!

Inställningar av rattarna, omkopplarna eller övriga kontrollknappar som inte anges i bruksanvisningen kan resultera i farlig laserstrålning. Justering eller reparation av denna kompaktskivspelare skall endast utföras av kvalificerad servicepersonal.

HUOMAUTUS

Jos nuppeja, kytkimiä ja säätimiä ym. säädetään tai laitetta käytetään toisella tavalla kuin on selostettu, tuloksena saattaa olla vaarallista lasersäteiden vuotoa. CD-soittimen säätö ja korjaus on jätettävä aina asiantuntevan huoltoteknikon tehtäväksi.

OBS!

Indstilling af knapper, cmskiftere og øvrige kontrolknapper, som ikke følger den i brugsanvisningen beskrevne måde, kan resultere i farlig laserudstråling. Justering eller reparation af denne CD-afspiller må kun udføres af kvalificeret servicepersonale.

OBS!

Justering av ratt, brytere og kontroller etc., eller annet som ikke er beskrevet her, kan resultere i farlig laserbestråling. Justering eller reparasjon av denne CD-spilleren må bare utføres av kvalifiserte fagfolk.

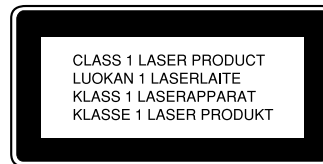
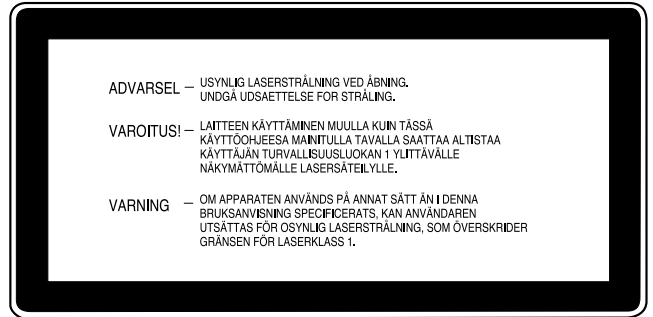

LASER DIODE PROPERTIES

MAXIMUM RADIANT POWER: 0.5 mW

WAVELENGTH: 790 nm

EMISSION DURATION: CONTINUOUS

The label is attached to the Compact Disc Player on the location specified in the illustration. For your own protection, you are strongly advised to follow the directions on the label, when handling laser radiation-emitting equipment. The label indicates that the equipment contains laser radiation-emitting components.

Följande etikett är klistrad på det ställe på denna kompaktskivspelare som är angivet på illustrationen. För din egen säkerhet skall du noggrant följa anvisningarna angivna på etiketterna vid hantering av de laserutstrålande komponenterna. Denna etikett visar att apparaten innehåller laserutstrålande komponenter.

CD-soittimeen on kiinnitetty tarra kuvassa näkyvään paikkaan. Oman turvallisuutesi vuoksi on tärkeää noudattaa tarkasti tarrassa olevia ohjeita, kun käytät lasersäteitä lähettäviä laitteita. Tarra osoittaa, että laite sisältää lasersäteitä lähettäviä osia.

Mærkatens er anbragt på CD-afspilleren, som vist på illustrationen. For din egen sikkerheds skyld bør du nøje følge anvisningerne på mærkatens, når du bruger laserudstrålende udstyr. Mærkatens viser, at apparatet indeholder laserudstrålende komponenter.

Etiketten er klistret på det stedet som er spesifisert i illustrasjonen. For din egen sikkerhets skyld må du følge anvisningene som er oppgitt på etiketten når du behandler laserstråleproduserende komponentene. Etiketten indikerer at komponentet inneholder laserstråleproduserende komponenter.

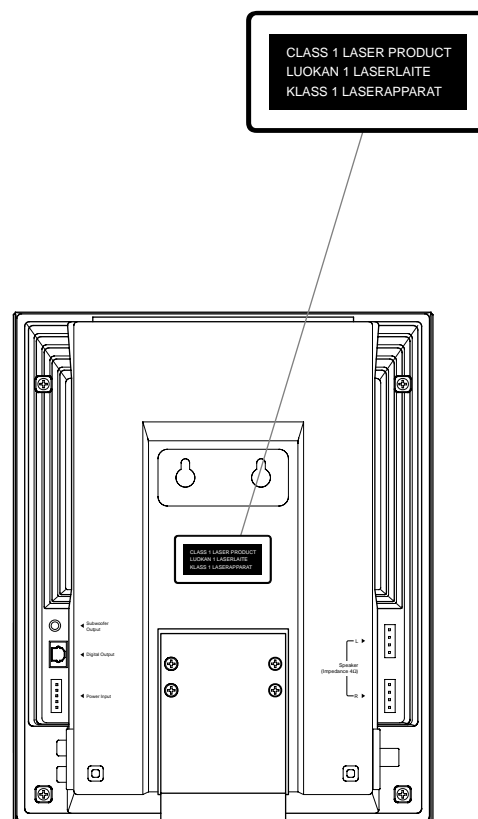

Nakamichi Corporation	1-153 Suzukicho, Kodaira, Tokyo 187-8501, Japan Phone: 81(42)346-3103 Fax: 81(42)344-0802
Nakamichi America	955 Francisco St., Torrance, CA 90502 Phone: 1(310)538-8150 Fax: 1(310)324-7614
Nakamichi Canada	276 S.W. Marine Drive, Vancouver, B.C. V5X 2R4, Canada Phone: 1(604)324-7535 Fax: 1(604)324-7919
Nakamichi Asia	8/F The Grande Bldg., 398 Kwun Tong Rd., Kowloon, Hong Kong Phone: 852(2357)6690 Fax: 852(2357)6697
Nakamichi Europe	Berkshire House, 56, Herschel Street, Slough, Berkshire SL1 1PY, England Phone: 44(1753)577 345 Fax: 44(1753)550 211
Web Site	http://www.nakamichi.com

Free Manuals Download Website

<http://myh66.com>

<http://usermanuals.us>

<http://www.somanuals.com>

<http://www.4manuals.cc>

<http://www.manual-lib.com>

<http://www.404manual.com>

<http://www.luxmanual.com>

<http://aubethermostatmanual.com>

Golf course search by state

<http://golfingnear.com>

Email search by domain

<http://emailbydomain.com>

Auto manuals search

<http://auto.somanuals.com>

TV manuals search

<http://tv.somanuals.com>