

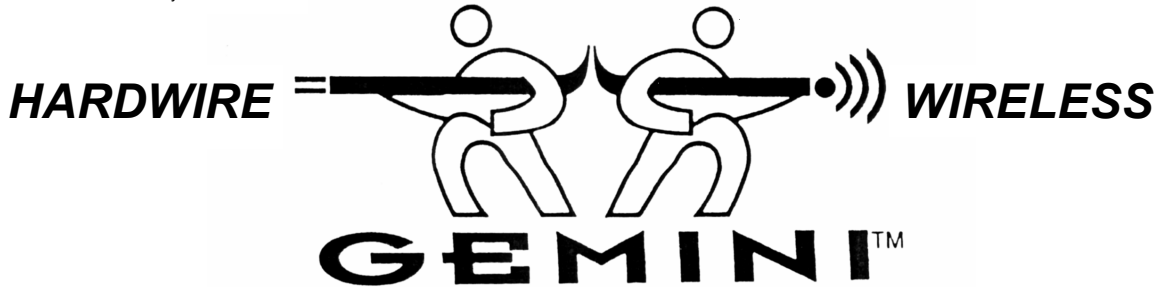

Publicly traded on NASDAQ Symbol: NSSC

PROGRAMMING INSTRUCTIONS



GEM-P3200 CONTROL PANEL/COMMUNICATOR

Programming the GEM-P3200 Control Panel with the "Classic" GEM-RP1CAe2 Keypad and the "K Series" GEM-K1CA Keypad

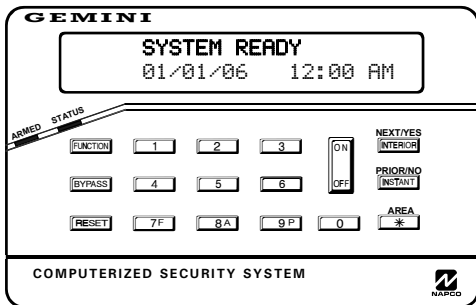

"Classic" GEM-RP1CAe2

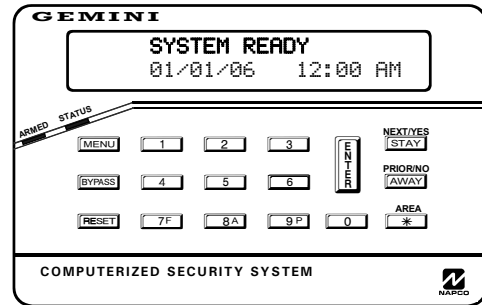

"K Series" GEM-K1CA

Quick Start (for "Classic" GEM-RP1CAe2)

1. Refer to the wiring diagram, connect Siren, Aux. Power, PGM Output, Remote Bus, Earth ground, Zone and Telephone wiring. NOTE: See Installation Instructions (WI817).
2. Connect AC power first and then the battery.
3. Configure the keypad (see page 55).
4. Access the Easy Menu Driven (Dealer Program) Mode:

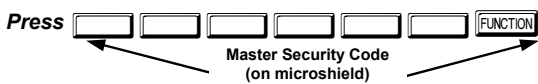

Press NO (**INSTANT**) until "ACTIVATE PROGRAM Y/N" appears on the keypad display.

Press YES (**INTERIOR**) to Enter Dealer Program Mode. Go to page 5.

Quick Start (for "K-Series" GEM-K1CA)

1. Refer to the wiring diagram, connect Siren, Aux. Power, PGM Output, Remote Bus, Earth ground, Zone and Telephone wiring. NOTE: See Installation Instructions (WI817).
2. Connect AC power first and then the battery.
3. Configure the keypad (see page 55).
4. Access the Easy Menu Driven (Dealer Program) Mode:

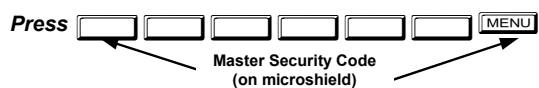

Press NO (**AWAY**) until "ACTIVATE PROGRAM Y/N" appears on the keypad display.









Press YES (**STAY**) to Enter Dealer Program Mode. Go to page 5.

THIS MANUAL INCLUDES FEATURES WHICH ARE ONLY AVAILABLE IN CONTROL PANEL FIRMWARE VERSION 50 OR LATER.

IMPORTANT NOTE

This manual supports the keypad programming of the GEM-P3200 control panel with the NAPCO "classic" GEM-RP1CAe2 keypad as well as the GEM-K1CA "K Series" keypad. The new "K Series" GEM-K1CA model offers the new STAY and AWAY buttons with simplified functionality, along with the new MENU and ENTER buttons. **Note:** While the instructions in this manual are depicted using the GEM-K1CA keypad, the manual applies to both the "classic" and the "K Series" keypads.

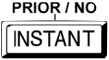
Program Mode is the same for both keypads--**only the button names have changed**, as follows:

- The  button and the  button operate identically (in Program Mode) for both keypads.
- The  button and the  button operate identically (in Program Mode) for both keypads.
- The  button and the  button operate identically (in Program Mode) for both keypads. The words "NEXT/YES button" are used in this manual.
- The  button and the  button operate identically (in Program Mode) for both keypads. The words "PRIOR/NO button" are used in this manual.

 **For consistency, it is recommended that all keypads either be all "classic" or all "K Series"--both keypad types should not be used in one alarm system.**

CHANGES FROM PREVIOUS EDITION

The following changes have been made to this manual (W1818G) since the previous edition (W1818F).

New addresses added to accommodate the GEM-ACM1D / GEM-2D Access Control Accessories, as follows:

- Enable ACM Access
- ACM Zone Options
- ACM Global Flags
- ACM Timeouts
- ACM Door Area Options
- ACM Scheduled Free Access
- Enable Panel Options
- Emergency Free Access
- Keypad Home Area / ACM Door #1 Area (Hex)
- Addition to the Easy Program Menu instructions, "Enter Proximity Card Users".

Existing addresses were changed and new addresses were added to accommodate the NAPCO NetLink™ NL-Mod device, as follows:

- For each telephone number desired, enable "Report to TCP/IP Receiver or AES" for Telco 1, Telco 2 and Telco 3.
- Enable "Callback Telephone No. Select". Enter either "1" for Callback Telephone Number 1 or "2" for Callback Telephone Number 2.
- Enable "Handshake for Local Telemetry"
- Enable "TCP/IP Communications"
- Enable "TCP/IP Panel/Site Initiated Functions"

NAPCO Security Group, Inc.,

333 Bayview Avenue, Amityville, New York 11701

For Sales and Repairs, call toll free: (800) 645-9445

For direct line to Technical Service, call toll free: (800) 645-9440

Internet: <http://www.napcosecurity.com>

TABLE OF CONTENTS

IMPORTANT NOTE	2	SYSTEM OPTIONS (ADDRESS 2420-2422, 3874, 3905, 3880-3881).....	35
CHANGES FROM PREVIOUS EDITION	2	ALARM/TROUBLE REPORTING CODES (ADDRESS 3880-3881).....	35
SYSTEM PROGRAMMING OPTIONS	4	SYSTEM OPTIONS (ADDRESS 3882-3901, 3903-3905 & 4084).....	36
<i>Introduction</i>	4	KEYPAD OPTIONS (ADDRESS 2425-2446).....	37
<i>Downloading from a Computer</i>	4	ACM ZONE OPTIONS (ADDRESS 2740-2769).....	38
EASY MENU DRIVEN PROGRAM MODE	5	ACM GLOBAL FLAGS (ADDRESS 2780).....	38
<i>Dealer Program - Preliminary Information</i>	5	ACM TIMEOUTS (ADDRESS 2782-2783).....	38
<i>Accessing Dealer Program Mode</i>	5	ACM DOOR AREA OPTIONS (ADDRESS 2784-2787).....	39
<i>Customizing a Default Program</i>	5	ACM SCHEDULED FREE ACCESS (ADDRESS 4072-4075).....	39
<i>GEM-RP1CAe2/GEM-K1CA Keypad Easy Program Menu</i>	6	KEYPAD HOME AREA / ACM DOOR #1 AREA (HEX) (ADDRESS 2425-2431) 40	
DIRECT ADDRESS PROGRAM MODE	15	SYSTEM OPTIONS (ADDRESS 2423).....	41
<i>Direct Address Overview</i>	15	EMERGENCY FREE ACCESS (ADDRESS 4080).....	41
<i>Address Mode Displays</i>	15	USER AREA OPTIONS (ADDRESS 2455-2502).....	42
<i>Binary (Bit) Format Example</i>	15	EZM GROUP OPTIONS (ADDRESS 2555-2576).....	43
<i>Decimal Format Example</i>	16	AREA ARMING OPTIONS (ADDRESS 2650-2651).....	44
<i>Hexadecimal Format Example</i>	17	REMOTE ACCESS LOGGING (ADDRESS 3184).....	44
<i>Programming Conventions Used in this Manual</i>	18	AREA OUTPUT CONTROL OPTIONS (ADDRESS 2700-2739).....	45
PROGRAMMING OPTIONS & WORKSHEETS	19	RF RECEIVERS & SUPERVISORY TIMER OPTIONS (ADDRESS 3776 & 3760-3775).....	46
SYSTEM DELAYS & TIMEOUTS (ADDRESS 0000-0002, 2402, 2406, 2414 & 3902).....	19	EXTERNAL RELAY CONTROL / RELAYS 1-24 (ADDRESS 3778-3801 & 2800-2895).....	47
SYSTEM DELAYS & TIMEOUTS (ADDRESS 2407, 2408 & 4088).....	19	NUMBER OF RELAY BOARD MODULES (ADDRESS 3777).....	51
SYSTEM DELAYS & TIMEOUTS (ADDRESS 2400, 2401, 2403-2405, 4082 & 4083).....	20	SYSTEM RESET OPTIONS (ADDRESS 4091-4093).....	52
KEYPAD SYSTEM CODES (ADDRESS 0490-0495 & 0500-0502).....	20	USER PROGRAM MODE	52
CS RECEIVER FORMAT OPTIONS (ADDRESS 0520, 0521, 0525, 0526, 0550, 0551, 0575 & 0576).....	21	<i>Preliminary Information</i>	52
CS RECEIVER TELEPHONE NUMBERS (ADDRESS 0527-0546, 0552-0571, 0577-0596).....	22	<i>Accessing User Program Mode</i>	53
DOWNLOAD/CALLBACK OPTIONS (ADDRESS 4089, 0600-0619, 0625-0647, 1022 & 1023).....	22	<i>User Codes</i>	53
CS SUBSCRIBER ID NUMBERS (ADDRESS 0650-0787).....	23	<i>Zone Descriptions</i>	54
CS SUBSCRIBER ID NUMBERS (ADDRESS 0790-0857).....	24	KEYPAD CONFIGURATION MODE	55
CS REPORTING CODES (ADDRESS 0859-0883).....	24	<i>Keypad Installation</i>	55
CS REPORTING CODES (ADDRESS 0870-0904).....	25	<i>Configuring the Keypads</i>	55
CS AREA & SYSTEM REPORTING OPTIONS (ADDRESS 1024-1027).....	25	ALPHABETICAL INDEX	57
CS ZONE REPORTING CODES (ADDRESS 0910-0957).....	26	ADDRESS NUMBER INDEX	61
CS USER REPORTING CODES (ADDRESS 1030-1074).....	27	GEM-P3200 WIRING DIAGRAM	68
GLOBAL SYSTEM TROUBLE REPORTING OPTIONS (ADDRESS 1082-1116).....	28		
AREA SYSTEM TROUBLE REPORTING OPTIONS (ADDRESS 1120-1137).....	29		
ZONE OPTIONS / ZONES 1-16 (ADDRESS 1200-1386).....	30		
ZONE OPTIONS / ZONES 17-32 (ADDRESS 1402-1586).....	31		
ZONE OPTIONS / ZONES 33-48 (ADDRESS 1602-1786).....	32		
SYSTEM OPTIONS (ADDRESS 2415-2419).....	34		

Refer to accompanying GEM-P3200 Installation Instructions (WI817) for installation information.



SYSTEM PROGRAMMING OPTIONS

INTRODUCTION

The GEM-P3200 control panel may be programmed by various means, each of which will be covered in detail in the sections that follow. Keypad displays shown are for a GEM-K1CA (v.8), the recommended keypad for programming.

✓ **Downloading From a Computer.** This is the preferred method of programming. The panel may be downloaded from (or uploaded to) an IBM PC-compatible computer, either locally or remotely. Napco's PCD3000 and PCD Windows Quickloader software feature context-sensitive help screens as well as an error-checking utility that prevents programming of incompatible or conflicting data to ensure proper panel operation. **Note:** Unattended downloading from a computer is not allowed for Fire Alarm or UL installations.

✓ **Easy Menu-Driven Program (Dealer Program) Mode - Keypad Programming.** The Easy Menu-Driven Program Mode allows keypad programming of number of zones in Area 1 and 2, number of fire zones (both 4-wire and 2-wire), local or Central Station reporting, number of exit/entry zones, number of interior zones, number of 24 hour zones, number of chime zones, Chime 2 zones, Exit/Entry2 zones, 50ms loop response zones (**Note: 750mS is required for Loop Response time in UL installations**), aux output activated on alarm zones, sensor watch zones, keypad sounder on alarm zones, auto bypass re-entry zones, EOLR zones, number of keypads in Area 1 and 2, Central Station telephone number, Central Station account number, Central Station receiver format, User Codes, RF transmitter points, RF keyfob transmitters, zone descriptions, date/time, dealer code, Telco line fault test, Burg output chirp on keyfob, keypad time/date display, enable CP-01 programming, and clear dealer program/cold start. For new panels, a custom default program may be created at the keypad. A menu-driven utility prompts the installer to configure the system. Further detailed customization is accomplished in the Direct Address Program Mode.

✓ **Direct Address (Dealer Program) Program Mode - Keypad Programming.** The Direct Address Program Mode is an extension of the Dealer Program Mode wherein data is entered at the keypad by location. This mode is accessed from the Easy Menu Driven Program Mode by pressing the  button at any time.

✓ **User Program Mode - Keypad Programming.** The User Program Mode is intended for authorized users and is limited to keypad programming of User Codes, Time, Date and Zone Descriptions.

DOWNLOADING FROM A COMPUTER

The control-panel program may be downloaded from the computer by any of the following methods.

Local Downloading

(**Note:** This procedure should be used after installation, after peripheral devices are connected).

For direct high-speed data transfer to the control panel from a desktop computer, connect the download jack (JP2) on the panel to the LOCAL jack (J3) on the Napco PCI2000/3000 computer interface using the supplied 6-conductor cable. (Refer to PCI2000/3000 Installation Instructions WI443 for wiring diagram and procedures).



Similarly, a high-speed local download may be made in the field using a notebook or laptop computer. Connect JP2 on the control panel to a Napco PCI-MINI computer interface using the 6-conductor cable supplied. (Refer to PCI-MINI Installation Instructions WI767).



Remote Downloading

(Also see PCI2000/3000 Installation Instructions WI443).

Function Mode











Start by establishing a telco connection between the computer operator and the installer. During this procedure, voice contact will be lost, therefore both the installer and the computer operator should be familiar with the operation. When a steady high-pitched tone is heard at the site phone, access the "ACTIVATE DOWNLOAD" Function (see Keypad Programming Modes), then press the  or  button or the **NEXT/YES** button; the site phone will go dead. Hang up the phone and wait for a call from the central station confirming a successful download.

Callback Method

An installed, unattended panel may be programmed or reprogrammed remotely using the Callback-Method Download feature of the PCD-Windows Quickloader software. Remote downloading requires a modem compatible with the PCI2000/3000. Upon answering the call from the computer, the panel will verify the Download Security Code and, if confirmed, will establish a connection. If a Callback Number is programmed into the panel, the panel will automatically disconnect and call the computer at this number before establishing a connection.

EASY MENU DRIVEN PROGRAM MODE





DEALER PROGRAM - PRELIMINARY INFORMATION

-  Only Keypad #1 may be used for both dealer and user programming, however this keypad may be located in any area.
-  The Master Security Code is *printed on the panel's microprocessor can*. Use this code to enter the Dealer Program Mode to program a custom Dealer Security Code. Record the number, then remove the code label to prevent unauthorized access to the panel. If you forget your Dealer Security Code, use the Master Security Code to enter programming.
-  After entering codes or data, press the save  button. Data will not be stored into memory unless it is pressed.
-  If the keypad is in the Program Mode and no activity is detected for longer than 4 minutes, a steady tone will sound.
-  Silence the sounder by pressing the  button to continue, or by pressing the  button to exit.
-  A panel that has been COLD STARTED (Address Location 4093) performs identically to a new panel.
-  If a GEM-RP2ASe2/GEM-K2AS (Version 6) is used, configure address jumpers as Keypad #1 (see WI1184).

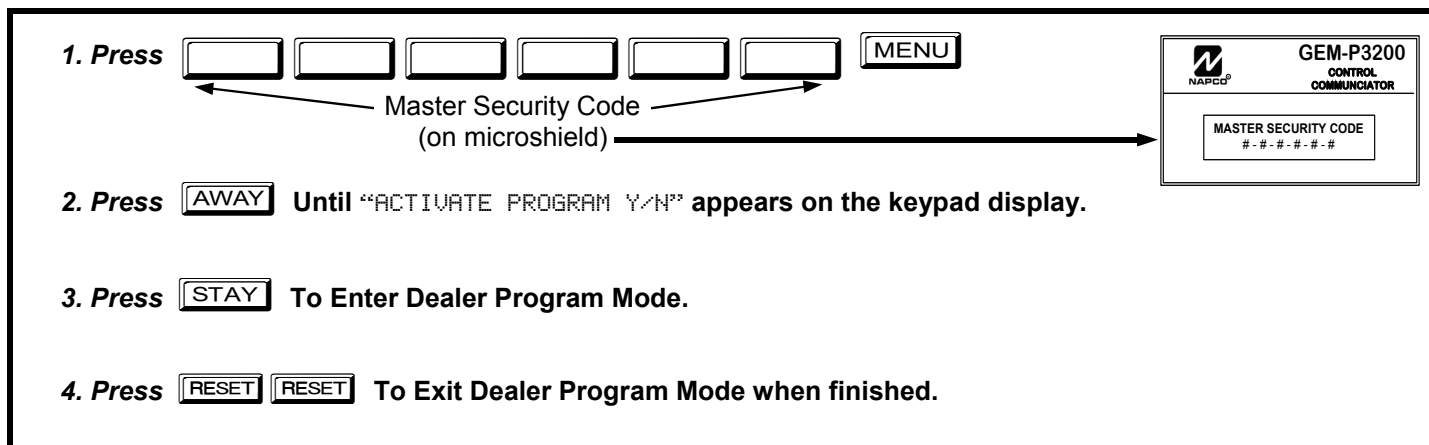
KEYPAD #1: For ease of programming, it is recommended that a GEM-K1CA (Version 8) be used as Keypad #1. (Regardless of which keypad is selected, all *new* keypads are configured as Keypad #1 out of the box).

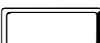

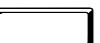
ACCESSING DEALER PROGRAM MODE



1. Press       
 Master Security Code (on microshield)

2. Press  **Until "ACTIVATE PROGRAM Y/N" appears on the keypad display.**

3. Press  **To Enter Dealer Program Mode.**



4. Press   **To Exit Dealer Program Mode when finished.**

CUSTOMIZING A DEFAULT PROGRAM

For new panels, you can design a default program that will best suit your application. Using this procedure, you will configure the panel for:

- Total Number of Zones in Area 1
- Total Number of Zones in Area 2
- Fire Zones in Area 1
- 2-Wire Fire Zones in Area 1
- Report All Zones to Central
- Exit/Entry Zones in Area 1
- Interior Zones in Area 1
- 24 Hour Zones in Area 1
- Chime Zones in Area 1
- Chime 2 Zones in Area 1
- Exit/Entry2 Zones in Area 1
- 50mS Loop Response Zones (Note: 750mS is required for Loop Response time in UL installations).
- Aux Output Activated on Alarm Zones
- Sensor Watch Zones
- Keypad Sounder on Alarm Zones
- Auto Bypass re-entry Zones
- Enable no EOLR Zones
- Enable Telco Line Fault Test
- Enable Burg Output Chirp on Keyfob
- Enable SIA CP-01 Features
- Number of Keypads in Area 1
- Number of Keypads in Area 2
- Central Station Receiver 1 Tel. Number
- Central Station Receiver 1 Account Number
- Central Station Receiver 1 Format
- Enter User Codes
- RF Transmitter Points
- Quick Method (Enroll Method)
- KeyFob Transmitters (as Arm/Disarm & Control Devices)
- KeyFob Transmitters (as Zone Input Devices)
- Enter Zone Descriptions
- Enter Date
- Enter Time
- Dealer Code
- Exit Dealer Program Mode

This procedure will automatically set up system keypads, EZMs, wireless transmitters, etc. After your basic default program has been loaded, you may alter it as necessary in the Direct Address Program Mode.

NEW PANELS: The custom default program may be created for new panels only. Once the panel has been programmed by any means, the number of areas, number of zones, fire zones, entry/exit zones and interior zones will be suppressed and cannot be changed. Should it be necessary to create a new custom default program, (a) from the Dealer Program Mode, press the  button to enter the Direct Address Program Mode; (b) access Location 4091 (Clear Program); (c) press the  button and start over.



GEM-RP1CAe2/GEM-K1CA Keypad Easy Program Menu

To create a custom program using the GEM-RP1CAe2/GEM-K1CA keypad, simply answer the following questions and record your information on the *Easy Menu Programming Worksheet*. In each of the following steps, press **MENU** to set cursor, the NEXT/YES button to go forwards, the PRIOR/NO button to go backwards, **SAVE** to save and **RESET** twice to exit at any time.

#of Zns in Area1
Enter # Zones XX

(Direct Entry)

Total Number of Zones in Area 1 (New Program Only)

- Enter the total number of zones to be programmed for Area 1.
- Valid entries are from 08 to 48. Directly enter the total number of zones, including leading zeros.
- The system is based on groups of 4 zones each (after the first 8 zones), and will automatically round up to the next group of 4. For example, if you enter 18, it will automatically convert this to 20 zones. Press **SAVE** to save. Press the NEXT/YES button to proceed.

#of Zns in Area2
Enter # Zones XX

(Direct Entry)

Total Number of Zones in Area 2 (New Program Only)

- Enter the total number of zones to be programmed for Area 2.
- Valid entries are from 00 to 48. Directly enter the total number of zones, including leading zeros.
- The system is based on groups of 4 zones each (after the first 8 zones), and will automatically round up to the next group of 4. For example, if you enter 18, it will automatically convert this to 20 zones. Press **SAVE** to save. Press the NEXT/YES button to proceed.

Fire Zones
Enter Zone # **

(Direct Entry)

Fire Zones in Area 1 (New Program Only)

- Enter the zone number of any Fire Zones (including 2-wire, 4-wire or wireless).
- Valid entries are from 01 to 48.
- Directly enter each zone number, including leading zeros, and press **SAVE** to save, and then repeat for any additional zone(s). Press the NEXT/YES button to proceed.

2-Wire Fire Zns
Enter Zone # **

(Direct Entry)

2-Wire Fire Zones in Area 1 (New Program Only)

- Enter the zone number of any Fire Zone (from previous question) to be used with 2-wire smoke detectors.
- Valid entries are 07 and 08. Directly enter each zone number, including leading zeros.
- Press **SAVE** to save, and repeat for any additional zone(s); press NEXT to proceed.

NOTE: Only zones which have been designated as Fire Zones can be programmed as 2 Wire Fire zones. JP3 must be set to "2-WF" position for 2-wire fire for zones 7-8. (refer to Installation Instructions).

Report All Zones
To Central? Y/N

(Press YES or NO)

Local or Central Station Reporting System (New Program Only)

Press the NEXT/YES button for all zones to report; press the PRIOR/NO button for local system.

Exit/Entry Zones
Enter Zone # XX

(Direct Entry)

Exit/Entry Zones in Area 1 (New Program Only)

- Enter the zone numbers of zones to be used as Exit/Entry zones.
 - Valid entries are from 01 to 48. Directly enter each zone number, including leading zeros.
 - Press **SAVE** to save and repeat for any additional zone(s); press the NEXT/YES button to proceed.
- NOTE:** Entry Delay Time of 30 seconds and Exit Delay Time of 60 seconds will automatically be programmed.

Interior Zones
Enter Zone # XX

(Direct Entry)

Interior Zones in Area 1 (New Program Only)

- Enter the zone numbers to be used as Interior Zones.
- Valid entries are from 01 to 48. Directly enter each zone number, including leading zeros.
- Press **SAVE** to save and then repeat for any additional zone(s).
- Press the NEXT/YES button to proceed.
- All Interior zones will also be automatically programmed as "Exit/Entry Follower" and as "Power Up Delay" zones.

24 Hour Zones
Enter Zone # **

(Direct Entry)

24 Hour Zones in Area 1 (New Program Only)

- Enter the zone numbers of zones to be used as 24 Hour zones.
 - Valid entries are from 01 to 48. Directly enter each zone number, including leading zeros.
 - Press **SAVE** to save and repeat for any additional zone(s); press the NEXT/YES button to proceed.
- NOTE:** 24 Hour Zones will automatically be programmed as audible (Burg Output).

Chime Zones
Enter Zone # **

(Direct Entry)

Chime Zones in Area 1 (New Program Only)

- Enter the zone numbers which are to be used as Chime Zones.
 - Valid entries are from 01 to 48. Directly enter each zone number, including leading zeros.
 - Press **SAVE** to save and then repeat for any additional zone(s), press the NEXT/YES button to proceed.
- NOTE:** A chime time of 2 seconds will be automatically programmed.



```
Chime 2 Zones
Enter Zone # **
```

(Direct Entry)

Chime 2 Zones in Area 1 (New Program Only)

- Enter the zone numbers which are to be used as Chime 2 Zones.
- Valid entries are from 01 to 48. Directly enter each zone number, including leading zeros.
- Press  to save and then repeat for any additional zone(s), Press the NEXT/YES button to proceed.

NOTE: A chime time of 2 seconds will be automatically programmed.
Chime 2 zones give a distinct pulsating tone when zone is faulted.

```
Exit/Entry2 Zones
Enter Zone # **
```

(Direct Entry)

Exit/Entry2 Zones in Area 1 (New Program Only)

- Enter the zone numbers of zones to be used as Exit/Entry zones.
- Valid entries are from 01 to 48. Directly enter each zone number, including leading zeros.
- Press  to save and repeat for any additional zone(s); press the NEXT/YES button to proceed.

NOTE: An Entry Delay Time of 30 sec. and an Exit Delay Time of 60 sec. will automatically be programmed.

```
50mS Loop Zones
Enter Zone # **
```

(Direct Entry)

50 mS Loop Response Zones (New Program Only)

- Enter the zone numbers of zones to have a 50mS loop response.
- Valid entries are from 01 to 08. Directly enter each zone number, including leading zeros.
- Press  to save and then repeat for any additional zone(s), Press the NEXT/YES button to proceed. **Note:** Only panel zones 01-08 can be programmed for Quick Loop Response. All other zones can be programmed via their respective EZM's (hardwire). **Note: 750mS is required for Loop Response time in UL installations.**

```
Aux Output Zones
Enter Zone # **
```

(Direct Entry)

Aux Output Activated on Alarm Zones (New Program Only)

- Enter the zone numbers of zones to activate the Aux Output upon alarm.
- Valid entries are from 01 to 48. Directly enter each zone number, including leading zeros.
- Press  to save and then repeat for any additional zone(s), Press the NEXT/YES button to proceed.

NOTE: An Aux Output Timeout of 15 minutes will automatically be programmed.

```
Sensor Watch Zns
Enter Zone # **
```

(Direct Entry)

Sensor Watch Zones (New Program Only)

- Enter the zone numbers of zones to be Sensor Watch zones.
- Valid entries are from 01 to 48. Directly enter each zone number, including leading zeros.
- Press  to save and then repeat for any additional zone(s), Press the NEXT/YES button to proceed.

NOTE: A Sensor Watch Time of 24 hours will automatically be programmed.

```
KP Sndr Alrm Zns
Enter Zone # **
```

(Direct Entry)

Keypad Sounder On Alarm Zones (New Program Only)

- Enter the zone numbers of all zones to activate the Keypad Sounder upon alarm.
- Valid entries are from 01 to 48. Directly enter each zone number, including leading zeros.
- Press  to save and then repeat for any additional zone(s), Press the NEXT/YES button to proceed.

```
Auto Byp REnt Zn
Enter Zone # **
```

(Direct Entry)

Auto Bypass Re-entry Zones (New Program Only) **(Not evaluated by UL)**

- Enter the zone numbers of zones to be Auto Bypass Re-entry zones.
- Valid entries are from 01 to 48. Directly enter each zone number, including leading zeros.
- Press  to save and then repeat for any additional zone(s), Press the NEXT/YES button to proceed.
- Auto Bypass Re-entry Zones allow the system to be armed with the zone faulted but come back into the system (armed) when the zone is subsequently closed.

```
Enable No EOLR
Zones Y/N
```

(Press YES or NO)

Enable No EOLR Zones (New Program Only)

- Press YES to program all zones except 24 Hr & fire zones for No End Of Line Resistor. Press NO to continue.
- Do not program this feature for UL Installations.

```
Enable Telco
Line Test? Y/N
```

(Press YES or NO)

Enable Telco Line Fault Test?

- Press YES to enable Telco Line Fault Test.
- Press NO to continue. **NOTE: If enabled, a Telco Line Fault Test Delay of 60 sec. will automatically be programmed.**

```
Enable Burg Out
Chirp? Y/N
```

(Press YES or NO)

Enable Burg Output Chirp on KeyFob?

- Press the NEXT/YES button to enable Burg Output Chirp on KeyFob Arm / Disarm.
 - Press the PRIOR/NO button to continue.
- NOTE:** The Burg Output will chirp once on Keyfob Arm and twice on Keyfob Disarm.



Enable SIA CP-01?
Y/N

(Press YES or NO)

Enable SIA CP-01 Features?

- Press the NEXT/YES button to enable.
- Press the PRIOR/NO button to continue.

The SIA CP-01 Features are designed to reduce the incidence of false alarms. **NOTE:** Do not enable unless reporting, otherwise system trouble *Fail to Communicate* may occur.

Area 1 Keypads
Enter # KPs 01

(Direct Entry)

Number of Keypads in Area 1

- Enter the total number of Keypads to be installed in Area 1.
 - Valid entries are from 01 to 07. Directly enter the number of keypads, including leading zeros.
- Press  to save. Press the NEXT/YES button to proceed.

Area 2 Keypads
Enter # KPs 00

(Direct Entry)















Number of Keypads in Area 2

- Enter the total number of Keypads to be installed in Area 2.
 - Valid entries are from 00 to 07. Directly enter the number of keypads, including leading zeros.
- Press  to save. Press the NEXT/YES button to proceed. **NOTE:** Area 2 keypads must have zones in Area 2, otherwise the keypad will indicate "Out Of System".

Central Phone #

(Direct Entry)









Central Station Receiver 1 Telephone Number

- Enter telephone number of up to 16 digits.
- Press  through  for digits 1-9;   for a zero and  for a blank (*).
- Press   through   for letters B-F, respectively.
- Pre-Dial Delay = "D" ( ); Dial-Tone Detection = "E" ( .
- Press  to save and press the NEXT/YES button to proceed.



NOTE: Central Station Receiver 2 and 3 Telephone Numbers must be entered in Direct Address Programming. See CS Receiver Options.

Easy Programming of Auto download ID #'s and PC Preset Callback Numbers (GEM-RP1CAe2 or GEM-K1CA keypads only) from the Central Station Telephone number.

For unattended PC Preset downloading, it is now possible to set the Auto download ID #'s and PC Preset Callback from the Keypad Easy Program Mode.

- At the field for CENTRAL PHONE #, program an "F" followed by the Auto Download ID # (2 digits) and then the Callback Telco # (up to 13 digits).
- Press  or  to save.
- Exit Program Mode ( 
- Enter Master Code
- Press  or 
- Go to Function "ACTIVATE DOWNLOAD Y/N" and press YES ( or .
- The panel will automatically call the PC Preset computer and download the program on the specified Auto Download line # of PC Preset. Example: Program an Auto download ID # of 07 and a PC Preset Callback # of 1-516-842-9400

CENTRAL PHONE #
F0715168429400

- Go to Central Phone # input screen and press: [*] [5] [0] [7] [1] [5] [1] [6] [8] [4] [2] [9] [4] [0] [0]  (or ).

**Central Station
Account # (____)**

(Direct Entry)

Central Station Receiver 1 Account Number

- Enter an account number of up to four digits.
- Press through , and for a blank (*).
- Press to save and press the NEXT/YES button to proceed.

NOTE: Central Station Receiver 2 and 3 Account Numbers must be entered in Direct Address Programming. See CS Reporting Options.

**See WI for Info
Rcvr Format (0)**

(Direct Entry)

Central Station Receiver 1 Format

- From the table at the right enter the receiver format.
- Press through , and for blank (*).
- Press through for letters B–E.
- Press to save and press the NEXT/YES button to proceed.

DATA ENTRY	CS RECEIVER 1 FORMAT
blank(*)	Ademco Slow, Silent Knight Slow
1	Sescoa, Vertex, DCI, Franklin Fast
2	Radionics Fast
3	Silent Knight Fast
4	Radionics, DCI, Franklin Slow
5	Universal High Speed
8	Radionics BFSK

DATA ENTRY	CS RECEIVER 1 FORMAT
9	FBI 4/3/1
0	Radionics Modem 2
B	SIA
C	Ademco Point ID
D	Ademco Express
E	Pager

NOTE: Modem IIe is available only in Direct Address Programming. Central Station Receiver 2 and 3 Formats can only be entered in Direct Address Programming. See CS Receiver Options.



Enter user code
001 123 -E3-

User# User Code

Enter User Codes (Press the **MENU** button to set cursor.)

Enter up to 48 User Codes with User Options, Authority Level and Access Control Options (if necessary) for each code. Refer to the tables below and on the next page for available data entries for User Options, Authority Level and Access Control Options. **Note:** All 48 Users must be assigned to areas in "User Area Options" (Address 2455-2502) in Direct Address Programming. By default, only User 1 is enabled in Area 1 and Area 2. Users 2 - 8 are enabled in Area 1 and users 9 - 16 are enabled in Area 2.

Press the **MENU** button to set the cursor to the User Code. Use the number buttons **1** through **9P** to enter a code from 3 to 6 digits. Enter up to 6 digits in the first six boxes from left to right for each user code. Valid entries are: 0-9. **Note:** Press the **0** button for a zero. No blank spaces in between; leave blank (*) any trailing boxes. If an "Ambush Code" (Address 0495) is entered, *do not* program the first two digits of ANY User Code as the same digits entered for the "Ambush Code".

If the programmed code is less than 6 digits, press the **MENU** button to set the cursor to the OPTION/LEVEL.

Refer to the tables below for the available User Option and User Level data entries. Enter the user options data in the left digit. Enter the level data (with arming options, if any, added) in the right digit. **Note:** For entries greater than 9, press the ***** **1** buttons through the ***** **5** buttons for B through F, respectively.

For Keypad Access Control, press the **MENU** button once again to program applicable keypads. Refer to the tables below, use the number buttons to enter the data for Keypad 1-4 in the right digit; and the data for Keypad 5-7 data in the left digit. (Press the **0** buttons for blank).

Example: Enter a code of "123456" as "123456" (from left to right).

USER OPTIONS			
USER CODE (UP TO 6 DIGITS)	USER OPTION	USER LEVEL	ACCESS CONTROL KEYPADS

USER OPTIONS				
DATA ENTRIES	BLOCKED VIEW	USER PROGRAM	BYPASS	OVERVIEW
blank (*)	DISABLED			
1	Y			
2		Y		
3	Y	Y		
4			Y	
5	Y		Y	
6		Y	Y	
7	Y	Y	Y	
8				Y
9	Y			Y
0		Y		Y
B	Y	Y		Y
C			Y	Y
D	Y		Y	Y
E		Y	Y	Y
F	Y	Y	Y	Y

DATA ENTRIES	AUTHORITY LEVEL	CODE TYPE
blank (*)	NONE	ARM/DISARM
1	LEVEL 1	ARM/DISARM
2	LEVEL 2	ARM/DISARM
3	LEVEL 3	ARM/DISARM
4	NONE	ARM ONLY
5	LEVEL 1	ARM ONLY
6	LEVEL 2	ARM ONLY
7	LEVEL 3	ARM ONLY
8	NONE	SERVICE
9	LEVEL 1	SERVICE
0	LEVEL 2	SERVICE
B	LEVEL 3	SERVICE
C*	NONE	AMBUSH
D*	LEVEL 1	AMBUSH
E*	LEVEL 2	AMBUSH
F*	LEVEL 3	AMBUSH

ACCESS CONTROL KEYPADS			
DATA ENTRIES	K.P. 5	K.P. 6	K.P. 7
blank (*)	NONE		
1	Y		
2		Y	
3	Y	Y	
4			Y
5	Y		Y
6		Y	Y
7	Y	Y	Y
8			
9	Y		
0		Y	
B	Y	Y	
C			Y
D	Y		Y
E		Y	Y
F	Y	Y	Y

ACCESS CONTROL KEYPADS				
DATA ENTRIES	K.P. 1	K.P. 2	K.P. 3	K.P. 4
blank (*)	NONE			
1	Y			
2		Y		
3	Y	Y		
4			Y	
5	Y		Y	
6		Y	Y	
7	Y	Y	Y	
8				Y
9	Y			Y
0		Y		Y
B	Y	Y		Y
C			Y	Y
D	Y		Y	Y
E		Y	Y	Y
F	Y	Y	Y	Y

Note: "Y" indicates option is enabled.

***Note:** These entries are only available when address 3905 option 8 is enabled.

Note: "Y" indicates option is enabled.

Note: "Y" indicates option is enabled.



USER AUTHORITY LEVEL	
KEYPAD DISPLAY FUNCTION MENU	
FUNCTION	LEVEL*
DISPLAY ZN FAULTS	1
DISPLAY ZN BYPASSED	1
DISPLAY ZN DIRECTORY	1
ACTIVATE BELL TEST	1
DISPLAY PHONE #S	1
DISPLAY SYS TRBL	1
DISPLAY FIRE ALARM	1
DISPLAY FIRE TRBL	1
DISPLAY OP/CL	3
ACTIVATE OVERVIEW	3**
ACTIVATE CHIME	1
ACTIVATE WATCH	2
RESET SYSTEM TRBL	3
RESET SENSOR MSG	3
START EXIT TIME	1
FAULT FIND	***
ACTIVATE LOCATE	***
EZM ZONE FIND	***
ACTIVATE DIALER TEST	3
DISPLAY ALARM LOG	3
DISPLAY TOTAL LOG	3
DISPLAY FIRE LOG	3
DISPLAY OP/CL LOG	3
DISPLAY SYSTEM LOG	3
AUTOARM IN 1-4HRS	2
DISPLAY AUTOARM SCHD	3
ACTIVATE PROGRAM	3**
ACTIVATE DOWNLOAD	3
DISPLY RF XMITTER STAT	1
RELAY CONTROL	1

NOTES:

- * Minimum Level required to access function
- ** Level-3 Code with appropriate user option
- *** Requires Dealer Code



USER OPTIONS	
OPTIONS	EXPLANATION
Disabled	User Code not active in this area.
Blocked View	Allows User Code to block another code from being viewed by another user. An unblocked code cannot view a blocked code, but a blocked code can view all codes. The master user code and the dealer program code can view all codes.
User Program	User Program Option is enabled for Keypad 1 only, wherever it is connected (any area). If enabled, Level 3 must also be enabled.
Bypass	Allows User Code to bypass zones.
Overview	This option, along with Level 3 Authorization, enables selection of OVERVIEW mode at a keypad. This Mode provides a system status display of all areas at a glance.
Arm Only	Prevents User Code from disarming this area.
Service	A Service Code has restricted arm/disarm rights; if an area is armed with a Service Code, a "5" appears on the GEM-RP1CAe2 keypad and the area can be disarmed with any valid User Code, including a Service Code. If the area is armed with OTHER than a Service Code, it CANNOT be disarmed with a Service Code. This is typically used to allow tradesmen access to premises under control of the owner.
Ambush	There are two types of Ambush Codes: (1) A 2-digit code (prefix) that is entered immediately prior to (and as part of) the regular User Code and (2) A separate and unique User Code. Disarming with an Ambush Code will cause a silent report to be sent to a central station. Thus, should a user be forced to disarm, he can silently signal an emergency while appearing to be merely disarming the system.
Access	This is normally used to activate a door striker while an area is disarmed. A code with the access option will not function as an arm/disarm code. When the code is entered, the keypad will display "ENTER NOW" and the Brown Wire on the keypad will become Active Low (Ground Potential) for 7 seconds.

Related User Options: "Ambush Code" (Address 0495), "Panel Access Code" (Address 0490), "Dealer Security Code" (Address 0500) & "User Area Options" (Address 2455-2502).

 Press  to save each code.

To proceed to the next User Code, set the cursor to the User Number and change it using the number buttons. Program a new User Code as previously described. Press NEXT  button to proceed.

Example: Program a code of "2222" for user 02, with User Option of "User Program", User "Level 3" and Access Control Option "Keypad No. 1". Enter "2222" for a user code, "2 3" for user option and "blank(*) 1" for access control option.

CHANGING OR CANCELING A CODE: To change any code, merely program over the existing code as described above and press  to save. Similarly, to cancel a code, blank out each number of the code and press  to save to save.



Enter user code
 001 123456- 6-

User# User Code

Enter Proximity Card Users (FOR ACM USE ONLY).

(Press the **MENU** button to set cursor). See WI1221 for more information.

Enter up to 48 Proximity Cards with User Options, Access Level and ACM Area (if necessary) for each card. Refer to the tables below and to WI1221 for more information.

Press the **MENU** button to set the cursor to the User Code. Use the number buttons **1** through **9P** to enter a 6 digit code. Enter the digits in the first six boxes from left to right for each user code. Valid entries are: 0-9. **Note:** Press the **0** button for a zero. No blank spaces in between; leave blank (*) any trailing boxes.

Refer to the tables below and WI1221 for the available User Level data entries. Enter the level data in the right digit. Leave blank (*) in the left digit. **Note:** For entries greater than 9, press the ***** **1** buttons through the ***** **5** buttons for B through F, respectively.

For ACM Area, enter data for Areas 1 or 2. See table below.

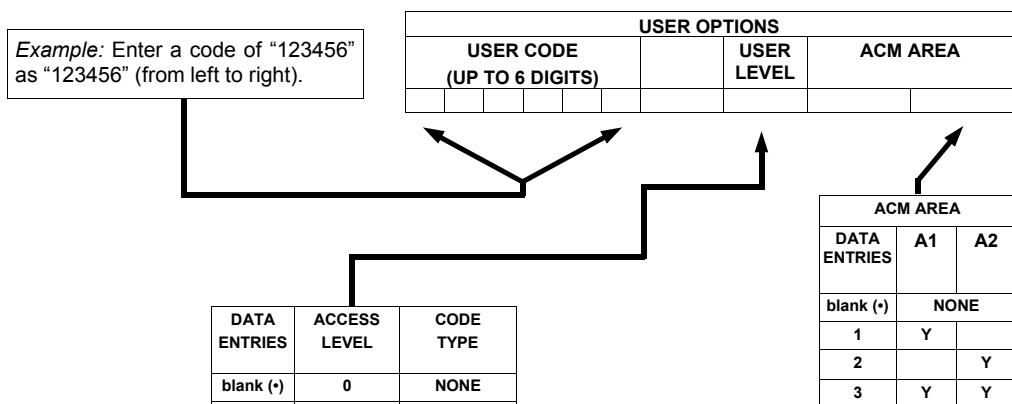

Note: "Y" indicates option is enabled.















```
ZN#   XMIT#+CS P
Zn01- 000000:0-0
```

Zone # Xmitter Check Point
Mapped to ID Sum #

RF Transmitter Points (Press  to set cursor.)

For each transmitter enter: (For wireless systems only. Also see Quick Method, which follows)

- The **zone number** (01–48) to which the transmitter will be mapped.
- The **6-digit RF ID #** and **1-digit checksum number** printed on the transmitter and box,
- The **point number** (1–2); enter “9” for *unsupervised* (all points).
- Press  to save and NEXT/YES button to proceed when all transmitters have been entered.

NOTE: When programming the ID Code number, “0” through “9” =  through  ; A =   ; B =   ; C =   ; D =   ; E =   and “F” =  .

Quick Method (Enroll Method).

If a receiver is already installed in the panel, transmitter wireless points can be programmed automatically (“enrolled”) using the following procedure. **NOTE:** The transmitter point will be enrolled only if the signal strength is 3 or greater.

```
ZN#   XMIT#+CS P
Zn01- 000000:0-0
```

```
ZN#   XMIT#+CS P
ZN01- ENROLL:A--
```

1. Enter the zone number to which the transmitter point will be mapped.
2. Press  to enter the Enroll Mode. The red and green LEDs on the keypad will flash and the window will display as shown at left.
3. Open the loop of the point that is to be programmed (GEM-TRANS2 only).
4. Install the transmitter battery. The keypad will beep to indicate that the point has been successfully enrolled. Multi-point transmitters can be mapped to successive zones simultaneously.

Example. A 2-point transmitter has the RF ID number 287613:1. Map point 1 to Zone 6 and point 2 to Zone 9.

1. Enter the Enroll mode as described above.
2. Enter Zone “06”.
3. Open point-1 loop.
4. Install the battery. The keypad will beep once to indicate that one point has been programmed. (Transmitter 287613:1, point 1 will be mapped

- to Zone 6).
5. Enter Zone “09”.
6. Close point-1 loop and open point-2 loop.
7. Remove the transmitter battery, then re-install it. The keypad will beep once to indicate that one point has been programmed. (Transmitter 287613:1, point 2 is mapped to Zone 9).

KEYFOB ZONE ASSIGNMENT: Keyfobs can also be assigned to zones to allow multiple wireless panic buttons on one alarm system, each reporting to a central station, a pager or having a description on the keypad that describes the person holding the keyfob, the location where the person holding the keyfob is stationed, or the special purpose of the keyfob button being depressed. See the next page on *Keyfob Transmitters as Zone Input Devices*.















```
KF A XMIT#+CS OP
01-0 000000:0 00
```

KF Area Xmitter Check Aux
ID Sum 1&2

Keyfob Transmitters as Arm/Disarm & Control Devices (Press  to set cursor.)

Keyfobs can be programmed as “Arm/Disarm” devices using their On/Off buttons (refer to WI752). For each Keyfob Transmitter, enter:

- The **Keyfob Transmitter number** (01–08).
- The **area number** to which transmitter is assigned (0 to disable keyfob, 1 or 2).
- The **6-digit RF ID #** and **1-digit checksum number** printed on the transmitter and box,
- The **Aux 1 Option** (see keyfob aux 1 & aux 2 options).
- The **Aux 2 Option** (see keyfob aux 1 & aux 2 options).
- **NOTE:** Keyfobs 1-8 report openings and closings as Users 25-32.
- Press  to save and NEXT/YES button to proceed when all keyfobs have been entered.

NOTE: When programming the ID Code number, “0” through “9” =  through  ; A =   ; B =   ; C =   ; D =   ; E =   and “F” =  .



KeyFob Transmitters as Zone Input Devices

(Refer to display above: press the PRIOR button to go backwards).

Each of the 4 keyfob buttons can be assigned to a zone. For example, On button = point 1; Off button = point 2; A1 = point 3; A2 = point 4. Up to 48 keyfobs (using 1 button) or 24 keyfobs (using 2 buttons) or 14 keyfobs (using all 4 buttons) or any combination up to a maximum of 48 controlled zones can be assigned, providing multiple wireless panic buttons on a system, each reporting to a Central Station or a pager and/or annunciating on a keypad the keyfob zone number with a description. *To assign a keyfob to a zone:* program the keyfob as you would a transmitter, entering the keyfob's ID code, check sum and point number at the appropriate zone. The "Quick Method" is not allowed. The zone may be hardwired to an electrical sensor as well as assigned to a keyfob (either one will activate the zone alarm output). **NOTE:** If assigning a keyfob to a zone, the "ON/OFF" buttons on the keyfob will no longer arm/disarm the system. The keyfob is converted to a "panic only" device.

DATA ENTRY	AUX 1/AUX 2 OPTIONS
0	None
1	Relay Group 1 Toggle
2	Relay Group 2 Toggle
9	Panic
A	Auxiliary
B	Instant
C	Aux. Output Toggle
D	Access on Aux. Output
E	Arm STAY ("K Series" Keypads Only)
F	Interior Bypass ("Classic" RP Series)

001-

(Direct Entry)

Enter Zone Descriptions

- Press and to place the cursor and; press and to select the character.
- For each zone, enter a description of up to two lines.
- Press to save each description.

- To proceed to the next description, place the cursor under the Zone Number (e.g. "01") and change the Zone Number using and . Program new description as above.
- NOTE:** Zone Descriptions can only be entered through the GEM-RP1CAe2 Keypad or by using the Napco Quickloader Software. See Easy Menu Programming Worksheet for available zone description characters.

Enter Date
(/ /)

(Direct Entry)

Enter Date (Press to set cursor).

- Enter the current date in the format MM/DD/YY. (MM = month, DD = day and YY = year.
- Press to save. Press the NEXT/YES button to proceed.

Enter Time
(:)

(Direct Entry)

Enter Time (Press to set cursor.)

- Enter the current time in format HH:MMA/P, where HH=hours (01-12); MM=minutes (00-59).
- Select AM or PM by pressing any number button to toggle selection.
- Press to save. Press the NEXT/YES button to proceed.

Dealer Code
456789

Dealer Code

- Directly enter the Dealer Code (default = 456789), using through buttons.
- Press to save.
- Re-enter the Dealer Code to verify the previous code.
- Press to save.
- Press the NEXT/YES button to proceed.

DEALER CODE
RE-ENTER

EXIT DEALER PROGRAM MODE: This completes the custom default program. Press to enter the Direct Address Program Mode for further programming or press once again to end all programming and resume normal keypad operation.

CLEAR PROGRAM: Should it be necessary to create a new custom default program, (a) from the Dealer Program Mode, press to enter the Address Program Mode; (b) access Location 4091 (Clear Program) or 4093 (Cold Start); (c) press and then (d) press to exit the Dealer Program Mode. A "SYSTEM TROUBLE/ED9-00 SERVICE" will occur. Press to silence the keypad.

4091 XX H

Clear Dealer Program (Erases Dealer Program)

Use this feature to erase the Panel Program, while maintaining Scheduled Data and Zone Descriptions. Access address 4091 and press . Data entry is not allowed. **NOTE:** Enter Easy Menu Driven Program Mode to reprogram system.

4093 XX H

Cold Start (Erases Entire Program)

This erases all programmed data (Dealer Program, Zone Description Data and Schedules). Access address 4093 and press . Data entry is not allowed. **NOTE:** Some features (schedules) can only be programmed again with the Downloading Software.



DIRECT ADDRESS PROGRAM MODE

DIRECT ADDRESS OVERVIEW

Direct Address Programming allows you to go directly to the address locations (up to 4095) and change the data entries manually in order to customize your control panel options. Whereas the Easy Menu Program Mode guides you through limited selections to get you started, **Direct Address Program Mode** allows you to change all options directly. It consists of up to 4095 address locations each with data entry locations as shown in the following diagram (below left). The data entry location accepts data in one of three formats: Binary, Decimal and Hexadecimal (explained below in "Address Mode Displays"). The following diagram (below right) illustrates a *Decimal* format data entry location (using a GEM-RP1CAe2/GEM-K1CA keypad).

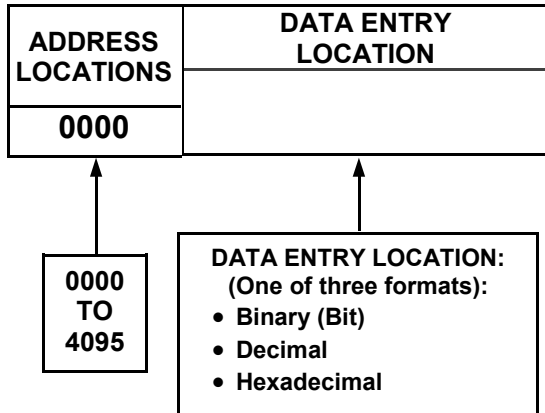

GEM-RP1CAe2/GEM-K1CA Keypad Display Example

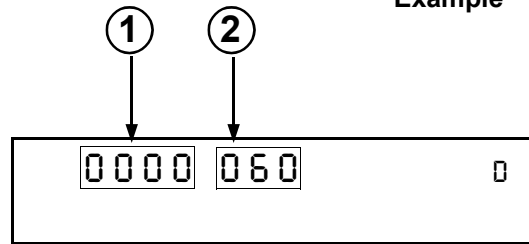

- ① = ADDRESS LOCATION
- ② = DATA ENTRY LOCATION

ADDRESS MODE DISPLAYS

There are three types of address displays when programming in Direct Entry Program Mode, as follows:

A) Binary (Bit) Format

Settings (such as Zone Features) display and accept data in "number" format. For example, Zone Features are turned on by the pressing of keypad buttons 1 through 8, with the activated Zone(s) displaying the corresponding decimal digit (replacing deactivated zones which are signified by dashes).

EXAMPLE: BIT Format with the GEM-RP1CAe2/GEM-K1CA: Program Zones 2, 4, 5 and 7 as *Exit/Entry Follower Zones*.

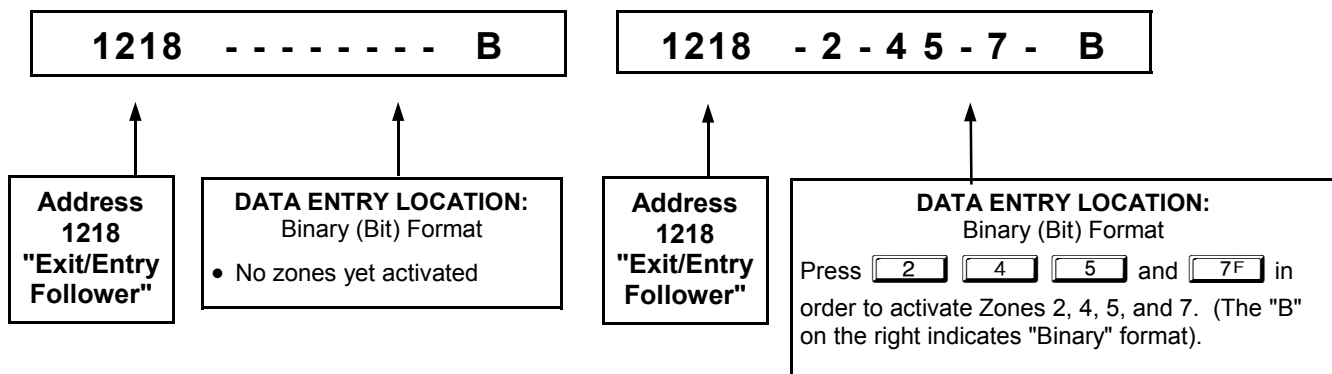

DETERMINE THE DATA ENTRIES

Referring to ZONE FEATURES in the Programming Worksheets that follow, the Exit/Entry Follower for Zones 1 through 8 are located at address 1218.

DIRECT ADDRESS PROGRAM MODE



ZONE FEATURES	ADDR	ZONES 1 → 8								ADDR	ZONES 9 → 16							
		Z1	Z2	Z3	Z4	Z5	Z6	Z7	Z8		Z9	Z10	Z11	Z12	Z13	Z14	Z15	Z16
		1	2	3	4	5	6	7	8		1	2	3	4	5	6	7	8
Exit/Entry Follower	1218						6	7	8	1318								

PROGRAM THE DATA ENTRIES

1. Enter the panel's Dealer Security Code, then press **[MENU]**.
2. Answer NO to all questions until "ACTIVATE PROGRAM Y/N" is displayed; then press YES. **NOTE:** If you pass "ACTIVATE PROGRAM", scroll backward using **[BYPASS]**.
3. Press **[RESET]** to enter the Address Program Mode. Address "0000" will display.
4. Press **[1] [2] [1] [8A]** to access Address 1218. *The existing data will display and the cursor will advance to the data field.*
5. Press **[6] [7F] [8A]**. The numbers 6,7 and 8 will appear on the keypad display indicating the zones activated.
6. Press **[ENTER]** to save. Address 1218 is now programmed with "6,7,8".
7. Press **[MENU]** and enter another 4-digit address to continue programming--or--press **[RESET]** to exit and resume normal keypad operation.

B) Decimal Format

Settings (such as Entry and Exit Delay) display and accept data in decimal format, as a 3 digit number. Data is entered directly, by pressing keys 0 – 9, with the cursor automatically moving to the right upon each key press.

EXAMPLE: DECIMAL Format with the GEM-RP1CAe2/GEM-K1CA: Program *Abort Delay* to be 15 seconds.

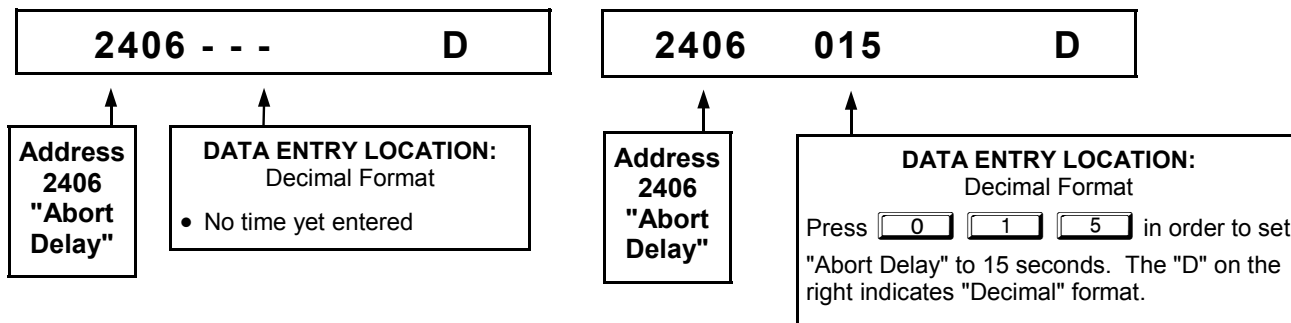

DETERMINE THE DATA ENTRIES

Referring to SYSTEM DELAYS & TIMEOUTS in the Programming Worksheets that follow, the Abort Delay is located at address 2406:

ABORT DELAY (sec.)	ADDRESS 2406		

[Default = 000]

PROGRAM THE DATA ENTRIES



1. Enter the panel's Dealer Security Code, then press **[MENU]**.
2. Answer NO to all questions until "ACTIVATE PROGRAM Y/N" is displayed; then press YES. **NOTE:** If you pass "ACTIVATE PROGRAM", scroll backward using **[BYPASS]**.
3. Press **[RESET]** to enter the Address Program Mode. Address "0000" will display.
4. Press **[2] [4] [0] [6]** to access Address 2406. *The existing data will display and the cursor will*

advance to the data field.

5. Press . The numbers 015 will appear on the keypad display indicating the number of seconds entered.
6. Press to save. Address 2406 is now programmed with a 15-second Abort Delay.
7. Enter another 4-digit address to continue programming or press to exit and resume normal keypad operation.

C) Hexadecimal Format

Data such as Report Codes displays, accepts data by means of a Hexadecimal display. Data is entered directly, by pressing keys 1 – 9, for zero, and through for hex B through F (11-15), with the cursor automatically moving to the right upon key press. See table below.

HEXADECIMAL ENTRIES					
ENTRY TOTAL	PRESS 	KEYPAD DISPLAYS	ENTRY TOTAL	PRESS 	KEYPAD DISPLAYS
blank	<input type="text" value="0"/>	•	8	<input type="text" value="8A"/>	8
1	<input type="text" value="1"/>	1	9	<input type="text" value="9P"/>	9
2	<input type="text" value="2"/>	2	10	<input type="text" value="*"/> <input type="text" value="0"/>	0
3	<input type="text" value="3"/>	3	11	<input type="text" value="*"/> <input type="text" value="1"/>	B
4	<input type="text" value="4"/>	4	12	<input type="text" value="*"/> <input type="text" value="2"/>	C
5	<input type="text" value="5"/>	5	13	<input type="text" value="*"/> <input type="text" value="3"/>	D
6	<input type="text" value="6"/>	6	14	<input type="text" value="*"/> <input type="text" value="4"/>	E
7	<input type="text" value="7F"/>	7	15	<input type="text" value="*"/> <input type="text" value="5"/>	F

EXAMPLE: HEXADECIMAL Format with the GEM-RP1CAe2/GEM-K1CA: Program an Ambush CS Reporting Code to be "1B".

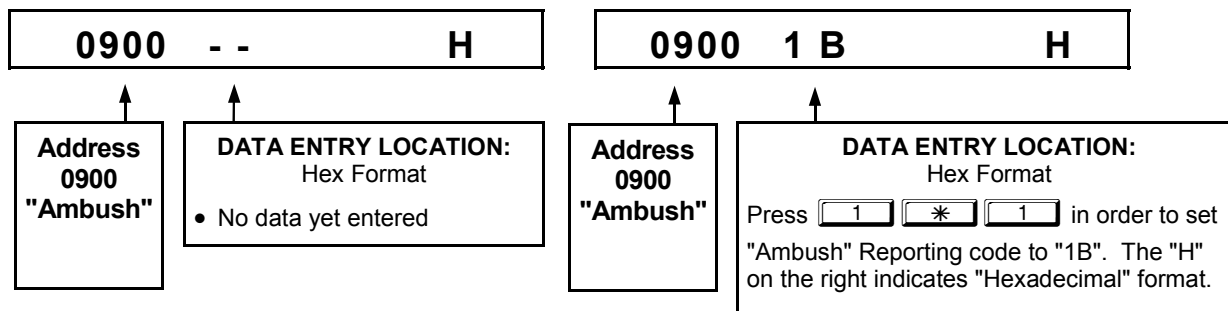

DETERMINE THE DATA ENTRIES

Referring to CS REPORTING CODES in the Programming Worksheets that follow, Ambush is located at address 0900. In the "Keypad Reporting Codes" table, the data entries needed to assign a code of "1B" are and .

KEYPAD REPORTING CODES	ADDRESS 0900-0904		
	LEFT	ADDR	RIGHT
Ambush	1	0900	B
Panic		0901	
Fire		0902	
Auxiliary		0903	
Tamper		0904	



PROGRAM THE DATA ENTRIES

1. Enter the panel's Dealer Security Code, then press **MENU**.
2. Answer NO to all questions until "ACTIVATE PROGRAM Y/N" is displayed; then press YES. **NOTE:** If you pass "ACTIVATE PROGRAM", scroll backward using **BYPASS**.
3. Press **RESET** to enter the Address Program Mode. Address "0000" will display.
4. Press **0** **9P** **0** **0** to access Address 0900. *The existing data will display and the cursor will advance to the data field.*
5. Since you wish the reporting code to be "1B", press **1** to enter a "1" in the display, and press ***** **1** to enter a "B" in the display. **NOTE:** The right address is reported first, therefore, in the address table, the right digit is the 1st digit of the reporting code ("1" in this example).
6. Press **SAVE** to save. Address 0900 is now programmed with an Ambush reporting code of "1B".
7. Press **MENU** and enter another 4-digit address to continue programming--or--press **RESET** to exit and resume normal keypad operation.

PROGRAMMING CONVENTIONS USED IN THIS MANUAL

The Keypad Programming Worksheets that follow are provided as an address-programming reference to help the installer modify his custom default program or to make minor field alterations to an existing panel program. It is recommended that the panel be uploaded to NAPCO's PCD-Windows software following any keypad programming and that the PCD-Windows's error-check feature be utilized to reduce the possibility of programming omissions or conflicts.

Keep the Keypad Programming Worksheets on file for future reference.

General Programming Steps

1. Contact the central station to ascertain receiver format, data format, event codes, subscriber numbers and telephone number(s).
2. Select the desired features by writing in (pencil recommended) the respective "address" boxes. Refer to the Programming Options and Worksheets for guidance in selecting the "data" to be entered into those boxes.
3. Program the data entered in the boxes on the worksheets into the respective addresses. The display will show the entry numerically, but if hexadecimal format will display "0" for the number 10, and letters "B", "C", "D", "E", and "F" for the numbers 11 through 15, respectively. To program a 10, press ***** **0**. To program 11 through 15, press ***** **1** through ***** **5**, respectively.

The displays will appear after a brief delay.

- Use **MENU** to toggle the cursor between the 4-digit address field and the data entry locations.
- Enter the address directly using the number buttons.
- The contents of the address will be read automatically, along with the feature name and programming information. The cursor will advance to the data field. Enter the required data directly using the number buttons.
- IMPORTANT:** Press **SAVE** or **OFF** to save the contents of each address.

EXIT DIRECT ADDRESS PROGRAM MODE: When done, press **RESET** to exit and resume normal keypad operation.

SYSTEM DELAYS & TIMEOUTS (ADDRESS 0000-0002, 2402, 2406, 2414 & 3902)

EXIT DELAY (sec.)	ADDRESS 0000			
-------------------------	---------------------	--	--	--

[Default = 060]

ENTRY DELAY 1 (sec.)	ADDRESS 0001			
----------------------------	---------------------	--	--	--

[Default = 030]

ENTRY DELAY 2 (sec.)	ADDRESS 0002			
----------------------------	---------------------	--	--	--

[Default = 030]

Aux. Output Access Control Timeout (sec.)	ADDRESS 2402			
--	---------------------	--	--	--

[Default = 000]

ABORT DELAY (sec.)	ADDRESS 2406			
--------------------------	---------------------	--	--	--

[Default = 000]

Telephone Line Test Delay (x15 sec.)	ADDRESS 2414			
---	---------------------	--	--	--

[Default = 000]

CS Telco 3 Report Delay (sec.)	ADDRESS 3902			
---	---------------------	--	--	--

[Default = 000]

 Select delay/timeout (0-255 seconds).

EXIT/ENTRY DELAYS: Apply only to zones programmed with the following options "Exit/Entry 1, Exit/Entry 2, Exit/Entry Follower". For UL Installations, the maximum exit delay is 60 seconds and the maximum entry delay is 45 seconds. **NOTE:** Sensor Watch Time Options are similar to above table, except in hours.

 Press  or  to save.

WARNING: Timers have uncertainty of +/-1 sec, so a "time" of 1 second may actually timeout IMMEDIATELY.

SYSTEM DELAYS & TIMEOUTS (ADDRESS 2407, 2408 & 4088)

CHIME TIME (¼sec.)	ADDRESS 2407			
--------------------------	---------------------	--	--	--

[Default = 008 x ¼ sec. = 2 sec.]

AC Fail Report Delay (x10 min.)	ADDRESS 2408			
---------------------------------------	---------------------	--	--	--

[Default = 008]

Sensor Watch Delay (Hr.)	ADDRESS 4088			
-----------------------------	---------------------	--	--	--

[Default = 024]

-  1. Enter delay/timeout in corresponding address locations above.
Note: All entries for address 2407 are in quarter seconds (.25 seconds).
 Therefore, the default of 008 results in a 2 second timeout.

 2. Press  or  to save.

SYSTEM DELAYS/TIMEOUTS



SYSTEM DELAYS & TIMEOUTS (ADDRESS 2400, 2401, 2403-2405, 4082 & 4083)

Reset Output Timeout (min.)	ADDRESS 2400		

[Default = 000]

Aux. Output Timeout (min.)	ADDRESS 2401		

[Default = 000]

Burg. Alarm Output Timeout (min.)	ADDRESS 2403		

[Default = 015]

Pulse Alarm Output Timeout (min.)	ADDRESS 2404		

[Default = 015]

Fire Output Timeout (min.)	ADDRESS 2405		

[Default = 000]

1. Select delay/timeout (0-255 min.).
2. Enter in corresponding address locations above and right.
3. Press or to save.

Report Cancel Window (min or sec.)	ADDRESS 4082		

[Default = 000]
 V.1 or less = sec.
 V.3 or greater = min.
 Program for at least 5 minutes in a CP-01 installation.*

OUTPUT TIMEOUTS: If a timeout of "0 min." is selected, then the output will remain active (ON) until the system is reset or disarmed. For UL Residential Installations, the minimum timeout is 4 minutes. For UL Commercial Installations, the minimum timeout is 15 minutes.

Auto Disarm Rearm Delay (min.)	ADDRESS 4083		

[Default = 000]

*Address 4082: When "Enable CP-01 Features" is selected in the Easy Program menu, this time is set to 7 minutes.

KEYPAD SYSTEM CODES (ADDRESS 0490-0495 & 0500-0502)

Panel Access Code	ADDRESS 0490-0492					
	0490		0491		0492	
	L	R	L	R	L	R

[Default = blank (*) blank (*) from address 0490-0492]

PANEL ACCESS CODE: Enter up to 6 digits to activate a door strike while the area is disarmed.

1. Enter in both left and right digits of address locations.
2. Valid entries are: 0-9.

Note: Also, "Access Control on Aux. Output" (Address 2418) and "Aux. Output Access Control Timeout" (Address 2402) must both be enabled.

Ambush Code	ADDRESS 0495	
	LEFT	RIGHT

[Default = 99]

AMBUSH CODE: Enter a 2-digit code used just prior to disarming and will activate an Ambush Condition, causing a SILENT report to be sent to the central station.

1. Enter in both left and right digits of address locations.
2. Valid entries are: 0-9.

Note: Also, "Enable Keypad Ambush" (Address 2440-2446), "Report on Ambush Alarm" (Address 1125, 1127, 1135 & 1137) must be enabled and "Ambush Reporting Code" (Address 0900) must be provided.

Dealer Security Code	ADDRESS 0500-0502					
	0500		0501		0502	
	L	R	L	R	L	R

[Default = blank (*) blank (*) from address 0500-0502]

DEALER SECURITY CODE: Enter up to 6 digits to be used by the dealer to enter programming.

1. Enter in both left and right digits of address locations.
2. Valid entries are: 0-9.

Note: If left blank, the Master Security Code must then be used to enter programming.

CS RECEIVER FORMAT OPTIONS (ADDRESS 0520, 0521, 0525, 0526, 0550, 0551, 0575 & 0576)

CS Receiver 1 Format	ADDRESS 0525	

CS Receiver 2 Format	ADDRESS 0550	

CS Receiver 3 Format	ADDRESS 0575	

Default for CS Receiver 1 Format depends on Easy Menu Question "RCVR FORMAT". [Default = •(blank) E] for CS Receivers 1, 2 and 3 Formats.

DATA ENTRIES		CS RECEIVER FORMATS
LEFT	RIGHT	
blank (*)	blank (*)	Ademco Slow, Silent Knight Slow
blank (*)	1	Sescoa, Vertex, DCI, Franklin Fast
blank (*)	2	Radionics Fast
blank (*)	3	Silent Knight Fast
blank (*)	4	Radionics, DCI, Franklin Slow
blank (*)	5	Universal High Speed
blank (*)	8	Radionics BFSK
blank (*)	9	FBI 4/3/1
blank (*)	0	Radionics Modem 2
blank (*)	B	SIA
blank (*)	C	Ademco Point ID
blank (*)	D	Ademco Express
blank (*)	E	Pager
blank (*)	F	Disabled
1	blank (*)	Radionics Modem IIe

CS RECEIVER FORMATS: Up to 3 CS Formats may be programmed.

- Select the desired CS Receiver Format from the table shown.
- Enter in the corresponding digit address locations for each CS Receiver.

NOTE: Dark shaded data value box shows option not available.



Leading Digits for Pager Format (1st Digit)	ADDRESS 0520	

[Default = blank (*) blank (*)]

Leading Digits for Pager Format (2nd Digit)	ADDRESS 0521	

[Default = blank (*) blank (*)]

LEADING DIGITS FOR PAGER FORMAT: In Pager Format reporting, the message typically begins with "00". However, for some pager services, this will cause the Pager's Voice Mail feature to activate. This option allows you to program these digits to any number desired. Typical Pager report is "003 022 1234", where 3 is the Event, 22 is the zone, and 1234 is the Subscriber ID number. For example, if the Leading Digits are programmed as "98", the Pager report will now appear as "983 022 1234".

- Enter in 1st and 2nd Leading Digits in right digit only (left digit is not used) as shown.
- Valid entries are: 0-9. Press  or  to save

0526	CS Receiver 1 Options	
Default		Option
OFF	1	1400Hz Handshake/Kissoff *
OFF	2	2300Hz Handshake/Kissoff *
OFF	3	Enable Zone Number on Pulse Alarm
OFF	4	Single Digit Only
OFF	5	Sum Check
OFF	6	3/1 with Extended Restores
OFF	7	Report to TCP/IP Receiver or AES (Telco 1)**
OFF	8	RESERVED

0551	CS Receiver 2 Options	
Default		Option
OFF	1	1400Hz Handshake/Kissoff *
OFF	2	2300Hz Handshake/Kissoff *
OFF	3	Enable Zone Number on Pulse Alarm
OFF	4	Single Digit Only
OFF	5	Sum Check
OFF	6	3/1 with Extended Restores
OFF	7	Report to TCP/IP Receiver or AES (Telco 2)**
OFF	8	RESERVED

0576	CS Receiver 3 Options	
Default		Option
OFF	1	1400Hz Handshake/Kissoff *
OFF	2	2300Hz Handshake/Kissoff *
OFF	3	Enable Zone Number on Pulse Alarm
OFF	4	Single Digit Only
OFF	5	Sum Check
OFF	6	3/1 with Extended Restores
OFF	7	Report to TCP/IP Receiver or AES (Telco 3)**
OFF	8	RESERVED

Default for CS Receiver 1 Format depends on Easy Menu Question "RCVR FORMAT". [Default = •(blank) E] for CS Receivers 2 and 3 Formats.

CS RECEIVER FORMATS: Up to 3 CS Formats may be programmed.

- Select the desired CS Receiver Format from the table shown.
- Enter the corresponding digit in the address location for each CS Receiver. **NOTE:** Dark shaded data value box shows option not available. Press [Enter] of [ON/OFF] to save.

NOTES:

- * If both are selected, 1400Hz has priority over 2300Hz.
- ** For NAPCO NetLink™ installations only: For each telephone number desired, enable to allow the panel to report alarms via the NL-MOD accessory. See WI1242 for more information.

CS RECEIVER FORMAT OPTIONS



CS RECEIVER TELEPHONE NUMBERS (ADDRESS 0527-0546, 0552-0571, 0577-0596)

	ADDRESS 0527-0546 (DIGITS 1-20)																			
CS Receiver 1 Telephone Number (Digits 1-20)	0527	0528	0529	0530	0531	0532	0533	0534	0535	0536	0537	0538	0539	0540	0541	0542	0543	0544	0545	0546
CS Receiver 2 Telephone Number (Digits 1-20)	0552	0553	0554	0555	0556	0557	0558	0559	0560	0561	0562	0563	0564	0565	0566	0567	0568	0569	0570	0571
CS Receiver 3 Telephone Number (Digits 1-20)	0577	0578	0579	0580	0581	0582	0583	0584	0585	0586	0587	0588	0589	0590	0591	0592	0593	0594	0595	0596

Default for CS Receiver 1 Telephone Number depends on Easy Menu Question "CENTRAL PHONE #".

[Default = blank (*)] across digits 1-20 for CS Receiver Telephone Numbers 2 and 3.

CS RECEIVER TELEPHONE NUMBERS: Enter telephone numbers for any of the three CS Receivers (Telco 1, 2 & 3).

1. Enter up to 20 digits from left to right. **NOTE:** Leave trailing boxes blank (*).
2. Valid entries are: 1-9, B = button, C = button, D = 3 sec. pause, E = Wait for dial tone, F = ignore location

DOWNLOAD/CALLBACK OPTIONS (ADDRESS 4089, 0600-0619, 0625-0647, 1022 & 1023)

Answer on Ring Number	ADDRESS 4089		

[Default = 015]

ANSWER ON RING NUMBER: Enter the number of rings before automatic pickup by the control panel when downloading from a computer (see Glossary in WI817). Initial value of 000 becomes 15 rings.

1. Enter digits only.
2. Valid entries are: 003-015. **NOTE:** Default is 15 Rings. Press or to save.

	ADDRESS 0600-0619 (DIGITS 1-20)																			
Callback Telephone Number 1 (Digits 1-20)	0600	0601	0602	0603	0604	0605	0606	0607	0608	0609	0610	0611	0612	0613	0614	0615	0616	0617	0618	0619

[Default = blank (*) for all digits 1-20]

	ADDRESS 0625-0644 (DIGITS 1-20)																			
Callback Telephone Number 2 (Digits 1-20)	0625	0626	0627	0628	0629	0630	0631	0632	0633	0634	0635	0636	0637	0638	0639	0640	0641	0642	0643	0644

[Default = blank (*) for all digits 1-20]

CALLBACK TELEPHONE NUMBERS: Enter telephone numbers to be used when downloading from a computer.

1. Enter digits only.
2. Enter up to 20 digits from left to right. **NOTE:** Leave trailing boxes blank (*).
3. Valid entries are: 0-9, B = button, C = button, D = 3 sec. pause, E = Wait for dial tone, F = ignore location. Press or to save.

	ADDRESS 0645-0647		
Download Security Code	0645	0646	0647

[Default = blank (*) blank (*)]

	ADDRESS 1022
Callback Telephone No. Select	

[Default = blank (*) blank (*)]

	ADDRESS 1023	
Auto Download ID No.		

Valid entries - 01-99

[Default = blank (*) blank (*)]

DOWNLOAD SECURITY CODE: Enter up to 6 digits to be used for remote access when downloading from a computer.

1. Enter digits in address locations above.
2. Valid entries are: 0-9.

Note: Download Security Code must match the code entered in the PCD-Windows Quickloader Download Software.

CALLBACK TELEPHONE NO. SELECT: Enter either "1" for Callback Telephone Number 1 or "2" for Callback Telephone Number 2.

1. Valid entries are: 1 or 2.

CS SUBSCRIBER ID NUMBERS (ADDRESS 0650-0787)

CS TELCO 1 SUBSCRIBER OPENING/CLOSING ID NUMBERS

AREA 1			
ADDRESS 0650-0653 (DIGITS 1-4)			
0650	0651	0652	0653

AREA 2			
ADDRESS 0654-0657 (DIGITS 1-4)			
0654	0655	0656	0657

CS TELCO 1 SUBSCRIBER EVENT ID NUMBERS

AREA 1			
ADDRESS 0682-0685 (DIGITS 1-4)			
0682	0683	0684	0685

AREA 2			
ADDRESS 0686-0689 (DIGITS 1-4)			
0686	0687	0688	0689

SYSTEM			
ADDRESS 0714-0717 (DIGITS 1-4)			
0714	0715	0716	0717

CS TELCO 2 SUBSCRIBER OPENING/CLOSING ID NUMBERS (BACKUP REPORTING)

AREA 1			
ADDRESS 0720-0723 (DIGITS 1-4)			
0720	0721	0722	0723

AREA 2			
ADDRESS 0724-0727 (DIGITS 1-4)			
0724	0725	0726	0727

CS TELCO 2 SUBSCRIBER EVENT ID NUMBERS (BACKUP REPORTING)

AREA 1			
ADDRESS 0752-0755 (DIGITS 1-4)			
0752	0753	0754	0755

AREA 2			
ADDRESS 0756-0759 (DIGITS 1-4)			
0756	0757	0758	0759

SYSTEM			
ADDRESS 0784-0787 (DIGITS 1-4)			
0784	0785	0786	0787

CS SUBSCRIBER ID NUMBERS (TELCO 1 & 2)



CS SUBSCRIBER ID NUMBERS (ADDRESS 0790-0857)

CS TELCO 3 SUBSCRIBER OPENING/CLOSING ID NUMBERS

AREA 1			
ADDRESS 0790-0793 (DIGITS 1-4)			
0790	0791	0792	0793

AREA 2			
ADDRESS 0794-0797 (DIGITS 1-4)			
0794	0795	0796	0797

CS TELCO 3 SUBSCRIBER EVENT ID NUMBERS

AREA 1			
ADDRESS 0822-0825 (DIGITS 1-4)			
0822	0823	0824	0825

AREA 2			
ADDRESS 0826-0829 (DIGITS 1-4)			
0826	0827	0828	0829

SYSTEM			
ADDRESS 0854-0857 (DIGITS 1-4)			
0854	0855	0856	0857

Default for CS Telco 1 Subscriber Event ID Number (Area 1) depends on Easy Menu Question "ACCOUNT #". [Default = blank (•) blank (•) blank (•) blank (•)] for all other ID Numbers.

CS TELCO SUBSCRIBER ID NUMBERS: Enter the Subscriber Opening/Closing and Event ID Numbers for any of the 3 CS Receivers.

1. Enter 3 or 4 digits (depending on the CS receiver format) for each subscriber number from left to right.
NOTE: Leave trailing boxes blank (•).
2. Valid entries are: 1-9, 0 and B-F. **NOTE:** A is not permitted. Press [Enter] or ON/OFF] to save.

CS REPORTING CODES (ADDRESS 0859-0883)

ALARM/TROUBLE REPORTING CODES	ADDRESS 0859-0862		
	LEFT	ADDR	RIGHT
Cancel	blank (•)	0859	
Alarm Restore	blank (•)	0860	
Trouble	blank (•)	0861	
Trouble Restore	blank (•)	0862	

[Default = blank (•) blank (•) from address 0859-0883]

OPENING/CLOSING REPORTING CODES	ADDRESS 0864-0883		
		ADDR	
Closing	blank (•)	0864	
Conditional Closing	blank (•)	0865	
Opening	blank (•)	0866	
Opening after Alarm	blank (•)	0867	
Fail to Open		0868	
Fail to Close		0869	
Telemetry Trouble		0882	
Telemetry Fail		0883	

CS SYSTEM REPORTING CODES:

1. Enter in corresponding address location (left and right digits).
NOTE: Left digit is the first digit and right digit is the second digit in a two digit CS receiver format.
2. Valid entries are: 1-9, 0 and B-F.
NOTE: A is not permitted.
3. To disable a code leave boxes blank (•).
NOTE: Dark shaded data value box shows option not available.
4. Press or to save.

CS REPORTING CODES (ADDRESS 0870-0904)



SYSTEM REPORTING CODES	ADDRESS 0870-0880		
	LEFT	ADDR	RIGHT
Test Timer		0870	
Alarm Supervisory		0871	
Bus Failure		0872	
Memory Failure		0873	
Low Battery		0874	
AC Failure		0875	
EZM Tamper		0876	
Sensor Watch		0877	
RESERVED	blank (*)	0878	blank (*)
RESERVED	blank (*)	0879	blank (*)
Telco Line Failure		0880	

SYSTEM REPORTING CODES	ADDRESS 0890-0897		
	LEFT	ADDR	RIGHT
Digital Dialer Test		0890	
RESERVED		0891	
RESERVED		0892	
Service Message		0893	
Program Change		0894	
RF Receiver Trouble		0895	
RF Tamper		0896	
RF Trouble		0897	

[Default = blank (*) blank (*) from address 0870-0904]

KEYPAD REPORTING CODES	ADDRESS 0900-0904		
	LEFT	ADDR	RIGHT
Ambush		0900	
Panic		0901	
Fire		0902	
Auxiliary		0903	
Tamper		0904	

CS SYSTEM REPORTING CODES:

1. Enter in corresponding address location (left and right digits).
NOTE: Left digit is the first digit and right digit is the second digit in a two digit CS receiver format.
2. Valid entries are: 1-9, 0 and B-F.
NOTE: A is not permitted.
3. To disable a code leave boxes blank (*).
NOTE: Dark shaded data value box shows option not available.
4. Press  or  to save.

CAUTION: For all 2-Digit Reporting Formats (see CS Receiver Format Options), use the following:

Reporting Code	ADDRESS Loc.	
	LEFT	RIGHT
1	2	

2nd Digit of Reporting Code

1st Digit of Reporting Code

Example: The 2-digit reporting code as shown is "21".

CS AREA & SYSTEM REPORTING OPTIONS (ADDRESS 1024-1027)

CS Area Reporting Options	ADDRESS	AREAS 1 → 2	
		A1	A2
DISABLE OPENING REPORTS	1024	1	2
DISABLE CLOSING REPORTS	1025		

1027	CS System Report Options	
Default		Option
OFF	1	Backup Report on Telco 2
OFF	2	Touch-tone Dialing Only *
ON	3	Touch-tone Dialing w/Rotary Backup *
OFF	4	Transmit "402" Opening/Closing Code
OFF	5	Cancel Next Test Timer on any Report
OFF	6	Disable Wait for Silence
OFF	7	Disable Wait for Handshake
OFF	8	Handshake for Local Telemetry

CS AREA & SYSTEM REPORTING OPTIONS:

1. Select the desired option entering the option number (1-8) for each digit.
2. Enter corresponding option number in address location.

NOTE: Dark shaded data value box shows option not available.

3. Press  or  to save.

* **NOTE:** If neither TouchTone Dialing nor TouchTone w/Rotary Backup is selected, then system defaults automatically to Rotary Dialing. Leave blank (*) to select Rotary Dialing.

CS REPORTING CODES & CS REPORTING OPTIONS



CS ZONE REPORTING CODES (ADDRESS 0910-0957)

ADDRESS 0910-0917							
ZONES REPORT CODE (CONTROL PANEL)							
ZONE 1	ZONE 2	ZONE 3	ZONE 4	ZONE 5	ZONE 6	ZONE 7	ZONE 8
0910	0911	0912	0913	0914	0915	0916	0917

ADDRESS 0918-0921			
ZONES REPORT CODE (GROUP 1)			
ZONE 9	ZONE 10	ZONE 11	ZONE 12
0918	0919	0920	0921

ADDRESS 0922-0925			
ZONES REPORT CODE (GROUP 2)			
ZONE 13	ZONE 14	ZONE 15	ZONE 16
0922	0923	0924	0925

ADDRESS 0926-0929			
ZONES REPORT CODE (GROUP 3)			
ZONE 17	ZONE 18	ZONE 19	ZONE 20
0926	0927	0928	0929

ADDRESS 0930-0933			
ZONES REPORT CODE (GROUP 4)			
ZONE 21	ZONE 22	ZONE 23	ZONE 24
0930	0931	0932	0933

ADDRESS 0934-0937			
ZONES REPORT CODE (GROUP 5)			
ZONE 25	ZONE 26	ZONE 27	ZONE 28
0934	0935	0936	0937

ADDRESS 0938-0941			
ZONES REPORT CODE (GROUP 6)			
ZONE 29	ZONE 30	ZONE 31	ZONE 32
0938	0939	0940	0941

ADDRESS 0942-0945			
ZONES REPORT CODE (GROUP 7)			
ZONE 33	ZONE 34	ZONE 35	ZONE 36
0942	0943	0944	0945

ADDRESS 0946-0949			
ZONES REPORT CODE (GROUP 8)			
ZONE 37	ZONE 38	ZONE 39	ZONE 40
0946	0947	0948	0949

ADDRESS 0950-0953			
ZONES REPORT CODE (GROUP 9)			
ZONE 41	ZONE 42	ZONE 43	ZONE 44
0950	0951	0952	0953

ADDRESS 0954-0957			
ZONES REPORT CODE (GROUP 10)			
ZONE 45	ZONE 46	ZONE 47	ZONE 48
0954	0955	0956	0957

Default for Group Zone Report Codes depends on Easy Menu Question "RCVR. FORMAT".

ZONE REPORT CODE OPTIONS	
DATA ENTRIES	

NOTE: Zones 1-8 are included in the control panel and Zones 9-32 are EZM Zones. Zones 33-48 are wireless. See Address 2555-2560 to enable "EZM Zone Groups".

CS ZONE REPORTING CODES

DATA ENTRIES	MODEM CODE
1	Fire *
2	Panic
3	Burglary
4	Hold up
7	Gas Alarm
8	Heat Alarm
0	Auxiliary Alarm
B	24 Hour Auxiliary

PULSE EVENT CODE will be the first digit of the 2 digit reporting code. The second digit will be the second digit of the reporting zone. For example, for zone 9 (address 0918), if the right digit is "3", then the reporting code is "39". With another example, for zone 15 (address 0924), if the right digit is "4", then the reporting code is "45".

MODEM CODES determine the zone types reported for the following formats: SIA and ADEMCO Point ID.

1. Select the desired Modem Code for each zone from the table shown.

2. Press or to save.

CS USER REPORTING CODES (ADDRESS 1030-1074)

Enable Users to Report	ADDR	USERS 1 → 8								ADDR	USERS 9 → 16							
		U1	U2	U3	U4	U5	U6	U7	U8		U9	U10	U11	U12	U13	U14	U15	U16
		1	2	3	4	5	6	7	8		1	2	3	4	5	6	7	8
User Opening Telco 1	1030									1031								
User Closing Telco 1	1043									1044								
User Opening Telco 3	1056									1057								
User Closing Telco 3	1069									1070								

Enable Users to Report	ADDR	USERS 17 → 24								ADDR	USERS 25 → 32							
		U17	U18	U19	U20	U21	U22	U23	U24		U25	U26	U27	U28	U29	U30	U31	U32
		1	2	3	4	5	6	7	8		1	2	3	4	5	6	7	8
User Opening Telco 1	1032									1033								
User Closing Telco 1	1045									1046								
User Opening Telco 3	1058									1059								
User Closing Telco 3	1071									1072								

Enable Users to Report	ADDR	USERS 33 → 40								ADDR	USERS 41 → 48							
		U33	U34	U35	U36	U37	U38	U39	U40		U41	U42	U43	U44	U45	U46	U47	U48
		1	2	3	4	5	6	7	8		1	2	3	4	5	6	7	8
User Opening Telco 1	1034									1035								
User Closing Telco 1	1047									1048								
User Opening Telco 3	1060									1061								
User Closing Telco 3	1073									1074								

NOTE: These opening events will report as the user number shown. Also, Keyfobs 1-8 (see Easy Menu Program Driven Mode) will report as Users 25-32, respectively.

CS USER REPORTING CODES



GLOBAL SYSTEM TROUBLE REPORTING OPTIONS (ADDRESS 1082-1116)

GLOBAL SYSTEM TROUBLE REPORTING OPTIONS

SYSTEM RESPONSE ACTIVATED BY GLOBAL EVENT/TROUBLE	ADDR	GLOBAL SYSTEM EVENT/TROUBLE							
		TEST TIMER	ALARM SUPERV.	COMM. BUS 1	MEMORY FAILURE	LOW BATTERY	AC FAIL	EZM TAMPER	SENSOR WATCH
		1	2	3	4	5	6	7	8
Burglary Alarm Output	1082								
Pulsed Burg. Output	1083								
Fire Output (Lug E9)	1084								
Reset Relay	1085								
Auxiliary Relay	1086								
Report Event Telco 1	1087								
Report Restore Telco 1	1088								
Report Event Telco 3	1091								
Report Restore Telco 3	1092								

[Default = blank (*) from address 1082-1092].

SYSTEM RESPONSE ACTIVATED BY GLOBAL EVENT/TROUBLE	ADDR	GLOBAL SYSTEM EVENT/TROUBLE							
		TELCO FAIL	RSRVD.	Telemetry Trouble	Telemetry Failure	RSRVD.	RSRVD.	RSRVD.	RSRVD.
		1	2	3	4	5	6	7	8
Burglary Alarm Output	1094								
Pulsed Burg. Output	1095								
Fire Output (Lug E9)	1096								
Reset Relay	1097								
Auxiliary Relay	1098								
Report Event Telco 1	1099								
Report Restore Telco 1	1100								
Report Event Telco 3	1103								
Report Restore Telco 3	1104								

[Default = blank (*) from address 1094-1104] * NOTE: Keypad Aux. is not to be selected for UL Installations.

SYSTEM RESPONSE ACTIVATED BY GLOBAL EVENT/TROUBLE	ADDR	GLOBAL SYSTEM EVENT/TROUBLE							
		Digital Dialer Test	RSRVD.	RSRVD.	SERVICE MESSAGE	PROGRAM CHANGE	RF RCVR. TROUBLE	RF TAMPER	RF TROUBLE
		1	2	3	4	5	6	7	8
Burglary Alarm Output	1106								
Pulsed Burg. Output	1107								
Fire Output (Lug E9)	1108								
Reset Relay	1109								
Auxiliary Relay	1110								
Report Event Telco 1	1111								
Report Restore Telco 1	1112								
Report Event Telco 3	1115								
Report Restore Telco 3	1116								

[Default = blank (*) blank (*) from address 1106-1116] * NOTE: Keypad Aux. is not to be selected for UL Installations.

1. Select the desired option entering the option number (1-8) for each digit.
2. Enter corresponding option number in address location.

NOTE: Dark shaded data value box shows option not available. Press or to save.





AREA SYSTEM TROUBLE REPORTING OPTIONS (ADDRESS 1120-1137)

SYSTEM RESPONSE ACTIVATED BY AREA 1 EVENT/TROUBLE	ADDR	AREA 1 SYSTEM EVENT/TROUBLE							RSRVD. 8
		AMBUSH 1	KEYPAD PANIC 2	KEYPAD FIRE 3	KEYPAD AUX. 4	KEYPAD TAMPER 5	FAIL TO OPEN 6	FAIL TO CLOSE 7	
		Pulsed Burg. Output	1120			Default ON			
Burglary Output	1121		Default ON		Default ON				
Fire Output (Lug E9)	1122								
Reset Relay	1123								
Auxiliary Relay	1124								
Report Alarm Telco 1	1125								
Report Alarm Telco 3	1127								

[Defaults as noted from address 1120-1127]

SYSTEM RESPONSE ACTIVATED BY AREA 2 EVENT/TROUBLE	ADDR	AREA 2 SYSTEM EVENT/TROUBLE							RSRVD. 8
		AMBUSH 1	KEYPAD PANIC 2	KEYPAD FIRE 3	KEYPAD AUX. 4	KEYPAD TAMPER 5	FAIL TO OPEN 6	FAIL TO CLOSE 7	
		Pulsed Burg. Output	1130			Default ON			
Burglary Output	1131		Default ON		Default ON				
Fire Output (Lug E9)	1132								
Reset Relay	1133								
Auxiliary Relay	1134								
Report Alarm Telco 1	1135		Default ON	Default ON	Default ON				
Report Alarm Telco 3	1137								

[Defaults as noted from address 1130-1137]

-  1. Select the desired option entering the option number (1-8) for each digit.
 -  2. Enter corresponding option number in address location.
- NOTE:** Dark shaded data value box shows option not available.
-  3. Press  or  to save.

AREA SYSTEM TROUBLE REPORTING OPTIONS



ZONE OPTIONS / ZONES 1-16 (ADDRESS 1200-1386)

ZONE OPTIONS / ZONES 1-16

ZONE OPTIONS	ADDR	ZONES 1 → 8								ADDR	ZONES 9 → 16							
		Z1	Z2	Z3	Z4	Z5	Z6	Z7	Z8		Z9	Z10	Z11	Z12	Z13	Z14	Z15	Z16
		1	2	3	4	5	6	7	8		1	2	3	4	5	6	7	8
50ms Loop Response (A)	1200																	
20ms Loop Response (A)	1201																	
† Priority	1202									1302								
† Priority with Bypass	1203									1303								
† Auto-Bypass	1204									1304								
† Selective Bypass	1205									1305								
† Keyswitch Arming	1206									1306								
† Auto-Bypass Re-entry	1207									1307								
† Pre-Alarm Warning	1208									1308								
† Never Arm	1209									1309								
† 24-Hour Zone	1210									1310								
† Burg. Alarm Output	1211									1311								
II Pulsed Alarm Output	1212									1312								
† Fire Output (Lug E9)	1213									1313								
† Reset Relay	1214									1314								
† Auxiliary Relay	1215									1315								
† Entry/Exit 1	1216									1316								
† Entry/Exit 2	1217									1317								
† Exit/Entry Follower	1218									1318								
† ⌘ Auto Reset	1219									1319								
† ⌘ Swinger Shutdown	1220									1320								
† Chime	1221									1321								
† Abort Delay	1222									1322								
† Power-up Delay	1223									1323								
† Day Zone Open	1224									1324								
† Day Zone Short	1225									1325								
† Alarm on Day Zone	1226									1326								
† RPT Alarm Tel 1	1227									1327								
† RPT Alarm Restore Tel 1	1228									1328								
† RPT Trouble Tel 1	1229									1329								
† RPT Trouble Restore Tel 1	1230									1330								
† RPT Alarm Tel 3	1235									1335								
† RPT Alarm Restore Tel 3	1236									1336								
† RPT Trouble Tel 3	1237									1337								
† RPT Trouble Restore Tel 3	1238									1338								
† No EOL Resistor	1239									1339								
† Sensor Watch	1240									1340								
† Trouble on Open	1241									1341								
† Trouble on Short	1242									1342								
† Trouble on Night Open	1243									1343								
† Zone Area 1	1244									1344								
† Zone Area 2	1245									1345								
† 2-Wire Smoke Detectors (B)	1252																	
RESERVED	1253									1353								
† Zone ANDing Group 1	1254									1354								
† Zone ANDing Group 2	1255									1355								
† Interior #1 Bypass	1262									1362								
† Interior #2 Bypass	1263									1363								
† Keypad Sounder on Alarm	1264									1364								
† Fire (C)	1275									1375								
† Fire Alarm Verification (C)	1276									1376								
† Interior (STAY) Bypass	1284									1384								
† Chime 2	1286									1386								

- † When the Easy Program Menu is used, these features are enabled by default (for new panels or after a Cold Start (address 4093)). Zone Area 1 is enabled for the first 8 zones only, by default
- ⌘ Do not program if "K Series" keypads (with "STAY" and "AWAY" buttons) are used in the system. See Zone Options on Page 33.
- ⌘ Disable Auto-Reset on non-fire zones for SIA CP-01 installations.
- II In UL installations, all Fire Zones must also be programmed for "Pulse Burg Output Cadence" (Address 2422, press 1 (bit zero)).

ZONE OPTIONS / ZONES 17-32 (ADDRESS 1402-1586)

ZONE OPTIONS	ADDR	ZONES 17 → 24								ADDR	ZONES 25 → 32							
		Z17	Z18	Z19	Z20	Z21	Z22	Z23	Z24		Z25	Z26	Z27	Z28	Z29	Z30	Z31	Z32
		1	2	3	4	5	6	7	8		1	2	3	4	5	6	7	8
† Priority	1402									1502								
† Priority with Bypass	1403									1503								
† Auto-Bypass	1404									1504								
† Selective Bypass	1405									1505								
† Keyswitch Arming	1406									1506								
† Auto-Bypass Re-entry	1407									1507								
† Pre-Alarm Warning	1408									1508								
† Never Arm	1409									1509								
† 24-Hour Zone	1410									1510								
† Burg. Alarm Output	1411									1511								
II Pulsed Alarm Output	1412									1512								
† Fire Output (Lug E9)	1413									1513								
† Reset Relay	1414									1514								
† Auxiliary Relay	1415									1515								
† Entry/Exit 1	1416									1516								
† Entry/Exit 2	1417									1517								
† Exit/Entry Follower	1418									1518								
† ⌘ Auto Reset	1419									1519								
† ⌘ Swinger Shutdown	1420									1520								
† Chime	1421									1521								
† Abort Delay	1422									1522								
† Power-up Delay	1423									1523								
† Day Zone Open	1424									1524								
† Day Zone Short	1425									1525								
† Alarm on Day Zone	1426									1526								
† RPT Alarm Tel 1	1427									1527								
† RPT Alarm Restore Tel 1	1428									1528								
† RPT Trouble Tel 1	1429									1529								
† RPT Trouble Restore Tel 1	1430									1530								
† RPT Alarm Tel 3	1435									1535								
† RPT Alarm Restore Tel 3	1436									1536								
† RPT Trouble Tel 3	1437									1537								
† RPT Trouble Restore Tel 3	1438									1538								
† No EOL Resistor	1439									1539								
† Sensor Watch	1440									1540								
† Trouble on Open	1441									1541								
† Trouble on Short	1442									1542								
† Trouble on Night Open	1443									1543								
† Zone Area 1	1444									1544								
† Zone Area 2	1445									1545								
† RESERVED	1453									1553								
† Zone ANDing Group 1	1454									1554								
† Zone ANDing Group 2	1455									1555								
† Interior #1 Bypass	1462									1562								
† Interior #2 Bypass	1463									1563								
† Keypad Sounder on Alarm	1464									1564								
† Fire (C)	1475									1575								
† Fire Alarm Verification (C)	1476									1576								
† Interior (STAY) Bypass	1484									1584								
† Chime 2	1486									1586								

† When the Easy Program Menu is used, these features are enabled by default (for new panels or after a Cold Start (address 4093)).

⌘ Do not program if "K Series" keypads (with "[STAY]" and "[AWAY]" buttons) are used in the system.

⌘ Disable Auto-Reset on non-fire zones for SIA CP-01 installations.

II In UL installations, all Fire Zones must also be programmed for "Pulse Burg Output Cadence" (Address 2422, press 1 (bit zero)).

See Zone Options on Page 33.

ZONE OPTIONS / ZONES 17-32



ZONE OPTIONS / ZONES 33-48 (ADDRESS 1602-1786)

ZONE OPTIONS / ZONES 33-48

ZONE OPTIONS	ADDR	ZONES 33 → 40								ADDR	ZONES 41 → 48							
		Z33	Z34	Z35	Z36	Z37	Z38	Z39	Z40		Z41	Z42	Z43	Z44	Z45	Z46	Z47	Z48
		1	2	3	4	5	6	7	8		1	2	3	4	5	6	7	8
† Priority	1602									1702								
† Priority with Bypass	1603									1703								
† Auto-Bypass	1604									1704								
† Selective Bypass	1605									1705								
† Keyswitch Arming	1606									1706								
† Auto-Bypass Re-entry	1607									1707								
† Pre-Alarm Warning	1608									1708								
† Never Arm	1609									1709								
† 24-Hour Zone	1610									1710								
† Burg. Alarm Output	1611									1711								
II Pulsed Alarm Output	1612									1712								
II Fire Output (Lug E9)	1613									1713								
II Reset Relay	1614									1714								
II Auxiliary Relay	1615									1715								
II Entry/Exit 1	1616									1716								
II Entry/Exit 2	1617									1717								
II Exit/Entry Follower	1618									1718								
† ⌘ Auto Reset	1619									1719								
† ⌘ Swinger Shutdown	1620									1720								
† Chime	1621									1721								
† Abort Delay	1622									1722								
† Power-up Delay	1623									1723								
† Day Zone Open	1624									1724								
† Day Zone Short	1625									1725								
† Alarm on Day Zone	1626									1726								
† RPT Alarm Tel 1	1627									1727								
† RPT Alarm Restore Tel 1	1628									1728								
† RPT Trouble Tel 1	1629									1729								
† RPT Trouble Restore Tel 1	1630									1730								
† RPT Alarm Tel 3	1635									1735								
† RPT Alarm Restore Tel 3	1636									1736								
† RPT Trouble Tel 3	1637									1737								
† RPT Trouble Restore Tel 3	1638									1738								
† No EOL Resistor	1639									1739								
† Sensor Watch	1640									1740								
† Trouble on Open	1641									1741								
† Trouble on Short	1642									1742								
† Trouble on Night Open	1643									1743								
† Zone Area 1	1644									1744								
† Zone Area 2	1645									1745								
RESERVED	1653									1753								
† Zone ANDing Group 1	1654									1754								
† Zone ANDing Group 2	1655									1755								
† Interior #1 Bypass	1662									1762								
† Interior #2 Bypass	1663									1763								
† Keypad Sounder on Alarm	1664									1764								
† Fire (C)	1675									1775								
† Fire Alarm Verification (C)	1676									1776								
† Interior (STAY) Bypass	1684									1784								
† Chime 2	1686									1786								



- † When the Easy Program Menu is used, these features are enabled by default (for new panels or after a Cold Start (address 4093)).
- ⌘ Do not program if "K Series" keypads (with "[STAY]" and "[AWAY]" buttons) are used in the system.
- ⌘ Disable Auto-Reset on non-fire zones for SIA CP-01 installations.
- II In UL installations, all Fire Zones must also be programmed for "Pulse Burg Output Cadence" (Address 2422, press 1 (bit zero)).

See Zone Options on Page 33.

ZONE OPTIONS / ZONES 1-48 (ADDRESS 1200-1786)

ZONE OPTIONS: Select zone options for any zone.

1. Select the desired zone option by entering the option number (1-8) for each selected zone.
2. Enter corresponding option number in address location, in Binary (Bit) Format.

NOTE: Dark shaded data value box shows option not available. Press  or  to save

NOTE: See Direct Address Programming Example on page 15.

NOTES: (A) 50ms & 20 ms Loop Response only available for zones 1-8.

(B) 2-wire Smoke Detectors only available for zones 1-8. Refer to Installation Instructions (WI817) for more details. If 2-wire Smoke Detector is selected, then Fire must also be selected.

(C) If Fire Alarm Verification is selected, then Fire must also be selected.

DEFAULTS: The zone options indicated are automatically set after exiting the Easy Menu Driven Mode.

- ✓ *Priority, Selective Bypass, Alarm Output, Auto Reset, Swinger Shutdown, Zone Area 1 and Zone Area 2* are enabled for the total number of zones entered in "AREA 1 # ZONES = 08" and "AREA 2 # ZONES = 00".
- ✓ *Alarm Telco 1* is enabled for the zones if [YES] is entered for "REPORT ALL ZONES TO CENTRAL ZONES? Y/N".
- ✓ *Entry/Exit 1* and *Chime* are enabled for zone numbers entered in "EXIT / ENTRY ZONES".
- ✓ *Exit/Entry Follower* and *Interior Bypass* are enabled for zone numbers entered in "INTERIOR ZONES".
- ✓ *Fire, Pulse Alarm Output and Fire Verification* is enabled for the zone numbers entered in "FIRE ZONES".
- ✓ 2-Wire Smoke Detector is enabled for zone numbers entered in "2 WIRE FIRE ZONES".

Note: See "Number of Zones & Keypads per Area" in Easy Menu Driven program Mode.

SYSTEM OPTIONS (ADDRESS 2415-2419)

2415 System Options - Disable Fire Reset		
Default		Option
OFF	1	Disable Fire Reset (Area 1)
OFF	2	Disable Fire Reset (Area 2)
OFF	3	RESERVED
OFF	4	RESERVED
OFF	5	RESERVED
OFF	6	RESERVED
OFF	7	RESERVED
OFF	8	RESERVED

2416 System Options - Enable Day Zone Watch		
Default		Option
OFF	1	Enable Day Zone Watch (Area 1)
OFF	2	Enable Day Zone Watch (Area 2)
OFF	3	RESERVED
OFF	4	RESERVED
OFF	5	RESERVED
OFF	6	RESERVED
OFF	7	RESERVED
OFF	8	RESERVED

2417 System Options		
Default		Option
OFF	1	Opening Report only after Alarm Report
OFF	2	Closing Report only on Cond. Closing (Auto-Byp.)
OFF	3	Include Sel./Grp. Bypass in Cond. Closing Status
OFF	4	Status Report (Auto-Byp. Zones on Clos.)
OFF	5	RESERVED
OFF	6	Lug E4 Armed Away Only
OFF	7	Disable Auto-Unbypass on Disarming
OFF	8	Enable All-Zone-in-Trouble Bypass



2418 System Options		
Default		Option
OFF	1	Auto Bell Test on Arming
ON	2	Auto Reset after Burg. Output Timeout
OFF	3	Suppress "Bypass" Icon when Armed
OFF	4	RESERVED
OFF	5	Access Control (Panel) on Aux. Output
OFF	6	Enable Burg. Output Warning on Entry
OFF	7	Enable Manager's Mode Outside Overview
OFF	8	Start Exit Delay after Ringback

2419 System Options		
Default		Option
OFF	1	Interior 1 Normally Bypassed*
OFF	2	Enable Exit-Delay Restart
OFF	3	Reset Day Zone with Arm/Disarm Only
OFF	4	Enable Local Alarm on First Zone "AND" Trip
OFF	5	Disable Keypad Function-Mode Download
OFF	6	Disable Callback Download
OFF	7	Disable Answering-Machine Download
OFF	8	Disable Auto-Reset on Day Zone

*Do not use on systems with "K Series " keypads.

SYSTEM OPTIONS:

1. Select the desired option entering the option number (1-8) for each digit.
2. Enter corresponding option number in address location.

NOTE: Dark shaded data value box shows option not available. Press  or  to save.

SYSTEM OPTIONS (ADDRESS 2420-2422, 3874, 3905, 3880-3881)

2420 System Options		
Default		Option
OFF	1	Disable System Trouble Audible (at Keypad) †
OFF	2	Chime on Lug E4
OFF	3	Disable Code required for Func. Mode Lvl. 1
OFF	4	Disable Code required for EZ Bypass
OFF	5	Disable Keypad Instant Button
OFF	6	Enable Telephone Line-Fault Test
OFF	7	Disable AC Fail Detection
OFF	8	Telco Fail only when Armed

† NOTE: Not for UL Installations.

** Default for this address contingent on EZ Menu selections.

2421 System Options		
Default		Option
OFF	1	Automatic Interior Bypass/Easy Exit
OFF	2	Veri-phone Zones trip Aux. Output
OFF	3	Veri-phone Zones Priority over Alarms
OFF	4	AuxOut Chirp on Keyfob Arm/Disarm**
OFF	5	Disable Auxout Clear on Disarm
OFF	6	2nd Call Answering Machine Override
OFF	7	Disable Zone Fault Scrolling (Auto Status)
OFF	8	Veri-phone Zones trip Fire Output



2422 System Options		
Default		Option
ON	1	Pulse Burg Output Cadence [§]
OFF	2	Wireless Smoke Low Battery Resound
OFF	3	Supervised Alarm Output
OFF	4	Enable Smoke Detector Dirty Trouble
OFF	5	Disable Area Entry Relays
OFF	6	Disable Exit/Entry Urgency Tone at Keypad
OFF	7	Select Bell Output on Keyfob Arming
OFF	8	Enable Burg. Output on Telco Fail only when Armed

§In Zone Options, Fire Zones, and only Fire Zones, must be programmed for pulse alarm output.

3874 System Options		
Default		Option
OFF	1	Enable GEM-PRINT
OFF	2	Enable Cancel Report to Telco 3
OFF	3	Wireless Trouble to Telco 1
OFF	4	Wireless Trouble to Telco 3
OFF	5	Enable Set Time/Date Message
OFF	6	RESERVED
ON	7	Enable Keypad Time/Date Display
	8	RESERVED

SYSTEM OPTIONS:

1. Select the desired option entering the option number (1-8) for each digit.
2. Enter corresponding option number in address location.

NOTE: Dark shaded data value box shows option not available. Press  or  to save.

3905 System Options		
Default		Option
OFF	1	RESERVED
OFF	2	Enable Exit Delay Restart (SIA-FAR)**
OFF	3	Enable Bell on Exit Error**
OFF	4	Enable Report Exit Err/Recent Close**
OFF	5	Digital Dialer Rpt Enter/Exit Test Mode**
OFF	6	Enable CP-01 Limits**
OFF	7	Disable Call Waiting on First Attempt
OFF	8	Enable Ambush in User Assignment Code Type

** Default for this addresses contingent on EZ Menu selections.

ALARM/TROUBLE REPORTING CODES (ADDRESS 3880-3881)

ALARM/TROUBLE REPORTING CODES	ADDRESS 3880-3881	
Wireless Supervisory	3880	
Wireless Tamper	3881	
[Default = blank (*) from address 3880-3881]		

ALARM/TROUBLE REPORTING CODES:

1. Enter in corresponding address location (left and right digits).

NOTE: Left digit is the first digit and right digit is the second digit in a two digit CS receiver format.

2. Valid entries are: 1-9, 0 and B-F.

NOTE: A is not permitted.

3. To disable a code leave boxes blank (*).

4. Press  or  to save.



SYSTEM OPTIONS (ADDRESS 3882-3901, 3903-3905 & 4084)

Telephone Dialing Prefix (Digits 1-20)	ADDRESS 3882-3901 (RIGHT DIGITS 1-20)																				
	3882	3883	3884	3885	3886	3887	3888	3889	3890	3891	3892	3893	3894	3895	3896	3897	3898	3899	3900	3901	

	ADDRESS 3903	
Pager Recalls	LEFT	RIGHT

[Default = blank (•) blank (•)]

	ADDRESS 3904	
Pager Format: Maximum Pages per Session	LEFT	RIGHT

[Default = blank (•) blank (•)]

SYSTEM OPTIONS	LEFT DATA VALUES
RESERVED	1
RESERVED	2
RESERVED	4
Skip Automatic Dial Tone Detect	8

ADDRESS 4084	
LEFT DIGIT (SUM OF DATA VALUES)	RIGHT DIGIT (SUM OF DATA VALUES)
	blank (•)

[Default = blank (•) blank (•)]

Note: Right digit is RESERVED (not used). Enter data in left digit only.

SYSTEM OPTIONS

KEYPAD OPTIONS (ADDRESS 2425-2446)

Keypad 1 Type & Area Assignment	ADDRESS 2425	
	LEFT	RIGHT

[Default = blank (*) 1]

Keypad 2 Type & Area Assignment	ADDRESS 2426	
	LEFT	RIGHT

[Default = blank (*) blank (*)]

Keypad 3 Type & Area Assignment	ADDRESS 2427	
	LEFT	RIGHT

[Default = blank (*) blank (*)]

Keypad 4 Type & Area Assignment	ADDRESS 2428	
	LEFT	RIGHT

[Default = blank (*) blank (*)]

Keypad 5 Type & Area Assignment	ADDRESS 2429	
	LEFT	RIGHT

[Default = blank (*) blank (*)]

Keypad 6 Type & Area Assignment	ADDRESS 2430	
	LEFT	RIGHT

[Default = blank (*) blank (*)]

Keypad 7 Type & Area Assignment	ADDRESS 2431	
	LEFT	RIGHT

[Default = blank (*) blank (*)]

KEYPAD TYPE & AREA ASSIGNMENT: Up to 7 keypads may be programmed, if they are connected.

NOTE: See Keypad Configuration Mode. By default from the factory, each keypad is configured as number 1.

KEYPAD TYPE	
LEFT	OPTION
blank (*)	Burg Keypad
2	Wizard Keypad

KEYPAD AREA ASSIGNMENT	
RIGHT	OPTION
blank (*)	Not Used
1	Area 1
2	Area 2

 1. Select keypad type & area assignment for each keypad from the tables shown.

 2. Enter in corresponding right and left digit address locations above.

KEYPAD NUMBER	ADDR	KEYPAD OPTIONS							
		KEYPAD FIRE	KEYPAD AUXILIARY	KEYPAD PANIC	Rem. Acc. Only *	AMBUSH	EASY ARMING	PANEL ACCESS	TOUR STATION
		1	2	3	4	5	6	7	8
1	2440	default ON	default ON	default ON		default ON			
2	2441	default ON	default ON	default ON		default ON			
3	2442	default ON	default ON	default ON		default ON			
4	2443	default ON	default ON	default ON		default ON			
5	2444	default ON	default ON	default ON		default ON			
6	2445	default ON	default ON	default ON		default ON			
7	2446	default ON	default ON	default ON		default ON			

[Defaults as noted for address 2440-2446]

KEYPAD OPTIONS: Select options for any of the 7 keypads.

* **Note:** For Remote Access Control only (no Arm/Disarm capability).

 1. Select the desired option entering the option number (1-8) for each digit.



 2. Enter corresponding option number in address location.

 3. Press  or  to save.

NOTE: Dark shaded data value box shows option not available.

ACM ZONE OPTIONS (ADDRESS 2740-2769)

ACM ZONE OPTIONS:

Enter the Zone numbers (in decimal 1-48 format) for each option in the table below. Press  or  to save.

NOTE: Dark shaded data value box shows option not available. **Note:** The Area # for Door 1 is controlled by the existing Keypad Programming table (Address 2425 to 2431). The assigned area for Door #2 for each ACM must be entered in the table below (addresses 2748 and 2758) and must not be left blank if Door 2 is to be used.

ACM1 Zone Options	ADDR	Door 1			ADDR	Door 2		
Door Contact	2740				2745			
Forced Entry Zone	2741				2746			
Door Ajar Zone	2742				2747			
Area # for Door 2					2748			
Reserved	2743				2749			
Reserved	2744							



ACM2 Zone Options	ADDR	Door 1			ADDR	Door 2		
Door Contact	2750				2755			
Forced Entry Zone	2751				2756			
Door Ajar Zone	2752				2757			
Area # for Door 2					2758			
Reserved	2753				2759			
Reserved	2754							

ACM GLOBAL FLAGS (ADDRESS 2780)

2780	ACM Global Flags	
Default		Option
OFF	1	Enable Two-Swipe Arming
OFF	2	Enable NAPCO Proprietary Access Format
OFF	3	Enable Facility Code
OFF	4	Enable Access Logging into Burg Log
OFF	5	Enable Printing of Access Events
OFF	6	Enable Card Presentation Beep and Green LED Flash
OFF	7	RESERVED
OFF	8	RESERVED

ACM GLOBAL FLAGS:

1. Select the desired option entering the option number (1-8) for each digit.
2. Enter corresponding option number in address location.

NOTE: Dark shaded data value box shows option not available. Press  or  to save.

ACM TIMEOUTS (ADDRESS 2782-2783)

Maximum Two-Swipe Arm Time (x100ms)	ADDRESS 2782				
	<table border="1" style="width: 100%; height: 20px;"> <tr><td style="width: 25%;"></td><td style="width: 25%;"></td><td style="width: 25%;"></td><td style="width: 25%;"></td></tr> </table>				

[Default = 030 = 3 seconds.]

Unlock Time (sec.)	ADDRESS 2783				
	<table border="1" style="width: 100%; height: 20px;"> <tr><td style="width: 25%;"></td><td style="width: 25%;"></td><td style="width: 25%;"></td><td style="width: 25%;"></td></tr> </table>				

[Default = 005 = 5 sec.]



Enable ACM Access (address 2423) must be enabled.



Address 2782 determines the maximum time allowed for the double swipe (x100ms). Address 2783 determines the door unlock time, in seconds, after a successful entry.

1. Select timeout (1-255).
2. Enter in corresponding address locations above and right. Press  or  to save.

ACM DOOR AREA OPTIONS (ADDRESS 2784-2787)

ACM DOOR AREA OPTIONS:





-  1. Select the desired option entering the option number (1-3) for each address.
-  2. Enter corresponding option number in address location.

NOTE: Dark shaded data value box shows option not available. Press  or  to save.

ACM Door Number	ADDR	ACM DOOR AREA OPTIONS							
		Arm All Areas Allowed	Disarm All Areas Allowed	Stealth Mode	RSRVD.	RSRVD.	RSRVD.	RSRVD.	RSRVD.
		1	2	3	4	5	6	7	8
ACM 1 - Door 1	2784								
ACM 1 - Door 2	2785								
ACM 2 - Door 1	2786								
ACM 2 - Door 2	2787								
[Default = blank (•) blank (•) from address 2784-2787]									

ACM SCHEDULED FREE ACCESS (ADDRESS 4072-4075)

ACM SCHEDULED FREE ACCESS:

-  1. Enter the Scheduled Free Access Index (1-24) (Relay #1-24) for each option in the table at right.
-  2. Press  or  to save.



Scheduled Free Access Index			
ADDR	Relay Number		
ACM 1 – Door 1 – 4072			
ACM 1 – Door 2 – 4073			
ACM 2 – Door 1 – 4074			
ACM 2 – Door 2 – 4075			

[Default = blank (•) blank (•) from address 4072-4075]



KEYPAD HOME AREA / ACM DOOR #1 AREA (HEX) (ADDRESS 2425-2431)

ACM ZONE OPTIONS:



- ☞ Enter the Zone numbers (in two-digit hexadecimal format) for each option in the table below.
- ☞ The left digit (nibble) determines the type of device: "●" for *Keypad* and "1" for *ACM*.
- ☞ The right digit (nibble) determines the home area (1 or 2) of the specified device.
- ☞ Press  or  to save.

KEYPAD HOME AREA / ACM DOOR #1 AREA (HEX) (ADDRESS 2425-2431)			
ACM / Keypad	ADDRESS	DEVICE TYPE (●) or 1	AREA # (1 or 2)
1	2425	See *Note at bottom	
2	2426		
3	2427		
4	2428		
5	2429		
6	2430		
7	2431		

[Default = blank (●) 1 for address 2425
blank (●) blank (●) for addresses 2426-2431]
* **Note:** First device should be a keypad.

SYSTEM OPTIONS (ADDRESS 2423)



SYSTEM OPTION:

- 1. Select the System Option from the table shown and enter in the corresponding address location at right. *Keypad Blanking* will clear all data from the LCD display (and turn off all keypad LED's) after the system is armed and delay time has expired. The display will re-appear when an exit/entry door is faulted, causing an entry time delay display, or if a valid user code is entered at the keypad while the system is armed.
- 2. Press  or  to save. **NOTE:** Dark shaded data value box shows option not available.

ADDRESS 2423	
SYSTEM OPTIONS	
DATA ENTRIES RIGHT	OPTION
1	Enable ACM Access
2	RESERVED
3	Enable TCP/IP Communications
4	TCP/IP Panel/Site Initiated Functions
5	RESERVED
6	RESERVED
7	RESERVED
8	Enable Keypad Blanking

EMERGENCY FREE ACCESS (ADDRESS 4080)

ENABLE ACM OPTION:

- 1. Select the Emergency Free Access Zone Number (001-048) and enter corresponding address location at right.
- 2. Press  or  to save.

Emergency Free Access Zone Number	ADDRESS 4080		

[Default = 000]

ACM OPTIONS



USER AREA OPTIONS (ADDRESS 2455-2502)



USER NUMBER	ADDR	AREAS 1 → 2	
		A1	A2
		1	2
1	2455	ON	
2	2456	ON	
3	2457	ON	
4	2458	ON	
5	2459	ON	
6	2460	ON	
7	2461	ON	
8	2462	ON	
9	2463		ON
10	2464		ON
11	2465		ON
12	2466		ON
13	2467		ON
14	2468		ON
15	2469		ON
16	2470		ON
17	2471		
18	2472		
19	2473		
20	2474		
21	2475		
22	2476		
23	2477		
24	2478		
25	2479		
26	2480		
27	2481		
28	2482		
29	2483		
30	2484		
31	2485		
32	2486		
33	2487		
34	2488		
35	2489		
36	2490		
37	2491		
38	2492		
39	2493		
40	2494		
41	2495		
42	2496		
43	2497		
44	2498		
45	2499		
46	2500		
47	2501		
48	2502		

[Default = blank (•) blank (•) from address 2471-2502

Default = blank (•) 1 from address 2455-2462

Default = blank (•) 2 from address 2463-2470]

USER AREA OPTIONS:

1. Each address corresponds to a specific User, numbered 1-48. For each User, select the desired Area by marking the desired Area number (1 or 2) in the above table.
2. Enter the corresponding Area number in each the address location, in Binary (Bit) Format.
3. Press  or  to save.

NOTE: See Direct Address Programming Example on page 15.



EZM GROUP OPTIONS (ADDRESS 2555-2576)

EZM Group 1 ZONES 9-12 ADDRESS 2555	EZM Group 2 ZONES 13-16 ADDRESS 2556	EZM Group 3 ZONES 17-20 ADDRESS 2557	EZM Group 4 ZONES 21-24 ADDRESS 2558	EZM Group 5 ZONES 25-28 ADDRESS 2559	EZM Group 6 ZONES 29-32 ADDRESS 2560

Default depends on Easy Menu questions:



"# OF ZNS IN AREA1"
and
"# OF ZNS IN AREA2"

For example, If 32 zones are used, then all 6 groups will be automatically enabled.
If only 8 zones are used, then groups 1-6 will be automatically disabled.

NOTE: Zones 1-8 are included in the control panel and Zones 9-32 (Groups 1-6) are EZM Zones (either Wireless or Hardwired). Zones 33-48 are wireless only.

EZM TYPE	
DATA ENTRIES RIGHT	OPTION
blank (*)	Not used (No EZM present)
1	4-Zone EZM



EZM GROUP OPTIONS: Up to 6 Groups of 4 Zones each may be programmed depending on the number of zones used and which EZM modules are connected. Each group represents 4 zones.

1. Select EZM type from the table shown.
2. Enter either blank (*) or "1" in corresponding address locations above.
3. Press  or  to save

GROUP NUMBER	ADDR	EZM PGM TERMINAL CONTROL							
		A1	A2	A3	A4	A5	A6	A7	A8
		1	2	3	4	5	6	7	8
1	2577								
2	2578								
3	2579								
4	2580								
5	2581								
6	2582								

[Default = blank (*) blank (*) from address 2577-2582]

EZM PGM ARMED TERMINAL CONTROL: For each zone group select the area(s) which, when armed, will activate the PGM Lug on the corresponding EZM modules. Each zone group corresponds to 4 zones. If 8-Zone EZMs are used, each one is treated as TWO zone groups. **NOTE:** Lug goes ACTIVE (low) when EITHER selected area is armed. When activated, the PGM Lug goes negative (to ground).

1. Select the desired group number.
2. Enter the corresponding Area number in each the address location, in Binary (Bit) Format. **NOTE:** See Direct Address Programming Example on page 15.
3. Press  or  to save.

EZM GROUP OPTIONS



AREA ARMING OPTIONS (ADDRESS 2650-2651)

ARMING AREA	ADDRESS	PRIORITY AREA ARMING	
		A1	A2
		1	2
1	2650		
2	2651		

[Default = blank (*) blank (*) from address 2650-2651]

PRIORITY AREA ARMING:

1. Select the desired arming area.
2. Enter the corresponding Area number in each the address location, in Binary (Bit) Format. **NOTE:** See Direct Address Programming Example on page 15.
3. Press or to save.

NOTE: Dark shaded data value box shows option not available.

REMOTE ACCESS LOGGING (ADDRESS 3184)

3184	System Options - Enable Keypad	
Default		Option
OFF	1	Enable Keypad 1
OFF	2	Enable Keypad 2
OFF	3	Enable Keypad 3
OFF	4	Enable Keypad 4
OFF	5	Enable Keypad 5
OFF	6	Enable Keypad 6
OFF	7	Enable Keypad 7
OFF	8	Enable Keypad 8

REMOTE ACCESS LOGGING: Enable logging of every keypad access event.

1. Select the desired option entering the option number (1-7) for each digit.
2. Enter corresponding option number in address location.
3. Press or to save.

AREA OUTPUT CONTROL OPTIONS (ADDRESS 2700-2739)



OUTPUT SILENCED (TURNED OFF)	ADDR	DISARMING AREA 1 TURNS OFF AREA OUTPUT	
		A1	A2
		1	2
Burglary Output	2700	ON	ON
Pulsed Burg. Output	2708	ON	ON
Fire Output	2716		
Reset Relay	2724		
Auxiliary Relay	2732		

[Default = Noted above with "ON"]

OUTPUT SILENCED (TURNED OFF)	ADDR	DISARMING AREA 2 TURNS OFF	
		A1	A2
		1	2
Burglary Output	2701	ON	ON
Pulsed Burg. Output	2709	ON	ON
Fire Output	2717		
Reset Relay	2725		
Auxiliary Relay	2733		

[Default = Noted above with "ON"]

AREA OUTPUT TURNS OFF UPON DISARM: Select options for any of the 5 Outputs per area when disarming a particular area.

1. Select the desired option.
2. Enter the corresponding Area number in each the address location, in Binary (Bit) Format. **NOTE:** See Direct Address Programming Example on page 15.
3. Press  or  to save.



RF RECEIVERS & SUPERVISORY TIMER OPTIONS (ADDRESS 3776 & 3760-3775)

Number of RF Receivers	ADDRESS 3776	
	0	0

Default Number of Receivers = 0

DATA ENTRIES	RF RECEIVER(S)
0	None
1	1
2	2

RF RECEIVERS: Up to 2 RF Receivers may be programmed. **NOTE:** This adds wireless capability to the system, increasing up to 48 the number of zones.

- ☞ 1. Select the number of receivers (1-2).
- ☞ 2. Enter the corresponding decimal number (1-2) into the right-most location. Press or to save.

RF SUPERVISORY TIMER	RF TRANSMITTER	ADDRESS 3760-3767			RF SUPERVISORY TIMER	RF TRANSMITTER	ADDRESS 3768-3775		
		LEFT	ADDR	RIGHT			LEFT	ADDR	RIGHT
Type 0	Window/Door, 2 Pt.		3760		Type 8	Smoke Detector		3768	
Type 1	Window/Door, 2 Pt.		3761		Type 9	Keyfob		3769	
Type 2	Window/Door, 2 Pt.		3762		Type A	Dual Tech.		3770	
Type 3	Window/Door, 2 Pt.		3763		Type B	Keyfob		3771	
Type 4	Window/Door, 4 Pt.		3764		Type C	Window/Door, 4 Pt.		3772	
Type 5	PIR		3765		Type D	PIR		3773	
Type 6	PIR		3766		Type E	Smoke Detector		3774	
Type 7	Smoke Detector		3767		Type F	Napco Glass Break		3775	

[Default = blank (*) 8 from address 3760-3767 (80 minutes)] [Default = blank (*) 8 from address 3768-3775 (80 minutes)]

RF RECEIVERS & SUPERVISORY TIMER OPTIONS

RF SUPERVISORY TIMERS		
DATA ENTRIES	DELAY	
LEFT	RIGHT	
blank (*)	blank (*)	0 min.
blank (*)	1	10 min.
blank (*)	2	20 min.
blank (*)	3	30 min.
blank (*)	4	40 min.
blank (*)	5	50 min.
blank (*)	6	60 min.
blank (*)	7	70 min.
blank (*)	8	80 min.
blank (*)	9	90 min.
blank (*)	0	100 min.
blank (*)	B	110 min.
blank (*)	C	120 min.
blank (*)	D	130 min.
blank (*)	E	140 min.
blank (*)	F	150 min.
1	blank (*)	160 min.
1	1	170 min.
1	2	180 min.
1	3	190 min.
1	4	200 min.
1	5	210 min.
1	6	220 min.
1	7	230 min.
1	8	240 min.
1	9	250 min.
1	0	260 min.
1	B	270 min.
1	C	280 min.
1	D	290 min.
1	E	300 min.
1	F	310 min.
2	blank (*)	320 min.
2	1	330 min.
2	2	340 min.
2	3	350 min.
2	4	360 min.
2	5	370 min.

RF SUPERVISORY TIMERS		
DATA ENTRIES	DELAY	
LEFT	RIGHT	
2	6	380 min.
2	7	390 min.
2	8	400 min.
2	9	410 min.
2	0	420 min.
2	B	430 min.
2	C	440 min.
2	D	450 min.
2	E	460 min.
2	F	470 min.
3	blank (*)	480 min.
3	1	490 min.
3	2	500 min.
3	3	510 min.
3	4	520 min.
3	5	530 min.
3	6	540 min.
3	7	550 min.
3	8	560 min.
3	9	570 min.
3	0	580 min.
3	B	590 min.
3	C	600 min.
3	D	610 min.
3	E	620 min.
3	F	630 min.
4	blank (*)	640 min.
4	1	650 min.
4	2	660 min.
4	3	670 min.
4	4	680 min.
4	5	690 min.
4	6	700 min.
↓	↓	↓
F	F	2550 min. = 42 Hr., 30 min.

RF SUPERVISORY TIMERS: RF Supervisory Timers may be programmed for each type of transmitter used. A transmitter will send a transmission every time it is tripped, when there is NO activity, the transmitter sends a status transmission about once an hour. If the receiver does NOT receive ANY signal (a trip or a status) from a transmitter in the time specified for transmitter type, a system trouble "E-04-NN" will be displayed at the keypad.

- ☞ 1. Select timer delay from the table shown. Timers are programmed in increments of 10 minutes each. Valid entries are (*)8-FF (80 minutes-2550 min) (2550 minutes = 42 hr,30 min). **WARNING:** Timers have uncertainty of +/-30 minutes.
- ☞ 2. Enter in corresponding address locations above (left and right digits).
- ☞ 3. For a desired *timer not* listed do the following:

$$\begin{array}{r}
 \textcircled{6} \text{ Quotient} \longrightarrow \text{Left Digit} \\
 16 \overline{) 100} \\
 \underline{-96} \\
 \textcircled{4} \text{ Remainder} \longrightarrow \text{Right Digit}
 \end{array}$$

- A. Choose a desired timer (intervals of 10), ex: 1440 min. (24 Hours)
- B. Divide it by 10, ex: 1440/10 = 144
- C. Divide it by 16

NOTE: These timers apply only to Supervised RF Transmitters (see RF Transmitters in Easy Menu Driven Mode Programming).

EXTERNAL RELAY CONTROL / RELAYS 1-24 (ADDRESS 3778-3801 & 2800-2895)

ADDRESS 3778 & 2800-2803 (RELAY/entry 1)									
3778		2800		2801		2802		2803	
L	R	L	R			L	R	L	R

ADDRESS 3779 & 2804-2807 (RELAY/entry 2)									
3779		2804		2805		2806		2807	
L	R	L	R			L	R	L	R

ADDRESS 3780 & 2808-2811 (RELAY/entry 3)									
3780		2808		2809		2810		2811	
L	R	L	R			L	R	L	R

ADDRESS 3781 & 2812-2815 (RELAY/entry 4)									
3781		2812		2813		2814		2815	
L	R	L	R			L	R	L	R

ADDRESS 3782 & 2816-2819 (RELAY/entry 5)									
3782		2816		2817		2818		2819	
L	R	L	R			L	R	L	R

ADDRESS 3783 & 2820-2823 (RELAY/entry 6)									
3783		2820		2821		2822		2823	
L	R	L	R			L	R	L	R

ADDRESS 3784 & 2824-2827 (RELAY/entry 7)									
3784		2824		2825		2826		2827	
L	R	L	R			L	R	L	R

ADDRESS 3785 & 2828-2831 (RELAY/entry 8)									
3785		2828		2829		2830		2831	
L	R	L	R			L	R	L	R

ADDRESS 3786 & 2832-2835 (RELAY/entry 9)									
3786		2832		2833		2834		2835	
L	R	L	R			L	R	L	R

ADDRESS 3787 & 2836-2839 (RELAY/entry 10)									
3787		2836		2837		2838		2839	
L	R	L	R			L	R	L	R

ADDRESS 3788 & 2840-2843 (RELAY entry 11)									
3788		2840		2841		2842		2843	
L	R	L	R			L	R	L	R

ADDRESS 3789 & 2844-2847 (RELAY/entry 12)									
3789		2844		2845		2846		2847	
L	R	L	R			L	R	L	R

ADDRESS 3790 & 2848-2851 (RELAY/entry 13)									
3790		2848		2849		2850		2851	
L	R	L	R			L	R	L	R

ADDRESS 3791 & 2852-2855 (RELAY/entry 14)									
3791		2852		2853		2854		2855	
L	R	L	R			L	R	L	R

ADDRESS 3792 & 2856-2859 (RELAY/entry 15)									
3792		2856		2857		2858		2859	
L	R	L	R			L	R	L	R

ADDRESS 3793 & 2860-2863 (RELAY/entry 16)									
3793		2860		2861		2862		2863	
L	R	L	R			L	R	L	R

ADDRESS 3794 & 2864-2867 (RELAY/entry 17)									
3794		2864		2865		2866		2867	
L	R	L	R			L	R	L	R

ADDRESS 3795 & 2868-2871 (RELAY/entry 18)									
3795		2868		2869		2870		2871	
L	R	L	R			L	R	L	R

ADDRESS 3796 & 2872-2875 (RELAY/entry 19)									
3796		2872		2873		2874		2875	
L	R	L	R			L	R	L	R

ADDRESS 3797 & 2876-2879 (RELAY/entry 20)									
3797		2876		2877		2878		2879	
L	R	L	R			L	R	L	R

ADDRESS 3798 & 2880-2883 (RELAY/entry 21)									
3798		2880		2881		2882		2883	
L	R	L	R			L	R	L	R

ADDRESS 3799 & 2884-2887 (RELAY/entry 22)									
3799		2884		2885		2886		2887	
L	R	L	R			L	R	L	R

ADDRESS 3800 & 2888-2891 (RELAY/entry 23)									
3800		2888		2889		2890		2891	
L	R	L	R			L	R	L	R

ADDRESS 3801 & 2892-2895 (RELAY/entry 24)									
3801		2892		2893		2894		2895	
L	R	L	R			L	R	L	R

[Default = blank (•) blank (•) from address 3778-3801 & 2800-2895]

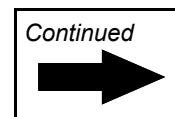

EXTERNAL RELAY CONTROL



EXTERNAL RELAY CONTROL

RELAY EVENT OPTIONS									
RELAY #		AREA		Timeout		Event ID		COND.	
L	R	L	R			L	R	L	R

To program, follow the 5 steps below:

STEP 1: RELAY # OPTIONS: Each relay/entry can be assigned to any of the 24 available external relays from Relay Module RM3008. Multiple entries can drive the same External Relay.

☞ Select the relay number from **Table 1** (shown on next page); enter in corresponding left and right digit address locations.

Note: Entries 01-24 correspond to relays 1 through 24. If entries are zero, zero (00), then relay number is identical to the relay/entry address table number, in the selected address table(s) above.

STEP 2: AREA OPTIONS: Each relay/entry can be assigned to Area 1 or 2 or both areas.

☞ Select the area from **Table 2** (shown on next page); enter in corresponding left and right digit address locations.

STEP 3: TIMEOUTS: Each relay event can be assigned a timeout depending on Alarm Type option.

☞ If Alarm Type is selected for timeout in minutes or seconds, enter the 3-digit **timeout duration** in corresponding address location. To choose seconds or minutes, see step 5A below. 254 is maximum entry.

STEP 4: EVENT ID CODES: Each relay event can be assigned any of the available event IDs from the table.

☞ Select 2-digit Event ID from **Table 4** (see page 50); enter in corresponding address locations (left and right digit).

STEP 5: RELAY EVENT CONDITION OPTIONS: Each relay event can be assigned an alarm type; and an activation condition; also, select a timeout type for each.

☞ 5A. Select Alarm Type and Timeout Type from **Table 5A** (see page 51); enter in corresponding address location (left digit).
NOTE: Select Timeout from Step 3.

☞ 5B. Select Activation from from **Table 5B** (see page 51); enter in corresponding address location (right digit).

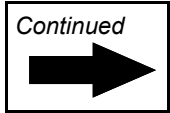
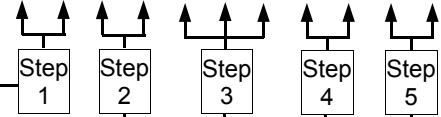

EXTERNAL RELAY CONTROL

RELAY EVENT OPTIONS				
RELAY #	AREA	TIMEOUT	EVENT ID	COND.
See Table 1 below	See Table 2 below	See Table 3 below	See Table 4 on page 50	See Tables 5A & 5B on page 51

TABLE 1 RELAY MAPPING		
DATA ENTRIES		RELAY #
LEFT	RIGHT	
blank (*)	blank (*)	None *
blank (*)	1	1
blank (*)	2	2
blank (*)	3	3
blank (*)	4	4
blank (*)	5	5
blank (*)	6	6
blank (*)	7	7
blank (*)	8	8
blank (*)	9	9
blank (*)	0	10
blank (*)	B	11
blank (*)	C	12
blank (*)	D	13
blank (*)	E	14
blank (*)	F	15
1	blank (*)	16
1	1	17
1	2	18
1	3	19
1	4	20
1	5	21
1	6	22
1	7	23
1	8	24

* Note: [blank (*) blank (*)] option affects the relay with the same entry number. All other options affect the relay number specified. Ex: Suppose Relay/Entry 1 is mapped to External Relay 1 and Relay/Entry 2 is mapped to External Relay 24. The data entries are as follows: Address 3778 = [blank (*) blank (*)] and Address 3779 = [1C].

Areas
1-2

TABLE 2 (AREAS 1-2) AREAS CONTROLLING RELAY SHUTOFF ON DISARM		
RIGHT DATA ENTRY	AREA 1	AREA 2
blank (*)	NONE	
1	Y	
2		Y
3	Y	Y

Note: "Y" indicates option is enabled.

TIMEOUTS: Each relay event can be assigned a timeout depending on Alarm Type option.

 If Alarm Type is selected for timeout in minutes or seconds, enter the 3-digit **time-out duration** in corresponding address location. To choose seconds or minutes, see step 5A on page 51. Maximum entry is 254.

For a desired relay not listed:
A. Choose a desired relay, ex: 60
B. Divide it by 16

$$\begin{array}{r}
 \textcircled{3} \text{ Quotient} \longrightarrow \text{Left Digit} \\
 16 \overline{) 60} \\
 \underline{-48} \\
 \textcircled{C} \text{ Remainder} \longrightarrow \text{Right Digit}
 \end{array}$$

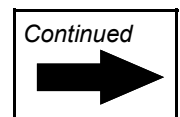

EXTERNAL RELAY CONTROL

STEP 4: EVENT ID CODES: Each relay event can be assigned any of the available event IDs from the table.

Select 2-digit Event ID from **Table 4** (below); enter in corresponding address locations (left and right digit).

TABLE 4		
EVENT ID CODES		
DATA ENTRIES		OPTION
LEFT	RIGHT	
blank (+)	blank (+)	Area 1 Arm
blank (+)	1	Area 2 Arm
C	blank (+)	Area 1 disarm
C	1	Area 2 disarm
blank (+)	8	Zone 1
blank (+)	9	Zone 2
blank (+)	0	Zone 3
blank (+)	B	Zone 4
blank (+)	C	Zone 5
blank (+)	D	Zone 6
blank (+)	E	Zone 7
blank (+)	F	Zone 8
1	blank (+)	Zone 9
1	1	Zone 10
1	2	Zone 11
1	3	Zone 12
1	4	Zone 13
1	5	Zone 14
1	6	Zone 15
1	7	Zone 16
1	8	Zone 17
1	9	Zone 18
1	0	Zone 19
1	B	Zone 20
1	C	Zone 21
1	D	Zone 22
1	E	Zone 23
1	F	Zone 24
2	blank (+)	Zone 25
2	1	Zone 26
2	2	Zone 27
2	3	Zone 28
2	4	Zone 29
2	5	Zone 30
2	6	Zone 31
2	7	Zone 32
2	8	Zone 33
2	9	Zone 34
2	0	Zone 35
2	B	Zone 36
2	C	Zone 37
2	D	Zone 38
2	E	Zone 39
2	F	Zone 40
3	blank (+)	Zone 41
3	1	Zone 42
3	2	Zone 43
3	3	Zone 44
3	4	Zone 45
3	5	Zone 46
3	6	Zone 47
3	7	Zone 48

6	8	Area 1 Keypad Ambush
6	9	Area 1 Keypad Panic
6	0	Area 1 Keypad Fire
6	B	Area 1 Keypad Medical
6	C	Keypad Tamper
6	D	Area 1 Fail to Open
6	E	Area 1 Fail to Close
7	blank (+)	Area 2 Keypad Ambush
7	1	Area 2 Keypad Panic
7	2	Area 2 Keypad Fire
7	3	Area 2 Keypad Medical
7	5	Area 2 Fail to Open
7	6	Area 2 Fail to Close
0	8	Test Timer
0	0	Bus Fail
0	B	Guarded RAM Fail
0	C	Low Battery
0	D	AC Fail
0	E	EZM Tamper
0	F	Sensor Watch
B	blank (+)	Telco Fault
B	8	Digital Dialer Test
B	9	RESERVED
B	B	Service Message
B	C	Program Change
B	D	RF Receiver Trouble
B	E	Transmitter Tamper
B	F	Transmitter Trouble
D	blank (+)	Keypad Fail
D	1	EZM Fail
D	2	Quickloader Device Control
D	3	System Shutdown
D	4	Quickloader Keypad Reset
D	5	General System Alarm
D	8	Area 1 General System Alarm
D	9	Area 2 General System Alarm
F	blank (+)	Relay Group 1
F	1	Relay Group 2
F	8	Area 1 Entry Delay
F	9	Area 2 Entry Delay

NOTE: Keypad Tamper must be enabled in UL installations using jumper option on keypad.

Continued



STEP 5: RELAY EVENT CONDITION OPTIONS: Each relay event can be assigned an alarm type; and an activation condition; also, select a timeout type for each.

 5A. Select Alarm Type and Timeout Type from **Table 5A** (below); enter in corresponding address location (left digit). **NOTE:** Select Timeout from Step 3.

 5B. Select Activation from from **Table 5B** (below); enter in corresponding address location (right digit).



TABLE 5A		
RELAY EVENT ALARM TYPE OPTIONS		
LEFT DATA ENTRIES	ALARM TYPE	TIMEOUT TYPE
blank (*)	Burglary	Minutes
1	Fire	Minutes
4	Day Zone	Minutes
8	Burglary	Seconds
9	Fire	Seconds
C	Day Zone	Seconds

TABLE 5B	
RELAY EVENT ACTIVATION CONDITIONS	
RIGHT DATA ENTRIES	OPTIONS
1	Alarm
2	Restore
3	Trouble
4	Trouble Restore
5	Follows Open Zone
6	Follows Shorted Zone

NUMBER OF RELAY BOARD MODULES (ADDRESS 3777)

Number of Relay Board Modules	ADDRESS 3777		DATA	Relay Board Module(s)
	LEFT	RIGHT	RIGHT	
	blank (*)		blank (*)	
		1	1	
		2	2	
		3	3	

RELAY BOARD MODULES: Up to 3 External Relay Board Modules (RM3008) may be programmed.

-  1. Select the number of relay modules from the table shown.
-  2. Enter in corresponding right digit address location shown (left digit is not used).

[Default = blank (*) blank (*)]



SYSTEM RESET OPTIONS (ADDRESS 4091-4093)

4091 XX

GEM-RP1CAe2/GEM-K1CA Keypad

Clear Dealer Program (Erases Dealer Program)



This erases the dealer program. Use this feature to start a customized default program.

4091XX

Access address 4091, then press the or button. Data entry is not allowed.

NOTE: Enter Easy Menu Driven Program Mode to program system again.

4093 XX

GEM-RP1CAe2/GEM-K1CA Keypad

Cold Start (Erases Entire Program)



This erases the entire program (codes, schedules, foreign language configuration, etc), leaving the panel as it came right out of the box.

4093XX

Access address 4093, then press the or button. Data entry is not allowed.

NOTE: Some features (schedules, language configuration) can only be re-programmed with the Downloading Software.

USER PROGRAM MODE

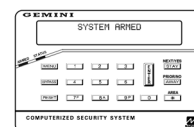

PRELIMINARY INFORMATION

The User Program Mode is covered in detail in the operating instructions for the keypad in use.

- Only Keypad #1 may be used for programming, however this keypad may be located in either area.
- The Program Mode cannot be accessed while the communicator is transmitting except during the first three minutes after power-up.
- After entering codes or data, press the save button. *Data will not be stored into memory unless this button is pressed.*
- If the keypad is in the Program Mode and no activity is detected for longer than 4 minutes, a steady tone will sound.

NOTE: For ease of programming, it is recommended that a GEM K1CA (or GEM-RP1CAe2) be used as Keypad #1. A new GEM-K1CA and a new GEM-RP1CAe2 are automatically configured as Keypad #1. See Keypad Configuration Mode.

Press the button to silence the sounder and exit the User Program Mode.

If a GEM-RP2ASe2/GEM-K2AS keypad is used, configure address jumpers as Keypad #1 (See WI1184).

ACCESSING USER PROGRAM MODE

1. Press  **MENU**
 ← New Panel (Default User Code = 123) →
 Existing Panel (Any Code with User Program Option Enabled)

2. Press  **Until "ACTIVATE PROGRAM Y/N" appears on LCD screen.**

3. Press  **To Enter User Program Mode**

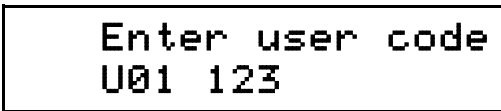

4. Press  **To Exit User Program Mode when finished**

USER CODES





GEM-K1CA Keypad (Direct Entry)



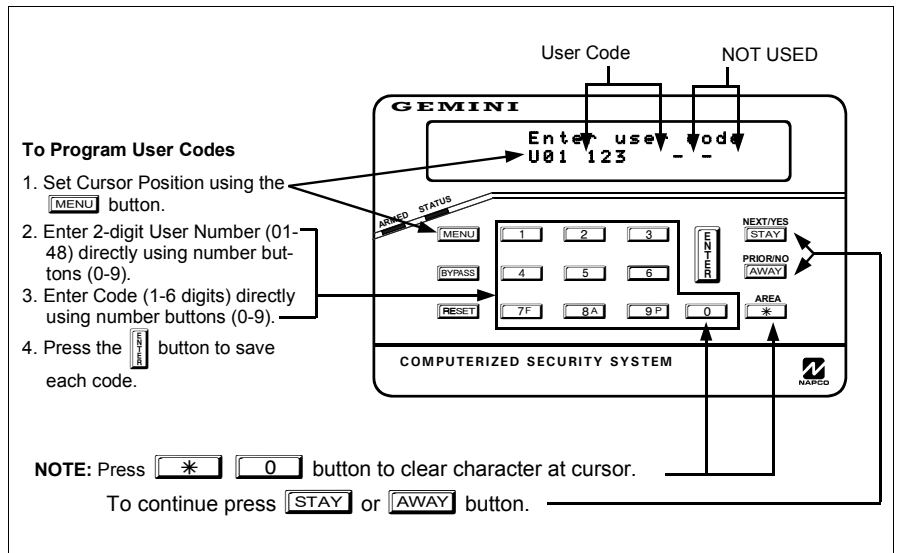

Up to 48 User Codes may be programmed.
NOTE: In this mode, only the code is programmable; the accompanying Area Options must be programmed in the Dealer Program Mode. By default, User 1 is enabled in Area 1 and 2; Users 2-8 are enabled in Area 1, Users 9-16 are enabled in Area 2; Users 17-48 are not enabled in any areas (see page 10).

 Use the  button to place the cursor over the User Number.







To Program User Codes



1. Set Cursor Position using the  button.
2. Enter 2-digit User Number (01-48) directly using number buttons (0-9).
3. Enter Code (1-6 digits) directly using number buttons (0-9).
4. Press the  button to save each code.

NOTE: Press   button to clear character at cursor.
 To continue press  or  button.

Programming User Codes with GEM-K1CA Keypad

 Enter a User Number (01-48) using the number buttons. The cursor will then advance to the User Code and read the existing code, if any.

 Enter the new User Code using the number buttons (0-9). If an old code is displayed, program over it. To erase the digit at the cursor, press   button.

 Press the  button to save the code in memory.

 Repeat this procedure for each user. To proceed to Zone-Description programming, press the NEXT button or the PRIOR button.

USER PROGRAM MODE



ZONE DESCRIPTIONS (GEM-RP1CAE2 / GEM-K1CA KEYPADS)

01-

Enter an identifying description for each zone. Characters are selected by pressing keypad buttons multiple times, "Cell Phone" style. Buttons **[1]** through **[9P]** plus **[0]** and **[*]** are used, as per the following table:

(Direct Entry)

PRESS:	CHARACTERS DISPLAYED IN SEQUENCE	HOLD [*] AND PRESS:	CHARACTERS DISPLAYED IN SEQUENCE
[1]	ABC1	[1]	abc1
[2]	DEF2	[2]	def2
[3]	GHI3	[3]	ghi3
[4]	JKL4	[4]	jkl4
[5]	MNO5	[5]	mno5
[6]	PQR6	[6]	pqr6
[7F]	STU7	[7F]	stu7
[8A]	VWX8	[8A]	vwx8
[9P]	YZ90	[9P]	yz90
[0]	(SPACE) - . () , / : ? #	[0]	(International Characters)

Press **[FUNCTION]** to move cursor right.

Press **[BYPASS]** to move cursor left.

Notes:

1. After releasing the number button for 1 second, the character will be accepted and the cursor advanced to the right.
2. After releasing the number button, if a new number button is pressed before the 1 second window expires, the current character will be accepted and the cursor automatically advanced to the right. The first of the 4 characters of this new number button will be displayed.
3. To erase an existing entry, use **[FUNCTION]** or **[BYPASS]** to move the cursor below the character to be changed. Enter a new character to overwrite the old.
4. To generate lowercase characters, the **[*]** button must be pressed and held down while pressing the number button. If the **[*]** button is released during the 1 second window, the current character will change to upper-case. Press **[]** to save.

To proceed to the next description, place the cursor under the Zone Number (e.g. "1") and press the number that corresponds to the zone. Repeat this procedure until all zones have been programmed. After programming the user codes, press the NEXT button to proceed.

Enter Date
(/ /)

(Direct Entry)

Enter Date (Press the **[MENU]** button to set cursor.)

Enter the current date in the format MM/DD/YY, where MM = the month (01-12); DD=the day (01-31); and YY=the year. Press **[]** to save. Press NEXT button to proceed.

Enter Time
(:)

(Direct Entry)

Enter Time (Press the **[MENU]** button to set cursor.)

Enter the current time in the format HH:MMA/P, where HH=hours (01-12); MM=minutes (00-59). Select Am or Pm by pressing any number button, then press **[]** once again to save.

NOTE: To enter the date and time, GEM-RP1CAe2/GEM-K1CA keypad (version 6 or greater) must be used and "Enable Keypad Time/Date Display" (Address 3874) must be enabled.

KEYPAD CONFIGURATION MODE

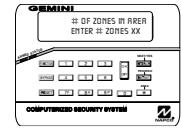

This section will focus on configuring the GEM-RP1CAe2/GEM-K1CA Keypads. If there is more than one keypad in the system, *only Keypad No. 1 may be used for programming.*

KEYPAD INSTALLATION

Two types of keypads may be used with the GEM-P3200: the GEM-RP1CAe2/GEM-K1CA. Each must be assigned an address number (1–7) and each requires its own configuration procedure (see CONFIGURING THE KEYPADS, which follows, and DIRECT ADDRESS KEYPAD AREA OPTIONS). At least 1 keypad must be used; only 1 is required for a single-area Commercial Burglary installation.

GEM-RP1CAe2/GEM-K1CA - is a 2-line combination fire/burglary/access keypad capable of supporting 4 EZM zones and a PGM output. The GEM-RP1CAe2 or GEM-K1CA is recommended for use as Keypad #1. See "Important Note" on page 2 for more information regarding the various buttons on the GEM-RP1CAe2/GEM-K1CA keypads.







CONFIGURING THE KEYPADS

A total of up to 7 keypads may be connected to the panel.

Configuring the GEM-RP1CAe2/GEM-K1CA Keypad





Each GEM-RP1CAe2/GEM-K1CA keypad must be configured for (a) keypad tactile beep; (b) entry sounder; (c) keypad address; (d) compatibility number; (e) EZM address; and (f) zone response.

To enter the Keypad Configuration Mode:

1. Move jumper JP1 (located in the center of the control panel board) from Pins 1-2 (top two) to Pins 2-3 (bottom two). **NOTE:** See Wiring Diagram on page 68.
2. After about 15 seconds, the display will read "XX OUT OF SYSTEM", where XX indicates the keypad address.
3. Press       and proceed as follows. (Repeat the following procedure for all keypads).





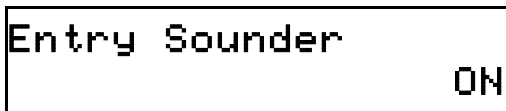

Keypad Tactile Beep

Upon entering the Keypad Configuration Mode, "KEYPAD BEEP ON" will be displayed, indicating that the tactile beep, which sounds when any button is pressed, is on. To turn off the tactile beep, press the  button (the  button will toggle the tactile beep on and off). Press  to continue or press  to exit.



Entry Sounder

To turn off the keypad entry sounder during entry time, press  (the  button will toggle the entry sounder on and off). Press  to continue or press  to exit.





Keypad Address

If more than one keypad is installed, each must be assigned a unique keypad address (that is, no two keypads may be numbered alike):

 Keypads must be numbered consecutively (missing numbers are not permitted)

 Only Keypad No. 1 may be used for programming.

To assign the keypad number, proceed as follows:

1. Enter the assigned keypad number 01–07, then press  to save. A valid number will be acknowledged by a short beep; an invalid number will be rejected by a long beep.
2. Press  to continue or press  to exit.





Compatibility Number

A 4-digit Compatibility Number, if programmed, will restrict this keypad to work on a panel programmed with a matching number.

1. Enter a 4-digit number
2. Press to save. Press the button to continue or press the button to exit.



EZM Address

The keypad's internal EZM (Expansion Zone Module) may be utilized to provide four additional wired zones. Whether used alone or in conjunction with optional GEM-EZM series modules or other keypad EZMs, it must be assigned a unique address (or Group number, see Keypad Programming

Workbook) similar to its keypad address. If no other EZMs are to be used, designate the keypad as Group "01" at the "EZM ADDRESS 00" display. In multiple-EZM systems, enter an assigned group number "01" through "06". (Each EZM must have a unique assigned group number, starting with "01" and proceeding consecutively.) Press the button to continue or press the button to exit.



Zone Response

The normal loop response of each keypad expansion zone is 750mS, however the response time of any zone can be reduced to 50mS as follows.

1. Of the following, circle the number(s) in parentheses associated with the zone(s) to be changed: Zone 1=(1); Zone 2=(2); Zone 3=(4); Zone 4=(8)

2. Add up the circled numbers.

3. At the keypad, enter the sum as a two-digit number "01" through "15" on the display, then press .

Example. Change Zones 2, 3 and 4 to 50mS response.

1. Circle numbers for Zones 2, 3 and 4: (2), (4) and (8).
2. Add up the circled numbers: 2 + 4 + 8 = 14.
3. Enter "14" at the keypad, then press the button.

Press the button to continue or press the button to exit.

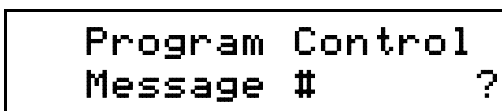

Program Control Message

A code-keypad association can be programmed such that when the code is entered at a specific keypad, a PGM Lug will be activated for 7 seconds, and a selected message will be displayed on this keypad. Six different program control messages can be selected (0-6) as displayed in the following table:

Program Control Message	
0	(No Message)
1	**Enter Now**
2	Door Control
3	Gate Control
4	Light Control
5	Control #1
6	Control #2

1. Enter a message number
2. Press to save.
3. Press the button to continue (the display will loop back through selections, for changes) or press the button to exit the Keypad Configuration Mode (display will read "01 OUT OF SYSTEM").
4. Replace Jumper JP1 across Pins 1-2 (top two).

ALPHABETICAL INDEX

- ABORT DELAY ADDRESS 2406, 19
 ABORT DELAY ZONE OPTION, 30, 31, 32
 AC FAIL REPORT DELAY ADDRESS 2408, 19
 ACCESS CONTROL (PANEL) ON AUX. OUTPUT ADDRESS 2418, 34
 ACCESS CONTROL OPTIONS, 10
 ACCESSING DEALER PROGRAM MODE, 5
 ACCESSING USER PROGRAM MODE, 53
 ACM DOOR #1 AREA (HEX) (ADDRESS 2425-2431), 40
 ACM DOOR AREA OPTIONS (ADDRESS 2784-2787), 39
 ACM GLOBAL FLAGS (ADDRESS 2780), 38
 ACM SCHEDULED FREE ACCESS (ADDRESS 4072-4075), 39
 ACM SYSTEM OPTIONS (ADDRESS 2423), 41
 ACM TIMEOUTS (ADDRESS 2782-2783), 38
 ACM ZONE OPTIONS (ADDRESS 2740-2769), 38
 ACTIVATE DOWNLOAD FUNCTION, 4
 ADDING WIRELESS CAPABILITY, 46
 ADDRESS MODE DISPLAYS, 15
 ALARM ON DAY ZONE ZONE OPTION, 30, 31, 32
 ALARM/TROUBLE REPORTING CODES (ADDRESS 3880-3881), 35
 ALARM/TROUBLE REPORTING CODES ADDRESS 0859-0862, 24
 AMBUSH CODE ADDRESS 0495, 20
 ANSWER ON RING NUMBER ADDRESS 4089, 22
 AREA ARMING OPTIONS (ADDRESS 2650-2651), 44
 AREA ASSIGNMENT & KEYPAD TYPE, 37
 AREA OUTPUT CONTROL OPTIONS (ADDRESS 2700-2739), 45
 AREA SYSTEM EVENT/TROUBLE, 29
 AREA SYSTEM TROUBLE REPORTING OPTIONS (ADDRESS 1120-1137), 29
 AUTHORITY LEVEL, 10
 AUTO BELL TEST ON ARMING ADDRESS 2418, 34
 AUTO BYPASS RE-ENTRY ZONES, 7
 AUTO DISARM REARM DELAY ADDRESS 4083, 20
 AUTO DOWNLOAD ID NO. ADDRESS 1023, 22
 AUTO RESET AFTER BURGL. OUTPUT TIMEOUT ADDRESS 2418, 34
 AUTO RESET ZONE OPTION, 30, 31, 32
 AUTO-BYPASS RE-ENTRY ZONE OPTION, 30, 31, 32
 AUTO-BYPASS ZONE OPTION, 30, 31, 32
 AUTOMATIC INTERIOR BYPASS/EASY EXIT ADDRESS 2421, 35
 AUX OUTPUT ACTIVATED ON ALARM ZONES, 7
 AUX. OUTPUT ACCESS CONTROL TIMEOUT ADDRESS 2402, 19
 AUX. OUTPUT TIMEOUT ADDRESS 2401, 20
 AUXILIARY RELAY, 28, 29
 AUXILIARY RELAY ZONE OPTION, 30, 31, 32
 BACKUP REPORT ON TELCO 2 ADDRESS 1027, 25
 BINARY (BIT) FORMAT, 15
 BIT FORMAT, 15
 BURGLAR KEYPAD TYPE, 37
 BURGL. ALARM OUTPUT TIMEOUT ADDRESS 2403, 20
 BURGL. ALARM OUTPUT ZONE OPTION, 30, 31, 32
 BURGLARY ALARM OUTPUT, 28
 BURGLARY OUTPUT, 29
 CALLBACK METHOD, 4
 CALLBACK TELEPHONE NO. SELECT ADDRESS 1022, 22
 CALLBACK TELEPHONE NUMBER 1 AND 2, 22
 CANCEL A CODE, 11
 CANCEL NEXT TEST TIMER ON ANY REPORT ADDRESS 1027, 25
 CANCELING A CODE, 11
 CENTRAL STATION RECEIVER 1 ACCOUNT NUMBER, 9
 CENTRAL STATION RECEIVER 1 FORMAT, 9
 CENTRAL STATION RECEIVER 1 TELEPHONE NUMBER, 8
 CHANGES FROM PREVIOUS EDITION, 2
 CHANGING OR CANCELING A CODE, 11
 CHIME 2 ZONE OPTION, 30, 31, 32
 CHIME 2 ZONES IN AREA 1, 7
 CHIME ON LUG E4 ADDRESS 2420, 35
 CHIME TIME ADDRESS 2407, 19
 CHIME ZONE OPTION, 30, 31, 32
 CHIME ZONES IN AREA 1, 6
 CLEAR DEALER PROGRAM, 14
 CLEAR DEALER PROGRAM ADDRESS 4091, 52
 CLEAR PROGRAM, 14
 CLOSING REPORT ONLY ON COND. CLOSING (AUTO-BYP.) ADDRESS 2417, 34
 COLD START, 14
 COLD START ADDRESS 4093, 52
 COMPATIBILITY NUMBER, 56
 CONFIGURING THE KEYPADS, 55
 CREATE A NEW CUSTOM DEFAULT PROGRAM, 5
 CS AREA & SYSTEM REPORTING OPTIONS (ADDRESS 1024-1027), 25
 CS RECEIVER 1 FORMAT ADDRESS 0525, 21
 CS RECEIVER 1 OPTIONS ADDRESS 0526, 21
 CS RECEIVER 2 FORMAT ADDRESS 0550, 21
 CS RECEIVER 2 OPTIONS ADDRESS 0551, 21
 CS RECEIVER 3 FORMAT ADDRESS 0575, 21
 CS RECEIVER 3 OPTIONS ADDRESS 0576, 21
 CS RECEIVER FORMAT OPTIONS (ADDRESS 0520, 0521, 0525, 0526, 0550, 0551, 0575 & 0576), 21
 CS RECEIVER TELEPHONE NUMBER 1-3, 22
 CS RECEIVER TELEPHONE NUMBERS (ADDRESS 0527-0546, 0552-0571, 0577-0596), 22
 CS REPORTING CODES (ADDRESS 0859-0883), 24
 CS REPORTING CODES (ADDRESS 0870-0904), 25
 CS SUBSCRIBER ID NUMBERS (ADDRESS 0650-0787), 23
 CS SUBSCRIBER ID NUMBERS (ADDRESS 0790-0857), 24
 CS SYSTEM REPORT OPTIONS ADDRESS 1027, 25
 CS TELCO 1 SUBSCRIBER EVENT ID NUMBERS, 23
 CS TELCO 1 SUBSCRIBER OPENING/CLOSING ID NUMBERS, 23
 CS TELCO 2 SUBSCRIBER EVENT ID NUMBERS (BACKUP REPORTING), 23
 CS TELCO 2 SUBSCRIBER OPENING/CLOSING ID NUMBERS (BACKUP REPORTING), 23
 CS TELCO 3 REPORT DELAY ADDRESS 3902, 19
 CS TELCO 3 SUBSCRIBER EVENT ID NUMBERS, 24
 CS TELCO 3 SUBSCRIBER OPENING/CLOSING ID NUMBERS, 24
 CS USER REPORTING CODES (ADDRESS 1030-1074), 27
 CS ZONE REPORTING CODES (ADDRESS 0910-0957), 26
 CUSTOM DEFAULT PROGRAM, 5
 CUSTOMIZING A DEFAULT PROGRAM, 5
 DATE, 14, 54
 DAY ZONE OPEN ZONE OPTION, 30, 31, 32
 DAY ZONE SHORT ZONE OPTION, 30, 31, 32
 DEALER CODE, 14
 DEALER PROGRAM, 5
 DEALER SECURITY CODE ADDRESS 0500-0502, 20
 DECIMAL FORMAT, 16
 DECIMAL FORMAT DATA ENTRY, 15



ALPHABETICAL INDEX (CONT'D)

- DIALING—ROTARY OR TOUCH-TONE, 25
 DIGITAL DIALER RPT ENTER/EXIT TEST MODE ADDRESS 3905, 35
 DIRECT ADDRESS OVERVIEW, 15
 DIRECT ADDRESS PROGRAM MODE, 15
 DISABLE AC FAIL DETECTION ADDRESS 2420, 35
 DISABLE ANSWERING-MACHINE DOWNLOAD ADDRESS 2419, 34
 DISABLE AREA ENTRY RELAYS ADDRESS 2422, 35
 DISABLE AUTO-RESET ON DAY ZONE ADDRESS 2419, 34
 DISABLE AUTO-UNBYPASS ON DISARMING ADDRESS 2417, 34
 DISABLE AUXOUT CLEAR ON DISARM ADDRESS 2421, 35
 DISABLE CALL WAITING ON FIRST ATTEMPT ADDRESS 3905, 35
 DISABLE CALLBACK DOWNLOAD ADDRESS 2419, 34
 DISABLE CODE REQUIRED FOR EZ BYPASS ADDRESS 2420, 35
 DISABLE CODE REQUIRED FOR FUNC. MODE LVL. 1 ADDRESS 2420, 35
 DISABLE EXIT/ENTRY URGENCY TONE AT KEYPAD ADDRESS 2422, 35
 DISABLE FIRE RESET ADDRESS 2415, 34
 DISABLE KEYPAD FUNCTION-MODE DOWNLOAD ADDRESS 2419, 34
 DISABLE KEYPAD INSTANT BUTTON ADDRESS 2420, 35
 DISABLE SYSTEM TROUBLE AUDIBLE (AT KEYPAD) ADDRESS 2420, 35
 DISABLE WAIT FOR HANDSHAKE ADDRESS 1027, 25
 DISABLE WAIT FOR SILENCE ADDRESS 1027, 25
 DISABLE ZONE FAULT SCROLLING (AUTO STATUS) ADDRESS 2421, 35
 DOUBLE SWIPE TIME, 38
 DOWNLOAD SECURITY CODE ADDRESS 0645-0647, 22
 DOWNLOAD/CALLBACK OPTIONS (ADDRESS 4089, 0600-0619, 0625-0647, 1022 & 1023), 22
 DOWNLOADING FROM A COMPUTER, 4
 EASY MENU DRIVEN PROGRAM MODE, 5
 EASY PROGRAM MENU, 6
 EMERGENCY FREE ACCESS (ADDRESS 4080), 41
 ENABLE ACCESS LOGGING INTO BURGLER LOG ADDRESS 2780, 38
 ENABLE ACM ACCESS ADDRESS 2423, 41
 ENABLE ALL-ZONE-IN-TROUBLE BYPASS ADDRESS 2417, 34
 ENABLE AMBUSH IN USER ASSIGNMENT CODE TYPE ADDRESS 3905, 35
 ENABLE BELL ON EXIT ERROR ADDRESS 3905, 35
 ENABLE BURGLER OUTPUT CHIRP ON KEYFOB?, 7
 ENABLE BURGLER OUTPUT ON TELCO FAIL ONLY WHEN ARMED ADDRESS 2422, 35
 ENABLE BURGLER OUTPUT WARNING ON ENTRY ADDRESS 2418, 34
 ENABLE CANCEL REPORT TO TELCO 3 ADDRESS 3874, 35
 ENABLE CARD PRESENTATION BEEP AND GREEN LED FLASH ADDRESS 2780, 38
 ENABLE CP-01 LIMITS ADDRESS 3905, 35
 ENABLE DAY ZONE WATCH ADDRESS 2416, 34
 ENABLE EXIT DELAY RESTART (SIA-FAR) ADDRESS 3905, 35
 ENABLE EXIT-DELAY RESTART ADDRESS 2419, 34
 ENABLE FACILITY CODE ADDRESS 2780, 38
 ENABLE GEM-PRINT ADDRESS 3874, 35
 ENABLE KEYPAD BLANKING ADDRESS 2423, 41
 ENABLE KEYPAD TIME/DATE DISPLAY ADDRESS 3874, 35
 ENABLE KEYPAD--REMOTE ACCESS LOGGING (ADDRESS 3184), 44
 ENABLE LOCAL ALARM ON FIRST ZONE "AND" TRIP ADDRESS 2419, 34
 ENABLE MANAGER'S MODE OUTSIDE OVERVIEW ADDRESS 2418, 34
 ENABLE NAPCO PROPRIETARY ACCESS FORMAT ADDRESS 2780, 38
 ENABLE NO EOLR ZONES, 7
 ENABLE PRINTING OF ACCESS EVENTS ADDRESS 2780, 38
 ENABLE REPORT EXIT ERR/RECENT CLOSE ADDRESS 3905, 35
 ENABLE SET TIME/DATE MESSAGE ADDRESS 3874, 35
 ENABLE SIA CP-01 FEATURES?, 8
 ENABLE SMOKE DETECTOR DIRTY TROUBLE ADDRESS 2422, 35
 ENABLE TCP/IP COMMUNICATIONS ADDRESS 2423, 41
 ENABLE TELCO LINE FAULT TEST?, 7
 ENABLE TELEPHONE LINE-FAULT TEST ADDRESS 2420, 35
 ENABLE TWO-SWIPE ARMING ADDRESS 2780, 38
 ENABLE USERS TO REPORT, 27
 ENABLE ZONE NUMBER ON PULSE ALARM ADDRESS 0526, 21
 ENABLE ZONE NUMBER ON PULSE ALARM ADDRESS 0551, 21
 ENABLE ZONE NUMBER ON PULSE ALARM ADDRESS 0576, 21
 ENROLL METHOD, 13
 ENTER DATE, 54
 ENTER DEALER PROGRAM MODE, 5
 ENTER PROXIMITY CARD USERS, 12
 ENTER TIME, 54
 ENTER USER CODES, 10
 ENTER ZONE DESCRIPTIONS, 14
 ENTRY DELAY 1 ADDRESS 0001, 19
 ENTRY DELAY 2 ADDRESS 0002, 19
 ENTRY SOUNDER, 55
 ENTRY/EXIT 1 ZONE OPTION, 30, 31, 32
 ENTRY/EXIT 2 ZONE OPTION, 30, 31, 32
 ERASING DEALER PROGRAM, 14
 ERASING DEALER PROGRAM ADDRESS 4091, 52
 ERASING ENTIRE PROGRAM, 14
 ERASING ENTIRE PROGRAM ADDRESS 4093, 52
 EVENT ID CODES, 50
 EXIT DEALER PROGRAM MODE, 14
 EXIT DELAY ADDRESS 0000, 19
 EXIT/ENTRY FOLLOWER ZONE OPTION, 30, 31, 32
 EXIT/ENTRY ZONES IN AREA 1, 6
 EXIT/ENTRY2 ZONES IN AREA 1, 7
 EXPANSION ZONE MODULE, 56
 EXTERNAL RELAY BOARD MODULES, 51
 EXTERNAL RELAY CONTROL / RELAYS 1-24 (ADDRESS 3778-3801 & 2800-2895), 47
 EZM ADDRESS, 56
 EZM GROUP OPTIONS (ADDRESS 2555-2576), 43
 EZM PGM ARMED TERMINAL CONTROL, 43
 50MS LOOP RESPONSE ZONES, 7
 50MS LOOP RESPONSE ZONE OPTION, 30
 FIRE ALARM VERIFICATION ZONE OPTION, 30, 31, 32
 FIRE OUTPUT (LUG E9), 28, 29
 FIRE OUTPUT (LUG E9) ZONE OPTION, 30, 31, 32
 FIRE OUTPUT TIMEOUT ADDRESS 2405, 20
 FIRE ZONE OPTION, 30, 31, 32
 FIRE ZONES IN AREA 1, 6
 FIRMWARE VERSION, 2
 1400HZ HANDSHAKE/KISSOFF ADDRESS 0526, 21
 1400HZ HANDSHAKE/KISSOFF ADDRESS 0551, 21



ALPHABETICAL INDEX (CONT'D)

- 1400HZ HANDSHAKE/KISSOFF ADDRESS 0576, 21
 FUNCTION MODE, 4
 GEM-RP1CAE2/GEM-K1CA KEYPAD EASY PROGRAM MENU, 6
 GENERAL PROGRAMMING STEPS, 18
 GLOBAL SYSTEM EVENT/TROUBLE, 28
 GLOBAL SYSTEM TROUBLE REPORTING OPTIONS (ADDRESS 1082-1116), 28
 HANDSHAKE FOR LOCAL TELEMETRY ADDRESS 1027, 25
 HEXADECIMAL FORMAT, 17
 INCLUDE SEL./GRP. BYPASS IN COND. CLOSING STATUS ADDRESS 2417, 34
 INTERIOR #1 BYPASS ZONE OPTION, 30, 31, 32
 INTERIOR #2 BYPASS ZONE OPTION, 30, 31, 32
 INTERIOR (STAY) BYPASS ZONE OPTION, 30, 31, 32
 INTERIOR 1 NORMALLY BYPASSED ADDRESS 2419, 34
 INTERIOR ZONES IN AREA 1, 6
 KEYFOB TRANSMITTERS AS ARM/DISARM & CONTROL DEVICES, 13
 KEYFOB TRANSMITTERS AS ZONE INPUT DEVICES, 14
 KEYFOB ZONE ASSIGNMENT, 13
 KEYPAD ACCESS EVENT, 44
 KEYPAD ADDRESS, 55
 KEYPAD AREA ASSIGNMENT, 37
 KEYPAD CONFIGURATION MODE, 55
 KEYPAD EASY PROGRAM MENU, 6
 KEYPAD HOME AREA / ACM DOOR #1 AREA (HEX) (ADDRESS 2425-2431), 40
 KEYPAD INSTALLATION, 55
 KEYPAD OPTIONS, 37
 KEYPAD OPTIONS (ADDRESS 2425-2446), 37
 KEYPAD REPORTING CODES ADDRESS 0900-0904, 25
 KEYPAD SOUNDER ON ALARM ZONE OPTION, 30, 31, 32
 KEYPAD SOUNDER ON ALARM ZONES, 7
 KEYPAD SYSTEM CODES (ADDRESS 0490-0495 & 0500-0502), 20
 KEYPAD TACTILE BEEP, 55
 KEYPAD TYPE & AREA ASSIGNMENT, 37
 KEYSWITCH ARMING ZONE OPTION, 30, 31, 32
 LEADING DIGITS FOR PAGER FORMAT ADDRESS 0520, 21
 LEADING DIGITS FOR PAGER FORMAT ADDRESS 0521, 21
 LOCAL DOWNLOAD, 4
 LOCAL DOWNLOADING, 4
 LOCAL JACK, 4
 LOCAL OR CENTRAL STATION REPORTING SYSTEM, 6
 LOOP RESPONSE ZONES, 7
 LUG E4 ARMED AWAY ONLY ADDRESS 2417, 34
 MASTER SECURITY CODE, 5
 MAXIMUM TWO-SWIPE ARM TIME ADDRESS 2782, 38
 MODEM CODES, 26
 NEVER ARM ZONE OPTION, 30, 31, 32
 NEW CUSTOM DEFAULT PROGRAM, 5
 NO EOL RESISTOR ZONE OPTION, 30, 31, 32
 NUMBER OF KEYPADS IN AREA 1, 8
 NUMBER OF KEYPADS IN AREA 2, 8
 NUMBER OF RELAY BOARD MODULES (ADDRESS 3777), 51
 NUMBER OF RF RECEIVERS ADDRESS 3776, 46
 NUMBERING KEYPADS, 55
 OPENING REPORT ONLY AFTER ALARM REPORT ADDRESS 2417, 34
 OPENING/CLOSING REPORTING CODES ADDRESS 0864-0883, 24
 OUTPUT SILENCED, 45
 OUTPUT TIMEOUTS, 20
 OUTPUT TURNS OFF UPON DISARM, 45
 PAGER FORMAT: MAXIMUM PAGES PER SESSION ADDRESS 3904, 36
 PAGER RECALLS ADDRESS 3903, 36
 PANEL ACCESS CODE ADDRESS 0490-0492, 20
 PCI2000/3000 COMPUTER INTERFACE, 4
 PCI-MINI COMPUTER INTERFACE, 4
 POWER-UP DELAY ZONE OPTION, 30, 31, 32
 PRE-ALARM WARNING ZONE OPTION, 30, 31, 32
 PRIORITY AREA ARMING, 44
 PRIORITY WITH BYPASS ZONE OPTION, 30, 31, 32
 PRIORITY ZONE OPTION, 30, 31, 32
 PROGRAM CONTROL MESSAGE, 56
 PROGRAMMING CONVENTIONS USED IN THIS MANUAL, 18
 PROGRAMMING STEPS, 18
 PROGRAMMING TRANSMITTER WIRELESS POINTS, 13
 PROXIMITY CARDS, 12
 PULSE ALARM OUTPUT TIMEOUT ADDRESS 2404, 20
 PULSE BURG OUTPUT CADENCE ADDRESS 2422, 35
 PULSE EVENT CODE, 26
 PULSED ALARM OUTPUT ZONE OPTION, 30, 31, 32
 PULSED BURG. OUTPUT, 28, 29
 QUICK METHOD, 13
 RECEIVER FORMATS, 21
 RELAY BOARD MODULES, 51
 RELAY EVENT ACTIVATION CONDITIONS, 51
 RELAY EVENT ALARM TYPE OPTIONS, 51
 RELAY EVENT CONDITION OPTIONS, 51
 REMOTE ACCESS LOGGING (ADDRESS 3184), 44
 REMOTE DOWNLOADING, 4
 REPORT ALARM TELCO 1, 29
 REPORT ALARM TELCO 3, 29
 REPORT CANCEL WINDOW ADDRESS 4082, 20
 REPORT EVENT TELCO 1, 28
 REPORT EVENT TELCO 3, 28
 REPORT RESTORE TELCO 1, 28
 REPORT RESTORE TELCO 3, 28
 REPORT TO TCP/IP RECEIVER OR AES (TELCO 1) ADDRESS 0526, 21
 REPORT TO TCP/IP RECEIVER OR AES (TELCO 2) ADDRESS 0551, 21
 REPORT TO TCP/IP RECEIVER OR AES (TELCO 3) ADDRESS 0576, 21
 RESET DAY ZONE WITH ARM/DISARM ONLY ADDRESS 2419, 34
 RESET OUTPUT TIMEOUT ADDRESS 2400, 20
 RESET RELAY, 28, 29
 RESET RELAY ZONE OPTION, 30, 31, 32
 RF RECEIVERS & SUPERVISORY TIMER OPTIONS (ADDRESS 3776 & 3760-3775), 46
 RF SUPERVISORY TIMERS, 46
 RF TRANSMITTER POINTS, 13
 RM3008, 51
 ROTARY DIALING BACKUP, 25
 RPT ALARM RESTORE TEL 1 ZONE OPTION, 30, 31, 32
 RPT ALARM RESTORE TEL 3 ZONE OPTION, 30, 31, 32
 RPT ALARM TEL 1 ZONE OPTION, 30, 31, 32
 RPT ALARM TEL 3 ZONE OPTION, 30, 31, 32



ALPHABETICAL INDEX (CONT'D)

- RPT TROUBLE RESTORE TEL 1 ZONE OPTION, 30, 31, 32
 RPT TROUBLE RESTORE TEL 3 ZONE OPTION, 30, 31, 32
 RPT TROUBLE TEL 1 ZONE OPTION, 30, 31, 32
 RPT TROUBLE TEL 3 ZONE OPTION, 30, 31, 32
 SCHEMATIC, 68
 SELECT BELL OUTPUT ON KEYFOB ARMING ADDRESS 2422, 35
 SELECTIVE BYPASS ZONE OPTION, 30, 31, 32
 SENSOR WATCH DELAY ADDRESS 4088, 19
 SENSOR WATCH ZONE OPTION, 30, 31, 32
 SENSOR WATCH ZONES, 7
 SILENCE OUTPUT, 45
 SINGLE DIGIT ONLY ADDRESS 0526, 21
 SINGLE DIGIT ONLY ADDRESS 0551, 21
 SINGLE DIGIT ONLY ADDRESS 0576, 21
 SKIP AUTOMATIC DIAL TONE DETECT ADDRESS 4084, 36
 START EXIT DELAY AFTER RINGBACK ADDRESS 2418, 34
 STATUS REPORT (AUTO-BYP. ZONES ON CLOS.) ADDRESS 2417, 34
 SUM CHECK ADDRESS 0526, 21
 SUM CHECK ADDRESS 0551, 21
 SUM CHECK ADDRESS 0576, 21
 SUPERVISED ALARM OUTPUT ADDRESS 2422, 35
 SUPPRESS "BYPASS" ICON WHEN ARMED ADDRESS 2418, 34
 SWINGER SHUTDOWN ZONE OPTION, 30, 31, 32
 SYSTEM DELAYS & TIMEOUTS (ADDRESS 0000-0002, 2402, 2406, 2414 & 3902), 19
 SYSTEM DELAYS & TIMEOUTS (ADDRESS 2400, 2401, 2403-2405, 4082 & 4083), 20
 SYSTEM DELAYS & TIMEOUTS (ADDRESS 2407, 2408 & 4088), 19
 SYSTEM OPTIONS (ADDRESS 2415-2419), 34
 SYSTEM OPTIONS (ADDRESS 2420-2422, 3874, 3905, 3880-3881), 35
 SYSTEM OPTIONS (ADDRESS 3882-3901, 3903-3905 & 4084), 36
 SYSTEM OPTIONS ADDRESS 2417, 34
 SYSTEM OPTIONS ADDRESS 2418, 34
 SYSTEM OPTIONS ADDRESS 2419, 34
 SYSTEM OPTIONS ADDRESS 2420, 35
 SYSTEM OPTIONS ADDRESS 2421, 35
 SYSTEM OPTIONS ADDRESS 2422, 35
 SYSTEM OPTIONS ADDRESS 3874, 35
 SYSTEM OPTIONS ADDRESS 3905, 35
 SYSTEM PROGRAMMING OPTIONS, 4
 SYSTEM RESET OPTIONS (ADDRESS 4091-4093), 52
 SYSTEM RESPONSE ACTIVATED BY AREA EVENT/TROUBLE, 29
 SYSTEM RESPONSE ACTIVATED BY GLOBAL EVENT/TROUBLE, 28
 TABLE OF CONTENTS, 3
 TACTILE BEEP, 55
 TCP/IP PANEL/SITE INITIATED FUNCTIONS ADDRESS 2423, 41
 TELCO CONNECTION, 4
 TELCO FAIL ONLY WHEN ARMED ADDRESS 2420, 35
 TELEPHONE DIALING PREFIX (DIGITS 1-20) ADDRESS 3882-3901, 36
 TELEPHONE LINE TEST DELAY ADDRESS 2414, 19
 TELEPHONE NUMBERS CS RECEIVER, 22
 3/1 WITH EXTENDED RESTORES ADDRESS 0526, 21
 3/1 WITH EXTENDED RESTORES ADDRESS 0551, 21
 3/1 WITH EXTENDED RESTORES ADDRESS 0576, 21
 TIME, 14, 54
 TOTAL NUMBER OF ZONES IN AREA 1, 6
 TOTAL NUMBER OF ZONES IN AREA 2, 6
 TOUCH-TONE DIALING ONLY ADDRESS 1027, 25
 TOUCH-TONE DIALING W/ROTARY BACKUP ADDRESS 1027, 25
 TRANSMIT "402" OPENING/CLOSING CODE ADDRESS 1027, 25
 TRANSMITTER WIRELESS POINTS, 13
 TROUBLE ON NIGHT OPEN ZONE OPTION, 30, 31, 32
 TROUBLE ON OPEN ZONE OPTION, 30, 31, 32
 TROUBLE ON SHORT ZONE OPTION, 30, 31, 32
 TROUBLE/ALARM REPORTING CODES (ADDRESS 3880-3881), 35
 20MS LOOP RESPONSE ZONE OPTION, 30
 2300HZ HANDSHAKE/KISSOFF ADDRESS 0551, 21
 2300HZ HANDSHAKE/KISSOFF ADDRESS 0576, 21
 24-HOUR ZONES IN AREA 1, 6
 24-HOUR ZONE ZONE OPTION, 30, 31, 32
 2ND CALL ANSWERING MACHINE OVERRIDE ADDRESS 2421, 35
 2-WIRE FIRE ZONES IN AREA 1, 6
 2-WIRE SMOKE DETECTORS ZONE OPTION, 30
 UNLOCK TIME ADDRESS 2783, 38
 USER AREA OPTIONS (ADDRESS 2455-2502), 42
 USER CLOSING TELCO, 27
 USER CODES, 10
 USER CODES, 53
 USER OPENING TELCO, 27
 USER OPTIONS, 10
 USER PROGRAM MODE, 52
 VERI-PHONE ZONES PRIORITY OVER ALARMS ADDRESS 2421, 35
 VERI-PHONE ZONES TRIP AUX. OUTPUT ADDRESS 2421, 35
 VERI-PHONE ZONES TRIP FIRE OUTPUT ADDRESS 2421, 35
 WIRELESS SMOKE LOW BATTERY RESOUND ADDRESS 2422, 35
 WIRELESS SUPERVISORY ADDRESS 3880, 35
 WIRELESS TAMPER ADDRESS 3881, 35
 WIRELESS TROUBLE TO TELCO 1 ADDRESS 3874, 35
 WIRELESS TROUBLE TO TELCO 3 ADDRESS 3874, 35
 WIRING DIAGRAM, 68
 WIZARD KEYPAD TYPE, 37
 ZONE ANDING GROUP 1 ZONE OPTION, 30, 31, 32
 ZONE ANDING GROUP 2 ZONE OPTION, 30, 31, 32
 ZONE AREA 1 ZONE OPTION, 30, 31, 32
 ZONE AREA 2 ZONE OPTION, 30, 31, 32
 ZONE DESCRIPTIONS, 54
 ZONE INPUT DEVICES, 14
 ZONE OPTIONS / ZONES 1-16 (ADDRESS 1200-1386), 30
 ZONE OPTIONS / ZONES 1-48 (ADDRESS 1200-1786), 33
 ZONE OPTIONS / ZONES 17-32 (ADDRESS 1402-1586), 31
 ZONE OPTIONS / ZONES 33-48 (ADDRESS 1602-1786), 32
 ZONE RESPONSE, 56

ADDRESS NUMBER INDEX

ADDRESS 0000.....	EXIT DELAY	19
ADDRESS 0000-0002	SYSTEM DELAYS & TIMEOUTS.....	19
ADDRESS 0001.....	ENTRY DELAY 1	19
ADDRESS 0002.....	ENTRY DELAY 2	19
ADDRESS 0490-0492	PANEL ACCESS CODE.....	20
ADDRESS 0490-0495	KEYPAD SYSTEM CODES	20
ADDRESS 0495.....	AMBUSH CODE.....	20
ADDRESS 0500-0502	DEALER SECURITY CODE.....	20
ADDRESS 0500-0502	KEYPAD SYSTEM CODES	20
ADDRESS 0520.....	CS RECEIVER FORMAT OPTIONS	21
ADDRESS 0520.....	LEADING DIGITS FOR PAGER FORMAT	21
ADDRESS 0521.....	CS RECEIVER FORMAT OPTIONS	21
ADDRESS 0521.....	LEADING DIGITS FOR PAGER FORMAT	21
ADDRESS 0525.....	CS RECEIVER 1 FORMAT	21
ADDRESS 0525.....	CS RECEIVER FORMAT OPTIONS	21
ADDRESS 0526.....	CS RECEIVER 1 OPTIONS	21
ADDRESS 0526.....	CS RECEIVER FORMAT OPTIONS	21
ADDRESS 0526.....	ENABLE ZONE NUMBER ON PULSE ALARM.....	21
ADDRESS 0526.....	1400HZ HANDSHAKE/KISSOFF	21
ADDRESS 0526.....	REPORT TO TCP/IP RECEIVER OR AES (TELCO 1)	21
ADDRESS 0526.....	SINGLE DIGIT ONLY	21
ADDRESS 0526.....	SUM CHECK.....	21
ADDRESS 0526.....	3/1 WITH EXTENDED RESTORES	21
ADDRESS 0527-0546	CS RECEIVER TELEPHONE NUMBERS.....	22
ADDRESS 0550.....	CS RECEIVER 2 FORMAT	21
ADDRESS 0550.....	CS RECEIVER FORMAT OPTIONS	21
ADDRESS 0551.....	CS RECEIVER 2 OPTIONS	21
ADDRESS 0551.....	CS RECEIVER FORMAT OPTIONS	21
ADDRESS 0551.....	ENABLE ZONE NUMBER ON PULSE ALARM.....	21
ADDRESS 0551.....	1400HZ HANDSHAKE/KISSOFF	21
ADDRESS 0551.....	REPORT TO TCP/IP RECEIVER OR AES (TELCO 2)	21
ADDRESS 0551.....	SINGLE DIGIT ONLY	21
ADDRESS 0551.....	SUM CHECK.....	21
ADDRESS 0551.....	3/1 WITH EXTENDED RESTORES	21
ADDRESS 0551.....	2300HZ HANDSHAKE/KISSOFF	21
ADDRESS 0552-0571	CS RECEIVER TELEPHONE NUMBERS.....	22
ADDRESS 0575.....	CS RECEIVER 3 FORMAT	21
ADDRESS 0575.....	CS RECEIVER FORMAT OPTIONS	21
ADDRESS 0576.....	CS RECEIVER 3 OPTIONS	21
ADDRESS 0576.....	CS RECEIVER FORMAT OPTIONS	21
ADDRESS 0576.....	ENABLE ZONE NUMBER ON PULSE ALARM.....	21
ADDRESS 0576.....	1400HZ HANDSHAKE/KISSOFF	21
ADDRESS 0576.....	REPORT TO TCP/IP RECEIVER OR AES (TELCO 3)	21
ADDRESS 0576.....	SINGLE DIGIT ONLY	21
ADDRESS 0576.....	SUM CHECK.....	21
ADDRESS 0576.....	3/1 WITH EXTENDED RESTORES	21
ADDRESS 0576.....	2300HZ HANDSHAKE/KISSOFF	21



ADDRESS NUMBER INDEX (CONT'D)

ADDRESS 0577-0596	CS RECEIVER TELEPHONE NUMBERS	22
ADDRESS 0600-0619	DOWNLOAD/CALLBACK OPTIONS	22
ADDRESS 0625-0647	DOWNLOAD/CALLBACK OPTIONS	22
ADDRESS 0645-0647	DOWNLOAD SECURITY CODE	22
ADDRESS 0650-0787	CS SUBSCRIBER ID NUMBERS	23
ADDRESS 0790-0857	CS SUBSCRIBER ID NUMBERS	24
ADDRESS 0859-0862	ALARM/TROUBLE REPORTING CODES	24
ADDRESS 0859-0883	CS REPORTING CODES	24
ADDRESS 0864-0883	OPENING/CLOSING REPORTING CODES	24
ADDRESS 0870-0904	CS REPORTING CODES	25
ADDRESS 0900-0904	KEYPAD REPORTING CODES	25
ADDRESS 0910-0957	CS ZONE REPORTING CODES	26
ADDRESS 1022	CALLBACK TELEPHONE NO. SELECT	22
ADDRESS 1022	DOWNLOAD/CALLBACK OPTIONS	22
ADDRESS 1023	AUTO DOWNLOAD ID NO.	22
ADDRESS 1023	DOWNLOAD/CALLBACK OPTIONS	22
ADDRESS 1024-1027	CS AREA & SYSTEM REPORTING OPTIONS	25
ADDRESS 1027	BACKUP REPORT ON TELCO 2	25
ADDRESS 1027	CANCEL NEXT TEST TIMER ON ANY REPORT	25
ADDRESS 1027	CS SYSTEM REPORT OPTIONS	25
ADDRESS 1027	DISABLE WAIT FOR HANDSHAKE	25
ADDRESS 1027	DISABLE WAIT FOR SILENCE	25
ADDRESS 1027	HANDSHAKE FOR LOCAL TELEMTRY	25
ADDRESS 1027	TOUCH-TONE DIALING ONLY	25
ADDRESS 1027	TOUCH-TONE DIALING W/ROTARY BACKUP	25
ADDRESS 1027	TRANSMIT "402" OPENING/CLOSING CODE	25
ADDRESS 1030-1074	CS USER REPORTING CODES	27
ADDRESS 1082-1116	GLOBAL SYSTEM TROUBLE REPORTING OPTIONS	28
ADDRESS 1120-1137	AREA SYSTEM TROUBLE REPORTING OPTIONS	29
ADDRESS 1200-1386	ZONE OPTIONS / ZONES 1-16	30
ADDRESS 1200-1786	ZONE OPTIONS / ZONES 1-48	33
ADDRESS 1402-1586	ZONE OPTIONS / ZONES 17-32	31
ADDRESS 1602-1786	ZONE OPTIONS / ZONES 33-48	32
ADDRESS 2400	RESET OUTPUT TIMEOUT	20
ADDRESS 2400	SYSTEM DELAYS & TIMEOUTS	20
ADDRESS 2401	AUX. OUTPUT TIMEOUT	20
ADDRESS 2401	SYSTEM DELAYS & TIMEOUTS	20
ADDRESS 2402	AUX. OUTPUT ACCESS CONTROL TIMEOUT	19
ADDRESS 2402	SYSTEM DELAYS & TIMEOUTS	19
ADDRESS 2403	BURG. ALARM OUTPUT TIMEOUT	20
ADDRESS 2403-2405	SYSTEM DELAYS & TIMEOUTS	20
ADDRESS 2404	PULSE ALARM OUTPUT TIMEOUT	20
ADDRESS 2405	FIRE OUTPUT TIMEOUT	20
ADDRESS 2406	ABORT DELAY	19
ADDRESS 2406	SYSTEM DELAYS & TIMEOUTS	19
ADDRESS 2407	CHIME TIME	19
ADDRESS 2407	SYSTEM DELAYS & TIMEOUTS	19

ADDRESS NUMBER INDEX (CONT'D)

ADDRESS 2408.....	AC FAIL REPORT DELAY	19
ADDRESS 2408.....	SYSTEM DELAYS & TIMEOUTS.....	19
ADDRESS 2414.....	SYSTEM DELAYS & TIMEOUTS.....	19
ADDRESS 2414.....	TELEPHONE LINE TEST DELAY	19
ADDRESS 2415.....	DISABLE FIRE RESET	34
ADDRESS 2415-2419	SYSTEM OPTIONS	34
ADDRESS 2416.....	ENABLE DAY ZONE WATCH.....	34
ADDRESS 2417.....	CLOSING REPORT ONLY ON COND. CLOSING (AUTO-BYP.).....	34
ADDRESS 2417.....	DISABLE AUTO-UNBYPASS ON DISARMING	34
ADDRESS 2417.....	ENABLE ALL-ZONE-IN-TROUBLE BYPASS.....	34
ADDRESS 2417.....	INCLUDE SEL./GRP. BYPASS IN COND. CLOSING STATUS	34
ADDRESS 2417.....	LUG E4 ARMED AWAY ONLY.....	34
ADDRESS 2417.....	OPENING REPORT ONLY AFTER ALARM REPORT.....	34
ADDRESS 2417.....	STATUS REPORT (AUTO-BYP. ZONES ON CLOS.).....	34
ADDRESS 2417.....	SYSTEM OPTIONS	34
ADDRESS 2418.....	ACCESS CONTROL (PANEL) ON AUX. OUTPUT	34
ADDRESS 2418.....	AUTO BELL TEST ON ARMING.....	34
ADDRESS 2418.....	AUTO RESET AFTER BURG. OUTPUT TIMEOUT	34
ADDRESS 2418.....	ENABLE BURG. OUTPUT WARNING ON ENTRY	34
ADDRESS 2418.....	ENABLE MANAGER'S MODE OUTSIDE OVERVIEW	34
ADDRESS 2418.....	START EXIT DELAY AFTER RINGBACK.....	34
ADDRESS 2418.....	SUPPRESS "BYPASS" ICON WHEN ARMED.....	34
ADDRESS 2418.....	SYSTEM OPTIONS	34
ADDRESS 2419.....	DISABLE ANSWERING-MACHINE DOWNLOAD.....	34
ADDRESS 2419.....	DISABLE AUTO-RESET ON DAY ZONE.....	34
ADDRESS 2419.....	DISABLE CALLBACK DOWNLOAD.....	34
ADDRESS 2419.....	DISABLE KEYPAD FUNCTION-MODE DOWNLOAD.....	34
ADDRESS 2419.....	ENABLE EXIT-DELAY RESTART.....	34
ADDRESS 2419.....	ENABLE LOCAL ALARM ON FIRST ZONE "AND" TRIP	34
ADDRESS 2419.....	INTERIOR 1 NORMALLY BYPASSED	34
ADDRESS 2419.....	RESET DAY ZONE WITH ARM/DISARM ONLY.....	34
ADDRESS 2419.....	SYSTEM OPTIONS	34
ADDRESS 2420.....	CHIME ON LUG E4.....	35
ADDRESS 2420.....	DISABLE AC FAIL DETECTION.....	35
ADDRESS 2420.....	DISABLE CODE REQUIRED FOR EZ BYPASS.....	35
ADDRESS 2420.....	DISABLE CODE REQUIRED FOR FUNC. MODE LVL. 1.....	35
ADDRESS 2420.....	DISABLE KEYPAD INSTANT BUTTON.....	35
ADDRESS 2420.....	DISABLE SYSTEM TROUBLE AUDIBLE (AT KEYPAD)	35
ADDRESS 2420.....	ENABLE TELEPHONE LINE-FAULT TEST	35
ADDRESS 2420.....	SYSTEM OPTIONS	35
ADDRESS 2420.....	TELCO FAIL ONLY WHEN ARMED	35
ADDRESS 2420-2422	SYSTEM OPTIONS	35
ADDRESS 2421.....	AUTOMATIC INTERIOR BYPASS/EASY EXIT.....	35
ADDRESS 2421.....	DISABLE AUXOUT CLEAR ON DISARM	35
ADDRESS 2421.....	DISABLE ZONE FAULT SCROLLING (AUTO STATUS)	35
ADDRESS 2421.....	SYSTEM OPTIONS	35
ADDRESS 2421.....	2ND CALL ANSWERING MACHINE OVERRIDE	35



ADDRESS NUMBER INDEX (CONT'D)

ADDRESS 2421.....	VERI-PHONE ZONES PRIORITY OVER ALARMS	35
ADDRESS 2421.....	VERI-PHONE ZONES TRIP AUX. OUTPUT	35
ADDRESS 2421.....	VERI-PHONE ZONES TRIP FIRE OUTPUT	35
ADDRESS 2422.....	DISABLE AREA ENTRY RELAYS	35
ADDRESS 2422.....	DISABLE EXIT/ENTRY URGENCY TONE AT KEYPAD	35
ADDRESS 2422.....	ENABLE BURG. OUTPUT ON TELCO FAIL ONLY WHEN ARMED	35
ADDRESS 2422.....	ENABLE SMOKE DETECTOR DIRTY TROUBLE	35
ADDRESS 2422.....	PULSE BURG OUTPUT CADENCE	35
ADDRESS 2422.....	SELECT BELL OUTPUT ON KEYFOB ARMING	35
ADDRESS 2422.....	SUPERVISED ALARM OUTPUT	35
ADDRESS 2422.....	SYSTEM OPTIONS	35
ADDRESS 2422.....	WIRELESS SMOKE LOW BATTERY RESOUND.....	35
ADDRESS 2423.....	ACM SYSTEM OPTIONS.....	41
ADDRESS 2423.....	ENABLE ACM ACCESS.....	41
ADDRESS 2423.....	ENABLE KEYPAD BLANKING.....	41
ADDRESS 2423.....	ENABLE TCP/IP COMMUNICATIONS.....	41
ADDRESS 2423.....	TCP/IP PANEL/SITE INITIATED FUNCTIONS	41
ADDRESS 2425-2431	ACM DOOR #1 AREA (HEX)	40
ADDRESS 2425-2431	KEYPAD HOME AREA / ACM DOOR #1 AREA (HEX).....	40
ADDRESS 2425-2446	KEYPAD OPTIONS.....	37
ADDRESS 2455-2502	USER AREA OPTIONS.....	42
ADDRESS 2555-2576	EZM GROUP OPTIONS.....	43
ADDRESS 2650-2651	AREA ARMING OPTIONS	44
ADDRESS 2700-2739	AREA OUTPUT CONTROL OPTIONS.....	45
ADDRESS 2740-2769	ACM ZONE OPTIONS	38
ADDRESS 2780.....	ACM GLOBAL FLAGS	38
ADDRESS 2780.....	ENABLE ACCESS LOGGING INTO BURG LOG.....	38
ADDRESS 2780.....	ENABLE CARD PRESENTATION BEEP AND GREEN LED FLASH.....	38
ADDRESS 2780.....	ENABLE FACILITY CODE	38
ADDRESS 2780.....	ENABLE NAPCO PROPRIETARY ACCESS FORMAT	38
ADDRESS 2780.....	ENABLE PRINTING OF ACCESS EVENTS	38
ADDRESS 2780.....	ENABLE TWO-SWIPE ARMING.....	38
ADDRESS 2782.....	MAXIMUM TWO-SWIPE ARM TIME.....	38
ADDRESS 2782-2783	ACM TIMEOUTS.....	38
ADDRESS 2783.....	UNLOCK TIME.....	38
ADDRESS 2784-2787	ACM DOOR AREA OPTIONS	39
ADDRESS 2800-2895	EXTERNAL RELAY CONTROL / RELAYS 1-24	47
ADDRESS 3184.....	ENABLE KEYPAD--REMOTE ACCESS LOGGING	44
ADDRESS 3184.....	REMOTE ACCESS LOGGING.....	44
ADDRESS 3760-3775	RF RECEIVERS & SUPERVISORY TIMER OPTIONS.....	46
ADDRESS 3776.....	NUMBER OF RF RECEIVERS.....	46
ADDRESS 3776.....	RF RECEIVERS & SUPERVISORY TIMER OPTIONS.....	46
ADDRESS 3777.....	NUMBER OF RELAY BOARD MODULES.....	51
ADDRESS 3778-3801	EXTERNAL RELAY CONTROL / RELAYS 1-24	47
ADDRESS 3874.....	ENABLE CANCEL REPORT TO TELCO 3	35
ADDRESS 3874.....	ENABLE GEM-PRINT	35
ADDRESS 3874.....	ENABLE KEYPAD TIME/DATE DISPLAY.....	35

ADDRESS NUMBER INDEX (CONT'D)

ADDRESS 3874.....	ENABLE SET TIME/DATE MESSAGE.....	35
ADDRESS 3874.....	SYSTEM OPTIONS.....	35
ADDRESS 3874.....	SYSTEM OPTIONS.....	35
ADDRESS 3874.....	WIRELESS TROUBLE TO TELCO 1.....	35
ADDRESS 3874.....	WIRELESS TROUBLE TO TELCO 3.....	35
ADDRESS 3880.....	WIRELESS SUPERVISORY.....	35
ADDRESS 3880-3881.....	ALARM/TROUBLE REPORTING CODES.....	35
ADDRESS 3880-3881.....	SYSTEM OPTIONS.....	35
ADDRESS 3880-3881.....	TROUBLE/ALARM REPORTING CODES.....	35
ADDRESS 3881.....	WIRELESS TAMPER.....	35
ADDRESS 3882-3901.....	SYSTEM OPTIONS.....	36
ADDRESS 3882-3901.....	TELEPHONE DIALING PREFIX (DIGITS 1-20).....	36
ADDRESS 3902.....	CS TELCO 3 REPORT DELAY.....	19
ADDRESS 3902.....	SYSTEM DELAYS & TIMEOUTS.....	19
ADDRESS 3903.....	PAGER RECALLS.....	36
ADDRESS 3903-3905.....	SYSTEM OPTIONS.....	36
ADDRESS 3904.....	PAGER FORMAT: MAXIMUM PAGES PER SESSION.....	36
ADDRESS 3905.....	DIGITAL DIALER RPT ENTER/EXIT TEST MODE.....	35
ADDRESS 3905.....	DISABLE CALL WAITING ON FIRST ATTEMPT.....	35
ADDRESS 3905.....	ENABLE AMBUSH IN USER ASSIGNMENT CODE TYPE.....	35
ADDRESS 3905.....	ENABLE BELL ON EXIT ERROR.....	35
ADDRESS 3905.....	ENABLE CP-01 LIMITS.....	35
ADDRESS 3905.....	ENABLE EXIT DELAY RESTART (SIA-FAR).....	35
ADDRESS 3905.....	ENABLE REPORT EXIT ERR/RECENT CLOSE.....	35
ADDRESS 3905.....	SYSTEM OPTIONS.....	35
ADDRESS 3905.....	SYSTEM OPTIONS.....	35
ADDRESS 4072-4075.....	ACM SCHEDULED FREE ACCESS.....	39
ADDRESS 4080.....	EMERGENCY FREE ACCESS.....	41
ADDRESS 4082.....	REPORT CANCEL WINDOW.....	20
ADDRESS 4082.....	SYSTEM DELAYS & TIMEOUTS.....	20
ADDRESS 4083.....	AUTO DISARM REARM DELAY.....	20
ADDRESS 4083.....	SYSTEM DELAYS & TIMEOUTS.....	20
ADDRESS 4084.....	SKIP AUTOMATIC DIAL TONE DETECT.....	36
ADDRESS 4084.....	SYSTEM OPTIONS.....	36
ADDRESS 4088.....	SENSOR WATCH DELAY.....	19
ADDRESS 4088.....	SYSTEM DELAYS & TIMEOUTS.....	19
ADDRESS 4089.....	ANSWER ON RING NUMBER.....	22
ADDRESS 4089.....	DOWNLOAD/CALLBACK OPTIONS.....	22
ADDRESS 4091.....	CLEAR DEALER PROGRAM.....	52
ADDRESS 4091.....	ERASING DEALER PROGRAM.....	52
ADDRESS 4091-4093.....	SYSTEM RESET OPTIONS.....	52
ADDRESS 4093.....	COLD START.....	52
ADDRESS 4093.....	ERASING ENTIRE PROGRAM.....	52



NOTES



NOTES



GEM-P3200 WIRING DIAGRAM

NAPCO SECURITY SYSTEMS, INC
AMITYVILLE, N.Y. 11701



GEMINI GEM-P3200 / P3200M WIRING DIAGRAM

(REFER TO OPERATION AND INSTALLATION INSTRUCTIONS W1817)

- 1.) END-OF-LINE RESISTORS, 2200 OHMS, RED, RED, 5%, 1/2W, (EOL2.2K) ALSO INSTALLED IF ZONE NOT USED IN PANEL OR EZM, (INCLUDING FIRE AND PANIC), DO NOT INSTALL EOL RESISTOR ON FIRE ZONE IF USING FT2200 EOL RELAY.
- 2.) COMBINED STANDBY CURRENT=AUX POWER + REMOTE POWER + RESET RELAY + FIRE POWER.
- 3.) BELL CURRENT MAY BE INCREASED BY SUBTRACTING AN EQUAL AMOUNT FROM THE STANDBY CURRENT.
- 4.) SYSTEM MUST BE TESTED AT LEAST ONCE A WEEK IN THE AC/BATTERY MODE AND IN THE BATTERY-ONLY MODE. CONTACT CENTRAL STATION PRIOR TO TESTING)
- 5.) CONTACTS 2A/24VDC RESISTIVE (CUT JUMPER FOR DRY CONTACT)
- 6.) FOR U.L. RESIDENTIAL FIRE; CUT 'PS' JUMPER AND INSTALL SHUNT ACROSS JP6 HEADERS.
- 7.) FOR SUPERVISION PROGRAM 'SUPERVISED BELL OUTPUT'
- 8.) UNIT INTENDED TO BE MOUNTED ON THE WALL VERTICALLY
- 9.) REFER TO W1817 FOR COMPATIBLE TWO WIRE SMOKE DETECTORS. DO NOT MIX DIFFERENT MODELS.
- 10.) RECOMMENDED BATTERIES: YUASA NP4-12 AND NP7-12. BATTERIES MUST BE REPLACED EVERY FIVE YEARS.
- 11.) THIS PANEL SHALL BE CHECKED BY A QUALIFIED TECHNICIAN AT LEAST ONCE EVERY THREE YEARS.
- 12.) AUX. POWER AND FIRE POWER VOLTAGE RATING 12.5VDC TO 11.7VDC. PANEL STOPS PROCESSING ALARMS AT 8VDC.
- 13.) THIS PANEL SUPPORTS ONLY ONE SMOKE DETECTOR IN ALARM FOR EACH ZONE.
- 14.) CUT TO DISABLE BELL SUPERVISION. DO NOT CUT IN U.L. INSTALLATIONS.
- 15.) DISABLE AUTO-RESET ON NON-FIRE ZONES FOR SIA CP-01 INSTALLATIONS.

LA1499F

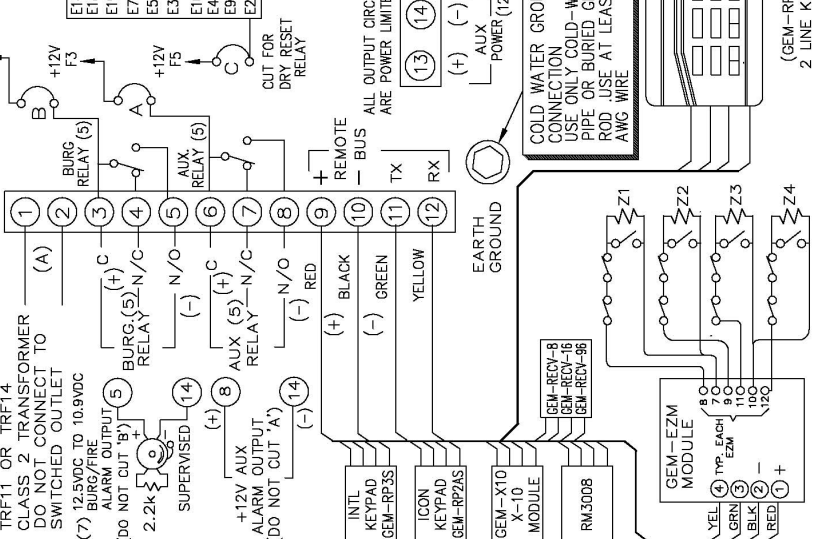
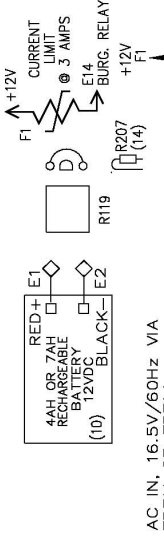
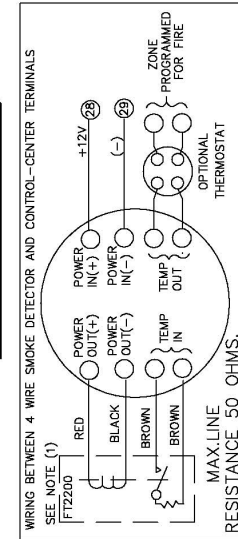

This equipment should be installed in accordance with Chapter 2 of the National Fire Alarm Code, ANSI/NFPA 72-1996 (National Fire Protection Association Batterymarch Park, Quincy, MA 02269), and local codes. Information describing proper installation, operation, testing, maintenance, evacuation planning, and repair service is to be provided with this equipment. U.L. Listed Limited Energy Cable is required.

J5
NORMAL
KEYPAD CONFIGURE

THIS UNIT INCLUDES AN ALARM VERIFICATION FEATURE THAT WILL RESULT IN DELAY OF THE SYSTEM ALARM SIGNAL FROM THE INDICATED CIRCUITS. THE SIGNAL (CONTROL UNIT PLUS SMOKE DETECTORS) SHALL NOT EXCEED 60 SECONDS. NO OTHER SMOKE DETECTORS SHALL BE CONNECTED TO THESE CIRCUITS UNLESS APPROVED BY THE LOCAL AUTHORITY HAVING JURISDICTION.

CIRCUIT CONTROL UNIT SMOKE DETECTORS ZONES DELAY-SEC

MODEL DELAY-SEC.

THE DELAY (POWER UP) (STARTUP) TIME MARKED ON THE INSTALLATION WIRING DIAGRAM OF THE SMOKE DETECTOR OR ON THE INSTALLED SMOKE DETECTOR(S) IS TO BE USED.

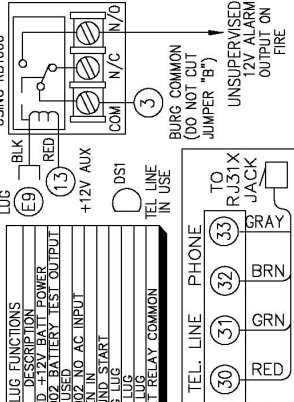

WARNING
TO PREVENT RISK OF ELECTRIC SHOCK DISCONNECT TELEPHONE LINES PRIOR TO SERVICING

BATTERY STANDBY CURRENT

RESIDENTIAL AND COMMERCIAL BURGLARY STANDBY/ALARM CURRENT CHART	
COMBINED BATTERY STANDBY CURRENT	PANEL STANDBY TIME
4 AH 850mA	2.0A 4 HOURS
7 AH 850mA	2.0A 6 HOURS
RESIDENTIAL FIRE AND COMBINATION RESIDENTIAL BURGLARY AND FIRE STANDBY/ALARM CURRENT CHART	
COMBINED BATTERY STANDBY CURRENT	PANEL STANDBY TIME
7AH 150mA (3)	6.50mA (3) 24 HOURS

BATTERY STANDBY CURRENT

RESIDENTIAL AND COMMERCIAL BURGLARY STANDBY/ALARM CURRENT CHART	
COMBINED BATTERY STANDBY CURRENT	PANEL STANDBY TIME
4 AH 850mA	2.0A 4 HOURS
7 AH 850mA	2.0A 6 HOURS
RESIDENTIAL FIRE AND COMBINATION RESIDENTIAL BURGLARY AND FIRE STANDBY/ALARM CURRENT CHART	
COMBINED BATTERY STANDBY CURRENT	PANEL STANDBY TIME
7AH 150mA (3)	6.50mA (3) 24 HOURS

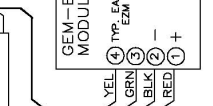
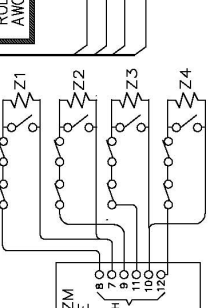
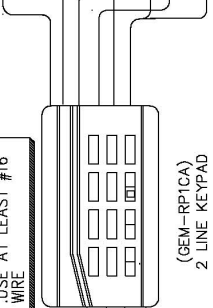
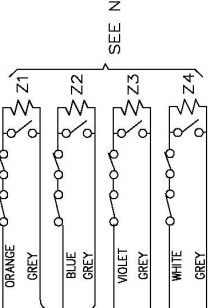

Free Manuals Download Website

<http://myh66.com>

<http://usermanuals.us>

<http://www.somanuals.com>

<http://www.4manuals.cc>

<http://www.manual-lib.com>

<http://www.404manual.com>

<http://www.luxmanual.com>

<http://aubethermostatmanual.com>

Golf course search by state

<http://golfingnear.com>

Email search by domain

<http://emailbydomain.com>

Auto manuals search

<http://auto.somanuals.com>

TV manuals search

<http://tv.somanuals.com>