

Evaluation Board Instruction Manual

ADC12040 12-Bit, 40 Msps, 5 Volt, 380 mW A/D Converter

ADC12010 12-Bit, 10 Msps, 5 Volt, 160 mW A/D Converter

ADC12020 12-Bit, 20 Msps, 5 Volt, 185 mW A/D Converter

ADC12L063 12-Bit, 62 Msps, 3.3 Volt 354 mW A/D Converter

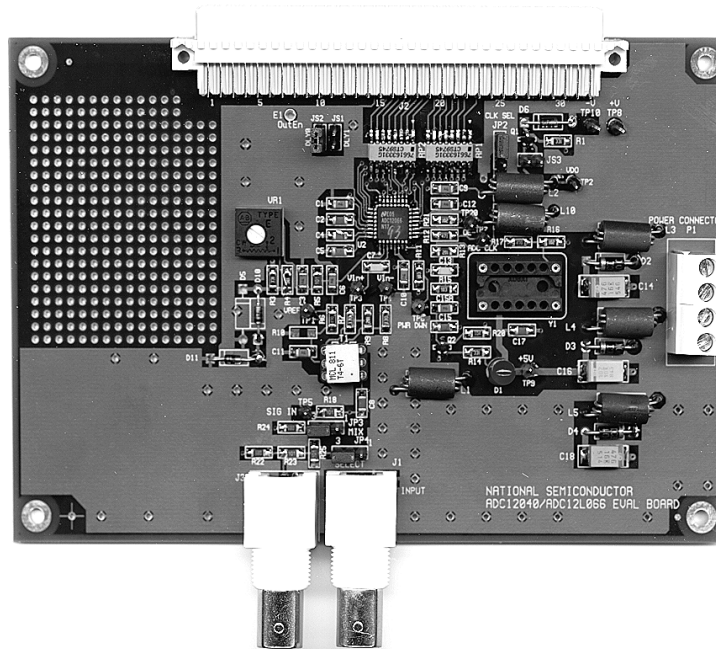

© 2001, 2002, 2003, 2004 National Semiconductor Corporation.

Table of Contents

1.0 Introduction.....	3
2.0 Board Assembly	3
3.0 Quick Start.....	4
4.0 Functional Description	4
4.1 Input (signal conditioning) circuitry	4
4.1.1 Single Input	4
4.1.2 Dual Input	5
4.2 ADC reference circuitry	5
4.3 ADC clock circuit	5
4.5 Digital Data Output	6
4.5 Power Supply Connections	6
4.6 Power Requirements.....	6
5.0 Installing the ADC12040 Evaluation Board	6
6.0 Obtaining Best Results.....	6
6.1 Clock Jitter.....	6
6.2 Coherent Sampling.....	7
7.0 Evaluation Board Specifications	8
8.0 Hardware Schematic	9
9.0 Evaluation Board Bill of Materials.....	10
A1.0 Operating in the Computer Mode.....	12
A2.0 Summary Tables of Test Points and Connectors	12

1.0 Introduction

These Design Kits (each consisting of an Evaluation Board, National's WaveVision software and this manual) is designed to ease evaluation and design-in of Nationals ADC12040, ADC12010, ADC12020, or ADC12L063 12-bit Analog-to-Digital Converter, which operate at speeds up to 40 Msp/s, 10 Msp/s, 20 Msp/s and 62 Msp/s, respectively. Further reference in this manual to the ADC12040 is meant to also include the ADC12010, ADC12020 and the ADC12L063, unless otherwise specified or implied. Note that the maximum sample rate capability of the WaveVision system in the Computer or Automatic mode is 60 Msp/s.

The WaveVision software can be operated under Microsoft Windows. The signal at the Analog Input is digitized and can be captured and displayed on a PC monitor as a dynamic waveform. The digitized output is also available at Euro connector J2.

The software can perform an FFT on the captured data upon command and, in addition to a frequency domain plot, shows dynamic performance in the form of SNR, SINAD, THD and SFDR.

A prototype area is available for building customized circuitry.

The evaluation board can be used in either of two modes. In the Manual mode suitable test equipment can be used with the board to evaluate the ADC12040 performance.

In the Computer mode evaluation is simplified by connecting the board to the WaveVision Digital Interface Board (order number WAVEVSN BRD 3.0), which is connected to a personal computer through a serial communication port and running WaveVision software, operating under Microsoft Windows. Or use WAVEVSN BRD 4.0 when available on National's web site. Use the WaveVision2 program (WAVEVSN2.EXE) or use WaveVision 4.0 when available on National's web site.

The signal at the Analog Input to the board is digitized and is available at pins B16 through B21 and C16 through C21 of J2. Pins A16 through A21 of J2 are ground pins.

Provision is made for adjustment of the Reference Voltage, V_{REF} , with VR1.

2.0 Board Assembly

The ADC12040 Evaluation Board may come pre-assembled or as a bare board that must be assembled. Refer to the Bill of Materials for a description of components, to Figure 1 for major component placement and to Figure 6 for the Evaluation Board schematic.

A breadboard area is provided for building customized circuitry. For best performance, keep circuitry neat and arrange components to provide short, direct connections.

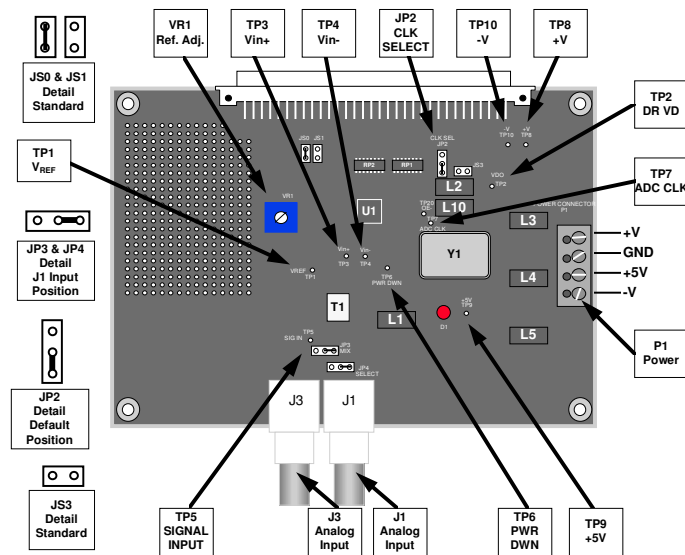

Figure 1. Component and Test Point Locations

3.0 Quick Start

Note: To develop the ADC clock, the Digital Interface Board divides its on-board clock. In doing so, jitter is introduced to the ADC clock which degrades the observed performance of the ADC12040. See [Section 6.0 Obtaining Best Results](#) for an explanation of this phenomenon and how to avoid it.

Refer to *Figure 1* for locations of test points and major components. For Stand-Alone operation:

1. Install an appropriate crystal into socket Y1. While the oscillator may be soldered to the board, using a socket will allow you to easily change clock frequencies.
2. Connect a clean power supply to Power Connector P1. Supply +5V at pin 3 of P1 to supply the Digital Interface board. Supply +3.3V to pin 1 for the ADC12L063, or +5V to pin 1 for the ADC12010, ADC12020 and the ADC12040. Pin 2 is ground.
3. Use VR1 to set the reference voltage (V_{REF}), which is 2.0V for the ADC12040, ADC12010, or ADC12020, or to 1.0V for the ADC12L063. V_{REF} can be measured at TP1.
4. To use the crystal oscillator located at Y1 to clock the ADC, connect the jumper at JP2 to pins 2 and 3. This is the default position. The ADC clock signal may be monitored at TP7. Because of clock isolation resistor R12 and the scope probe capacitance, the clock signal at TP7 will appear integrated.
5. Connect the jumper at JP3 between pins 1 and 2, and the jumper at JP4 to pins 1 and 2 to select input J1 only. This is the default position.
6. Connect a signal of 1.4 V_{p-p} amplitude for the ADC12040, ADC12010 or the ADC12020, or 0.7 V_{p-p} for the ADC12L063 from a 50-Ohm source to Analog Input BNC J1. The ADC input signal can be observed at TP5. Because of isolation resistor R18 and the scope probe capacitance, the input signal at TP5 may not have the same frequency response as the ADC input. Be sure to use a bandpass filter before the Evaluation Board.
7. Adjust the input signal amplitude as needed to ensure that the signals at TP3 and TP4 remains within the valid signal range of 0V to V_{REF} .
8. The digitized signal is available at pins B16 through B21 and C16 through C21 of J2. See board schematic of *Figure 6*.

For Computer Mode operation:

NB: Be sure to read section 6.1 before using this board in the Computer Mode.

1. Connect the evaluation board to the Digital Interface Board. See the Digital Interface Board Manual for operation of that board.

2. Perform steps 2 and 3 of stand alone quick start,, above.
3. Use of the crystal oscillator located at Y1 is recommended to clock the ADC. To do so, connect the jumper at JP2 to pins 2 and 3. This is the default position. The ADC clock signal may be monitored at TP7. Because of clock isolation resistor R12 and the scope probe capacitance, the clock signal at TP7 will appear integrated.
4. Perform steps 5 through 7 of the Stand-Alone quick start, above.
5. See the Digital Interface Board Manual for instructions for setting the ADC clock frequency and for gathering data.

4.0 Functional Description

The ADC12040 Evaluation Board schematic is shown in *Figure 6*.

4.1 Input (signal conditioning) circuitry

The input signal to be digitized should be applied to BNC connector J1. This 50 Ohm input is intended to accept a low-noise sine wave signal of 2V peak-to-peak amplitude for the ADC12040, ADC12010 and ADC12020 or 1V peak-to-peak for the ADC12L063. To accurately evaluate the dynamic performance of these converters, the input test signal will have to be passed through a high-quality bandpass filter with at least 14-bit equivalent noise and distortion characteristics.

Signal transformer T1 provides single-ended to differential conversion. The common mode voltage at the ADC input is equal to the reference voltage of the ADC.

No scope or other test equipment should be connected to TP3 or to TP4 while gathering data.

This evaluation board is capable of accommodating a single input or two different inputs. These inputs are NOT differential in nature, but are intended to mix two different signals before presenting them to the ADC.

NOTE: If input frequency components above 30 MHz are required, remove capacitor C7 at the ADC differential input pins.

4.1.1 Single Input

To evaluate the ADC12040 with a single input, connect jumpers JP3 and JP4 in their default positions, as shows in *Figure 1*. That is, short together pins 1 and 2 of JP3 and of JP4. Doing so provides a 50-Ohm input at J1. No connection should be made to J3. This configuration is appropriate for evaluation of dynamic performance parameters.

4.1.2 Dual Input

To look at intermodulation performance, moving shorting jumpers of JP3 and JP4 to pins 2 and 3 of JP3. Connect different signals to J1 and J3 from 50-Ohm sources. When looking at the ADC output with two different signals at the input, the dynamic performance parameters (SNR, SINAD, THD and SFDR) are meaningless. With two input signals we are looking for any spurs in the frequency domain plot (FFT). The simple method used here to mix two signals is not adequate to completely evaluate IMD of these converters. Consequently, the actual IMD performance of the A/D converter is better than would be indicated by using this method. Most high speed ADCs exhibit high spurious content under these conditions unless the total input swing is very low compared with full scale.

As mentioned in *Section 5.0*, it is important to use a bandpass filter at BNC J1 (and BNC J3, if this input is used) to ensure the quality of the signal presented to the ADC and to get meaningful test results.

4.2 ADC reference circuitry

An adjustable reference circuit is provided on the board. The simple circuit here is not temperature stable and is not recommended for your final design solution. When using the resistor values shown in *Figure 1*, the reference circuit will generate a nominal reference voltage in the range of 0 to 2.4 Volts for the ADC12040, ADC12010 and ADC12020 or 0 to 1.2 Volts for the ADC12L063. The ADC12040, ADC12010 and ADC12020 are specified to operate with V_{REF} in the range of 1.0 to 2.4 V, with a nominal value of 2.0V while the ADC12L063 is specified to operate with V_{REF} in the range of 0.8 to 1.2 V, with a nominal value of 1.0V. The reference voltage can be monitored at test point TP1 and is set with VR1.

4.3 ADC clock circuit

The clock signal applied to the ADC is selected with jumper JP2. A standard crystal oscillator can be installed at Y1 and selected with jumper JP2 pins 2 and 3 shorted together. To use a different clock source, connect the signal to pin B23 of J2 and select pins 1 and 2 of jumper JP2. The ADC clock frequency can be monitored at test point TP7. R13 and C13 are used for high frequency termination of the clock line. In the Computer mode of operation using the Digital Interface Board, JP2 can have pins 1 and 2 shorted together to use the clock from the Digital Interface Board, but this is not recommended, as discussed in *Section 6.1*.

Note that any external clock source must have TTL/CMOS levels. Also, if using the Digital Interface Board from National Semiconductor to capture data, the oscillator at Y1 should be removed, the external clock signal supplied at pin 3 of that socket and pins 2 and 3 of JP2 should be selected. Additionally, the clock frequency

must be the same as that provided from the Digital Interface Board.

See *Section 6.1* for information on capturing data with a clock that is not synchronized to the clock of the Digital Interface Board.

4.5 Digital Data Output

The digital output data from the ADC12040 is available at the 96-pin Euro connector J2. Series resistors RP1 and RP2 isolate the ADC from the load circuit to reduce noise coupling into the ADC.

4.5 Power Supply Connections

Power to this board is supplied through power connector P1. The only supply needed is +5V at pin 1 for the ADC12040, ADC12010 or the ADC12020, or +3.3V at pin 1 for the ADC12L063, plus ground at pin 2 for either. Any circuitry you breadboard may need a negative voltage at the -V supply pin 4.

When using the ADC12040 Evaluation Board with the Digital Interface Board, a 5V logic power supply for the interface board is needed at pin 3 of P1. This supply voltage is passed through J2 to the Digital Interface Board.

The supply voltages are protected by shunt diodes and can be measured at TP8, TP9 and TP10. If a breadboarded circuit requires voltages greater than 5V, they will have to be separately provided by the user.

4.6 Power Requirements

Voltage and current requirements for the ADC12040 Evaluation Board mode are:

For the ADC12040, ADC12010 and the ADC12020:

- +5.0V at 100 mA [+V]
- +5.0V at 30 mA (1A when connected to the Digital Interface Board) [+5V].

For the ADC12L063:

- +3.3V at 120 mA [+V]
- +5.0V at 30 mA (1A when connected to the Digital Interface Board) [+5V].

There is no need for a negative supply for either ADC, unless it may be needed for the breadboard area.

5.0 Installing the ADC12040 Evaluation Board

The evaluation board requires power supplies as described in *Section 4.6*. An appropriate signal source should be connected to the Analog Input BNC J1. When evaluating dynamic performance, an appropriate signal generator (such as the HP8644B, HP8662A or the R&S SME-03) with 50 Ohm source impedance should be connected to the Analog Input BNC J1 and/or J3 through

an appropriate bandpass filter as even the best signal generator available can not produce a signal pure enough to evaluate the dynamic performance of an ADC.

If this board is used in conjunction with the Digital Interface Board and WaveVision software, a cable with a DB-9 connector must be connected between the Digital Interface Board and the host computer when using WAVEVSN BRD 3.0 Digital Interface Board. See the Digital Interface Board manual for details.

6.0 Obtaining Best Results

Obtaining the best results with any ADC requires both good circuit techniques and a good PC board layout. The layout is taken care of with the design of this evaluation board.

6.1 Clock Jitter

When any circuitry is added after a signal source, some jitter is almost always added to that signal. Jitter in a clock signal, depending upon how bad it is, can degrade dynamic performance. We can see the effects of jitter in the frequency domain (FFT) as "leakage" or "spreading" around the input frequency, as seen in *Figure 2a*. Compare this with the more desirable plot of *Figure 2b*. Note that all dynamic performance parameters (shown to the right of the FFT) are improved by eliminating clock jitter.

To develop the ADC clock, WAVEVISON BRD 3.0 Digital Interface Board divides its on-board clock to provide the ADC clock. In doing so, jitter is introduced to the ADC clock, degrading the observed performance of the ADC. The amount of jitter produced by this evaluation system is acceptable for relatively low input frequencies (below about 5 MHz). But at higher frequencies and resolutions this jitter can make it appear as though the ADC does not perform well.

For many applications the results seen will be completely acceptable. However, if it is desired to observe the best results possible from the ADC, you should not use the Digital Interface Board to capture data OR you should do the following when using the Digital Interface Board:

1. Use an 80 MHz oscillator on the Digital Interface Board (120 MHz for the ADC12L063) with the DIP switches on that board set to divide the oscillator frequency by the appropriate amount. See the Digital Interface Board manual for details on setting the divide ratio. The goal here is to have the divided clock from the Digital Interface Board be the same frequency as the oscillator on the ADC12040 Evaluation Board.
2. Use a 40 MHz oscillator on the ADC12040 evaluation board, a 10 MHz oscillator for the

ADC12010 evaluation board, a 20 MHz oscillator for the ADC12020 evaluation board, or a 60 MHz on the ADC12L063 evaluation board).

3. Connect the jumper at JP2 to pins 2 and 3 (default position). This selects the crystal oscillator located at Y1 on the evaluation board (rather than the divided oscillator signal on the Digital Interface Board) to clock the ADC.

Because the divided signal from the Digital Interface Board and the oscillator at Y1 are not synchronized, bad data will sometimes be taken because we are latching data when the outputs are in transition. This data might be as you see in *Figure 3* or *Figure 4*.

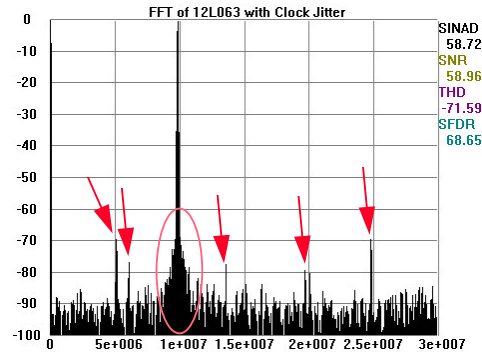

Figure 2a. Jitter causes a spreading around the input signal, as well as undesirable signal spurs.

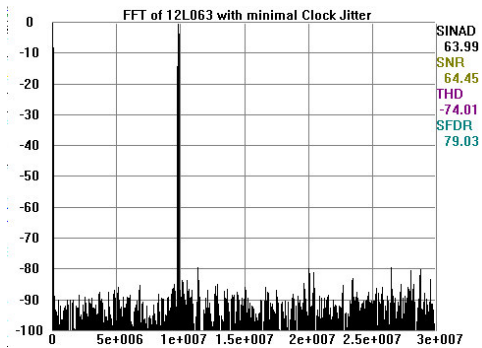

Figure 2b. Eliminating or minimizing clock jitter results in a more desirable FFT that is more representative of how the ADC actually performs.

The problem of *Figure 3* is obvious, but it is not as easy to see the problem in *Figure 4*, where the only thing we see is small excursions beyond the normal envelope. Compare *Figure 3* and *Figure 4* with *Figure 5*.

If your data capture results in something similar to what is shown here in *Figure 3* or in *Figure 4*, take another sample. It may take a few trials to get good data.

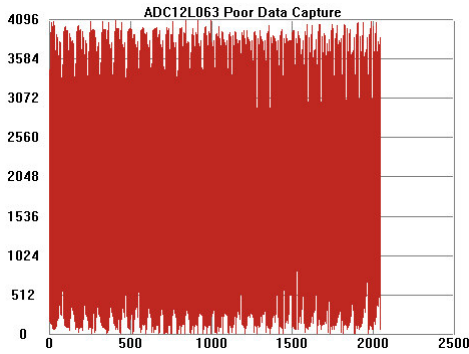

Figure 3. Poor data capture resulting from trying to capture data while the ADC outputs are in transition

6.2 Coherent Sampling

Artifacts can result when we perform an FFT on a digitized waveform, producing inconsistent results when testing repeatedly. The presence of these artifacts means that the ADC under test may perform better than the measurements would indicate.

We can eliminate the need for windowing and get more consistent results if we observe the proper ratios between the input and sampling frequencies. We call this *coherent sampling*. Coherent sampling greatly increases the spectral resolution of the FFT, allowing us to more accurately evaluate the spectral response of the A/D converter. When we do this, however, we must be sure that the input signal has high spectral purity and stability and that the sampling clock signal is extremely stable with minimal jitter.

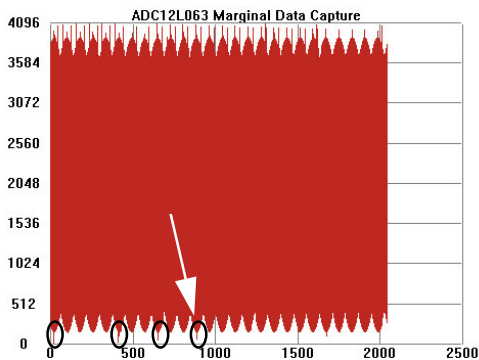

Figure 4 Marginal data capture that results from trying to capture data that is near but not right at the point where the ADC outputs are in transition.

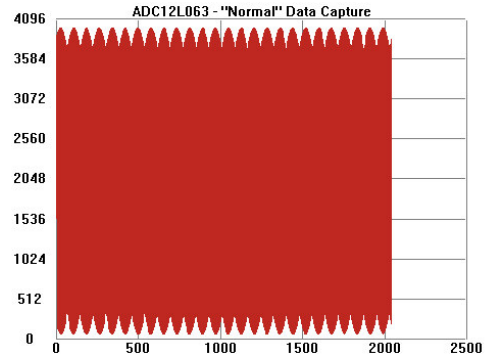

Figure 5. Normal data capture.

Coherent sampling of a periodic waveform occurs when a prime integer number of cycles exists in the sample window. The relationship between the number of cycles sampled (CY), the number of samples taken (SS), the signal input frequency (f_{in}) and the sample rate (f_s), for coherent sampling, is

$$\frac{CY}{SS} = \frac{f_{in}}{f_s}$$

CY, the number of cycles in the data record, must be a prime integer number and SS, the number of samples in the data record, must be a factor of 2 integer.

Further, f_{in} (signal input frequency) and f_s (sampling rate) should be locked to each other so that the relationship between the two frequencies is exact. Locking the two signal sources to each other also causes whatever sample-to-sample clock edge timing variation (jitter) that is present in the two signals to cancel each other.

Windowing (an FFT Option under WaveVision) should be turned off for coherent sampling.

7.0 Evaluation Board Specifications

Board Size:	6.5" x 3.5" (16.5 cm x 8.9 cm)
Power Requirements:	+5.0V, 100 mA (ADC12040 / ADC12010 / ADC12020) or +3.3V, 120 mA (ADC12L063)
	+5V @ 30 mA / 1A (see Sect 4.6)
Clock Frequency Range:	1.0 MHz to 40 MHz or 60 MHz
Analog Input	
Nominal Voltage:	1.4V _{P-P}
Impedance:	50 Ohms

8.0 Hardware Schematic

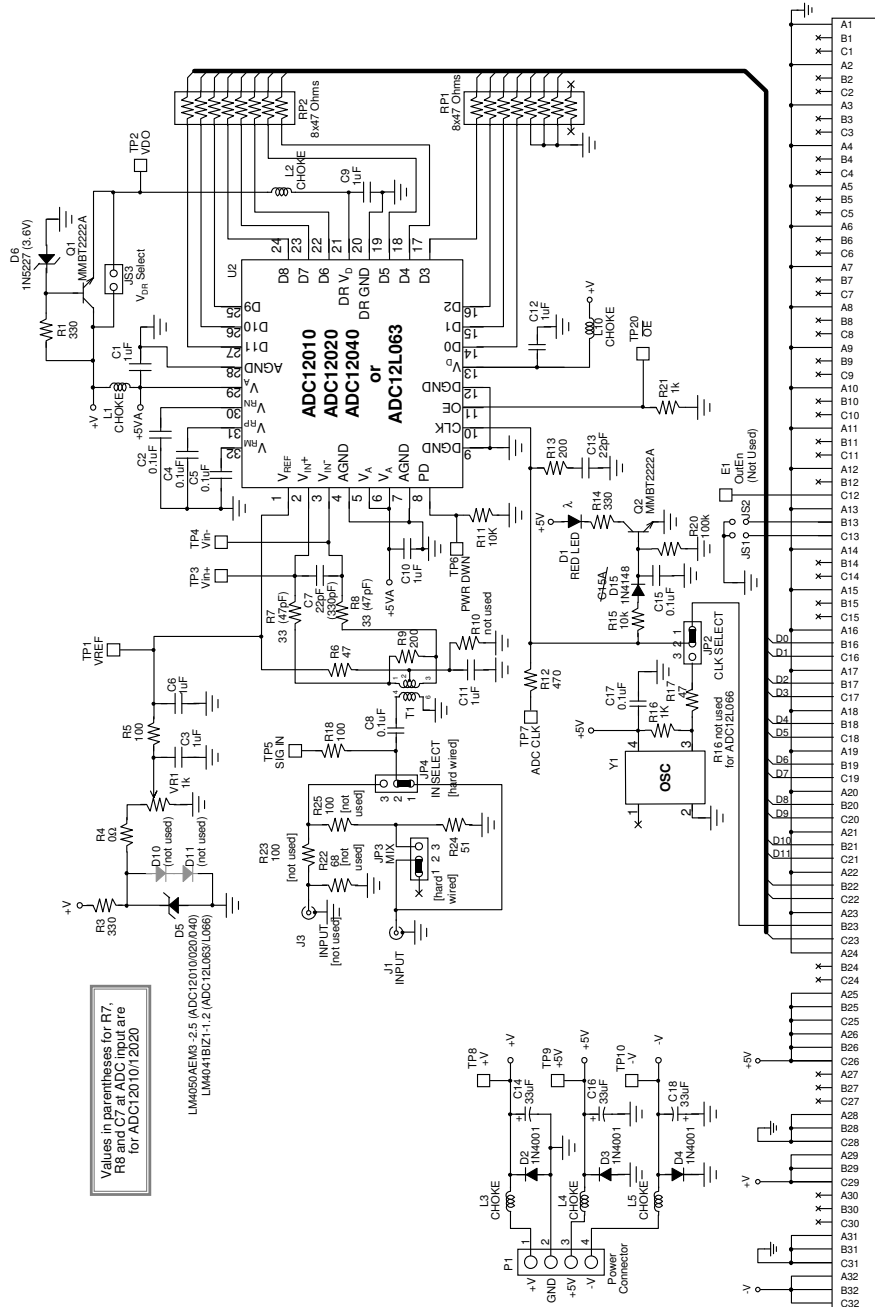

Figure 6. ADC 12040 Evaluation Board Schematic

9.0 Evaluation Board Bill of Materials

Item	Qty	Reference	Part	Source
1	7	C1, C3, C6, C9, C10, C11, C12	1 uF	Type 1206
2	6	C2, C4, C5, C8, C15, C17	0.1 uF	Type 1206
3	1	C7	22 pF (330 pF for ADC12010 / 12020)	Type 1206
4	1	C13	22 pF	Type 1206
5	2	C14, C16	33 uF, 6.3V	Type 7343 (D Size)
6	-	C18	not populated	n/a
7	-	C15A	is diode D15	see D15
8	1	D1	RED LED	DigiKey # 160-1124-ND
9	2	D2, D3	1N4001	Various
10	1	D5	LM4041BIZ-2.5	National Semiconductor
11	1	D6	1N5227 (Not used for the ADC12L063)	Various
12	1	D15	1N4148	Various
13	-	D4, D10, D11	not populated	n/a
14	1	JP2	3-Pin Post Header	DigiKey # A19351-ND
15	-	JP3, JP4	not populated	n/a
16	3	JS1, JS2, JS3	2-Pin Post Header	DigiKey # A19350-ND
17	1	J1	BNC Connector	DigiKey # ARF1177-ND
18	1	J2	96-Pin Female	DigiKey # H7096-ND
19	-	J3	not populated	n/a
20	5	L1, L2, L3, L4, L10	Choke	DigiKey # M2304-ND
21	-	L5	not populated	n/a
22	2	P1	Terminal Block	DigiKey # ED1609-ND
23	2	Q1, Q2	MMBT2222A (Q1 not used for ADC12L063)	Various
24	3	R1, R3, R14	330, 5% (R1 not used for ADC12L063)	Type 1206
25	-	R2, R10, R19 (R2 & R19 no exist)	not used	n/a
26	1	R4	0 (shorting strap)	n/a
27	2	R5, R18	100, 5%	Type 1206
28	2	R6, R17	47, 5%	Type 1206
29	2	R7, R8	33, 5% (47Ω for ADC12010 / 12020)	Type 1206
30	2	R9, R13	200, 5%	Type 1206
31	2	R11, R15	10k, 5%	Type 1206
32	1	R12	470, 5%	Type 1206
33	1	R16 (not used on ADC12L063)	1K, 5%	Type 1206
34	1	R20	100k, 5%	Type 1206
35	1	R21	1K, 5%	Type 1206
36	-	R22, R23, R24, R25	not populated	n/a
37	2	RP1, RP2	Resistor Pack - 8 x 47 Ohms	DigiKey # 767-163-R47-ND
38	1	VR1	1K	DigiKey # 3386P-102-ND
39	1	TP1, TP2, TP3, TP4, TP5, TP6, TP7, TP8, TP9, TP20	Breakable Header	DigiKey # S1012-36-ND
40	-	TP10	not populated	n/a
41	1	T1	Signal Transformer	MiniCircuits type T4-6T
42	1	U1	ADC12010CIVY, ADC12020CIVY, ADC12040CIVY or ADC12L063CIVY	National Semiconductor
43	1	Y1	10 MHz Oscillator for ADC12010 20 MHz Oscillator for ADC12020 40 MHz Oscillator for ADC12040 60 MHz Oscillator for ADC12L063	Pletronics #P1145-3SD-10.0M Pletronics #P1145-3SD-20.0M Pletronics #P1145-3SD-40.00M Pletronics #P1145-3SD-60.0M or
44	1	--	6-pin Socket for Transformer	DigiKey # AE8906-ND
45	1	--	4-Pin full-size oscillator socket	DigiKey # A462-ND
46	2	--	Jumpers for JP2 & JS3	DigiKey # S9001-ND

APPENDIX

A1.0 Operating in the Computer Mode

The ADC12040 Evaluation Board is compatible with the WaveVision Digital Interface Board and WaveVision software. When connected to the Digital Interface Board, data capture is easily controlled from a personal computer operating in the Windows environment. The data samples that are captured can be observed on the PC video monitor in the time and frequency domains. The FFT analysis of the captured data yields insight into system noise and distortion sources and estimates of ADC dynamic performance such as SINAD, SNR and THD.

See the Digital Interface Board manual for more information.

A2.0 Summary Tables of Test Points and Connectors

Test Points on the ADC12040 Evaluation Board

TP 1	ADC Reference Voltage
TP 2	ADC output driver supply voltage
TP 3	Positive input signal to the ADC (Vin+)
TP 4	Negative input signal to the ADC (Vin-)
TP 5	Signal Input test point
TP 6	Power Down (active high) input
TP 7	ADC clock frequency monitor
TP 8	+5V power supply for ADC12040 / 12010 / 12020 or +3.3V for ADC12L063
TP 9	+5V power supply for the Digital Interface Board, if used
TP 10	Optional negative power supply for breadboard area
TP 20	Output Enable input. Pull high to disable the outputs

P1 Connector - Power Supply Connections

J1-1	+V	Positive Power Supply (+5V for ADC12040/12010/12020 or +3.3V for ADC12L063)
J1-2	GND	Power Supply Ground
J1-3	+5V	+5.0V Logic Power Supply for Digital Interface Board
J1-4	-V	Optional Negative Power Supply for Breadboard Area

JP2 Jumper - ADC Clock selection jumper settings

Connect 1-2	Use Clock signal from J2 pin B23
Connect 2-3	Use crystal oscillator Y1

JP3 Jumper - ADC Input Select

Connect 1-2	Use single J1 Input
Connect 2-3	Mix J1 & J3 Inputs (must also have JP4 pins 1 & 2 shorted)

JP4 Jumper - ADC Input Select

Connect 1-2	Select input J1 only
Connect 2-3	Select mixed J1 & J3 Inputs (must also have JP3 pins 2 & 3 shorted)

J2 Connector - ADC Data Outputs - Connection to WaveVision Digital Interface Board

Signal	J2 pin number
ADC output D0	B16
ADC output D1	C16
ADC output D2	B17
ADC output D3	C17
ADC output D4	B18
ADC output D5	C18
ADC output D6	B19
ADC output D7	C19
ADC output D8	B20
ADC output D9	C20
ADC output D10	B21
ADC output D11	C21
GND	A1 thru A24, A28, B28, C28, A31, B31, C31
ADC Output Enable	C12 (not used)
External clock input	B23
Reserved, signal	B22, C22, C23
Reserved, power	A25, A26, B25, B26, C25, C26 (+5V Logic Power Supply to Digital Interface Board)
Reserved, power	A29, B29, C29
Reserved, power	A32, B32, C32

BY USING THIS PRODUCT, YOU ARE AGREEING TO BE BOUND BY THE TERMS AND CONDITIONS OF NATIONAL SEMICONDUCTOR'S END USER LICENSE AGREEMENT. DO NOT USE THIS PRODUCT UNTIL YOU HAVE READ AND AGREED TO THE TERMS AND CONDITIONS OF THAT AGREEMENT. IF YOU DO NOT AGREE WITH THEM, CONTACT THE VENDOR WITHIN TEN (10) DAYS OF RECEIPT FOR INSTRUCTIONS ON RETURN OF THE UNUSED PRODUCT FOR A REFUND OF THE PURCHASE PRICE PAID, IF ANY.

The ADC12040/ADC12010/ADC12020/ADC12L063 Evaluation Boards are intended for product evaluation purposes only and are not intended for resale to end consumers, is not authorized for such use and is not designed for compliance with European EMC Directive 89/336/EEC, or for compliance with any other electromagnetic compatibility requirements.

National Semiconductor Corporation does not assume any responsibility for use of any circuitry or software supplied or described. No circuit patent licenses are implied.

LIFE SUPPORT POLICY

NATIONAL'S PRODUCTS ARE NOT AUTHORIZED FOR USE AS CRITICAL COMPONENTS IN LIFE SUPPORT DEVICES OR SYSTEMS WITHOUT THE EXPRESS WRITTEN APPROVAL OF THE PRESIDENT OF NATIONAL SEMICONDUCTOR CORPORATION. As used herein:

1. Life support devices or systems are devices or systems which, (a) are intended for surgical implant into the body, or (b) support or sustain life, and whose failure to perform, when properly used in accordance with instructions for use provided in the labeling, can be reasonably expected to result in a significant injury to the user.
2. A critical component is any component in a life support device or system whose failure to perform can be reasonably expected to cause the failure of the life support device or system, or to affect its safety or effectiveness.

National Semiconductor Corporation Americas Tel: 1-800-272-9959 Fax: 1-800-737-7018 Email: support@nsc.com	National Semiconductor Europe Fax: +49 (0) 1 80-530 85 86 Email: europe.support@nsc.com Deutsch Tel: +49 (0) 699508 6208 English Tel: +49 (0) 870 24 0 2171 Français Tel: +49 (0) 141 91 8790	National Semiconductor Asia Pacific Customer Response Group Tel: 65-2544466 Fax: 65-2504466 Email: sea.support@nsc.com	National Semiconductor Japan Ltd. Tel: 81-3-5639-7560 Fax: 81-3-5639-7507
--	---	--	--

www.national.com

National does not assume any responsibility for any circuitry described, no circuit patent licenses are implied and National reserves the right at any time without notice to change said circuitry and specifications.

Free Manuals Download Website

<http://myh66.com>

<http://usermanuals.us>

<http://www.somanuals.com>

<http://www.4manuals.cc>

<http://www.manual-lib.com>

<http://www.404manual.com>

<http://www.luxmanual.com>

<http://aubethermostatmanual.com>

Golf course search by state

<http://golfingnear.com>

Email search by domain

<http://emailbydomain.com>

Auto manuals search

<http://auto.somanuals.com>

TV manuals search

<http://tv.somanuals.com>