

PXI

NI CardBus-8310-to-PXI Expansion User Manual

August 2005
371665A-01



Worldwide Technical Support and Product Information

ni.com

National Instruments Corporate Headquarters

11500 North Mopac Expressway Austin, Texas 78759-3504 USA Tel: 512 683 0100

Worldwide Offices

Australia 1800 300 800, Austria 43 0 662 45 79 90 0, Belgium 32 0 2 757 00 20, Brazil 55 11 3262 3599, Canada 800 433 3488, China 86 21 6555 7838, Czech Republic 420 224 235 774, Denmark 45 45 76 26 00, Finland 385 0 9 725 725 11, France 33 0 1 48 14 24 24, Germany 49 0 89 741 31 30, India 91 80 51190000, Israel 972 0 3 6393737, Italy 39 02 413091, Japan 81 3 5472 2970, Korea 82 02 3451 3400, Lebanon 961 0 1 33 28 28, Malaysia 1800 887710, Mexico 01 800 010 0793, Netherlands 31 0 348 433 466, New Zealand 0800 553 322, Norway 47 0 66 90 76 60, Poland 48 22 3390150, Portugal 351 210 311 210, Russia 7 095 783 68 51, Singapore 1800 226 5886, Slovenia 386 3 425 4200, South Africa 27 0 11 805 8197, Spain 34 91 640 0085, Sweden 46 0 8 587 895 00, Switzerland 41 56 200 51 51, Taiwan 886 02 2377 2222, Thailand 662 278 6777, United Kingdom 44 0 1635 523545

For further support information, refer to the *Technical Support and Professional Services* appendix. To comment on National Instruments documentation, refer to the National Instruments Web site at ni.com/info and enter the info code `feedback`.

© 2005 National Instruments Corporation. All rights reserved.

Important Information

Warranty

The NI CardBus-8310-to-PXI Expansion hardware is warranted against defects in materials and workmanship for a period of one year from the date of shipment, as evidenced by receipts or other documentation. National Instruments will, at its option, repair or replace equipment that proves to be defective during the warranty period. This warranty includes parts and labor.

The media on which you receive National Instruments software are warranted not to fail to execute programming instructions, due to defects in materials and workmanship, for a period of 90 days from date of shipment, as evidenced by receipts or other documentation. National Instruments will, at its option, repair or replace software media that do not execute programming instructions if National Instruments receives notice of such defects during the warranty period. National Instruments does not warrant that the operation of the software shall be uninterrupted or error free.

A Return Material Authorization (RMA) number must be obtained from the factory and clearly marked on the outside of the package before any equipment will be accepted for warranty work. National Instruments will pay the shipping costs of returning to the owner parts which are covered by warranty.

National Instruments believes that the information in this document is accurate. The document has been carefully reviewed for technical accuracy. In the event that technical or typographical errors exist, National Instruments reserves the right to make changes to subsequent editions of this document without prior notice to holders of this edition. The reader should consult National Instruments if errors are suspected. In no event shall National Instruments be liable for any damages arising out of or related to this document or the information contained in it.

EXCEPT AS SPECIFIED HEREIN, NATIONAL INSTRUMENTS MAKES NO WARRANTIES, EXPRESS OR IMPLIED, AND SPECIFICALLY DISCLAIMS ANY WARRANTY OF MERCHANTABILITY OR FITNESS FOR A PARTICULAR PURPOSE. CUSTOMER'S RIGHT TO RECOVER DAMAGES CAUSED BY FAULT OR NEGLIGENCE ON THE PART OF NATIONAL INSTRUMENTS SHALL BE LIMITED TO THE AMOUNT THEREFORE PAID BY THE CUSTOMER. NATIONAL INSTRUMENTS WILL NOT BE LIABLE FOR DAMAGES RESULTING FROM LOSS OF DATA, PROFITS, USE OF PRODUCTS, OR INCIDENTAL OR CONSEQUENTIAL DAMAGES, EVEN IF ADVISED OF THE POSSIBILITY THEREOF. This limitation of the liability of National Instruments will apply regardless of the form of action, whether in contract or tort, including negligence. Any action against National Instruments must be brought within one year after the cause of action accrues. National Instruments shall not be liable for any delay in performance due to causes beyond its reasonable control. The warranty provided herein does not cover damages, defects, malfunctions, or service failures caused by owner's failure to follow the National Instruments installation, operation, or maintenance instructions; owner's modification of the product; owner's abuse, misuse, or negligent acts; and power failure or surges, fire, flood, accident, actions of third parties, or other events outside reasonable control.

Copyright

Under the copyright laws, this publication may not be reproduced or transmitted in any form, electronic or mechanical, including photocopying, recording, storing in an information retrieval system, or translating, in whole or in part, without the prior written consent of National Instruments Corporation.

Trademarks

National Instruments, NI, ni.com, and LabVIEW are trademarks of National Instruments Corporation. Refer to the *Terms of Use* section on ni.com/legal for more information about National Instruments trademarks.

Other product and company names mentioned herein are trademarks or trade names of their respective companies.

Members of the National Instruments Alliance Partner Program are business entities independent from National Instruments and have no agency, partnership, or joint-venture relationship with National Instruments.

Patents

For patents covering National Instruments products, refer to the appropriate location: **Help»Patents** in your software, the `patents.txt` file on your CD, or ni.com/patents.

WARNING REGARDING USE OF NATIONAL INSTRUMENTS PRODUCTS

(1) NATIONAL INSTRUMENTS PRODUCTS ARE NOT DESIGNED WITH COMPONENTS AND TESTING FOR A LEVEL OF RELIABILITY SUITABLE FOR USE IN OR IN CONNECTION WITH SURGICAL IMPLANTS OR AS CRITICAL COMPONENTS IN ANY LIFE SUPPORT SYSTEMS WHOSE FAILURE TO PERFORM CAN REASONABLY BE EXPECTED TO CAUSE SIGNIFICANT INJURY TO A HUMAN.

(2) IN ANY APPLICATION, INCLUDING THE ABOVE, RELIABILITY OF OPERATION OF THE SOFTWARE PRODUCTS CAN BE IMPAIRED BY ADVERSE FACTORS, INCLUDING BUT NOT LIMITED TO FLUCTUATIONS IN ELECTRICAL POWER SUPPLY, COMPUTER HARDWARE MALFUNCTIONS, COMPUTER OPERATING SYSTEM SOFTWARE FITNESS, FITNESS OF COMPILERS AND DEVELOPMENT SOFTWARE USED TO DEVELOP AN APPLICATION, INSTALLATION ERRORS, SOFTWARE AND HARDWARE COMPATIBILITY PROBLEMS, MALFUNCTIONS OR FAILURES OF ELECTRONIC MONITORING OR CONTROL DEVICES, TRANSIENT FAILURES OF ELECTRONIC SYSTEMS (HARDWARE AND/OR SOFTWARE), UNANTICIPATED USES OR MISUSES, OR ERRORS ON THE PART OF THE USER OR APPLICATIONS DESIGNER (ADVERSE FACTORS SUCH AS THESE ARE HEREAFTER COLLECTIVELY TERMED "SYSTEM FAILURES"). ANY APPLICATION WHERE A SYSTEM FAILURE WOULD CREATE A RISK OF HARM TO PROPERTY OR PERSONS (INCLUDING THE RISK OF BODILY INJURY AND DEATH) SHOULD NOT BE RELIANT SOLELY UPON ONE FORM OF ELECTRONIC SYSTEM DUE TO THE RISK OF SYSTEM FAILURE. TO AVOID DAMAGE, INJURY, OR DEATH, THE USER OR APPLICATION DESIGNER MUST TAKE REASONABLY PRUDENT STEPS TO PROTECT AGAINST SYSTEM FAILURES, INCLUDING BUT NOT LIMITED TO BACK-UP OR SHUT DOWN MECHANISMS. BECAUSE EACH END-USER SYSTEM IS CUSTOMIZED AND DIFFERS FROM NATIONAL INSTRUMENTS' TESTING PLATFORMS AND BECAUSE A USER OR APPLICATION DESIGNER MAY USE NATIONAL INSTRUMENTS PRODUCTS IN COMBINATION WITH OTHER PRODUCTS IN A MANNER NOT EVALUATED OR CONTEMPLATED BY NATIONAL INSTRUMENTS, THE USER OR APPLICATION DESIGNER IS ULTIMATELY RESPONSIBLE FOR VERIFYING AND VALIDATING THE SUITABILITY OF NATIONAL INSTRUMENTS PRODUCTS WHENEVER NATIONAL INSTRUMENTS PRODUCTS ARE INCORPORATED IN A SYSTEM OR APPLICATION, INCLUDING, WITHOUT LIMITATION, THE APPROPRIATE DESIGN, PROCESS AND SAFETY LEVEL OF SUCH SYSTEM OR APPLICATION.

Compliance

Compliance with FCC/Canada Radio Frequency Interference Regulations

Determining FCC Class

The Federal Communications Commission (FCC) has rules to protect wireless communications from interference. The FCC places digital electronics into two classes. These classes are known as Class A (for use in industrial-commercial locations only) or Class B (for use in residential or commercial locations). All National Instruments (NI) products are FCC Class A products.

Depending on where it is operated, this Class A product could be subject to restrictions in the FCC rules. (In Canada, the Department of Communications (DOC), of Industry Canada, regulates wireless interference in much the same way.) Digital electronics emit weak signals during normal operation that can affect radio, television, or other wireless products.

All Class A products display a simple warning statement of one paragraph in length regarding interference and undesired operation. The FCC rules have restrictions regarding the locations where FCC Class A products can be operated.

Consult the FCC Web site at www.fcc.gov for more information.

FCC/DOC Warnings

This equipment generates and uses radio frequency energy and, if not installed and used in strict accordance with the instructions in this manual and the CE marking Declaration of Conformity*, may cause interference to radio and television reception. Classification requirements are the same for the Federal Communications Commission (FCC) and the Canadian Department of Communications (DOC).

Changes or modifications not expressly approved by NI could void the user's authority to operate the equipment under the FCC Rules.

Class A

Federal Communications Commission

This equipment has been tested and found to comply with the limits for a Class A digital device, pursuant to part 15 of the FCC Rules. These limits are designed to provide reasonable protection against harmful interference when the equipment is operated in a commercial environment. This equipment generates, uses, and can radiate radio frequency energy and, if not installed and used in accordance with the instruction manual, may cause harmful interference to radio communications. Operation of this equipment in a residential area is likely to cause harmful interference in which case the user is required to correct the interference at their own expense.

Canadian Department of Communications

This Class A digital apparatus meets all requirements of the Canadian Interference-Causing Equipment Regulations.

Cet appareil numérique de la classe A respecte toutes les exigences du Règlement sur le matériel brouilleur du Canada.

Compliance with EU Directives

Users in the European Union (EU) should refer to the Declaration of Conformity (DoC) for information* pertaining to the CE marking. Refer to the Declaration of Conformity (DoC) for this product for any additional regulatory compliance information. To obtain the DoC for this product, visit ni.com/certification, search by model number or product line, and click the appropriate link in the Certification column.

* The CE marking Declaration of Conformity contains important supplementary information and instructions for the user or installer.

Conventions

This manual provides information on the installation and use of an NI CardBus-8310-to-PXI Expansion system. The following conventions are used in this manual:

» The » symbol leads you through nested menu items and dialog box options to a final action. The sequence **File»Page Setup»Options** directs you to pull down the **File** menu, select the **Page Setup** item, and select **Options** from the last dialog box.



This icon denotes a note, which alerts you to important information.



This icon denotes a caution, which advises you of precautions to take to avoid injury, data loss, or a system crash. When this symbol is marked on a product, refer to Chapter 1, *Introduction*, for information about precautions to take.

bold Bold text denotes items that you must select or click in the software, such as menu items and dialog box options. Bold text also denotes parameter names.

italic Italic text denotes variables, emphasis, a cross reference, or an introduction to a key concept. Italic text also denotes text that is a placeholder for a word or value that you must supply.

`monospace` Text in this font denotes text or characters that you should enter from the keyboard, sections of code, programming examples, and syntax examples. This font is also used for the proper names of disk drives, paths, directories, programs, subprograms, subroutines, device names, functions, operations, variables, filenames, and extensions.

Contents

Chapter 1

Introduction

Functional Overview.....	1-1
Functional Unit Descriptions.....	1-2
CardBus Connector.....	1-2
StarFabric Bridge.....	1-2
RJ-45 Connector.....	1-3
NI CardBus-8310-to-PXI Cable Options.....	1-3
Before Installation.....	1-3
Parts List.....	1-4
Protecting Against Electrostatic Discharge.....	1-4
NI PXI-8310 Overview.....	1-5

Chapter 2

Hardware and Software Installation

Installation Instructions.....	2-1
Install the Software Driver.....	2-1
Windows 2000/XP (Without XP Service Pack 2).....	2-2
Windows XP (With Service Pack 2).....	2-2
Install the PXI Cards.....	2-4
Attach the PXI Expansion Cables.....	2-4
Install the NI CardBus-8310.....	2-5
Powering Up.....	2-5
Verifying the Installation.....	2-8
Powering Down.....	2-9
Running the System.....	2-10
Uninstalling the NI CardBus-8310 Driver.....	2-10
Additional Notes.....	2-10
System Hierarchy.....	2-10
System Boot.....	2-11
NI Measurement & Automation Explorer (MAX).....	2-11

Appendix A

PCIScope

Overview.....	A-1
---------------	-----

Appendix B Specifications

Power Requirements.....	B-1
Physical.....	B-1
Dimensions.....	B-2
Operating Environment.....	B-2
Storage Environment.....	B-2

Appendix C Troubleshooting NI PXI-CardBus-8310 Cards

Contacting Technical Support.....	C-1
Troubleshooting.....	C-2
Error Code (Yellow Exclamation Mark) in Device Manager.....	C-8

Appendix D Technical Support and Professional Services

Index

Introduction

This chapter presents an overview of the hardware functionality of NI CardBus-8310-to-PXI cards, and explains the operation of each functional unit. It also contains recommended steps to be taken while preparing to install the NI CardBus-8310 and NI PXI-8310 modules.

Functional Overview

The National Instruments CardBus-8310-to-PXI interface kit provides laptop computers direct control of PXI systems. The CardBus-to-PXI link is transparent to software applications and drivers, thereby providing you the ability to use high-performance laptop computers to control PXI systems. The NI CardBus-8310-to-PXI interface kit is ideal for use with portable systems, and you can pair it with DC-powered chassis to provide mobile solutions for applications such as in-vehicle testing.

The CardBus-to-PXI link consists of an NI CardBus-8310 card in the laptop computer connected via cabling to an NI PXI-8310 module in slot 1 of a PXI chassis. For convenience, you can purchase either a complete NI CardBus-8310-to-PXI interface kit with all necessary components or purchase the NI CardBus-8310 card, NI PXI-8310 module, and cabling separately.

The CardBus-8310-to-PXI interface kit, which uses a StarFabric serial interface to implement a CardBus-to-PCI bridge, provides a transparent link where all PXI modules appear as if they were PCI boards within the laptop computer itself. However, you benefit from the increased number of slots, power and cooling per slot, module selection, and synchronization features provided by PXI.

The NI CardBus-8310-to-PXI product is based on Stargen's StarFabric technology. StarFabric is a 2.5 Gb/s serial technology that can extend the capabilities of PCI based systems. It supports PCI-to-PCI bridging to extend the PCI bus to multiple chassis.

Figure 1-1 shows the basic architecture of an NI CardBus-8310-to-PXI system. The NI CardBus-8310 consists of a CardBus connector, a CardBus-to-PXI bridge, a StarFabric bridge and two RJ-45 connectors. The NI PXI-8310 consists of two RJ-45 connectors, a StarFabric bridge, and a PXI connector.

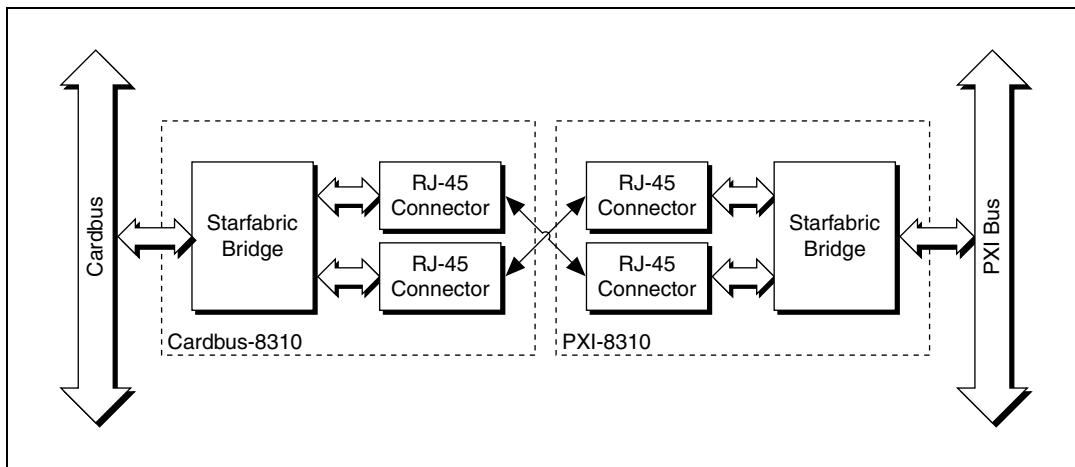

Figure 1-1. NI CardBus-8310-to-PXI Block Diagram

Functional Unit Descriptions

This section describes the individual units that comprise an NI CardBus-8310-to-PXI system.

CardBus Connector

The CardBus connector allows the NI CardBus-8310 to be used in a laptop CardBus expansion slot. This connector is defined by the PCMCIA Specification.

StarFabric Bridge

A PCI-to-StarFabric bridge provides an interface between PCI and StarFabric by translating PCI traffic into serial frame format for transmission across StarFabric. The PCI bus is a 32-bit parallel bus that transfers data between a master and a slave at 33 MHz, while the StarFabric link can simultaneously transmit and receive at 2.5 Gbps. A standard link is made up of four aggregated 622 Mbps LVDS differential pairs in each direction.

RJ-45 Connector

This connector is a standard connector commonly used for Ethernet. The StarFabric bridges use the RJ-45 connector with CAT5 cables for a board-to-board interconnect.

NI CardBus-8310-to-PXI Cable Options

A pair of CAT5-e cables are required to make a complete link: One cable to transmit data and one cable to receive data. You must install these cables in a pair. In addition, to meet the specified electromagnetic emissions standards, you must install the supplied ferrites on both ends of each cable, one ferrite per cable end.

The NI CardBus-8310-to-PXI is available with cables of various lengths. Table 1-1 shows the cables that are available from National Instruments.

Table 1-1. National Instruments CardBus-8310-to-PXI Cables

Cable Length (meters)	Description
3 m	3 m StarFabric Cable Set 763640-03, 779544-03, CBL3S-NI
10 m	10 m StarFabric Cable Set 763640-10, 779544-10, CBL10S-NI
14 m	14 m StarFabric Cable Set 763640-14, 779544-14, CBL14S-NI

Before Installation

Before installing the NI CardBus-8310-to-PXI expansion system you should perform the following steps.

- Inventory the shipping carton contents for all of the required parts.
- Gather all of the necessary tools required for installation.
- Read the rest of this manual. The installation instructions must be followed closely.

Follow these suggested guidelines and cautions while installing.

- Use only the cables provided by National Instruments.
- Use keyed connectors (to prevent connecting a cable backwards).
- Be careful when routing signal cables to your devices.

- Avoid sharp bends or folds in the cables.
- Provide enough slack to allow easy device placement.
- Avoid things that might cause scuffing and abrasion damage to the cables.
- Secure the devices in their shelves using the appropriate hardware.
- Use the screws or brackets supplied with the device. Suitable mounting brackets, adapters, and hardware are available from your local computer dealer or retailer.

Parts List

Table 1-2 lists the components included with your kit.

Table 1-2. CardBus-8310 Kit Components

Quantity	Item
1	NI CardBus-8310
2	3 meter CAT5-e cables with 4 ferrites (two ferrites for each cable). 10-meter and 14-meter cables may be purchased separately.
1	NI PXI-8310
1	Software Installation CD (will contain the software driver, full user manual, and Documents of Conformity)
1	Installation Guide



Caution In order to complete the installation of the CardBus-to-PXI expansion system you will need perform the installation in a suitable electrostatic discharge (ESD) protective environment.

Protecting Against Electrostatic Discharge

You can take the following steps to prevent damage from electrostatic discharge (ESD):

- When unpacking a static-sensitive component from its shipping carton, do not remove the anti-static packaging material until you are ready to install the component in a computer. Just before unwrapping the anti-static packaging, be sure you are at an ESD workstation, or that you are electrically grounded.
- When transporting a sensitive component, first place it in an anti-static container or package.

- Handle all sensitive components at an ESD workstation. If possible, use anti-static floor pads and workbench pads.
- Handle components and boards with care. Don't touch the components or contacts on a board. Hold a board by its edges or by its metal mounting bracket.

NI PXI-8310 Overview

The NI PXI-8310 expansion card is connected to the NI CardBus-8310 through the CAT5-e cables. You must install the PXI card in slot 1 (the system controller slot) of the PXI chassis. The NI PXI-8310 card has two ports for communication (L0 and L1), each utilizing four twisted pair connections. Each twisted pair is represented on the PXI card front panel by a separate LED. If a twisted pair connection is functioning, the corresponding LED will be lit on the front panel.

Each port requires two CAT5-e cables. You must connect the RX jack of the CardBus-8310 to the TX jack of the PXI-8310, and the TX jack of the CardBus-8310 to the RX jack of the PXI-8310.



Note You must use the RX and TX connector for the same port to establish communication. For instance, use the L1 RX and TX connectors to establish communication on the L1 port. If you only use one port, it is recommended that you use the L0 port, as the status LEDs will be easier to see.

The top 4 LEDs provide connection status of the top two RJ-45 jacks (labeled L0) while the bottom 4 LEDs provide the status of the bottom two jacks (L1). Each pair of RJ-45 jacks constitutes a link capable of throughput of up to 2.5 Gbps at full duplex, one jack being used as transmitter (TX) and the other as receiver (RX). The LED control register within the StarGen chip can operate them in one of three modes.

- **All LEDs off**—No Link. The differential receiver and transmitter are not synchronized, meaning that the RJ45 cables are either not connected or they are crossed.
- **All LEDs on**—Link is active. The differential transmitter and receiver are synchronized and data can flow across the link.
- **All LEDs blinking**—Communication has been lost. At some point the transmitter and receiver were linked, however now they are longer synchronized. The link needs to be re-established before data can be transmitted again.

If one or more LEDs for a given port (L0 or L1) are not lit, it indicates that the twisted pair represented by that LED is not properly connected.

Table 1-3 describes the status indicated by each unlit LED. The same descriptions apply for the L0 LEDs and the L1 LEDs.

Table 1-3. Unlit LED Status Descriptions

LED	Description
0	The PXI card senses no link on its differential pair 0.
1	The PXI card senses no link on its differential pair 1.
2	The PXI card senses no link on its differential pair 2.
3	The PXI card senses no link on its differential pair 3.

Link problems may involve one or more LEDs turning off, depending on the affected differential pair. It is recommended that you re-seat the cable to see if that resolves the issue. It is also possible that one of the port cables may need to be replaced.



Note A faulty cable may link some differential pairs while disabling others and the LEDs can be used to isolate the faulty cable. If replacing the cable does not resolve the issue, there may be a problem with the StarGen bridge. In that case, contact National Instruments with the information described in the *Contacting Technical Support* section of Appendix C, *Troubleshooting NI PXI-CardBus-8310 Cards*.

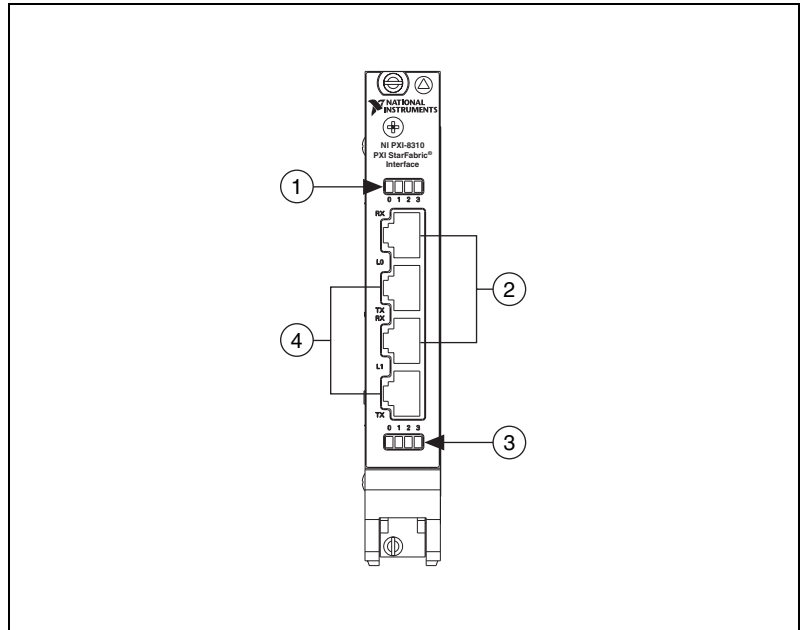

- | | | | |
|---|---------------------------|---|---------------------------|
| 1 | L0 Link Status LEDs (0-3) | 3 | L1 Link Status LEDs (0-3) |
| 2 | Receiver Ports (RX) | 4 | Transmitter Ports (TX) |

Figure 1-2. Front Panel of the NI PXI-8310 Expansion Card

Hardware and Software Installation

The following steps will guide you in completing the installation of your new NI CardBus-8310-to-PXI system.

Installation Instructions

It is highly recommended that Microsoft Windows users follow the software driver installation instructions exactly, in the order in which the instructions are presented in this chapter. If you do not follow the driver installation instructions, you will greatly increase your chances of failure while configuring your system.



Note The NI-CardBus-8310 driver is intended for use only with Windows 2000 and Windows XP.

Install the Software Driver



Cautions You will be prompted to reboot after the software installation. Each shut down and reboot is important and is required for correct installation. If you shut down and reboot when requested, it may save you from having to make a call to NI technical support.

You *must* be logged in as a system administrator while installing the software. You must remain logged in as system administrator until installation is complete.



Notes Under Windows XP, you must install the NI CardBus-8310 driver *before* connecting or inserting the hardware into the CardBus slot.

If you are using Windows XP, the “Found New Hardware” dialog box will only appear if you have Service Pack 2 installed. This dialog appears by default under Windows 2000.

Windows 2000/XP (Without XP Service Pack 2)

1. If you do not have your system configured to allow autorun CDs, you must run `SETUP.EXE` to install the NI CardBus-8310 driver.
2. Follow the prompts to install the software.
3. When the software prompts you reboot, do so. When the system has been rebooted, the installation process is complete.

Windows XP (With Service Pack 2)

1. If you do not have your system configured to allow autorun CDs, you must run `SETUP.EXE` to install the NI CardBus-8310 driver.

After the software setup utility launches, the dialog box shown in Figure 2-1 will appear.

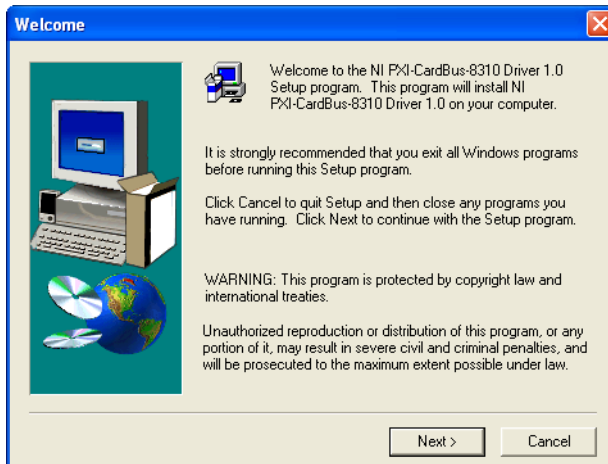

Figure 2-1. Software Installation Dialog Box

2. The driver will make a small change to `boot.ini`, and then prompt you to reboot, as shown in Figure 2-2. You must do this before the driver install can continue.



Figure 2-2. Reboot Dialog Box Under Windows XP Service Pack 2

After the reboot, the installation utility will re-launch automatically, and you will see the dialog box shown in Figure. 2-1.

3. **Click Next.**

The dialog box shown in Figure 2-3 will appear.

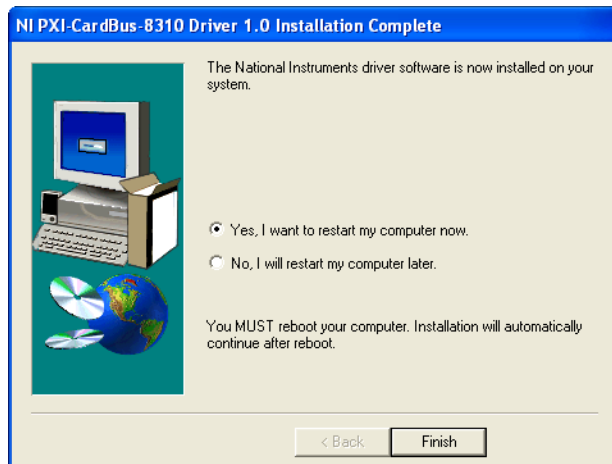

Figure 2-3. Reboot Dialog Box

4. Choose **No** and click **Finish**.
5. Manually shut down your computer.



Note Before you shut down the system to proceed to the next step, you should also install any drivers that may be required by the PXI cards. For instance, if you are using a PXI-GPIB card in your expansion chassis, install the latest NI-GPIB driver, etc. Driver CDs are shipped with each PXI card. It is recommended that you install the NI CardBus-8310 driver first, then the PXI drivers.

Install the PXI Cards



Cautions High voltages are present inside the chassis when the power cord is plugged into an electrical outlet. Disconnect the power cord from its source before removing the chassis cover.

All PXI cards are susceptible to electrostatic discharge. When moving PXI cards, it is best to carry the cards in anti-static packaging. If you need to set a card down, be sure to place it inside or on top of an anti-static surface. For more information, refer to the [Protecting Against Electrostatic Discharge](#) section of Chapter 1.

When installing PXI cards or hard drives, ensure that the input current rating specified on the AC input label is not exceeded.

Generally, when installing PXI cards in the expansion system, it should make no difference what slot order you place your cards in, unless specified by the PXI card manufacturer.

Install the PXI cards following the PXI card manufacturer's recommendations. Be sure to seat the cards securely. Make sure that all PXI cards are fully seated in their connectors. When correctly seated in its connector, you will notice a firm resistance when you pull up gently on the card.

Not all PXI cards are consistent in their behavior. Sometimes simply moving a PXI card that is having a problem to a different slot, or reordering your cards in their slots, may alleviate issues.

Attach the PXI Expansion Cables

1. Carefully position the PXI chassis so that the supplied cables will conveniently reach from the connector of the NI CardBus-8310 card to the connectors on the NI PXI-8310.
2. Install one of the provided ferrites on each end of each of your cables. All four ferrites should be installed.

3. For each cable, Receive (RX) on one card attaches to Transmit (TX) on the other card. Attach one CAT5-e cable to the Receive (RX) port on the NI CardBus-8310 card. Attach the other end to the Transmit (TX) terminal on the NI PXI-8310 card. Attach one CAT5-e cable to the Transmit (TX) port on the NI CardBus-8310 card, then attach the other end to the Receive (RX) port on the NI PXI-8310 card. The LEDs on the NI PXI-8310 will light up if the cables are connected properly.

If the LED lights flash continuously, reboot the laptop.

Install the NI CardBus-8310

This step can only be completed after the NI CardBus-8310 software has been installed.



Note CardBus cards can only be used in systems that support CardBus. A special keying mechanism prevents insertion into systems that do not support 32-bit CardBus cards.

1. Power down your laptop computer. Use the procedures for shutting down your operating system and shutting off power to your system that have been provided in your owner's manual or host computer documentation.
2. Insert the NI CardBus-8310 with the NI logo side up (gold strip up) into the host computer CardBus slot. Gently push the card until it is seated firmly.
3. For more information on using CardBus cards, refer to your host computer's user manual.

Powering Up

Apply power to the PXI chassis first, and then power up your host computer. This will allow the higher-numbered buses in your hierarchy to stabilize before the host computer issues its master power-on bus reset. In systems that perform automatic bus configuration, this will allow the configuration code to recognize the bus hierarchy and the attached devices.



Note The driver allows you to hot-plug your CardBus-8310 card into the CardBus slot on your laptop, but you should never hot-plug a PXI card into a PXI chassis as it will cause physical damage to the board, and possibly the backplane.

1. Make sure your CAT5-e cables are connected correctly, then turn on the PXI chassis, and plug the NI CardBus-8310 card into the laptop. Power up the host computer.
2. Both LEDs should be lit on the NI PXI-8310. Flashing LEDs indicate that the wires are reversed. If the LEDs are flashing, switch the wires and begin again at step 1.
3. The dialog box shown in Figure 2-4 will appear the first time you boot your computer with the PXI chassis connected.



Figure 2-4. Found New Hardware Wizard Dialog Box (Windows 2000/XP SP2 Only)

4. Choose **No** and click **Next**.

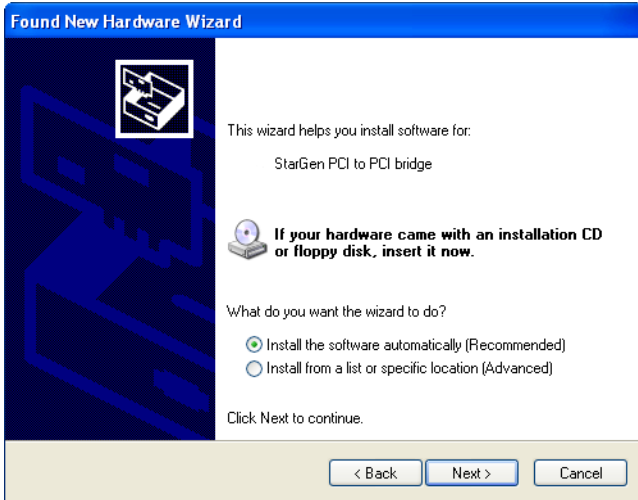

Figure 2-5. Software Installation Options

5. Choose automatic installation and click **Next**.

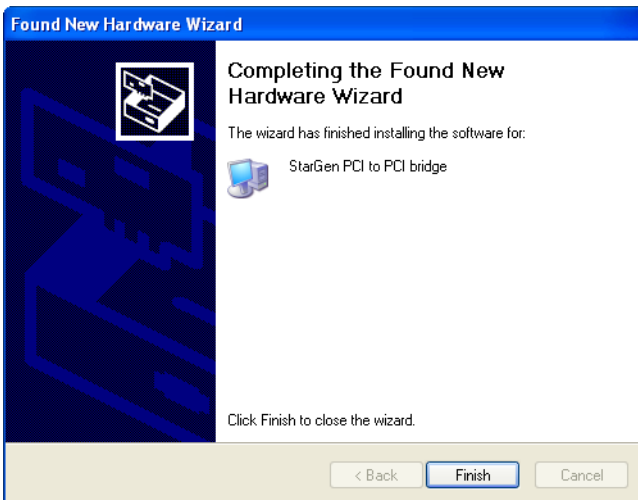

Figure 2-6. Installation Wizard Completion Dialog Box

6. Once the StarGen PCI to PCI bridge installation is complete, click **Finish**.

7. The Found New Hardware Wizard dialog box will appear again, and will find another PCI to PCI bridge, because there are two bridge chips. Follow the instructions outlined in steps 4 through 7 to successfully install the second PCI to PCI bridge.
8. The Found New Hardware Wizard will now detect the PXI modules that have been installed in the PXI chassis. Follow the same procedure described in steps 4 through 7 to successfully install each module.



Note Remember that PXI devices in the chassis will not be recognized unless the device-specific driver has been installed. The devices will show up as generic PCI devices and will not operate properly.

Verifying the Installation

Go to **Start»Control Panel»Printers and Other Hardware»System»Hardware»Device Manager** and make sure **View device by connection** is selected. From there, go to **ACPI»Microsoft ACPI-Compliant System»PCI Bus**. Open the device branches until you reach the CardBus bridge. Under this entry you should see any hardware that is installed in the PXI chassis. In Figure 2-7, a PXI-GPIB card has been installed in a PXI chassis.

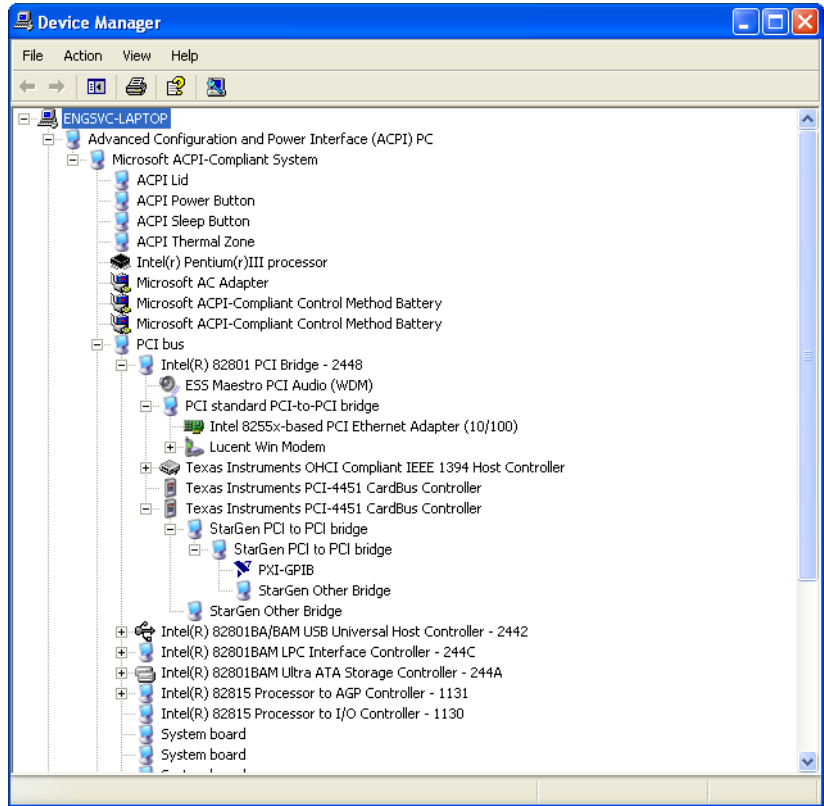

Figure 2-7. PXI Module Shown In Device Manager Tree

The NI CardBus-8310 CardBus Driver installation is now complete.

Powering Down



Caution The hardware will not support powering down the chassis before the host computer. If you do so, the machine may hang, blue screen, or it may even appear to be working. The condition of the system will be very unstable. If you must power down the PXI chassis without shutting down the host computer, stop the NI CardBus-8310 device first by using the undock manager in the system tray and requesting removal first.

It is recommended that you first shut down the host computer correctly, and then power down the PXI chassis to avoid a computer lock-up.

Running the System



Cautions High voltages are present inside the chassis when the chassis power cord is plugged into an electrical outlet. Disconnect the power cord from its source.

Before touching anything inside the chassis, move to an ESD station and follow proper ESD procedure. Failure to do so may result in electrostatic discharge damaging the computer or its components. For more information, refer to the [Protecting Against Electrostatic Discharge](#) section of Chapter 1.

If there is a problem, be sure to turn off the power before making any changes. If you are having trouble with the system, turn off the host computer and the chassis, then check that all cards are seated properly and all cables are connected.

If you are still having problems, check Appendix C, [Troubleshooting NI PXI-CardBus-8310 Cards](#), for more information.

Uninstalling the NI CardBus-8310 Driver

Go to **Start»Settings»Control Panel»Add/Remove Programs**. Select the NI CardBus-8310 driver, and then select **Add/Remove**.

Additional Notes

The following notes are observations made during the testing of the NI CardBus-8310 and the NI PXI-8310.

System Hierarchy

To connect additional PXI chassis through MXI-4, please connect them to the first PXI bus segment in the first chassis as shown in Figure 2-8. The preferred connection style is a Star configuration, rather than a daisy-chain, which is shown in Figure 2-9. The system will support daisy-chaining, but only to a certain depth of PCI bus segments. Systems connected in a Star configuration will also exhibit lower latency.

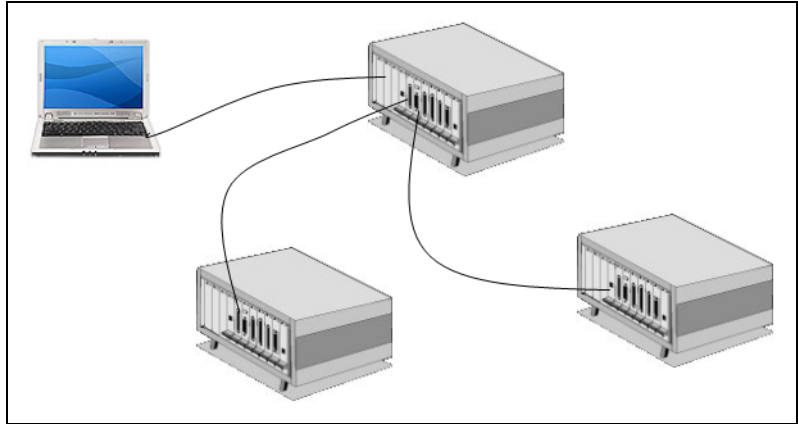

Figure 2-8. Star Configuration (Preferred)

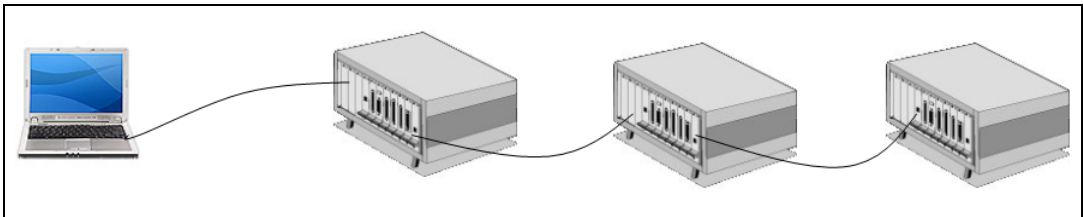

Figure 2-9. Daisy-Chain Configuration (Non-Preferred)

System Boot

In systems with a large number of modules and chassis, the host computer may appear to hang, taking more than 20 seconds at the Windows XP splash screen. This operation is expected, as the operating system is enumerating all the devices in the PCI bus hierarchy, which can take time in a complex configuration.

NI Measurement & Automation Explorer (MAX)

The initial launch of MAX may take a long time (several minutes) to discover all the devices in a system with a large number of modules and chassis.

PCIScope

Overview

PCIScope is a powerful monitoring tool designed by the German company APSoft. This software utility is used to explore, examine and debug the PCI subsystem of your computer. PCIScope has proven to be very useful when verifying and debugging configurations involving an NI PXI expansion system under a Windows platform. It can provide information such as PCI bus numbering and resource allocation, as well as other information that may prove useful when debugging expansion chassis or PCI card problems.

When the PCIScope utility is installed on your computer, a window similar to the one shown in Figure A-1 will appear. (The example shown was taken from a Compaq Armada 7400.)

Visit www.tssc.de for more information about the capabilities of PCIScope and other utilities offered by APSoft.

An evaluation version of PCIScope can be downloaded from www.tssc.de. (You can purchase a license from APSoft for use beyond the evaluation period for \$49.95.)

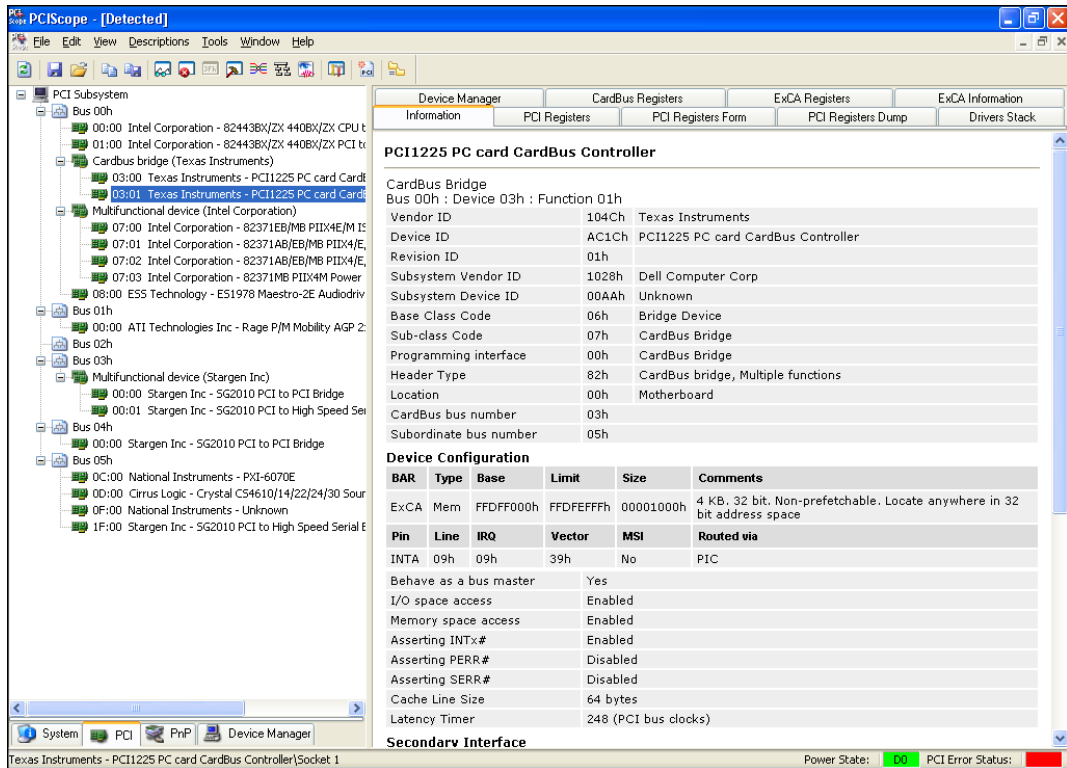

Figure A-1. Example of PCIScope Interface

The data can be stored as a *.bpd file on your computer. You may be requested to email this file to support@ni.com if you are experiencing configuration problems.

Specifications

This appendix deals with safety and environmental specifications for the NI CardBus-8310-to-PXI Expansion system.

Power Requirements

This section discusses the DC output for the NI CardBus-8310-to-PXI system.

NI CardBus-8310

Typical

3.3 V 0.25 A

5 V 0 A

Maximum

3.3 V 0.30 A

5 V 0 A

NI PXI-8310

Typical

3.3 V 0.15 A

5 V 1.5 A

Maximum

3.3 V 0.40 A

5 V 1.7 A

Physical

Sustained Throughput

Input Up to 50 MB/s

Output Up to 10 MB/s

Dimensions

NI CardBus-8310.....	Type II PC Card
NI PXI-8310	1-slot 3U PXI module
Slot requirements	One 3U PXI system controller slot
Maximum cable length	14 m
Compatibility	Fully compatible with the <i>PXI Hardware Specification 2.1</i>

Operating Environment

Temperature	
CardBus-8310.....	0 to 40 °C
PXI-8310	0 to 55 °C
Relative humidity	10 to 90%

Storage Environment

Temperature	-40 to 70 °C
Relative humidity	5 to 95% noncondensing

Safety

The CardBus-8310-to-PXI Expansion system was designed to meet the requirements of the following standards of safety for electrical equipment for measurement, control, and laboratory use:

- EN 61010-1 A2:1995



Note For UL and other safety certifications, refer to the product label, or refer to the Document of Conformity, which has been included as a digital document on your driver CD.

Electromagnetic Compatibility

Emissions	EN 55011 Class A @ 10 meters FCC Part 15A above 1 GHz
Immunity	Evaluated to EN 61326:1998, Table 1
EMC/EMI.....	CE, C-Tick, and FCC Part 15 (Class A) Compliant

CE Compliance



Note Refer to the Declaration of Conformity (DoC) for this product for any additional regulatory compliance information. The DoC for this product has been included as a digital document on your driver CD.



Troubleshooting NI PXI-CardBus-8310 Cards

This appendix deals with troubleshooting methods for an NI CardBus-8310-to-PXI system.



Caution To avoid potential issues with this configuration, please install the NI CardBus-8310 driver before inserting the CardBus card.

Contacting Technical Support

While this appendix contains a number of troubleshooting tips for resolving issues that may be experienced with NI CardBus-8310 cards, extreme cases may require you to contact National Instruments Technical Support. You can find that contact information in the *Technical Support and Professional Services* appendix of this manual.

You must be ready to give the following information prior to troubleshooting the system.

- Name and model of laptop (exact model)
- Name of CardBus card controller
- Number of PCMCIA sockets (1 or 2 sockets)
- Which socket is being used
- Operating system version
- Third party cards: name, model and manufacturer—If there are multiple cards, you will need all of the information provided
- Type of card
- Whether the card has a hardware bridge
- Application name and version

Troubleshooting

The following list relates problems that have been observed during initialization. Below the list, elaboration upon each issue is provided, along with steps to correct it.

1. No LEDs are lit on the NI PXI-8310 card.
2. The LEDs are flashing on the NI PXI-8310 card.
3. One or more LEDs are not lit on the NI PXI-8310 card.
4. An error is returned after inserting the CardBus card before installing the CardBus card driver.
5. The host computer is unable to detect the PXI chassis.
6. The host computer is unable to detect the third party PXI card in Windows Device Manager.
7. The application or program is unable to detect the third party PXI card.
8. The host computer won't boot when the PXI chassis is connected.
9. The host computer is blue-screening/frozen while installing the NI CardBus-8310 driver.
10. The system froze after installing the NI CardBus-8310 driver.
11. The host computer is blue-screening/frozen during reboot after installing the NI CardBus-8310 driver.
12. The application or program failed to communicate with the PXI device card during an operation.
13. An error (yellow exclamation mark) shows up next to the card in Device Manager.

Issue: No LEDs are lit on the NI PXI-8310 card.

- Eject and re-insert the NI CardBus-8310 card.
- Re-seat both cable connections.
- Swap the cables. Ensure that one end of the cable goes into the Transmitter (TX) port on the NI CardBus-8310 card, and the other end goes into the Receiver (RX) port of the NI PXI-8310 card.
- Try or use another cable of the same length.
- If using a long cable, try using a shorter one.

Issue: The LEDs are flashing on the NI PXI-8310 card.

- Reverse the TX and RX cables, and power up again.

- Try ejecting and re-inserting the CardBus card.
- Power down the laptop and the chassis system. Power up the chassis first and then power up the computer.

Issue: One or more LEDs are not lit on the NI PXI-8310 card.

This may be a defective hardware. Please call customer service for support.



Note The hardware may still appear to function, but at a reduced bandwidth.

Issue: An error is returned after inserting the CardBus card before installing the CardBus card driver.

1. Go to **Windows Device Manager»View»Devices by connection**, as shown in Figure C-1.

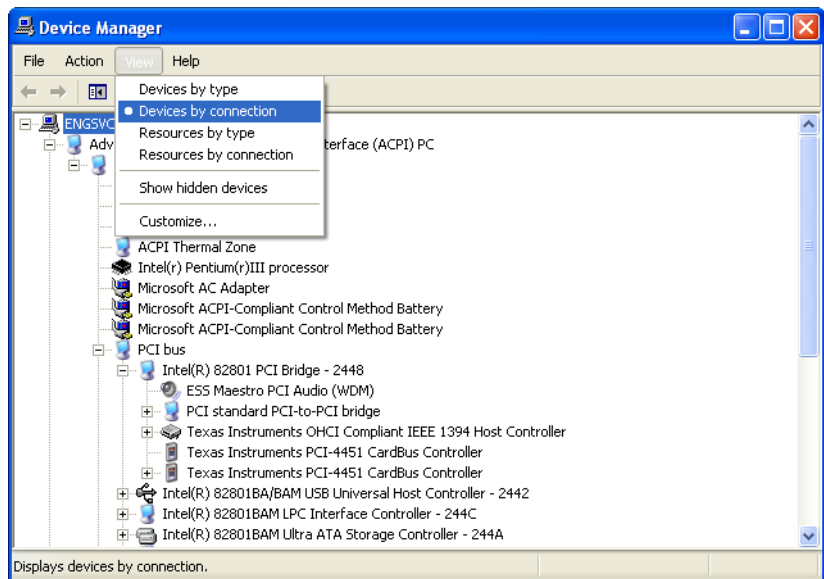

Figure C-1. Devices by Connection Menu in Device Manager

2. Remove the CardBus card from the PCMCIA slot. Install the *NI CardBus Driver 1.0* from the provided driver CD.

After installing the NI CardBus-8310 Driver, the CardBus device will be visible in Device Manager.

Issue: The host computer is unable to detect the PXI chassis.

- If the LEDs are flashing on the NI PXI-8310 card:
 - Try ejecting and reinserting the CardBus card.
 - Power down the laptop and the chassis system. Power up the chassis first and then the computer.
- If there are no LEDs lit on the NI PXI-8310 card:
 - Verify that the CardBus card is inserted properly.
 - Try ejecting and re-inserting the CardBus card.
 - Re-seat both cable connections.
 - Swap the cables. Make sure the one end of the cable goes into the Transmitter (TX) port on the NI CardBus-8310 card, the other end goes into the Receiver (RX) port on the NI PXI-8310 card.
 - Test with another cable of the same length.
 - If using a long cable, try using a shorter one.
- One or more LED lights are not lit.

This may be defective hardware. Please call customer service for support.

Issue: The host computer is unable to detect the third party PXI card in Windows Device Manager.

- If you see a yellow exclamation mark (error) next to the generic entries “Other PCI Bridge Device” and “PCI standard PCI-to-PCI bridge” in **Windows Device Manager»View»Devices by connection:**
 - Please eject the CardBus card, and install the NI CardBus-8310 driver before inserting the NI CardBus-8310 card.
- If you see an entry called “StarGen Other Bridge” in Device Manager but do not see any bridge devices:
 - Turn off the system completely. Power up the PXI chassis first, and then power up the laptop. Ensure that the PXI chassis is powered up properly before the laptop is turned on.
 - Swap the cables. Make sure that one end of the cable goes into the Transmitter (TX) port on the NI CardBus-8310 card, the other end goes into the Receiver (RX) port on the NI PXI-8310 card.
 - Eject and re-insert the NI CardBus-8310 card.

Issue: The application or program is unable to detect the third party PXI card.

Go to **Windows Device Manager»View»Devices by connection**, expand the device branches to see if there is a yellow exclamation mark (error) in front of the affected PXI card.

- If there is a yellow exclamation mark in front of the PXI card:
 - Double-click on the PXI device to find out the Error Code number. Refer to the *Error Code (Yellow Exclamation Mark) in Device Manager* section at the end of this appendix for more information on the yellow exclamation mark.
 - Re-install the driver for the third party PXI card using the manufacturer's installation instructions.



Note You may want to check the manufacturer's web site to see if there are any installation/driver updates for the device.

- If there is no yellow exclamation mark in front of the PXI card:
 - Re-install the driver for the third party PXI card using the manufacturer's installation instructions.
 - If another PXI card that has worked in the past is available, try installing it in the same slot.
 - Plug the PXI card into a different slot in the chassis, to make sure that the chassis is functional.

Issue: The host computer won't boot when the PXI chassis is connected.

Has any other hardware or software been added to the host computer recently? If not, please call customer support for service. Otherwise:

- Remove the recently installed program or hardware, and re-test the system.
- Reboot the computer and see if that fixes the problem.
- Make sure that recently added hardware or software is fully-compatible with the operating system.
- Remove all the cards in the PXI chassis, then reboot the system with the empty chassis connected. In **Windows Device Manager»View»Devices by connection**, there should be no errors. At this point, power down and begin adding PXI cards one by one, powering up to check that there are no errors in Device Manager after installing each card. This can isolate problematic hardware/software.

Issue: The host computer is blue-screening/frozen while installing the NI CardBus-8310 driver.

Re-install the NI CardBus-8310 driver again from the driver CD provided in your kit. If the problem occurs consistently, please contact National Instruments for technical support.

Issue: The system froze after installing the NI CardBus-8310 driver.

- If any other hardware or software has been added recently:
 - Remove the recently installed program or hardware, and re-test the system.
 - Reboot the computer and see if that fixes the problem.
 - Ensure that the recently added hardware or software is fully-compatible with the operating system.
 - Consult the manufacturer's web site to see if there is a driver update.
- If no other hardware or software has been added recently:
 - Verify that the NI CardBus-8310 driver has loaded. If not, re-install the NI CardBus-8310 driver.
 - Verify that the NI CardBus-8310 card is inserted properly.
 - Test the PCMCIA socket by using a different CardBus card, such as a wireless CardBus card or modem, etc.
 - Verify that you are using the correct expansion interface cards. You should be using an NI CardBus-8310 card in your host computer, and an NI PXI-8310 card in your PXI chassis.
 - Re-seat both cable connections.
 - Clean the cable with solvent alcohol using a soft bristle brush.
 - Swap cables or reverse both end connections.
 - Use another cable of the same length.
 - If you are using a long cable, try using a shorter one.

Issue: The host computer is blue-screening/frozen during reboot after installing the NI CardBus-8310 driver.

1. Reboot the system and press <F8> to go into Windows Safe Mode.
2. Go to C:\Windows\System32\drivers, and delete Mobridg.sys.
3. Reboot the system.
4. Re-install the NI CardBus-8310 driver again from the driver CD provided.

If the problem occurs consistently, please contact National Instruments for technical support.

Issue: The application or program failed to communicate with the PXI device card during an operation.

- Make sure the PXI chassis is properly powered.
- Check the LED lights on the NI PXI-8310 card.
 - No LEDs lit on the NI PXI-8310 card.
 - Re-insert the NI CardBus-8310 card.
 - Re-seat both cable connections.
 - Swap cables or reverse both end connections.
 - Use another cable of the same length.
 - If you are using a long cable, try using a shorter one.
 - LEDs flashing on the NI PXI-8310 card.
 - Eject the NI CardBus-8310 card and re-insert it.
 - Power down the laptop and the chassis system. Power up the chassis and then the laptop.
 - Only part of the LEDs are lit.

This may be defective hardware. Please call customer service for support.
- Go to **Windows Device Manager»View»Devices by connection**, expand the device branches to see if there is yellow exclamation mark (error) in front of the card.
 - If there is yellow exclamation mark (error) in front of the card:
 - Double-click on the device to find out the Error Code number. (Refer to the [Error Code \(Yellow Exclamation Mark\) in Device Manager](#) section at the end of this appendix for more information.)
 - If there is no yellow exclamation mark (error) in front of the card:
 - Re-install the driver for the third party card using the manufacturers installation instructions.



Note You may want to check the manufacturer's web site to see if there are any installation/driver updates for the device.

- If another card that has worked in the past is available, try it in the same slot.
- Plug the card into a different slot in the chassis, to ensure that the chassis is functional.

Error Code (Yellow Exclamation Mark) in Device Manager

The following section interprets the error codes corresponding to the yellow exclamation point used in Windows Device Manager to denote hardware errors.

Error Code 1 on a third party card in the PXI chassis

This means that there is no driver installed for this device. Re-install the driver for the third party card using the manufacturer's installation instructions.



Note You may want to check the manufacturer's web site to see if there are any installation/driver updates for the device.

Error Code 10 on a third party card in the PXI chassis

The device failed to start. This usually means that the driver is not properly installed or the driver is not compatible with the Windows Driver Model (WDM). Re-install the driver for the third party card using the manufacturer's installation instructions.



Note You may want to check the manufacturer's web site to see if there are any installation/driver updates for the device.

Error Code 12 on the first standard PCI-to-PCI Bridge

This usually means the NI CardBus-8310 driver is not installed, so the resources are not allocated correctly. To resolve this issue, install the NI CardBus-8310 driver before inserting the NI CardBus-8310 card into the CardBus slot on the host computer.

Error Code 12 on a third party card in the PXI chassis

This usually means the memory, I/O, or Prefetch required by the card is more than what has been allocated by the NI driver. Right-click on the

NI icon in the system tray of your desktop, click **Reset Bridges Settings** and restart your computer.

Error Code 28 on the Other PCI Bridge Device

This code means the device was not installed completely. Re-install the NI CardBus-8310 driver from the driver CD provided before inserting the NI CardBus-8310 card into the CardBus slot of the host computer.

Error Code 28 on a third party card in the PXI chassis

This code means the device was not installed completely. To resolve this issue, remove the device from Device Manager (by right-clicking the device entry and selecting **Uninstall**) and use the Add New Hardware Wizard to re-detect it. If that is unsuccessful, re-install the driver from the installation CD provided, or get the latest driver from the manufacturer's web site.

Error Code 31 on a third party card in the PXI chassis

This error means that the device is not working properly. This code usually appears when a device is dependent on another device to function properly. Remove the device from Device Manager (by right-clicking the device entry and selecting **Uninstall**) and use the Add New Hardware Wizard to re-detect it. If that is unsuccessful, use the other CardBus socket in your host computer. If you don't have another CardBus socket, please contact technical support.

For more information on the Windows Device Manager Error Codes please visit the Microsoft page:

http://www.microsoft.com/resources/documentation/Windows/XP/all/reskit/en-us/Default.asp?url=/resources/documentation/Windows/XP/all/reskit/en-us/prjk_dec_lgsc.asp

Technical Support and Professional Services

Visit the following sections of the National Instruments Web site at ni.com for technical support and professional services:

- **Support**—Online technical support resources at ni.com/support include the following:
 - **Self-Help Resources**—For answers and solutions, visit the award-winning National Instruments Web site for software drivers and updates, a searchable KnowledgeBase, product manuals, step-by-step troubleshooting wizards, thousands of example programs, tutorials, application notes, instrument drivers, and so on.
 - **Free Technical Support**—All registered users receive free Basic Service, which includes access to hundreds of Application Engineers worldwide in the NI Developer Exchange at ni.com/exchange. National Instruments Application Engineers make sure every question receives an answer.

For information about other technical support options in your area, visit ni.com/services or contact your local office at ni.com/contact.

- **Training and Certification**—Visit ni.com/training for self-paced training, eLearning virtual classrooms, interactive CDs, and Certification program information. You also can register for instructor-led, hands-on courses at locations around the world.
- **System Integration**—If you have time constraints, limited in-house technical resources, or other project challenges, National Instruments Alliance Partner members can help. To learn more, call your local NI office or visit ni.com/alliance.

- **Declaration of Conformity (DoC)**—A DoC is our claim of compliance with the Council of the European Communities using the manufacturer’s declaration of conformity. This system affords the user protection for electronic compatibility (EMC) and product safety. You can obtain the DoC for your product by visiting ni.com/certification. A PDF copy of the DOC is available on the NI-PXI-CardBus-8310 driver CD.

If you searched ni.com and could not find the answers you need, contact your local office or NI corporate headquarters. Phone numbers for our worldwide offices are listed at the front of this manual. You also can visit the Worldwide Offices section of ni.com/niglobal to access the branch office Web sites, which provide up-to-date contact information, support phone numbers, email addresses, and current events.

Index

C

- cable installation, 2-4
- cable options, 1-3
- CardBus-8310 installation, 2-5
- contacting technical support, C-1
- conventions used in the manual, v

D

- Declaration of Conformity (NI resources), D-2
- diagnostic tools (NI resources), D-1
- documentation
 - conventions used in the manual, v
 - NI resources, D-1
- drivers (NI resources), D-1

E

- electromagnetic compatibility, B-3
- ESD protection, 1-4
- examples (NI resources), D-1

F

- functional overview, 1-1
- functional unit descriptions, 1-2

H

- help, technical support, D-1

I

- installation
 - cabling, 2-4
 - CardBus-8310, 2-5
 - ESD protection, 1-4
 - parts list, 1-4
 - powering up, 2-5
 - preparation, 1-3
 - PXI cards, 2-4
 - software driver, 2-1
 - supported operating systems, 2-1
 - troubleshooting, C-1
 - uninstalling the CardBus driver, 2-10
 - verification, 2-8
- instrument drivers (NI resources), D-1

K

- kit components, 1-4
- KnowledgeBase, D-1

L

- latencies
 - Measurement and Automation Explorer (MAX), 2-11
 - system boot, 2-11

M

- Measurement and Automation Explorer (MAX), 2-11

N

National Instruments support and services, D-1
NI CardBus-8310, 1-2
NI PXI-8310, 1-5
 front view (figure), 1-7
NI support and services, D-1

O

OS support, 2-1
overview
 cabling, 1-3
 functional, 1-1
 NI CardBus-8310, 1-2
 NI PXI-8310, 1-5
 RJ-45 connector, 1-3
 StarFabric bridge, 1-2

P

parts list, 1-4
PCIScope utility, A-1
powering down the system, 2-9
powering up the system, 2-5
preparing to install, 1-3
programming examples (NI resources), D-1
PXI card installation, 2-4

R

RJ-45 connector, 1-3

S

safety specifications (table), B-2
software (NI resources), D-1
software driver installation, 2-1

specifications
 electromagnetic compatibility, B-3
 safety, B-2
StarFabric bridge, 1-2
supported operating systems, 2-1
system boot latencies, 2-11
system hierarchy, 2-10
system operation, 2-10

T

technical support, D-1
training and certification (NI resources), D-1
troubleshooting (NI resources), D-1
troubleshooting your system, C-1

U

uninstallation, 2-10
using the system, 2-10

V

verifying the hardware installation, 2-8

W

Web resources, D-1

Free Manuals Download Website

<http://myh66.com>

<http://usermanuals.us>

<http://www.somanuals.com>

<http://www.4manuals.cc>

<http://www.manual-lib.com>

<http://www.404manual.com>

<http://www.luxmanual.com>

<http://aubethermostatmanual.com>

Golf course search by state

<http://golfingnear.com>

Email search by domain

<http://emailbydomain.com>

Auto manuals search

<http://auto.somanuals.com>

TV manuals search

<http://tv.somanuals.com>