

GPIB-BUF

User Manual

February 1994 Edition

Part Number 320125-01

**© Copyright 1989, 1994 National Instruments Corporation.
All Rights Reserved.**

National Instruments Corporate Headquarters

6504 Bridge Point Parkway

Austin, TX 78730-5039

(512) 794-0100

Technical support fax: (800) 328-2203

(512) 794-5678

Branch Offices:

Australia (03) 879 9422, Austria (0662) 435986, Belgium 02/757.00.20,

Canada (Ontario) (519) 622-9310, Canada (Québec) (514) 694-8521,

Denmark 45 76 26 00, Finland (90) 527 2321, France (1) 48 14 24 24,

Germany 089/741 31 30, Italy 02/48301892, Japan (03) 3788-1921,

Netherlands 03480-33466, Norway 32-848400, Spain (91) 640 0085,

Sweden 08-730 49 70, Switzerland 056/20 51 51, U.K. 0635 523545

MicroGPIB Products

National Instruments has developed the MicroGPIB product line to offer a series of high performance, low cost IEEE 488 support items that are packaged in small all-metal cases, capable of being rack mounted.

Limited Warranty

The GPIB-BUF is warranted against defects in materials and workmanship for a period of two years from the date of shipment, as evidenced by receipts or other documentation. National Instruments will, at its option, repair or replace equipment that proves to be defective during the warranty period. This warranty includes parts and labor.

A Return Material Authorization (RMA) number must be obtained from the factory and clearly marked on the outside of the package before any equipment will be accepted for warranty work. National Instruments will pay the shipping costs of returning to the owner parts which are covered by warranty.

National Instruments believes that the information in this manual is accurate. The document has been carefully reviewed for technical accuracy. In the event that technical or typographical errors exist, National Instruments reserves the right to make changes to subsequent editions of this document without prior notice to holders of this edition. The reader should consult National Instruments if errors are suspected. In no event shall National Instruments be liable for any damages arising out of or related to this document or the information contained in it.

EXCEPT AS SPECIFIED HEREIN, NATIONAL INSTRUMENTS MAKES NO WARRANTIES, EXPRESS OR IMPLIED, AND SPECIFICALLY DISCLAIMS ANY WARRANTY OF MERCHANTABILITY OR FITNESS FOR A PARTICULAR PURPOSE. CUSTOMER'S RIGHT TO RECOVER DAMAGES CAUSED BY FAULT OR NEGLIGENCE ON THE PART OF NATIONAL INSTRUMENTS SHALL BE LIMITED TO THE AMOUNT THEREFORE PAID BY THE CUSTOMER. NATIONAL INSTRUMENTS WILL NOT BE LIABLE FOR DAMAGES RESULTING FROM LOSS OF DATA, PROFITS, USE OF PRODUCTS, OR INCIDENTAL OR CONSEQUENTIAL DAMAGES, EVEN IF ADVISED OF THE POSSIBILITY THEREOF. This limitation of the liability of National Instruments will apply regardless of the form of action, whether in contract or tort, including negligence. Any action against National Instruments must be brought within one year after the cause of

action accrues. National Instruments shall not be liable for any delay in performance due to causes beyond its reasonable control. The warranty provided herein does not cover damages, defects, malfunctions, or service failures caused by owner's failure to follow the National Instruments installation, operation, or maintenance instructions; owner's modification of the product; owner's abuse, misuse, or negligent acts; and power failure or surges, fire, flood, accident, actions of third parties, or other events outside reasonable control.

Copyright

Under the copyright laws, this publication may not be reproduced or transmitted in any form, electronic or mechanical, including photocopying, recording, storing in an information retrieval system, or translating, in whole or in part, without the prior written consent of National Instruments Corporation.

Trademarks

MicroGPIB[®] is a trademark of National Instruments Corporation.

Product and company names listed are trademarks or trade names of their respective companies.

Warning Regarding Medical and Clinical Use of National Instruments Products

National Instruments products are not designed with components and testing intended to ensure a level of reliability suitable for use in treatment and diagnosis of humans. Applications of National Instruments products involving medical or clinical treatment can create a potential for accidental injury caused by product failure, or by errors on the part of the user or application designer. Any use or application of National Instruments products for or involving medical or clinical treatment must be performed by properly trained and qualified medical personnel, and all traditional medical safeguards, equipment, and procedures that are appropriate in the particular situation to prevent serious injury or death should always continue to be used when National Instruments products are being used. National Instruments products are NOT intended to be a substitute for any form of established process, procedure, or equipment used to monitor or safeguard human health and safety in medical or clinical treatment.

FCC/DOC Radio Frequency Interference Compliance

This equipment generates and uses radio frequency energy and, if not installed and used in strict accordance with the instructions in this manual, may cause interference to radio and television reception. This equipment has been tested and found to comply with the following two regulatory agencies:

Federal Communications Commission

This device complies with Part 15 of the Federal Communications Commission (FCC) Rules for a Class A digital device. Operation is subject to the following two conditions:

1. This device may not cause harmful interference in commercial environments.
2. This device must accept any interference received, including interference that may cause undesired operation.

Canadian Department of Communications

This device complies with the limits for radio noise emissions from digital apparatus set out in the Radio Interference Regulations of the Canadian Department of Communications (DOC).

Le présent appareil numérique n'émet pas de bruits radioélectriques dépassant les limites applicables aux appareils numériques de classe A prescrites dans le règlement sur le brouillage radioélectrique édicté par le ministère des communications du Canada.

Instructions to Users

These regulations are designed to provide reasonable protection against harmful interference from the equipment to radio reception in commercial areas. Operation of this equipment in a residential area is likely to cause harmful interference, in which case the user will be required to correct the interference at his own expense.

There is no guarantee that interference will not occur in a particular installation. However, the chances of interference are much less if the equipment is installed and used according to this instruction manual.

If the equipment does cause interference to radio or television reception, which can be determined by turning the equipment on and off, one or more of the following suggestions may reduce or eliminate the problem.

- Operate the equipment and the receiver on different branches of your AC electrical system.
- Move the equipment away from the receiver with which it is interfering.
- Reorient or relocate the receiver's antenna.
- Be sure that the equipment is plugged into a grounded outlet and that the grounding has not been defeated with a cheater plug.

Notice to user: Changes or modifications not expressly approved by National Instruments could void the user's authority to operate the equipment under the FCC Rules.

If necessary, consult National Instruments or an experienced radio/television technician for additional suggestions. The following booklet prepared by the FCC may also be helpful: *How to Identify and Resolve Radio-TV Interference Problems*. This booklet is available from the U.S. Government Printing Office, Washington, DC 20402, Stock Number 004-000-00345-4.

Contents

| | |
|--|-----|
| About This Manual | ix |
| Introduction to the GPIB-BUF | ix |
| Organization of This Manual | ix |
| Conventions Used in This Manual | x |
| Related Documentation | x |
| Customer Communication | x |
| | |
| Chapter 1 | |
| Description of the GPIB-BUF | 1-1 |
| Introduction..... | 1-1 |
| What Your Kit Contains | 1-2 |
| Optional Equipment | 1-2 |
| The GPIB-BUF Front Panel | 1-3 |
| The GPIB-BUF Rear Panel | 1-4 |
| The GPIB Connectors | 1-4 |
| | |
| Chapter 2 | |
| Installation and Operation | 2-1 |
| Installation | 2-2 |
| Step 1. Inspect the GPIB-BUF | 2-2 |
| Step 2. Verify the Voltage Requirement | 2-2 |
| Step 3. Configure the Operating Parameters | 2-3 |
| Set Configuration Switches | 2-4 |
| Step 4. Connect the Cables | 2-6 |
| Step 5. Power on the Unit | 2-7 |
| Operation | 2-7 |
| | |
| Chapter 3 | |
| Technical Information | 3-1 |
| Power Up | 3-1 |
| Addressing | 3-2 |
| Data Transfers..... | 3-2 |
| EOI | 3-3 |
| IFC | 3-4 |
| REN | 3-4 |
| Polling the GPIB-BUF | 3-5 |
| Special Note About Timeouts..... | 3-8 |
| Multiline Command Group..... | 3-8 |

| | |
|--------------------------------------|-----|
| Appendix A | |
| Hardware Specifications | A-1 |
| Appendix B | |
| Customer Communication | B-1 |
| Glossary | G-1 |

Figures

| | |
|--|-----|
| Figure 1-1. The GPIB-BUF | 1-1 |
| Figure 1-2. The GPIB-BUF Front Panel | 1-3 |
| Figure 1-3. The GPIB-BUF Rear Panel | 1-4 |
| Figure 1-4. The GPIB Connector and Signal Designations | 1-5 |
| Figure 2-1. GPIB-BUF System Setup Example | 2-1 |
| Figure 2-2. Factory Default Switch Settings | 2-4 |
| Figure 3-1. Serial Poll Status Byte | 3-5 |

Tables

| | |
|--|-----|
| Table 1-1. LED Descriptions | 1-3 |
| Table 2-1. Configuration Parameters for Switches 1 through 3 | 2-4 |
| Table 2-2. Configuration Parameters for Switches 4 through 8 | 2-5 |
| Table 3-1. Parallel Poll Responses | 3-7 |
| Table A-1. Electrical Characteristics | A-1 |
| Table A-2. Environmental Characteristics | A-1 |
| Table A-3. Physical Characteristics | A-2 |

About This Manual

Introduction to the GPIB-BUF

The GPIB-BUF is one of National Instruments family of MicroGPIB products. These products are high-performance, low-cost IEEE 488 support items, packaged in small all-metal cases, capable of being rack mounted.

Organization of This Manual

This manual is organized as follows:

- Chapter 1, *Description of the GPIB-BUF*, contains general information about the National Instruments GPIB-BUF and lists components and accessories.
- Chapter 2, *Installation and Operation*, describes the procedures for installing and operating the GPIB-BUF.
- Chapter 3, *Technical Information*, contains a more detailed description of the operation of the GPIB-BUF. The timing characteristics of the parallel port are provided in this chapter.
- Appendix A, *Hardware Specifications*, contains tables which specify the electrical, environmental, and physical characteristics of the GPIB-BUF.
- Appendix B, *Customer Communication*, contains forms you can use to request help from National Instruments or to comment on our products and manuals.
- The *Glossary* contains an alphabetical list and a description of terms used in this manual, including abbreviations, acronyms, metric prefixes, mnemonics, and symbols.

Conventions Used in This Manual

The following conventions are used in this manual.

| | |
|--------------------|---|
| <i>italic</i> | Italic text denotes emphasis, a cross reference, or an introduction to a key concept. |
| bold italic | Bold italic text denotes a note, caution, or warning. |
| bold | Bold text denotes the name of light-emitting diode (LED). |

Abbreviations, acronyms, metric prefixes, mnemonics, symbols, and terms are listed in the *Glossary*.

Related Documentation

The following document contains information that you may find helpful as you read this manual.

- ANSI/IEEE Standard 488.1-1987, *IEEE Standard Digital Interface for Programmable Instrumentation*
- ANSI/IEEE Standard 488.2-1987, *IEEE Standard Codes, Formats, Protocols, and Common Commands*.

Customer Communication

National Instruments wants to receive your comments on our products and manuals. We are interested in the applications you develop with our products, and we want to help if you have problems with them. To make it easy for you to contact us, this manual contains comment and configuration forms for you to complete. These forms are in Appendix B, *Customer Communication*, at the end of this manual.

Chapter 1

Description of the GPIB-BUF

This chapter contains general information about the National Instruments GPIB-BUF and lists components and accessories.

Introduction

The GPIB-BUF, shown in Figure 1-1, is an IEEE 488 (GPIB) data buffer which increases GPIB performance by isolating a slow GPIB data acceptor from the rest of the GPIB system. This increase in performance is reflected both in an increase in the GPIB bandwidth and a quicker release of the GPIB talker from the task of transferring data to a slow GPIB device. In most cases, the GPIB talker is a computer with other tasks to perform. The faster it transfers data, the sooner it can perform its next task.

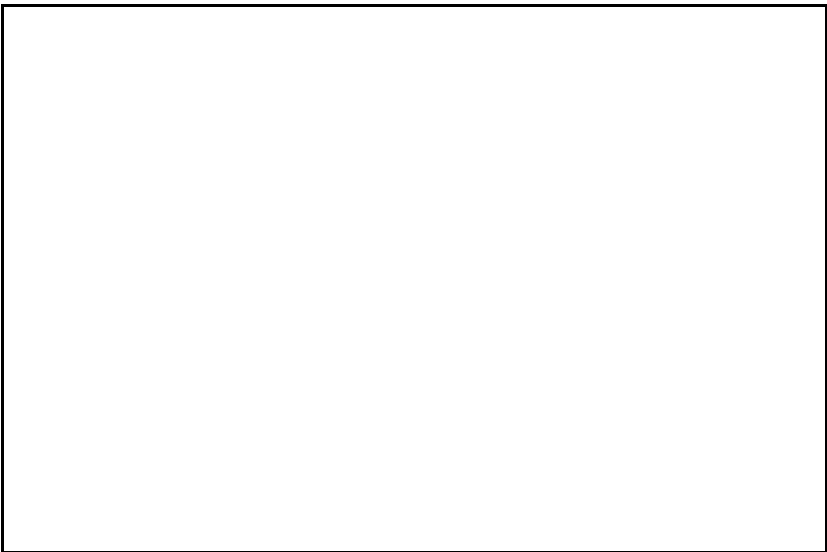

Figure 1-1. The GPIB-BUF

The GPIB-BUF has two isolated GPIB ports and is placed in-line between a GPIB system and a single, slower GPIB device (usually a printer or plotter). The GPIB-BUF automatically buffers all device-dependent data sent to the slower device. Because the GPIB-BUF can talk or listen on either port at any time, the GPIB-BUF provides fully transparent bi-directional data transfers. The target GPIB device appears to be connected directly to the IEEE 488 bus.

What Your Kit Contains

Your kit should contain the following components:

| Component | Part Number |
|-----------------------------------|-------------|
| One of the following boxes: | |
| • GPIB-BUF (256 KB RAM - 115 VAC) | 776226-02 |
| • GPIB-BUF (1 MB RAM - 115 VAC) | 776226-03 |
| • GPIB-BUF (256 KB RAM - 230 VAC) | 776226-32 |
| • GPIB-BUF (1 MB RAM - 230 VAC) | 776226-33 |
| • <i>GPIB-BUF User Manual</i> | 320125-01 |

Optional Equipment

| Component | Part Number |
|------------------------------|-------------|
| Rack Mount Kit: | |
| Single (1 unit) | 180480-01 |
| Dual (2 units) | 180480-02 |
| Double-Shielded GPIB Cables: | |
| GPIB Type X2 Cable – 1 m | 763061-01 |
| GPIB Type X2 Cable – 2 m | 763061-02 |
| GPIB Type X2 Cable – 4 m | 763061-03 |

The GPIB-BUF Front Panel

The power switch and six Light Emitting Diodes (LEDs) are mounted on the GPIB-BUF front panel. Figure 1-2 shows the front panel of the GPIB-BUF.

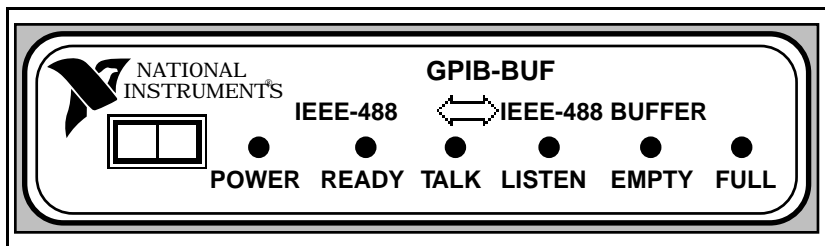

Figure 1-2. The GPIB-BUF Front Panel

The LEDs show the current status of the GPIB-BUF at all times. The following table describes each LED.

Table 1-1. LED Descriptions

| LED | Indication |
|---------------|---|
| POWER | Indicates that power to the unit has been applied and the ON/OFF switch is in the ON position. |
| READY | Indicates that the unit is running its power-on self-test (blinking), has passed its power-on self-test and is ready to operate (steady on), or has failed the power-on self-test (steady off). |
| TALK | Indicates that the GPIB-BUF is configured as a GPIB Talker. |
| LISTEN | Indicates that the GPIB-BUF is configured as a GPIB Listener. |
| EMPTY | Indicates that the internal data buffer of the GPIB-BUF is empty. |
| FULL | Indicates that the internal buffer of the GPIB-BUF is full. |

The GPIB-BUF Rear Panel

Figure 1-3 shows the power cable and the GPIB cables connected to the rear panel of the GPIB-BUF.

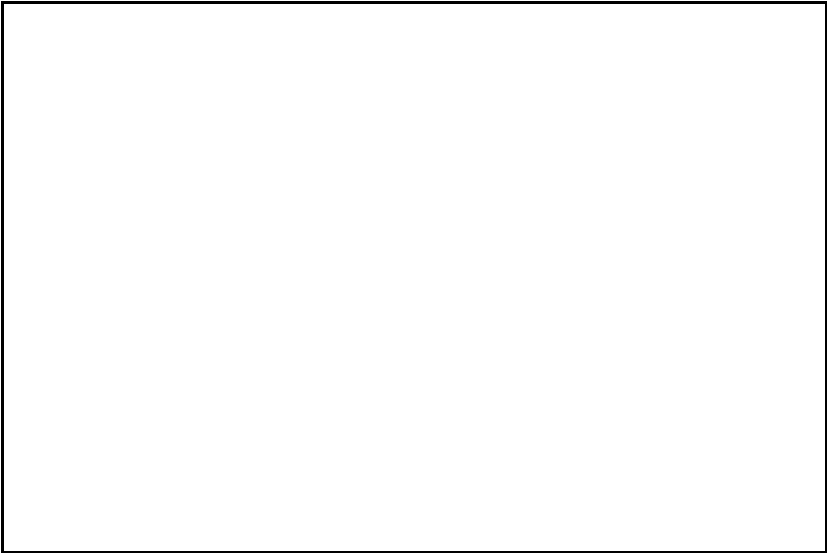

Figure 1-3. The GPIB-BUF Rear Panel

The GPIB Connectors

The GPIB-BUF has two GPIB connectors labeled GPIB IN and GPIB OUT. Both GPIB connectors are standard 24-pin shielded AMP CHAMP female connectors with metric screwlock hardware. As you face the rear panel, the GPIB IN connector is the right-most GPIB connector. The GPIB OUT connector is located on the left.

Notice that although these GPIB ports are labeled GPIB IN and GPIB OUT, both are able to transfer data in either direction. The notations GPIB IN and GPIB OUT are used in order to differentiate the ports since the GPIB IN port, under normal circumstances, receives data while the GPIB OUT port normally sends data to the GPIB target device.

The port labeled GPIB IN is intended to be connected to a GPIB system that includes one or more GPIB devices which send data to the GPIB target device. All data received via the GPIB IN port is transferred into the Random Access Memory (RAM) buffer of the GPIB-BUF using the on-board Direct Memory Access (DMA) controller. The port labeled GPIB OUT should be connected to the GPIB target device. This port has GPIB controller capabilities and addresses the GPIB target device when required. All data input to the internal GPIB-BUF RAM buffer is output via the GPIB OUT port. Under normal operating conditions, you should only connect one device (your GPIB target device) to the GPIB OUT port.

Figure 1-4 shows a diagram of one of the GPIB connectors and the signal designations. Only one GPIB connector is shown since both connectors have the same signal and pin descriptions. A * suffix indicates that the signal is active low.

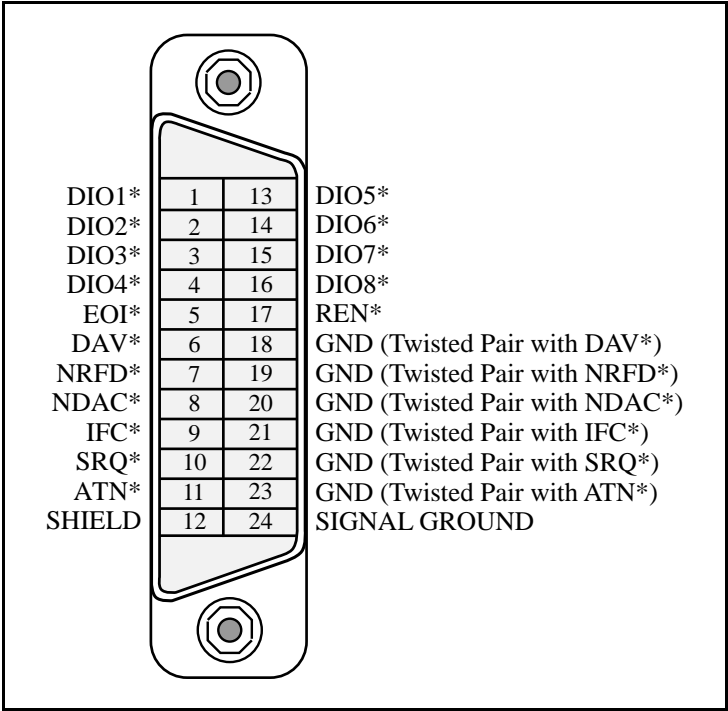

Figure 1-4. The GPIB Connector and Signal Designations

Chapter 2

Installation and Operation

This chapter describes the procedures for installing and operating the GPIB-BUF.

Figure 2-1 shows an example of a GPIB-BUF connected to a GPIB system. This example shows a GPIB-BUF placed in a GPIB system with a GPIB Talker/Controller, such as an IBM-PC with a National Instruments GPIB-PCII Controller board installed, and a slow GPIB data acceptor, such as an HP 7475A Color Plotter. Notice that the GPIB-BUF is placed in-line between the existing GPIB system and the GPIB target device.

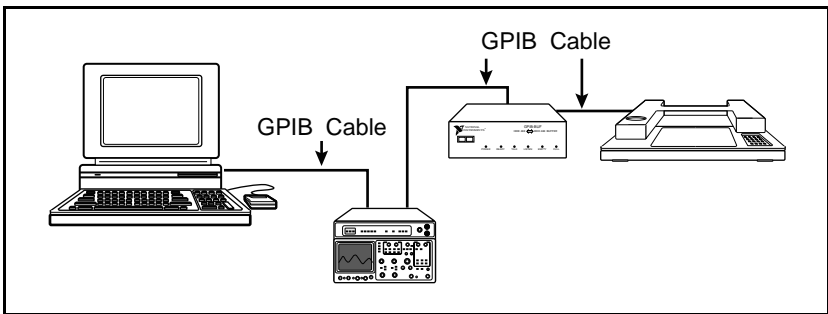

Figure 2-1. GPIB-BUF System Setup Example

Installation

Install the GPIB-BUF according to the following procedure.

1. Inspect the GPIB-BUF.
2. Verify the voltage requirement.
3. Configure the operating parameters.
4. Connect the cables.
5. Power on the unit.

These steps are described in more detail in the following subsections.

Step 1. Inspect the GPIB-BUF

Before you install the GPIB-BUF, inspect the shipping container and its contents for damage. If damage appears to have been caused in shipment, file a claim with the carrier. Retain the packing material for possible inspection and/or reshipment.

If the equipment appears to be damaged, do not attempt to operate it. Contact National Instruments for instructions.

Step 2. Verify the Voltage Requirement

The GPIB-BUF is shipped from the factory with either a 115 V or 230 V wall-mount power supply.

Verify that the voltage on the power supply matches the voltage that is supplied in your area.

Warning: *Operating the unit at any voltage other than the one specified could damage the unit.*

Step 3. Configure the Operating Parameters

The GPIB-BUF is shipped from the factory configured to operate at a GPIB primary address of 5 with the SRQ-on-empty function disabled and device clear recognition and pass through enabled.

The address specified on the configuration switches should match the GPIB address of your target device. If the addresses do not match, you must either change the primary address of your target device or change the primary address of the GPIB-BUF so that they correspond.

To change the primary address of your target device, refer to the user manual of the device.

To change the GPIB-BUF primary address, the SRQ-on-empty function, or the device clear response method, you must open the unit and change the configuration switches. The following steps describe how to change the configuration switches.

1. Disconnect power to the GPIB-BUF and disconnect any cables attached to the rear panel.
2. Remove the two screws on the opposite sides of the rear panel.

Warning: *Most of the circuitry in the GPIB-BUF uses advanced CMOS technology and can be damaged by static electricity. Avoid touching any of the components and take any necessary CMOS handling precautions.*

3. Grasp the rear panel bezel and pull it straight away from the rest of the unit. The board should slide out the back of the enclosure.
4. Locate the configuration DIP switch (U38) on the printed circuit board.
5. Set the switches for the desired configuration, as described in the following section, *Set Configuration Switches*.
6. Close the unit and reinsert the rear panel screws.

Set Configuration Switches

Use the DIP switch at location U38 on the printed circuit board to configure the GPIB primary address and operating modes of the GPIB-BUF. The DIP switch has eight configuration switches. Figure 2-2 shows the factory default setting.

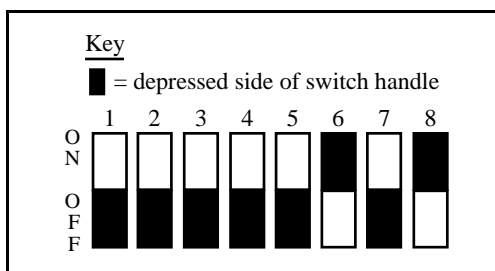

Figure 2-2. Factory Default Switch Settings

Table 2-1 and Table 2-2 detail the possible configurations of the eight switches and what each configuration indicates. For more information on the different operating modes configured by the switches, refer to Chapter 3, *Technical Information*.

Default settings are in shaded rows.

Table 2-1. Configuration Parameters for Switches 1 through 3

| Switch | Position | Indication |
|--------|----------|---|
| 1 | OFF | Enables device clear recognition |
| | ON | Disables device clear recognition |
| 2 | OFF | Sends DCL to the target and resets the GPIB-BUF |
| | ON | Sends DCL to the target |
| 3 | OFF | Disables SRQ on buffer empty |
| | ON | Enables SRQ on buffer empty |

Table 2-2. Configuration Parameters for Switches 4 through 8

| Switches | | | | | Indication |
|-----------------|----------|----------|----------|----------|------------------------------|
| 4 | 5 | 6 | 7 | 8 | |
| OFF | OFF | OFF | OFF | OFF | Sets GPIB primary address 0 |
| OFF | OFF | OFF | OFF | ON | Sets GPIB primary address 1 |
| OFF | OFF | OFF | ON | OFF | Sets GPIB primary address 2 |
| OFF | OFF | OFF | ON | ON | Sets GPIB primary address 3 |
| OFF | OFF | ON | OFF | OFF | Sets GPIB primary address 4 |
| OFF | OFF | ON | OFF | ON | Sets GPIB primary address 5 |
| OFF | OFF | ON | ON | OFF | Sets GPIB primary address 6 |
| OFF | OFF | ON | ON | ON | Sets GPIB primary address 7 |
| OFF | ON | OFF | OFF | OFF | Sets GPIB primary address 8 |
| OFF | ON | OFF | OFF | ON | Sets GPIB primary address 9 |
| OFF | ON | OFF | ON | OFF | Sets GPIB primary address 10 |
| OFF | ON | OFF | ON | ON | Sets GPIB primary address 11 |
| OFF | ON | ON | OFF | OFF | Sets GPIB primary address 12 |
| OFF | ON | ON | OFF | ON | Sets GPIB primary address 13 |
| OFF | ON | ON | ON | OFF | Sets GPIB primary address 14 |
| OFF | ON | ON | ON | ON | Sets GPIB primary address 15 |
| ON | OFF | OFF | OFF | OFF | Sets GPIB primary address 16 |
| ON | OFF | OFF | OFF | ON | Sets GPIB primary address 17 |
| ON | OFF | OFF | ON | OFF | Sets GPIB primary address 18 |
| ON | OFF | OFF | ON | ON | Sets GPIB primary address 19 |

(continues)

Table 2-2. Configuration Parameters for Switches 4 through 8 (Continued)

| Switches | | | | | Indication |
|----------|-----|-----|-----|-----|------------------------------|
| 4 | 5 | 6 | 7 | 8 | |
| ON | OFF | ON | OFF | OFF | Sets GPIB primary address 20 |
| ON | OFF | ON | OFF | ON | Sets GPIB primary address 21 |
| ON | OFF | ON | ON | OFF | Sets GPIB primary address 22 |
| ON | OFF | ON | ON | ON | Sets GPIB primary address 23 |
| ON | ON | OFF | OFF | OFF | Sets GPIB primary address 24 |
| ON | ON | OFF | OFF | ON | Sets GPIB primary address 25 |
| ON | ON | OFF | ON | OFF | Sets GPIB primary address 26 |
| ON | ON | OFF | ON | ON | Sets GPIB primary address 27 |
| ON | ON | ON | OFF | OFF | Sets GPIB primary address 28 |
| ON | ON | ON | OFF | ON | Sets GPIB primary address 29 |
| ON | ON | ON | ON | OFF | Sets GPIB primary address 30 |
| ON | ON | ON | ON | ON | Sets listen-only operation |

Step 4. Connect the Cables

Connect the cables as follows:

1. Connect the power jack of the wall-mount power supply to the power receptacle on the back panel of the GPIB-BUF, then plug the supply into an AC outlet of the correct voltage.
2. Connect a GPIB cable from the target device to the GPIB OUT port on the rear panel of the GPIB-BUF.
3. Connect another GPIB cable from the GPIB IN port on the rear panel of the GPIB-BUF to the remaining GPIB devices in your system.

Note: *In steps 2 and 3, be sure to obey all IEEE 488 cabling restrictions, and tighten all lock screws on the GPIB connectors.*

Step 5. Power on the Unit

Power on your target device then power on your GPIB-BUF by using the front panel rocker switch. The **POWER** LED should light immediately and the **READY** indicator should blink while the unit executes its power-on self-test. The **READY** indicator should stop blinking and remain on when the GPIB-BUF has passed its power-on self-test indicating the unit is ready for operation.

If the **READY** indicator does not start to blink immediately or continues to blink for more than 7 s for the 256 KB model or 20 s for the 1 MB model after the unit is powered on, recheck all connections and switch settings and retry the power-on sequence. If the **READY** light still fails to come on or continues to blink longer than the specified time limits, contact National Instruments for further instructions.

Operation

The GPIB-BUF is now ready to operate. When the GPIB-BUF is powered on, it asserts the Interface Clear (IFC*) line on the GPIB OUT port to initialize the GPIB link to the target device; therefore, ensure that the GPIB target device is powered on before the GPIB-BUF.

When the GPIB-BUF is addressed to listen, all data sent to the unit via the GPIB IN port is input directly to memory by the on-board DMA controller at speeds up to 900 kbytes/s and is stored in the internal data buffer. The actual speed depends on the speed of the GPIB talker as well as the speed of other GPIB devices that are addressed to listen along with the GPIB-BUF. Thus, the speed is no longer limited to the speed of the target device which is now isolated from the rest of the GPIB system. The GPIB-BUF addresses the target device to listen and sends the buffered data to the target device at the maximum rate that the target device can receive the data.

When addressed to talk, the GPIB-BUF waits until it has emptied all the data currently stored in its internal buffer, then addresses the target device to talk. All data sent by the target device is passed directly through the GPIB-BUF to the GPIB listener(s) on the GPIB system.

The addressing of the target device, as well as the routing and buffering of data, is taken care of automatically by the GPIB-BUF. All data operations are completely transparent, and the target device appears to be connected directly to the GPIB bus. You should operate and control your target device in the same manner you would if you did not have a GPIB-BUF.

Chapter 3

Technical Information

This chapter contains a more detailed description of the operation of the GPIB-BUF. The timing characteristics of the parallel port are provided in this chapter.

The GPIB-BUF is actually a powerful 8-bit microcomputer tailored for use as an IEEE 488 data buffer. The operating system of the unit is contained in Read-Only Memory (ROM) and can address up to 1 MB of dynamic Random Access Memory (RAM). The GPIB-BUF microprocessor contains an integrated Direct Memory Access (DMA) Controller for high-speed data transfers from the GPIB circuitry. The processor also contains an integrated memory management unit, a dynamic RAM Controller, a clock generator, a programmable timer unit, a full duplex UART, and an interrupt Controller.

Two LSI GPIB Controller chips which are programmed and maintained by the operating system provide all GPIB functionality. Both controller chips are connected to their respective ports through GPIB transceivers which are responsible for guaranteeing that the electrical characteristics of the IEEE 488 specification are upheld.

Power Up

When powered on, the GPIB-BUF runs internal diagnostics to verify the operation of all internal circuitry. Since the diagnostics can take as long as 20 s, the **READY** LED blinks during the test to indicate that the power-on self-test is progressing successfully. If no errors are found, the GPIB-BUF illuminates the **READY** and **EMPTY** LEDs which indicates that the GPIB-BUF is ready to operate and its internal data buffer is empty. If the GPIB-BUF is in listen-only mode, it also illuminates the **LISTEN** LED at this time.

After the GPIB-BUF has successfully completed its power-on self-test, it asserts the Interface Clear (IFC *) signal on the GPIB OUT port to initialize the link between the GPIB-BUF and the target device, and to establish the ability of the GPIB-BUF to address the target device. The GPIB-BUF then reads the status of the configuration switches and initializes the rest of the system.

If the SRQ-on-empty feature is enabled, the GPIB-BUF asserts the Service Request (SRQ*) signal on the GPIB IN port. The SRQ condition can be used to signal the GPIB Controller that the GPIB-BUF is powered on and ready to accept data.

Addressing

The five GPIB address switches (U38, switches 4 through 8) become the GPIB primary address to which the GPIB IN port responds. These switches are also used to determine the talk and listen addresses used by the GPIB-BUF when addressing the target device attached to the GPIB OUT port. Unless either the GPIB-BUF or the target device is operating in listen-only mode, the target device must be set at the same GPIB address as the GPIB-BUF.

If all the GPIB address switches are set to ON, the GPIB-BUF is configured to operate in listen-only mode. In this mode, no addressing is required to make the GPIB-BUF a GPIB Listener and it cannot be unaddressed to listen. Therefore, all data transferred on the GPIB IN port is accepted by the GPIB-BUF and output to the target device.

When operating in listen-only mode, the GPIB-BUF can neither return any data from the target device nor respond to a serial poll request since it cannot be addressed as a GPIB Talker. As a consequence, the SRQ feature of the GPIB-BUF should not be enabled when operating in listen-only mode.

When operating in listen-only mode, the GPIB-BUF sends all possible listen addresses to the target device (via the GPIB OUT port) after it has finished its power-on self-test. Since all listen addresses are sent out, the target device need not be in listen-only mode. Instead, it can be at any valid GPIB primary address. This mode can also be used to connect more than one target device to the GPIB-BUF which allows multiple, simultaneous copies of a document or drawing to be created.

Data Transfers

Upon being addressed to listen, the GPIB-BUF updates the front panel address indicators by turning on the **LISTEN** indicator and turning off the **TALK** indicator. The GPIB-BUF then begins to accept data from the GPIB IN port using the onboard Direct Memory Access (DMA) Controller. The

DMA Controller transfers the data directly to the internal data buffer without processor intervention. Thus, GPIB transfer rates as high as 900 kbytes/s are possible. The GPIB-BUF turns off the **EMPTY** indicator as soon as it starts receiving data from the host.

The buffered data is then sent to the target device connected to the GPIB OUT port at the maximum acceptance rate of the target device. The GPIB OUT port is interrupt-driven and is asynchronous with respect to any DMA activity that is taking place on the GPIB IN port. Both events take place concurrently and without user intervention.

If very large amounts of data are sent to the GPIB-BUF (greater than the amount of RAM in the system) and the target device is a very slow data acceptor (such as a printer or plotter), the internal data buffer of the GPIB-BUF can become full. If this happens, the **FULL** indicator on the front panel illuminates. This is not an error condition, but an indication that the GPIB transfer rate from the GPIB Talker to the GPIB-BUF has slowed to approximately the same rate as that of the target device accepting the data.

Upon being addressed to talk, the GPIB-BUF updates the front panel address indicators by turning on the **TALK** indicator and turning off the **LISTEN** indicator. The GPIB-BUF waits for all the data in its internal buffer to be accepted by the target, and then addresses the target device to talk. Any data sent from the target device to the GPIB-BUF is not buffered, but is passed directly through the GPIB-BUF to the GPIB IN port. Since no buffer space is required when the GPIB-BUF is addressed to talk, all the RAM in the system can be dedicated to providing the largest possible buffer space for data coming into the GPIB IN port.

EOI

The GPIB End Or Identify (EOI) signal is used by the GPIB Listener(s) to determine when the GPIB Talker has finished sending data. Without it, the GPIB Listener must either know in advance the exact amount of data that the Talker will send or must know of some terminating character sequence that the Talker will adhere to when sending data. EOI signal reception and transmission is fully supported on the GPIB-BUF.

When sending data while addressed as a GPIB Talker, the GPIB-BUF asserts EOI* on the GPIB IN port with any byte received from the target device that has the EOI* signal line asserted.

When receiving data while addressed as a GPIB Listener, the GPIB-BUF buffers the state of the EOI* signal line along with the data byte it corresponds to using an additional on-board RAM module. Therefore, the GPIB-BUF is able to maintain the EOI status with each byte received even when the DMA Controller is transferring data directly to memory. In this way, the GPIB-BUF can accept multiple occurrences of EOI bytes at full speed without loss of performance due to special EOI handling techniques.

IFC

Interface Clear (IFC) is used by a GPIB Controller to place an interface system in a known, quiescent state. The function of the IFC* signal is to halt current operations on the bus by unaddressing all Talkers and Listeners, and disabling serial polls.

The GPIB-BUF asserts IFC* on the GPIB OUT port once at power-up for 500 μ s. The action of asserting IFC* for at least 100 μ s initializes the GPIB link to the target device and establishes the ability of the GPIB-BUF to address the target device. Any other response to IFC* is not defined by the IEEE 488 specification and is specific to the target device.

If the GPIB-BUF detects IFC* asserted on the GPIB IN port, it immediately unaddresses itself (unless it is in listen-only mode) and stops accepting data. IFC* does not clear the GPIB-BUF data buffer or assert IFC* on the GPIB OUT port since either of these operations aborts any current data transfer taking place to the target device. Device CLear (DCL) or Selected Device Clear (SDC) should be used to terminate an ongoing data transfer to the target device.

REN

Remote Enable (REN) is asserted by the system Controller and is used to enable GPIB devices to be placed in the remote programming mode (programmable via the GPIB). The GPIB-BUF always asserts REN* on the GPIB OUT port. REN* need not be asserted on the GPIB IN port for the GPIB-BUF to operate.

Polling the GPIB-BUF

The GPIB-BUF can return status information to the GPIB Controller through the serial poll response byte as shown in Figure 3-1. This byte contains two bits of information that reflect the current condition of the GPIB-BUF data buffer and whether the GPIB-BUF is asserting the SRQ* signal on the GPIB IN port. The serial poll status byte is returned as follows:

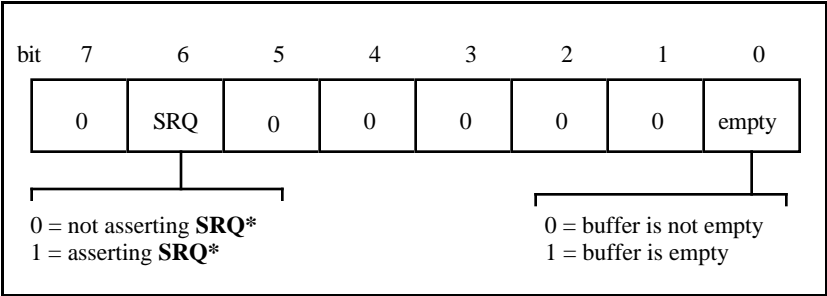

Figure 3-1. Serial Poll Status Byte

The empty bit always reflects the current status of the buffer while the SRQ bit only returns a 1 if the GPIB-BUF is asserting the SRQ* signal line. The GPIB-BUF asserts the SRQ* signal if the buffer is currently empty and the SRQ-on-empty function is enabled by Switch 3 of U38. The GPIB-BUF unasserts the SRQ* signal when the buffer is no longer empty or when the GPIB Controller serial polls the GPIB-BUF. Although serial polls are usually in response to an SRQ condition, the GPIB-BUF can be serial polled at any time for any reason.

Note: *The GPIB-BUF cannot return a serial poll status byte if it is in listen-only mode.*

The GPIB-BUF SRQ-on-empty feature and serial poll status byte are useful for several reasons.

- A remote Controller is able to tell when a data transfer to a plotter or printer is completely finished.
- A ready indicator is provided to a remote GPIB Controller signaling that the GPIB-BUF has been powered on, has successfully completed its self-test, and is ready to accept data.
- A means is provided by which very large files can be transferred without depleting the bandwidth of the GPIB Talker and the GPIB bus.

The following paragraphs explain how this last point can be beneficial:

Suppose that you need to send a file to a plotter via the GPIB-BUF and the file is larger than the available memory in the GPIB-BUF. Since the plotter is a slow data acceptor and you are sending a large file, the GPIB-BUF buffer will most likely become full. If this happens, the GPIB bus as well as the GPIB Talker will bottleneck to the same speed as the plotter.

To avoid this problem, the SRQ-on-empty function can be enabled and the GPIB Talker/Controller can send data amounts up to, but not exceeding the GPIB-BUF buffer size. The Controller can then unaddress the GPIB-BUF and allow other devices to use the GPIB while the GPIB-BUF is spooling the file to the target device. The Controller also is now free to perform other work while the file is being spooled. When the GPIB-BUF has emptied its internal data buffer, it then requests service using SRQ* to indicate that it is ready for additional data. The Controller can then re-address the GPIB-BUF to listen and continue sending the rest of the file in the above manner until all the data has been transferred.

Since the GPIB-BUF is a fully transparent, self-contained unit, the amount of data buffering can also be increased by chaining multiple GPIB-BUF units together.

Another means by which a Controller can determine if a device requires service is by a parallel poll. During a parallel poll, each responding device indicates its need for service by returning a status bit via one of the GPIB data lines. GPIB data line assignments, as well as the level (high or low) of the GPIB line, depend on the last parallel poll configuration command sent to the device.

Internally, the local Individual Status (ist) bit of the GPIB-BUF is reset to 0 when the internal data buffer is empty of data. It is set to 1 when the internal data buffer is not empty.

Therefore, after the GPIB Controller configures the GPIB-BUF with a Parallel Poll Enable (PPE) message from 60 to 67 hex, the GPIB-BUF, during a parallel poll, drives the data line (which the Controller has specified) active when the internal data buffer is empty. When data is present in the GPIB-BUF, it drives the data line inactive. Likewise, after the GPIB Controller configures the GPIB-BUF with a PPE message from 68 to 6F hex, the GPIB-BUF, during a parallel poll, drives the data line (which the Controller has specified) active when the internal data buffer is not empty of data. When the internal data buffer is empty, it drives the data line inactive. The possible parallel poll responses from the GPIB-BUF are summarized in Table 3-1.

Unlike serial polls, you can parallel poll the GPIB-BUF even when it is in listen-only mode.

Table 3-1. Parallel Poll Responses

| PPE (hex) | GPIB Data Line Driven Active in Response to Parallel Poll | |
|--------------|--|------------------|
| | Buffer Empty | Buffer Not Empty |
| 60 | DIO1 | NONE |
| 61 | DIO2 | NONE |
| 62 | DIO3 | NONE |
| 63 | DIO4 | NONE |
| 64 | DIO5 | NONE |
| 65 | DIO6 | NONE |
| 66 | DIO7 | NONE |
| 67 | DIO8 | NONE |
| 68 | NONE | DIO1 |
| 69 | NONE | DIO2 |
| 6a | NONE | DIO3 |
| 6b | NONE | DIO4 |
| 6c | NONE | DIO5 |
| 6d | NONE | DIO6 |
| 6e | NONE | DIO7 |
| 6f | NONE | DIO8 |

Special Note About Timeouts

If your current GPIB system relies on a timeout method to ensure a non-functioning GPIB device does not hang the bus indefinitely, then it may be necessary to adjust or disable the time limit to ensure that the target device has enough time to respond to any requests for information.

For example, suppose that your current code sends a file to a plotter and then prompts the plotter for its current status. If the file is large and GPIB timeouts are in effect, the file is transferred to the GPIB-BUF followed immediately by the plotter prompt. At this time, the Controller re-addresses the GPIB-BUF to talk, starts its timeout timer, and waits for a response. Since the GPIB-BUF is still spooling the data file to the plotter, which has not yet received the prompt, the plotter cannot respond until the entire plot is finished and the prompt is received. If the time required to finish the plot and respond to the prompt are longer than the time limit of the Controller, a timeout error will occur. This can be easily corrected by either increasing or disabling time limits on GPIB operations of this type to very slow data acceptors.

A more efficient way to handle responses after large file transfers is to wait until the GPIB-BUF is empty before issuing the plotter request for information. In this way, timeouts can remain in effect, and the GPIB Talker can perform other useful work because it will not hang while waiting for a plotter response. If SRQs are enabled, then the Controller need not continually poll the GPIB-BUF, but can instead wait for an SRQ before issuing the plotter request.

Multiline Command Group

When the GPIB-BUF receives either a GPIB Multiline Message SDC or DCL via the GPIB IN port, it responds in one of several ways. The response depends on the condition of switch 1 and 2 of the configuration switch at location U38 on the printed circuit board.

If switch 1 is on, the GPIB-BUF ignores any SDC and DCL received and takes no action. If switch 1 is off (default), the GPIB-BUF response depends on the condition of switch 2.

If switch 2 is on, the GPIB-BUF immediately passes a DCL to the GPIB target device when a DCL or SDC is received. If switch 2 is off (default), the GPIB-BUF not only passes a DCL to the target device but also clears its

internal data buffer. This mode can be used to prematurely abort a lengthy plot or print.

Neither Group Execute Trigger (GET), Go To Local (GTL), nor Local Lockout (LLO) have any effect on the GPIB-BUF.

The GPIB IN port on the GPIB-BUF can only act as a GPIB Talker or Listener. It should not be passed control. If it is, the GPIB circuitry in the GPIB-BUF will accept control and immediately assert ATN*. This is an error condition that can lock up your system and, therefore, should be avoided.

Appendix A

Hardware Specifications

This appendix lists the electrical, environmental, and physical specifications of the

Table A-1. Electrical Characteristics

| Characteristic | Specification |
|-----------------------|--|
| Power Supply Unit | Wall mount type, 115 VAC or 230 VAC, 50/60 Hz input, 9 VDC @ 1A max output |
| Voltage | 9 VDC regulated |
| Current | 700 mA typical; 1.0 A max |

Table A-2. Environmental Characteristics

| Characteristic | Specification |
|-----------------------|-------------------------------------|
| Operating Temperature | 0° to 40° C |
| Storage Temperature | -20° to 70° C |
| Relative Humidity | 10% to 90% noncondensing conditions |
| Noise Emissions | FCC Class A Verified |

Table A-3. Physical Characteristics

| Characteristic | Specification |
|-----------------------|--|
| Case Size | 1.6 in. by 5.7 in. by 8.4 in. (40.6 mm by 144.8 mm by 213.4 mm) |
| Case Material | All metal enclosure |
| Rack Mounting | Single or dual kits available |
| Weight | 28 oz. (796 gm) without power supply unit |

Appendix B

Customer Communication

For your convenience, this appendix contains forms to help you gather the information necessary to help us solve technical problems you might have as well as a form you can use to comment on the product documentation. Filling out a copy of the *Technical Support Form* before contacting National Instruments helps us help you better and faster.

National Instruments provides comprehensive technical assistance around the world. In the U.S. and Canada, applications engineers are available Monday through Friday from 8:00 a.m. to 6:00 p.m. (central time). In other countries, contact the nearest branch office. You may fax questions to us at any time.

Corporate Headquarters

(512) 795-8248

Technical support fax: (800) 328-2203
(512) 794-5678

| Branch Offices | Phone Number | Fax Number |
|-----------------------|---------------------|-------------------|
| Australia | (03) 879 9422 | (03) 879 9179 |
| Austria | (0662) 435986 | (0662) 437010-19 |
| Belgium | 02/757.00.20 | 02/757.03.11 |
| Denmark | 45 76 26 00 | 45 76 71 11 |
| Finland | (90) 527 2321 | (90) 502 2930 |
| France | (1) 48 14 24 00 | (1) 48 14 24 14 |
| Germany | 089/741 31 30 | 089/714 60 35 |
| Italy | 02/48301892 | 02/48301915 |
| Japan | (03) 3788-1921 | (03) 3788-1923 |
| Netherlands | 03480-33466 | 03480-30673 |
| Norway | 32-848400 | 32-848600 |
| Spain | (91) 640 0085 | (91) 640 0533 |
| Sweden | 08-730 49 70 | 08-730 43 70 |
| Switzerland | 056/20 51 51 | 056/20 51 55 |
| U.K. | 0635 523545 | 0635 523154 |

Technical Support Form

Technical support is available at any time by fax. Include the information from your configuration form. Use additional pages if necessary.

Name _____

Company _____

Address _____

Fax (____) _____ Phone (____) _____

Computer brand _____

Model _____ Processor _____

Operating system _____

Speed _____MHz RAM _____MB

Display adapter _____

Mouse _____yes _____no

Other adapters installed _____

Hard disk capacity _____MB Brand _____

Instruments used _____

National Instruments hardware product model _____

Revision _____

Configuration _____

National Instruments software product _____

Version _____

Configuration _____

(continues)

The problem is _____

List any error messages _____

The following steps will reproduce the problem _____

Hardware Configuration Form

Record the settings and revisions of your hardware on the line to the right of each item. Update this form each time you revise your hardware configuration, and use this form as a reference for your current configuration.

National Instruments Products

- GPIB-BUF Revision _____
- Switch Settings:

Other Products

- Computer Make and Model _____
- Microprocessor _____
- Clock Frequency _____
- Type of Monitor Card Installed _____
- Application Programming Language (BASIC, C, Pascal, and so on)

Documentation Comment Form

National Instruments encourages you to comment on the documentation supplied with our products. This information helps us provide quality products to meet your needs.

Title: **GPIB-BUF User Manual**

Edition Date: **February 1994**

Part Number: **320125-01**

Please comment on the completeness, clarity, and organization of the manual.

(continues)

If you find errors in the manual, please record the page numbers and describe the errors.

Thank you for your help.

Name _____

Title _____

Company _____

Address _____

Phone (_____) _____

Mail to: Technical Publications
 National Instruments Corporation
 6504 Bridge Point Parkway, MS 53-02
 Austin, TX 78730-5039

Fax to: Technical Publications
 National Instruments Corporation
 MS 53-02
 (512) 794-5678

Glossary

| Prefix | Meaning | Value |
|--------|---------|-----------|
| μ- | micro | 10^{-6} |
| m- | milli- | 10^{-3} |
| k- | kilo- | 10^3 |
| M- | mega- | 10^6 |

| | |
|------|--|
| ° | degrees |
| % | percent |
| A | amperes |
| AC | alternating current |
| ANSI | American National Standards Institute |
| C | Celsius |
| EMI | electromagnetic interference |
| FCC | Federal Communications Commission |
| GPIB | General Purpose Interface Bus |
| Hz | hertz |
| IEEE | Institute of Electrical and Electronic Engineers |
| in. | inches |
| KB | kilobytes of memory |
| LED | light-emitting diode |
| m | meters |
| MB | megabytes of memory |
| oz | ounce |
| RAM | random-access memory |
| s | seconds |
| VAC | volts alternating current |
| VDC | volts direct current |

Free Manuals Download Website

<http://myh66.com>

<http://usermanuals.us>

<http://www.somanuals.com>

<http://www.4manuals.cc>

<http://www.manual-lib.com>

<http://www.404manual.com>

<http://www.luxmanual.com>

<http://aubethermostatmanual.com>

Golf course search by state

<http://golfingnear.com>

Email search by domain

<http://emailbydomain.com>

Auto manuals search

<http://auto.somanuals.com>

TV manuals search

<http://tv.somanuals.com>