

USER MANUAL



iCN 700 series with SmartST™ 2006

iCN 700 series

User Manual

English - Europe / New Zealand

© 2006 Brunswick New Technologies Asia Pte Limited. Navman is a registered trademark of Brunswick New Technologies Asia Pte Limited and is used under licence by Navman New Zealand. Navman is part of the Brunswick Group, headquarters Chicago, IL. All rights reserved.

The software contains proprietary information of Navman; it is provided under a licence agreement containing restrictions on use and disclosure and is also protected by copyright law. Reverse engineering of the software is prohibited.

No part of this publication may be reproduced, stored in a retrieval system, or transmitted in any form or by any means, electronic, mechanical, photocopying, recording or otherwise, without the prior written permission of Navman.

Back-On-Track, Drive-Away, **NavPix**, SmartST and Turn-by-Turn are either registered trademarks or trademarks of Brunswick New Technologies Asia Pte Limited and are used under licence by Navman New Zealand. All rights reserved.

Microsoft Windows 2000 and XP SP1, Microsoft Internet Explorer and ActiveSync are either registered trademarks or trademarks of Microsoft Corporation in the United States and/or other countries. All rights reserved.

Adobe and Adobe Reader are either registered trademarks or trademarks of Adobe Systems Incorporated in the United States and/or other countries. All rights reserved.

Location Identifiers © 2005 International Air Transport Association.

All other trademarks and registrations are the property of their respective owners.

Published in New Zealand.

Disclaimer

Due to continued product development this information may change without notice. Navman does not warrant that this document is error-free.

The screenshots and other presentations shown in this User Manual may differ from the actual screens and presentations generated by the actual product. All such differences are minor and the actual product will deliver the described functionality as presented in this User Manual in all material respects.



Compliance

This device complies with part 15 of the FCC Rules. Operation is subject to the following two conditions: (1) This device may not cause harmful interference, and (2) this device must accept any interference received, including interference that may cause undesired operation.

The software is based in part on the work of the Independent JPEG Group.

Important safety information

PLEASE READ CAREFULLY BEFORE INSTALLING PRODUCT IN VEHICLE

	<p>This is the safety alert symbol. It is used to alert you to potential personal injury hazards. Obey all safety messages that follow this symbol to avoid possible injury or death.</p>
	<p>WARNING indicates a potentially hazardous situation which, if not avoided, could result in death or serious injury.</p>
	<p>CAUTION indicates a potentially hazardous situation which, if not avoided, may result in minor or moderate injury.</p>
<p>CAUTION</p>	<p>CAUTION used without the safety alert symbol indicates a potentially hazardous situation which, if not avoided, may result in property damage.</p>



Removing original equipment, adding accessories or modifying your vehicle could affect the vehicle's safety or make it illegal to operate in some jurisdictions.

Follow all product instructions and all instructions in your vehicle owner's manual regarding accessories or modifications.

Consult your country's and/or state's laws regarding operation of a vehicle with any accessories or modifications.



It is your sole responsibility to place, secure and use the iCN in a manner that will not cause accidents, personal injury or property damage. Always observe safe driving practices.

Mount the iCN in a position that is secure and does not obstruct the driver's view.

Do not mount the iCN in a way that may interfere with the safe operation of the vehicle, the deployment of air bags or other safety equipment.

Do not operate the iCN while driving.

Before you use your iCN for the first time, familiarize yourself with your device and its operation.

On main roads, the distance to an exit calculated by the iCN may be further than the distance shown on road signs. Road signs show the distance to the start of an exit while your iCN shows the distance to the next intersection, i.e., the end of the exit ramp or road. To prepare to exit a road, always follow distance information on road signs.



Do not handle the iCN while it is hot. Let the product cool, out of direct sunlight.

CAUTION

Do not expose the iCN to direct sunlight in an unattended vehicle for prolonged periods. Overheating may damage the unit.

To discourage theft, do not leave the iCN, mounting bracket or any cables in plain view in an unattended vehicle.

Failure to adhere to these warnings and cautions may lead to death, serious injury or property damage. Navman disclaims all liability for installation or use of the iCN that causes or contributes to death, injury or property damage or that violates any law.

Contents

Important safety information.....	5
Welcome.....	9
Box contents.....	10
Typographical conventions.....	11
Getting to know your iCN.....	12
Front components.....	12
Side components.....	13
Top components.....	14
Bottom components.....	14
Back components.....	15
Volume.....	15
Internal battery.....	16
How do I get started?.....	17
How do I turn my iCN off?.....	19
What are the main screens that I will use?.....	20
How do I navigate with GPS?.....	22
How do I go from A to B?.....	23
How do I search for an address?.....	24
Case Study: How do I search for an address?.....	24
Using the <i>Keyboard</i> screen.....	27
Using the <i>Destination Search</i> screen.....	27
How do I create a trip with multiple stops?.....	30
Case Study: How do I navigate to multiple addresses?.....	31
How do I skip a waypoint during a multi-stop trip?.....	35
How do I search for a landmark or venue?.....	36
How do I find the nearest petrol station?.....	36
How do I find the nearest parking area?.....	37
How do I search for other POIs?.....	38
Case Study: How do I search for a Point of Interest?.....	38
How do I view my route?.....	41
3D Map screen.....	42
2D Map screen.....	44
Next Turn screen.....	46
Direction List screen.....	47
What if I miss a turn?.....	48
How do I save Favourites and My Home?.....	49
How do I save a Favourite?.....	49
How do I navigate to a Favourite?.....	50
How do I navigate to My Home?.....	51
How do I view details of a Favourite?.....	52
How do I edit the name of a Favourite?.....	53
How do I delete a Favourite?.....	54
How do I use the camera?.....	55
How do I view the Camera screen?.....	56
How do I take a photo?.....	57
How do I customize camera preferences?.....	58
How do I manage my photos?.....	59
Album management.....	59
Photo management.....	61

How do I save, e-mail or print photos?	63
Via Memory Card.....	63
Via USB cable	63
How do I navigate to a photo location?	65
How do I assign a photo to a Favourite?	66
What else can I do?	67
How do I navigate to a recent location?	68
How do I use the Map Menu?	69
How do I avoid an area?	71
How do I preview a route?	72
How do I view my route statistics?	74
How do I view statistics on my current route?	74
How do I view statistics of my trips to date?.....	75
What is SmartST Desktop?	76
Can I use SmartST Desktop with my computer?	77
What is Microsoft ActiveSync®?	77
How do I install a map for the first time?	77
How do I install SmartST Desktop on my computer?	78
SmartST Desktop features.....	79
Toolbars	81
How do I keep SmartST up-to-date?.....	82
How do I install maps on my iCN?	83
How do I install maps from CD?	83
How do I know which map contains a particular city or town?.....	86
What is a Major Road Network map?	87
How do I install Custom Points of Interest?	88
How do I create a Custom POI file?.....	89
How do I copy a Custom POI file to my iCN?.....	90
How do I backup my iCN?.....	93
Reference	94
What can I customize?.....	95
Route Preferences	96
Tutorial	99
System Preferences	99
Display Preferences	103
POI Preferences	107
Which maps are already installed on my iCN?.....	110
How do I use a memory card with my iCN?	111
How do I insert a Memory Card?	112
How do I remove a Memory Card?	112
Address search rules	113
Street types - Europe	114
Points of Interest categories.....	118
Specifications.....	120
Support information.....	121
Notes	122















Welcome

Thank you for purchasing this Navman iCN. This user manual has been prepared to guide you through the operation of your Navman iCN from first set-up through to continuous use, and will help you Drive-Away™ with your iCN, straight out of the box. Please read this manual carefully before using your iCN for the first time. Keep this manual available for future reference.

In this section

Box contents.....	10
Typographical conventions	11
Getting to know your iCN.....	12

Box contents

Item		Item	
iCN with GPS receiver		Mounting bracket	
AC Power pack with power cable and plugs  The number of plugs included depends on the country of purchase.		12V In-vehicle power adaptor with power cable	
USB cable		CDs include: <ul style="list-style-type: none"> SmartST 2005 software, including SmartST Desktop Map data User Manual (PDF) and Adobe® Reader®  The number of discs included depends on the country of purchase.	
User Manual		In-Car Installation Guide	
GPS Frequently Asked Questions guide		Global Support Information	
Software Product Licence and Limited Warranty Agreement		Registration card	

Typographical conventions

It is important to understand the terms and typographical conventions used in this manual.





Formatting

The following kinds of formatting in the text identify special information:

Convention	Type of Information
Bold	iCN components or items displayed on screen, including buttons, headings, field names and options.
<i>Italics</i>	Indicates the name of a screen.

Icons

The following icons are used throughout this manual:

Icon	Description
	Note
	Important note
	Tip
	Case study
	Warning

Terms

The following terms are used throughout this manual to describe user actions.





Term	Description
Press	Press and release a button quickly.
Select	Tap an item in a list or tap a command from a menu.
Tap	Press and release an item displayed on the touch screen.
Tap and hold	Press and hold an item displayed on the touch screen for 2-3 seconds.

Getting to know your iCN

We recommend that you familiarize yourself with the iCN's basic operations.





Front components



	Component	Description
1	Battery indicator	Indicates the level of internal battery charge: <ul style="list-style-type: none"> Green - battery full Red - battery low Orange - battery charging For more information, see "Internal battery" on page 16.
2	Touch screen	Displays maps and menu options. Tap to select menu options or enter information.
3		Displays a list of the nearest petrol stations based upon your current location.
4		Displays a list of the nearest parking areas based upon your current location.
5		Displays the <i>Main Menu</i> screen. For more information, see "What are the main screens that I will use?" on page 20.
6		Displays the <i>Go To</i> menu screen. For more information, see "What are the main screens that I will use?" on page 20.
7		Cycles through the <i>3D Map</i> , <i>2D Map</i> , <i>Next Turn</i> and <i>Turn List</i> screens. For more information, see "What are the main screens that I will use?" on page 20.



Side components

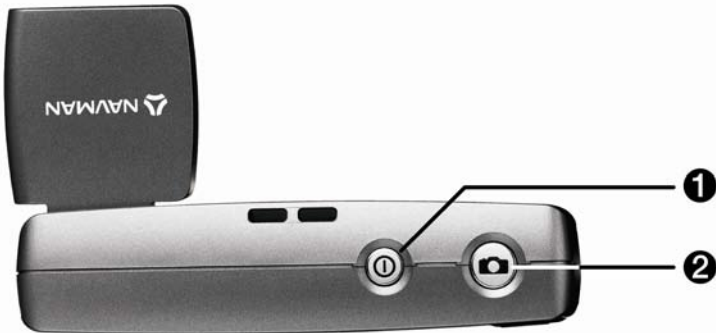

	Component	Description
1	External antenna socket	Connection socket for GPS MCX External Antenna (not included).
2		Connection socket for headphones or earphones (not included).
3		Slot for memory card. The memory card must be inserted with the label facing the front of the iCN. For more information on inserting the memory card, see "How do I use a memory card with my iCN?" on page 111.
4		Connection socket for AC power-pack or in-vehicle power adaptor.
5		Connection socket for USB cable to your computer.
6	Volume control	Rotate up or down to hear a sound test and adjust the volume. Press to mute the volume.

Top components



	Component	Description
1		Turns the iCN on or off; when off, the iCN enters a suspended state.
2		Turns the camera on. Press to take a photo.

Bottom components



	Component	Description
1	RESET	Resets the iCN. For more information, see "How do I turn my iCN off?" on page 19.
2	BATTERY	Must be set to ON for normal use. Switching to OFF turns the battery off, which saves battery power.
3	Hot shoe plate	Connection plate for the P1 or T1 module.

Back components



	Component	Description
1	Camera	The camera lens.
2	Speaker	Broadcasts voice commands and warnings. Use the Volume control to adjust.
3	GPS receiver	Receives signals from GPS satellites when lifted out to the horizontal position.

Volume

The volume on your iCN can be adjusted either by the volume control on the iCN or by using the three volume control buttons on the remote control (may be sold separately). These are described below:

Volume Control on iCN

To hear a sound test and adjust the volume, rotate the **Volume** control up or down. The volume bar displays as **green**.

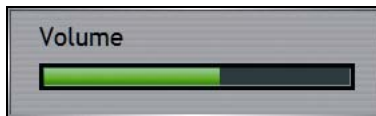

To mute the volume, press the **Volume** control. The volume bar displays as **grey**, and indicates that the volume is muted. To make the volume active, rotate the **Volume** control up or down. The volume bar displays as **green**.

Internal battery

The iCN has an internal battery that, when fully charged, should power the iCN for up to 2.5 hours.

The battery indicator light on the front of the iCN indicates the level of internal battery charge:

- **Green** - battery full
- **Red** - battery low
- **Orange** - battery charging

How do I monitor the battery status?

You can monitor battery power status at the *Power* screen. For more information, see "Power" on page 101.

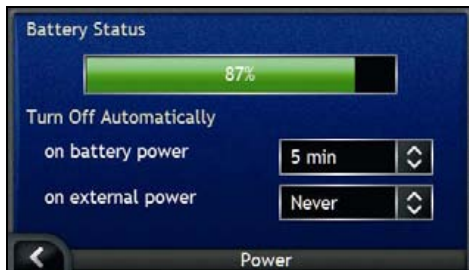

How do I charge the internal battery?

The **Battery Status** bar displays **Charging** while the battery is under charge; when the battery is fully charged, the **Battery Status** bar will display at 100%.

- To charge the iCN in a vehicle, plug the vehicle power adaptor into *** on the side of the iCN and the other end into the vehicle power socket.
- To charge the iCN using an electrical wall outlet, plug the AC power cable into *** on the side of the iCN and the AC power pack into the wall outlet.

How do I get started?

Before you begin, check if your vehicle is fitted with a heat-reflective or heated windscreen. If so, you will need to purchase an external antenna for your iCN to receive GPS signals. For more information, see the *GPS Frequently Asked Questions* guide.

To get started for the first time, complete the following steps:

Step	Action
1	Turn your iCN on.
2	Select your preferred language.
3	Accept the warning message.
4	View the Tutorial.

1. Turn the iCN on

- a) Position the iCN in your vehicle according to the instructions in the *In-Car Installation Guide*. Please ensure that:
- the iCN does not obstruct the driver's view, or interfere with the operation of the vehicle airbags and safety devices.
 - the **GPS receiver** is facing the sky directly above it, to allow it to obtain a GPS fix through the windscreen.
 - the **BATTERY** switch is **ON**.



The **BATTERY** switch is **GREEN** when ON and **RED** when OFF.

- b) Press  to turn your iCN on. The iCN will turn on and display the *Language* screen.



If your iCN was last turned **OFF** via the **BATTERY** switch, it will automatically turn on when the **BATTERY** switch is switched **ON**.



If you have maps installed from multiple continents, you may be prompted to select the maps you would like to load before the *Language* screen is displayed.

To use maps from a different continent at a later time, you must first reset your iCN, then select a different continent.

2. Select your preferred language

From the *Language* screen, tap your preferred language.





- To prevent the *Language* screen from displaying on each startup, tap the **Show on startup** check box.
- You can change your preferred language while using your iCN. For more information, see "Language" on page 101.

3. Accept the warning message

- a) The *Warning* screen will display when you have selected your preferred language. Read the *Warning* message.
- b) To confirm that you have read and understood the message, tap **Accept**. The *Tutorial* will display.

4. View the Tutorial

When you have accepted the *Warning* message, the *Tutorial* will display. Read the *Tutorial*:

- To prevent the *Tutorial* from displaying again on startup, tap the **Show on start-up** check box to clear it.
- To move forward through the *Tutorial* screens, tap . To revisit the previous screen, tap .
- You can view the *Tutorial* again while using your iCN. For more information, see "Tutorial" on page 99.

When you have finished the *Tutorial*, the *3D Map* screen will display. If you have a GPS fix, your current location will be displayed on the map. For information on GPS, see "How do I navigate with GPS?" on page 22.

How do I turn my iCN off?

To turn your iCN off, press .

Your iCN will enter a suspended state and the screen will turn off. When you turn your iCN on again, it will return to the screen you were last viewing.

Power-saving suspended state

To save power, your iCN will automatically enter a suspended state after a pre-determined period of time. You can change the default suspended state setting at the *Power* preference screen. For more information, see "Power" on page 101.

If battery power is very low, your iCN will enter a suspended state whether you have set a pre-determined period of time or not.



If you are not going to be using your iCN for an extended period of time, switch the **BATTERY** switch to **OFF** to save battery power.

How do I reset my iCN?

Normally you do not need to reset your iCN; however, should your iCN not turn on or not respond, you can reset it to solve the problem.

To reset your iCN, press the white **RESET** button on the bottom of your iCN. Your iCN will restart.

What are the main screens that I will use?

Map screens

There are four map screens used to view the route to your destination:

- 3D Map
- 2D Map
- Next Turn
- Direction List

To display the *3D Map* screen, or the map screen that you were last viewing, press ; press again to cycle through the map screens.



- For more information on the map screens, see "How do I view my route?" on page 41.
- For information on using the *Map* menu from the *3D Map* and *2D Map* screens, see "How do I use the Map Menu?" on page 69.

Main Menu screen

The *Main Menu* screen provides access to all of the iCN's navigation functions.

To access the *Main Menu* at any time, press ; to select a *Main Menu* option, tap the required icon.



Go To Menu screen

The *Go To Menu* screen is your starting point for specifying a destination. From the *Go To Menu* screen you can navigate to My Home, an address, Point of Interest, Favourite, recent location or set a multi-stop trip.

To access the *Go To Menu* at any time, press , or tap  from the *Main Menu* screen; to select a *Go To Menu* option, tap the required icon.





- For information or setting your destination, see "How do I go from A to B?" on page 23.

How do I navigate with GPS?

The Global Positioning System (GPS) is available at any time, free of charge, and is accurate to within 5m (15ft). GPS navigation is made possible by a network of satellites that orbit the Earth at around 20,200km. Each satellite transmits a range of signals which are utilized by GPS receivers, such as your iCN, to determine an exact location. Although a GPS receiver can detect signals from up to 12 satellites at any time, only four signals are required to provide a position or "GPS fix" (latitude and longitude), for vehicle navigation systems.

Your iCN receives GPS signals via the GPS antenna. To guarantee the optimum GPS signal strength, ensure your iCN is outdoors, or in a vehicle outdoors and the GPS antenna has an unobstructed view of the sky. Your iCN can operate in all weather types except snowfall.

You can view your GPS status at any time from the map screens or the camera screens. The GPS icon  displays green when a GPS fix is established and red when a GPS fix is unavailable. To indicate the reception strength of a GPS fix,  displays between one and four green quadrants.

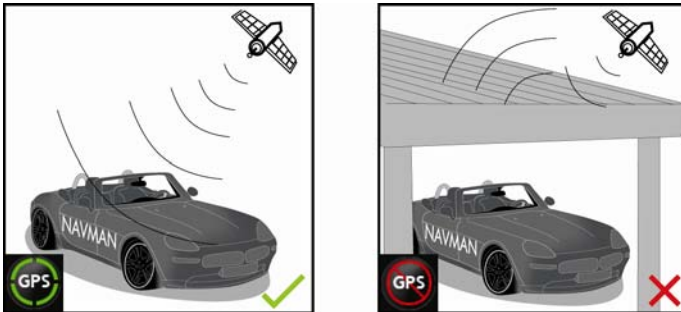

- To see your GPS status in more detail, see "GPS Status" on page 100.
- For more GPS information, see the *GPS Navigation - Frequently Asked Questions* guide.

How do I go from A to B?

Your iCN is equipped with maps that provide street-level detail for door-to-door navigation, including Points of Interest (POIs) such as accommodation, parking areas, petrol stations, railway stations and airports.

When you ...	Then ...
know the address of your destination	use the address-entry wizard to enter the address, see "How do I search for an address?" on page 24.
have multiple stops	use the <i>Multi-stop Trip Planner</i> screen to enter multiple waypoints, see "How do I create a trip with multiple stops?" on page 30.
need to find a named site, feature, landmark or public venue	search for a Point of Interest, see "How do I search for a landmark or venue?" on page 36.
need to find a petrol station	select from a list of the nearest petrol stations, see "How do I find the nearest petrol station?" on page 37.
need to find a parking area	select from a list of the nearest parking areas to your current location, see "How do I find the nearest parking area?" on page 37.



WARNING For your safety, enter destination information before you start a journey. Do not enter a destination while driving.

In this section

How do I search for an address?	24
How do I create a trip with multiple stops?	30
How do I search for a landmark or venue?	36

How do I search for an address?

Select a destination using the *Destination Search*, *Keyboard* and *Destination Preview* screens, which used together form an address-entry wizard.

This section describes how to use each of these screens and provides a case study to help guide you through setting your destination.

Quick Steps

1. Open the *Destination Search* screen
2. Select the country
3. Search for the city/area
4. Search for the street
5. Search for the house number
6. Tap **Go**.



Case Study: How do I search for an address?

This case study will show you how to set your destination by selecting your country, then area, then street, then house number.

1. Open the *Destination Search* screen



The *Destination Search* screen will display.



If this is the first time you are setting your destination and you have maps from more than one country installed and selected, then the *Select Country* screen will display instead of the *Destination Search* screen. Go directly to step 2b.

The next time you perform this procedure, the *Destination Search* screen will open as expected.

2. Select the country

If you only have the map of one country installed and selected, that country is selected for your destination by default and cannot be changed. Go to step 3.

- a) From the *Destination Search* screen, tap **Change Country**.
The *Select Country* screen will display.



Select a country from the list.
The *Destination Search* screen will display.

3. Search for the City/Area

- a) From the *Destination Search* screen, tap **City/Area**.
The *Keyboard* screen will display.



- b) Use the *Keyboard* screen to search for the city or area of your destination.
The *Destination Search* screen will display.



4. Search for the street

- a) From the *Destination Search* screen, tap **Street**.
The *Keyboard* screen will display.



There may be multiple matches for a particular street name. Long streets that run through several neighbouring areas, and common street names; for example, *Main Street*, will produce matches that are distinguished by their associated city or area name.

- b) Use the *Keyboard* screen to search for the street of your destination. Where there are multiple matches, select the city or area that best describes your destination.
The *Destination Search* screen will display.



If house numbers and intersection information are not available for your selected street, the *Destination Preview* screen will display. Go to step 5c.

Using the *Keyboard* screen

The *Keyboard* screen will display when you are required to enter text, such as when searching for a street name. As you tap each character, the first two matching results will display. Tap  to see more search results. Search results will be listed in matching order, with the closest matches appearing at the top of the list. A maximum of 99 results will display.

The *Keyboard* screen can display in three modes: *alphabet*, *alternate* and *number/symbol*.



As you select each character, the first two results will display. Tap  to see more search results.

- To select a character or a search result, tap the character or search result.
- To delete a character, tap .
- To display the number/symbol *Keyboard* screen, tap **123**.
- To display the alternate *Keyboard* screen, tap **alt**.
- To display the alphabet *Keyboard* screen, tap **abc**.

Using the *Destination Search* screen

As you specify each part of the address, it will display at the top of the screen.

The available options will change to reflect the parts of the address still to be completed.



5. Search for the house number

- a) From the *Destination Search* screen, tap **House Number**. The *Keyboard* screen will display.



If house numbers are available, but not the one that you require, you may have to choose the same street in a neighbouring area. Go to step 4.

If the **House Number** option is not displayed at all, house numbers are not available for your selected section of the street. Tap **Go to Centre of Street** to display the *Destination Preview* screen. Go to step c.

- b) Use the *Keyboard* screen to search for the house number of your destination. The *Destination Preview* screen will display.



- c) Complete one of the following:



Please ensure that the route preferences are applicable for the route that you have specified, *before* you tap **Go**.

If you want to ...	Then ...
calculate the route and open the <i>3D Map</i> screen	tap Go . Your route is calculated; the <i>3D Map</i> screen will display.
select a more precise location by pointing	tap the map to switch to the main map view.
display the geographical details	tap Details . The <i>Destination Details</i> screen will display.
save the destination as My Home	<ul style="list-style-type: none"> ▪ tap Save. The <i>New Favourite</i> screen will display. ▪ Tap Save as Home.
save the destination as a Favourite	<ul style="list-style-type: none"> ▪ tap Save. The <i>New Favourite</i> screen will display. ▪ Tap Save as Favourite.

If you want to ...	Then ...
display Route Preferences	tap Preferences . The <i>Route Calculation</i> screen will display.
change your destination	press  . The <i>Destination Search</i> screen will display.

How do I create a trip with multiple stops?

You can use the *Multi-stop Trip Planner* screen to set multiple waypoints for your trip. Your route will be calculated to go via each of these points in the specified order.

Waypoints can be added via the *Multi-stop Trip Planner* screen or by selecting **Location** from the pop-up *Map* menu on the *2D Map* or *3D Map* screen, then **Add to Trip**. You can save up to 200 multi-stop trips, each with up to 15 waypoints.



Waypoints added, updated or deleted after a multi-stop trip has commenced will not affect the current route.

Quick Steps

1. Start your Multi-stop Trip
2. Select the country
3. Search for the city/area
4. Search for the street
5. Search for the house number
6. Tap **Go**.



Case Study: How do I navigate to multiple addresses?

This case study will show you how to set a multi-stop trip by selecting your country, then area, then street, then house number for each waypoint.

1. Start your multi-stop trip

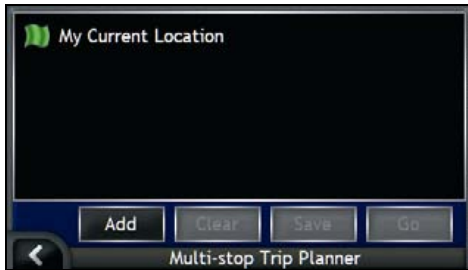

The *Multi-stop Trip Planner* screen will display.

- a) Tap **Add**.
The *Add to Trip Menu* will display.



- b) Tap **Address or POI**.
The *Destination Search* screen will open.



You can also add waypoints using Favourites, recent destinations and nearest Points of Interest.

2. Select the country

If you only have the map of one country installed and selected, that country is selected for your destination by default and cannot be changed. Go to step 3.

- a) From the *Destination Search* screen, tap **Change Country**.
The *Select Country* screen will display.



Select a country from the list.
The *Destination Search* screen will display.

3. Search for the city/area

- a) From the *Destination Search* screen, tap **City/Area**.
The *Keyboard* screen will display.



- b) Use the *Keyboard* screen to search for the city or area of your destination.
The *Destination Search* screen will display.



4. Search for the street

- a) From the *Destination Search* screen, tap **Street**.
The *Keyboard* screen will display.



- b) Use the *Keyboard* screen to search for the street of your destination.
The *Destination Search* screen will display.



 If house numbers and intersection information are not available for your selected street, the *Waypoint Preview* screen will display. Go to step 5b.

5. Search for the house number

- a) From the *Destination Search* screen, tap **House Number**.
The *Keyboard* screen will display.

 If the **House Number** option is not displayed, house numbers are not available for your selected street. To display the *Destination Preview* screen, tap **Go to centre of street**. Go to step c.



- b) Use the *Keyboard* screen to search for the house number of your destination. The *Waypoint Preview* screen will display.



- c) Tap **Add**. The destination is automatically saved and the *Multi-Stop-Trip Planner* screen will display.

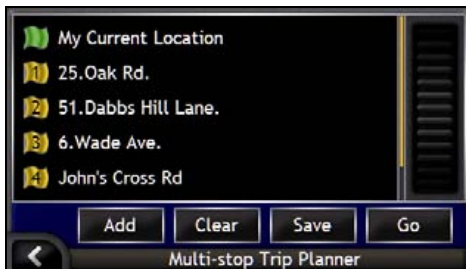

- d) Complete one or more of the following:

If you want to ...	Then ...
add another waypoint  Waypoints added after a multi-stop trip has commenced will not be included in the current route.	<ul style="list-style-type: none"> tap Add. The <i>Destination Search</i> screen will display. Return to step 3.
calculate the route	<ul style="list-style-type: none"> tap Go. The <i>Multi Stop Trip Preview</i> screen will display. Tap Go. The <i>Map</i> screen will display the calculated route.
change the order of your waypoints	<ul style="list-style-type: none"> tap a destination point to move. The <i>Waypoint Preview</i> screen will display. Tap Move up or Move down. The <i>Multi-stop Trip Planner</i> screen will display.
display the geographical details of a waypoint	<ul style="list-style-type: none"> tap a destination point. The <i>Waypoint Preview</i> screen will display. Tap Details. The <i>Waypoint Details</i> screen will display.
delete all waypoints	tap Clear .
delete one waypoint	<ul style="list-style-type: none"> tap a destination point to delete. The <i>Waypoint Preview</i> screen will display. Tap Delete. The <i>Multi-stop Trip Planner</i> screen will display.

If you want to ...	Then ...
save the multi-stop trip as a Favourite	<ul style="list-style-type: none"> ▪ tap Save. The New Favourite screen will display. ▪ Tap Save as Favourite. The Favourite will save and the <i>Multi-Stop Trip Planner</i> screen will display.

How do I skip a waypoint during a multi-stop trip?

You can modify a multi-stop trip at any time from the *Multi-stop Trip Planner* screen, however if you have already commenced a trip, changes will not affect the current route:

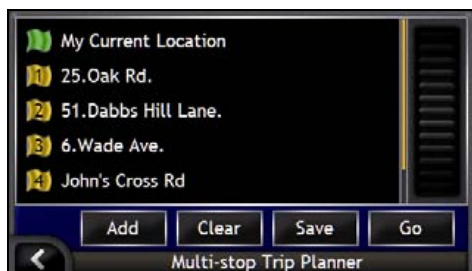

To skip a waypoint during a multi-stop trip, complete the following:

1. Tap the map to display the cross-hairs.
The *Map Menu* will display.
2. Tap **Route**, then **Skip Waypoint**.
The next waypoint will be skipped and the route recalculated to the following waypoint.

How do I search for a landmark or venue?

Setting a Point of Interest (POI) as your destination

A POI is a named site, feature, landmark or public venue which can be displayed as an icon on the map. POIs are grouped by type, such as petrol stations, parks and museums.

How do I find the nearest petrol station?

You can press  to quickly find the nearest petrol station.

As POIs are grouped by category, including petrol stations, your iCN will display a list of the nearest petrol stations based upon your current location.

a) Press .

The *Select POI* screen will display, showing a list of the nearest petrol stations based upon your current location. The nearest appears at the top of the list.



b) Select a petrol station from the list.
The *Destination Preview* screen will display.



c) Tap **Go**.
Your route is calculated; the *3D Map* screen will display.

P How do I find the nearest parking area?

You can press  to quickly find the nearest parking area.

This case study will show you how to set your destination by locating and selecting a parking area Point of Interest (POI).

As POIs are grouped by category, including parking areas, the iCN will show you a list of the nearest parking areas based upon your current location.

- a) Press .

The *Select POI* screen will display, showing a list of the nearest parking areas based upon your current location. The nearest appears at the top of the list.



- b) Select a parking area from the list.
The *Destination Preview* screen will display.



- c) Tap **Go**.
Your route is calculated; the *3D Map* screen will display.

How do I search for other POIs?

Select a POI destination using the *Destination Search*, *Keyboard* and *Destination Preview* screens, which used together form a POI-entry wizard.

This section describes how to use each of these screens and provides a case study to help guide you through setting your POI.

Quick Steps

1. Open the *Destination Search* screen
2. Select the country
3. Select the type of POI
4. Tap **Go**.



Case Study: How do I search for a Point of Interest?

This case study will show you how to set your destination by selecting a Point of Interest (POI).

1. Open the *Destination Search* screen



The *Destination Search* screen will display.



If this is the first time you are setting your destination and you have maps from more than one country installed and selected, then the *Select Country* screen will display instead of the *Destination Search* screen. Go directly to step 2b.

The next time you perform this procedure, the *Destination Search* screen will open as expected.

2. Select the country

If you only have the map of one country installed and selected, that country is selected for your destination by default and cannot be changed. Go to step 3.

- a) From the *Destination Search* screen, tap **Change Country**.
The *Select Country* screen will display.



Select a country from the list.
The *Destination Search* screen will display.

3. Select the type of POI



To narrow the search for a type of POI, you can first search by Area.

- a) From the *Destination* screen, tap **Point of Interest**.
The *Select POI* screen will display.



- b) Select a POI type from the list.
The *Keyboard* screen will display.

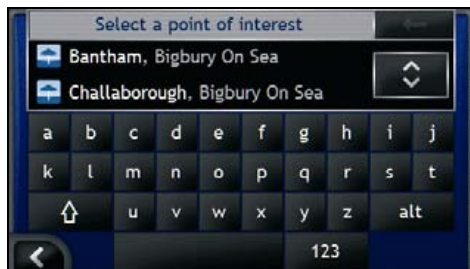

- c) Use the *Keyboard* screen to find the POI.
The *Destination Preview* screen will display.



- d) Complete one of the following:



Please ensure that the route preferences are applicable for the route that you have specified, *before* you tap **Go**.

If you want to ...	Then ...
calculate the route and open the <i>3D Map</i> screen	tap Go . Your route is calculated; the <i>3D Map</i> screen will display.
select a more precise location by pointing	tap the map to switch to the main map view.
display the geographical details	tap Details . The <i>Destination Details</i> screen will display.
save the destination as My Home	<ul style="list-style-type: none"> ▪ tap Save. The <i>New Favourite</i> screen will display. ▪ Tap Save as Home.
save the destination as a Favourite	<ul style="list-style-type: none"> ▪ tap Save. The <i>New Favourite</i> screen will display. ▪ Tap Save as Favourite.
display Route Preferences	tap Preferences . The <i>Route Calculation</i> screen will display.
change your destination	press  . The <i>Destination Search</i> screen will display.

How do I view my route?

Once a route has been calculated, the *3D Map* screen will display. You will be directed to your destination by vocal and visual instructions.

You can view your route in several ways by pressing  to cycle through the map screens.

In this section

3D Map screen	42
2D Map screen	44
Next Turn screen	46
Direction List screen	47



3D Map screen





The *3D Map* screen is oriented to your travelling direction.

To view the *3D Map* screen when a route has been calculated, press  to cycle through the screens.

- Tap and drag the screen, to move across the map.
- Tap and hold the map, to view *Map* menu. For more information, see "How do I use the Map Menu?" on page 69.



Item	Description
1	Direction of next turn The direction of your next turn.  To repeat the voice prompt of your next turn, tap the turn arrow.
2	Distance to next turn The distance to your next turn.
3	Next instruction The direction and name of the street to turn in to.  When you cycle through the Information options, a function description will display briefly at the top of the screen.
4	Next turn arrow Your next turn is highlighted in a different colour from future turns. The default colour of your next turn is green, but will depend on the colour theme you are using.
5	Current position Your current position is marked with  .
6	Status bar Displays one of the following: <ul style="list-style-type: none"> ▪ The name of the street you are located on ▪ Speed warnings ▪ Active POIs.

	Item	Description
7	Information	<p>Displays one of the following options:</p> <ul style="list-style-type: none"> ▪ Time ▪ km/h or mph (Speed) ▪ TTG (Time to Go) ▪ DTG (Distance to Go) ▪ ETA (Estimated Time of Arrival). <p>Tap to cycle through the options.</p> <hr/> <p> During a Multi-trip journey, Time to Go, Distance to Go and ETA will display as: Time to Waypoint, Distance to Waypoint and ETA at Waypoint.</p>
8	Route	Your current route is highlighted.
9	Cancel route	Cancels your current route
10	Zoom	<p>To view zoom options, tap .</p> <ul style="list-style-type: none"> ▪ To display a smaller area in greater detail, tap  or scroll down. ▪ To display a larger area in less detail, tap  or scroll up.
11	Compass and GPS information	<p>Displays one of the following options:</p> <ul style="list-style-type: none"> ▪ Green Quadrants - A valid GPS signal is being used to fix your position; displays between one and four quadrants to indicate the strength of the signal. ▪ Red Circle - No GPS signal. ▪ Compass heading. <p>Tap to cycle through the options; tap and hold to display the <i>GPS Status</i> screen.</p>



2D Map screen





The *2D Map* screen shows your current position (if a GPS fix is active) and surrounding street names. If a route has been calculated, the route and turns are highlighted. The *2D Map* screen is displayed *Course Up*, unless the *Map Display* preferences are set to North.

To view the *2D Map* screen, press  to cycle through the screens.

- Tap and drag the screen, to move across the map.
- Tap and hold the map, to view *Map* menu. For more information, see "How do I use the Map Menu?" on page 69.



Item	Description
1	Direction of next turn The direction of your next turn.  To repeat the voice prompt of your next turn, tap the turn arrow.
2	Distance to next turn The distance to your next turn.
3	Next instruction The direction and name of the street to turn in to.  When you cycle through the Information options, a function description will display briefly at the top of the screen.
4	Current position Your current position is marked with  .
5	Scale bar Displays map scale.
6	Status bar Displays one of the following: <ul style="list-style-type: none"> ▪ The name of the street you are located on ▪ Speed warnings ▪ Active POIs.



	Item	Description
7	Information	<p>Displays one of the following options:</p> <ul style="list-style-type: none"> ▪ Time ▪ km/h or mph (Speed) ▪ TTG (Time to Go) ▪ DTG (Distance to Go) ▪ ETA (Estimated Time of Arrival). <p>Tap to cycle through the options.</p> <hr/> <p> During a Multi-trip journey, Time to Go, Distance to Go and ETA will appear as: Time to Waypoint, Distance to Waypoint and ETA at Waypoint.</p>
8	Route	Your current route is highlighted.
9	Cancel route	Cancels your current route.
10	Next turn arrow	<p>Your next turn is highlighted in a different colour to future turns.</p> <p>The default colour of your next turn is green, but will depend on the colour theme you are using.</p>
11	Zoom	<p>To view zoom options, tap .</p> <ul style="list-style-type: none"> ▪ To display a smaller area in greater detail, tap  or scroll down. ▪ To display a larger area in less detail, tap  or scroll up.
12	Compass and GPS Information	<p>Displays one of the following options:</p> <ul style="list-style-type: none"> ▪ Green Quadrants - A valid GPS signal is being used to fix your position; displays between one and four quadrants to indicate the strength of the signal. ▪ Red Circle - No signal. ▪ Compass heading. <p>Tap to cycle through the options; tap and hold to display the <i>GPS Status</i> screen.</p>

Next Turn screen

The *Next Turn* screen displays information that you need for the next turn, the direction of the turn and the distance to the turn. A route must first have been calculated, for this screen to be available.

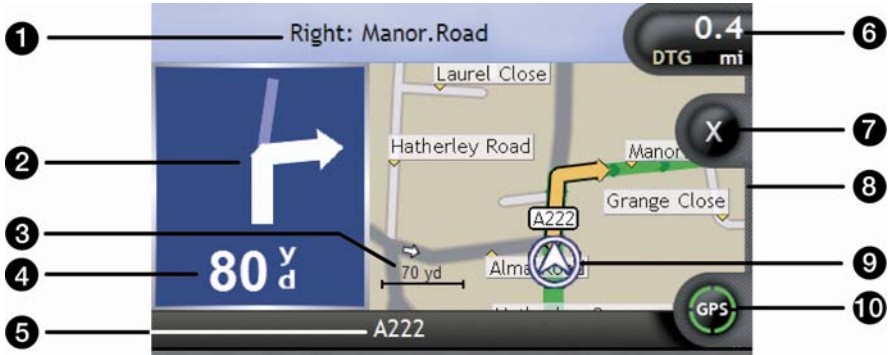
To view the *Next Turn* screen when a route has been calculated, press  to cycle through the screens.



Item	Description
1	Next instruction The direction and name of the street to turn in to.  When you cycle through the Information options, a function description will display briefly at the top of the screen.
2	Direction of next turn The direction of your next turn.
	Scale bar Displays map scale.
4	Distance to next turn The distance to your next turn.
5	Status Bar Displays one of the following: <ul style="list-style-type: none"> The name of the street you are located on Speed warnings Active POIs.
6	Information Displays one of the following options: <ul style="list-style-type: none"> Time km/h or mph (Speed) TTG (Time to Go) DTG (Distance to Go) ETA (Estimated Time of Arrival). Tap to cycle through the options.  During a Multi-trip journey, Time to Go, Distance to Go and ETA will appear as: Time to Waypoint, Distance to Waypoint and ETA at Waypoint.
7	Cancel Route Cancels your current route.

Item	Description
8	Map of next turn A map of your next turn.
9	Current position Your current position is marked with  ; if visible.
10	Compass and GPS Information Displays one of the following options: <ul style="list-style-type: none"> Green Quadrants - A valid GPS signal is being used to fix your position; displays between one and four quadrants to indicate the strength of the signal. Red Circle - No signal. Compass heading. Tap to cycle through the options; tap and hold to display the <i>GPS Status</i> screen.

Direction List screen

The *Direction List* screen displays the next four turns of your route, the turn direction, the street name and the distance to the turn. You can view all the turns in the list, using the scroll bar. A route must first have been calculated for this screen to be available.

To view the *Direction List* screen when a route has been calculated, press  to cycle through the screens.

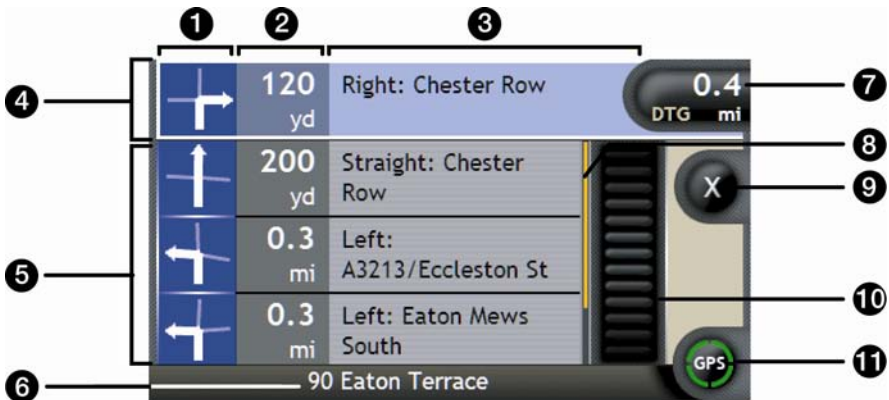

Item	Description
1	Direction of turn The direction of the turn. Your next turn is highlighted.
2	Distance to turn The distance to your next turn. Your next turn is highlighted.
3	Instruction The direction and name of the street to turn in to. Your next turn is highlighted.
4	Next turn (highlighted) Your next turn is highlighted at the top of the list.
5	Upcoming turns The direction and distance of upcoming turns.

	Item	Description
6	Status Bar	The name of the street you are located on.
7	Information	<p>Displays one of the following options:</p> <ul style="list-style-type: none"> ▪ Time ▪ km/h or mph (Speed) ▪ TTG (Time to Go) ▪ DTG (Distance to Go) ▪ ETA (Estimated Time of Arrival). <p>Tap to cycle through the options.</p> <hr/> <p> During a Multi-trip journey, Time to Go, Distance to Go and ETA will appear as: Time to Waypoint, Distance to Waypoint and ETA at Waypoint.</p>
8	Position Indicator	Displays your position in the Direction List screen.
9	Cancel Route	Cancels your current route.
10	Scroll Bar	Allows you to view each turn by scrolling through the list.
11	Compass and GPS Information	<p>Displays one of the following options:</p> <ul style="list-style-type: none"> ▪ Green Quadrants - A valid GPS signal is being used to fix your position; displays between one and four quadrants to indicate the strength of the signal. ▪ Red Circle - No signal. ▪ Compass heading. <p>Tap to cycle through the options; tap and hold to display the <i>GPS Status</i> screen.</p>



What if I miss a turn?

Back-On-Track™ Automatic Rerouting

Your route is re-directed if you make a wrong turn. A message informing you that your route is being re-calculated will display at the top of the screen. The **Information** button will display the percentage complete status of the route re-calculation.

To cancel a route re-calculation tap . A warning will display, asking you to confirm the cancellation. If confirmed, both the re-calculation and your current route will be cancelled.

How do I save Favourites and My Home?

You can save up to 200 destinations as Favourites, one of which can be saved as My Home. My Home can be any designated Favourite, but we recommend that it is your home or other common destination.

You can save a Favourite from the *Destination Preview* screen after searching for an address, or from the *Maps Menu* on the *3D or 2D Map* screens. For more information, see "How do I use the Map Menu?" on page 69.

Can I assign a photo to a Favourite?

You can assign a photo to any of your existing Favourites. For more information, see "How do I assign a photo to a Favourite?" on page 66.

How do I save a Favourite?

Search for an address until the *Destination Preview* screen is displayed.

1. Tap **Save**.
The *New Favourite* screen will display.



2. To change the name of the Favourite, tap . The *Keyboard* screen will display.

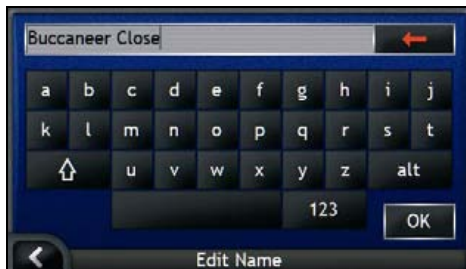

- After you have entered a name for the Favourite, tap **OK**.
The *New Favourite* screen will display.

3. Complete one of the following:

If you want to ...	Then ...
save as a Favourite	tap Save as Favourite . The Favourite is saved. The <i>Favourite Preview</i> screen will display.
save as My Home	tap Save as My Home . The Favourite is saved as My Home. The <i>My Home Preview</i> screen will display.

How do I navigate to a Favourite?



1. Tap the Favourite destination you want to travel to.
The *Favourite Preview* screen will display.

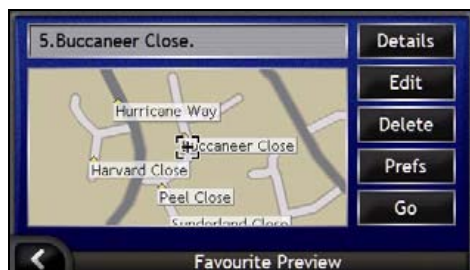

2. Tap **Go**.
The route is calculated and displayed on the *Map* screen.

How do I navigate to My Home?

If you have not set an address as *My Home*, the first time you try to navigate to *My Home* you will be prompted to search for an address using the address-entry wizard.

Option 1 - From the *Go To Menu*



The route is calculated and displayed on the *Map* screen.

Option 2 - From the *Favourite Destinations* screen



1. From the *My Favourites* screen, select *My Home*.
The *My Home Preview* screen will display.



2. To navigate to *My Home*, tap **Go**.
The route is calculated and displayed on the *Map* screen.

Option 3 - Using the remote control

You can navigate to *My Home* by pressing **Ⓜ** on the remote control (may be sold separately).

1. Press **Ⓜ** to display the *My Home Preview* screen.
2. Press **Ⓜ** again, to calculate the route and display the *3D Map* screen.

How do I view details of a Favourite?



- From the *My Favourites* screen, select a Favourite. The *Favourite Preview* screen will display.



- Tap **Details**. The *Favourite Details* screen will display.



- Complete one of the following:

If you want to ...	Then ...
rename the <i>Favourite</i> or save the <i>Favourite</i> as your <i>Home</i>	tap Save . The <i>Edit Favourite</i> screen will display.
set the route <i>Preferences</i> before navigating to your <i>Favourite</i>	tap Prefs . The route <i>Preference</i> screen will display.
navigate to your <i>Favourite</i> or <i>My Home</i>	tap Go . The route is calculated and displayed on the <i>Map</i> screen.
return to the <i>Favourite Preview</i> screen	tap

How do I edit the name of a Favourite?



- From the *My Favourites* screen, select a Favourite to edit. The *Favourite Preview* screen will display.



- Tap **Edit**. The *Edit Name* screen will display.

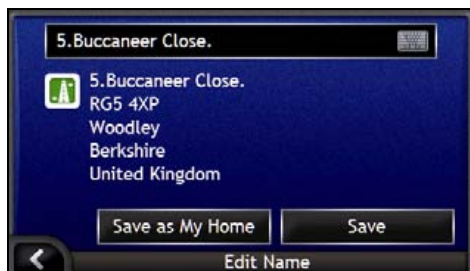

- To edit the name of the Favourite, tap .
 - After you have edited the Favourite name, tap **OK**. The *Edit Name* screen will display.
- Complete one of the following:

If you want to ...	Then ...
rename the Favourite	tap Save . The Favourite is saved. The <i>Favourite Preview</i> screen will display.
save as My Home	tap Save as My Home . The Favourite is saved as My Home. The <i>My Home Preview</i> screen will display.

How do I delete a Favourite?



1. From the *My Favourites* screen, select a Favourite to delete. The *Favourite Preview* screen will display.



2. Tap **Delete**.
The Favourite is deleted. The *My Favourites* screen will display.



How do I use the camera?

Your iCN has an inbuilt camera with **NavPix** technology, which allows you to take photos and save them as a geographical location on the navigation maps. This enables you to navigate directly to where the photo was taken. Photos can be stored in an Album on the iCN's hard drive or a memory card and viewed in full screen mode.

In this section

How do I view the Camera screen?	56
How do I take a photo?	57
How do I manage my photos?	59
How do I save, e-mail or print photos?	63
How do I navigate to a photo location?	65
How do I assign a photo to a Favourite?	66

How do I view the Camera screen?







The *Camera* screen allows you to take photos and access the camera preferences. To view the *Camera* screen, press  on top of the iCN.

- You can also access the *Camera* screen from the *Main Menu*; tap .



Pressing  will not take a photo until you are already in the *Camera* screen.





	Element	Description
1		Captures the photo.
2		Displays the <i>Album</i> screen.
3		Returns you to the screen you last viewed.
4	Viewfinder	Allows you to frame the image within the Viewfinder .
5		Displays the current lighting setting. Tap to view lighting options.
6		Displays the brightness setting. Tap to view brightness options.
7		Indicates if GPS information is available.



When the *Camera* screen is displayed, all buttons on the iCN except  become inactive. This ensures you remain in the *Camera* screen, even if other buttons are pressed accidentally.



How do I take a photo?

The *Camera* screen must be displayed before you can take a photo.

1. To view the *Camera* screen, press  on top of the iCN.
 - You can also access the *Camera* screen from the *Main Menu*; tap .
2. When the *Camera* screen is open, an image of whatever the camera is focused on will display in the **Viewfinder**.



Before you take a photo you can customize the lighting and brightness settings. For more information, see "How do I customize camera preferences?" on page 58.

3. When you are satisfied with the image displayed in the **Viewfinder**, press  to take the photo.
 - You can also tap  to take the picture.
4. The captured image will preview in the **Viewfinder** for two seconds before it is automatically saved in your *Album* on the iCN's hard drive.



If the *Camera* screen is inactive for more than two minutes it will revert to the *Main Menu* screen.



GPS fix

The GPS icon indicates whether the iCN has a GPS fix and the strength of the signal. When the iCN has a GPS fix and a picture is taken, location co-ordinates are linked to the picture. The co-ordinates must be available for you to save a picture as a *Favourite* destination. Location co-ordinates are displayed on the *Photo Details* screen. For more information, see "Photo management" on page 61.







How do I customize camera preferences?

The Camera has lighting and brightness settings which you can customise before taking a photo.

Lighting options

1. To view the *Camera* screen, press .
2. From the *Camera* screen, tap .
The range of lighting options will display.





Setting	Description
	For outdoor use, in bright sunlight
	For outdoor use, with cloud cover
	For indoor use, under normal lighting
	For indoor use, under fluorescent lighting
	For night use; gives longer exposure time to enhance picture quality
	Automatically selects the most suitable setting for the conditions

3. Tap your preferred lighting option.
Your selection will be saved.

Brightness options

The brightness control is adjustable to one of six levels.

1. To view the *Camera* screen, press .
2. From the *Camera* screen, tap .
The range of brightness options will display.





3. Select one of the six levels to set the brightness of a photo.

How do I manage my photos?





Album management

The *Album* stores all your photos and displays them as thumbnails. You can store photos in the *Album* on the iCN's hard drive or on your memory card.

 When you take a photo, it is always saved to the *Album* on the iCN's hard drive.

1. Press  to view the *Camera* screen.
2. From the *Camera* screen tap . The *Album* screen will display.



	Element	Description
1		Displays the <i>Album</i> on the hard drive.
2		Displays the <i>Album</i> on the memory card. (Optional)
3	Copy	Copies photos from the hard drive to the memory card or vice versa.
4	Delete	Deletes photos from the hard drive or memory card.
5		Tap to return to the Viewfinder .
6	Photo	Displays photos in the photo album on the hard drive or memory card. Tap to display <i>Photo Details</i> screen.
7	Scroll bar	Allows you to scroll through thumbnail view of photos.
8		Displays if GPS co-ordinates are associated with a photo.

How do I copy photos between *Albums*?

Photos can be copied from the *Album* on the iCN's hard drive to your memory card and vice versa.



The first time a photo is copied to your memory card, a folder will be created on the memory card called *My Pictures*. For more information, see "How do I use a memory card with my iCN?" on page 111.

1. From the *Album* screen, select the *Album* you want to view.
2. Tap and hold, then drag across the screen to select the photo(s) you want to copy. As a photo is selected, a red border will appear around it.
3. To cancel a selection, tap and drag over the photo(s) again.
4. When you have finished the selection, tap **Copy**.
5. A warning screen will display, asking you to confirm or cancel the procedure. If confirmed, the photo(s) will be copied to the other *Album*.



You can also copy a single photo from the *Photo Details* screen. For more information, see "Photo management" on page 61.

How do I view the *Album* on my Memory Card?

The icon displayed at the top left hand corner of the *Album* screen, indicates which *Album* you are currently viewing.

To change *Albums*, tap the icon to reveal both options (hard drive & memory card) then select the required *Album*.

For information on using a memory card with your iCN, see "How do I use a memory card with my iCN?" on page 111.

How do I delete photos from an album?

Photos can be deleted from the *Album* on the iCN's hard drive or your memory card.



When a photo has been saved as a Favourite destination, you will not delete the Favourite if you subsequently remove the photo from your *Album*.

1. From the *Album* screen, select the *Album* you want to view.
2. Tap and hold, then drag across the screen to select the photos you want to delete. As a photo is selected, a red border will appear around it.
3. To cancel a selection, tap and drag across the photo again.
4. When you have finished the selection, tap **Delete**.
5. A warning screen will display, asking you to confirm or cancel the procedure. If confirmed, the photos will be deleted from the *Album*.





You can also delete a single photo from the *Photo Details* screen. For more information, see "Photo management" on page 61.

Photo management

The *Photo Details* screen displays information about your photo. To display the *Photo Details* screen, tap any photo in your *Album*.







	Element	Description
1	Go to	Displays the <i>Destination Preview</i> screen, ready for you to navigate to the location.  The Go To button is only available if GPS co-ordinates are associated with the photo.
2	Assign	Allows you to assign a photo to an existing <i>Favourite</i> ; or create a new <i>Favourite</i> , if GPS co-ordinates are associated with the photo.
3	Copy	Copies a photo from the hard drive to your memory card and vice versa.
4	Delete	Deletes a photo from the hard drive or your memory card.
5	Photo Title	The title of the photo; tap Edit to add a title or edit the existing title.
6		Tap to return to your <i>Album</i> .
7	Show on Map	When selected, displays an icon on the map at the location the photo was taken.
8	Photo	A thumbnail of the photo. Tap to display the photo in full-screen.
9	Scroll Bar	Tap and drag to scroll through photos stored in your <i>Album</i> .
10	Edit	Allows you to create a title for a photo using the <i>Keyboard</i> screen.
11	Time / Date and Location Co-ordinates	Displays the time and date the photo was taken; also displays the latitude and longitude co-ordinates, if GPS co-ordinates are associated with the photo.

How do I view a photo in full-screen?

1. From the *Photo Details* screen, tap the thumbnail of the photo.
The photo will appear in full-screen.



2. Complete the following:

If you want to ...	Then ...
zoom into the photo	tap  .
zoom out of the photo	tap  .
rotate the photo	tap  The photo will rotate 90 degrees anticlockwise each time  is tapped; the photo is saved at the new angle.
view parts of the photo not displayed on-screen	tap and hold the image, then drag across the screen.

How do I create a title for a photo?

A title can be given to your photo or an existing title can be renamed. The title can be a maximum of 34 characters.

1. From the *Photo Details* screen, tap **Edit**.
The *Edit Description* screen will display.
2. Tap each character as required.
The title will appear at the top of the screen.



3. When the title is complete, tap **OK**.
The *Photo Details* screen will display, with the new title under the photo.

How do I save, e-mail or print photos?

To save, e-mail or print photos, you must first transfer the photos to your computer; there are two ways to do this:

- Copy the photos from a memory card to your computer via a memory card reader or memory card drive, or
- Copy the photos directly from your iCN to your computer via the enclosed USB cable.

Via Memory Card

Photos can be copied from the *Album* on your iCN to the *My Pictures* folder on your memory card. The first time a photo is copied to the memory card, the following folders will be created:

E:\My Documents\My Pictures, where "E" is the letter assigned to your memory card drive or reader.

All photos in *My Pictures* are part of the same photo album and can be viewed on your iCN. For more information on viewing albums and copying photos between albums, see "Album management" on page 59.

Once a photo has been copied to the photo album on your memory card, you can then use the card with your computer to save, e-mail or print the photos, or take the memory card to a digital photo retailer for printing.

Via USB cable

Before you can copy photos from your iCN to your computer, you must first ensure that you have Microsoft ActiveSync installed.

What is Microsoft ActiveSync®?

Microsoft ActiveSync is used to establish a connection between your iCN and your computer.

After it is installed, ActiveSync will run in the Windows System Tray/Notification Area when you start Windows. ActiveSync will activate when your iCN is connected to your computer.

For more information on ActiveSync, search for "ActiveSync" at www.microsoft.com.

How do I install ActiveSync on my computer?

Microsoft ActiveSync is automatically installed on your computer when you install SmartST Desktop. For more information, see "How do I install SmartST Desktop on my computer?" on page 78.

If you will not be installing SmartST Desktop on your computer, you can install ActiveSync 3.7.1 by completing the following:

1. Close all open programs on your computer.
2. Insert the SmartST Application Installer CD into your computer CD drive. The SmartST Desktop installer will start.
 - If your computer does not automatically launch the CD, start the installation manually: *Start > Run*. Type **D:\Install.exe** where "D" is the letter assigned to your CD drive, then click **OK**.

3. Select your preferred language for SmartST Desktop.
4. Click **Install Microsoft ActiveSync** and follow the screen prompts.

How do I copy photos from my iCN to my computer via the USB cable?

CAUTION Ensure that Microsoft ActiveSync is installed on your computer before connecting the USB cable to your computer.

1. Plug the large end of the USB cable directly into a USB port on your computer (not a USB hub); plug the small end into the **USB Socket** (↔) on the side of your iCN.



Where possible, plug the USB cable into a USB port at the *back* of your computer.

2. Plug the small end of the AC Power Pack cable into the ^{***} socket on the side of your iCN; plug the other end into the mains.
3. If your iCN is turned off, press **⏻**.
Your iCN will turn on.
4. When the following screen displays on your iCN, click **Next**:

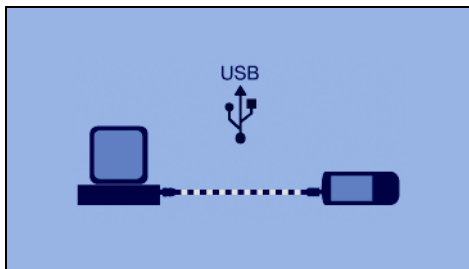

Microsoft ActiveSync will synchronize with your iCN.

5. In the *Microsoft ActiveSync* window, click .
Windows Explorer will open, displaying the contents of your iCN.



CAUTION Do not delete, move or edit any files on your iCN other than photos, as it may prevent your iCN from functioning properly.

6. Open the following folder to display a list of your photos:

My Documents > My Pictures



You cannot view or preview photos until they have been copied to your computer.

7. Copy the photos in the *My Pictures* folder to your computer.
You can now view, e-mail or print the photos.



When the photos have been successfully copied to your computer, it is then safe to delete the photos from your iCN *My Pictures* folder.

How do I navigate to a photo location?



To navigate to a photo location, a GPS fix must have been available when the photo was taken.



1. From the *Album* screen, tap a photo. The *Photo Details* screen will display.
2. From the *Photo Details* screen, tap **Go to**. The *Destination Preview* screen will display.



3. Complete the following:

If you want to ...	Then ...
navigate to your destination	tap Go , the <i>3D Map</i> screen will display your route.
customise your route preferences	tap Preferences , the <i>Route Preference</i> screen will display.
view your destination details	tap Details , the <i>Destination Details</i> screen will display.
save a photo as a Favourite or as My Home	<ul style="list-style-type: none"> ▪ tap Save, the <i>New Favourite</i> screen will display. ▪ tap . The <i>Keyboard</i> screen will display. Enter a name for your Favourite or My Home, then tap OK. ▪ to create a new My Home destination, tap Save as Home; to create a new Favourite destination, tap Save as Favourite. <div style="border: 1px solid black; padding: 5px; margin-top: 10px;"> Photos can only be saved as destinations if the GPS coordinate information was available when the photo was taken. </div>

How do I assign a photo to a Favourite?



When a photo is assigned to an existing Favourite, only the image, and not the image co-ordinates, are associated with the Favourite.



1. From the *Album* screen, tap a photo.
The *Photo Details* screen will display.
2. From the *Photo Details* screen, tap **Assign**.
The *Assign Photo* screen will display.



3. Complete the following:

If you want to ...	Then ...
assign a photo to an existing Favourite location	<ul style="list-style-type: none"> ▪ tap and select a Favourite destination from the list. The Favourite title will display. ▪ tap Save. The photo is assigned to the Favourite and the <i>Photo Details</i> screen will display.
create a new Favourite (when GPS co-ordinates are associated with a photo)	<ul style="list-style-type: none"> ▪ tap and select A new favourite from the list. ▪ tap . The <i>Keyboard</i> screen will display. Enter a name for your Favourite, then tap OK. ▪ tap Save. The photo is saved as a new Favourite and the <i>Photo Details</i> screen will display.

What else can I do?

When you want to...	Then ...
view your recent locations	use 'Recent Locations', see "How do I navigate to a recent location?" on page 68.
calculate a route that avoids a specified area on the map	use 'Avoid an Area', see "How do I avoid an area?" on page 71.
preview your route, or plan and view a route without a GPS fix	use the Route Demonstrator, see "How do I preview a route?" on page 72.
view statistical information on both your current trip and all trips to date	use the Trip Meter, see "How do I view my route statistics?" on page 74.



WARNING For your safety, enter destination information before you start a journey. Do not enter a destination while driving.

In this section

How do I navigate to a recent location?	68
How do I use the Map Menu?	69
How do I avoid an area?	71
How do I preview a route?	72
How do I view my route statistics?	74

How do I navigate to a recent location?

To make navigating to an address easier, your iCN will automatically save all of your start locations and destinations in a list of recent locations.

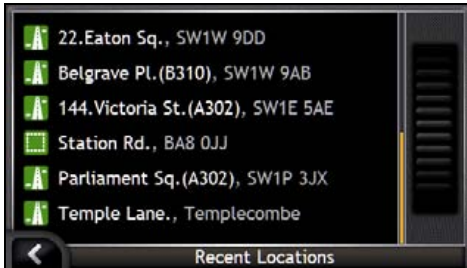

1. Tap a recent location.
The *Recent Location Preview* screen will display.



2. Complete one of the following:

If you want to ...	Then ...
calculate the route and open the <i>3D Map</i> screen	tap Go . The <i>3D Map</i> screen will display.
display the geographical details of the recent location	tap Details . The <i>Recent Location Details</i> screen will display.
save the recent location as My Home	<ul style="list-style-type: none"> tap Save. The <i>New Favourite</i> screen will display. Tap Save as My Home.
save the recent location as a Favourite	<ul style="list-style-type: none"> tap Save. The <i>New Favourite</i> screen will display. Tap Save as Favourite.
display Route Preferences	tap Preferences . The <i>Route Calculation</i> screen will display.

If you want to ...	Then ...
change your destination	press  . The <i>Recent Locations</i> screen will display.

How do I use the Map Menu?

The *Map Menu* allows you to access navigational functions from the *3D Map* and *2D Map* screen.



Displaying the *Map Menu*

1. Tap  to display the *3D Map* or *2D Map* screen.
2. Tap and drag to move around the map to your selected location.
3. Either tap and hold the cross-hairs that location, or tap and hold elsewhere on the map. The *Map Menu* will display.

Map Menu options

The following options are available via the *Map Menu*:

Menu Option	Description
Navigate To	Calculates a route from your current location, once your current location is determined.
Show Details	Only available when the selected location is near a road. Displays the <i>Location Details</i> screen from which you can: <ul style="list-style-type: none"> ▪ View details of the location ▪ Add the location to your multi-stop trip ▪ Save the location as a favourite ▪ Access and edit your route preferences ▪ Navigate to the location.

Menu Option	Description
Location	<p>Only available when the selected location is near a road.</p> <p>Displays the <i>Location</i> sub-menu from which you can:</p> <ul style="list-style-type: none"> ▪ Add To Favourites. Displays the <i>New Favourite</i> screen for you to add the location as a favourite. For further information, see "How do I save a Favourite?" on page 49. ▪ Nearest POI. Displays the <i>Select POI</i> screen. Select the POI category, then the POI to navigate to. For further information, see "How do I search for a landmark or venue?" on page 36. ▪ Add To Trip. Adds the location to your multi-stop trip. ▪ Set As Start Location. Sets the location as your departure point.
Route	<p>Only available when navigating a route.</p> <p>Displays the <i>Route</i> sub-menu from which you can:</p> <ul style="list-style-type: none"> ▪ Detour. Detours your route to avoid the next 1, 2, 5, 10 or 20 kilometres or the next 1, 2, 5, 10 or 20 miles. ▪ Demonstrate. Starts the route demonstration, demonstrating navigation from your current position or departure point. ▪ Stop Demonstration. Stops the route demonstration. ▪ Skip Waypoint. Skips the next stop on your multi-stop trip. ▪ Show Entire Route. Displays your entire route on the <i>2D Map</i> screen. ▪ Show Summary. Displays a summary of your route, including your departure and destination addresses, total distance and total estimated time to your destination.
Add Avoid Area	<p>Adds an Avoid Area for you to size.</p>
Delete Avoid Area	<p>Deletes the selected Avoid Area.</p>

How do I avoid an area?

Your iCN can calculate a route that avoids a specified area on the map. Up to ten Avoid Areas can be added. Avoid Areas are displayed as shaded areas.



CAUTION If no alternative route around an Avoid Area exists, the route calculation will fail.

CAUTION If your destination is in an Avoid Area, you will be routed into that Avoid Area.

How do I add an Avoid Area?

1. Tap and hold the map to display the *Map* menu.
2. Select **Add Avoid Area**.
3. Tap and drag to set the Avoid Area to the correct size and position. The Avoid Area is added.

How do I delete an Avoid Area?

1. Locate the Avoid Area that you want to delete.
2. Tap and hold the Avoid Area to display the *Map* menu.
3. Select **Remove Avoid Area**. The Avoid Area is deleted.

How do I delete all Avoid Areas?



The *Saved Information* screen will display.

1. Tap **Delete Avoid Areas**.
2. When the warning dialog-box opens, tap **Yes** to confirm. All Avoid Areas are deleted.

How do I preview a route?

Route demonstration allows you to:

- Preview a route.
- Plan and view a route without a GPS fix, such as when you are inside a building.

The following steps will show you how to preview one route. To always preview your route, see "Demonstration and Logging" on page 98.

1. Select a departure point

If you have a GPS fix, you do not need to select a departure point unless you want the demonstrated route to start elsewhere.

- Tap to display the cross-hairs on the *Map* screen.
- Position the intersection of the cross-hairs over your departure point.
- Tap and hold the cross hairs to display the *Map* menu.

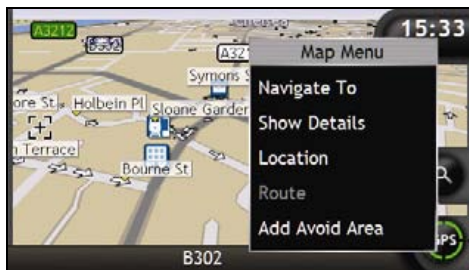

- Select **Location**.
The *Location* submenu will display.
- Select **Set as Start Location**.
The *Map* menu will close, and the selected point is set as your departure point.

2. Select a destination point

Set a destination either by using the address entry wizard or by using the *Maps* (see below):

- a) Locate your destination.
- b) Tap and hold your destination to display the *Map* menu.
- c) Select **Navigate To**.
The *Map* menu will close and the map screen will display the calculated route.

3. Demonstrate the route

Once the route has been determined, you can demonstrate the route by completing the following:

- a) Tap and hold the *Map* screen to display the *Map* menu.
- b) Select **Route**.
The *Route* submenu will display.
- c) Select **Demonstrate**.
The *3D Map* screen will display the calculated route in Route Demonstration mode.
 - If you have selected the **Loop demonstrations** check box on the *Demonstration and Logging* preferences screen, the Route Demonstration will continue to repeat the route.

How do I view my route statistics?

The iCN provides information on your:

- distance travelled
- average speed
- maximum speed
- time taken for trip
- stationary time.

Trip information is presented in two different ways. These are:

- information for the current trip
- information for all trips to date, or since the tripmeter was last reset.

How do I view statistics on my current route?

The *Tripmeter - Current Route* screen is used to view statistical information for your current trip.



The *Tripmeter - Current Route* screen will only display when there is a current route selected. If there is no route selected, the *Tripmeter - Global* screen will display as a default.

- a) Press and hold the **Information** button.
The *Tripmeter - Current Route* screen will display.



- b) Complete one of the following:

If you want to ...	Then ...
view statistics for your trips to date	tap  to display the <i>Tripmeter - Global</i> screen.
reset the tripmeter	<ul style="list-style-type: none"> ▪ tap Reset. A Warning dialog box will display. ▪ Tap Yes to reset. The <i>Tripmeter - Current Route</i> screen will display.

How do I view statistics of my trips to date?

The *Tripmeter - Global* screen is used to view statistical information for all of your trips to date, or since the trip meter was last reset.



The *Tripmeter - Current Route* screen will only display when there is a current route selected. If there is no route selected, the *Tripmeter - Global* screen will display as a default. Go to step b.

- a) From the *Tripmeter - Current Route* screen, tap . The *Tripmeter - Global* screen will display.



- b) Complete one of the following:

If you want to ...	Then ...
view statistics for your current route	tap to display the <i>Tripmeter - Current Route</i> screen.
reset the tripmeter	<ul style="list-style-type: none"> tap Reset. A Warning dialog box will display. Tap Yes to reset. The <i>Tripmeter - Global</i> screen will display.

What is SmartST Desktop?

SmartST Desktop is software for your PC computer and is used to install maps to your iCN.

You can also use it to remove maps from your iCN, obtain software updates, manage Custom Points of Interest (POIs) and install Basemaps.

In this section

How do I install SmartST Desktop on my computer?	78
SmartST Desktop features	79
How do I keep SmartST up-to-date?	82
How do I install maps on my iCN?	83
How do I backup my iCN?	93

Can I use SmartST Desktop with my computer?

Ensure you have the following *minimum* system requirements before installing SmartST Desktop:

- IBM compatible PC,
- Microsoft® Windows® 2000 or XP SP1 (NT not supported),
- Internet Explorer 6 or higher,
- CD drive,
- USB port,
- Internet connection for registration.



You must install SmartST Desktop from the Application Installer CD onto your computer hard drive; you cannot run SmartST Desktop from the CD.

What is Microsoft ActiveSync®?

Microsoft ActiveSync is used to establish a connection between your iCN and your computer. ActiveSync 3.7.1 will be installed on your computer (if a later version of ActiveSync is not already installed) as part of the installation of SmartST Desktop.

After it is installed, ActiveSync will run in the Windows System Tray/Notification Area when you start Windows. ActiveSync will activate when your iCN is connected to your computer.

For more information on ActiveSync, search for "ActiveSync" at www.microsoft.com.

How do I install a map for the first time?

The most common task performed using SmartST Desktop is the installation of a new map to your iCN internal memory or memory card. Complete the following procedures:

Step	Action
1	Install SmartST Desktop on your computer, see "How do I install SmartST Desktop on my computer?" on page 78.
2	Check for software updates for SmartST on your iCN, see "How do I keep SmartST up-to-date?" on page 82.
3	Install one or more maps on your iCN, see "How do I install maps on my iCN?" on page 83.

How do I install SmartST Desktop on my computer?



Before you Begin:

Ensure that your computer meets the minimum system requirements for SmartST Desktop, especially:

- i. Ensure that *Internet Explorer 6* or higher is installed on your computer before you install SmartST Desktop, even if it is not your default browser.
- ii. Windows XP users, ensure that *Windows XP Service Pack 1* or higher has been applied before you install SmartST Desktop.

1. Close all open programs on your computer.
2. Insert the SmartST Application Installer CD into your computer CD drive. The SmartST Desktop installer will start.
 - If your computer does not automatically launch the CD, start the installation manually: *Start > Run*. Type **D:\Install.exe** where "D" is the letter assigned to your CD drive, then click **OK**.



3. Select your preferred language for SmartST Desktop.
4. Click **Install SmartST Desktop**.
5. Follow the screen prompts to install SmartST Desktop:
 - Review and accept the Licence Agreement for SmartST Desktop and Microsoft ActiveSync (if not already installed on your computer) when prompted.
 - Select a destination folder for SmartST Desktop when prompted.
 - When the installation has finished, click **Finish**. SmartST Desktop will open.
6. If prompted to connect your iCN to your computer, complete the following:
 - Plug the large end of the USB cable directly into a USB port on your computer (not a USB hub); plug the small end into the **USB Socket** (*+*) on the side of your iCN.



Where possible, plug the USB cable into a USB port at the *back* of your computer.

- Plug the small end of the AC Power Pack cable into the  socket on the side of your iCN; plug the other end into the mains.

- Press **Ⓞ**.
Your iCN will turn on.
- When the following screen displays on your iCN, click **Next**:

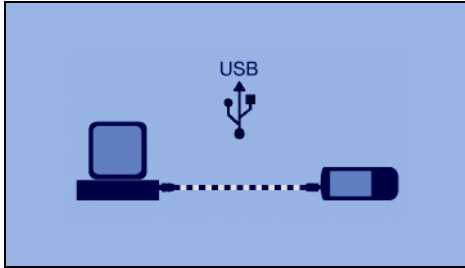

Microsoft ActiveSync will synchronize with your iCN.

You are now ready to use SmartST Desktop to install maps to your iCN.



SmartST Desktop features



Once SmartST Desktop has been installed on your computer, you can access it from the Windows **Start** menu:

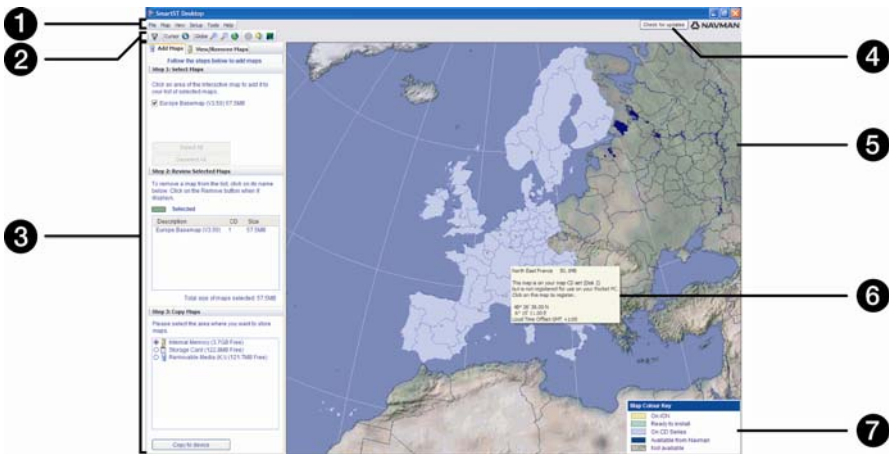







Start > All Programs > Navman > SmartST Desktop 2006



	Element	Description
1	Menu bar	Menus that provide access to SmartST Desktop functionality.
2	Toolbars	<p>There are three toolbars:</p> <ul style="list-style-type: none"> ▪ Status ▪ Globe ▪ Cursor <p>To display toolbars that are not on by default, select Toolbars on the View menu.</p> <p>For more information, see "Toolbars" on page 81.</p>
3	Add Maps and View/Remove Maps tabs	<p>Follow the steps on the Add Maps tab to install maps to your iCN, memory card, or memory card via a memory card reader. For more information, see "How do I install maps on my iCN?" on page 83.</p> <p>Follow the steps on the View/Remove Maps tab to remove installed maps from your iCN, memory card, or memory card via a memory card reader.</p>
4	Check for updates/ Update available	Click to check online for software updates or download software updates.
5	Globe	<p>A map of the world indicating the maps:</p> <ul style="list-style-type: none"> ▪ on the current CD, ▪ on a CD that came with the current CD, ▪ installed on your iCN or memory card, or ▪ available from Navman.
6	Map Information	<p>The following information will display when you point to a map:</p> <ul style="list-style-type: none"> ▪ Map name ▪ File size (if the map is on the inserted CD or a CD in the same set) ▪ Map status ▪ Latitude Longitude co-ordinates in degrees, minutes and seconds ▪ Local time offset UTC <hr/> <p> To display the Latitude and Longitude co-ordinates and UTC offset, click .</p>
7	Map Colour Key	A key for defining the different colours of the maps.

Toolbars

The following toolbars are available in SmartST Desktop:

Toolbar	Button	Description
Status		Indicates that your iCN is connected to your computer via ActiveSync.
		Indicates that your iCN is not connected to your computer.
Globe		Click to zoom in to the globe.
		Click to zoom out of the globe.
		Controls whether the globe automatically rotates to the correct maps when a map CD is inserted in your CD drive.
		Controls whether the globe is transparent.
		Controls whether the day/night line is displayed on the globe.
		Controls whether the maps are displayed on a globe or Mercator Projection.
Cursor		Controls whether the Latitude Longitude co-ordinates and UTC offset are displayed in the pointer text.

Moving a toolbar

A toolbar is either docked in the grey area at the top of the screen, or floating on the screen.

- To float a toolbar, click the portion of the toolbar to the left of the buttons and drag it to anywhere on the screen.
- To dock a toolbar, either double-click the top of a floating toolbar, or click and drag the toolbar back to the grey area at the top of the screen.
- To position a floating toolbar over a docked toolbar, press and hold **CTRL** while you drag the toolbar to the required position.

Reshaping a toolbar

Click and drag the edge of a floating toolbar to reshape it. You cannot reshape a toolbar that is docked at the top of the screen.

How do I keep SmartST up-to-date?

We recommend that you regularly use SmartST Desktop to check the Navman server for SmartST software updates.



Updating vs. Upgrading

Updating software is different from *upgrading* software:

When you *update* SmartST, the latest service packs and bug fixes are downloaded from Navman and applied to your iCN.

To *upgrade* SmartST, you must first purchase a new version of SmartST from a retailer, then install it on your iCN.

How do I update SmartST?

1. If you connect to the Internet via a dial-up connection, connect to the Internet now.
2. Open SmartST Desktop, follow the prompts, then click **Check for updates**. Your computer will connect to the Navman server to check for software updates.
3. If a software update is available, complete the following:
 - a) Click **Update available**. The Navman website will open.
 - b) Select the update for your region and download it to your computer.
 - c) On the *Setup* menu, select **Update software**, then **Update software on iCN**. Follow the prompts to update your iCN software.

Can I automatically check for software updates?

To configure SmartST Desktop to automatically check the Navman server for software updates, from the *Setup* menu, select **Update software**, then **Automatically check for software updates**.

If a software update is available, complete step 3 above.

How do I upgrade from a previous version of SmartST?

Follow the instructions in the *Installation Guide* or *Upgrade Guide* that came with your SmartST upgrade.

How do I install maps on my iCN?

Your iCN comes with one or more pre-activated maps.

You can install maps from the enclosed CDs to memory card or your iCN internal hard drive; however you may first need to purchase a Map Product Key to activate the maps. For detailed information on your model of iCN and whether you require a Map Product Key, see "Which maps are already installed on my iCN?" on page 110.

How do I use preactivated memory cards?

Preactivated maps are also available for purchase separately on memory card. To use a preactivated memory card, insert the card in the Memory Card slot and Drive-Away™. For more information, see "How do I use a memory card with my iCN?" on page 111.

Which map should I install?

If you are not sure which map contains the town or city that you want to install, you can use the *Find City* window to identify the correct map. For more information, see "How do I know which map contains a particular city or town?" on page 86.

How do I install maps from CD?

1. Open SmartST Desktop, if it is not already open:
Start > All Programs > Navman > SmartST Desktop 2006
2. Insert a SmartST Map CD into your computer CD drive.
 - The preactivated maps that are ready to be installed to your iCN are **light green**.
 - The maps on the CD that require activation before being installed to your iCN are **light blue**.



If your computer opens Windows Explorer when the CD is inserted, close the Windows Explorer window.

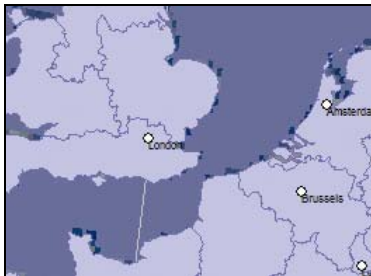

3. Complete the following:

If the map to be installed is ...	Then ...
light green	go to step 6.
light blue	the map needs to be activated via the Internet before it can be installed; continue to step 4.

4. If you connect to the Internet via a dial-up connection, connect to the Internet now.

5. Follow the prompts to activate your Map Product Key, including:

- Enter the Map Product Key from the back of the enclosed CD box when prompted.



- Your computer will connect to the Internet and activate your Map Product Key.
- When activation has completed, the map will change colour to **light green**; continue to step 6.

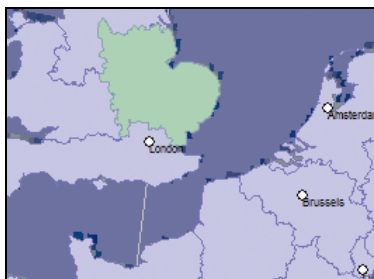

6. Click the map you want to install to your iCN. The map will change colour to **dark green** to indicate it has been selected. The map is now listed in the **Review Selected Maps** section of the **Add Maps** tab.

- To deselect a map, click the map again.



You may need to install multiple maps to cover the desired geographical area.

7. Complete the following:

If you want to ...	Then ...
select a light green map	go back to step 6.
select a light blue map	the map needs to be activated via the Internet before it can be installed; go back to step 4.
select a Major Road Network map	select the check box in the Step 1: Select Maps section. For information on Major Road Network maps, see "What is a Major Road Network map?" on page 87.
install the selected maps to your iCN	continue to step 8.

8. In the **Step 3: Install Maps** section, select the destination media for the selected maps, for example, memory card or iCN internal memory.
9. Click **Install Maps**.
When they have been installed, the map or maps will change colour to **yellow**.

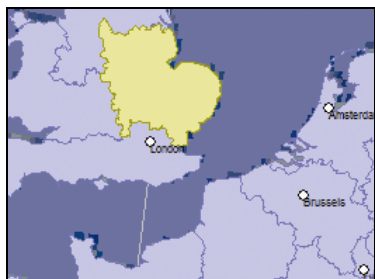

10. To use your iCN, disconnect the USB cable.



WARNING Do not disconnect the USB cable from the iCN **USB Socket** until the **Globe** has refreshed, and the installed map or maps have changed colour to **yellow**.

How do I remove maps from my iCN?

1. Open SmartST Desktop, if it is not already open:
Start > All Programs > Navman > SmartST Desktop 2006
2. Click the **View/Remove Tabs** tab.
The **View/Remove** tab will open, displaying a list of installed maps.
3. Select the name from the list of the map that you want to remove, then click **Remove**.
4. Confirm that you want to remove the selected map when prompted.
The map is removed from your iCN.

How do I know which map contains a particular city or town?

Use the *Find City* window to find the map that contains a particular city or town.

1. On the **Map** menu, select **Find City**.
The *Find City* window will open.



2. Type the name of the city or town in the **City Name** field.
The list of available cities will reduce to match your search.
3. Double-click the name of the city or town.
The **Globe** will rotate to centre on the selected city or town and  will mark the city or town location.

What is a Major Road Network map?

Continuous continental navigation

Major Road Network maps allow you to seamlessly navigate between installed maps without installing maps of all regions along your route. Each Major Road Network map covers a large area, such as Western Europe or Canada and the United States (continental), and contains main roads that connect cities and towns. You can select a road or Point of Interest on the Major Road Network map as your departure point or destination.

All Major Road Network maps:

- contain roads and ferry connections of high national and international importance.
- use less memory than would be necessary to install all equivalent detailed maps.
- exclude smaller roads and have a reduced level of geographical detail.

Major Road Network map table

Region of Purchase	Model	Description
Australia or New Zealand	All	Does not require a Major Road Network map, as detailed maps of either Australia or New Zealand are pre-installed on your iCN.
Canada and United States	All	Does not require a Major Road Network map, as detailed maps of Canada and the United States (continental) are pre-installed on your iCN.
Western Europe	iCN 720	A Major Road Network map of Western Europe is pre-installed on your iCN.
	iCN 750	Does not require a Major Road Network map, as detailed maps of Western Europe are pre-installed on your iCN.

How do I install or reinstall a Major Road Network map?

Major Road Network maps can be installed to a new memory card or reinstalled to your iCN hard drive using SmartST Desktop. For more information, see "How do I install maps from CD?" on page 83.



How do I install Custom Points of Interest?

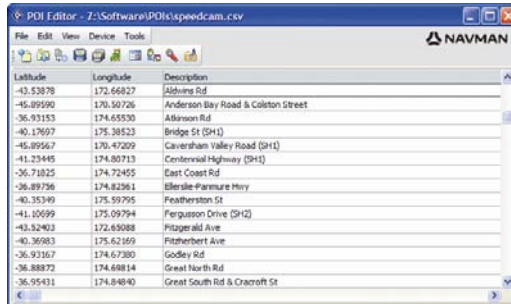

You can create custom Points of Interest (POIs) by using the POI Editor in two ways:

- by creating your own POI files, or
- by using compatible POI files, such as safety camera locations, downloaded from the Internet.

Various POI files are available for download for free or by subscription from third-party websites¹. Ensure that downloaded POI files are in .csv (Comma Separated Values) format.

A maximum of 25 custom POI files can be saved on your iCN. Each file corresponds to a POI category; for example, **Hotels.csv** will be listed in your iCN as the **Hotels** category.

POI Alerts

Custom POI categories can be set to enable a warning sound or visual warning when in close proximity. For more information, see "POI Alerts" on page 108.

¹ Navman is not responsible for the content or accuracy of the information or the reliability or availability of these websites. The use of information regarding safety camera locations may be subject to local laws in the country of use. You are responsible for checking that you can use the information in your country or in the country where the information will be used.



How do I create a Custom POI file?

Complete the following steps to create or edit a custom POI file containing the latitude and longitude of individual POIs. The file will be saved on your computer in .csv (Comma Separated Values) format.

When you have finished creating or editing the file, you can copy it to your iCN. For more information, see "How do I copy a Custom POI file to my iCN?" on page 90.

Map → Points of Interest

1. Complete one of the following:

If you want to ...	Then ...
create a new POI file	<ul style="list-style-type: none"> Click . The <i>POI File Name</i> window will open. Type a name for the file in the File Name box, then click OK. <hr/> <p> The file name will be used as both the name of the CSV file and the category name. The file name cannot include spaces. The category name will consist of the first 8 characters.</p>
open an existing POI file	<ul style="list-style-type: none"> Click . The <i>Open</i> dialogue box will open. Select the POI file from your local or network drive, then click Open. The POIs contained in the POI file are listed.

2. Complete the following to add or edit a POI:

a) On the **Edit** menu, click **New** to create a new POI, or **Modify** to edit the selected POI. The *POI Details* window will open.

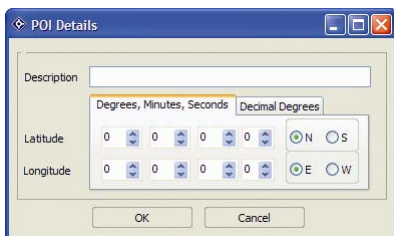

b) Type a description for the POI in the **Description** box.

c) Complete one of the following:

If you know ...	Then ...
the degrees, minutes and seconds of the POI	<p>on the Degrees, Minutes, Seconds tab, type or select the degree, minute and second of the POI latitude in the Latitude boxes and the POI longitude in the Longitude boxes.</p> <p>Select N, S, E or W to designate the hemisphere of the co-ordinates.</p>

If you know ...	Then ...
the decimal degrees of the POI	on the Decimal Degrees tab, type the POI latitude in the Latitude box and the POI longitude in the Longitude box. Select N , S , E or W to designate the hemisphere of the co-ordinates.

- d) Click **OK** to save the POI.
3. Repeat step 2 until all POIs have been added to the POI file.
4. Click .
The POI file is saved.

You are now ready to copy your custom POI file to your iCN. For more information, see "How do I copy a Custom POI file to my iCN?" on page 90.

How do I copy a Custom POI file to my iCN?







Map Points of Interest

1. Open or create a POI file.
2. Click .
The *POI Options* window will open.



You can open the *POI Options* window at any time by clicking .

3. Modify the POI settings as required:

If you want to...	Then...
edit the POI category name	type the name of the POI category in the POI Name field.  The file name cannot include spaces. The category name will consist of the first 8 characters.
activate the POI to enable proximity warnings	select the Active check box.  If you do not activate the POI, you will not be able to configure the Alert settings.
enable a visual warning when a POI of this category is in close proximity	select the Visual Alert check box.
enable a warning sound when a POI of this category is in close proximity	select the Audio Alert check box.
change the units used to measure distance for this POI category	select either the Metric or Imperial option.
select the distance from a POI of this category at which the visual warning should display or the warning chime should sound	select the distance from the Distance box.
indicate the priority of a POI of this category when one or more additional POIs are in the same vicinity	move the POI Visibility Level slider left for lower priority or right for higher priority.
select an icon to display on the map screens for POIs of this category	type the path to the icon file to be used to represent the POI type, in the Icon File box, or click Browse to select the icon file from your local or network drive. Once you have located the icon file, select it and click Open . The icon file must be a bitmap (.bmp) graphic with a minimum size of 6x6 pixels and a maximum size of 32x32 pixels.  If you do not select a custom icon, a default icon will display.
select a custom sound alert file to play when a POI of this category is in close proximity	select a sound file from the list. The list of sounds is formed from default sound files and sound files that you have added using <i>My Sounds Admin</i> . For more information, see "How do I add sound files to My Sounds Admin?" on page 92. Click  to include a WAVE (.wav) sound file from your computer or network. Click  to play the selected sound file.  If you do not select a custom sound file, a default sound alert will play.



4. Click **OK** to save the POI settings.
The *Copy POIs* window will open.
5. Select the destination media for the selected maps; for example, memory card or iCN internal memory, then click **Copy POI**.
The POI file is saved to the iCN or memory card as a POI category.

How do I add sound files to My Sounds Admin?

My Sounds Admin is used to compile a list of sound files for you to select an audible alert from when editing the POI file options.

Map → Points of Interest

1. Click .
The *My Sounds Admin* window will open.
2. Add, delete or play sound files as required:

If you want to...	Then...
add a sound file	click  to select a WAVE (.wav) sound file from your local or network drive. Once you have located the sound file, select it and click Open .
delete a sound file	select the sound file from the list and click  .
play a sound file	select the sound file from the list and click  .

3. Click **OK** to save your list of sound files and close the *My Sounds Admin* window.

How do I delete a Custom POI File from my iCN?

Map → Points of Interest

1. Click .
The *Manage POI Files* window will open, displaying a list of custom POI files installed on your iCN.
2. Click the **File Name** or **Size** of the POI file to delete.
3. Click **Delete**.
The file is removed from the list, but is not yet deleted.
4. To select another file to delete, go back to step 2; otherwise, continue to step 5.
5. Click **OK** and accept the changes.
The selected file or files are deleted.

How do I backup my iCN?



You can save backups of the following information, and later restore them to your iCN:

- Favourites and My Home
- Preferences, including Point of Interest and photo preferences
- Multi-stop trips
- Recent locations.

How do I Backup my iCN?

1. On the **File** menu, select **Backup**.
The *Backup/Restore* window will open.
2. Click **New Backup**.
The *New Backup* window will display.
3. Click **OK**.
The *New Backup* window will close and your backup will be saved to your computer. The backup will be listed on the *Backup* window.
4. Close the *Backup/Restore* window.

How do I Restore a Backup to my iCN?

1. On the **File** menu, select **Restore**.
The *Backup/Restore* window will open.
2. Select the backup from the list, then click **Restore**.
The backup will be restored to your iCN.
3. Close the *Backup/Restore* window.

How do I Delete a Backup?

1. On the **File** menu, select **Backup**.
The *Backup/Restore* window will open.
2. Select from the list the backup to delete.
3. Click **Delete**, then click **OK**.
The backup is deleted.
4. Close the *Backup/Restore* window.



Reference

In this section





What can I customize?	95
Which maps are already installed on my iCN?	110
How do I use a memory card with my iCN?	111
Address search rules	113
Street types - Europe	114
Points of Interest categories	118
Specifications	120

What can I customize?

There are a number of different customization options available to enhance your navigation experience.



The *Preferences* menu is shown below, and is accessed by pressing the  button on your iCN, then tapping .



Element	Description
	Options to control aspects of your route; for example, indicating a preference for motorways.
	Displays the SmartST <i>Tutorial</i> .
	Options to control how the iCN functions; for example, power and language controls.
	Options to control the screen brightness, touchscreen alignment and measurement preferences.
	Legal, version and copyright information.

Route Preferences

You can enhance your navigation experience by modifying aspects of your route and route calculation.

The first route preference screen is the *Route Calculation* screen, and is accessed by tapping  on the *Preferences* menu. Tap  to display the other route preference screens.

Route Calculation

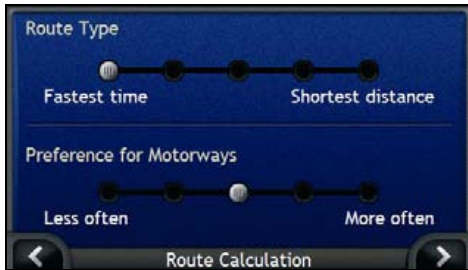

Complete the following:

If you want to...	Then...
change the route type	<p>move the Route Type slider towards Fastest time to give more weighting to the fastest time when calculating a route.</p> <p>move the Route Type slider towards Shortest distance to give more weighting to the shortest distance when calculating a route.</p>
change the preference for motorways	<p>move the Preference for Motorways slider towards Less often to use roads other than motorways where possible when calculating a route.</p> <p> This option may not completely remove Motorways from a route.</p> <p>move the Preference for Motorways slider towards More often to use motorways where possible when calculating a route.</p>

- Your preferences are automatically saved.
- Tap  to return to the previous screen.

Road Types

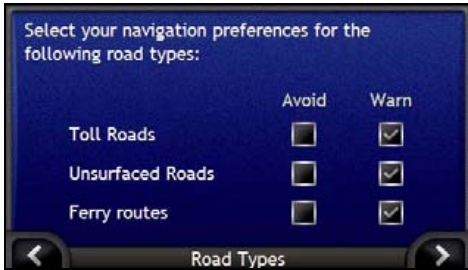

Complete the following:

If you want to...	Then...
avoid toll roads	select the Toll roads check box in the Avoid column.
receive a warning if your route includes toll roads	select the Toll roads check box in the Warn column. The warning will display at the start of your trip.
avoid unsurfaced roads	select the Unsurfaced roads check box in the Avoid column.
receive a warning if your route includes unsurfaced roads	select the Unsurfaced roads check box in the Warn column. The warning will display at the start of your trip.
avoid ferry routes	select the Ferry routes check box in the Avoid column.
receive a warning if your route includes ferry routes	select the Ferry routes check box in the Warn column. The warning will display at the start of your trip.

- Your preferences are automatically saved.
- Tap to return to the previous screen.

Driving Alerts



Complete the following:

If you want to...	Then...
enable a warning chime when travelling at or above a designated speed	select the speed in the Alert me when my speed exceeds check box.
select your preferred speed	select your preferred speed from the Speed box.
enable a visual warning if the <i>Main Menu</i> screen is accessed in a moving vehicle	select the Warn me not to operate my iCN while driving check box.

- Your preferences are automatically saved.
- Tap  to return to the previous screen.

Demonstration and Logging

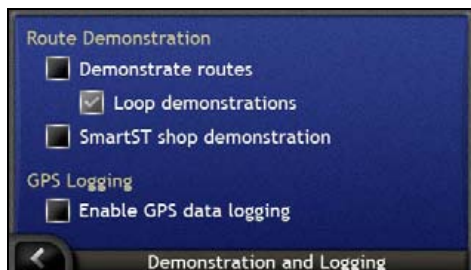

Complete the following:

If you want to...	Then...
enable the route demonstration	select the Demonstrate routes check box. This allows you to plan and view a route without a GPS fix.
enable the route demonstration to play repeatedly	select the Loop demonstrations check box.
enable a shop demonstration of SmartST to be played	select the SmartST shop demonstration check box. After a 10-second delay, the route demonstration will navigate between your first and second Favourite.
enable GPS data logging (only to be used if required by Navman Customer Support)	contact Navman Customer Support, as we recommend this feature be used only under the supervision of a Navman technician.

- Your preferences are automatically saved.
- Tap  to return to the previous screen.

Tutorial

The *Tutorial* displays when you turn your iCN on, unless you have cleared the **Show on start-up** check box.

You can view the *Tutorial* at any other time:



- To prevent the *Tutorial* from displaying again on startup, tap the **Show on start-up** check box to clear it.
- To move forward through the *Tutorial* screens, tap . To revisit the previous screen, tap .

When you have finished the *Tutorial*, the *Preferences* menu will display.

System Preferences

You can enhance your navigation experience by modifying aspects of the way that your iCN functions.

The *System Preferences* menu is shown below, and is accessed by tapping on the *Preferences* menu.



Element	Description
	Options to control the screen brightness and touch screen alignment.
	An option to reset the GPS signal.
	Options to control the way that power to the unit is used; for example, the time to elapse before the unit is automatically turned off.
	Options to control the language used on your iCN, and voice guidance.
	Options to delete saved information.
	Options to control what is displayed when your iCN is turned on.

Screen Display



For further information, see "Screen Display" on page 104.

GPS Status

Signals are transmitted by Global Positioning System (GPS) satellites orbiting the Earth. The *GPS Status* screen provides a visual representation of the information being received.

Latitude and longitude are displayed, along with ground speed, the heading in degrees and a north-pointing compass. The strength of each satellite is displayed on a bar chart.

For more information on GPS, see "How do I navigate with GPS?" on page 22.

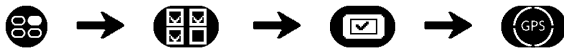

The satellites available from your current position are shown as grey, red and green coloured bars:

Bar Colour	Description
Grey	No signal at all
Red	A valid signal, but not being used to fix your position
Green	A valid signal being used to fix your position

Resetting your GPS fix

On occasion, the GPS fix may need to be reset. This may occur if the receiver has been transported a large distance since last being used; for example, to a different country, and is still trying to establish the previous position.

Complete the following:

If you want to...	Then...
reset the GPS	tap Reset GPS .

Power

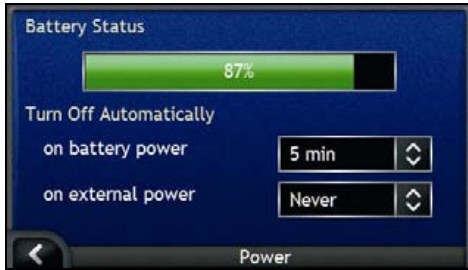

The **Battery Status** bar shows the percentage of power left in the iCN battery; the word **Charging** will display when the battery is charging from an external power source. To charge the battery, see "Internal battery" on page 16.

Complete the following:

If you want to...	Then...
change the time to elapse before turning off, when using battery power	tap the on battery power box and select a time to elapse before turning off; select Never for the iCN to not turn off automatically unless battery power is very low.
change the time to elapse before turning off, when using external power	tap the on external power box and select a time to elapse before turning off; select Never for the iCN to never turn off automatically.

- Your preferences are automatically saved.
- Tap to return to the previous screen.

Language



Complete the following:

If you want to...	Then...
change the on-screen language	select your preferred language from the Language box and tap OK . Your language preference is saved and the map screen is displayed.
enable voice guidance instructions while driving to your destination	select the Enable voice guidance checkbox.
change the voice scheme	select your preferred voice scheme from the Voice Guidance box.  Only voice schemes that are compatible with the chosen language are displayed.

- Your preferences are automatically saved.
- Tap  to return to the previous screen.

Saved Information

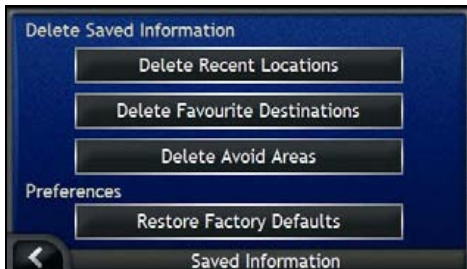

Complete the following:

If you want to...	Then...
delete recent locations	tap Delete Recent Locations .
delete Favourites	tap Delete Favourite Destinations .
delete avoid areas	tap Delete Avoid Areas .
restore factory default settings	tap Restore Factory Defaults .

- When the warning dialog box displays, tap **Yes**.
- Tap  to return to the previous screen.

Start-up

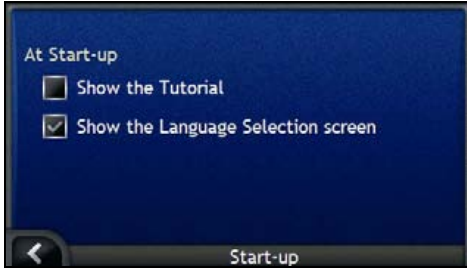

Complete the following:

If you want to...	Then...
show the <i>Tutorial</i> when you turn on your iCN	select the Show the Tutorial checkbox.
show the <i>Language Selection</i> screen when you turn on your iCN	select the Show the Language Selection screen checkbox.

- Your preferences are automatically saved.
- Tap to return to the previous screen.

Display Preferences

You can enhance your navigation experience by modifying aspects of the way that your iCN displays information.

The *Display Preferences* menu is shown below, and is accessed by tapping on the *Preferences* menu.



Element	Description
	Options to control the screen brightness and touch screen alignment.
	Options to control the general map presentation and colour scheme.

Element	Description
	Options to control measurement of time, position and distance.

Screen Display

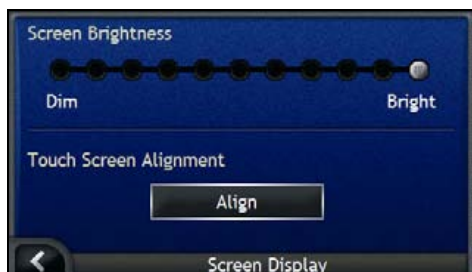
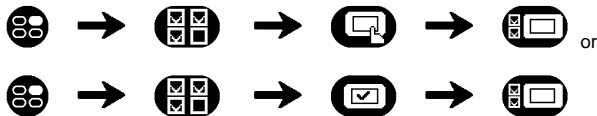

Complete the following:

If you want to...	Then...
change the screen brightness	<p>move the Screen Brightness slider towards Bright to increase screen brightness.</p> <p>move the Screen Brightness slider towards Dim to decrease screen brightness.</p> <hr/> <p> Warning: The iCN can heat up when the <i>Brightness</i> scale is set above 70% - i.e., when more than seven rectangles are coloured - therefore, use lower brightness whenever acceptable.</p> <hr/> <p> The screen brightness can also be adjusted using the remote control (may be sold separately).</p>
align the touch screen	<p>tap Align and follow the prompts.</p> <hr/> <p> The prompts are available in English only.</p>

- Your preferences are automatically saved.
- Tap to return to the previous screen.

Map Display



Complete the following:

If you want to...	Then...
change the Colour scheme	select your preferred scheme from the Map Colour Scheme box.
improve screen contrast in light or dark conditions	select either the Day hues or the Night hues option.
enable automatic zooming during navigation	select the Auto-zoom on Main Map screens check box. If selected, the <i>3D Map</i> and <i>2D Map</i> screens will automatically zoom in or out, depending on your speed, to allow optimal route-viewing.
display North at the top of the <i>2D Map</i> screen	select the Keep North at top of 2D Map screen check box.
display "no entry" icons on "no entry" roads on the <i>2D Map</i> and <i>3D Map</i> screens	select the Show no-entry road signs check box.

- Your preferences are automatically saved.
- Tap  to return to the previous screen.

Measurements

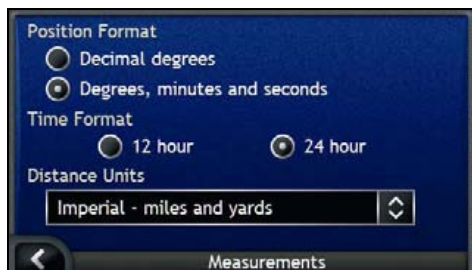

Complete the following:

If you want to...	Then...
change the Position Format	select either the Decimal degrees or the Degrees, minutes and seconds option.
change the local time offset	select either the 12 hour or 24 hour option for time-format.
change the distance units ²	select your preferred distance units measurement from the Distance Units box.

- Your preferences are automatically saved.
- Tap  to return to the previous screen.





² Only available when UK English, AU English or US English language is selected.

POI Preferences

You can enhance your navigation experience by modifying aspects of the way that your iCN displays and manages POIs.

The *POI Menu* is shown below, and is accessed by tapping  on the *Preferences* menu.



Element	Description
	Options to set warning chimes and visual warnings for custom POI categories that will activate within a chosen distance-radius of your location.
	Options to control the display of POIs on your iCN.
	Options to search for a POI by name.
	Options to search for a POI in a distance-radius of your location.

POI Alerts

The POI Alert preferences allow you to set warning chimes and visual warnings for custom POI categories that will activate within a chosen distance-radius of your location. For example, a warning chime will sound or a visual warning will display when an active POI is in the vicinity (set by the **Warning Distance** preferences), but not necessarily on your route.



Custom POIs must first be installed on your iCN using SmartST Desktop before they can be set as active POIs.



1. Tap a custom POI category.
The activation preferences for the selected POI category will display.

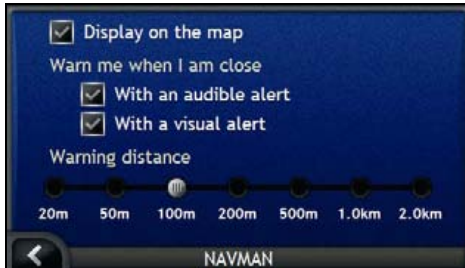

2. Complete the following:

If you want to...	Then...
display the POI on the map	select the Display on the map check box.
enable a warning chime when the POI is in close proximity	select the With an audible alert check box.
enable a visual warning when the POI is in close proximity	select the With a visual alert check box.
select the distance at which the warnings will activate	move the Warning distance slider to select the distance at which the warnings will activate.

- Your preferences are automatically saved.
- Tap to return to the previous screen.

How do I enable Points of Interest?

Points of Interest (POI) in a region are grouped into categories. You may either choose to display (or hide) icons of all POI categories on the map screens, or to selectively display desired icons chosen from the list of POI categories.

For example, you may be only interested in entertainment venues and want to disable other POI categories such as schools.

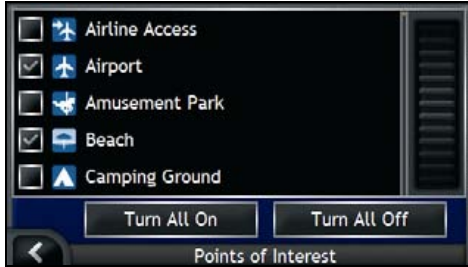

Complete the following:

If you want to...	Then...
display all POI icons (ie, icons from all POI categories)	tap Turn all on.
display no POI icons	tap Turn all off.
select a specific POI category icon for display on the map screens	select the desired POI category checkbox; repeat until all desired POI categories are selected.

- Your preferences are automatically saved.
- Tap  to return to the previous screen.

Which maps are already installed on my iCN?

Region of Purchase	Model	Description
Australia or New Zealand	iCN 750	<p>Preactivated maps of Australia or New Zealand are preinstalled on your iCN.</p> <p>You can reinstall your maps from the enclosed CD, if necessary, using SmartST Desktop.</p> <p>Preactivated maps of other countries are available for purchase on memory card.</p>
Canada and United States	iCN 750	<p>Preactivated maps of Canada and the United States are preinstalled on your iCN.</p> <p>You can reinstall your maps from the enclosed CDs, if necessary, using SmartST Desktop.</p> <p>Preactivated maps of other countries or states are available for purchase on memory card.</p>
Western Europe, including the United Kingdom	iCN 720	<p>Preactivated maps of one or more countries are preinstalled on your iCN.</p> <p>Maps of Western Europe are on the enclosed CDs. You can reinstall your preactivated maps from the enclosed CDs, if necessary, using SmartST Desktop; however to install a non-activated map, you must first purchase a Map Product Key.</p> <p>Alternatively, preactivated maps are available for purchase on memory card.</p>
	iCN 750	<p>Preactivated maps of Western Europe are preinstalled on your iCN.</p> <p>You can reinstall your maps from the enclosed CDs, if necessary, using SmartST Desktop.</p> <p>Preactivated maps of other countries are available for purchase on memory card.</p>

How do I use a memory card with my iCN?

Your iCN has a memory card slot (■) for an SD or MMC memory card (not included) that can be used for storing maps or photos.

Map Storage

If there is not enough space in your iCN internal memory for a required map, you can install maps to your memory card using SmartST Desktop. For information on installing maps, see "How do I install maps on my iCN?" on page 83.

Alternatively, preactivated maps are available for purchase separately on memory card.

To navigate using maps on a memory card, ensure the card is in the memory card slot before you set your destination, then Drive-Away™.

Photo Album

Photos can be copied from the *Album* on your iCN to the *My Pictures* folder on your memory card. The first time a photo is copied to the memory card, the following folders will be created:

E:\My Documents\My Pictures, where "E" is the letter assigned to your memory card drive or reader.

All photos in *My Pictures* are part of the same photo album and can be viewed on your iCN. For more information on viewing albums and copying photos between albums, see "Album management" on page 59.

Once a photo has been copied to the photo album on your memory card, you can then use the card with your computer to save, e-mail or print the photos, or take the memory card to a digital photo retailer for printing.

How do I insert a Memory Card?

Holding the card by the edges, gently insert it into the  slot with the label facing the front of the iCN.

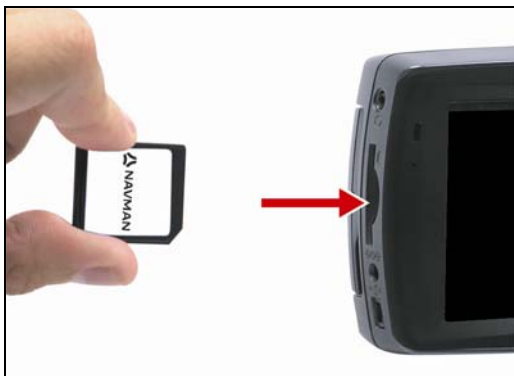

CAUTION Do not to apply pressure to the centre of the memory card.

How do I remove a Memory Card?

Before removing the memory card, turn off the iCN. Next, gently push the top edge of the card to release it, and pull it out of the slot.

Address search rules

The following rules apply when searching for a destination in Europe:

Street names with dates or numbers

If a street name contains a date or a number, search by the first number:

Example 1: If searching for "**Faubourg du 13 Juillet 1920**", search by "**13**".

Example 2: If searching for "**Avenue du 14 Avril 1914**", search by "**14**".

Example 3: If searching for "**Rue de la 1^{ere} Armée**", search by "**1**".

If a highway or motorway designation contains a number, search by the first character of the designation:

Example 1: If searching for "**A-6**", search by "**A**".

Example 2: If searching for "**E55**", search by "**E**".

Example 3: If searching for "**Strada Provinciale 168**", search by "**168**".

Streets named after people

If a street name is a person's name (including at least a first and last name), search by the first name:

Example 1: If searching for "**Rue Albert Mathieu**", search by "**Albert**".

Example 2: If searching for "**Fred Archer Way**", search by "**Fred**".

Example 3: If searching for "**Franz Grillparzer-Strasse**", search by "**Franz**".

Postcodes in the Netherlands

When searching by postcode in the Netherlands, type the postcode without the last two letters.

Example: If searching for "**3514 BN**", search by "**3514**".

Street types - Europe



Belgium and Switzerland each list street types and their abbreviations in three languages.















Country	Street Type	Abbreviation
Austria	BOULEVARD CHAUSSEE PLATZ STRASSE	BVD CH PL STR
Belgium (Dutch)	BAAN BERG DREEF LAAN MARKT PARK PLEIN SQUARE STEENWEG STRAAT	BN BG DR LN MKT PK PL SQ STWG STR
Belgium (French)	AVENUE BOULEVARD CHAUSSÉE IMPASSE MONT MONTAGNE PLACE ROUTE ROUTE NATIONAL RUE SQUARE	AVE BVD CH IMP MT MT PL RTE RN R. SQ
Belgium (German)	CHAUSSEE PLATZ STRASSE	CH PL STR
Finland	GATAN GATE GATA VÄGEN VÄG	GT GT GT V. V.
France	ALLEE AVENUE BOULEVARD CHAUSSÉE DOMAINE FAUBOURG IMPASSE MONT MONTAGNE PASSAGE	ALL AVE BVD CH DOM FG IMP MT MT PAS

























Country	Street Type	Abbreviation
	PLACE QUARTIER ROND-POINT ROUTE ROUTE NATIONALE RUE SQUARE TRAVERSE	PL QU RPT RTE RN R. SQ TRA
Germany	BOULEVARD CHAUSSEE PLATZ STRASSE	BVD CH PL STR
Ireland	AVENUE BOULEVARD CENTRE CRESCENT PLACE ROAD ROUTE SQUARE STREET YARD	AVE BVD CTR CR PL RD RTE SQ ST YD
Italy	CONTRADA CORSO FRAZIONE LARGO PIAZZA PIAZZALE STRADA STATALE SUPERSTRADA VIA VIALE	C.DA C.SO FR LGO P.ZA P.LE SS SS V. VL
Luxembourg	ALLÉE AVENUE BOULEVARD CHAUSSÉE DOMAINE FAUBOURG IMPASSE MONT MONTAGNE PASSAGE PLACE QUARTIER ROND-POINT ROUTE ROUTE NATIONALE RUE SQUARE	ALL AVE BVD CH DOM FG IMP MT MT PAS PL QU RPT RTE RN R. SQ

Country	Street Type	Abbreviation
	TRAVERSE	TRA
Netherlands	BOULEVARD DIJK DWARSSTRAAT DWARSWEG GRACHT KADE KANAAL LAAN LEANE LOANE PARK PLANTSOEN PLEIN SINGEL STRAAT STRJITTE STRAATWEG WEG	BVD DK DWSTR DWWG GR KD KAN LN LN LN PK PLNTS PLN SNGL STR STR STRWG WG
Norway	GATA GATE PLASSEN VEGEN VEI	GT GT PL V. V.
Portugal	AVENIDA BAIRRO CALÇADA CAMINHO ESTRADA LARGO LARGUINHO PRAÇA QUARTO QUARTA QUINTA RUA SÃO SANTA SANTO	AVE BA CC CAM EST LGO LARG PR QT QT QU R. S. S. S.
Spain	AVENIDA CALLE CALLEJÓN CAMINO CARRETERA GLORIETA PASEO PLAZA RAMBLA RONDA	AVE C/ CJ CM CR G P.O P. RBLA RD

Country	Street Type	Abbreviation
Switzerland (German)	BOULEVARD CHAUSSEE PLATZ STRASSE	BVD CH PL STR
Switzerland (French)	AVENUE CHAUSSÉE IMPASSE MONT MONTAGNE PLACE QUARTIER ROUTE ROUTE NATIONAL RUE SQUARE	AVE CH IMP MT MT PL QU RTE RN R. SQ
Switzerland (Italian)	CONTRADA CORSO FRAZIONE LARGO PIAZZA PIAZZALE VIA VIALE	C.DA C.SO FR LGO P.ZA P.LE V. VL
United Kingdom	AVENUE BOULEVARD CENTRE CRESCENT PLACE ROAD ROUTE SQUARE STREET	AVE BVD CTR CR PL RD RTE SQ ST

Points of Interest categories

Icon	Description	Icon	Description
	Airline Access		Airport
	Amusement Park		Arts or Cultural Centre
	Bank		Beach
	Boat Ramp		Breakdown Service, Car Repair Facility
	Building		Camping Ground
	Car Dealer		Caravan Park
	Cash Dispenser		Casino
	Centre of Settlement		Church
	Cinema		City Centre
	College or University		Company
	Concert Hall, Music Centre, Opera		Convention Centre, Exhibition Centre
	Courthouse		Cultural Centre
	Dentist		Doctor
	Drive-Through Bottle Shop		Embassy
	Emergency Medical Service		Ferry Terminal
	Fire Station		Frontier Crossing
	General POI		Golf course
	Government Office		Hospital/Polyclinic
	Hotel or Motel		Ice Skating Rink
	Important Tourist Attraction		Leisure Centre, Sports Centre
	Library		Military Cemetery
	Monument		Mountain Pass
	Mountain Peak		Museum
	Night life		Open Parking Area
	Park and Recreation Area		Petrol station

Icon	Description	Icon	Description
	Pharmacy		Place of Worship
	Police Station		Post Office
	Railway Station		Rent-a car Parking
	Rest Area		Restaurant Area
	Scenic or Panoramic View		School
	Shop		Shopping Centre
	Stadium		Swimming Pool
	Tennis Court		Theatre
	Tourist Information Office		Travel Agency
	Vehicle Equipment Provider		Veterinarian
	Water Sports		Winery
	Yacht Basin		Zoological park (zoo)

Specifications

Specifications

General

Operating voltage: DC5V
 Operating voltage range: DC10.8–16.0V
 Maximum operation current: 2.5A
 Grounding system: car battery negative pole

AC adapter

Operating voltage range: AC85-265V
 Maximum operation current: 2.5A

Car adapter

Operating voltage: DC12V
 Operating voltage range: DC8–24V
 Maximum operation current: 2.5A

TFT monitor

Screen diagonal: 4 inches (105mm)
 Usable display area: 87.84mm (W) x 49.8mm (H)
 Resolution: WQVGA 480 (W) x 272 (H) pixels
 Brightness: 180cd/m (centre brightness after 30 minutes)
 Top viewing angle: 58°
 Bottom viewing angle: 52°
 Horizontal viewing angle: +66°

Dimensions

Dimensions: 136mm (W) x 77mm (H) x 32mm (D)
 Net weight: 300g

Remote control

Frequency range: 2.4 – 2.483GHz
 Nominal output power: 0 dBm
 Modulation: FSK

Camera

Effective Pixels: 1.3 M
 Resolution: 1304 x 968 SXGA
 Aperture range: F 4.9mm

Battery

Capacity: 1350mAH (iCN 720)
 Capacity: 1890mAH (iCN 750)
 Type: Lithium-ion

Hardware

Processor: Intel PXA270 312Mhz
 RAM: 64MB
 ROM: 64MB
 Internal CF card: 512MB (iCN 720)
 HDD: 4GB (iCN 750)
 SD/MMC Memory Expansion

Environment

Operating temperature: -10°C–+60°C
 Storage temperature: -30°C–+70°C
 Operating humidity: 45%–80% RH
 Storage humidity: 30%–90% RH
 EMC: e-Mark, FCC, CE, C Tick, RSS-210
 Operating shock: 4G
 Non-operating shock: 75G

Support information

Support for Australia

Navman Australia Pty Ltd
PO Box 479
Gladesville, NSW 2111
Australia

Support: <http://support.navman.com>
Website: <http://www.navman.com>

Support for New Zealand

Navman New Zealand
PO Box 68-155 Newton
Auckland
New Zealand

Support: <http://support.navman.com>
Website: <http://www.navman.com>

Support for Europe

Navman Europe Ltd
4G Gatwick House
Peeks Brook Lane, Horley
Surrey RH6 9ST
United Kingdom

Support: <http://support.navman.com>
Website: <http://www.navman.com>

Support for US and Canada

Navman USA Inc
5275 Capital Boulevard
Raleigh, NC 27616-2925
United States of America

Phone: 866-9-NAVMAN
Support: <http://support.navman.com>
Website: <http://www.navman.com>

Notes



Free Manuals Download Website

<http://myh66.com>

<http://usermanuals.us>

<http://www.somanuals.com>

<http://www.4manuals.cc>

<http://www.manual-lib.com>

<http://www.404manual.com>

<http://www.luxmanual.com>

<http://aubethermostatmanual.com>

Golf course search by state

<http://golfingnear.com>

Email search by domain

<http://emailbydomain.com>

Auto manuals search

<http://auto.somanuals.com>

TV manuals search

<http://tv.somanuals.com>