

# **NEC**

## **MultiSync Hivid 3500 Projector Large Screen MultiSync Projection System**

### **User's Manual**

**Model number: XL-3500**

**CAUTION:** To turn off main power, be sure to remove the plug from power outlet. The power outlet socket should be installed as near to the equipment as possible, and should be easily accessible.

### Precautions

Please read this manual carefully before using your NEC MultiSync Hivid 3500 Projector and keep the manual handy for future reference.

### 3. GSGV Acoustic Noise Information Ordinance:

The sound pressure level is less than 70 dB(A) according to ISO 3744 or ISO 7779.

### WARNING

TO PREVENT FIRE OR SHOCK HAZARDS, DO NOT EXPOSE THIS UNIT TO RAIN OR MOISTURE. ALSO DO NOT USE THIS UNIT'S POLARIZED PLUG WITH AN EXTENSION CORD RECEPTACLE OR OTHER OUTLETS, UNLESS THE PRONGS CAN BE FULLY INSERTED. REFRAIN FROM OPENING THE CABINET AS THERE ARE HIGH-VOLTAGE COMPONENTS INSIDE. REFER SERVICING TO QUALIFIED SERVICE PERSONNEL.

### AVERTISSEMENT

POUR EVITER UN FEU OU UN RISQUE D'ELECTROCUTION NE PAS EXPOSER CET ENSEMBLE A LA PLUIE OU A L'HUMIDITE; DE MEME, NE PAS BRANCHER LA PRISE POLAIRE AVEC UNE RALLONGE A MOINS QUE LES DENTS DE LA PREMIERE NE S'Y INSERENT PLEINEMENT. EVITER D'OUVRIER LE COFFRET CAR IL Y A, A L'INTERIEUR, DES COMPOSANTS SOUMIS A UNE HAUTE-TENSION; POUR LES REPARATIONS, S'ADRESSER A UN PERSONNEL QUALIFIE.

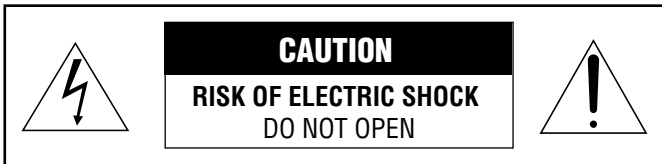

**CAUTION:** TO REDUCE THE RISK OF ELECTRIC SHOCK, DO NOT OPEN COVER. NO USER-SERVICEABLE PARTS INSIDE. REFER SERVICING TO QUALIFIED SERVICE PERSONNEL.

**ATTENTION:** POUR EVITER LES RISQUES D'ELECTROCUTION, NE PAS OUVRIR LE COUVERCLE. AUCUN DES ELEMENTS INTERNES NE DOIT ETRE REPARÉ PAR L'UTILISATEUR. NE CONFIER L'ENTRETIEN QU'A UN PERSONNEL QUALIFIE.

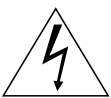

This symbol warns the user that uninsulated voltage within the unit may have sufficient magnitude to cause electric shock. Therefore, it is dangerous to make any kind of contact with any part inside of this unit.

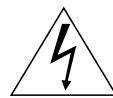

L'éclair fléché dans un triangle équilatéral est destiné à avertir l'utilisateur de la présence, dans l'appareil, d'une zone non-isolée soumise à une haute-tension dont l'intensité est suffisante pour constituer un risque d'électrocution.



This symbol alerts the user that important literature concerning the operation and maintenance of this unit has been included. Therefore, it should be read carefully in order to avoid any problems.



Le point d'exclamation dans un triangle équilatéral est destiné à attirer l'attention de l'utilisateur sur la présence d'informations de fonctionnement et d'entretien importantes dans la brochure d'accompagnement l'appareil.

### DOC compliance Notice

This Class A digital apparatus meets all requirements of the Canadian Interference-Causing Equipment Regulations.

### DOC avis de conformation

Cet appareil numérique de la classe A respecte toutes les exigences du Règlement sur le Matériel D'interférence du Canada.

### WARNING

This equipment has been tested and found to comply with the limits for a Class A digital device, pursuant to Part 15 of the FCC Rules. These limits are designed to provide reasonable protection against harmful interference when the equipment is operated in a commercial environment. This equipment generates, uses, and can radiate radio frequency energy and, if not installed and used in accordance with the installation manual, may cause harmful interference to radio communications. Operation of this equipment in a residential area is likely to cause harmful interference in which case the user will be required to correct the interference at his own expense.

## Important Safeguards

These safety instructions are to ensure the long life of your projector and to prevent fire and shock. Please read them carefully and heed all warnings.

### Installation

1. Place the projector on a flat, level surface and in a dry area free from dust and moisture.
2. Do not place the projector in direct sunlight, near heaters or heat radiating appliances.
3. Exposure to direct sunlight, smoke or steam could harm internal components.
4. Handle your projector carefully. Dropping or jarring your projector could damage internal components.
5. Do not place heavy objects on top of the projector.
6. If installing the projector on the ceiling:
  - a. The ceiling must be strong enough to support the projector and the installation must be performed in accordance with any local building codes.
  - b. Qualified NEC authorized dealer personnel must install the projector.

### Power Supply

1. The projector is designed to operate on a power supply of 2.3KW(MAX) AC200-240V 50/60Hz. Ensure that your power supply fits this requirement before attempting to use your projector.
2. Handle the power cable carefully and avoid excessive bending. A damaged cord can cause electric shock or fire.
3. If the projector will not be used for an extended period of time, disconnect the plug from the power outlet.
4. Placing the power cord and the RGB cable closely to each other can cause beat noise. If this happens, keep the two separated until beat noise is not generated

### Cleaning

1. Unplug the projector before cleaning.
2. Clean the cabinet periodically with a damp cloth. If heavily soiled, use a mild detergent. Never use strong detergents or solvents such as alcohol or thinner.
3. Use a blower or lens paper to clean the lens, and be careful not to scratch or mar the lens.

### Fire and Shock Precautions

1. Ensure that there is sufficient ventilation and that vents are unobstructed to prevent potentially dangerous concentrations of ozone and the build-up of heat inside your projector. Allow at least 3 inches (10cm) of space between your projector and a wall.
2. Prevent foreign objects such as paper clips and bits of paper from falling into your projector. Do not attempt to retrieve any objects that might fall into your projector. Do not insert any metal objects such as a wire or screwdriver into your projector. If something should fall into your projector, disconnect it immediately and have the object removed by a qualified NEC service person.
3. Do not place any liquids on top of your projector.

**CAUTION:** High Pressure Lamp May Explode if Improperly Handled. Refer Servicing to Qualified Service Personnel.

#### Lamp Caution: Please read before operation

Due to the lamp being sealed in a pressurized environment, there is a small risk of explosion, if not operated correctly. There is minimal risk involved, if the unit is proper working order, but if damaged or operated beyond the recommended 1500 hours, the risk of explosion increases.

Please note that there is a warning system built in, that displays the following message when you reach 1500 hours of operation” Lamp Running Time is Over 1500 Hours!!” When you see this message please contact your NEC Dealer for a replacement.

If the lamp does explode, smoke will be discharged from the vents located on the side of the unit. This smoke is comprised of glass in particulate form and Xenon gas, and will not cause harm if kept out of your eyes. If your eyes have been exposed to this gas, please flush your eyes out with water immediately and seek immediate medical attention. **Do not rub your eyes! This could cause serious injury.**

**WARNING:**Do not look into the lens while the projector is on. Serious damage to your eyes could result.

## INTRODUCTION

### Recommandations importantes

Ces instructions de sécurité ont pour but d'assurer une longue vie à votre projecteur et d'éviter un incendie ou une décharge électrique. Prière de les lire avec attention et de tenir compte de tous les avertissements.

#### Installation

1. Placer le projecteur sur une surface plate et de niveau, et dans un endroit sec et à l'abri des poussières et de l'humidité.
2. Ne pas exposer le projecteur aux rayons directs du soleil, ni le placer près d'un chauffage ou de dispositifs de radiation de chaleur.
3. L'exposition aux rayons directs du soleil, à la fumée ou à la vapeur pourrait endommager des composants internes.
4. Manipuler le projecteur avec précautions. Laisser tomber le projecteur ou lui donner des chocs pourrait endommager des composants internes.
5. Ne pas poser d'objets lourds sur le dessus du projecteur.
6. En cas d'installation du projecteur au plafond :
  - a. Le plafond doit être assez résistant pour supporter le projecteur et l'installation doit être faite en conformité avec toute norme de construction locale.
  - b. Le projecteur doit être installé par du personnel qualifié d'un revendeur agréé NEC.

#### Alimentation

1. Le projecteur est conçu pour fonctionner sous une tension d'alimentation de 2,3 KW (MAX) CA 200-240 V 50/60 Hz. S'assurer que la tension du secteur soit conforme à ces caractéristiques avant d'utiliser le projecteur.
2. Manipuler le cordon d'alimentation avec précautions et éviter des flexions excessives. Un cordon endommagé peut occasionner une décharge électrique ou un incendie.
3. Si le projecteur ne doit pas être utilisé pendant une longue période, débrancher la fiche de la prise de courant.
4. Placer le cordon d'alimentation et le câble RGB tout près l'un de l'autre peut occasionner un bruit de battement. Si cela se produit, les maintenir séparés jusqu'à ce que le bruit de battement disparaisse.

#### Nettoyage

1. Débrancher le projecteur avant de le nettoyer.
2. Nettoyer régulièrement le boîtier extérieur avec un chiffon humide. S'il est très sale, utiliser un détergent doux. Ne jamais utiliser de détergent forts ou de solvants tels que de l'alcool ou du diluant.
3. Utiliser un souffleur ou du papier pour objectif pour nettoyer l'objectif, et faire attention de ne pas griffer ou endommager l'objectif.

#### Précautions contre l'incendie ou la décharge

1. S'assurer qu'il y ait une ventilation suffisante et que les ouvertures ne soient pas obstruées afin d'éviter des concentrations potentiellement dangereuses d'ozone et l'accumulation de chaleur à l'intérieur du projecteur. Laisser au moins 10 cm d'espace entre le projecteur et un mur.
2. Empêcher tous objets étrangers tels que des attaches trombones ou des morceaux de papier de tomber à l'intérieur du projecteur. Ne pas essayer de récupérer des objets qui seraient tombés dans le projecteur. Ne pas introduire d'objets métalliques tels qu'un fil ou un tournevis dans le projecteur. Si quelque-chose doit tomber dans le projecteur, le débrancher immédiatement et faire enlever l'objet par un technicien agréé NEC.
3. Ne pas poser de liquides sur le dessus du projecteur.

**ATTENTION :** La lampe à haute pression peut exploser si elle est manipulée incorrectement. Confier l'entretien à du personnel d'entretien qualifié.

#### AVERTISSEMENT :

Ne pas regarder dans l'objectif lorsque le projecteur est allumé. De sérieux dommages aux yeux pourraient en résulter.

## VISUAL SYSTEMS DIVISION

# LIMITED WARRANTY

---

NEC Technologies, Inc. (hereafter NECTECH) warrants this product to be free from defects in material and workmanship under the following terms.

### HOW LONG IS THE WARRANTY

Parts and labor are warranted for (1) One Year from the date of the first customer purchase. The lamp is warranted for 1000 hours of operating time or 90 days, whichever comes first.

### WHO IS PROTECTED

This warranty may be enforced only by the first purchaser.

### WHAT IS COVERED AND WHAT IS NOT COVERED

Except as specified below, this warranty covers all defects in material or workmanship in this product. The following are not covered by the warranty:

1. Any product which is not distributed in the U.S.A., Canada, and Mexico by NECTECH or which is not purchased in the U.S.A., Canada, and Mexico from an authorized NECTECH dealer.  
If you are uncertain as to whether a dealer is authorized, please contact NECTECH at 800-836-0655.
2. Any product on which the serial number has been defaced, modified or removed.
3. Damage, deterioration or malfunction resulting from:
  - a. Accident, misuse, abuse, neglect, fire, water, lightning or other acts of nature, unauthorized product modification, or failure to follow instructions supplied with the product.
  - b. Repair or attempted repair by anyone not authorized by NECTECH.
  - c. Any shipment of the product (claims must be presented to the carrier).
  - d. Removal or installation of the product.
  - e. Any other cause which does not relate to a product defect.
4. Cartons, carrying cases, batteries, external cabinets, magnetic tapes, or any accessories used in connection with the product.

### WHAT WE WILL PAY FOR AND WHAT WE WILL NOT PAY FOR

We will pay labor and material expenses for covered items, but we will not pay for the following:

1. Removal or installation charges.
2. Costs of initial technical adjustments (set-up), including adjustment of user controls. These costs are the responsibility of the NECTECH dealer from whom the product was purchased.
3. Payment of shipping charges.

### HOW YOU CAN GET WARRANTY SERVICE

1. To obtain service on your product, consult the dealer from whom you purchased the product, or ship it prepaid to any authorized NECTECH service center.
2. Whenever warranty service is required, the original dated in voice (or a copy) must be presented as proof of warranty coverage, and should be included in any shipment of the product. Please also include in any mailing, your name, address and a description of the problem (s).
3. For the name of the nearest NECTECH authorized service center, call NECTECH at 800-836-0655.

### LIMITATION OF IMPLIED WARRANTIES

All implied warranties, including warranties of merchantability and fitness for a particular purpose, are limited in duration to the length of this warranty.

### EXCLUSION OF DAMAGES

NECTECH's liability for any defective product is limited to the repair or replacement of the product at our option. NECTECH shall not be liable for:

1. Damage to other property caused by any defects in this product, damages based upon inconvenience, loss of use of the product, loss of time, commercial loss; or
2. Any other damages whether incidental, consequential or otherwise. Some states do not allow limitation on how long an implied warranty lasts and/or do not allow the exclusion or limitation of incidental or consequential damages, so the above limitations and exclusions may not apply to you.

### HOW STATE LAW RELATES TO THE WARRANTY

This warranty gives you specific legal rights, and you may also have other rights which vary from state to state.

FOR MORE INFORMATION, TELEPHONE 800-836-0655  
NEC TECHNOLOGIES, INC.  
1250 N. Arlington Heights Road, Suite 500  
Itasca, Illinois 60143-1248

NOTE: All products returned to NECTECH for service MUST have prior approval. To get approval, call NEC Technologies at 800-836-0655.

---

# TABLE OF CONTENTS

---

## INTRODUCTION

Introduction To The MultiSync Hivid 3500 Projector .....	7
How Do You Get Started? .....	7
What's In The Box? .....	7

## 1.PART NAMES AND FUNCTIONS

Input Panel Features .....	8
Remote Control Features .....	12
Remote Control Battery Installation .....	14

## 2.INSTALLATION

Setting Up Your MultiSync Hivid 3500 Projector .....	16
Moving the Projector .....	16
Selecting A Location .....	16
Screen Size and Projection Distance .....	16
Examples of Connections .....	20
Cautions on Connections .....	20
When Used in Stand Alone Operation .....	20
When Used with One Switcher (ISS-6020/ISS-6020G) .....	21
When Used with Two or More Switchers (100 Inputs) .....	22
REMOTE 1 Connector .....	24

## 3. OPERATION

General Controls .....	26
Using The On-screen Menus .....	27
On Adjustment Mode .....	27
Menu Descriptions & Functions .....	28
Task Bar .....	28
Storing Projector Settings (Automatic Save Feature) .....	29

Basic Operation (Operate Menu) .....	30
Source Select .....	30
Source Information .....	32
Picture Control .....	37
Display Control .....	38
Image Control .....	39
Sound Control .....	40
Closed Caption .....	40
Timer Setting .....	41

Ajusting and Setting (Adjust Menu) .....	43
Source Registry .....	43
Amplitude .....	48
White Balance .....	48
Signal Level .....	48
Uniformity .....	49
Display Function .....	50
Lamp Mode .....	51
Set Option .....	52
Passcode .....	52
Setting Mode .....	59
Menu Mode .....	67
Execute Mode .....	71
Help Menu .....	74
Help .....	74
Topics .....	74
Set Information .....	74
Others .....	75
Test Pattern .....	75
Normalize/Load/Cancel .....	76

## 4. SPECIFICATIONS ..... 78

## 5. APPENDIX

Message List .....	80
--------------------	----

# INTRODUCTION

---

This section introduces you to your new MultiSync Hivid 3500 Projector, provides a list of materials that comes with your projector and describes the features and controls.

## **Congratulations On Your Purchase Of The MultiSync Hivid 3500 Projector**

The MultiSync Hivid 3500 is one of the very best projectors available today. Digital Light Processing™ (DLP™) by Texas Instruments enables you to project high bright precise images up to 500 inches across (measured diagonally) from your PC or Macintosh computer (desktop or notebook), VCR, document camera, laser disc player, DVD player and even an HD VCR or HD laser disc player.

You can use the projector on a tabletop or cart, you can permanently mount it on a ceiling\*, or you can use MultiSync Hivid 3500 Projector to project images from behind the screen. The wired remote control can be used with a cable, and you can even use the wireless remote control.

### **The features you'll enjoy include:**

- A high-performance 1.6 KW Xenon lamp that delivers 3500 lumens (ANSI) and lamp life is 1500 hours.
- DLP offers true color reproduction.
- Display size can be altered to accommodate any picture size from 80 to 500 inches (measured diagonally).
- White Uniformity circuit keeps color of a large image evenly
- DLP projects images with uniform brightness onto screens while colors remain true to their original source.
- Magnifying, Reducing and Panorama mode allows you to make an image large or smaller and wider.
- Edge-blending feature provides a clean unbroken image of multiple screens.
- The new bulb type Xenon short arc lamp offers bright images and yet its long life.
- An image can be projected from in front or behind a screen, and the projector can even be installed on the ceiling\*.
- Supports HDTV and DVD signals as well as most IBM VGA, S-VGA, XGA (scaling), Macintosh or any other RGB signals within a horizontal frequency range of 15 to 64 kHz and a vertical frequency range of 40 to 100 Hz. This includes NTSC, PAL, SECAM, and NTSC4.43 standard video signals.
- On-screen monitor out terminal allows you to view on-screen message on your PC when setting up your system.
- The remote control can be used with or without a cable.

\* Installing the MultiSync Hivid 3500 Projector on the ceiling must be done by authorized NEC technicians. Consult your NEC dealer for more information.

### **How Do You Get Started?**

The fastest way to get started is to take your time and do everything right the first time. Taking a few minutes now to review the manual may save you hours later on. At the beginning of each section of the manual you'll find an overview. If the section doesn't apply, you can skip it.

### **What's In The Box?**

Make sure your box contains everything listed. If any pieces are missing, contact your dealer. Please save the original box and packing materials if you ever need to ship your MultiSync Hivid 3500 Projector.

- NEC MultiSync Hivid 3500 Projector
- Remote Control with Remote Cable (wireless/wired).
- Power Cable
- Two AA Batteries
- User Manual

# 1. PART NAMES AND FUNCTIONS

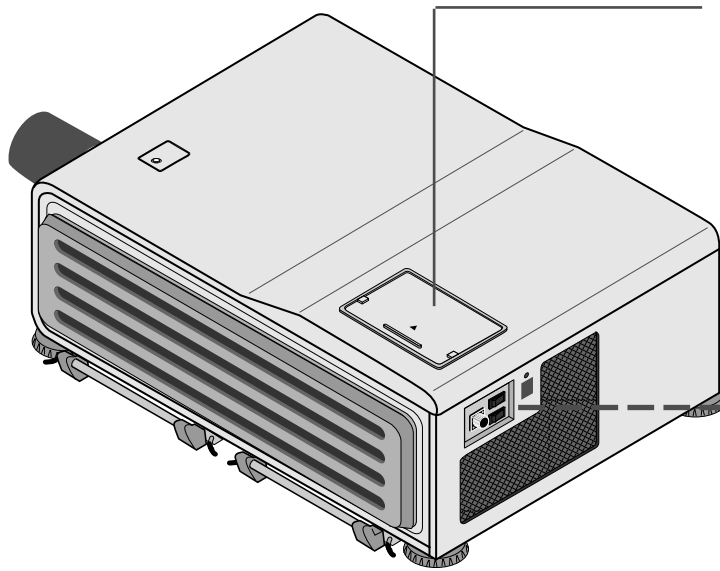

This compartment accommodates the remote control. The remote control serves as the key panel on the projector when it is plugged and fit in this compartment.

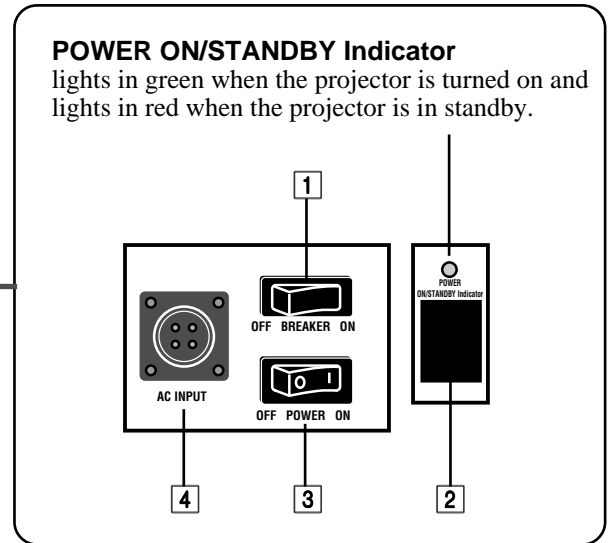

## 1 Breaker Switch

Press the switch to the ON position to turn on the breaker and press to the OFF position to turn off the breaker. When abnormal conditions are encountered, the breaker will trip and turn the projector off. If the projector will not be used for an extended period of time, turn off the breaker by pressing the switch to the OFF position.

## 2 Remote Sensor

Receives the signal from the supplied remote control when used in the wireless mode.

## 3 Power Switch (Main power)

To turn on the main power to the projector press the switch to the ON position (I). The STANDBY and the RC READY indicator will light. In this condition you can start up the projector by pressing the POWER ON button on the remote control or the POWER button on the side panel. Press to the OFF position (O) to turn the main power off.

**NOTE:** When turning off the main power, first return the projector to the standby condition by pressing the POWER OFF button on the remote control or the POWER button on the side panel and then turn off the main POWER switch. These procedures are necessary to protect your projector and the connected equipment.

## 4 AC INPUT

Connect the supplied power cord here (AC 200-240V).

## 5 POWER Button

Turns the projector on when the projector is in the standby condition (Main Power switch must be on and the STANDBY indicator lit). Turns the projector off after “- -” on the two digit display is blinking for three minutes.

**NOTE:** Do not turn off the main power while “- -” on the two digit display is blinking. During this time the lamp is cooling off.

## 6 POWER Indicator

Lights up when the projector is turned on.

## 7 STANDBY Indicator

Lights up when the projector's main POWER switch is on. When the projector is used with the ISS-6020 switcher on SW1 level or SW2 level mode, this indicator flashes when the projector is not connected with the switcher correctly or when the switcher is turned off.

## 8 RC READY Indicator

Lights up when the projector's main POWER switch is on. Flashes when the projector receives a signal from the remote control.

## 9 LAMP Indicator

Displays the lamp on or off. Indicator illuminates—Lamp is turned on  
Indicator goes out—Lamp is turned off

## 10 Two Digit Display

INDICATOR: Displays projector error codes. (“00” in normal operation)  
ON/OFF Switch: Turns the INDICATOR on or off.

## 11 REMOTE 2 Jacks

IN: for the wired remote control.  
OUT: for daisy-chaining multiple projectors and operating them with the same remote control. To do so, connect to a second projector's IN terminal to relay the input at the IN terminal of the first projector until all the projectors are connected.



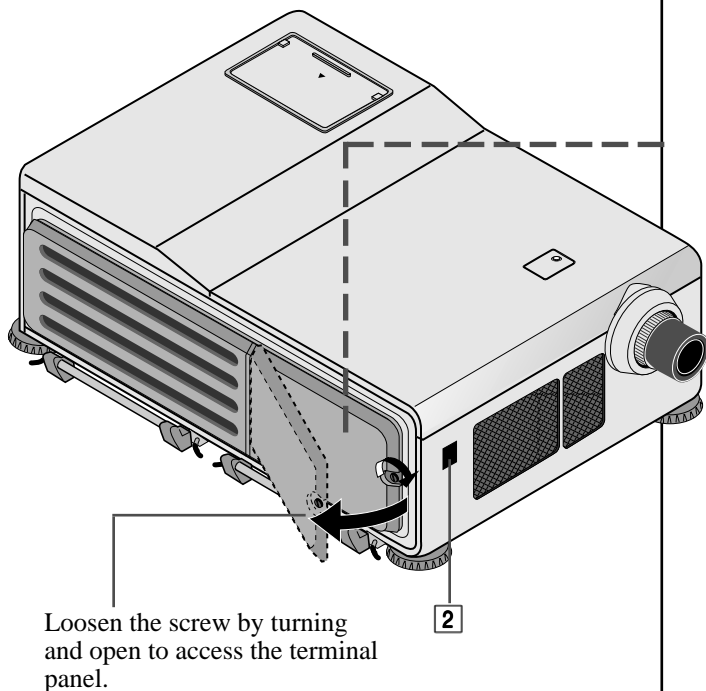

Loosen the screw by turning and open to access the terminal panel.

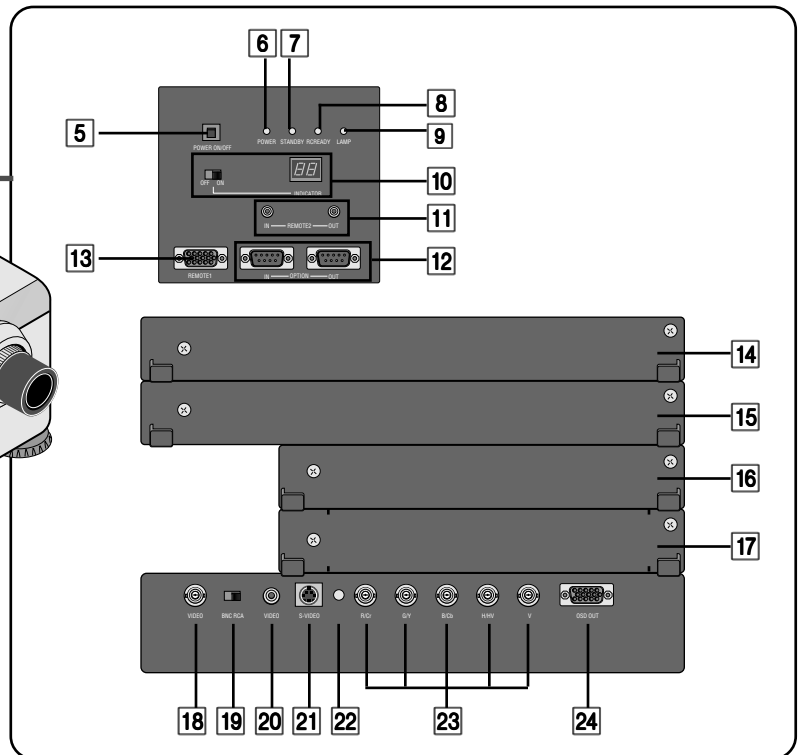

- 12 OPTION Connectors (D-Sub 9-pin)**  
For system expansion such as PC-control.  
IN: connect to the external equipment such as PC.  
OUT: for daisy-chaining multiple projectors and operating them with the same external equipment. To do so, connect to a second projector's IN terminal to relay the input at the IN terminal of the first projector until all the projectors are connected.
- 13 REMOTE 1 Connector (Mini D-Sub 15-pin)**  
This terminal allows external control of the projector from either the Switcher or from an external control. When the Switcher is used, connect to the REMOTE 1 terminal on the back of the Switcher.  
NOTE: The ISS-6020/ISS-6020G Switcher is compatible with this projector.
- 14 INPUT E**  
Not used.
- 15 INPUT D**  
Used for the factory-installed video processor only.
- 16 INPUT C**  
Slot for adding optional RGB or video input cards.
- 17 INPUT B**  
Slot for adding optional RGB or video input cards.
- 18 VIDEO Input BNC Terminal (INPUT A)**  
Connect to the BNC video output of the external equipment such as a VCR or laser disk player.
- 19 VIDEO Input Select Switch**  
Selects VIDEO input between BNC and RCA type.

- 20 VIDEO Input RCA Terminal (INPUT A)**  
Connect to the RCA video output of the external equipment such as a VCR or laser disk player.
- 21 S-VIDEO Input Terminal (INPUT A)**  
Connect to the S-video output of the external equipment such as a VCR with an S-video output. This terminal allows switching between S2 and S1 VIDEO input modes. See the "S-Video Mode" section for more information.
- 22 Active Indicator (green LED)**  
Lights up when the INPUT A slot is selected.
- 23 R/Cr, G/Y, B/Cb, H H/V and V Input Terminals (INPUT A)**  
Connect R,G,B,H (Horizontal sync) and V (Vertical sync) outputs of the external equipment such as the Switcher). If using a component with a combined sync (SYNC) output, connect it to the H/V terminal.  
Connect component video outputs of the external equipment such as DVD player.
- 24 OSD OUT Connector (Mini D-Sub 15-pin)**  
Outputs on-screen information. You can use this connector to loop your on-screen information to an external monitor.

**NOTE:**

- 1) A picture may be distorted or no picture may appear when any one of the following procedures is performed:
  - \* An XGA signal is input to the projector.
  - \* A High-refresh signal in SVGA is input to the projector.
- 2) Some types of monitor may display no image on the screen.

## 1. PART NAMES AND FUNCTIONS

### OPTIONAL Boards

#### VIDEO INPUT Board [XG VIDIN(A)]

Front view

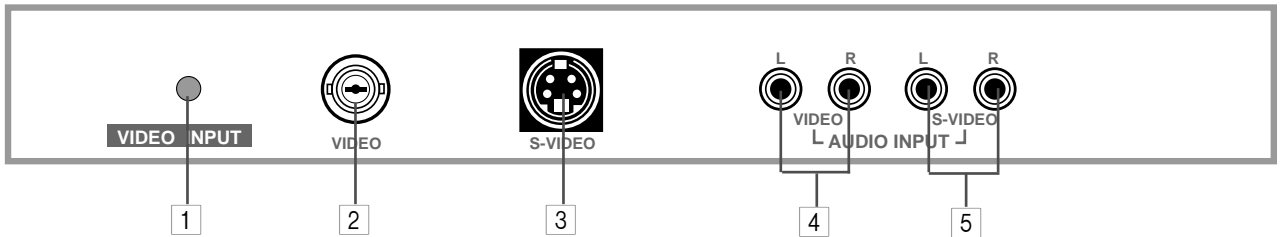

- 1 **Active Indicator (green LED)** ..... Lights up when this board is selected.
- 2 **VIDEO INPUT Terminal** ..... Connects composite video output signals.
- 3 **S-VIDEO INPUT Terminal** ..... Connects S-video output signals.
- 4 **VIDEO INPUT Terminal** ..... Connect to the audio outputs of the external equipment such as a VCR.  
(Not available on this model.)
- 5 **S-VIDEO INPUT Terminal** ..... Connect to the S-video audio outputs of the external equipment such as a VCR with S-video outputs. (Not available on this model.)

#### RGB INPUT Board [XG RGBIN(A)]

Front view

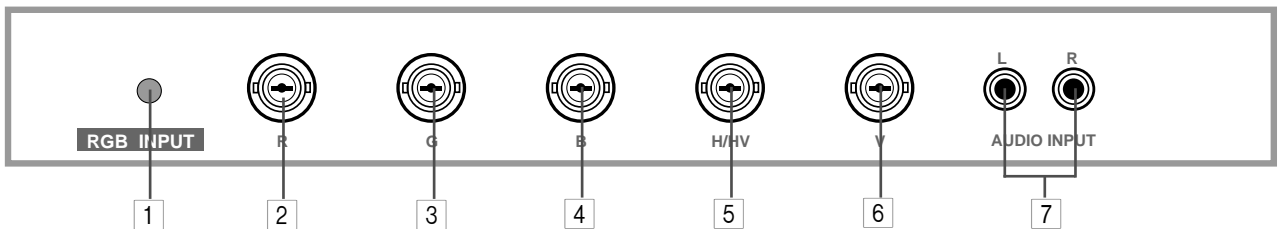

- 1 **Active Indicator (green LED)** ..... Lights up when this board is selected.
- 2 **R Input Terminal** ..... Connects an Red output signal.
- 3 **G Input Terminal** ..... Connects a Green output signal.
- 4 **B Input Terminal** ..... Connects a Blue output signal.
- 5 **H/HV Input Terminal** ..... Connects horizontal sync or horizontal/vertical sync output signals.
- 6 **V Input Terminal** ..... Connects a vertical sync output signal.
- 7 **AUDIO Input Terminals** ..... Connect to the audio outputs of the external equipment such as ISS-6020/6020G.  
(Not available on this model.)

#### RGB INPUT Board

Top view

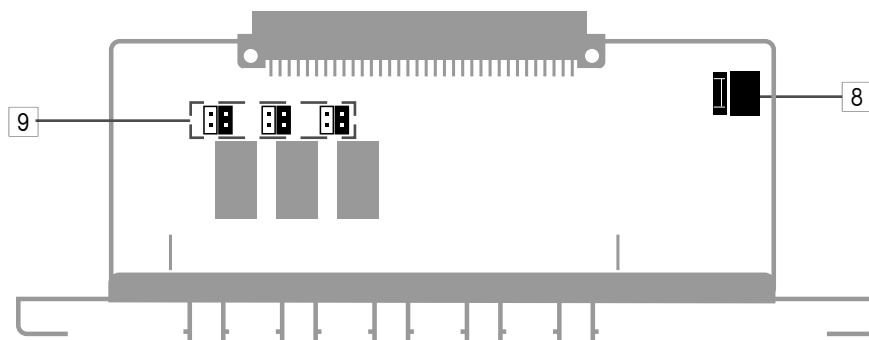

- 8 **Rotary Switch (S1001)**
- 9 **Jumper(S1002, S1003, S1004)**

The combination of the rotary switch and the jumper pins allows the projector to accept VIDEO signals. Note that this board cannot accept RGB signals when board is set to VIDEO input.

**Rotary switch (S1001)**



**Jumper (S1002, S1003, S1004)**

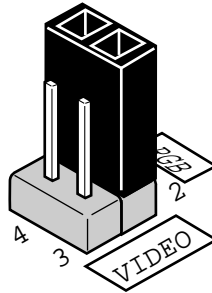

**Setting of Rotary switch**

No.	Mark	Input
0	VIDEO	VIDEO input
1	OPTION	Option
3	RGB	RGB input
2, 4-9		Not used

\*1  
\*2

\*1 ) No 1 is for future system expansion.  
\*2) No 3 is factory preset.

**Table for Setting Rotary Switch and Jumpers.**

Setting of Rotary switch and Jumpers		Input Signal			Board Identification
Rotary Switch(S1001)	Jumpers	R terminal	G terminal	B terminal	
0	(2, 3) Short	VIDEO	Y	C	VIDEO
* 3	(1, 2) Short	R	G	B	RGB

\* indicates factory preset.

**SLOT FOR OPTIONAL MODULE**

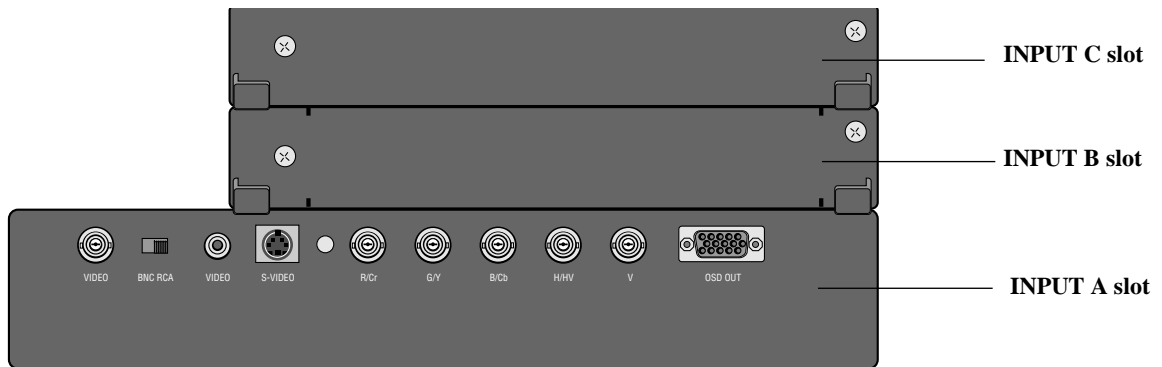

**Corresponding slot number**

You can also select the input signal directly by pressing the INPUT "1" through "10" button. In this case INPUT buttons function as follows:

**1) When the slot A(Mother board) is selected:**

- INPUT 1 ..... RGB input
- INPUT 2 ..... VIDEO input
- INPUT 3 ..... S-VIDEO input

**3) When the slot C (optional board) is selected:**

- When VIDEO board installed      When RGB board installed
- INPUT 7 ..... VIDEO input      INPUT 7 ..... RGB input
- INPUT 8 ..... S-VIDEO input

**2) When the slot B (optional board) is selected:**

- When VIDEO board installed      When RGB board installed
- INPUT 4 ..... VIDEO input      INPUT 4 ..... RGB input
- INPUT 5 ..... S-VIDEO input

## 1. PART NAMES AND FUNCTIONS

### Remote control unit

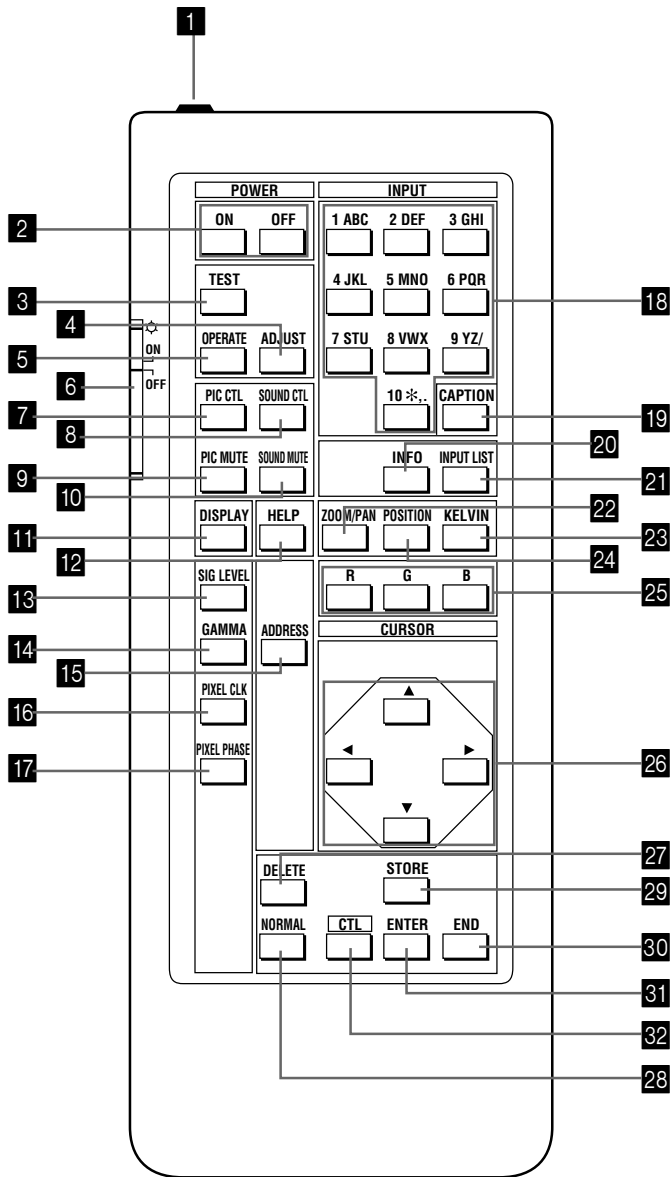

You can use your remote control with the cable or wirelessly to operate your MultiSync Hivid 3500 Projector. If you want to use your remote control with the cable, connect one end of the cable to the jack on the remote control and the other end to the REMOTE 2 IN jack of the projector.

- 1 Remote Jack**  
Insert the supplied remote cable here.
- 2 POWER Buttons (ON/OFF)**  
Press the ON button to turn the projector on when the projector is in the standby condition (STANDBY and RC READY indicators lit). Press the OFF button to return the projector to the standby condition.
- 3 TEST Button**  
Press to display the TEST PATTERN menu from which you can select a test pattern.
- 4 ADJUST Button**  
Press to display the ADJUST menu.
- 5 OPERATE Button**  
Press to display the OPERATE menu.
- 6 Backlight Switch**  
Turns the backlight on and off. If no button operation is made within 30 seconds with the Backlight ON, the Backlight will turn off to conserve battery life. The light stays on in standby and power-on when the remote control is used as a wired remote.
- 7 PIC CTL Button**  
Press to display the picture adjustment screen. NOTE: Some function items will not be available depending on the type of video signal.
- 8 SOUND CTL Button**  
Press to display the VOLUME adjustment screen. You can adjust the volume of the ISS-6020/ISS-6020G Switcher. (when used with the ISS-6020 switcher on SW1 level or SW2 level mode)
- 9 PICTURE (PIC) MUTE Button**  
Press to mute the picture. Press again to display the picture.
- 10 SOUND MUTE Button**  
Press to mute the sound. Press again to return the sound. (when used with the ISS-6020 switcher on SW1 level or SW2 level mode)
- 11 DISPLAY Button**  
Press to turn on or off the on-screen display. Pressing with CTL eliminates the on-screen display; pressing with CTL will restore display.

**NOTE:** Even if the on-screen display may be turned off with pressing CTL and DISPLAY, any adjustment will still change the projector's memory settings. This mode is available even when an input is switched to another or the power is turned off using the POWER OFF button on the remote control.

**12 HELP Button**

Press to display the explanation of the current selected function and available functions.

**13 SIG LEVEL Button**

Press to display the SIGNAL LEVEL menu. You can set the level for an RGB or YUV signal.

**14 GAMMA Button**

Press to display the GAMMA CORRECTION menu. You can select two options.

**15 ADDRESS Button**

Press to display the ADDRESS menu. Pressing with CTL allows you to specify the address for the remote control.

**16 PIXEL CLK Button**

Press to display the PIXEL CLOCK adjustment screen. You can adjust a picture width to the screen by adjusting the clock frequencies to eliminate the vertical banding in the image.

**17 PIXEL PHASE**

Press to display the PIXEL PHASE adjustment screen. You can adjust the clock phase to reduce video noise, dot interference or cross talk. (This is evident when part of your image appears to be shimmering.)

**18 INPUT Button**

Selects menus and switches input signals.

**19 CAPTION Button**

Press to display the CLOSED CAPTION menu.

**20 INFO Button**

Press to display the various parameters and settings of the currently displayed image. Pressing with the CTL button displays some of items available in.

**21 INPUT LIST Button**

Press to display the memory list of the recorded input signals.

**22 ZOOM/PAN Button**

Press to display the ZOOM adjustment screen. The zoom function enlarge or reduce the projected image. Pressing with CTL displays the PAN adjustment screen. The pan function enlarge or reduce the selected part of an image.

**23 KELVIN Button**

Press to enter the KELVIN mode. You can adjust the color temperature, horizontal, vertical position and horizontal, vertical blanking and image size.

**24 POSITION Button**

Press to enter the position mode. You can adjust the

**25 R, G, and B Buttons**

The R and B buttons are used for Uniformity only.

**26 CURSOR Buttons**

Used for increasing and decreasing control levels, cursor movement and convergence adjustments.

**27 DELETE Button**

Used to delete characters or numbers you typed.

**28 NORMAL Button**

Returns the standard level for each signal. When pressed once, the confirmation message will be displayed. When "YES" is selected and ENTER is pressed, the data will be returned to the standard level. While holding down the CTL button, press the NORMAL button to display the LOAD menu to select the LOAD (last stored level).

**29 STORE Button**

Memorizes the adjustments setting of each signal separately.

When pressed once, the confirmation message "STORE?" will be displayed. When selecting "YES" and ENTER, the data will be stored in memory.

**30 END Button**

Ends the adjustment mode.

**31 ENTER Button**

Executes menu selection and switches to selected input.

**32 CTL Button**

Used in conjunction with other buttons, similar to a shift key on a computer.

## 1. PART NAMES AND FUNCTIONS

### Remote Control Battery Installation

1. Press firmly and slide the battery cover off.

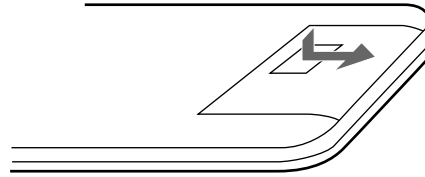

2. Remove both old batteries and install new ones (AA).  
Ensure that you have the batteries' polarity (+/-) aligned correctly.

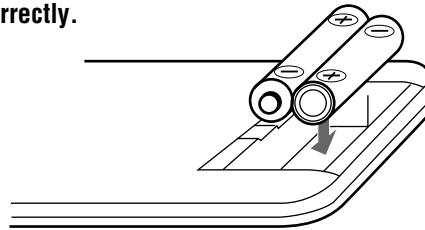

3. Slip the cover back over the batteries until it snaps into place.

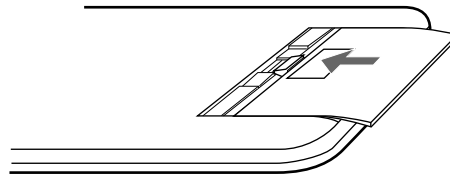

**NOTE:** The remote control is powered by two alkaline 1.5V AA batteries.

### Remote Control Precautions

- When using the remote wirelessly, you should be within 23 ft.(7 m) of the projector and at an angle of no more than 30 degrees.
- When the cable is connected to the remote control, it will not work wirelessly.
- Handle the remote control carefully.
- If the remote control gets wet, wipe it dry immediately.
- Avoid excessive heat and humidity.
- If you will not be using the remote control for a long time, remove the batteries.
- Do not mix new and old or different types of batteries.
- Avoid using the remote control as wireless with the backlight switch ON for an extended period of time. This can cause short battery life.
- Be sure to secure the remote control with the metal fitting when installing the projector on the ceiling and using the remote control as the key panel of the projector.

**When using the remote control as the key panel on the projector:**

The following steps are necessary only when the projector is installed on the ceiling.

When you use the projector in floor projection, you do not need to fasten the remote with the metal fitting. Simply open the lid and put the remote in the compartment.

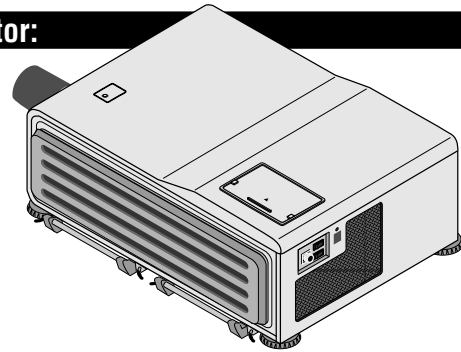

**1. Slide and open the lid.**

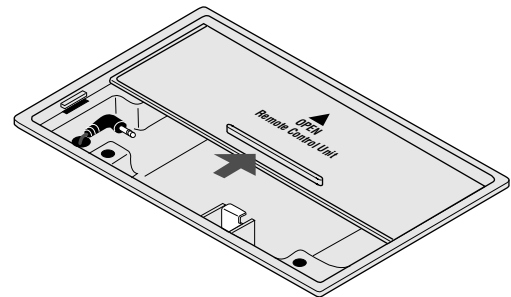

**2. Loosen the screw on the metal fitting.**

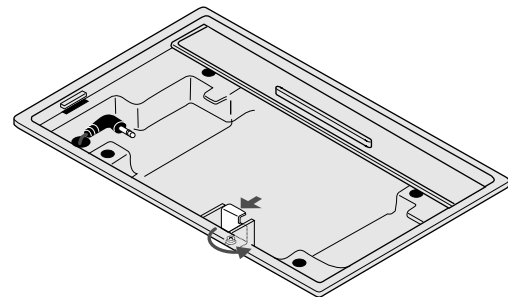

**3. Plug the mini plug into the remote jack of the remote control.**

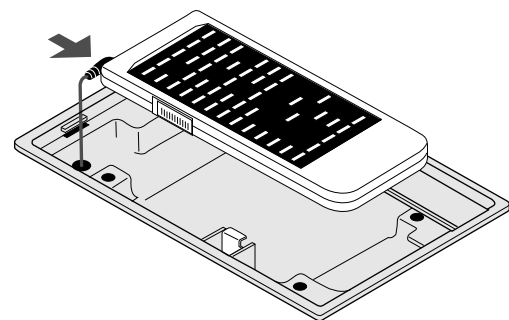

**4. Place the remote control in the compartment.**

**5. Tighten the screw and secure the remote control with the metal fitting.**

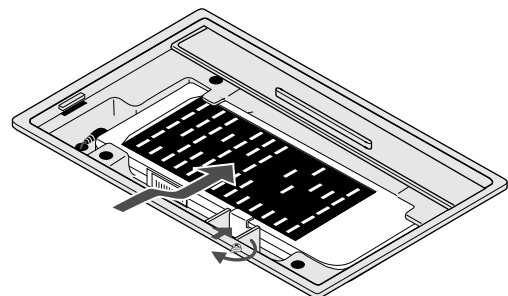

## 2. INSTALLATION

This section describes how to set up your MultiSync Hivid 3500 projector and how to connect video and audio sources.

### Setting Up Your MultiSync Hivid 3500 Projector

To set up and use your MultiSync Hivid 3500 Projector, you must first do:

1. Determine the screen size and the optional lens to be used.

**NOTE:** Consult your dealer for lens order and installation.

2. Set up a screen or select a non-glossy white wall onto which you can project your image.

### Moving The Projector

Always carry your projector by the handle. Ensure that the power cord and any other cables connecting to video sources are disconnected before moving the projector. When moving the projector or when it is not in use, cover the lens with the lens cap.

### Selecting A Location

The further your projector is from the screen or wall, the larger the image. The minimum size the image can be projected is 80" (2 m) measured diagonally. The largest the image can be is 500" (12.7 m).

#### WARNING

- Only use your projector on a solid, level surface. If the projector falls to the ground, you can be injured and the projector severely damaged.
- Do not use the projector where temperatures vary greatly. The projector must be used at temperatures between 32 degrees F (0 degree C) and 104 degrees F (40 degree C).
- Do not expose the projector to moisture, dust, or smoke. This will harm the screen image.
- Ensure that you have adequate ventilation around your projector so heat can dissipate. Do not cover the vents on the bottom or back of the projector.

### Screen Size and Projection Distance

1. Place your projector on a flat level surface at the optimal distance from the screen or wall so you realize the size image you want. (Avoid having bright room lighting or sun light directly on the screen or wall where you'll be projecting the image.)
2. Connect the power cable, remove the lens cap and turn the projector on. (If no input signal is available, the projector will display a black screen.)
3. Ensure that the projector is square to the screen.
4. Move the projector left or right to center the image horizontally on the screen.

### Pulling Out the Handles

Pull out the handle from the bottom side.

### Retracting the Handles

Press down the two levers at the same time to retract the handle.

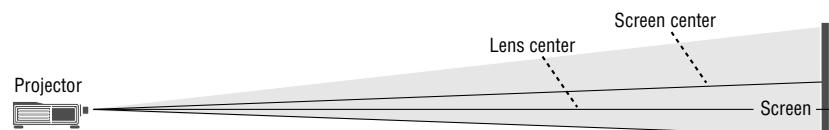
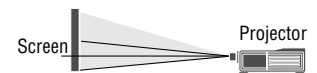
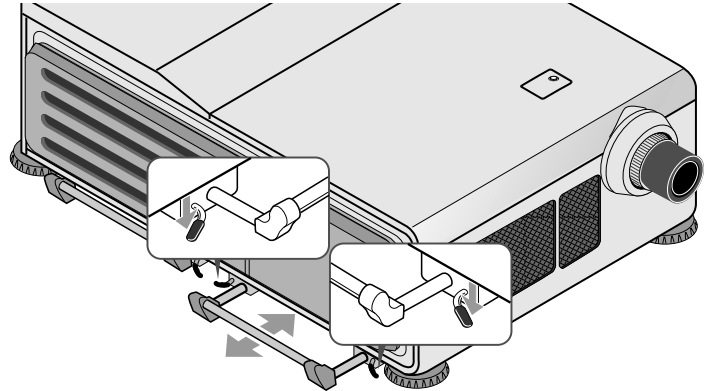



5. To move the projected image up or down, rotate the lens vertical knob in the top compartment right above the lens barrel.
6. Adjust the focus using the Focus knob at the lens.
7. Increase or reduce the size of the projected image by using the ZOOM/PAN button on the remote control.

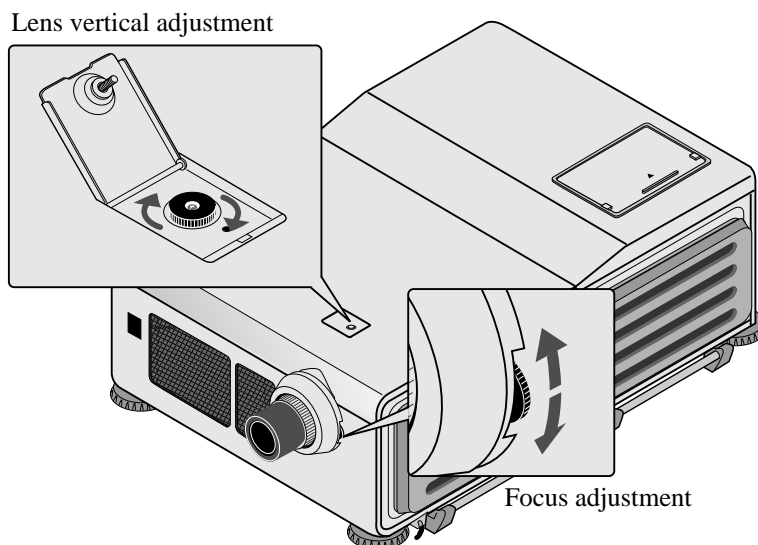

■ Projection Distance

		Model No.					
		Fixed focal length lens				Zoom lens	
Model No.		XL-L1.27	XL-L3	XL-L5	XL-L7	XL-L1.5Z	XL-L3Z
Magnification		1.27:1	3.0:1	5.0:1	7.0:1	Zoom1.5-3.0	Zoom3.0-7.0
Screen Size" (diagonal)	100"	2580mm 102in	6100mm 240in	10160mm 400in	14220mm 560in	3,050-6,100mm 120-240in	6,100-14,220mm 240-600in
	200"	5160mm 203in	12190mm 480in	20320mm 800in	28450mm 1120in	6,100-12,190mm 240-480in	12,190-28,450mm 480-1120in
	300"	7740mm 305in	18290mm 720in	30480mm 1200in	42670mm 1680in	9,140-18,290mm 360-720in	18,290-42,670mm 720-1680in
	400"	10320mm 406in	24380mm 960in	40640mm 1600in	56900mm 2240in	12,190-24,380mm 480-960in	24,380-56,900mm 960-2240in
	500"	12900mm 508in	30480mm 1200in	50800mm 2000in	71120mm 2800in	15,240-30,480mm 600-1200in	30,480-71,120mm 1200-2800in
	Vertical offset	1/2V	1/2V	1/2V	1/2V	1/4V	1/4V

V=Screen Height (inch)

**NOTE:** "Vertical Offset" refers to as movable range between lens center and screen center. Vertical offset is decided by ratio of screen height (V).

**Example:** When using a 100" screen (4:3) with the lens (XL-L 1.27), you can get 30 inches of your vertical offset by using the formula (100 x 3/5 x 1/2) and you can make your screen height larger by 30 inches.

\*For screen sizes between 80" and 500" not indicated on the above table, use the following proportional formula:

**Diagonal screen size (4:3) x 4/5 = Screen width**  
**W(Screen width) x magnification = Projection distance**

Unit=inches

**NOTE:** The margin of error for projection distance is +/- 3% in fixed-focal-length lens and +/- 5% in zoom lens.

Six lenses are available. The four are fixed-focal-length lenses; the two are zoom lenses.

Order lens from your NEC dealer using lens' s model number. Consult your NEC dealer for lens installation and replacement.

## 2. INSTALLATION

### Ceiling Installation

Installing your MultiSync Hivid 3500 Projector on the ceiling must be done by a qualified technician. Contact your NEC dealer for more information.

Do not attempt to install the projector yourself.

The following shows the proper relative positions of the projector and screen. Refer to the table to determine the position of installation.

Install in such a way that the projector and screen are positioned in the proper direction and at the proper angle. If not,

the projector's performance will be affected and its reliability will decrease. Be sure to position the projector properly.

The manufacturer will not be held responsible for any problems occurring when the projector is not installed in the proper position.

If your projector is mounted on the ceiling and your image is upside down, use PJ ORIENTATION on the ADJUST-SETTING Menu to correct the orientation. (See page.)

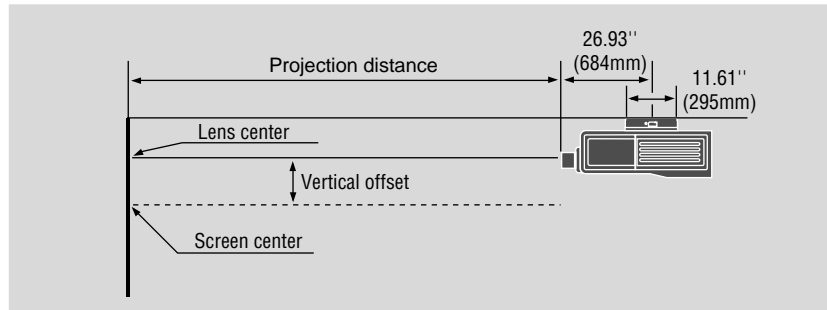

		Model No.					
		Fixed focal length lens			Zoom lens		
Model No.		XL-L1.27	XL-L3	XL-L5	XL-L7	XL-L1.5Z	XL-L3Z
Magnification		1.27:1	3.0:1	5.0:1	7.0:1	Zoom1.5-3.0	Zoom3.0-7.0
Screen Size" (diagonal)	100"	2580mm 102in	6100mm 240in	10160mm 400in	14220mm 560in	3,050-6,100mm 120-240in	6,100-14,220mm 240-600in
	200"	5160mm 203in	12190mm 480in	20320mm 800in	28450mm 1120in	6,100-12,190mm 240-480in	12,190-28,450mm 480-1120in
	300"	7740mm 305in	18290mm 720in	30480mm 1200in	42670mm 1680in	9,140-18,290mm 360-720in	18,290-42,670mm 720-1680in
	400"	10320mm 406in	24380mm 960in	40640mm 1600in	56900mm 2240in	12,190-24,380mm 480-960in	24,380-56,900mm 960-2240in
	500"	12900mm 508in	30480mm 1200in	50800mm 2000in	71120mm 2800in	15,240-30,480mm 600-1200in	30,480-71,120mm 1200-2800in
	Vertical offset	1/2V	1/2V	1/2V	1/2V	1/4V	1/4V

V=Screen Height (inch)

**NOTE:** "Vertical Offset" refers to as movable range between lens center and screen center. Vertical offset is decided by ratio of screen height (V).

**Example:** When using a 100" screen (4:3) with the lens (XL-L 1.27), you can get 30 inches of your vertical offset by using the formula (100 x 3/5 x 1/2) and you can make your screen height larger by 30 inches.

\*For screen sizes between 80" and 500" not indicated on the above table, use the following proportional formula:

$$\text{Diagonal screen size (4:3)} \times \frac{4}{5} = \text{Screen width}$$

$$W(\text{Screen width}) \times \text{magnification} = \text{Projection distance}$$

Unit=inches

**NOTE:** The margin of error for projection distance is +/- 3% in fixed-focal-length lens and +/- 5% in zoom lens.

**Reflecting The Image**

Using a mirror to reflect your projector's image enables you to enjoy a much larger image. Contact your NEC dealer if you need a mirror.

If you're using a mirror and your image is inverted, use the ADJUST-SETTING Menu to access to correct the orientation. (See page 59.)

**Rear Screen Projection**

You can use your MultiSync Hivid 3500 to project an image from the rear onto a transparent screen. The distance the projector must be from the screen is the same as if you were projecting the image from the front. Contact your NEC dealer if you need a transparent screen.

If you're projecting the image from the rear and your image is inverted, use the ADJUST-SETTING Menu to access to correct the orientation. (See page 59.)

## 2. INSTALLATION

### EXAMPLES OF CONNECTIONS.

#### CAUTIONS ON CONNECTIONS:

- Unplug the projector and other equipment from the AC supply before making connections.
- Make sure that the plug of the power cord is properly connected to the power outlet. A loose connection may cause hum or noise.
- Confirm your connection layout with the user's manual accompanying the equipment to be connected with the ISS-6020/ISS-6020G Switcher.

#### When Used in Stand Alone Operation

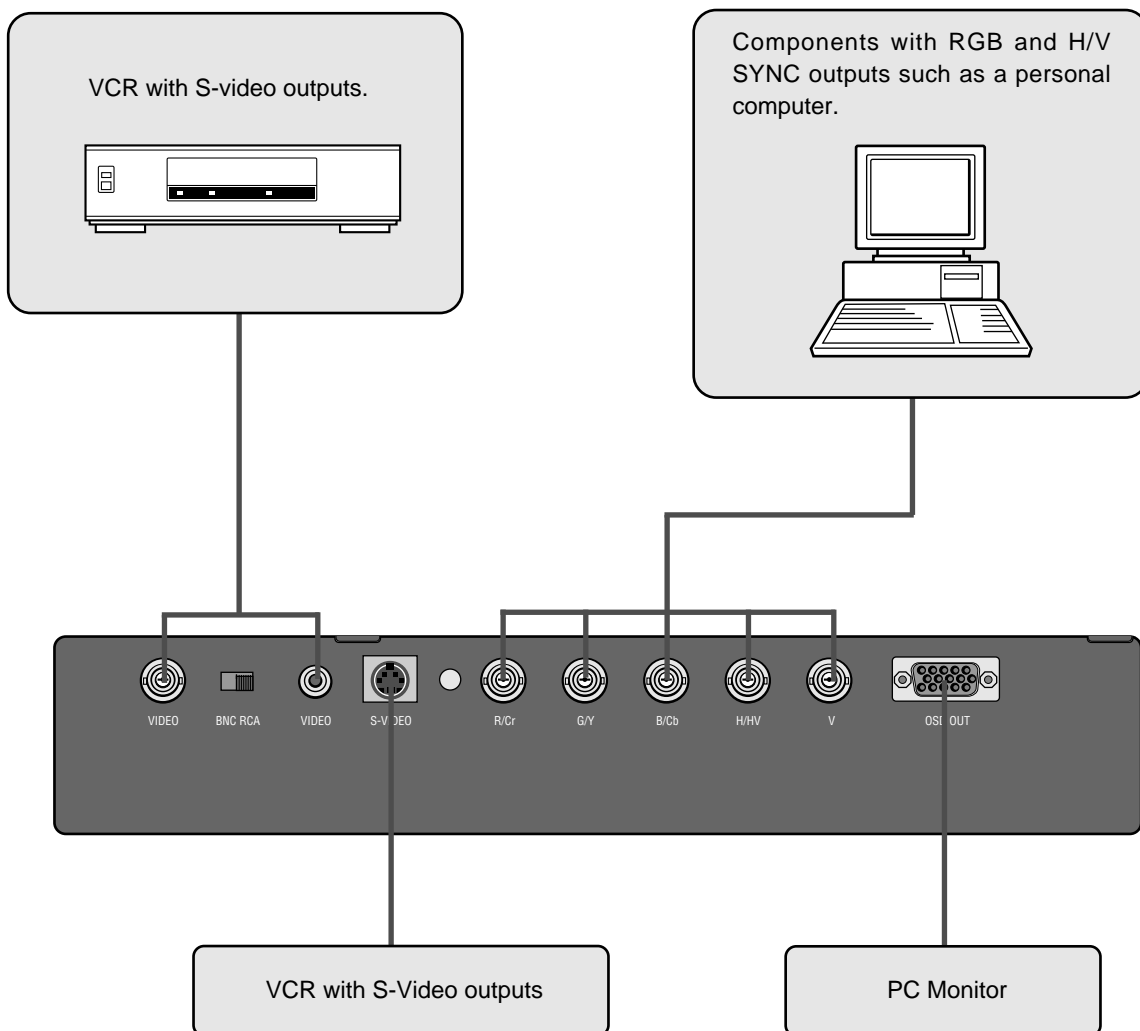

- Make sure that the STANDALONE mode is selected from the CONNECT CONDITION menu. See page 71 for connecting the Switcher.

**When Used with One Switcher (ISS-6020/ISS-6020G)**

Up to 10 input signals can be accepted when the projector is connected to one Switcher. Using the projector with the Switcher allows easy adjustment and signal selection.

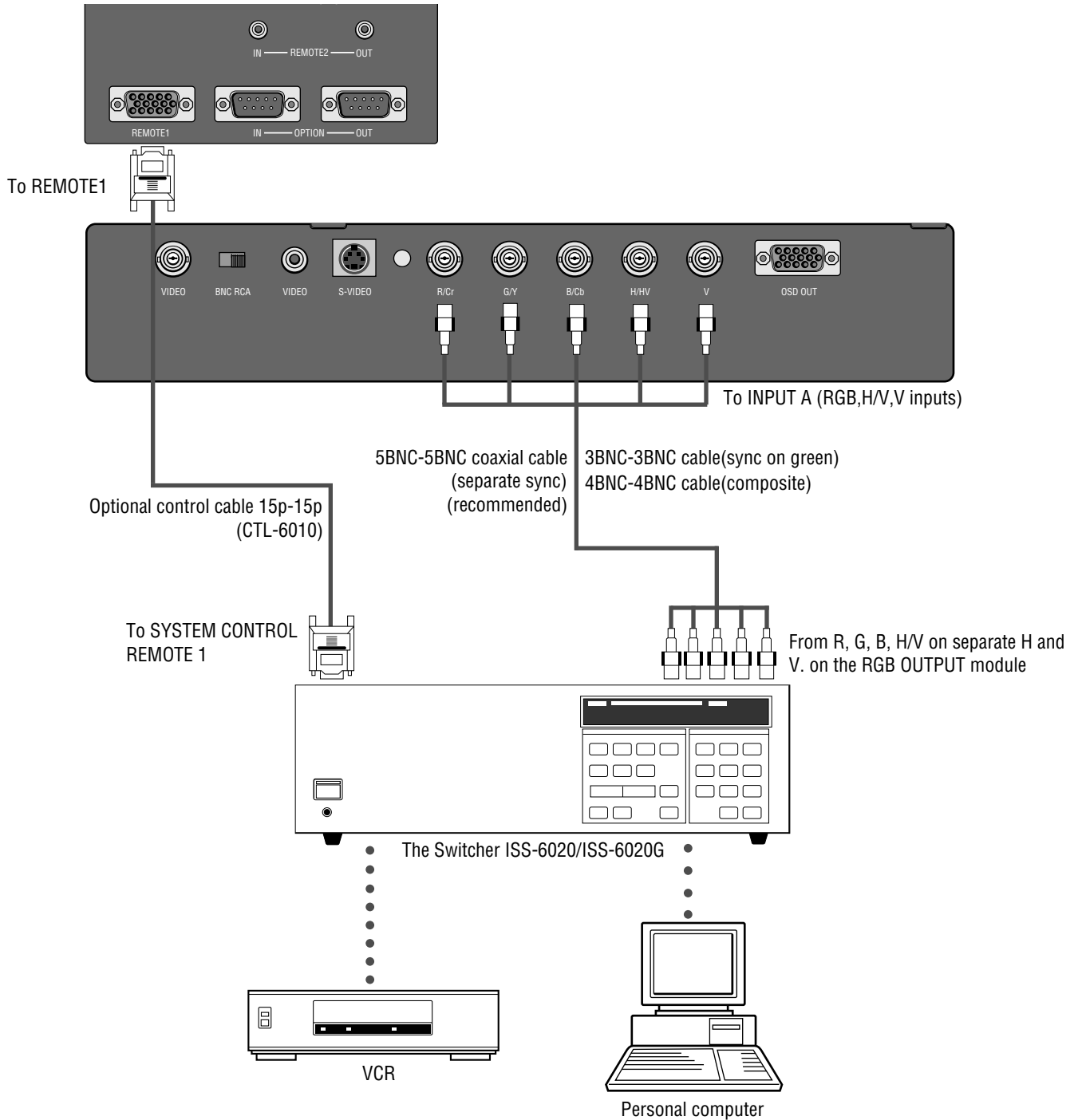

- Make sure that the SW1 LEVEL mode is selected from the CONNECT CONDITION menu. See page 71 for the information in detail.
- For more information on the Switcher, refer to the user's manual accompanying the ISS-6020/ISS-6020G Switcher.
- All cables mentioned above are optional.

## 2. INSTALLATION

### When Used with Two or More Switchers (100 Inputs)

Up to 100 inputs can be accepted using the Switcher.

#### How to make connections:

- ① Connect the REMOTE 1 terminal of the master Switcher to the REMOTE 1 of the projector using the optional control cable (15p-15p/CTL-6010).
- ② Next connect the REMOTE 2 terminal of the master Switcher to the REMOTE 1 terminal of the first slave Switcher using the same optional control cable as mentioned above. Third, connect the REMOTE 2 terminal of the first slave to the REMOTE 1 of the second slave, and the REMOTE 2 terminal of the second slave to the REMOTE 1 terminal of the third slave (— and the REMOTE 2 of the ninth slave to the REMOTE 1 of the tenth slave). Connect all the Switchers with optional control cables.

#### NOTE:

- Be sure to set all the slide switches (S8603) of the Switcher to RS-422 positions. Set the one on the last slave Switcher to the appropriate position to match the connected equipment such as a personal computer. (RS-422/RS-232C for PC control of projector)
- Set the DIP switch S8601 of the Switcher.

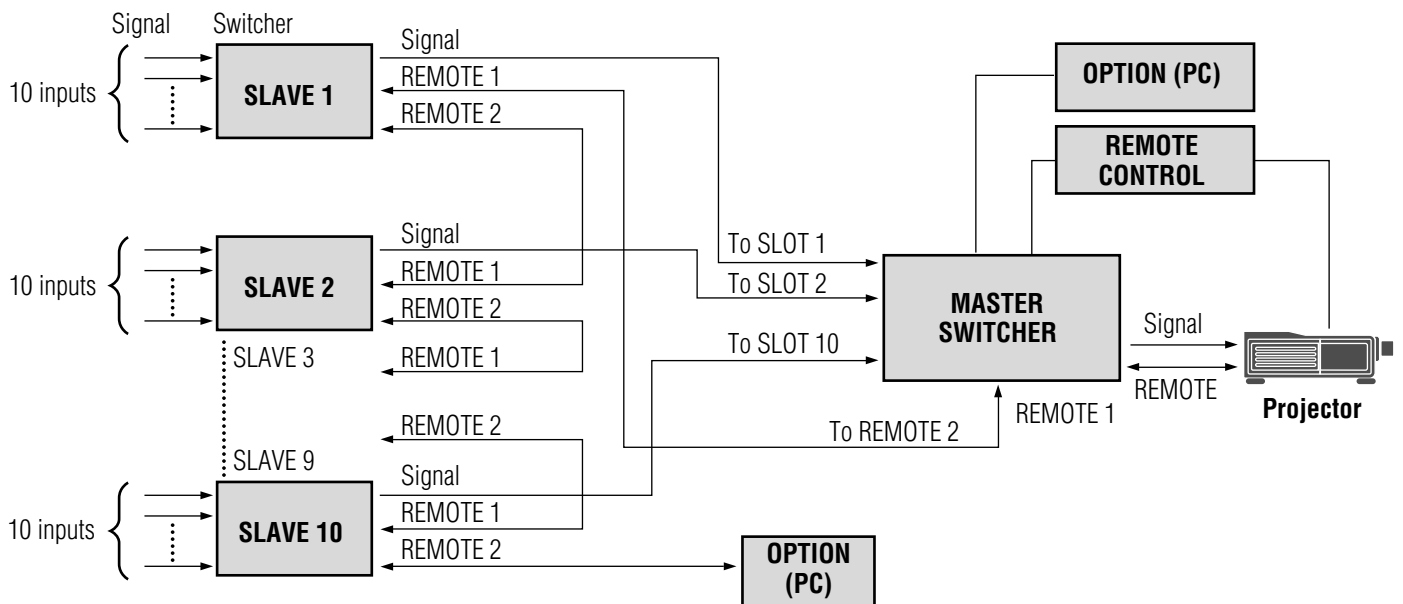

- Make sure that the SW2 LEVEL mode is selected from the CONNECT CONDITION menu. See page 71 for the information in detail.
- Refer to the user's manual accompanying the Switcher.
- Cables mentioned are not included with the projector.

Set the DIP switch (S8601) of the Switcher as follows:

**NOTE:** Slave numbers 1 to 10 must correspond to the master's slot numbers 1 to 10.

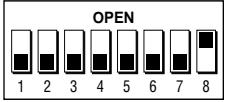
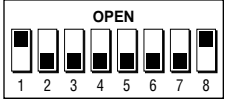
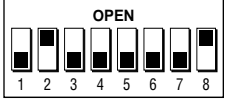
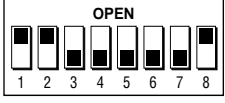
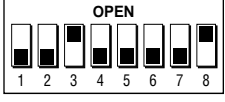
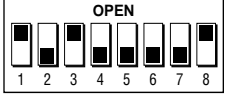
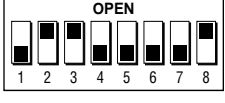
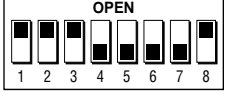
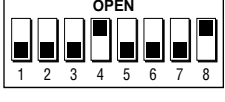
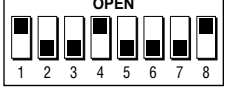
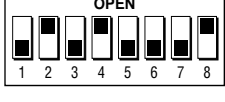
ISS-6020 ISS-6020G	Output to	Setting of S8601
<b>Master</b>	The Projector	
<b>Slave 1</b>	Slot 1 of the Master	
<b>Slave 2</b>	Slot 2 of the Master	
<b>Slave 3</b>	Slot 3 of the Master	
<b>Slave 4</b>	Slot 4 of the Master	
<b>Slave 5</b>	Slot 5 of the Master	
<b>Slave 6</b>	Slot 6 of the Master	
<b>Slave 7</b>	Slot 7 of the Master	
<b>Slave 8</b>	Slot 8 of the Master	
<b>Slave 9</b>	Slot 9 of the Master	
<b>Slave 10</b>	Slot 10 of the Master	

## 2. INSTALLATION

### REMOTE 1 Terminal

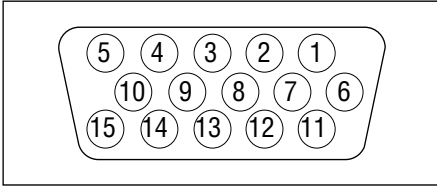

This terminal is used for either connecting the ISS-6020/ISS-6020G Switcher or a third party external control device. When the Switcher is used, connect it with the optional control cable (15-15 pin; 50 ft./16m; CTL-6010) to this terminal.

#### When used with the Switcher.

Pin No.	FUNCTION
1, 2, 6 and 7	Sending and receiving data when the Switcher is used.
9	Identifying the Projector
15	Ground
Others	Used inside the Projector. Normally set to OPEN.

When using with the Switcher ISS-6020/ISS-6020G, connect no. 1,2,6,7,9 and 15 pins of the projector to the same no. pins of the switcher as shown below.

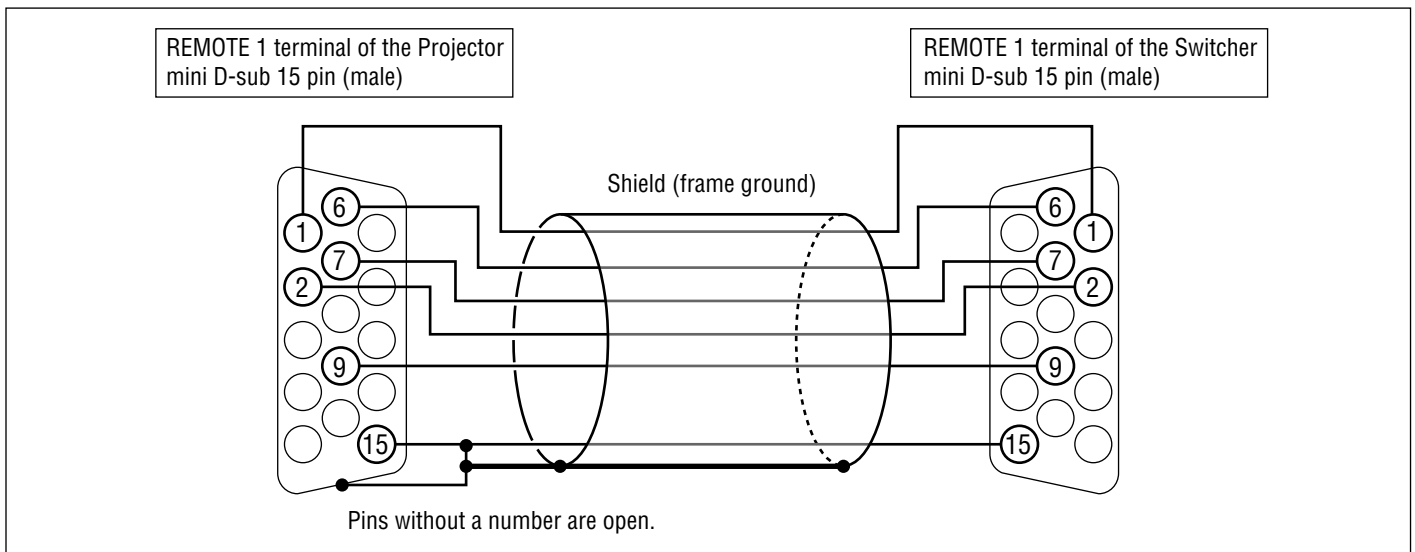

**Pin Configuration of Optional CTL-6010 Cable**



**When used in stand alone operation.**

Pin No.	SHORT/OPEN				FUNCTION
14	SHORT OPEN				External control mode ON External control mode OFF
5	SHORT OPEN				POWER ON POWER OFF
10	SHORT OPEN				PICTURE MUTE ON PICTURE MUTE OFF
4,8,11,12	11	12	8	4	INPUT-A RGB VIDEO S-VIDEO COMPONENT COMPONENT(HDTV)
	OPEN	OPEN	OPEN	OPEN	
	OPEN	OPEN	OPEN	SHORT	
	OPEN	OPEN	SHORT	OPEN	
	OPEN	OPEN	SHORT	SHORT	
	OPEN	SHORT	OPEN	OPEN	
	OPEN	SHORT	OPEN	SHORT	INPUT-B RGB VIDEO S-VIDEO COMPONENT COMPONENT(HDTV)
	OPEN	SHORT	SHORT	OPEN	
	OPEN	SHORT	SHORT	SHORT	
	SHORT	OPEN	OPEN	OPEN	
	SHORT	OPEN	OPEN	SHORT	
	SHORT	OPEN	SHORT	OPEN	INPUT C RGB VIDEO S-VIDEO COMPONENT COMPONENT(HDTV)
	SHORT	OPEN	SHORT	SHORT	
	SHORT	SHORT	OPEN	OPEN	
	SHORT	SHORT	OPEN	SHORT	
SHORT	SHORT	SHORT	OPEN		

The term "SHORT" means to connect with pin 15

- When in the external control mode, the POWER, INPUT and PICTURE MUTE buttons on the remote control will not function.

**NOTE:** Pin 13 is the external remote signal terminal. The projector can be controlled by the same format signal as the supplied remote control from the external controller regardless of setting Pin 14.

**NOTE:** When turning off the power to the projector using the external control, do not disconnect the plug from the power outlet. These procedures are to protect your projector and the connected equipment.

## 3. OPERATION

---

This section describes how to select a computer or video source and how to adjust the picture and sound, register a new signal and other settings and adjustments for set-up

### General Controls

Before you turn on your MultiSync Hivid 3500 Projector ensure that the computer or video source is turned on and that your lens cap is removed.

#### 1. Turn On The Projector

The breaker switch and the main power switch are on the back panel of the MultiSync Hivid 3500 Projector. By turning these switch on, the projector will go into its standby mode and the POWER ON/STANDBY indicator will glow red. Only after you press the 'On' button on the remote control or projector cabinet will the POWER ON/STANDBY light turn to green and the projector become ready to use.

#### 2. Select The Computer Or Video Source

Press the INPUT button on the remote control to display the image. Or press the Operate button on the remote control and use the Source Selection to select your video source: Video, S-Video, RGB or Y/Cr/Cb.

**NOTE:** When the message "New Signal" is displayed, register the signal in the Source Registry menu.

#### 3. Adjust The Image and The Sound

Press the PIC CTL button on the remote control or use the Operate-Picture Control menu to adjust the picture. Press the SOUND CTL button on the remote control or use the Operate-Sound Control menu to increase or decrease the volume.

#### 4. Turn Off The Projector









First press the POWER button on the remote control or the projector cabinet. The STANDBY light will glow. Allow the fan to cool the projector for three minutes. This will extend the life of the lamp. Then turn off the main power switch on the back panel. The power light will go out. Last turn off the breaker switch on the back panel.

#### **IMPORTANT:**

- The projector should be unplugged if it will not be used for an extended period.
- If you want to turn off the image briefly (five minutes or less), press the PIC MUTE button instead of turning the projector off and on.
- The projector will display a message "No Signal !!" if no input signal is present.
- Do not turn the projector off and then immediately back on. The Projector needs to cool down for three minutes before it is powered on again.

**CAUTION:** Do not unplug the projector or turn off the main power while the cooling fan is on and the "--" on Two Digit display is blinking for three minutes.

## Using The On-Screen Menus

1. Press the OPERATE or ADJUST button on the remote control to display the Operate or Adjust menu.
2. Use the  or  button on the remote control to highlight the "1. Ope.", "2. Adj." or "3. Help" in yellow and the selected menu will drop down.
3. Press the  or  button to highlight the item you want to adjust or set in the selected menu.
4. Press the ENTER button on the remote control to select the item.
5. Adjust the level or turn the selected item on or off by using the   or   buttons on the remote control. The on-screen gauge will show you the amount of increase or decrease.
6. Press the STORE button on the remote control to store the change.

**NOTE:** The change is stored automatically when the Automatic Save ("Auto Data Store") Feature mode is set to "ENABLE" See page 64.

7. Repeat steps 2-5 to adjust an additional item, or press the END button on your remote control to quit.

## On Adjustment Mode

The Adjustment mode contains various adjustment items for set-up. Open the Adjustment menu and select the item you wish to adjust. To display the ADJUST menu, proceed as follows:

- ① Press the ADJUST button.
  - The projector may ask for your passcode.
- ② Enter your registered passcode.

### When a passcode has not been registered:

- Since no passcode is programmed at the factory, pressing the ADJUST button will open the Adjustment menu.
- See "Entering Passcode", "Registering Passcode", "Changing Your Passcode" and "Canceling Your Passcode" on pages 52 through 58.

### When your passcode has already been registered:

- When finishing the Adjustment mode, the "RETURN USER MODE?" menu will be displayed. If you select "Yes" and press ENTER to end the Adjustment mode, you will have to enter your passcode to re-enter the Adjustment mode.
- When finishing the Adjustment mode by either selecting "No" or pressing END, you do not need to enter your passcode to re-enter the Adjustment mode. To exit the Adjustment mode temporarily during adjusting, select "No".

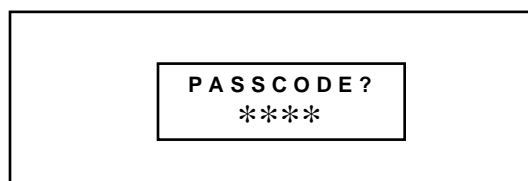

### 3. OPERATION

#### Menu Descriptions & Functions

Access of all set-up functions is done through the menu system. Depending upon button selection, your desired screen will be displayed as shown below:

**NOTE:** Some function items will not be available on the input video signal or connected peripheral equipment. Functions not available are indicated in gray.

Operate Menu	Adjust Menu	Help Menu
1. Ope. 2. Adj 3. Help	1. Ope. 2. Adj 3. Help	1. Ope. 2. Adj 3. Help
-Operate- 1. Source Select 2. Source Information 3. Picture Control ▷ 4. Display Control ▷ 5. Image Control ▷ 6. Sound Control 7. Closed Caption 8. Timer Setting ▷	-Adjustment- 1. Source Registry ▷ 2. Amplitude 3. White Balance 4. Signal Level 5. Uniformity ▷ 6. Display Function ▷ 7. Lamp Mode 8. Set Option ▷	-Help- 1. Help 2. Topics 3. Set Information

Typical keys on the remote control work as follows:

**OPERATE** : Accesses the Operate menu.

**ADJUST** : Accesses the Adjust menu.

◀ : Selects the next upper item in the menu. Or increases the adjustments.

▶ : Selects the next lower item in the menu. Or decreases the adjustments.

◁ : Selects the next right side item in the menu or task bar. Or increase the adjustments.

▷ : Selects the next left side item in the menu or task bar. Or decrease the adjustments.

**ENTER** : Proceeds to the selected menu choice or to the selected adjustment.

**END** : Returns to the previous menu or exits the selected function.

**INPUT(1-10)** : Directly switches to the corresponding input or opens the corresponding sub menu or item.

#### About Task bar

The mens (Operate, Adjust or Help) has the common bar across the top of the menu. This is called the Task bar. A press of either of the OPERATE or ADJUST button on the remote control displays the task bar with the menu.

#### On-Screen Menu Elements:

**Highlight:** Indicates the selected menu in yellow; indicates the selected control in white back.

**Delta symbol (▷) in the menu or sub menu:** Indicates further choices are available. Use the ENTER button to open the pull-down menu.

**Inverted delta symbol (▽) in the adjustment or setting screen:** Indicates further choices are available. Use the ENTER button to open the pull-down menu. Note that a solid inverted delta symbol (▼) indicates the item is currently selected.

## Storing Projector Settings (Automatic Save Feature)

You have two options to store projector settings in the memory: automatically and manually.

\* The Automatic Save Feature mode has been set to "DISABLE" by factory. For information on setting, see "Automatic Auto Data Store" on page 64.

■ When the Automatic Save Feature mode is set to "ENABLE", projector settings will be stored in the projector's memory automatically.

Settings are stored automatically when any one of the following procedures is performed:

- One input is switched to another.
- The projector is turned off.
- After every 10 minutes of elapsed time.

■ When the Automatic Save Feature mode is set to "DISABLE", projector settings can be stored in the projector's memory manually.

When you try to return the source screen by pressing END several times, the "STORE?" menu is displayed.

To manually save settings, proceed as follows:

1. Use the END button to display the "STORE" menu from the current adjustment screen or menu.
2. Use the CURSOR  or  button to highlight "Yes" or "No" and press ENTER.

### Items to select

- Yes ---- Overwrites the currently projected signal and saves the settings. Note that "Yes" is available only for registered signals.
- No ----- Does not save settings.

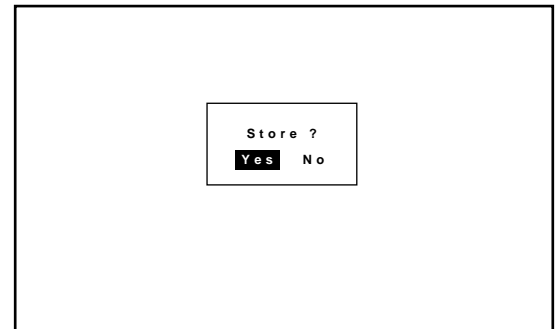



### 3. OPERATION







## Basic Operation (Operate Menu)

### Source Select

Enables you to select a source such as a VCR, laser disk player, DVD player, or computer.

- Use the CURSOR  or  button to highlight the source to be switched to and press the ENTER to the selected source.

#### NOTE:

- The Source Select menu has 10 pages. Each page consists of two sheets. Press the  or  button to go on to the next sheet or the previous sheet.
- To advance to the next page or to the previous page, hold down the CTL button then press the CURSOR  /  or  / . To directly access the page, hold down the CTL button then any one of the INPUT buttons.



PO1/10-1 Source Select StandAlone				
No	Name	Source	Input	Option
01				
02	NTSC	VIDEO	A	
03	78K	RGB	A	
04				
05	NTSC	VIDEO	C	
06	No40	RGB	A	
07	No39	RGB	A	
08	31.45K	RGB	A	
09	A	VIDEO	C	
10		VIDEO	B	

Output Data:List No.xxx

PO1/10-2 Source Select StandAlone				
No	Date	fh	fv	Key
01				
02		15.74	60.07	CTL+10
03		78.36	72.28	
04				
05		15.74	60.07	
06		37.93	60.52	
07		37.55	75.10	
08	Jan/01/1998	31.48	59.96	CTL+5
09	Jan/01/2000	15.35	51.85	
10	Jan/01/2040	15.37	51.92	

Output Data:List No.xxx

To select a source using the INPUT buttons on the remote control when no menus are displayed:

- 1) Press the INPUT "0" button.
  - The Select Terminal menu is displayed.
- 2) Use the CURSOR  or  button to select an input terminal you wish to input.
- 3) Press the ENTER button to execute selection and to switch to the selected input. To cancel, press any one of the INPUT buttons.

### INPUT SELECT List Format

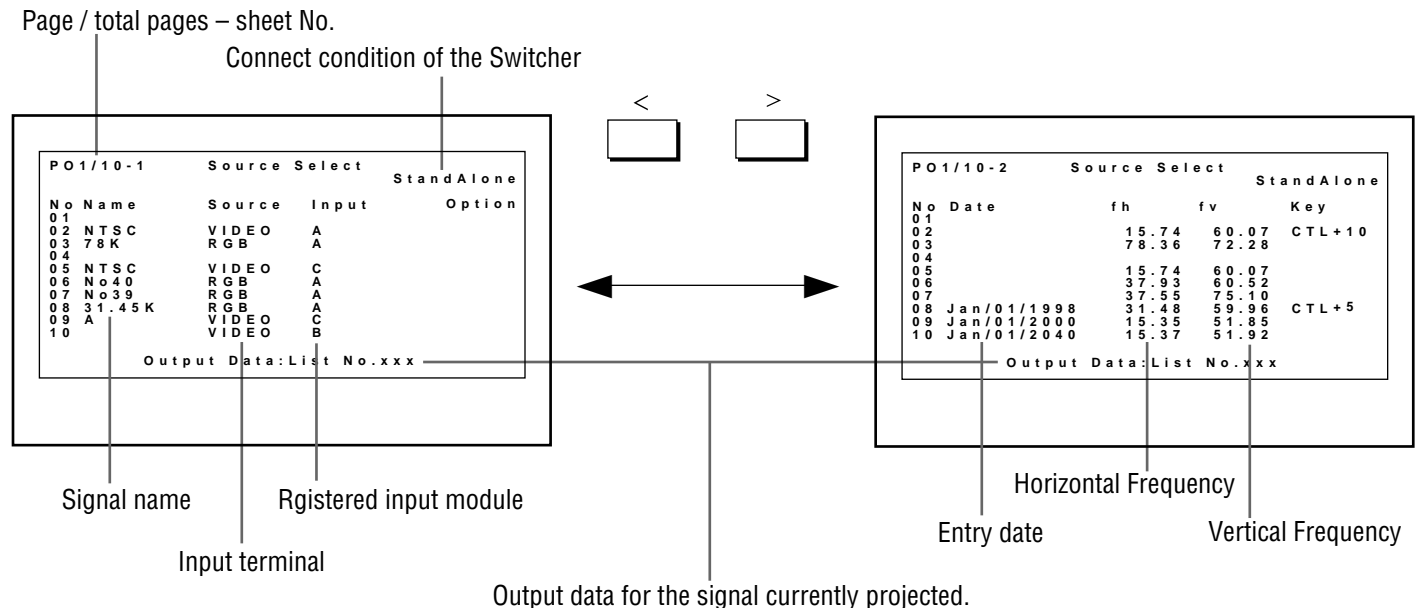

**NOTE:**

- While you are viewing a source screen, you can also select the input signal directly by pressing the INPUT “1” through “10” button. In this case INPUT buttons function as follows:

**When using the projector in stand alone operation:**

Input Mode Input Module	RGB	VIDEO	S-VIDEO	COMPONENT	COMPONENT (HDTV)	Slot Selection
A	1	2	3	4	5	10

Numbers designate INPUT buttons on the remote control.



**When using the projector with the ISS-6020/ISS-6020G:**

INPUT 1 through 10 → Selects the corresponding number slot of the ISS-6020/ISS-6020G

**When using the projector with two ISS-6020/ISS-6020G or more:**

To switch to another input signal, enter the master slot number, then the slave slot number by using INPUT buttons and press ENTER.

Example: If you want to select a signal from the no.3 slot of the slave Switcher which is connected to the no.2 slot of the master Switcher, first press the INPUT “2” button, then the INPUT “3” button and then press ENTER.

- You can switch to any input signal of NO 01 through 10 on the Source Select list by holding down the CTL button and pressing one of the INPUT buttons corresponding to the input number. To activate this function you must first select ENABLE in the Direct Key. For further details, contact your dealer.
- If there are two or more memory locations that contain the same signal information the projector will reference the signal nearest the beginning of the list. To select the next signal use the CURSOR  or  button and press ENTER.

### 3. OPERATION

#### Source Information

Provides and changes information for the parameters of your current projected source.

**NOTE:** For other registered signals, change their parameters on the Source Registry menu.

The menu items you can display, change or specify are as follows:

Source Name -----	Changes a user name that has previously been entered.
Direct Key -----	Assigns settings of source to each INPUT button (1-10) with CTL.
Input Slot -----	Selects an input terminal for the registered signal when you need to do due to adding optional equipment.
Signal System -----	Displays the signal system of the current source such as RGB, Video, S-Video, or Component signal.
Video System -----	Displays the current video standard.
Sync Frequency (H/V) -----	Displays the current sync frequency.
Sync Polarity (H/V) -----	Displays the current sync polarity.
Sync System -----	Selects the detection method of the sync signal.
Sync Termination -----	Selects the impedance of the sync signal.
Display Mode -----	Selects the image display mode.
Color Matrix -----	Selects the mode to match the output format of an HDTV or DVD signal.
CTI Control ----- (Color Transient Improvement)	Turns this feature on so you can make the color sharper.
Noise Reduction -----	Turns this feature on so video noise can be reduced.
Stadium Mode -----	Selects this feature so the picture is expanded in the horizontal and vertical directions at different ratios.
Source Select Counter -----	Resets the number of times a signal is selected for display.
Source Display Timer -----	Resets the time of signal display.

Source Information Page 1 / 2 (List No. 99)	
Source Name	[ NTSC3.58 ]
Direct Key	[ CTL+10 Key <input checked="" type="checkbox"/> ]
Input Slot	[ INPUT A <input checked="" type="checkbox"/> ]
Signal System	S-VIDEO
Video System	NTSC3.58 Cinema
Sync Frequency	fH = 15.74 KHz fV = 61.23 Hz
Sync Polarity	HD(+) VD(+)

Source Information Page 2 / 2 (List No. 99)	
Sync System	[ Auto <input checked="" type="checkbox"/> ] H/V Separate
Sync Termination	[ Hi-Z <input checked="" type="checkbox"/> ]
Display Mode	[ 00:NTSC <input checked="" type="checkbox"/> ]
Color Matrix	[ Y,B-Y,R-Y <input checked="" type="checkbox"/> ]
CTL Control	[ OFF <input checked="" type="checkbox"/> ]
Noise Reduction	[ OFF <input checked="" type="checkbox"/> ]
Stadium Mode	[ Normal <input checked="" type="checkbox"/> ]
Select Counter	0000
Display Timer	0000H 00M

Use the CURSOR  or  button to select the item you want to view or set.



The following items can be set:

### ■ Source Name

To change the source name or input a new source name by selecting one character at a time with the INPUT buttons 1 through 10 and by moving the cursor with the CURSOR button. Only after completely finishing the selection of the characters, press ENTER.

- If you have made an error, use the CURSOR button and reenter the correct letter or number.

To delete one character, move the highlight to the character to be deleted and then press the NORMAL button.

To delete all the entered name, hold down the CTL button then press the NORMAL button.

- The above is the same procedure of the signal entry. See To change the source name or input a new source name by selecting one character at a time with the INPUT buttons 1 through 10 and by moving the cursor with the CURSOR button. Only after completely finishing the selection of the characters, press ENTER.

To delete one character, move the highlight to the character to be deleted and then press the NORMAL button.

To delete all the entered name, hold down the CTL button then press the NORMAL button.

- The above is the same procedure of the signal entry. See pages 45 and 46 for more details.

### ■ Direct Key

Use the CURSOR buttons to assign settings of a source to each of the 10 INPUT buttons with CTL.

### 3. OPERATION

#### ■ Input Slot

You can select the input terminal for the registered signal. This feature is useful when you need to change the input terminal due to adding optional equipment.

**NOTE:** This setting cannot be done to the current projected signal.

#### When used in the stand alone operation:

Use the CURSOR  or  button to select an input slot from three slots: INPUT A, INPUT B, and INPUT C, and press ENTER.

#### Items to select

- INPUT A ..... Standard installed terminal
- INPUT B ..... Optional board terminal
- INPUT C ..... Optional board terminal

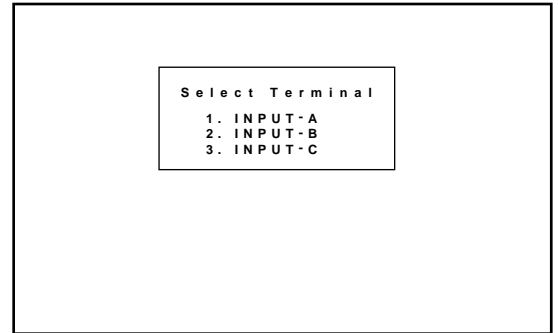

#### When used with a single Switcher ISS-6020/ISS-6020G:

Use the CURSOR  or  button to select the desired slot number "1" through "10" of the Switcher and press ENTER.

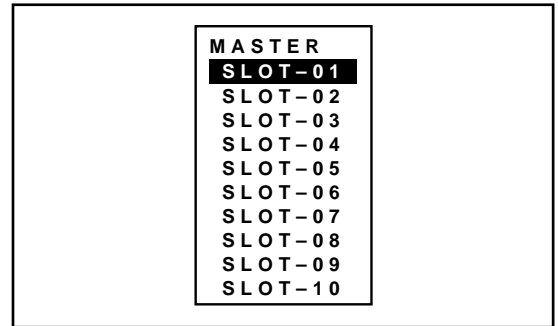

#### When used with two or more Switchers ISS-6020/ISS-6020G:

Use the CURSOR  or  button to select the master slot number "1" through "10" first from the master menu, then select the slave slot number "1" through "10" from the slave menu and press ENTER.

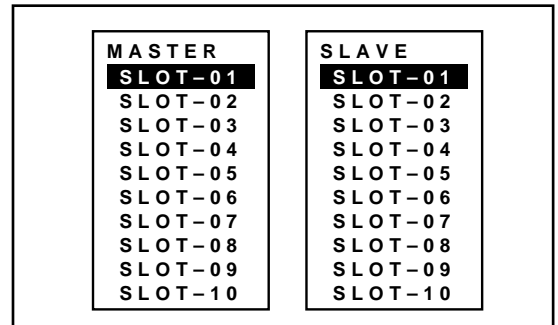

## ■ Sync System

This function is used to select the detection method of the sync signal for an RGB signal.

Use the CURSOR  or  button to select "AUTO", "G-SYNC", or "TRI-SYNC" and press ENTER.

- When "AUTO" is selected, the sync type will be displayed.
- Select "AUTO" in normal operation.

### On-screen display

- AUTO ----- Detects automatically a composite or HV separate sync signal.
- G-SYNC ----- Selects sync on green signal.
- TRI-SYNC ---- Selects a tri-sync signal (HDTV signal).

## ■ Sync Termination

This functions is used to select the impedance of the sync signal.

Use the CURSOR  or  button to select "75 Ω" or "Hi-Z", then press ENTER.

**NOTE:** The default setting is "75 Ω".

This should be "75 Ω" for normal use. Select the "Hi-Z" when inputting a TTL signal.

## ■ Display Mode

This function is used to select the image display mode such as VGA, SVGA or Mac.

Use the CURSOR  or  button to select the desired mode and press the ENTER button.

## ■ Color Matrix

This function is used to select the mode to match the output format of an HDTV or DVD signal.

Use the CURSOR  or  button to select the appropriate mode and press the ENTER button.

## ■ CTI(Color Transient Improvement) Control

This functions is used to turn this feature on so you can make the color sharper.

Use the CURSOR  or  button to select either On or Off and press the ENTER button.

## 3. OPERATION

---

### ■ Noise Reduction

This function is used to turn this feature on so video noise can be reduced.

Use the CURSOR  or  button to select either On or Off and press the ENTER button.

### ■ Stadium Mode

This feature is used to select this feature so the picture is expanded in the horizontal and vertical directions at different ratios.

Use the CURSOR  or  button to select either Stadium or Normal and press the ENTER button.

### ■ Source Select Counter

This is used to reset the number of times a signal is selected for display.

When "Source Select Counter" is selected, the message "Do you want to reset the Source Select Counter ? Yes No" is displayed.

Use the CURSOR , ,  or  button to select either Yes or No and press the ENTER button.

### ■ Source Display Timer

This function is used to reset the time of signal display.





When "Source Display Time" is selected, the message "Do you want to reset the Source Display Timer ? Yes No" is displayed.

Use the CURSOR , ,  or  button to select either Yes or No and press the ENTER button.

## Picture Control

Provides access to controls for your image such as brightness, contrast, color, sharpness, hue, color temperature, gamma correction.



**NOTE:** Color, tint, and sharpness are available for an RGB source only.



1. Use the CURSOR , ,  or  button to select the item you want to adjust and press the ENTER button.

### Items to select







- Brightness ----- Adjusts the overall image and background screen brightness.
- Contrast ----- Adjusts the image brightness in relation to the background.
- Color ----- Adjusts the color intensity of the image.
- Sharpness ----- Adjusts the detail of the image.
- Hue ----- Adjusts the red and green values of the image.
- Color Temperature --- Adjusts the color temperature.
- Gamma Correction --- Adjusts the brightness of a dark area on the screen.

2. Use the CURSOR buttons to adjust the picture to your desired setting.

The CURSOR  or  button increases the level.

The CURSOR  or  button decreases the level.

\*For Gamma Correction, follow the instructions below.

1. Use the CURSOR  or  button to select either "Table" or "User Table" and press the ENTER button.
2. Use the CURSOR / or / button to select your desired mode and press the ENTER button.

### -Picture Control-

1. **Brightness**
2. Contrast
3. Color
4. Sharpness
5. Hue
6. Color Temperature
7. Gamma Correction

### Gamma Correction



Table [Default1 

User Table [1.0 

### 3. OPERATION

## Display Control



Enables you to fine tune the computer image or to remove any vertical banding that might appear by adjusting the clock frequencies, and to adjust the clock phase or to reduce video noise, dot interference or cross talk. This also allows you to pan or zoom in/out the image.

Use the CURSOR  or  button to select the item you want and press the ENTER button.

### Items to select



- Pixel Clock ----- Adjusts the clock frequencies to remove moire.
- Pixel Phase ----- Adjusts the clock phase to reduce video noise.
- Zoom/Pan ----- Magnifies or reduces the image. You also can pans the display when pressin with CTL.



### ■ Pixel Clock / Pixel Phase





The CURSOR  or  button increases video noise.

The CURSOR  or  button decreases video noise.

### ■ Zoom/Pan

The CURSOR  or  button enlarges the image or reduces the image.

The CURSOR  or  button enlarges the image or reduces the image.

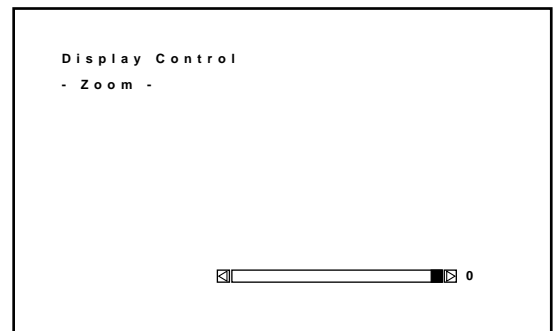
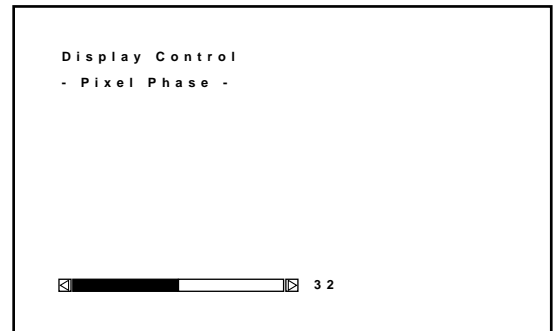
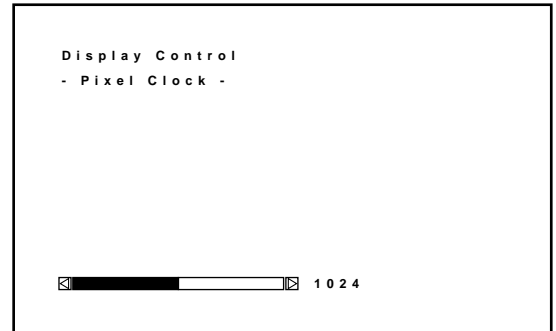

CTL+ , ,  or  button pans the image.

**-Display Control-**  
**1. Pixel Clock**  
**2. Pixel Phase**  
**3. Zoom/Pan**



## Image Control

Enables you to adjust the image position and blanking.



Use the CURSOR  or  button to select the item you want to adjust and press the ENTER button.



### Items to select

- Image Position ----- Adjusts the image position.
- Blanking ----- Adjusts the screen area.

**-Image Control-**  
**1. Image Position**  
**2. Blanking**

### ■ Image Position

Pressing the CURSOR  or  moves the position of the picture left or right.

Pressing the CURSOR  or  moves the position of the picture up or down.

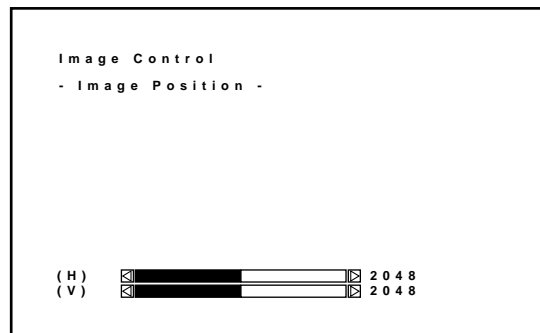



### ■ Blanking



Press any one of the CURSOR buttons while press and hold CTL to select the position you want to adjust:



CTL+  ----- Top



CTL+  ----- Right



CTL+  ----- Left

CTL+  ----- Bottom

Top and right ----- Pressing  or  increases the adjustment values.

Pressing  or  decreases the adjustment values.

Bottom and left ----- Pressing  or  increases the adjustment values.

Pressing  or  decreases the adjustment values.

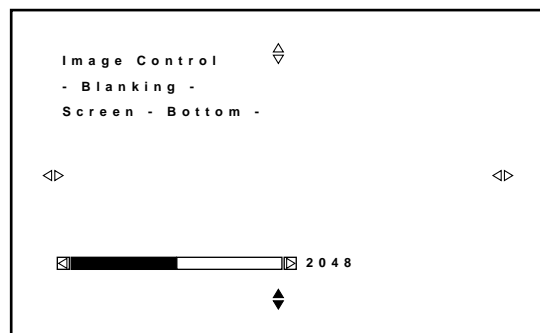





### 3. OPERATION

#### Sound Control (only when used with the ISS-6020/ISS-6020G Switcher)

Provides access to control for your sound volume.

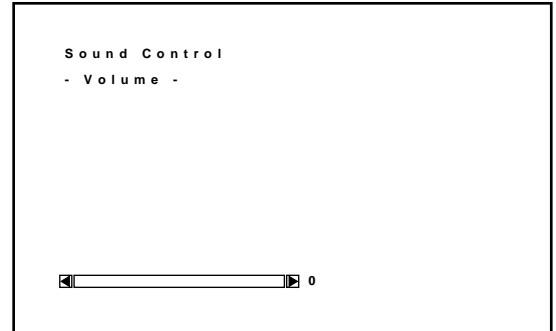

**NOTE:** This function works only with the ISS-6020/ISS-6020G Switcher.

The CURSOR  or  button increases the volume.  
The CURSOR  or  button decreases the volume.



#### Closed Caption

Enables you to set several closed caption modes for text to be superimposed on the projection screen.

Use the CURSOR  or  button to select the desired mode and press the ENTER button.

##### Items to select

- Caption 1-4 ----- Text is superimposed.
- Text 1-4 ----- Text is displayed in full screen.
- Off ----- Exits the selected Closed Caption mode.

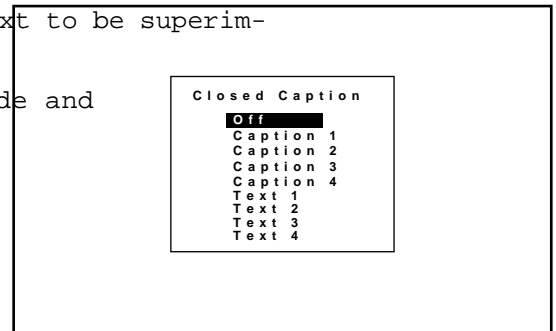

##### NOTE:

- The Closed Caption feature work with an NTSC 3.58 source only.
- Pressing ENTER executes store function. Switching to source other than NTSC3.58 source again.



## Timer Setting

Enables you to program to turn on or off your projector automatically at a specified time. The two timer functions are available: On/Off Timer and Sleep Timer.

**NOTE:** When the On Timer is set and the projector is in standby, the two digit indicator flashes "00" to indicate that the On Timer is active.

Proceed as follows:

- Before setting On/Off Timer, make sure that Date, Time Preset feature is set.
- Even after setting On/Off Timer, turning the projector on or off with the remote control is possible.
- There are two time display formats: 24-hour or AM/PM format. You can set either format in the "Date, Time Preset" in [Adjust - Set Option - Menu Mode].  
Use the CURSOR  or  button to select "On/Off Timer" or "Sleep Timer".

### Items to select

- On/Off Timer---Programs to turn on or off the power at a predetermined time.
- Sleep Timer---Programs to turn off the power at a predetermined time, up to two hours later in 30-minute increments.

To set the On/Off Timer:

- 1) Use the CURSOR  or  button to select On/Off Timer and press ENTER to display the On/Off Timer menu.

- 2) Select a program number and press ENTER to display the On/Off Timer Setting menu.

- 3) Set the Week, Day, On-Time and Off-Time using the CURSOR buttons and INPUT buttons (1 thru 10). To cancel the on-time or off time, press NORMAL.

### -Timer Setting- 1. On/Off Timer 2. Sleep Timer

On/Off Timer				
Prg	Week	Day	On Time	Off Time
1	1Week	Mon	09:00	12:00
2				
3				
4	Every	Mon-Fri	18:00	22:00
5				
6				
7				
8				
Execute Switch			[Inactive	<input checked="" type="checkbox"/>

On/Off Timer				
Prg	Week	On/Off Timer Setting	Time	0am
1	1We	Program 1		
2		Week	[1Week	<input checked="" type="checkbox"/>
3		Day	[Mon	<input checked="" type="checkbox"/>
4	Every	On Time	[00:00]	
5		Off Time	[00:00]	<input checked="" type="checkbox"/>
6		Entry Cancel Clear		
7				
8				

### 3. OPERATION

4) Select the Entry and press ENTER. This enables the On Timer or Off Timer function.

To cancel your data such as week, day, on/off time, select the Cancel and press ENTER.

To delete the setting data such as week, day and on/off time for the program number, select the Clear and press ENTER.

**NOTE:**

When setting On Timer during cooling the fan, the projector will turn on after the cooling has finished.

To set the Sleep Timer:

1) Use the CURSOR  or  button to select the Sleep Timer and press ENTER to display the Sleep Timer menu.

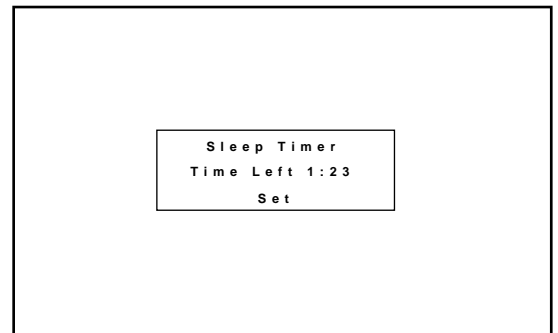

2) Select the Set and press ENTER to drop the pull-down menu.

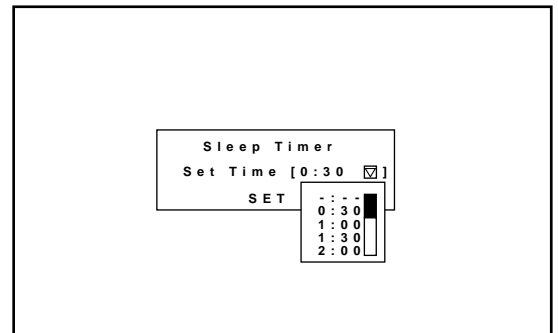

3) Select your desired time between 30 minutes and 2 hours in 30 minutes.

**NOTE:** "- : - -" indicates the Sleep Timer will not be used.

To enable your settings:

Select "Active" in Execute Switch and press ENTER.

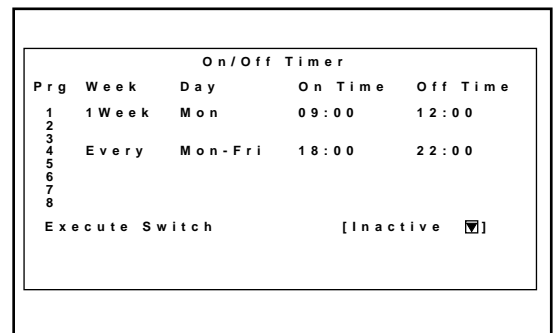

## Adjusting and Setting (Adjustment)

### Source Registry

#### On Source Registry

The projector uses a micro-processor to automatically read and distinguish between all video signals input at the same time. These signals are then used to make optimum adjustments for best image. Various parameters must be registered into the micro-processor beforehand to ensure the video signals are recognized and adjusted to optimum quality.



This function registers these video signals in the Source Select list and at the same time obtains the various parameters pertaining to these signals. Always access this mode first whenever inputting video signals for the first time so that you can register the video signals before making any adjustments. If the current input signal(s) has not been registered, the “New Signal” message is displayed on screen.

**NOTE:** If you have software which changes scanning mode due to the graphic board of your PC (such as VGA), it will be necessary to register signal entry for each scanning mode. This can be done using your PC by way of stopping the software in each scanning mode and performing a signal entry operation.

#### ■ Source Registry

When connecting a signal for the first time, you need to register it into the projector's memory. You can copy the initial setting for the new signal from any other signal that has already been registered or use the factory preset setting.

#### To make the signal entry, proceed as follows:

- ① Press the ADJUST button.
  - The Adjust menu is displayed.
- ② Use the CURSOR  or  button to highlight the “1.Source Registry” line and press ENTER.
  - The Source Registry menu will be displayed.
  - You can also select the Source Registry menu directly by pressing the INPUT “1” button.

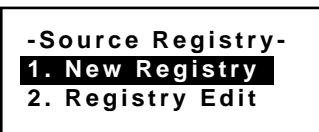
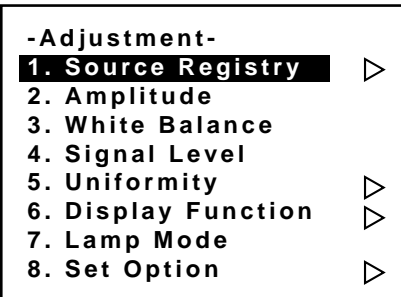

### 3. OPERATION

#### Items to select

- New Entry ----- Registers a new signal.
- Registry Edit. - Changes setting various parameters of the registered signals.

- ③ Use the CURSOR  or  button to highlight the “1.New Registry” line and press ENTER.
- The “1. Slot” menu is displayed. Then proceed as follows:
    1. Select slot.
    2. Select signal system.
    3. Set HDTV or not when selecting component signal.
    4. Input a user name.
    5. Select a location number for your registry.

To advance the next item, select Next  and press ENTER. To return the previous item, select  Prev and press ENTER. To cancel your registry, select Cancel.

#### 1) To Select a Slot

You have two steps depending on whether you use your projector on standalone or with the ISS-6020 switcher(s).

**NOTE:** The setting INPUT TERMINAL cannot be done to the current projected signal.

When using the projector in stand alone application:  
Use the CURSOR  or  button to select one of the three slots, and press ENTER.

#### Items to select

- INPUT A ---- Standard
- INPUT B ---- Optional board
- INPUT C ---- Optional board

#### When using with a single Switcher ISS-6020/ISS-6020G:

Use the CURSOR  or  button to select the input slot number of the Switcher and press ENTER.

- Input slot numbers are from 1 through 10.
- The “4. User Name” screen will be displayed when you finish entering the slot number.

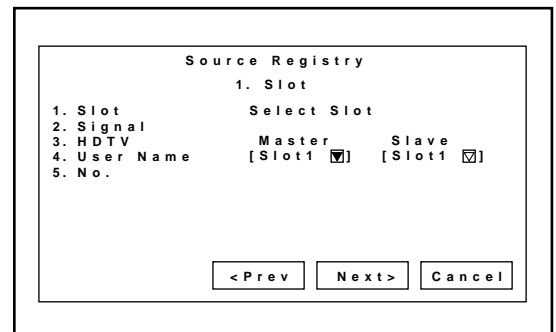
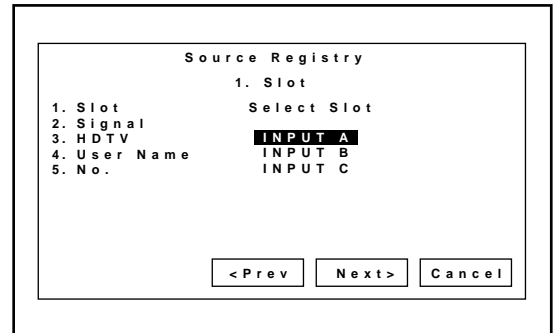

**When using with two or more ISS-6020/ISS-6020G switchers:**

Use the CURSOR or button to select the input slot number of the master Switcher and press ENTER. Then select the slot number of the slave Switcher and press ENTER.

- The “MASTER” menu will be displayed when the slot number of the master Switcher is selected.
- The “SLAVE” menu will be displayed when the slot number of the slave Switcher is selected.
- The “4. User Name” screen will be displayed when you finish entering the slot number.

**2) To Select Signal System**

Select your desired signal system.

Items to select	
• RGB -----	Selects the RGB input signal of this projector
• C-Video -----	Selects the VIDEO input signal of this projector
• S-Video -----	Selects the S-VIDEO input signal of this projector.
• COMPONENT	Selects the component input signal of this projector.

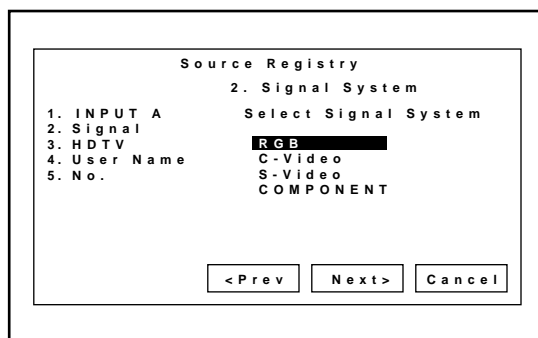

**3) To Set HDTV or not When Selecting Component Signal.**

When you select COMPONENT, you are asked if the component is HDTV or not.

Select Yes or No according to your component source.

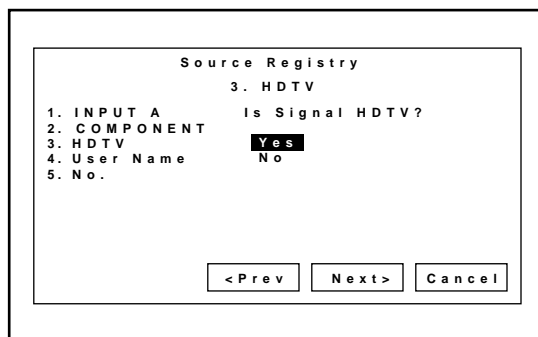

**4) To Input a User Name.**

Input the source name by selecting one character at a time with the INPUT buttons 1 through 10 and by moving the cursor with the CURSOR button. After finishing the selection of the characters, press ENTER.

- Up to eight characters can be selected.
- Eight characters are assigned to one INPUT button.
- Whenever the INPUT button is pressed, characters will be rotated.

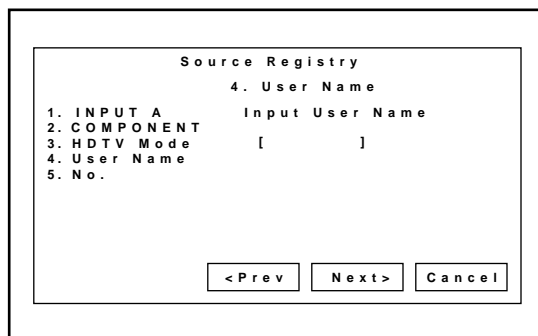

### 3. OPERATION

For example: A → B → C → 1 → A .....

- When pressing the INPUT button while holding down the CTL button, another group of characters will be rotated.

For example: a → b → c → ! → a .....

- The characters corresponding to these INPUT buttons are as follows:

When using With CTL

INPUT 1 A, B, C, and 1 a, b, c, and !

INPUT 2 D, E, F, and 2 d, e, f, and " INPUT 3 G, H, I, and 3 g, h, i, and #

INPUT 4 J, K, L, and 4 j, k, l, and \$

INPUT 5 M, N, O, and 5 m, n, o, and %

INPUT 6 P, Q, R, and 6 p, q, r, and &

INPUT 7 S, T, U, and 7 s, t, u, and " INPUT 8 V, W, X, and 8 v, w, x, and (

INPUT 9 Y, Z, ?, and 9 y, z, /, and )

INPUT 10 \*, ,, ., and 0 ;, :, +, and -

If you have made an error in the input of a character, use the CURSOR button and enter the correct letter or number.

To delete one character, move the CURSOR button to the character to be deleted and then press the NORMAL button.

To delete all the entered name, hold down the CTL button then press NORMAL.

#### 5) To Select a Registry Number.

Select the number location where you want to register the signal and press ENTER.

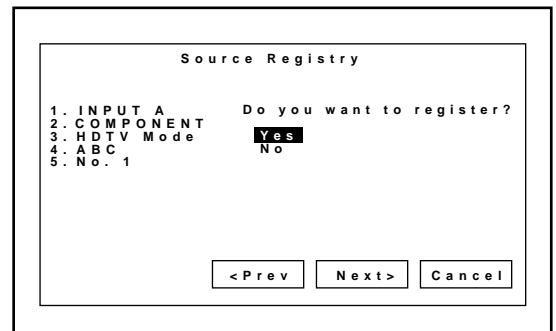
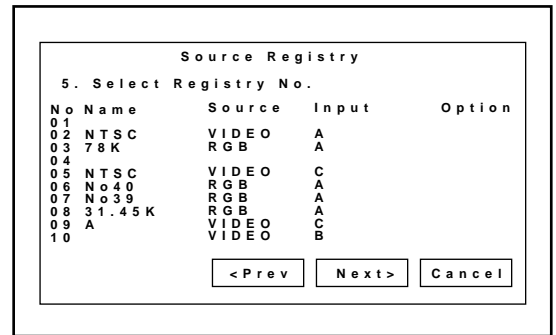

The "Do you want to register ?" message is displayed. If yes, press ENTER.



## ■ Registry Edit





This feature allows you to change various parameters of the source on the selected line. This can be done to the current projected signal as well as not projected source.

### To edit the registered signal, proceed as follows:

- 1) Press the ADJUST button.
  - The Adjust menu is displayed.
- 2) Use the CURSOR  or  button to highlight the “1.Source Registry” line and press ENTER.
  - The Source Registry menu will be displayed.
  - You can also select the Source Registry menu directly by pressing the INPUT “1” button.

#### Items to select

- New Entry----- Registers a new signal.
- Registry Edit----- Changes setting various parameters of the registered signals.

- 3) Use the CURSOR  or  button to highlight the “2. Registry Edit” line and press ENTER.
  - The “Registry Edit” screen is displayed.
- 4) Use the CURSOR  or  button to highlight the registered signal and press ENTER.
  - The “Edit Command” menu is displayed. Then proceed as follows:

- \* **Cut** Enables you to remove a selected signal from the list and place it on the “clipboard” in the projector.
- \* **Copy** Enables you to copy a selected signal from the list and place it on the “clipboard” in the projector.
- \* **Paste** Enables you to paste the signal placed on the “clipboard” to any other line of the list. To do this, select “Paste” and then select the line number you want to paste to. Last press ENTER.
- \* **Information** Enables you to set a various parameters. When “Information is selected, the Source Information screen is displayed. Select an item and press ENTER.

- 5) When setting is completed, press END.

**NOE:** The contents will leave the “clipboard” when you press END.



**Edit Command**  
**Cut**  
**Copy**  
**Paste**  
**Information**



### 3. OPERATION

#### Amplitude

Enables you to adjust the horizontal and vertical amplitude of the image.

NOTE: Normally use the normal value.

Use the CURSOR  or  to adjust the horizontal amplitude.

Use the CURSOR  or  to adjust the vertical amplitude.

When the amplitude adjusting is completed, press the END button.

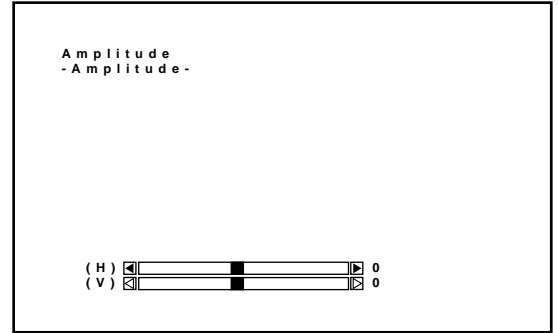





#### White Balance

Enables you to adjust the white balance of the image.

##### Items to select

- White/Red-Blue ----- Adjust the white level for the red or blue.
- Black/Red-Blue ----- Adjust the black level for the red or blue.

Use the CURSOR  or  to adjust the level of each item.

Use the CURSOR  or  to select an item.

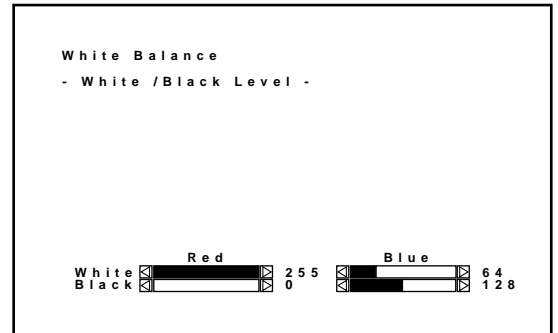

When the white balance adjusting is completed, press the END button.





#### Signal Level

Enables you to adjust the signal level.

**NOTE:** You can directly access the Signal Level by pressing the SIGNAL LEVEL button on the remote control.

Use the CURSOR  or  to adjust the level of each item.

Use the CURSOR  or  to select an item.

When the signal level adjusting is completed, press the END button.

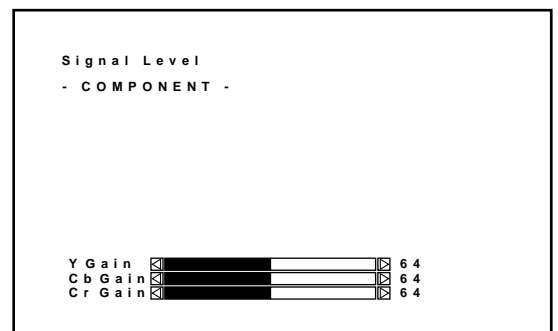
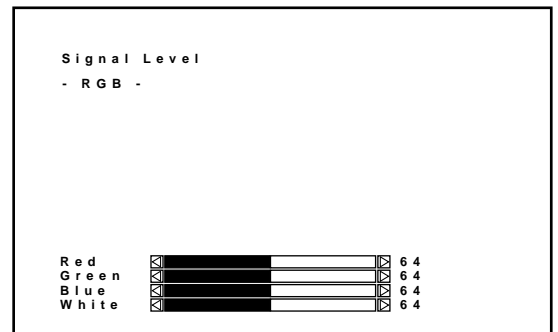











## Uniformity

Enables you to adjust the white uniformity and edge blending.

The white uniformity feature allows you to adjust color balance on the left and right side of the screen; the edge-blending feature allows you to adjust the brightness on the area which two images projected from the two projectors are overlapped.







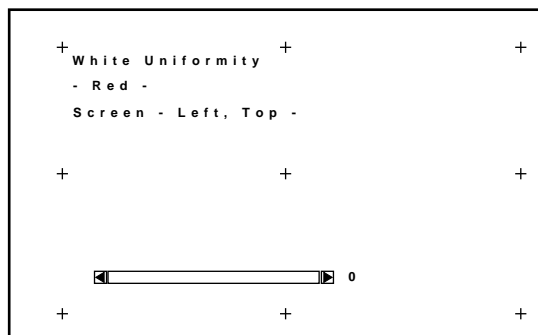





### -Uniformity- 1. White Uniformity 2. Edge Blending

#### To Adjust White Uniformity

- 1) Press R or B button while pressing and holding CTL to select the color you want to adjust. Note that Green is not available.
- 2) Move the cursor to the area you want to adjust using CURSOR button while pressing and holding CTL.
  - CTL +  moves the cursor to the right.
  - CTL +  moves the cursor to the left.
  - CTL +  moves the cursor up.
  - CTL +  moves the cursor down.
- 3) Use the CURSOR buttons to adjust the white uniformity.
  - Pressing  or  increases the level.
  - Pressing  or  decreases the level.
- 4) Repeat from the step 1 for the other color.



#### To Adjust the Edge Blending

- 1) Press the CURSOR buttons while pressing and holding CTL to select the area you want to adjust.
    - CTL +  selects the top
    - CTL +  selects the bottom
    - CTL +  selects the right
    - CTL +  selects the left
  - 2) Use the CURSOR  or  button to select "DATA" or "POS.".
    - "DATA" ----- Adjusts the level
    - "POS." ----- Adjusts the position
  - 3) Use the CURSOR  or  button to adjust the edge blending.
    - When "DATA" is selected:
      - Pressing  increases the level.
      - Pressing  decreases the level.
    - When "POS." is selected:
      - Pressing  moves the position to the top or the right.
      - Pressing  moves the position to the bottom or the left.
- To exit the Uniformity, press END.

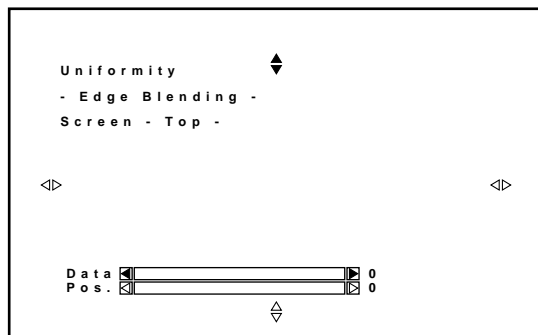

### 3. OPERATION

## Display Function

Enables you to adjust various items such as the field handling, interlace mode and sync protect if the image is not displayed correctly. Normally you do not need to set these items.

#### Items to select

- Field Handling ----- Sets the high refresh signal or interlace or both
- Interlace Mode ----- Selects the interlace mode.
- Sync Protect ----- Adjusts bending on the top of the screen.

#### 1) Field Handling

#### Items to select



- None. ----- Normally select this mode.
- Frame Drop (FD)----- Select this mode for a high refresh signal.
- Field Jam (FJ) ----- Select this mode for an interlace signal.
- FJ & FD ----- Select this mode for a high refresh interlace signal.



#### 2) Interlace Mode

Select the appropriate mode for an interlace signal viewing the image. Normally select the mode preset at the factory.

#### 3) Sync Protect

After selecting ON, adjust the bending of the top of the screen. Normally select OFF.

To adjust, use the CURSOR  or  to adjust the level viewing the screen.

To switch the top or the bottom, press the CURSOR  or  button.

**-Display Function-**  
**1. Field Handling**  
**2. Interlace Mode**  
**3. Sync Protect**

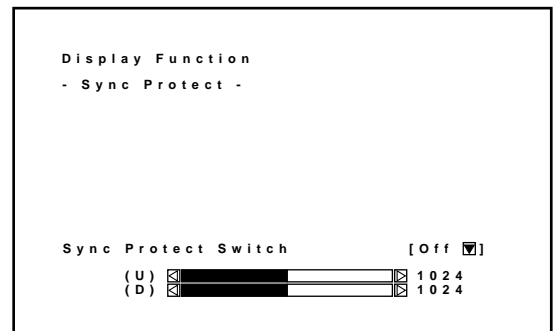
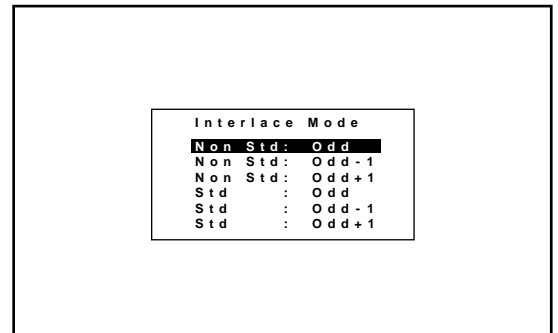
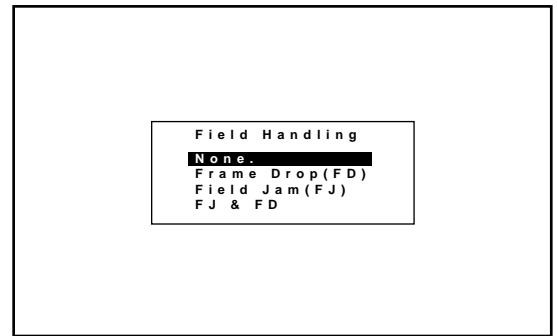

## Lamp Mode

Enables you to adjust the brightness of the lamp.

### Items to select

- Normal ----- Normally select this mode.
- High Bright ----- Select this mode to increase the brightness of the lamp.

**NOTE:** The High Bright mode shortens the lamp life. Be sure to use this mode at temperature 95 degrees F (35 degrees C) or less.



## 3. OPERATION

---

### Set Option

#### Passcode

##### ■ Entering Passcode

To prevent any unauthorized operation or mis-adjustment, the projector is equipped with a passcode option. If your passcode has not been entered correctly, the “Adjustment” menu will not be displayed. When the ADJUST button is pressed, and no passcode has been entered, the “Passcode?” screen is displayed. Enter your passcode.

To do this, proceed as follows:

- ① Press the ADJUST button.
  - The “Passcode?” screen is displayed.
- ② Enter the four digit passcode you have already registered by using the “1” through “10” buttons.
  - 1) Each time you press the INPUT button, an asterisk appears under the “Passcode?” message.
  - 2) After you have finished entering the four digit passcode, press ENTER.

**NOTE:** If you have made an error, press the NORMAL button to delete the asterisk “\*”. Then re-enter the correct passcode. To delete all the entered digits, hold down the CTL button then press the NORMAL button.

- 3) If the entered passcode is correct, the “ADJUST” menu is displayed.

**NOTE:** If the passcode is not correct, the “Warning Different Passcode!!” message is displayed and you are required to enter the correct passcode.



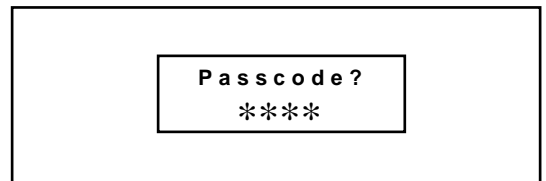



- ③ Proceed to each adjustment and setting.



## ■ Registering Passcode

When the projector is shipped from the factory, no passcode is registered. If you want to use the passcode option, you must register a passcode.

To register a new passcode, proceed as follows:

- ① Press the ADJUST button.
  - The “Adjustment” menu will be displayed.
- ② Use the CURSOR  or  button to highlight the “8.Set Option” menu. Press ENTER to display the Set Option menu.
- ③ Use the CURSOR  or  button to highlight the “1.Passcode” line. Press ENTER to display the “Passcode Setting” menu.
- ④ Use the CURSOR  or  button to select “Entry”. Press ENTER to display the “New Passcode?” menu.
- ⑤ Enter a four digit passcode using the “1” through “10” buttons.
  - 1) Each time you press the INPUT button, an asterisk will appear next to the “New Passcode?” message.
 

**NOTE:** “0000” and “9999” cannot be used as a passcode.
  - 2) Once you have finished entering your four digit passcode, press ENTER to store the code.
 

**NOTE:** If you have made an error, press the NORMAL button to delete the asterisk “\*”. Then re-enter the correct passcode. To delete all the entered digits, hold down the CTL button then press the NORMAL button.
  - 3) If the passcode has been entered correctly, the “Confirm New Passcode?” menu will be displayed.
 

**NOTE:** If the passcode is not entered correctly, the “Warning Passcode!!” message will be displayed. You will be required to enter the passcode correctly.

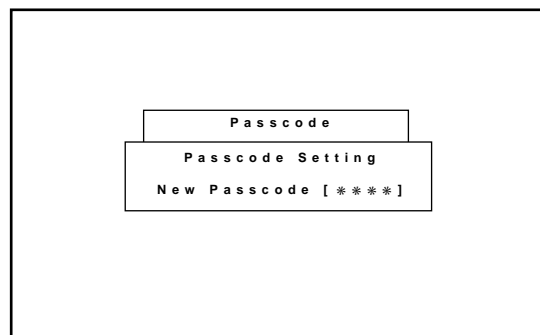
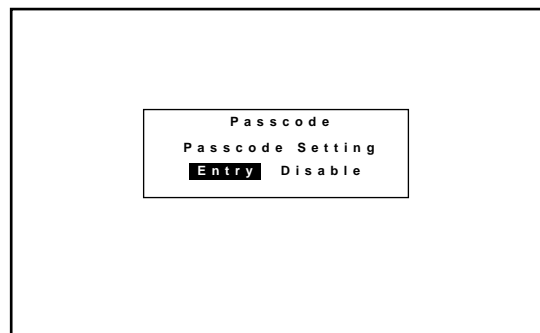
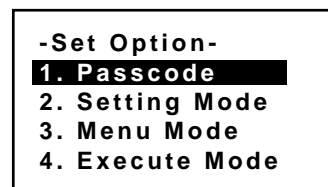
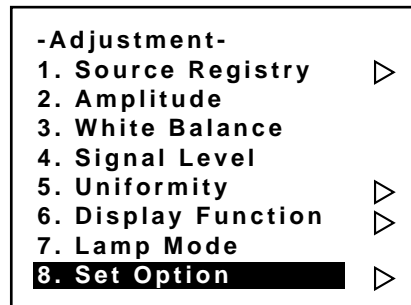

### 3. OPERATION

---

- ⑥ Enter the new passcode again.
- 1) Each time you press the INPUT button, an asterisk will appear next to the “Confirm New Passcode?” message.
  - 2) Once you have finished entering the new four digit passcode, press ENTER.

**NOTE:** If you have made an error, press the NORMAL button to delete the asterisk “\*”. Then re-enter the correct passcode. To delete all the entered digits, hold down the CTL button then press the NORMAL button.

- 3) If the entered passcode is correct, the “Change Passcode Complete!!” message will be displayed.





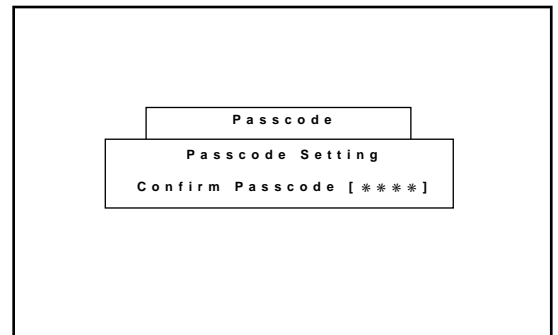

**NOTE:** If the passcode is not correct, the “Warning Different Passcode!!” message will be displayed. You are required to enter the new passcode correctly.

The new passcode has been registered.



## ■ Changing Your Passcode

To change your passcode, proceed as follows:

- ① Press the ADJUST button.
  - The “Passcode?” screen will be displayed.
- ② Enter the four digit current passcode using the “1” through “10” buttons. Press ENTER.
  - The “Adjustment” menu will be displayed.
- ③ Use the CURSOR  or  button to highlight the “8. Set Option” menu. Press ENTER to display the “Set Option” menu.
- ④ Use the CURSOR  or  button to select “1. Passcode”. Press ENTER to display the “Passcode Setting” menu.
- ⑤ Use the CURSOR  or  button to select “Entry”. Press ENTER to display the “Current Passcode?” menu.
- ⑥ Enter the four digit passcode (the current passcode) using the “1” through “10” buttons.
  - 1) Each time you press the INPUT button, an asterisk will appear next to the “Current Passcode?” message.
  - 2) Once you have finished entering the four digit passcode, press ENTER.
- 3) If the entered passcode is correct, the “New Passcode?” screen will be displayed.

**NOTE:** If you have made an error, press the NORMAL button to delete the asterisk “\*”. Then re-enter the correct passcode. To delete all the entered digits, hold down the CTL button then press the NORMAL button.

**NOTE:** If the passcode is not correct, the “Warning Different Passcode!!” message is displayed. You will be required to enter the correct current passcode.

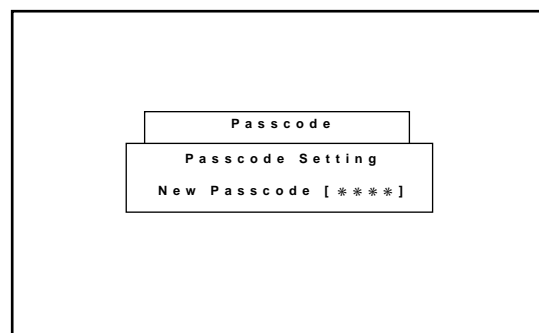
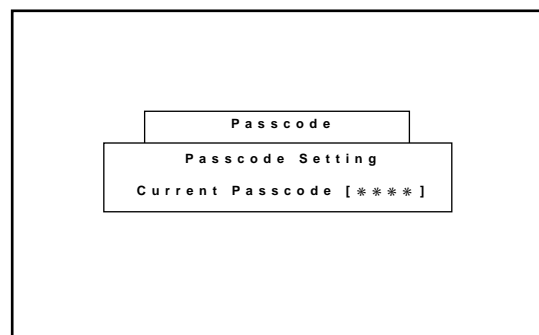
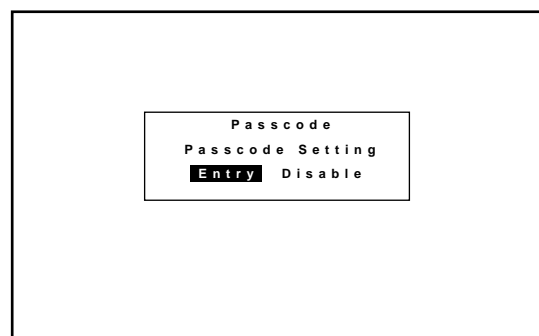
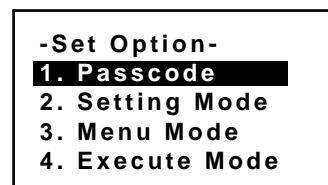
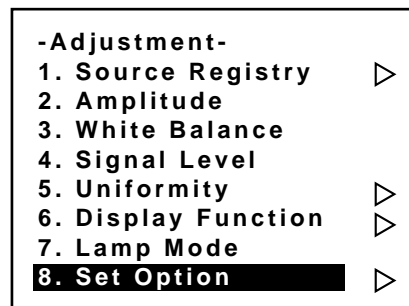

### 3. OPERATION

---

- ⑦ Enter a new passcode using the “1” through “10” buttons.
- 1) Each time you press the INPUT button, an asterisk will appear next to the “New Passcode?” message.
  - 2) Once you have finished entering the four digit new passcode, press ENTER.

**NOTE:** If you have made an error, press the NORMAL button to delete the asterisk “\*”. Then re-enter the correct passcode. To delete all the entered digits, hold down the CTL button then press the NORMAL button.

- 3) If the passcode has been entered correctly, the “Confirm New Passcode?” menu will be displayed.

**NOTE:** If the passcode is not entered correctly, the “Warning Different Passcode!!” message will be displayed. You are required to enter the new passcode correctly.

- ⑧ Enter the new passcode again using the “1” through “10” buttons.
- 1) Each time you press the INPUT button, an asterisk will appear under the “Confirm New Passcode?” message.
  - 2) Once you have finished entering the four digit new passcode, press ENTER.

**NOTE:** If you have made an error, press the NORMAL button to delete the asterisk “\*”. Then re-enter the correct passcode. To delete all the entered digits, hold down the CTL button then press the NORMAL button.

- 3) If the entered passcode is correct, the “Change Passcode Complete!!” message is displayed.

**NOTE:** If the passcode is not entered correctly, the “Warning Different Passcode!!” message is displayed. You will be required to enter the new passcode correctly.

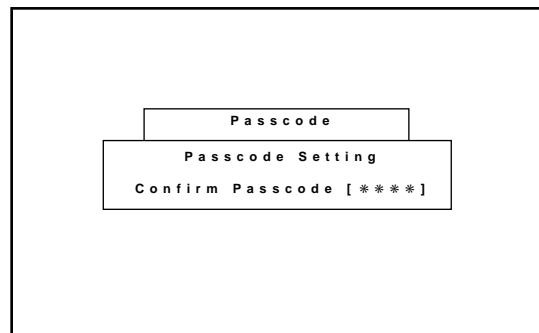

The passcode has been changed to another.







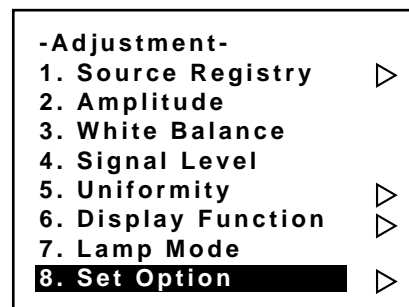

## ■ Canceling Your Passcode

To cancel the passcode, proceed as follows:

- ① Press the ADJUST button and then enter your passcode.
  - The “Passcode?” screen will be displayed.
- ② Enter the four digit current passcode using the “1” through “10” buttons and then press ENTER.
  - The “Adjustment” menu will be displayed.
- ③ Use the CURSOR  or  button to highlight “8. Set Option”. Press the ENTER button to display the “Set Option” menu.



- ④ Use the CURSOR  or  button to highlight “1. Passcode” line. Press ENTER to display the “Passcode Setting” menu.
- ⑤ Use the CURSOR  or  button to select “Disable”. Press ENTER to display the “Passcode Disable?” menu. Select “Yes” and press ENTER.
  - The “Current Passcode” screen will be displayed.

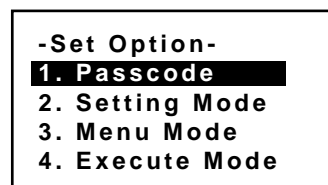

- ⑥ Enter the four digit passcode (the current passcode) using the “1” through “10” buttons.
  - 1) Each time you press the INPUT button, an asterisk will appear next to the “Current Passcode?” message.
  - 2) Once you have finished entering the four digit passcode, press ENTER.

**NOTE:** If you have made an error, press the NORMAL button to delete the asterisk “\*”. Then re-enter the correct passcode. To delete all the entered digits, hold down the CTL button then press the NORMAL button.

- 3) If the entered passcode is correct, the “Passcode Disable?” menu will be displayed.

**NOTE:** If the passcode is not correct, the “Warning Different Passcode!!” message will be displayed. You will be required to enter your correct passcode.

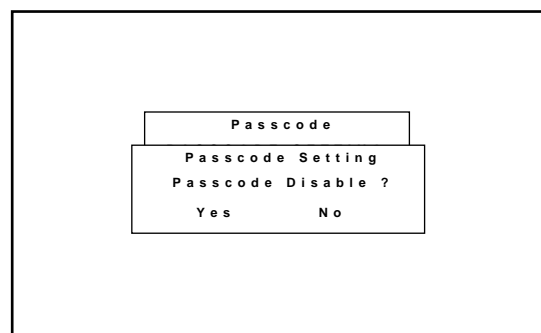
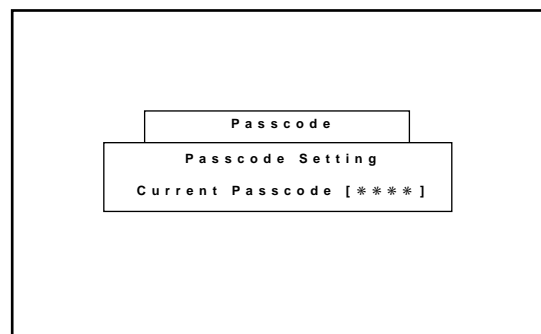
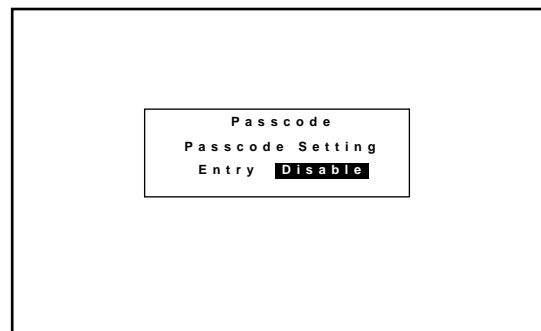

### 3. OPERATION

---

- ⑦ Use the CURSOR  or  button to select Yes and then press ENTER.

**Items to select**

- Yes ----- When selecting “Yes”, the current passcode will be canceled. You will not be required to re-enter your passcode when you press the ADJUST button to re-enter the ADJUST mode.
- No ----- When selecting “No”, the current passcode will remain in effect.

Your passcode has been cancelled.

## Setting Mode

Enables you to set various items.

To do, follow the steps below.

1. Press the ADJUST button to display the Adjustment menu.
2. Use the CURSOR  or  button to select "8. Set Option" menu.  
Press ENTER.
3. Use the CURSOR  or  button to select "2. Setting Mode" menu. Press ENTER.

Proceed to the following steps.

### ■ PJ Orientation

This feature allows you to set the installation type according to the projection configuration.

- ① Use the CURSOR  or  button to select the "PJ ORIENTATION" item, then press ENTER to display the "PJ ORIENTATION" menu.

**-Setting Mode-**  
**1. PJ Orientation**  
 2. Default Source Select  
 3. S-Video Mode Select  
 4. Video System Select  
 5. Auto Data Store  
 6. Option Terminal Speed  
 7. Uniformity Switching

Setting Mode	
PJ Orientation	[Ceiling/Front <input type="checkbox"/>
Default Mode Select	Default INPUT-A S-Video
S-Video Mode Select	[S2 <input type="checkbox"/>
Video System Select	Manual NTSC3.58
Auto Data Store	[Disable <input type="checkbox"/>
Option Terminal Speed	[38400 BPS <input type="checkbox"/>
Uniformity White	[Disable <input type="checkbox"/>
Edge Blend.	[Disable <input type="checkbox"/>

- ② Use the CURSOR  or  button to select one of the four projector installation types and press ENTER.

#### Items to select

- CEILING/REAR .... Ceiling mounting type and rear projection
- FLOOR/REAR ..... Desk top type and rear projection
- CEILING/FRONT .. Ceiling mounting type and front projection
- FLOOR/FRONT ..... Desk top type and front projection

Floor / Rear  
 Ceiling / Front  
**Floor / Front**  
 Ceiling / Rear

### 3. OPERATION

#### ■ Default Source Select

You can set the projector to default to any one of its inputs each time the projector is turned on.

Proceed as follows:

- ① Use the CURSOR  or  button to select the “Default Source Select” item, then press ENTER to display the “Default Source Select” menu.

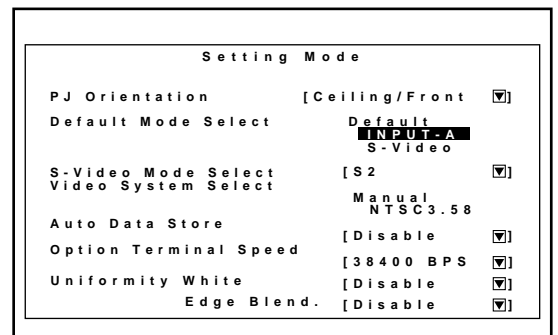
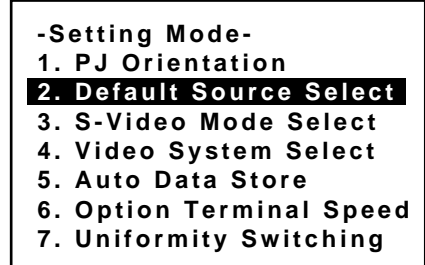



- ② Use the CURSOR  or  button to select either “Default” or “Last” and press ENTER.
  - Selecting “LAST” completes setting.
  - Selecting “DEFAULT” displays the “Default input” screen.

#### Items to select

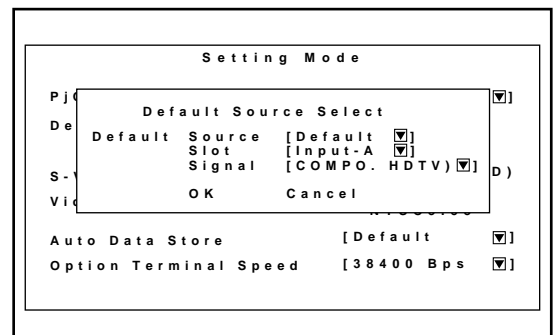

- **DEFAULT** . Displays the same source input every time the projector is started up.
- **LAST** ..... Sets the projector to default to the previous last active input each time the projector is turned on.  
 Note: An input must be active for a minimum of 10 minutes before it is recognized as the last active signal.



- ③ Use the CURSOR  or  button to select an input and then press the ENTER button.

**When used in stand alone operation:**

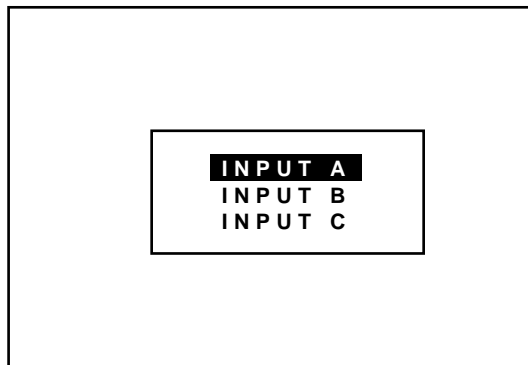

The default input screen will be displayed.

Use the CURSOR  or  button to select an input and press ENTER.



**When used with a single Switcher:**

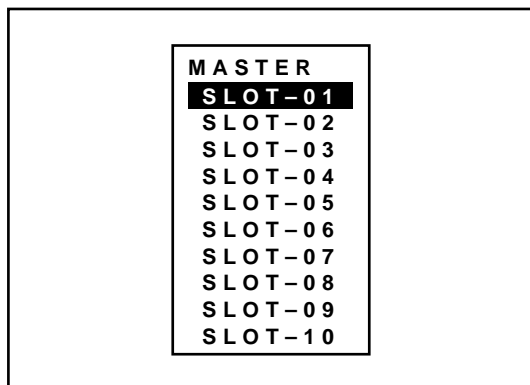

The “MASTER” slot menu will be displayed.

Use the CURSOR  or  button to select the desired slot number “1” through “10(0)” and then press ENTER.





**When used with two or more Switchers:**

The “MASTER” and “SLAVE” slot number menu will be displayed.

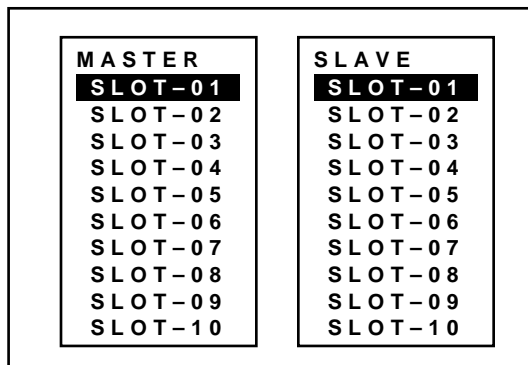
Use the CURSOR  or  button to select the master slot number first and then select the slave slot number “1” through “10(0)”. Press ENTER.



- ④ Use the CURSOR  or  button to select a signal and press ENTER button.

- ⑤ Press OK to complete the setting.

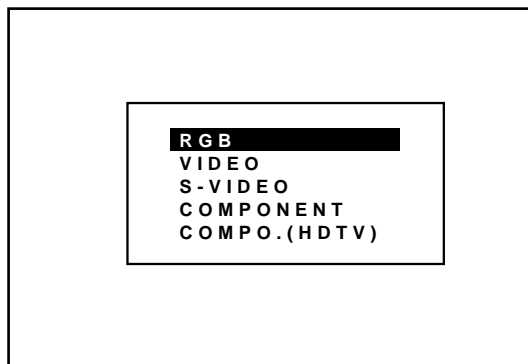

### 3. OPERATION

#### ■ S-Video Mode Select

This function is used to select the S-video signal detection mode. This allows identifying of the S-video signals with different aspect ratio: squeeze or full mode(16 : 9) and letter box (4 : 3) signals. To set, proceed as follows:

- ① Use the CURSOR  or  button to select the “S-Video Mode Select” item, then press ENTER to display the “S-Video Mode Select” menu.

- Setting Mode-**
1. PJ Orientation
  2. Default Source Select
  - 3. S-Video Mode Select**
  4. Video System Select
  5. Auto Data Store
  6. Option Terminal Speed
  7. Uniformity Switching

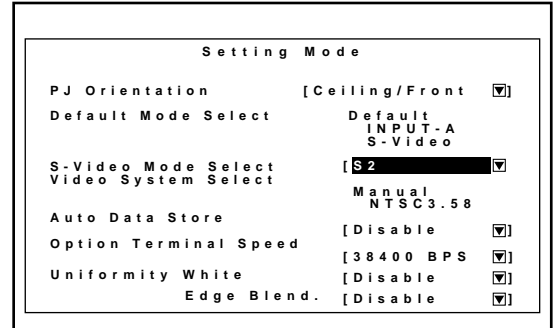

- ② Use the CURSOR  or  button to select one of the three items: S2, S1, and OFF, and then press ENTER.

#### Items to select

- S2 ..... Identifies squeeze and letter box signals.  
S1 ..... Identifies a squeeze signal only.  
OFF ..... Does not identify any S-video signal.

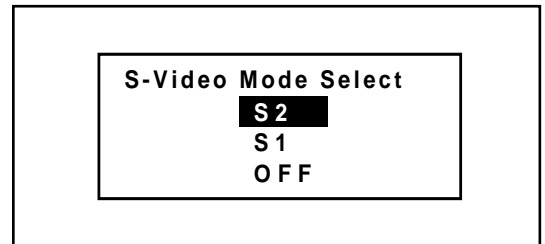

#### NOTE :

- The input signal must be compatible with the S2/S1 MODE standard. Refer to the user manual included with the connected equipment for more information.
- The identification function may not work correctly with a non-compatible signal. If this happens, select “OFF” from the “S-VIDEO MODE SELECT” menu.

## ■ Video System Select

This function is used to select the NTSC 3.58, NTSC 4.43, PAL or SECAM video standard.

To select any one of the video standards, proceed as follows:

- ① Use the CURSOR  or  button to select the “Video System Select” item, then press ENTER to display the “Video System Select” menu.

- ② Use the CURSOR  or  button to select either “Auto” or a video standard manually and then press ENTER.

### When selecting “AUTO”

#### Video Modes

- NTSC3.58 ..... Indicates the NTSC3.58 video standard
- NTSC4.43 ..... Indicates the NTSC4.43 video standard
- PAL ..... Indicates the PAL video standard
- SECAM ..... Indicates the SECAM video standard

- Select “Auto” in normal operation.
- Select a video standard manually when connecting to poor quality signal or non-standard signals such as video games.

**NOTE:** The projector may not function correctly with a monochrome signals in the Auto mode.

#### -Setting Mode-

1. PJ Orientation
2. Default Source Select
3. S-Video Mode Select
- 4. Video System Select**
5. Auto Data Store
6. Option Terminal Speed
7. Uniformity Switching

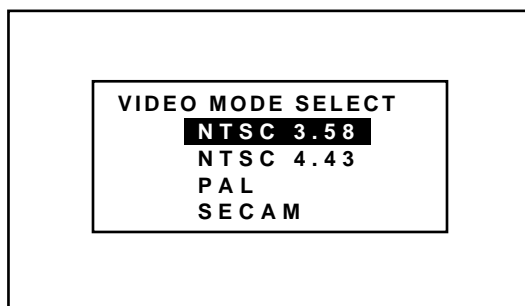
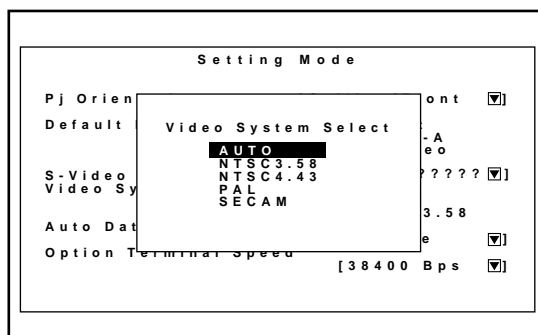
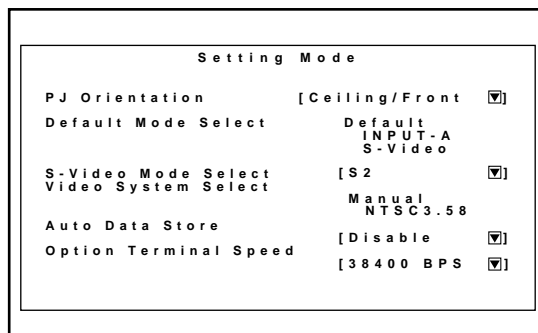

### 3. OPERATION

#### ■ Auto Data Store

This feature allows you to select two ways to store settings; automatically and manually.

After “Enable” is selected in the Auto Data Store menu, all projector settings are stored in the projector's memory automatically. To set this feature, proceed as follows:

- ① Use the CURSOR  or  button to select the “Auto Data Store” item on Page 2, then press ENTER to display the “Auto Data Store” menu.

- ② Use the CURSOR  or  button to select either “Disable” or “Enable” and then press ENTER.

##### Items to select

- Disable .... Projector does not store the settings automatically.
- Enable ..... Projector stores the settings automatically.

Automatic storing data is done when any one of the following procedures is performed:

- Pressing the END button several times returns the adjustment screen to the source screen.
- One input is switched to another.
- The projector is turned off.
- Every 10 minutes.

**NOTE:** After “Disable” is selected in the Auto Data Store menu, the settings will not be stored in the memory unless you select “Yes” in the “Store ?” menu.

**-Setting Mode-**  
1. PJ Orientation  
2. Default Source Select  
3. S-Video Mode Select  
4. Video System Select  
**5. Auto Data Store**  
6. Option Terminal Speed  
7. Uniformity Switching

Setting Mode	
PJ Orientation	[Ceiling/Front <input type="checkbox"/>
Default Mode Select	Default INPUT-A S-Video
S-Video Mode Select	[S2 <input type="checkbox"/>
Video System Select	Manual NTSC3.58
Auto Data Store	[Disable <input type="checkbox"/>
Option Terminal Speed	[38400 BPS <input type="checkbox"/>
Uniformity White	[Disable <input type="checkbox"/>
Edge Blend.	[Disable <input type="checkbox"/>

**Auto Data Store**  
**Disable**  
Enable



## ■ Option Terminal Speed

This feature allows you to set baud rate of the OPTION terminal from 4800 to 38400 bps.

### NOTE:

- The baud rate of the OPTION terminal defaults to 38400 bps at the factory.
- Make sure that the baud rate of the OPTION terminal matches that of operating of the connected equipment.

To change the baud rate of the OPTION terminal, proceed as follows:

- ① Use the CURSOR  or  button to select the “Option Terminal Speed” item, then press ENTER to display the “Option Term Boad Rate” menu.

- ② Use the CURSOR  or  button to select the baud rate from 4800 to 38400 bps and press ENTER.

**-Setting Mode-**  
**1. PJ Orientation**  
**2. Default Source Select**  
**3. S-Video Mode Select**  
**4. Video System Select**  
**5. Auto Data Store**  
**6. Option Terminal Speed**  
**7. Uniformity Switching**

Setting Mode	
PJ Orientation	[Ceiling/Front <input type="checkbox"/>
Default Mode Select	Default INPUT-A S-Video
S-Video Mode Select	[S2 <input type="checkbox"/>
Video System Select	Manual NTSC3.58
Auto Data Store	[Disable <input type="checkbox"/>
Option Terminal Speed	[38400 BPS <input type="checkbox"/>
Uniformity White	[Disable <input type="checkbox"/>
Edge Blend.	[Disable <input type="checkbox"/>

4800 BPS  
**9600 BPS**  
 19200 BPS  
 38400 BPS

### 3. OPERATION

#### ■ Uniformity Switching

Enables you to enable or disable the uniformity white and edge blending features.

① Use the CURSOR  or  button to select the “Uniformity Switching” item, then press ENTER.

**-Setting Mode-**  
**1. PJ Orientation**  
**2. Default Source Select**  
**3. S-Video Mode Select**  
**4. Video System Select**  
**5. Auto Data Store**  
**6. Option Terminal Speed**  
**7. Uniformity Switching**

② Use the CURSOR  or  button to select the “White Uniformity or Edge Blend.” item, and select Disable or Enable, then ENTER.

```
Setting Mode
PJ Orientation      [Ceiling/Front ]
Default Mode Select  Default
                   INPUT-A
                   S-Video
S-Video Mode Select [S2 ]
Video System Select  Manual
                   NTSC3.58
Auto Data Store     [Disable ]
Option Terminal Speed [38400 BPS ]
Uniformity White    [Disable ]
Edge Blend.        [Disable ]
```

**Disable**  
Enable

## Menu Mode

Enables you to set various items for on-screen display.

To do, follow the steps below.

1. Press the ADJUST button to display the Adjustment menu.
2. Use the CURSOR  or  button to select “8. Set Option” menu. Press ENTER.
3. Use the CURSOR  or  button to select “3. Menu Mode” menu. Press ENTER.

Proceed to the following steps.

This feature allows you to display the items on the top of the screen: date, time, input signal, source name, address, and new signal.

### ■ Message Time

There are two modes of operations for the on-screen display. With AUTO mode, the on-screen display will automatically switch off after three through ten seconds. In the MANUAL mode, the display must be manually turned off with the DISPLAY button on the full function remote control each time it appears.

**NOTE:** Pressing DISPLAY with CTL will select the non on-screen mode; pressing DISPLAY with CTL again will cancel this mode. Even if the on-screen display may be turned off with CTL and DISPLAY, any adjustment will still change the projector’s memory settings.

Proceed as follows:

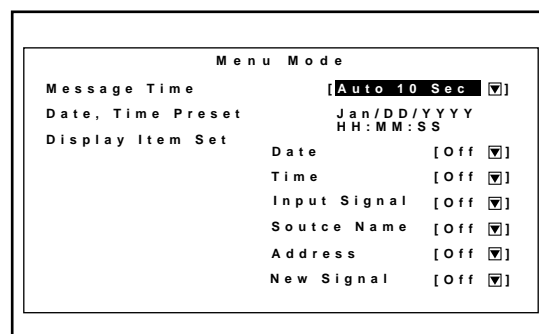

- ① Use the CURSOR  or  button to highlight the “Message Time” item. Press ENTER to display the “Message Time” menu.

-Menu Mode-  
**1. Message Time**  
 2. Date, Time Preset  
 3. Display Item Set



### 3. OPERATION

---

- ② Use the CURSOR  or  button to select either “Auto” or “Manual“ and press ENTER.

#### Items to select

- Auto ..... The on-screen menu display appears when the buttons on the remote control, or the controls on the rear panel are pressed. The on-screen display will turn off at a preselected time. The OFF TIME is specified in seconds up to a maximum of 30 seconds. Select your desired time (3-30 seconds) from the OFF TIME menu.
- Manual .... The on-screen menu display appears when the buttons on the remote control, or the controls on the rear panel are pressed. The display will be turned on and off whenever the DISPLAY button is pressed. If no button operation is made for 20 minutes or more, the on-screen message will automatically turn off.

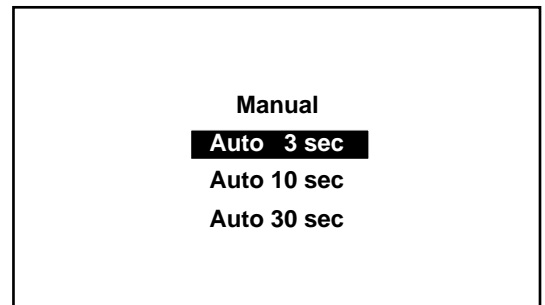

### ■ Date, Time Preset

The current year, month, date and time are displayed on the top of the screen.

Proceed as follows:

- ① Use the CURSOR  or  button to highlight the “Date, Time, Preset” item. Press ENTER to display the “Date, Time Preset” menu.

- ② Use the CURSOR  or  button to select any one of the two items: Date, and Time.

- ③ Type the date and time. Then press OK.

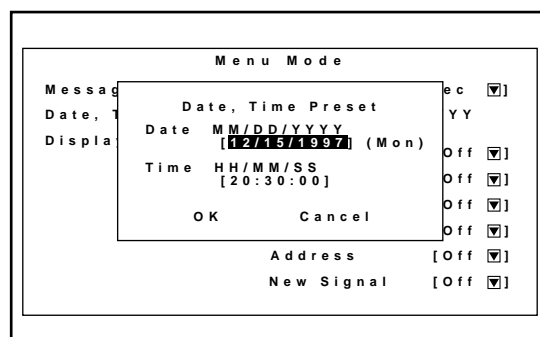
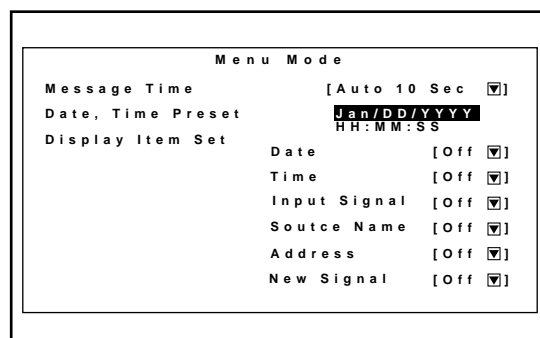
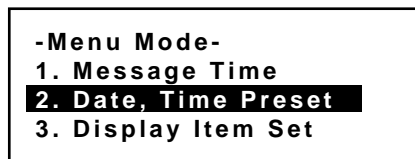

### 3. OPERATION

---

#### ■ Display Item Set

This feature allows you to display the items : date, time, input signal, source name, address, and new signal on the top of the screen.

- ① Use the CURSOR  or  button to highlight the “Display Item Set” menu. Press ENTER.

**-Menu Mode-**  
**1. Message Time**  
**2. Date, Time Preset**  
**3. Display Item Set**

- ② Use the CURSOR  or  buttons to select on or off and press ENTER.

Menu Mode	
Message Time	[Auto 10 Sec <input type="checkbox"/>
Date, Time Preset	Jan/DD/YYYY HH:MM:SS
Display Item Set	
Date	[Off <input type="checkbox"/>
Time	[Off <input type="checkbox"/>
Input Signal	[Off <input type="checkbox"/>
Soutce Name	[Off <input type="checkbox"/>
Address	[Off <input type="checkbox"/>
New Signal	[Off <input type="checkbox"/>

## Execute Mode

Enables you to select connecting with the switcher ISS-6020 and view the projector address on the screen.

To do, follow the steps below.

1. Press the ADJUST button to display the Adjustment menu.
2. Use the CURSOR  or  button to select “8. Set Option” menu. Press ENTER.
3. Use the CURSOR  or  button to select “4. Execute Mode” menu. Press ENTER.

Proceed to the following steps.

### ■ Connect Condition

This setting explains how the projector is used with the ISS-6020/ISS-6020G Switcher.

- ① Use the CURSOR  or  button to select the “1. Connect Condition” item, then press ENTER to display the ““1. Connect Condition” menu.
- ② Use the CURSOR  or  button to select your desired connection condition of Switcher and press ENTER.
  - The “Re-Start ?” prompt is displayed after setting of the connection condition is modified from the current status to your desired condition.

#### Items to select

- Stand Alone ..... The projector used in stand alone operation.
- SW 1 Level ..... The projector used with one Switcher.
- SW 2 Level ..... The projector used with two or more Switchers.

- ③ Use the CURSOR  or  button to select either “Yes” or “No” and press ENTER.

#### Items to select

- Yes ..... Restart the projector.
- No ..... Does not restart the projector.

**NOTE:** The selected connection condition becomes effective only after the projector is restarted.

-Execute Mode-  
1. Connect Condition  
2. PJ Address

Excute Mode  
Connect Condition [Stand Alone

PJ Address [01] (01-64)

#### Connect Condition

SW1 Level  
SW2 Level

Re-Start?  
Yes No

### 3. OPERATION

---

#### ■ PJ Address

Each projector needs its own unique address in the case of a serial connection of projectors. Up to 64 addresses can be set.

Proceed as follows:

- ① Use the CURSOR  or  button to highlight the “2/PJ Address” line. Press ENTER to display the “Address” menu.



- ② Enter the address number using the INPUT button and press ENTER.
  - If you have made a mistake, press END to return to the “OPTION” menu, then start again.

**NOTE:** Enter the address number “01” when only one projector is used.

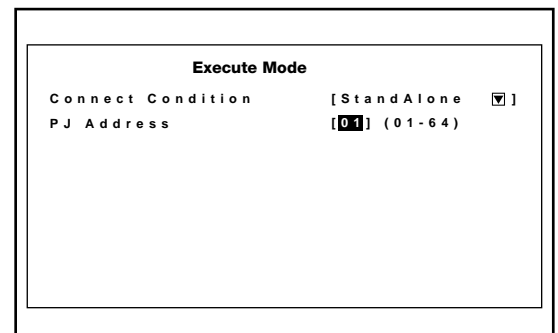



### ■ Addressing the Remote Control Unit

When changing the projector address, ensure that the projector address respond to the remote control address, otherwise you cannot operate the projector using the remote control.

To specify the remote control address, proceed as follows:

- 1) Press and hold the CTL button then press the ADDRESS button to access the RC UNIT address mode.
  - The current remote control address is displayed on the remote control address screen. (When the current remote control address is configured at "00", the remote control address screen will not be displayed.
  - This screen will disappear in 30 seconds.

**NOTE:** When the remote control is used with the Switcher in wired application, a window shown on the right will not be displayed. However, the remote control address can be changed.

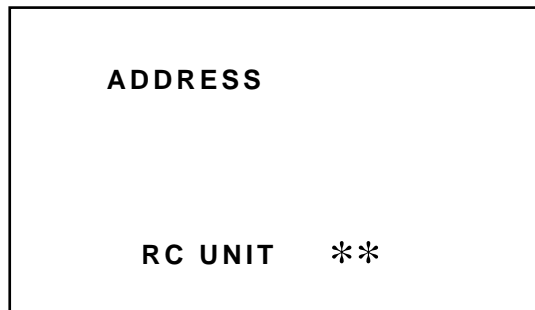

When the remote control address is configured at "00", the above screen will not be displayed.

- 2) Use INPUT buttons to enter a new two-digit number and press ENTER.
  - The new remote control address is displayed on the screen. When the new remote control address is configured at "00", the display will not be changed. However, its address has been changed by pressing ENTER.
  - The number you can specify ranges from 00 to 64.

To stop the address changing, press END.  
See the projector address number on the screen.

**NOTE:**

- The buttons other than the above mentioned button and the OFF button are not available during specifying the remote control address.
- If no key input is made within 30 seconds, the remote control automatically exits the RC UNIT address mode.

### Address common to all the projectors

When specifying the remote control address as "00", you can operate the projector using the remote control, regardless of the projector addresses.

If the remote control loses power, the remote control address becomes "00". In this case the on-screen shown on the right above is not displayed on the screen.

- 3) To complete, press END.

## 3. OPERATION

### Help Menu

Provides information about operation and adjustment procedures or the set information.

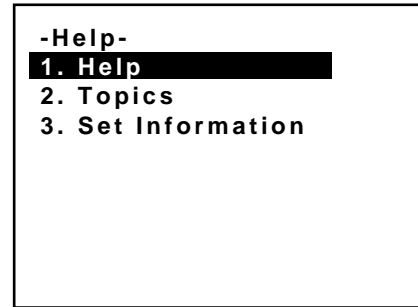

To view the information:

Press OPERATE or ADJUST button then select "Help" from the Task bar and press ENTER. The Help menu will be displayed.





#### ■ Help

Provides information how to use the Help.

To view the Help menu, use the CURSOR  or  button to select "1. Help" menu and press ENTER.



#### ■ Topics

Provides you information of a various items explaining function and operation.

To view information, use the CURSOR  or  button to select "2. Topics" menu and press ENTER.

#### ■ Set Information

Lets you know the version for the running time, the lamp usage time, the version for your hardware and software.

To view the information, use the CURSOR  or  button to select "3. Set Information" menu and press ENTER.

The information you can view are:

User Name ----- Indicates the user name

Set Serial No. ----- Indicates serial number for your projector

Set hour Meter ----- Indicates the amount of operating time of your projector

Lamp Hour Mete ----- Indicates the amount of operating time of the lamp

Software version ----- Indicates the version for the software

Hardware version ----- Indicates the version for the hardware

\*The Switcher item is displayed only when the Connect Condition is set to the SW 1 or 2 Level.

Set Information		
User Name	[	]
Set Serial No.	[	]
Set Hour Meter	0300H	40M
Lamp Hour Meter	0100H	20M
Software Version	Bios	1.00
	Application	1.00
	Data	1.00
	Sub CPU	1.00
	Switcher	1.00
Hardware Version		1.00



## Others

### ■ Test Patterns

This projector will generate a selection of test signals.

Six kinds of internal test patterns can be selected from the Test Pattern menu.

To display the Test Pattern menu, proceed as follows:

1. Press the TEST button on the remote control.
  - The Test Pattern menu will be displayed.
  - When END is pressed, the Test Pattern menu will disappear.
2. Use the CURSOR  or  button to highlight the test pattern you wish to use and press ENTER.
  - The selected test pattern will be displayed.
3. To return to the original screen, press TEST and then press END.
  - When the TEST button is pressed, the Test Pattern menu will be displayed and when END is pressed, the screen will be changed to the source screen.
  - The projector will return to the original source screen by pressing END only when no menu or no adjustment screen is displayed.

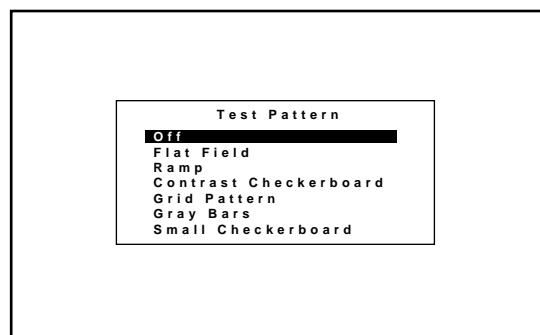

### TEST PATTERN

GRID PATTERN

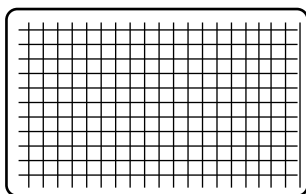

FLAT PATTERN

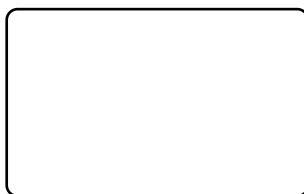

GRAY BARS

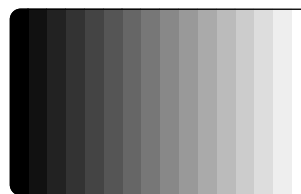

CONTRAST CHECKER BOARD

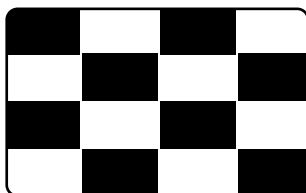

SMALL CHECKER BOARD

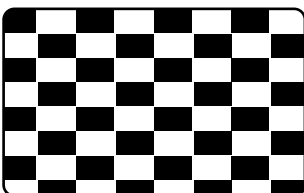

RAMP

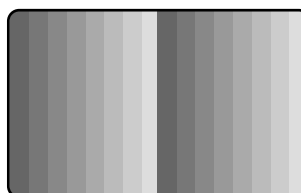

### 3. OPERATION

#### ■ Normal, Load, and Cancel Function

Adjustment settings can be returned to the factory preset level, previously stored level, or can be canceled.

To return to the standard level (Normal):

1. Press the NORMAL button.

The confirmation message is displayed.

2. Use the CURSOR  or  button to select Yes.

A confirmation message is displayed.

3. Press ENTER.

The Normal function is performed.

If you select “No”, you will exit this mode suspending current status.

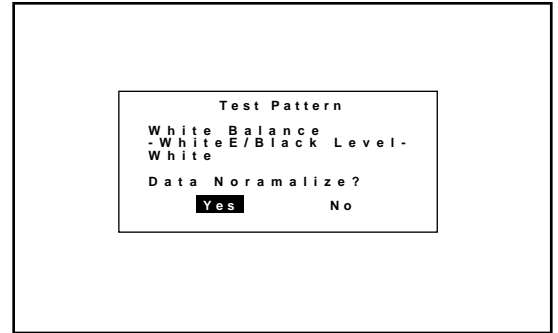

#### ■ To return to the last stored level (Load):

1. Press and hold the CTL button then press the NORMAL button.

- The Memory menu is displayed.

2. Use the CURSOR  or  button to select Load.

A confirmation message is displayed.

3. Use the CURSOR  or  button to select Yes.



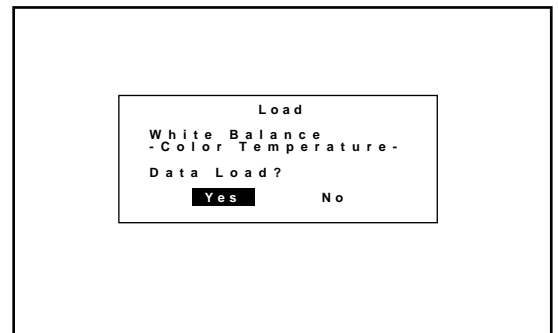
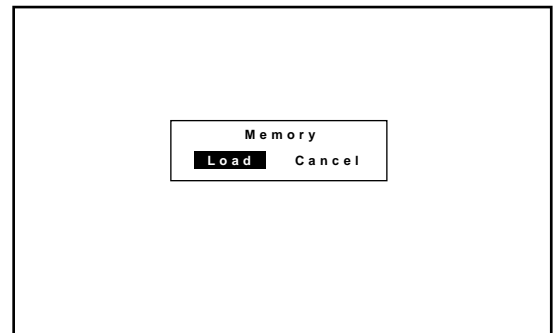

- If you select No, you will exit this mode suspending current status.

4. Press ENTER.

- The LOAD function is performed.



**■ To cancel the adjustment data (Cancel):**

1. Press and hold the CTL button then press the NORMAL button.
  - The Memory menu is displayed.
2. Use the CURSOR  or  button to select Cancel.
  - A confirmation message is displayed.
3. Use the CURSOR  or  button to select Yes.
  - If you select No, you will exit this mode suspending current status.
4. Press ENTER.
  - The CANCEL function is performed.

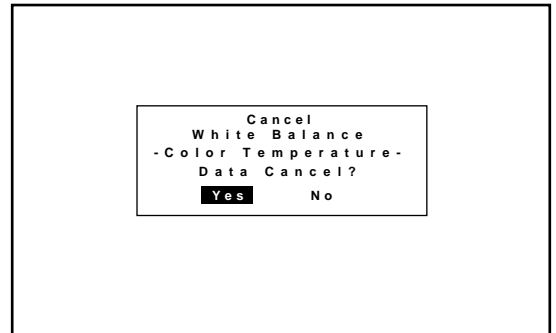
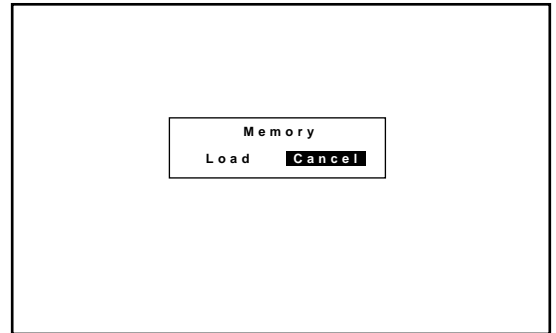

## 4.SPECIFICATIONS

---

Projection Type	: 3Chip DMD TM High light out put projector.
Projection System	: 3chip DMD TM , 1 Lens
Display Orientation	: Front Floor , Rear Floor , Front Ceiling , Rear Ceiling
Lamp Type	: Bulb type 1.6 KW Xenon Lamp
Shooting offset	: 0 + 150 pixel by Zoom Lens ( One direction ) 0 + 300 pixel by Fixed Lens ( One direction )
Scanning line rat / Flame rate	: H 15-64KHz V 30-100Hz
Resolution	: DMD™ 848×600 pixel Max : 1024 × 768 by Scaling
Pixel clock	: Max 80 MHz
Lens (optional)	: Fixed lens ; Type 1 : 1.27:1 Type 2 : 3.0:1 Type 3 : 5.0:1 Type 4 : 7.0:1 Zoom Lens Type 1 : 1.5-3.0 Type 2 : 3.0-7.0
Picture Size	: 80-500 inch diagonal
Light Output	: 3500 ANSI lumen
Contrast Ratio	: 250:1 ( Full On / Off )
Input terminal	: Fixed terminal : Composite Video ( BNC or RCA switchable ) RGB , H, V / Y,Cr,Cb ( BNC ) S Video ( S- terminal ) Optional terminal : 2 slot prepared
Input signal (Level)	: RGB signal : 0.7Vp-p 75ohm Positive(BNC) HV sync : 0.7-4.0Vp-p(75ohm/1Kohm) Negative or Positive(BNC) Duty 3-30% (H-Sync Positive) 70-97% (H-Sync Negative) 0.1-10%(V-sync Positive) 90-99.9%(V-Sync Negative) Mix sync : 0.7-4.0Vp-p(75ohm/1Kohm) Negative or Positive(BNC) G sync : 0.3-0.6Vp-p 75ohm Sync. Negative(BNC) Video : 1.0Vp-p 75ohm Sync. Negative S-Video : Y 1.0Vp-p 75ohm Sync. Negative C0.28Vp-p 75ohm(burst level) (3 mode acceptable) Y, Cr, Cb : Y 1.0Vp-p 75ohm Sync. Negative

---

Convergence limits	: Within one pixel
Set-up signal	: Gray Scale signal , Cross hatch signal , All white , All Black , 20% white
Power supply	: AC 200V - 240V
Power consumption	: 2.3KW ( MAX)
Input current	: 12.5 A(MAX)
Safety and regulation	<ul style="list-style-type: none"> <li>UL : Meet UL 1950</li> <li>CSA : Meet CSA 950</li> <li>FCC : Meet FCC class A</li> <li>DHHS : Approved</li> <li>DOC : Meet</li> <li>Meet EMC Directive <ul style="list-style-type: none"> <li>EN55022 : Meet(Radiation)</li> <li>EN55082-2 : Meet(Immunity)</li> <li>EN61000-3-2, EN61000-3-3 : Meet(Disturbance)</li> </ul> </li> <li>Meet LVP Directive <ul style="list-style-type: none"> <li>EN60950 :Meet (Safety)</li> </ul> </li> </ul>
Cabinet dimension	: 29.5" (W) x 39.4" (D) x 15" (H) without lens 750 mm (W) x 1000 mm (D) x 380 mm (H) without lens
Weight	: 238 lbs (108 kg)
Remote controller	: Wired application Wireless (operating distance 23 ft./7m)
External control	: Input select ; Power On/OFF Mute
PC control	: Supports RS-232C / RS-422 switchable
ISS-6020 Compatibility	: Full compatible
OSD Output terminal	: D-sub shrink 15 Pin RGB signal : 0.7Vp-p Analog out ( 75ohm ) H,V sync out : TTL
Accessory (Option)	: Input terminal Option
Environment	: Temperature 0 to 40 degree : Humidity 20 to 90% non-condensing : Storage -10 to 50 degree c
Lamp life	: 1500 Hours ( Half light out put point )
Noise	: 59 dB

**Note:** Specifications are subject to change without notice.

## 5.APPENDIX

### Message List

Code	Message
A1	PS PROTECT ERROR (Overload or failure in the mains power supply)
A2	POWERGOOD ERROR (Insufficient voltage of +5V(D) or DLP5V in the mains power supply)
C0~CF	COMMUNICATION ERROR (Communication setting errors in conjunction with switcher and PC control)
D0	SIGNAL UNLOCK (Instability or failure in synchronization)
E0	FAN STOP ERROR (Fan stoppage)
EC	FLASH MEMORY ERASE ERROR (Error in system PWB)
ED	FLASH MEMORY WRITE ERROR (Error in system PWB)
EE	ALL STORE DATA INITIAIZING (Store ROM formatting)
EF	PARTLY STORE DATA IS BREAKING (Error in stored data)
F0	H-FREQUENCY LIMIT OVER (Entry of signal input at 120kHz or above)
F1	ENGINE TEMPERATURE EROOR (Engine temperature deviating the specified range)
F2	12CBUS EROOR (VIDEO PRO PWB or CORE PACK) (Control error in video PRO PWB/core PACK)
F3	12CBUS ERROR (DLP ENGINE) (Engine control error)
F4	LAMP PROTECT EROOR (Lamp source error/lamp error or lamp's fan stop)
F5	LAMP STATE ERROR (Lamp error)
F6	LAMP TEMPERATURE ERROR (Lamp's temperature error)
F7	MUSEBUS ERROR (Error in graphic PWB)
P0	FPGA (OSD) WRITING (Writing in FPGA)
P1	FPGA (R) WRITING (Writing in FPGA)
P2	FPGA (G) WRITING (Writing in FPGA)
P3	FPGA (B) WRITING (Writing in FPGA)
PP	BIOS PROGRAM STATING (Program writing being processed)
o0~oF	Internal processing



**NEC**  
**NEC Corporation**

Printed in Japan  
78408931

## Free Manuals Download Website

<http://myh66.com>

<http://usermanuals.us>

<http://www.somanuals.com>

<http://www.4manuals.cc>

<http://www.manual-lib.com>

<http://www.404manual.com>

<http://www.luxmanual.com>

<http://aubethermostatmanual.com>

Golf course search by state

<http://golfingnear.com>

Email search by domain

<http://emailbydomain.com>

Auto manuals search

<http://auto.somanuals.com>

TV manuals search

<http://tv.somanuals.com>