

NEC Express5800 Series

**N8800-096F, EXP320B
NEC Express5800/320Fb-L**

**N8800-097F, EXP320A
NEC Express5800/320Fb-LR**

**N8800-098F, EXP320D
NEC Express5800/320Fb-M**

**N8800-099F, EXP320C
NEC Express5800/320Fb-MR**

User's Guide (Setup)



N8800-096F, EXP320B

NEC Express5800/320Fb-L

N8800-097F, EXP320A

NEC Express5800/320Fb-LR

N8800-098F, EXP320D

NEC Express5800/320Fb-M

N8800-099F, EXP320C

NEC Express5800/320Fb-MR

User's Guide (Setup)

1st Edition

12-2006

856-124126-411-00

PROPRIETARY NOTICE AND LIABILITY DISCLAIMER

The information disclosed in this document, including all designs and related materials, is the valuable property of NEC Corporation (NEC) and /or its licensors. NEC and/or its licensors, as appropriate, reserve all patent, copyright and other proprietary rights to this document, including all design, manufacturing, reproduction, use, and sales rights thereto, except to the extent said rights are expressly granted to others.

The NEC product(s) discussed in this document are warranted in accordance with the terms of the Warranty Statement accompanying each product. However, actual performance of each such product is dependent upon factors such as system configuration, customer data, and operator control. Since implementation by customers of each product may vary, the suitability of specific product configurations and applications must be determined by the customer and is not warranted by NEC.

To allow for design and specification improvements, the information in this document is subject to change at any time, without notice. Reproduction of this document or portions thereof without prior written approval of NEC is prohibited.

First Printing, December 2006
Copyright 2006
NEC Corporation
7-1 Shiba 5-Chome, Minato-Ku
Tokyo 108-8001, Japan
All Rights Reserved
Printed in Japan



Keep this User's Guide handy for quick reference when necessary.

Safety Indications



To use NEC Express5800 series safely, follow the instructions in this User's Guide.

This guide explains components that pose a danger, types of dangers caused by failing to follow the instructions, and actions taken to prevent them; such components are labeled warning.

This guide and warning labels use "WARNING" and "CAUTION" to indicate a danger depending on the degree. These terms are defined as follows:



 WARNING	Indicates a danger that could lead to a death or serious injury.
 CAUTION	Indicates a danger that could lead to a burn, other injuries or damage to physical assets.

This guide uses the following three types of symbols to give indications and precautions against a danger. They are defined as follows:

	Indicates that there is a risk of a danger. Each image symbolizes a particular type of danger. (Attention)
	Indicates what you must not do. Each image symbolizes a particular type of prohibition. (Prohibited actions)
	Indicates what you must do. Each image symbolizes a particular type of action necessary to avoid a danger. (Mandatory actions)

(Example)

Symbol to draw attention
Term indicating a degree of danger









 CAUTION	
	<p>High temperature. Immediately after the power-off, system components such as hard disk are very hot. Wait the server to cool down completely before adding/removing some component.</p>

Description of a danger







Symbol indicating a prohibited action (may not always be indicated)

Symbols and its descriptions used in this User's Guide and warning labels are as follows:



Attention

	Indicates a risk of an electric shock.
	Indicates a risk of a personal injury due to heat.
	Indicates a risk of catching your fingers.
	Indicates a risk of a fire or smoke.
	Indicates a general precaution or warning that is not defined herein.
	Indicates a risk of losing eyesight due to laser beam.
	Indicates a risk of an explosion.
	Indicates a risk of a personal injury.

Prohibited actions

	Indicates a general prohibition that is not defined herein.
	Do no touch the indicated area. There is a risk of an electric shock or fire.
	Do not touch with wet hands. There is a risk of an electric shock.
	Keep from flame. There is a risk of a fire.
	Avoid using water or liquid nearby. If it spills on the equipment, there is a risk of an electric shock or fire.
	Do not disassemble, repair, or modify the equipment. There is a risk of an electric shock or fire.

Mandatory actions

	Unplug the server. There is a risk of an electric shock or fire.
	Indicates a general action to take that is not defined herein. Make sure to follow the instructions.

For detailed notes to set up the machine safely, refer to “NOTES FOR SAFE HANDLING” on page 1-2.



安全注意事項

安全標示



請參考本用戶指南中的指示以安全使用NEC Express5800系列伺服器。

本用戶指南說明了設備何處有危險、危險類型、如何避免危險等。在設備可預計到的危險之處或其附近貼有警告標籤。

用戶指南及警告標籤中，根據危險程度不同，使用“警告”、“注意”等詞，含義如下：

 WARNING	表示如不遵守該指示，可能引發人員傷亡。
 CAUTION	表示如不遵守該指示，可能發生燒傷等身體損傷或造成物質損失。

對危險的提示表示有如下三種符號，具體含義如下所述：

	表示該處可能發生危險。符號為危險內容的圖案。（注意）
	表示禁止行爲。符號中或其附近的圖案為禁止行爲內容。（禁止行爲）
	表示強制行爲。符號中的圖案為強制必須做的行爲內容。即為避免危險必需的行爲。（強制行爲）

（用戶指南中範例）

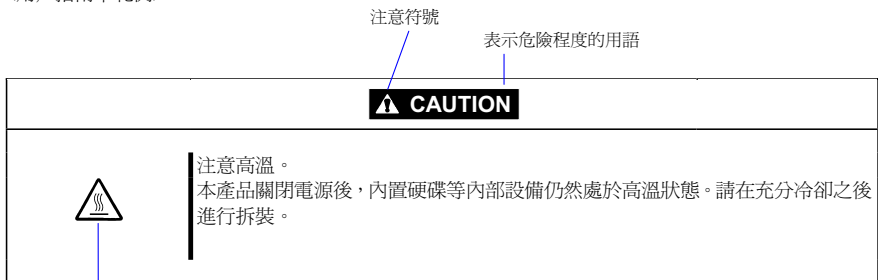









禁止行爲的提示符號（有可能沒有此類提示）

危險提示內容

本書及警告標籤中使用的符號



注意

	表示有觸電的危險。
	表示有因高溫而負傷的危險。
	表示有手指等被夾住的危險。
	表示有冒煙或者著火的危險。
	表示非特定的一般的提醒警告。
	表示有因雷射導致失明的危險。
	表示有爆炸的危險。
	表示有受傷的危險。

禁止行爲

	表示非特定的一般禁止。
	不要觸摸指定區域。有觸電或著火的危險。
	不要用濕手觸摸。有觸電的危險。
	遠離火源。有著火的危險。
	遠離液體。如果沾到液體，有觸電或著火的危險。
	請不要對本設備進行拆卸、修理、改造。有觸電和發生火災的危險。

強制行爲

	請將本設備的電源插頭從伺服器上拔下。有發生火災和觸電的危險。
	對非特定的一般使用者的行爲進行指示。請按照說明進行操作。

NOTE: This equipment has been tested and found to comply with the limits for a Class A digital device, pursuant to Part 15 of the FCC Rules. These limits are designed to provide reasonable protection against harmful interference when the equipment is operated in a commercial environment. This equipment generates, uses, and can radiate radio frequency energy and, if not installed and used in accordance with the instruction manual, may cause harmful interference to radio communications. Operation of this equipment in a residential area is likely to cause harmful interference in which case the user will be required to correct the interference at his own expense.

警告使用者：

這是甲類的資訊產品，在居住的環境中使用時，可能會造成射頻干擾，在這種情況下，使用者會被要求採取某些適當的對策。

**CLASS 1
LASER PRODUCT**

這是CLASS 1 LASER PRODUCT。該標籤貼於系統的內部光碟。

注意：本產品通過多餘的硬體模組提供硬體容錯性能。但是這並不表示能夠保證完全容錯。如，在以下情況下可能發生宕機：

- 軟體發生致命故障。
- 多餘硬體雙方均發生故障，不能運行。
- 時鐘產生器線路或內部連接背板等非多餘元件發生致命故障。
- 切斷了整個系統的AC電源

NOTE: This equipment has been tested and found to comply with the limits for a Class A digital device, pursuant to Part 15 of the FCC Rules. These limits are designed to provide reasonable protection against harmful interference when the equipment is operated in a commercial environment. This equipment generates, uses, and can radiate radio frequency energy and, if not installed and used in accordance with the instruction manual, may cause harmful interference to radio communications. Operation of this equipment in a residential area is likely to cause harmful interference in which case the user will be required to correct the interference at his own expense.

警告使用者：

這是甲類的資訊產品，在居住的環境中使用時，可能會造成射頻干擾，在這種情況下，使用者會被要求採取某些適當的對策。

이 기기는 업무용으로 전자파적합등록을 한 기기이오니 판매자 또는 사용자는 이 점을 주의하시기 바라며 만약 잘못된 판매 또는 구입하였을 때에는 가정용으로 교환하시기 바랍니다.

This class A digital apparatus meets all requirements of the Canadian Interference-Causing Equipment Regulations.

Cet appareil numérique de la classe A respecte toutes les exigences du Règlement sur le matériel brouilleur du Canada.

CE Statement

Warning: This is a Class A product. In residential environment, this product may cause radio interference, in which case the user may be required to take adequate measures (EN55022).

**CLASS 1
LASER PRODUCT**

This system is classified as a CLASS 1 LASER PRODUCT. This label is located on the internal CD-ROM installed in your system.

NOTE: This product provides resistance against hardware faults with its redundant hardware modules. However, this does not mean complete fault-tolerance is assured. For example, there is a risk of system down when:

- A fatal fault occurs in software.
- Both modules within a redundant hardware pair break down.
- A fatal fault occurs in a non-redundant component, such as the clock generator circuitry or the interconnect backplane.
- The entire system is cut off from AC power.

Trademarks and Patents

NEC EXPRESSBUILDER and NEC ESMPRO are trademarks of NEC Corporation.

Microsoft, Windows, Windows Server, Windows NT, and MS-DOS are registered trademarks of Microsoft Corporation in the United States and other countries.

Intel and Pentium are registered trademarks of Intel Corporation.

AT is a registered trademark of International Business Machines Corporation in the United States and other countries.

Adobe, the Adobe logo, Acrobat, and the Acrobat logo are trademarks of Adobe Systems Incorporated.

Datalight is a registered trademark of Datalight, Inc. ROM-DOS is a trademark of Datalight, Inc.

Xeon is a trademark of Intel Corporation in the United States. DLT and DLTape are trademarks of Quantum Corporation in the United States. QLogic and its logo are trademarks of QLogic Corporation in the United States. Fast!UTIL is a trademark of QLogic Corporation in the United States.

Avocent and Dambrackas Video Compression (DVC) are trademarks or registered trademarks of Avocent Corporation in the United States and other countries.

Mozilla is a trademark of Mozilla Foundation.

Netscape is a trademark or registered trademark of Netscape Communications Corporation in the United States and other countries. Java is a trademark or registered trademark of Sun Microsystems, Inc. in the United States and other countries.

All other product, brand, or trade names used in this publication are the trademarks or registered trademarks of their respective trademark owners.

Microsoft Windows Server 2003 R2 32-bit Standard Edition operating system, Microsoft Windows Server 2003 R2 32-bit Enterprise Edition operating system, Microsoft Windows Server 2003 Standard Edition operating system and Microsoft Windows Server 2003 Enterprise Edition operating system are called Windows Server 2003 for short. Microsoft Windows 2000 Server operating system, Microsoft Windows 2000 Advanced Server operating system and Microsoft Windows 2000 Professional operating system are called Windows 2000 for short. Microsoft Windows NT Server network operating system version 3.51/4.0 and Microsoft Windows NT Workstation operating system version 3.51/4.0 are called Windows NT for short. Microsoft Windows Millennium Edition Operating System is called Windows Me for short. Microsoft Windows 98 operating system is called Windows 98 for short. Microsoft Windows 95 operating system is called Windows 95 for short.

Names used with sample applications are all fictitious. They are unrelated to any existing product names, names of organizations, or individual names.

The Dambrackas Video Compression algorithm from Avocent Corporation is used for ft Remote Management Card.

U.S. Patent Numbers: 5,732,212, 5,937,176, 6,633,905, 6,681,250, 6,701,380 and other patents pending

Taiwanese Patent Number: 173784

European Patent Number: 0 740 811

Notes:

- (1) No part of this manual may be reproduced in any form without prior written permission of NEC Corporation.
- (2) The contents of this manual are subject to change without prior notice.
- (3) The contents of this manual shall not be copied or altered without prior written permission of NEC Corporation.
- (4) All efforts have been made to ensure the accuracy of all information in this manual. If you find any part unclear, incorrect, or omitted in this manual, contact the sales agent where you purchased this product.
- (5) NEC assumes no liability arising from the use of this product, nor any liability for incidental or consequential damage arising from the use of this manual regardless of (4) above.

Preface

Welcome to the NEC Express5800/ft series.

NEC Express5800/ft series is a “fault-tolerant (ft)” server focusing on “high reliability” in terms of fault-tolerance, in addition to “high performance,” “scalability,” and “general versatility” provided by NEC Express5800 series. In the event of trouble, its dual configuration will allow the system to instantaneously isolate the failed parts to assure non-stop running; operation will be moved smoothly from one module to the other, minimizing damage to it. You can use NEC Express5800/ft series in a mission-critical system where high availability is required. By the use of Windows Server 2003 operating system, it also provides outstanding openness for general-purpose applications, etc.

To make the best use of these features, read this User's Guide thoroughly to understand how to operate NEC Express5800/ft series.

About This User's Guide

This User's Guide helps a user to properly setup and use the product. Consult this guide when you set up the product.

Keep this manual and the separate volume of User's Guide handy.

This User's Guide is intended for users who have a good knowledge on the basic use of Windows operating systems and general I/O devices such as a keyboard and mouse.

How to Use This User's Guide

This guide explains the procedures you should perform before you begin system operation after you purchased the product. Read the guide in order from Chapter 1. If you perform procedures according to this guide, you will set up the product properly.

Chapter 4 describes how to install the operating system. Chapter 5 describes post-installation procedures. Chapter 6 explains how to troubleshoot if you cannot set up the product properly. Refer to "SYSTEM REPAIR" on page 6-2 for details about system configurations and repairs of this product. Refer to "TROUBLESHOOTING" on page 6-14 if you feel you failed to set up the product.

See this User's Guide for details of this product's operation, and functions and operations of the hardware and the system.

Additional symbols

The following symbols are used throughout this User's Guide in addition to the caution symbols described at the beginning.

IMPORTANT:	Important points or instructions to keep in mind when using the server or software
CHECK:	Something you need to make sure when using the server or software
TIPS:	Helpful information, something useful to know

About our Web Service

Information on NEC Express5800/ft series including modification modules is also available on our web site, NEC Express5800 Web Site Asia Pacific, at

<http://www.nec.co.jp/express/index.html>

Contents

Preface	iii
About This User's Guide	iv
How to Use This User's Guide	iv
Additional symbols	v
About our Web Service.....	v
CHAPTER 1 BEFORE USING	1-1
NOTES FOR SAFE HANDLING	1-2
Warning Labels.....	1-2
CPU/IO Modules	1-4
PRECAUTIONS FOR SAFETY	1-6
General.....	1-6
Use of Power Supply and Power Cord.....	1-7
Installation, Relocation, Storage and Connection.....	1-8
Cleaning and Handling of Internal Devices	1-9
During Operation	1-10
Rack-mount Model (Model 320Fb-MR).....	1-11
安全注意事項	1-13
一般注意事項	1-13
使用電源及電源線注意事項.....	1-14
安裝，移動，保管及連接注意事項.....	1-15
整理及操作內部設備時的注意事項.....	1-16
操作注意事項	1-17
機架式伺服器的注意事項.....	1-18
UNPACKAGING	1-20
Accessories	1-20
CHAPTER 2 ABOUT OPERATING SYSTEM	2-1
INSTALLING Windows Server 2003	2-2
About OS Installation	2-2
CHAPTER 3 INSTALLING SERVER	3-1
INSTALLATION	3-2
Tower Model.....	3-2
Rack-mount Model	3-4

Connection.....	3-7
CHAPTER 4 WINDOWS SETUP	4-1
Express Setup	4-2
SETUP FLOW	4-3
Step 1: Things Required for Setup	4-4
Size of the Partition to be Created	4-5
Step 2: Prepare for Express Setup.....	4-6
2-1: Prepare NEC Express5800/ft series.....	4-6
Step 3: Disable Boot Monitoring Function	4-9
Step 4: Start the Express Setup.....	4-14
Flow of Setup Procedures	4-15
Setup Procedures	4-16
Step 5: Set Dual LAN Configuration.....	4-23
Overview	4-23
NEC Express 5800/Fault Tolerant Server Series Duplication Rule.....	4-24
Dual Configuration Setup	4-24
Step 6: Set Dual Disk Configuration	4-29
Setting Dual Disk Configuration by Disk Management	4-29
Step 7: Update Software.....	4-32
Step 8: Connect and Configure Options	4-32
Step 9: Create Volume.....	4-33
Step 10: Set Network for NEC ESMPRO Agent	4-33
Step 11: Enable Boot Monitoring Function	4-35
Step 12: Make Settings for Failure Management.....	4-36
Set Memory Dump (Debug Information)	4-36
Set Dr. Watson.....	4-41
Install a Network Monitor	4-42
Set Recovery Console.....	4-43
Step 13: Back up System Information.....	4-44
CHAPTER 5 PROCEDURES AFTER COMPLETION OF INSTALLATION.....	5-1
INSTALLING MANAGEMENT UTILITIES	5-2

NEC ESMPRO Agent.....	5-2
NEC ESMPRO Manager	5-11
NEC DianaScope	5-12
CONFIRMATION OF THE GeminiEngine Control Software VERSION	5-13
CAUTIONS FOR APPLYING Windows Service Pack	5-14
CHANGING THE COLOR QUALITY OF DISPLAY TO 32 BIT	5-14
COMPRESSING A SYSTEM DRIVE	5-15
ABOUT Windows Update (APPLYING SECURITY PATCHES)	5-15
CHAPTER 6 TROUBLESHOOTING	6-1
SYSTEM REPAIR	6-2
Preparation.....	6-4
Starting up Recovery Console.....	6-5
Updating the System.....	6-8
Installing GeminiEngine Control Software.....	6-13
TROUBLESHOOTING.....	6-14
Problems with NEC EXPRESSBUILDER	6-14
Problems with Windows Setup	6-15
About the Express Setup	6-17
Problems with NEC ESMPRO Setup	6-21
Problems with System Repair	6-22
APPENDIX A ABOUT SERVICES	A-1

Chapter 1

Before Using

This chapter includes information necessary for proper and safe operation of the server, the main unit and its accessories. Go through this chapter before you start setup of the product.

NOTES FOR SAFE HANDLING

The following section describes necessary information to use the product properly and safely.

Warning Labels

Warning labels are placed in certain parts of the system so that the user stays alert to possible risks (Do not remove or damage these labels).

If some label is missing, about to peel off, or illegible, contact your sales agent.

The figures below show locations of the labels on the server.

Tower model

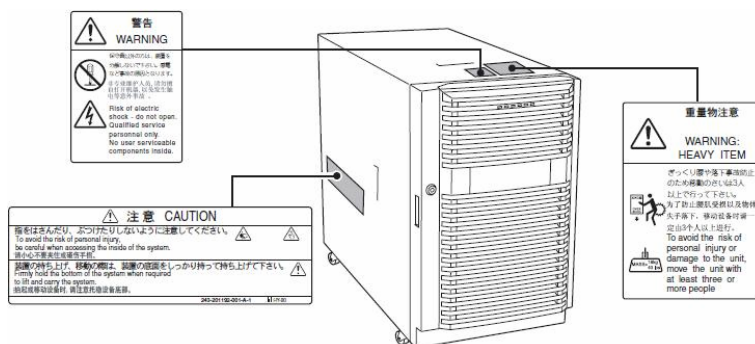

Front

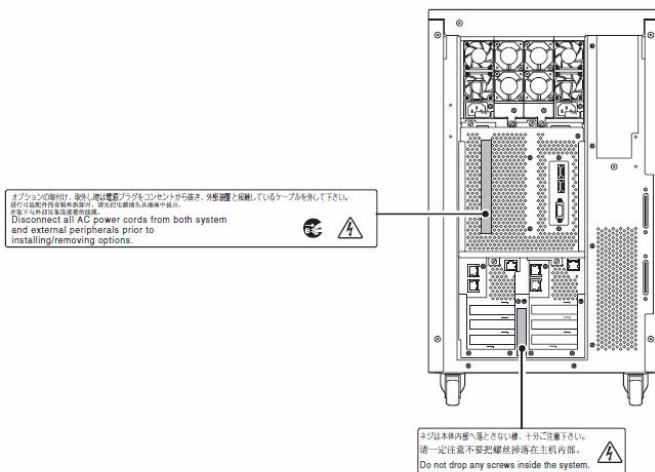

Rear

CPU/IO Modules

The following shows the place on CPU/IO modules where the label is attached.

Standard Model



⚠ 注意 CAUTION

ボード及びオプション機器の接続の際は、必ずユーザーズガイドを参照し、正しく接続して下さい。誤った接続は、故障や火災の原因となります。

对板卡以及可选设备进行连接时，请务必参照“用户指南”，正确进行连接。如果错误连接，可能会导致故障或火灾的发生。

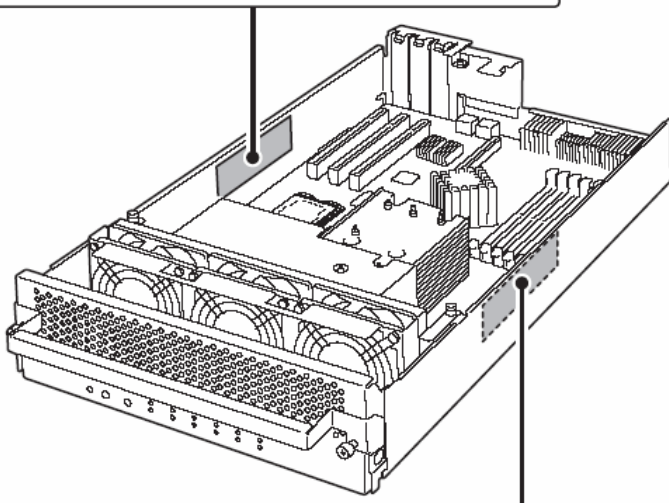
Refer to the "User's Guide" when option board or peripherals are installed. Incorrect installations may result in damage to the system and lead to accidents.



⚠ 注意 CAUTION  

・高温になるコンポーネントがあります。十分に冷えてから触れるようにしてください。

・電源を切ってもバッテリーで稼働している部分があります。保守をずるまえに各々のコンポーネントの取り扱い説明書をお読みください。

• As some components may become very hot during system operation, give ample time to allow cooling as well as use precaution when handling internal components immediately after powering down. • Some internal components may still be operational on battery power. Refer to instruction manuals for this system as well as options prior to maintenance.

・有的部件可能会达到高温。请注意待其冷却之后再接触。

・有的部件即使切断电源仍然使用电池在运转。进行设备维护前，请务必先阅读各部件相关的说明书。

Water-Cooling kit

⚠ 注意 CAUTION

ボード及びオプション機器の接続の際は、必ずユーザーズガイドを参照し、正しく接続して下さい。
誤った接続は、故障や火災の原因となります。

对板卡以及可选设备进行连接时，请务必参照“用户指南”，
正确进行连接，如果错误连接，可能会导致故障或火灾的发生。

Refer to the "User's Guide" when option board or peripherals are installed. Incorrect installations may result in damage to the system and lead to accidents.

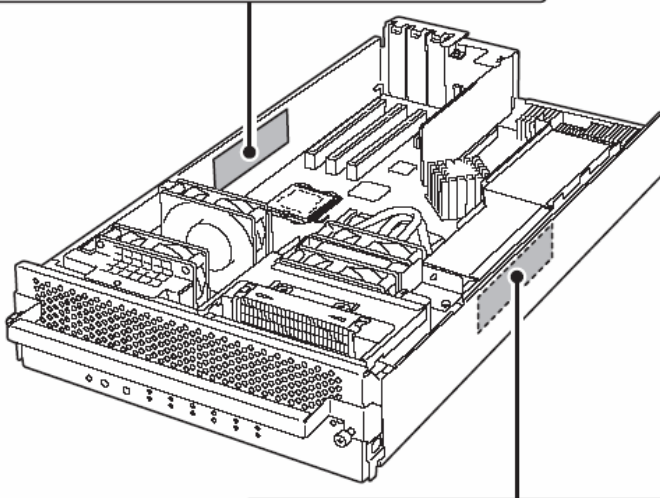

⚠ 注意 CAUTION



・高温になるコンポーネントがあります。十分に冷えてから触れるようにしてください。
・電源を切ってもバッテリーで稼働している部分があります。保守をするまえに各々のコンポーネントの取り扱い説明書をお読みください。

・ As some components may become very hot during system operation, give ample time to allow cooling as well as use precaution when handling internal components immediately after powering down. • Some internal components may still be operational on battery power. Refer to instruction manuals for this system as well as options prior to maintenance.

・ 有的部件可能会达到高温。请注意待其冷却之后再接触。
・ 有的部件即使切断电源仍然使用电池在运转。进行设备维护前，
请务必先阅读各部件相关的说明书。

PRECAUTIONS FOR SAFETY

This section provides precautions for using the server safely. Read this section carefully to ensure proper and safe use of the server. For symbol meanings, see “Safety Indications” described in the previous section.

General

WARNING



Do not use the server in an operation where human lives are involved or high reliability is required.

This equipment is not intended for use in controlling or use with facilities or systems where human lives are involved or high reliability is required, including medical devices or nuclear, aerospace, transportation, and traffic control facilities. NEC assumes no liability for any accidents or damage to physical assets resulting from the use of this equipment in such systems or facilities.



Do not continue to use the server if you detect smoke, odor, or noise.

If the server emits smoke, odor, or noise, immediately flip off the POWER switch, unplug the cords, and contact your sales agent. There is a risk of a fire.



Do not insert a wire or metal object.

Do not insert a wire or metal objects into a vent or disk drive slot. There is a risk of an electric shock.

CAUTION



Prevent water or foreign objects from getting into the server.



Do not let water or foreign objects (e.g., pins or paper clips) enter the server. There is a risk of a fire, electric shock, and breakdown. When such things accidentally enter the server, immediately turn off the power and unplug the cords. Contact your sales agent instead of trying to disassemble it yourself.

Use of Power Supply and Power Cord

⚠ WARNING



Do not handle power plugs with a wet hand.

Do not plug/unplug power cords with a wet hand. There is a risk of an electric shock.



Do not connect the ground wire to a gas pipe.



Never connect the ground wire to a gas pipe. There is a risk of a gas explosion.

⚠ CAUTION



Do not plug the cords in nonconforming outlets.



Use wall outlets with specified voltage and power type. There is a risk of a fire or current leakage.

Avoid installing the server where you may need extension cords. If the cords do not meet the power specifications, there is a risk of overheating that could lead to a fire.



Do not plug too many cords in a single outlet.

If the rated current is exceeded, there is a risk of overheating that could lead to a fire.



Do not plug the cords insecurely.



Insert the plug firmly into an outlet. There is a risk of heat or fire due to poor contact. If dust settles on the slots and it absorbs moisture, there is also a risk of heat or fire.



Do not use nonconforming power cords.



AC cord is to spend the thing of the next specifications:
Maximum 4.5m (14.76ft) long. Rated minimum 125V, 10A, Type SJT flexible cord.

You also have to observe the following prohibitions to prevent an electric shock or fire caused by damage to the cords.

- Do not pull on the cords.
- Do not pinch the cords.
- Do not bend the cords.
- Keep chemicals away from the cords.
- Do not twist the cords.
- Do not place any object on the cords.
- Do not use cords as bundled.
- Do not alter, modify, or repair the cords.
- Do not staple the cords.
- Do not use any damaged cord. (Replace it with a new one of the same specifications. For replacement procedures, contact your sales agent.)

Installation, Relocation, Storage and Connection

CAUTION



Do not install the server in an unsuitable place.

Install the server in such a place as specified in this User's Guide. Avoid the following locations. There is a risk of a fire.

- a dusty place
- a humid place located near a boiler, etc
- a place exposed to direct sunlight
- an unstable place



Do not use or store this product in a corrosive environment.

Avoid the usage or storage of this product in an environment which may be exposed to corrosive gases, such as those including but not limited to : sulfur dioxide, hydrogen sulfide, nitrogen dioxide, chlorine, ammonia and/or ozone. Avoid installing NEC Express5800/ft series in a dusty environment or one that may be exposed to corrosive materials such as sodium chloride and/or sulfur.

Avoid installing this product in an environment that may have excessive metal flakes or conductive particles in the air.

Such environments may cause corrosion or short circuits within this product, resulting in not only damage to this product, but may even lead to be a fire hazard. If there are any concerns regarding the environment at the planned site of installation or storage, please contact your sales agent.



Do not use any non-designated interface cable.

Use only interface cables designated by NEC; identify which component or connector to attach beforehand. If you use a wrong cable or make a wrong connection, there is a risk of short-circuit that could lead to a fire.

You also have to observe the following prohibitions about handling and connecting interface cables:

- Do not use any damaged cable connector.
- Do not step on the cable.
- Do not place any object on the cable.
- Do not use the server with loose cable connections.
- Do not use damaged cables.

Cleaning and Handling of Internal Devices

⚠ WARNING



Do not disassemble, repair, or alter the server.



Unless described herein, never attempt to disassemble, repair, or alter the server. There is a risk of an electric shock or fire as well as malfunction.



Do not look into the CD-ROM drive.



The CD-ROM drive uses a laser beam. Do not look or insert a mirror inside while the system is on. A laser beam is invisible; if your eyes get exposed to it, there is a risk of losing eyesight.



Do not detach a lithium battery yourself.

This equipment has a lithium battery. Do not detach it yourself. If the battery is exposed to fire or water, it could explode. When the lithium battery is running down and the server does not work correctly, contact your sales agent instead of disassembling, replacing or recharging it yourself.



Disconnect the power plugs before cleaning the server.



Even though built-in options for the server can be replaced while the power cords are connected to power source, be sure to follow the instructions described in this User's Guide. Do not touch any internal device of the server unless instructed by this User's Guide. There is a risk of an electric shock.

Make sure to power off the server and disconnect the power plug from a power outlet before cleaning or installing/removing internal optional devices. Touching any internal device of the server with its power cords connected to power source may cause an electric shock even if the server is off-powered.

Disconnect the power plug from the outlet occasionally and clean the plug with a dry cloth. Heat will be generated if condensation is formed on a dusty plug, which may cause a fire.

⚠ CAUTION



High temperature

Immediately after powering off the system, system components such as hard disk may be very hot. Wait for the server to cool down completely before adding/removing components.



Make sure to completely insert cables and boards.

Completely insert all power cords, interface cables and/or boards. An incompletely inserted component may cause a contact failure, resulting in fire and/or smoke.

⚠ CAUTION



Protect the unused connectors with the protective cap.

The unused power cord connectors are covered with the protective cap to prevent short circuits and electrical hazards. When removing the power cord connector from the internal devices, attach the protective cap to the connector. Failure to follow this warning may cause a fire or an electric shock.

During Operation

⚠ CAUTION



Keep animals away.

Keep animals away from the server. Animal's waste or hair may get inside the server to cause a fire or electric shock.



Do not place any object on top of the server.

The object may fall off to cause injuries, damage to hardware and/or a fire.



Do not leave the CD tray ejected.

Dust may get in the server to cause malfunction. The ejected tray may also become a cause of injuries.



Do not touch the server when it thunders.

Unplug the server when it threatens to thunder. If it starts to thunder before you unplug the server, do not touch the server or cables. There is a risk of a fire or electric shock.



Do not use a cellular phone or pager around the server.

Turn off your cellular phone or pager when you use the server. Their radio waves may cause the server to malfunction.

Rack-mount Model (Model 320Fb-MR)**⚠ WARNING**

Do not install the server on a nonconforming rack.

Install the server on a 19-inch rack conforming to the EIA standard. Do not use the server without a rack or install it on a nonconforming rack. The server may not function properly, and there is a risk of damage to physical assets or injuries. For suitable racks, contact your sales agent.



Do not use the server in an unsuitable place.

Do not install a server rack in an unsuitable environment. Other systems also may be affected, and the rack may fall over to cause a fire or injuries. For details about installation environment and quake-resistant engineering, see the attached manual or contact your sales agent.

⚠ CAUTION

Be careful not to hurt your fingers.

Exercise great care not to hurt your fingers on the rail when you mount/dismount the server into/from the rack.



Carry or install the server by more than 3 people.

To avoid a risk of injuries, users should not attempt to carry or install the server into a rack. Installation should be performed by trained maintenance personnel.



Do not install the server in such a manner that its weight is imposed on a single place.

To distribute the weight, use stabilizers or attach two or more racks. Unstable rack may fall down to cause injuries.



Do not assemble parts alone.

It takes at least two people to mount doors and trays to a rack. If you handle them alone, you may drop some parts to cause a breakage or injuries.



Do not pull a device out of the rack if the rack is unstable.

Before pulling out a device, make sure that the rack is fixed (by stabilizers or quake-resistant engineering).



Do not leave more than one device pulled out from the rack.

If you pull out more than one device, the rack may fall down. You can only pull out one device at a time.

 **CAUTION**



Do not install excessive wiring.



To prevent burns, fires, and damage to the server, make sure that the rated load of the power branch circuit is not exceeded. For more information on installation and wiring of power-related facilities, contact your electrician or local power company.







Do not pull out a device during operation.



Do not pull out or remove a device while it is running. There is a risk of malfunction and a device may be detached from a rack to cause injuries.

安全注意事項

本節講述安全使用本伺服器所需的注意事項。爲了您正確安全地使用本伺服器，請仔細閱讀該節內容。符號的相關說明請參考“安全標示（SAFETY INDICATIONS）”說明。

一般注意事項

 WARNING	
	<p>不要用於危及人命和需要高度可靠性的操作。</p> <p>本產品不要安裝在醫療設備、原子能設備、航空宇宙機器、運輸設備等會危及人命以及需要高度可靠性的設備和機器上，也不要使用本產品來控制這些機器。如果將本產品用於這類系統的設備及機器，造成人身事故及財產損失等後果，本公司概不負責。</p>
	<p>發生冒煙、異味、雜音時不要使用。</p> <p>發生冒煙、異味、雜音等時，請直接關閉電源POWER，並將電源插頭從插座上拔下。然後請與經銷商或維護服務公司聯繫。繼續使用會導致火災。</p>
	<p>不要插入鐵絲和金屬片。</p> <p>不要將金屬片和鐵絲等異物插入通氣孔或軟碟機、光碟機的縫隙。有觸電的危險。</p>

 CAUTION	
 	<p>設備內不要進水和異物。</p> <p>設備內不要進入水、針、夾子等異物。有可能導致火災和觸電。一旦進入異物，請立即關閉電源，將電源插頭從插座上拔下來。不要自行拆卸，請與經銷商或維護服務公司聯繫。</p>

使用電源及電源線注意事項

⚠ WARNING



不要用濕手拿電源插頭。

不要用濕手插拔電源插頭。有觸電的危險。



不要把地線連接到煤氣管道上。



請勿將地線連接到煤氣管道上。有導致煤氣爆炸的危險。

⚠ CAUTION



不要插入未指定的插座。

電源請使用指定電壓及電源的壁式插座。使用未指定的電源會造成火災和漏電。請避免使用延長線安裝設備。如果連接與本產品電源規格不相符的電線，會因過熱而導致火災。



不要在一個插座上插接多個電源線。

插座如果超過額定電流，會因過熱而導致火災的危險。



不要只插入一半。



請將電源插頭直插到底部。如果插入一半會因接觸不良而發熱，造成火災。另外，插入部如附著灰塵、水滴等，會因發熱導致火災。



不要使用未指定的電源線。

請使用下列規格的AC電源線。

最長4.5m (14.76 ft)，最小額定電壓125V，10A，SJT電源線。

此外，操作和連接電源線時請遵循以下注意事項。

- 不要拖拽電源線。
- 不要夾電源線
- 不要彎折電源線。
- 不要使電源線靠近化學藥品。
- 不要扭曲電源線。
- 不要踩踏電源線。
- 不要在電源線上載入物品。
- 不要捆綁電源線。
- 不要對電源線進行改造、加工、修復。
- 不要用固定器等固定電源線。
- 不要使用損傷的電源線。（損傷的電源線要立即更換為相同規格的電源線。更換事宜請與經銷商或維護服務公司聯繫）

安裝，移動，保管及連接注意事項

⚠ CAUTION



不要安裝或存放在未指定的場所。

不要將本設備放置在如下場所和本書未指定的場所，有導致火災的危險。

- 灰塵較多的場所
- 熱水器旁等濕氣較高的場所
- 陽光直射的場所
- 不平穩的場所



不要在腐蝕性環境中使用或存放設備。

不要在有腐蝕性氣體（如二氧化硫、氫化硫、氮、氫、氨或臭氧等）的環境中使用或存放本產品。

不要將本產品安裝在灰塵較多或含有腐蝕性物質如氫化鈉或硫磺等的地方。

不要將本產品安裝在空氣中含有過量金屬碎末或傳導粒子的地方。

上述環境可能導致本產品腐蝕或短路，因而損壞產品，甚至引起火災。

對產品安裝或存放環境有任何疑問，請與經銷商或維修服務公司聯繫。



不要使用未指定的信號線。

使用NEC指定的信號線，並在確認連接設備和介面後進行連接。使用未指定信號線或連接錯誤等會造成短路、導致火災。

信號線的操作和連接，須遵守以下注意事項：

- 不要使用任何損壞的信號線接頭。
- 不要腳踏信號線。
- 不要在信號線上載入物品。
- 信號線接鬆動時不要使用。
- 不要使用任何損壞的信號線。

整理及操作內部設備時的注意事項

⚠ WARNING



不要自行拆卸、修理或改造本伺服器。



除本書記載的情況外，不要進行拆卸、修理、改造。否則，不但可能導致設備不能進行正常運行，還有發生觸電和火災的危險。



不要看光碟機內部。



光碟機使用了雷射，請不要在電源打開的狀態下觀看內部或插入鏡子等。雷射射入眼睛有導致失明的危險（雷射肉眼看不見）。



不要擅自拆除鋰電池。

本產品內部安裝有鋰電池。請不要拆下電池。鋰電池靠近火或浸水均有可能發生爆炸。

由於電池使用期限而導致設備不能正常運行時，不要自行拆卸、更換、充電等，請與經銷商或維護服務公司聯繫。



清潔伺服器前請拔下電源插座。



整理或拆裝本設備內部的選購配置時，要切斷設備電源，並拔下電源插頭。即使已關閉電源，但連接著電源線，接觸到任何內部設備也有觸電的危險。

另外，請經常拔下電源插頭，用乾布擦拭灰塵和附著物。有灰塵或水滴等附著時會發熱，有導致火災的危險。

⚠ CAUTION



注意高溫

本產品關閉電源後，內置硬碟等內部設備仍然處於高溫狀態。請在充分冷卻之後進行拆裝。



確認安裝完畢。

電源線和信號線、配件板要確實安裝妥當。
安裝不牢有可能引起接觸不良，可能造成冒煙和著火。

⚠ CAUTION

請用保護蓋保護好未使用的介面。

請用保護蓋保護好未使用的電源線介面以防止短路或觸電。從內部設備上拔下電源插頭時，用保護蓋蓋好介面，否則有導致火災或觸電的危險。

操作注意事項**⚠ CAUTION**

不要讓寵物靠近。

寵物的排泄物和毛髮進入設備可能導致火災和觸電。



設備上不要放置物品。

物品倒下可能引起傷亡，破壞硬體或導致火災。



不要將光碟機托盤拉出放置。

防止托盤中進入灰塵引起運轉錯誤。同時防止因碰撞等造成托盤損傷。



不要在打雷時觸摸機器。

打雷時請拔下電源插頭。如來不及拔下電源插頭，請不要觸摸設備及線纜等，防止發生火災或觸電。



不要在設備附近使用行動電話或呼叫器。

在本產品附近時請關閉行動電話及呼叫器電源，防止因電波影響導致運轉錯誤。

機架式伺服器的注意事項

WARNING



不要將設備安裝在未指定的機架上。

請將設備安裝在符合EIA標準的19英寸機架上。一定要將設備安裝在指定的機架上才能使用。否則設備可能無法正常使用，並有可能損壞機器零部件或導致人身傷害。關於合適的機架，請與您的經銷商聯繫。



不要在未指定的場所使用本伺服器產品。

不要在未指定的環境中安裝伺服器機架。否則，其他系統可能會受到影響，並且機架脫落可能導致火災或者人身傷害。有關安裝環境和防震技術的詳細事項請參閱附帶的用戶手冊或與經銷商或維護服務公司聯繫。

CAUTION



請小心不要夾住或碰傷手指。

將本機器安裝到機架上或者從機架上卸載的時候，請務必小心以免被滑軌劃傷手指。



請確認同時有三人以上一起進行搬運/安裝此伺服器的動作。

爲了避免人身傷害，請不要自行將本機器安裝到機架上。應該由受過專業訓練的維護人員來安裝。



安裝機器時不能將機器的所有重量由一個地方來承載。

爲了分散重量，應該加裝固定器或者同時安裝兩個或更多的機架，否則機架可能會傾倒導致人身傷害。



不要擅自組裝零部件。

將前門和托架安裝到機架上至少需要兩人共同完成，否則可能會因爲零部件跌落而導致損壞或者人身傷害。



不要從不牢固的機架中抽出設備。

在抽出設備之前請確認機架已經被穩固器或者通過抗震技術固定。

⚠ CAUTION

不要從機架抽出兩個或者兩個以上的設備。

同時抽出兩個或者兩個以上的設備可能導致機架傾倒。一次只能抽出一個設備。



不要裝配過多電線。



爲了避免火災和設備損壞，請務必確保不要超過線路的額定負載。有關電力設備的安裝和電線的更多資訊請聯繫電工或者當地的電力公司。



不要在設備運行時拔出設備。

不要拔出或拆除運行中的設備。有導致系統故障和損壞的危險。

UNPACKAGING

The following section describes necessary information to use the product properly and safely.

Accessories

This product is shipped with various accessories. See the attached list to make sure everything is included and check the individual items. If any component is missing or damaged, contact your sales agent.

- Keep the accessories in a safe place. You will need them when you perform setup, addition of options, or replacement of failed components.
- To check NEC EXPRESSBUILDER components, see the attached list.
- Be sure to fill out and mail the software registration card that is shipped with the operating system.
- Make backup copies of included floppy disks, if any. Keep the original disks as the master disks; use these copies in operation.
- Improper use of an included floppy disk or CD-ROM may alter your system environment. If you find something unclear, stop using them and contact your sales agent.

Chapter 2

About Operating System

This chapter gives essential information on the Windows system supported by the server and how to install it.

INSTALLING Windows Server 2003

For installing an operating system on NEC Express5800/ft series, use NEC EXPRESSBUILDER.

IMPORTANT:

The NEC Express5800/ft series is a precision instrument. You should ask maintenance personnel to install it.

The Express Setup program is exclusively used for the NEC Express5800/ft series. To execute the setup program, simply select the item [Express Setup] from the menu displayed when starting the system through the provided CD-ROM "NEC EXPRESSBUILDER." The setup program automatically performs the complete setups from hardware internal parameter/status settings to installation of the operating system (Windows Server 2003) and various utilities.

Use the NEC Express5800/ft series setup program for the first installation and reinstallation of the operating system. This program accomplishes complicate setups.

Before performing the NEC Express5800/ft series setup, contact your sales agent about the latest release of GeminiEngine Control Software.

About OS Installation

Read the notes here carefully before installing the operating system.

Operating System Supported by the NEC Express5800/ft series

The operating system that NEC Express5800/ft series supports is Microsoft® Windows Server™ 2003 R2 32-bit Enterprise Edition (English), hereinafter called "Windows Server 2003."

NEC Express5800/ft series does not support any operating systems other than the above (e.g., Windows Server 2003 Standard Edition, Windows 2000 or Windows NT 4.0).

About Windows Server 2003

Use the Express Setup program to install Windows Server 2003. Note the following at installation:

IMPORTANT:

- Complete all the setups such as the memory expansion and the BIOS setting before installing Windows Server 2003.
 - NEC software package, which is to be purchased separately, is also provided with the documentation for installation. However, see this User's Guide for installation into this server.
 - After completing the Express Setup program, make settings for failure management (e.g., memory dump (debug information) setting) according to Chapter 4.
-

About Auto Installation of Utilities

The Express Setup installs the following utilities automatically.

- Drivers and services for achieving duplicated operation
- NEC ESMPRO Agent

(This page is intentionally left blank.)

Chapter 3

Installing Server

This chapter describes requirements for using the product properly and safely, the setup procedures to make NEC Express5800/ft series ready for use, and how to connect peripherals.

INSTALLATION

This section describes installation of NEC Express5800/ft series.

Tower Model

IMPORTANT:

NEC Express5800/ft series is a precision instrument. You should ask maintenance personnel to install it.

Select a suitable site for tower model.

⚠ CAUTION



Observe the following precautions to use the equipment safely. There are risks of a burn, injury, or damage to physical assets. For details, see "Notes for Safe Handling" in Chapter 1.

- Remove all modules before moving the equipment.
- Do not install the equipment in non-designated places.

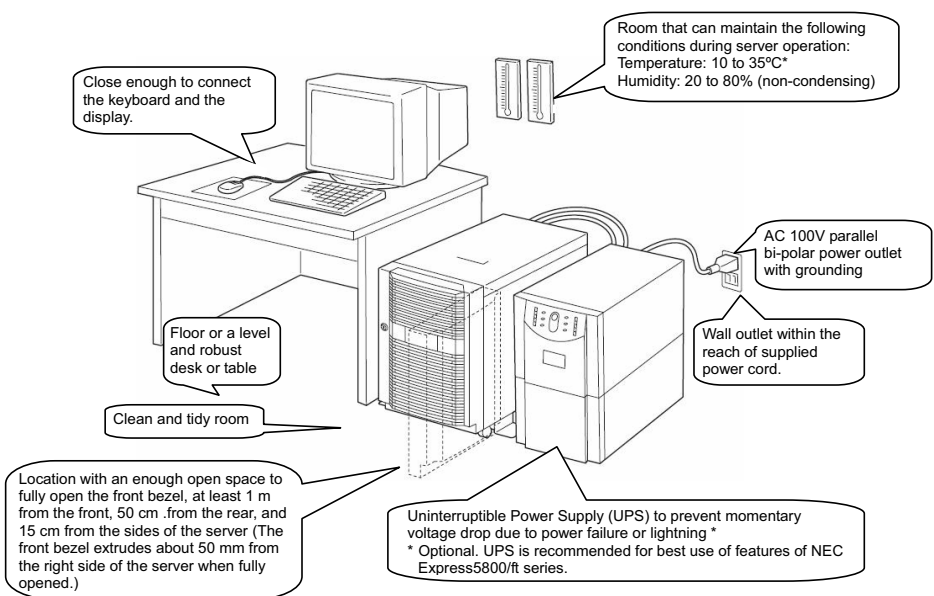

* It is recommendable to use the server in a room where temperature can be kept between 15 and 25°C.

Do not install NEC Express5800/ft series in such places as listed below. Otherwise, the server may malfunction.

- Place where temperatures change widely (near a heater, air conditioner, or refrigerator).
- Place that is subject to intense vibration.
- Place where corrosive gas (sodium chloride, sulfur dioxide, hydrogen sulfide, nitrogen dioxide, or ozone) is generated, or a place that is close to chemicals or exposed to chemicals.
- Place whose floor is covered with non-antistatic carpet.
- Place that may be subject to falling objects.
- Place where you may step or trip on the power cords or interface cables.
- Place that is close to some equipment that generates intense magnetic field (e.g., TV set, radio, broadcasting/communications antenna, power transmission wire, and electromagnetic crane). (If unavoidable, contact your sales agent to request proper shield construction.)
- Place where the power cord of the server must be connected to an AC outlet that shares the outlet of another device with large power consumption.
- Place that is close to some equipment that causes power noises (e.g., sparks caused by power-on/off using a relay). If you must install the server close to such equipment, request your sales agent for separate power cabling or noise filter installation.

It takes at least three people to carry the server; hold it firmly by its bottom and place it slowly on the selected site.

IMPORTANT:

Do not hold the front bezel to lift it, or it may become detached and fall down.

After placing the main cabinet, lock its two front casters out of four and screw the attached four stabilizers on the cabinet adjusting their height.

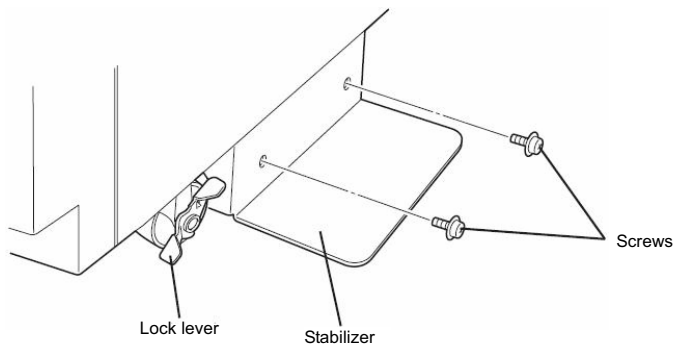

Rack-mount Model

You can mount NEC Express5800/ft series on a rack that conforms to the EIA standards.

IMPORTANT:

NEC Express5800/ft series is a precision instrument. You should ask maintenance personnel to install it.

To install a rack, contact your sales agent or maintenance personnel.

CAUTION



Do not attempt to install the server.

To avoid the risk of personal injury, users should not attempt to install the server into the rack assembly. The server should be installed in the rack only by trained maintenance personnel.

Room that can maintain the following conditions:
[When operating]
Temperature: 10 to 35°C*
Humidity: 20 to 80%
Temperature gradient: ±10°C/hr
Atmospheric pressure: 749 to 1040hpa
[When not operating]
Temperature: 5 to 40°C*
Humidity: 10 to 80%
Temperature gradient: ±15°C/hr
Atmospheric pressure: 749 to 1040hpa



Space 40 cm or more on top, 1 m or more on the front and rear, and 60 cm or more on the right and left.

100V - 120 V or 200V - 240 V parallel bi-polar power outlet with grounding

Wall outlet within the reach of supplied power cord.



Level and reinforced floor.

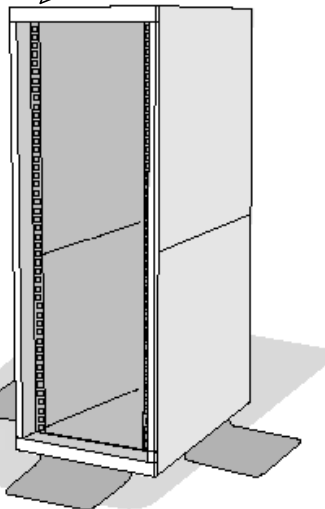

* It is recommended to use the server in a room where temperature can be kept between 15 and 25°C.

⚠ WARNING

Observe the following precautions to use the server safely. There is a risk of a death or serious injury. For details, see "Notes for Safe Handling" in Chapter 1.

- Do not install the server in non-designated places.
- Do not connect the ground wire to a gas pipe.

⚠ CAUTION

Observe the following precautions to use the server safely. There is a risk of a burn, personal injury, or damage to physical assets. For details, see "Notes for Safe Handling" in Chapter 1.

- Do not carry or install a rack alone.
- Do not install a rack in such a manner that its weight is imposed on a single place.
- Do not assemble or disassemble parts alone.
- Do not pull a device out of the rack if the rack is unstable.
- Do not leave more than one device pulled out from the rack.
- Do not install excessive wiring.

Do not install NEC Express5800/ft series in such places as listed below. If you locate racks or install the server in such places, the server may malfunction.

- Place where you cannot pull out the components fully.
- Place that cannot sustain the total weight of the rack and its components.
- Place where you cannot use stabilizers or where you cannot perform installation without quake-resistant engineering.
- Place whose floor is uneven or inclined.
- Place where temperatures change widely (near a heater, air conditioner, or refrigerator).
- Place that is subject to intense vibration.
- Place where corrosive gas (sodium chloride, sulfur dioxide, hydrogen sulfide, nitrogen dioxide, or ozone) is generated, or a place that is close to chemicals or exposed to chemicals.
- Place whose floor is covered with non-antistatic carpet.
- Place that may be subject to falling objects.
- Place that is close to some equipment that generates intense magnetic field (e.g., TV set, radio, broadcasting/communications antenna, power transmission wire, and electromagnetic crane). (If unavoidable, contact your sales agent to request proper shield construction.)
- Place where the power cords of the server must be connected to outlets that share the outlet of another device with large power consumption.

- Place that is close to some equipment that causes power noises (e.g., sparks caused by power-on/off using a relay). If you must install the server close to such equipment, request your sales agent for separate power cabling or noise filter installation.

IMPORTANT:

Temperature increase inside the rack and airflow

If you install several components or the ventilation isn't good inside the rack, the internal temperature may increase due to heat emitted from the components. When the operating temperatures of NEC Express5800/ft series (10 to 35°C) are exceeded, there is a risk of malfunction. You must take adequate precautions and measures for airflow inside the rack as well as in the room so that the internal temperature can be kept within this range during operation.

Connection

Connect peripheral devices to NEC Express5800/ft series.

The server is provided with connectors for wide variety of peripheral devices on its front and rear. The figure on the next page illustrates available peripheral devices for the server in the standard configuration, and locations of the connectors for the devices. After connecting the peripheral devices, connect the provided power cords with the server, and then plug the power cords into the power outlet.

WARNING



Observe the following precautions to use the server safely. There is a risk of a death or serious injury. For details, see “Notes for Safe Handling” in Chapter 1.

- Do not hold the power plug with a wet hand.
- Do not connect the ground wire to a gas pipe.

CAUTION



Observe the following precautions instructions to use the equipment safely. There is a risk of a burn, personal injury, or damage to physical assets. For details, see “Notes for Safe Handling” in Chapter 1.

- Do not plug the power cord in a nonconforming outlet.
- Do not plug too many cords in a single outlet.
- Do not plug the cord insecurely.
- Do not use nonconforming power cords.

IMPORTANT:

- Power off the server before connecting peripheral devices, with the exception of peripherals with USB interface. Connecting a powered peripheral device to the powered server will cause malfunctions and failures.
 - To connect a third-party peripheral device or interface cable to the server, check with your sales agent to see if they are compatible with NEC Express5800/ft series. Some third-party devices may not be used with the server.
 - The total cable length of SCSI device connections is up to 6 m, including the internal SCSI cables.
 - The serial port connectors are reserved for maintenance.
 - Place the USB floppy disk drive on the server. Space of 1U is needed to put it on the server.
-

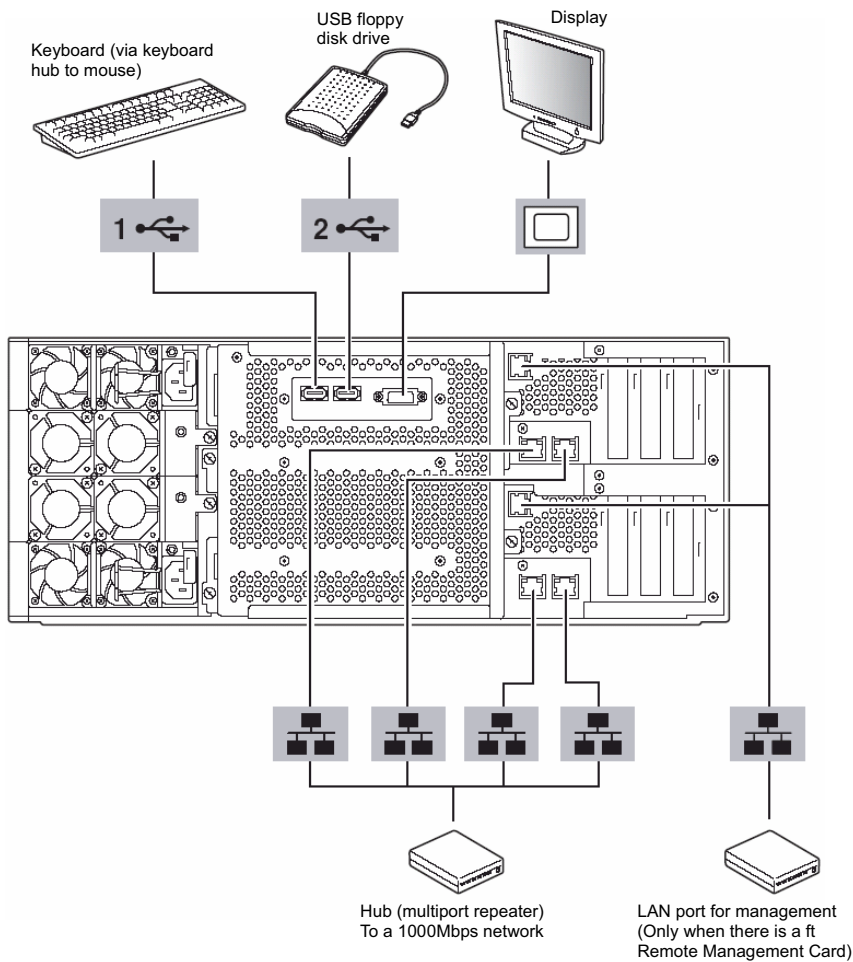

IMPORTANT:

Connection of optional devices

- In the case of standard configuration, you need to complete setup of the operating system before mounting optional PCI cards or hard disks that you purchased separately.
 - If N8803-033 is mounted, be sure to connect cables to the FC array unit before going on to the next step.
-

Insert the power cords to the AC inlets of the power unit.

Then, secure the power cords using the locking springs on the power units.

When completing connection to peripheral equipment, connect the two provided power cords to the server. After that, secure the cables with the cable tie provided in the server.

Connect the plug at the other end of the power cord to a wall outlet with parallel double-pole grounds provided or to an uninterruptible power supply (UPS).

To use the functions of the server, you should connect the server to the UPS.

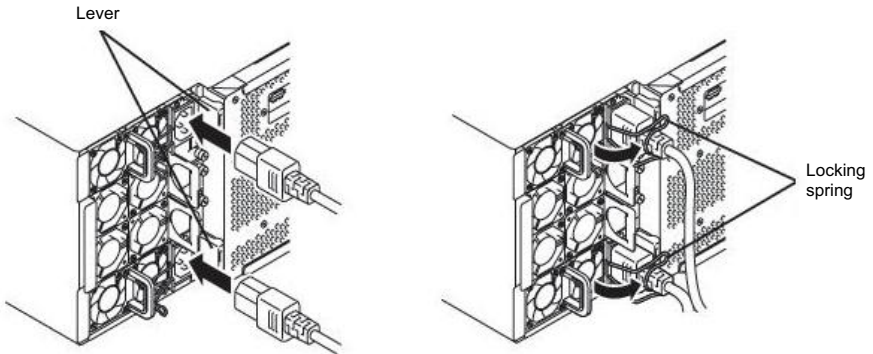

IMPORTANT:

- Be sure to use both of the power cords to make the server fault-tolerant.
- After connecting the power cords, wait at least 30 seconds before pressing the power switch.

To connect the power cords from the server to an uninterruptible power supply (UPS), use service outlets on the rear of the UPS.

The UPS service outlets are categorized into two groups: SWITCH OUT and UN-SWITCH OUT. (They may be called "OUTPUT1" and "OUTPUT2".)

For constant power supply, connect the power cords to a UN-SWITCH OUT outlet. (Connect the modem that is in service for 24 hours to this outlet.)

When the power cords from the server are connected to a UPS, change the BIOS setup of the server to link with power supply from the UPS.

Select [AC-LINK] from [Server] on the BIOS setup utility and change parameters. See the separate volume of User's Guide for details.

<Example>

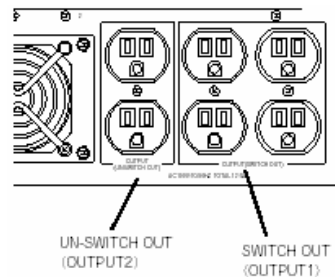

(This page is intentionally left blank.)

Chapter 4

Windows Setup

This chapter describes procedures for configuring boot monitoring function, setup, installing Windows, setting dual LAN configuration, setting dual disk configuration and so on.

Express Setup

Use NEC EXPRESSBUILDER to setup the NEC Express5800/ft series.

IMPORTANT:

NEC Express5800/ft series is a precision instrument. You should ask maintenance personnel to install it. You perform Express Setup for reinstallation.

The Express Setup is the install program for the NEC Express5800/ft series. The Express Setup helps you to install Windows Server 2003. You can use the Express Setup for reinstalling Windows Server 2003 to your server as well.

IMPORTANT:

Using the Express Setup will format your system disk.

The "NEC EXPRESSBUILDER" CD-ROM that comes with your server is used to run the Express Setup program.

You will also use the Express Setup when you reinstall the operating system.

SETUP FLOW

The following flow-chart illustrates the flow of the setup procedures for the NEC Express5800/320Fb-L(-R) server and 320Fb-M(-R) server. Corresponding page numbers are shown in parentheses.

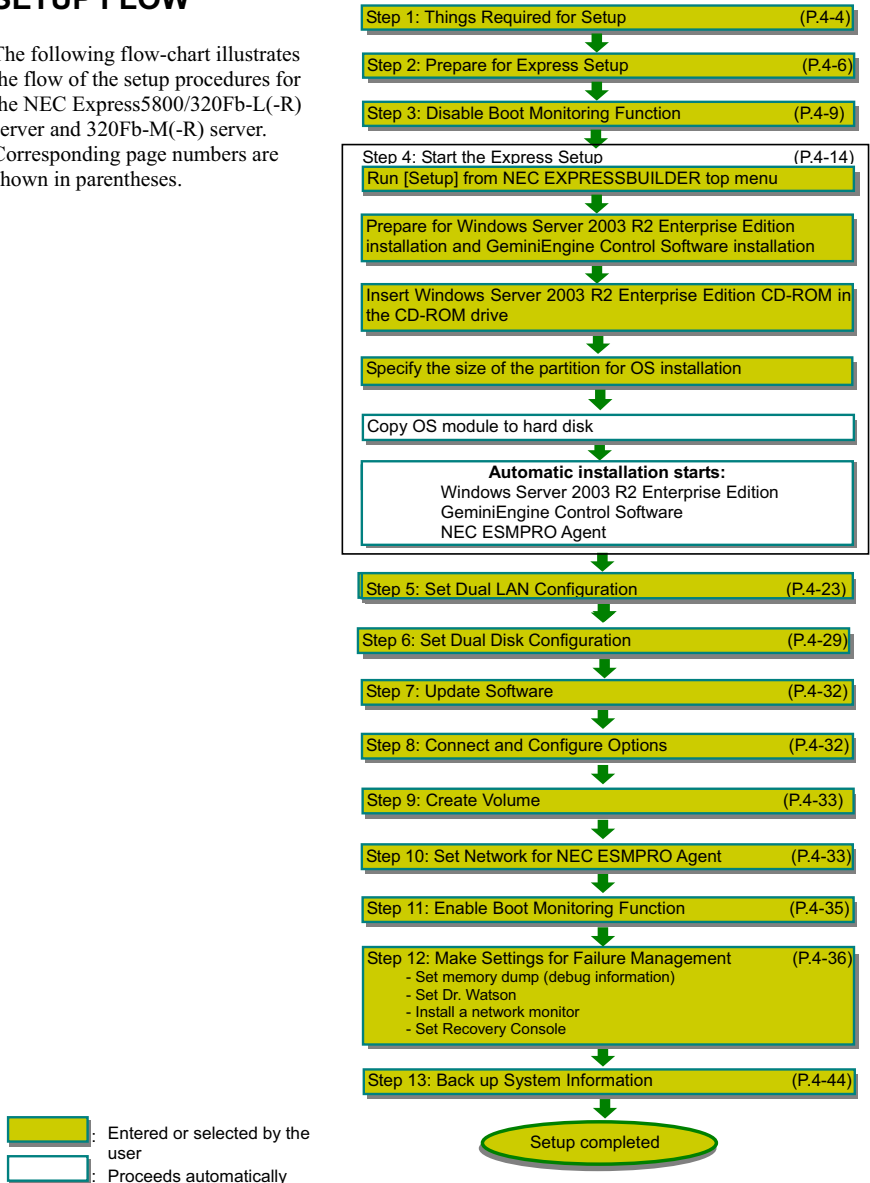

Step 1: Things Required for Setup

The following explains the setup procedure using the Express Setup program:

IMPORTANT:

- Because “Express Setup” formats the entire area of the disk used for reinstallation, all data on that disk will be deleted. If there is any data partition other than system partition that contains OS on the disk for reinstallation, you must back up important data in the data partition first and then start “Express Setup.”
 - Do not apply service packs to NEC Express5800/ft series based on your judgment. If you desire to apply service packs, contact your sales agent about application status and apply service packs to NEC Express5800/ft series.
-

TIPS:

For the latest information on support for Windows Service Pack, contact your sales agent.

You need the following to install Windows Server 2003 R2 32-bit Enterprise Edition:

- NEC EXPRESSBUILDER (CD-ROM)
- GeminiEngine Control Software UPDATE CD-ROM

This CD-ROM is used to update GeminiEngine Control Software; it may not be shipped with the equipment. (Not included if “NEC EXPRESSBUILDER” CD-ROM contains the latest version of software programs at the time of shipment.)

- Microsoft® Windows Server™ 2003 R2 32-bit Enterprise Edition Disk1
(hereinafter referred to as “Windows Server 2003 CD-ROM”)
Microsoft® Windows Server™ 2003 R2 32-bit Enterprise Edition Disk2
- User’s Guide (Setup) (this manual)
- User’s Guide

IMPORTANT:

- About the latest release of GeminiEngine Control Software and purchase of the latest version of its Update CD-ROM, ask your sales agent.
-

Before starting the setup, decide the size of the partition where the operating system will be installed.

Size of the Partition to be Created

The required minimum size of a partition to install the system can be obtained from the following formula:

Size required for installation + paging file size + dump file size	
Size required for installation	= 3,500MB (Windows Server 2003 R2)
Paging file size (recommended)	= size of memory mounted* × 1.5
Dump file size	= size of memory mounted* + 12MB

IMPORTANT:

- The above paging file size is necessary for collecting debug information (memory dump). If a value smaller than the “Recommended” value is set for the initial size of the paging file, correct debug information (memory dump) may not be collected.
- The maximum paging file size is 4095MB in a partition. If 1.5 times the size of mounted memory is larger than 4095MB, set the size at 4095MB.
- If the size of mounted memory is larger than 2GB, the maximum size of dump file is “2048MB+12MB.”

TIPS: The mounted memory size means the total of memory installed on a single CPU/IO module.

For example, if memory of 1GB is mounted, the required minimum partition size obtained from the above formula is as follows:

$$3500\text{MB} + (1024\text{MB} \times 1.5) + (1024\text{MB} + 12\text{MB}) = 6072\text{MB}$$

TIPS: The minimum partition size you can specify in the Express Setup is 6072MB. The partition size must be 6072MB or larger for automatic installation. Therefore the size smaller than 6072MB cannot be specified.

Step 2: Prepare for Express Setup

Before starting Express Setup, be sure to do the following. If these preparations are not done, setup cannot be performed properly.

2-1: Prepare NEC Express5800/ft series

With the power of NEC Express5800/ft series off, follow the steps below:

1. Prepare NEC Express5800/ft series.
 - Mount the modules for both systems.
 - Insert only one hard disk to the slot0.
 - Remove all LAN cables.
 - Remove optional SCSI devices such as a tape device from the SCSI connector.

IMPORTANT:

Do not mount any hard disk into any slots of any modules unless specified. If multiple hard disks are inserted, the hard disk to install OS cannot be determined.

2. Prepare the installation from the module#0.

The location of the parts required for operations and check are show below:

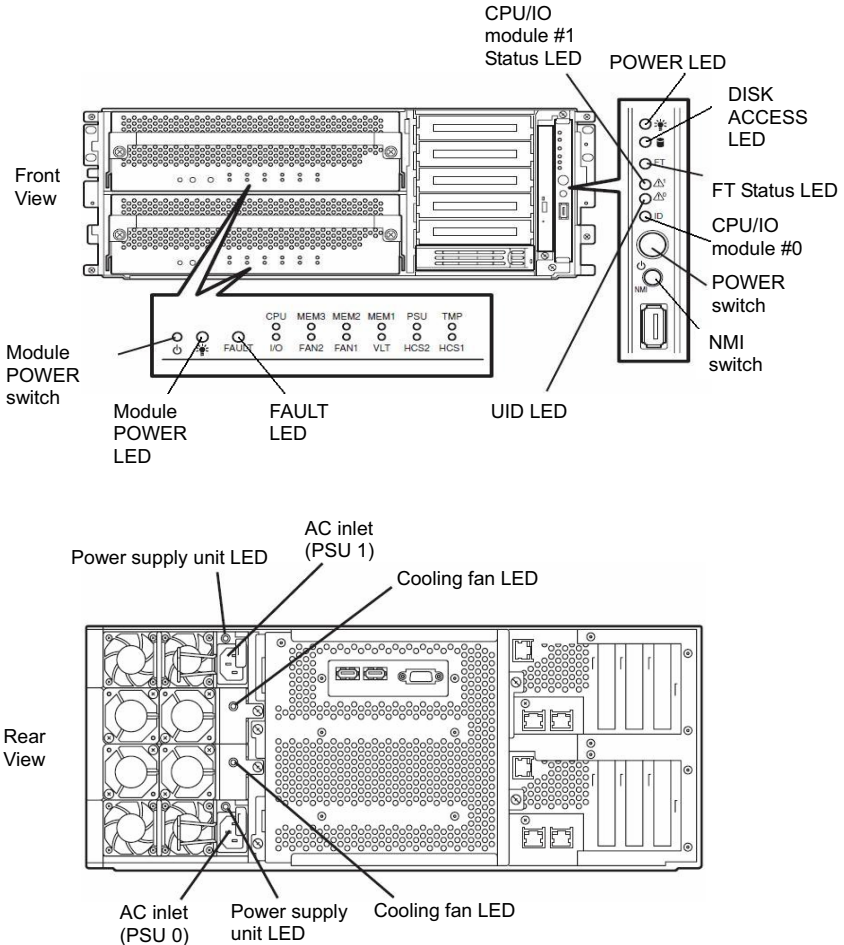

<When the AC power is on (The power cords are plugged to the wall outlet)>

- (1) Confirm the POWER LED of the system.
 - If the POWER LED is lit, shut down the OS and unplug the AC power cord after the POWER LED turns off.
 - If the POWER LED is turned off, unplug the AC power cord.

- (2) Execute the operation to be taken when AC power supply is turned off.

<When the AC power is off (The power cord is not plugged into the outlet)>

Connect the power cords to NEC Express5800/ft series in the following order:

- (1) Connect the power cord to the AC inlet (PSU0)
- (2) Connect the power cord to the AC inlet (PSU1)
- (3) Make sure that the FAULT LED of each module is turned off.

Preparation is now completed.

Step 3: Disable Boot Monitoring Function

Check whether the power is ON and make settings for properly performing setup for later on. This equipment has a function to monitor the main unit at startup. (Enabled in the configuration at shipment)

When reinstalling the operating system, this monitoring function needs to be disabled. Otherwise the installation may not be done properly. Follow the steps in this section and make proper settings.

IMPORTANT:

If you skip the settings described here, the system will be restarted forcefully while Windows setup screen is shown and the setup will be unsuccessful; BIOS may repeat Windows setup in an invalid manner. In this case, you will need to restart the setup procedures from the beginning.

TIPS:

For details of operations for BIOS Setup Utility and parameters, see the separate volume of User's Guide.

<Procedure for Changing BIOS settings>

1. Turn on the display and the peripheral equipment connected to the NEC Express5800/ft series.

CHECK:

If the power cords are connected to a power controller like a UPS, make sure that it is powered on.

2. Detach the front bezel in case of a rack-mount model (or open it in the case of a tower model).

3. Press the POWER switch which is located on the front side of the server.

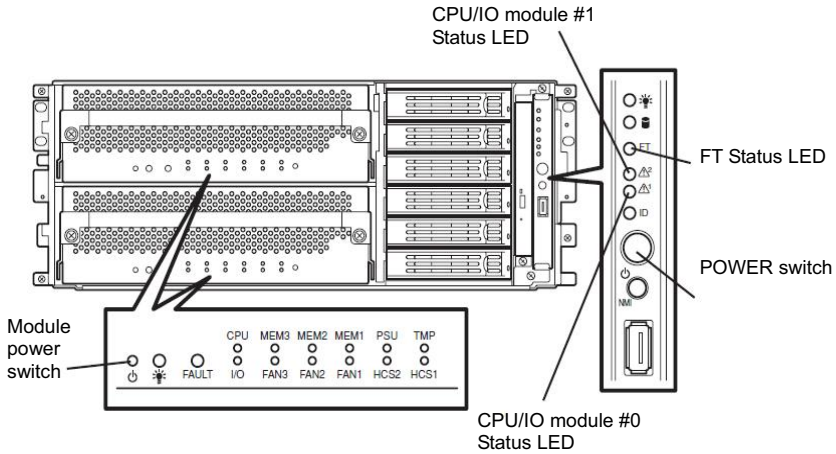

IMPORTANT:

Do not turn off the power before the "NEC" logo appears.

Press the Power switch straight without your nail getting caught.

After a while, the "NEC" logo will appear on the screen.

While the "NEC" logo is displayed on the screen, NEC Express5800/ft series is performing a power-on self test (POST) to check itself. For details, see the separate volume of User's Guide.

CHECK:

If the server finds errors during POST, it will interrupt POST and display the error message. See the separate volume of User's Guide.

4. When the message “Press <F2> to enter SETUP” or “Press <F2> to enter SETUP or Press <F12> to boot from Network” on the display screen, press **F2**.

The BIOS Setup Utility “SETUP” starts and the Main menu is displayed on the screen.

<Example>

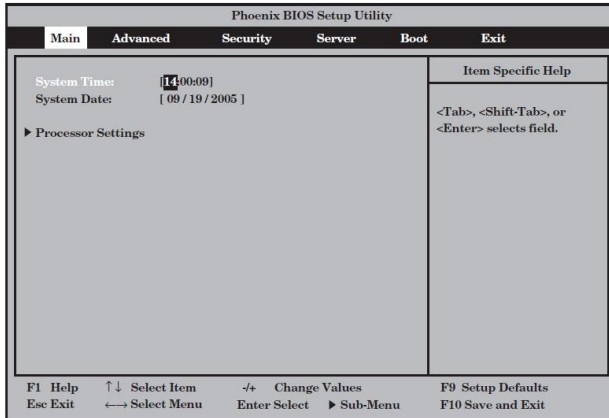

5. Move the cursor onto "Server" and select “Server.”

The Server menu will be displayed.

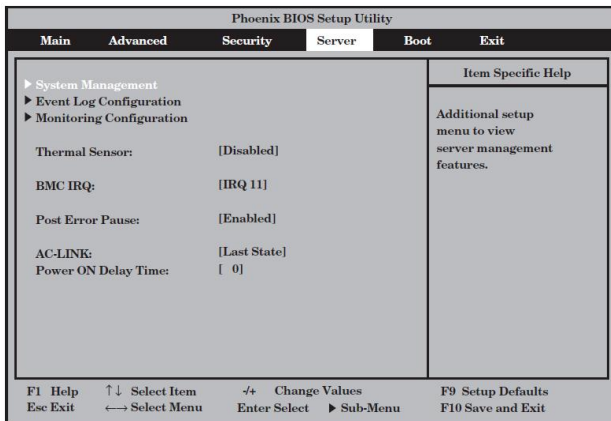

6. Move the cursor onto “Monitoring Configuration” and press **Enter**.

The Monitoring Configuration submenu appears.

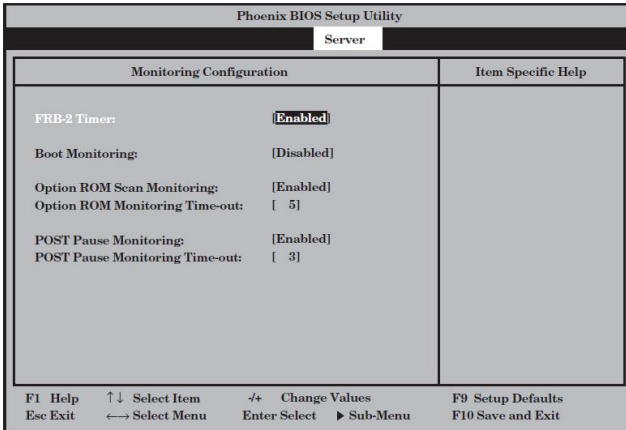

7. Move the cursor onto “Boot Monitoring” and press **Enter**.

Parameters will be displayed.

8. Among the parameters, choose “Disabled” and press **Enter**.

The current display of the configuration for Boot Monitoring will be changed to “Disabled.”

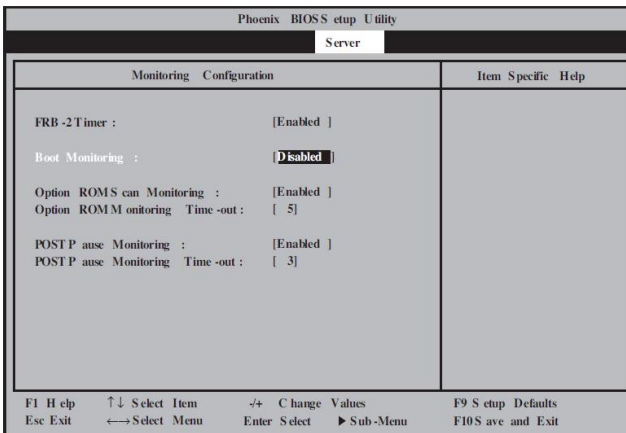

9. Press **Esc** twice to go back to the Advanced menu, and then move the cursor onto "Exit" to display the Exit menu.

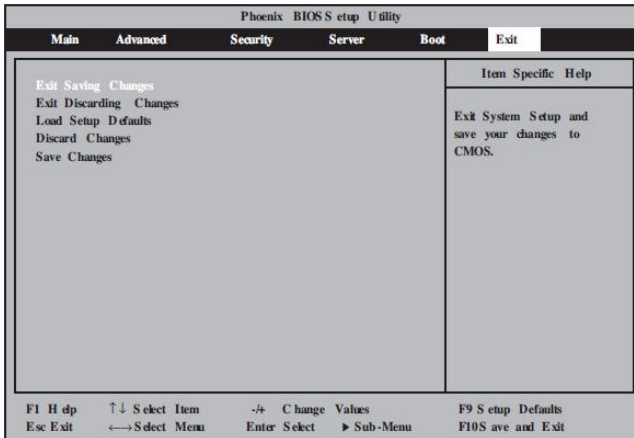

10. Move the cursor onto "Exit Saving Changes" and press **Enter**.

The confirmation window will appear.

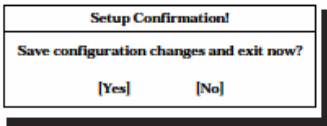

11. Select "Yes" and press **Enter**.

After the configuration data is saved and SETUP is terminated, the system is rebooted. This is the end of steps for switching boot monitoring function.

TIPS:

When reinstalling the OS, power off this server to prepare for reinstallation. Then, referring to "Step 4: Start the Express Setup" on the next page, continue the setup.

Step 4: Start the Express Setup

Set up with the Express Setup functions of NEC EXPRESS BUILDER.

“Express Setup” is a setup method for NEC Express5800 series to smoothly configure settings as internal parameters and status of hardware and to install OS (Windows Server 2003) and various utilities by using the “NEC EXPRESSBUILDER” CD-ROM which comes with the server. Use this “Express Setup” when using hard disk drives with their partition setting different from those at shipment, or when reinstalling the OS. It performs complicated setups automatically.

Express Setup edits the information required for the setup and saves it to a floppy disk before the setup, to proceed a series of setup processes. The floppy disk used here is called [Configuration diskette].

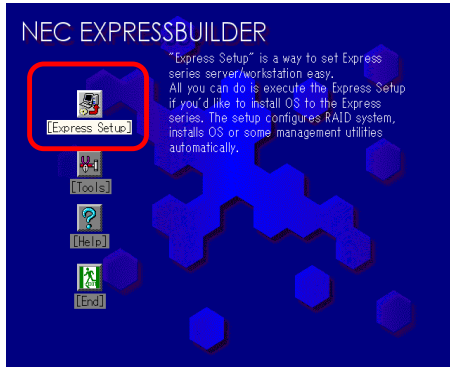

TIPS:

- [Configuration diskette] is a setup disk that stores the information set/selected during Express Setup.

Express Setup executes all the setup process automatically, based on this information. It is not necessary to sit by the system and check the status, during the setup. Also, if you use the Configuration diskette that has been used last time, you can create the same setup condition as the previous one.

- Users are responsible for preparing the Configuration diskette.
- You can create a parameter file in advance, by using “Configuration Diskette Creator®” in NEC EXPRESSBUILDER.

If you create [Configuration diskette] in advance, you can skip the options that need to be entered or selected during Express Setup. (You can create or modify the setup information in the Configuration diskette, during Express Setup). If any computer that is running on Windows XP/2000/Windows Server 2003 is available, it is recommended to edit the setup information with Configuration Diskette Creator in advance.

- You cannot use the mouse in the Express Setup. Use the keyboard to proceed the setup.
-

For the procedure to create a parameter file with Configuration Diskette Creator, refer to User’s Guide.

- **Reinstalling the OS to the hard disk drive that has been upgraded to dynamic disk**

You cannot reinstall Windows Server 2003 if the existing partition of the hard disk drive that has been upgraded to dynamic disk is still there.

Flow of Setup Procedures

The following flow-chart illustrates the setup procedures for Express Setup.

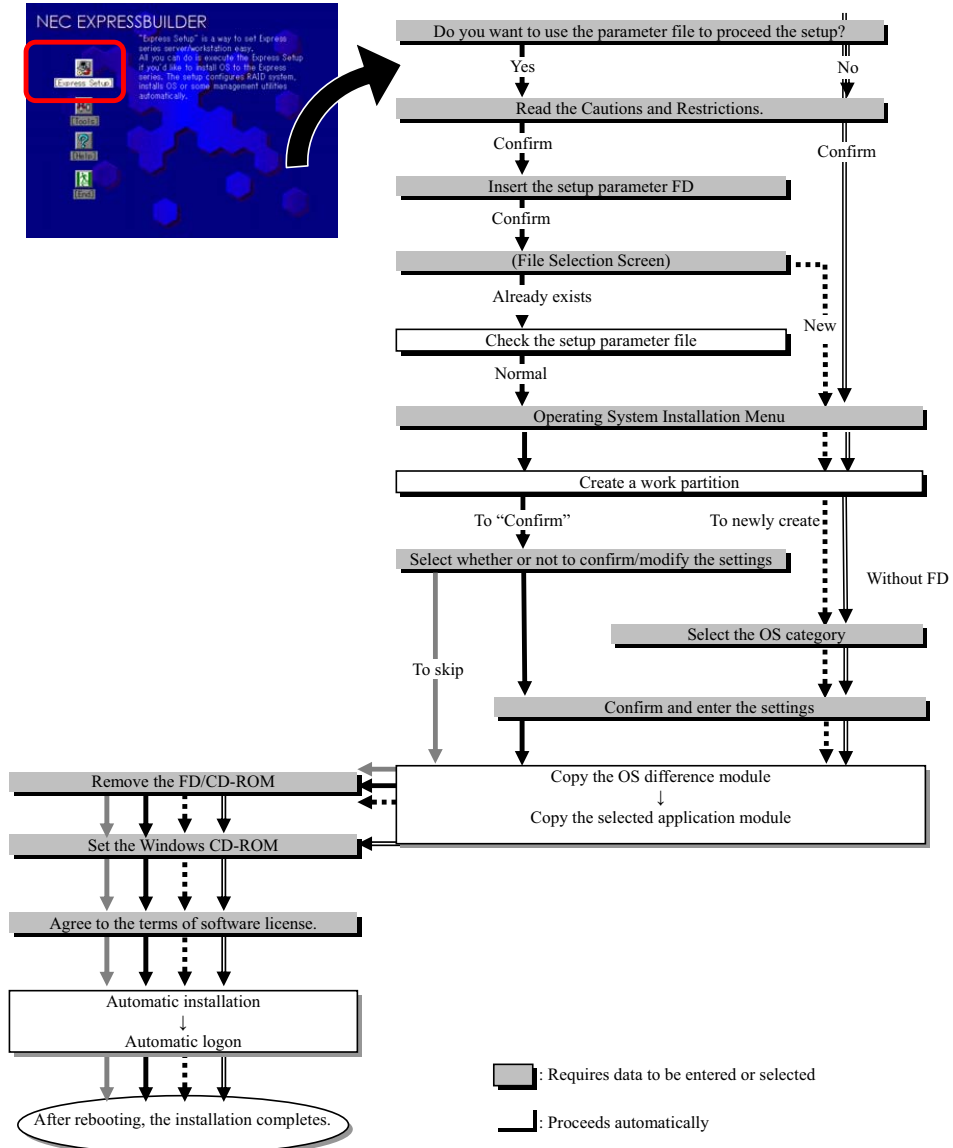

Setup Procedures

Express Setup configures the settings for each of the parameters in the Wizard form. You can also save each of the parameters as one file (parameter file) to a floppy disk.

CHECK:

To execute Express Setup with a parameter file, one empty 1.44MB formatted floppy disk is required. Prepare an empty floppy disk in advance.

When you reinstall OS, you can skip entering the parameter in the Wizard form, by reading the parameter file that has been saved.

Also, during Express Setup, to individually apply the attached driver FDs (OEM-FD for high-capacity storage), it is necessary to configure the parameter file settings as well. You also need to prepare an empty floppy disk for this purpose.

IMPORTANT:

In case of changing the system configuration, update the system (page 6-8).

1. Turn on the peripherals and then NEC Express5800/ft series.

TIPS:

To connect a hard disk drive other than the one to which you install OS, install the OS in advance.

2. Insert the NEC EXPRESSBUILDER CD-ROM into the CD-ROM drive of the server.
3. When having inserted the CD-ROM correctly, reset the system (press **Ctrl, Alt** and **Delete** together), or turn the power off and then turn it on to restart the NEC Express5800/ft series.

The system starts through the CD-ROM, and NEC EXPRESSBUILDER is activated.

4. Select [Express Setup].



5. The message, [Do you want to use the parameters file in order to set up the Express server or workstation?] is displayed. In case of using the parameter file, select [Yes]. In case of not using, select [No].

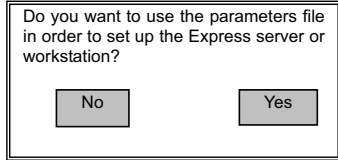

6. [NOTE] is displayed. Read the displayed contents carefully and select [Confirm].

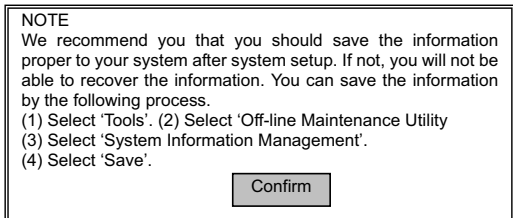

7. Cautions for Express Setup are displayed. Read the displayed contents carefully and select [Confirm].

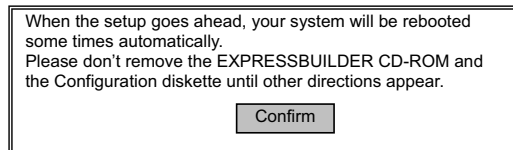

CHECK:

If OS is installed to the disk, the message that confirms whether to continue the installation is displayed. To continue the setup, select [Continue].

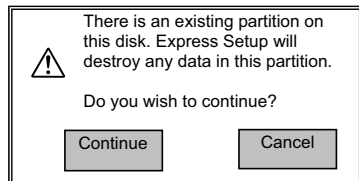

8. In case of using the parameter file, the Configuration Diskette is required, so insert the FD and select [Confirm].
In case of not using the parameter file, this message will not be displayed. Go to Step 9.

CHECK:

Do not remove the floppy disk that has been set in this step until you receive instruction.

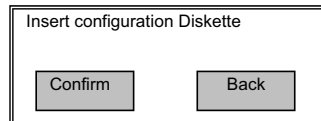

[In case of using an existing parameter]

List of the parameter files on the floppy disk that has been inserted is displayed.

- (1) Select the parameter file that is used for the installation, and select [Use].

The confirmation dialog box will be displayed.

- (2) If you want to confirm the parameter, select [Review]. If you do not need to confirm the parameter and want to proceed the installation, select [Skip].

Select [Review].→ Go to Step 9.

Select [Skip].→ After Step 9, go to Step 15.

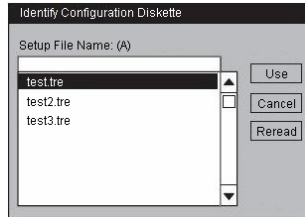

[In case of setting an empty floppy disk]

- (1) Press the **A** key.

The input box will be displayed.

- (2) Enter the file name.

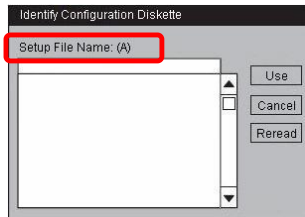

- 9. Select the operating system to install.

Select [Windows] from the list box.

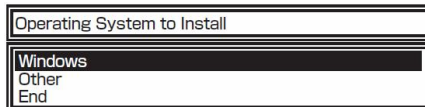

- 10. The confirmation dialog box will be displayed. If you want to confirm the parameter, select [Modify]. If you do not need to confirm the parameter and want to proceed the installation, select [Skip].

Select [Modify]. → Go to Step 11

Select [Skip].→ Go to Step 15

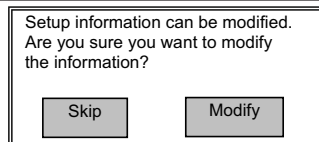

11. When the [Basic information] window is displayed, confirm the information and correct it if necessary. Then press the → key. (The “Target Machine” information on the window differs depending on the model.)

→ key: Used to move to the next screen.

← key: Used to return to the previous screen.

↑ ↓ key: Used to select a menu.

F1 key: Displays help.

ENTER key: Used to select [OK] or to decide each item.

ESC key: Used to select [Cancel].

Basic Information	
Target Machine	Express5800/xxx
Operating System to Install	Windows Server 2003 Standard/Ent
OS Language	United States
System Partition	Create New Partition
Partition Size (Entire Area)**	12288
Convert File System to NTFS	Yes
Apply Service Pack	No
Installation Directory	Windows

Back Next Help

IMPORTANT:

- Allocate the partition to install the OS in the size that is bigger than the required minimum size. (See page 4-5.)
- If you select [Use Existing Partition] in [System Partition], information about the first partition will be formatted and erased all. Information on other partitions will be retained.
- If an existing hard disk drive partition that has been upgraded to the dynamic disk remains, you cannot reinstall OS (refer to page 4-14). Do not select [Use Existing Partition] in [System Partition].
- The file system of the system partition is fixed to be NTFS.
- When you select [Use Existing Partition] in [System Partition], if the partition to be reused only exists (excluding the maintenance domain), reserve the maximum disk space and install Windows Server 2003.
- You cannot move to the next window, if the contents that you have set are incorrect.
- In Express Setup, you cannot specify the details of network adapter. Specify them from Control Panel after starting Windows.
- Detailed setting of the network adapter is not supported by Express Setup. Set it from Control Panel after starting Windows.

12. When the [User Information] window is displayed, confirm the settings and move to the next screens. Correct the settings if necessary. Then press the → key.

→ key: Used to move to the next screen.

User Information	
User Name	
Corporate Name	Corporate Name
Time Zone	(GMT) Greenwich Mean Time:Du
Keyboard Layout	User Default

Back Next Help

← key: Used to return to the previous screen.

↑ ↓ key: Used to select a menu.

F1 key: Displays help.

ENTER key: Used to select [OK] or to decide each item.

ESC key: Used to select [Cancel].

13. When the [Role of Computer] window is displayed, confirm the information and correct it if necessary. Then press the **F9** key. (If the [OK] button is not displayed in the right side of the screen, press the → key.)

F9 key: Used to finish the configuration settings.

→ key: Used to move to the next screen.

← key: Used to return to the previous screen.

↑ ↓ key: Used to select a menu.

F1 key: Displays help.

ENTER key: Used to select [OK] or to decide each item.

ESC key: Used to select [Cancel].

If you press the → key, you can confirm the additional settings. Subsequently, confirm the settings and move to the next screen. Correct the settings if necessary.

Role of Computer	
Computer Name	<input type="text"/>
Role of Computer	Stand Alone Server
Network Setup	Yes
Domain Name	---
Work Group Name	WORKGROUP
Client License	per Server
Maximum Concurrent Clients	5
Create Account (Account Name)	---
(Password)	---
(Password Check)	---
<input type="button" value="Back"/> <input type="button" value="Next"/> <input type="button" value="OK"/> <input type="button" value="Help"/>	

IMPORTANT:

- Once you press the → key to go to the next screen from [Role of Computer], [OK] will not appear even if you go back to this screen.
- [OK] does not appear if the Parameters File that has already been created is loaded.
- In Express Setup, you cannot specify the details of network adapter. Specify them from Control Panel after starting Windows.
- You cannot move to the next window, if the contents that you have set are incorrect.

- To specify the setup parameters, the number of characters must not exceed the limit as shown in the table below (a double-byte character is counted as two characters):

Item	Value specified	Max. number of characters
Creation of New Users	User Name	19
	Group Name	20
	Full Name	63
	Explanation	47
Creation of New Groups	Group Name	20
	Explanation (Group Name)	47

14. The confirmation dialog box will be displayed. If you want to finish the configuration settings, select [OK]. If not, select [Cancel] to return to the configuration screen.

If the configuration settings are correct and complete, press [OK] to continue. If not, press [Cancel] to return to the configuration screen(s).

ENTER key: Used to select [OK] or to decide each item.

ESC key: Used to select [Cancel].

15. Install the application to add.

In case of additionally installing the application compatible with Express Setup, a message will be displayed.

Insert the application's installation medium in the CD-ROM/floppy disk drive.

16. Follow the message, and remove the NEC EXPRESSBUILDER CD-ROM from the CD-ROM drive.

If the setup parameter FD is used at this point, remove it from the floppy disk drive.

17. Set the Windows Server 2003 CD-ROM to the CD-ROM drive.

The [Windows Server 2003 Setup] window will be displayed.

18. Read the contents carefully. If you agree, press the **F8** key. If you do not agree, press the **F3** key.

IMPORTANT:

If you do not agree, the setup will be terminated and Windows Server 2003 will not be installed.

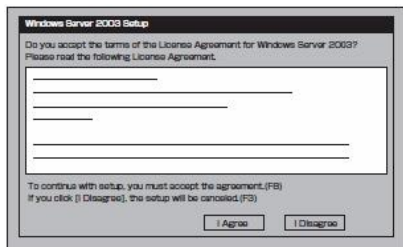

Windows Server 2003 and the specified applications will be automatically installed. Log on to the system.

- 19.** Insert Microsoft(R) Windows Server(TM) 2003 R2 32-bit Enterprise Edition Disk2 into the CD-ROM drive after the OS installation. Follow the instructions on the screen. When the installation is completed, remove the CD from the CD-ROM drive and restart the system.

Now the setup using Express Setup is completed.

Step 5: Set Dual LAN Configuration

The NEC Express5800/ft series builds a dual LAN configuration by using "Intel(R) PRO/1000 MT Dual Port Network Connection" and extended PCI slot "Intel(R) PRO/1000 MT Server Adapter," "Intel(R) PRO/1000 MF Server Adapter" mounted as standard on the CPU/IO module.

Overview

There are two kinds of Dual LAN configurations below.

- **Adapter Fault Tolerance (AFT)**

Adapter Fault Tolerance is a feature to switch to the backup controller immediately and continue the operation if the primary controller fails, by placing more than one LAN controllers on the same LAN (same segment).

- **Adaptive Load Balancing (ALB)**

Adaptive Load Balancing (ARB) is a feature that connects more than one LAN controller to the same hub, and enhances the throughput by operating packet transmission from the server.

Receive Load Balancing (RLB) is enabled by default. When RLB is enabled, the receive throughput is enhanced.

NEC Express 5800/Fault Tolerant Server Series Duplication Rule

Be sure to set the dual configuration in the server.

Also, when you set the duplex configuration, be sure to use one CPU/IO Module #0 Adapter and one CPU/IO Module #1 Adapter.

e.g.1) Set the dual configuration with the improved endurance using all the adapters.

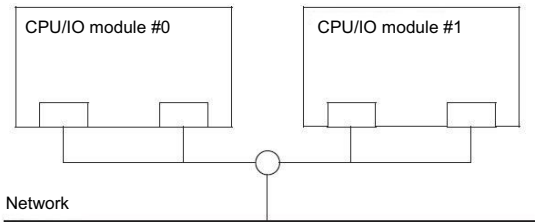

e.g.2) Set the dual configuration for more than one LAN connections

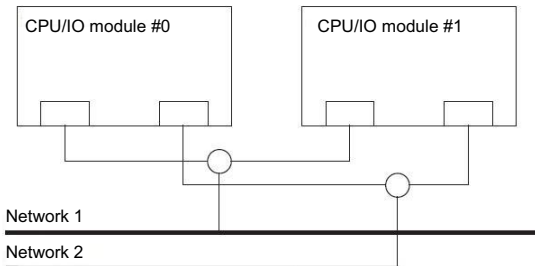

Dual Configuration Setup

The following describes the procedure to set dual LAN configuration.

The procedure to set dual LAN configuration of the example 1 in “NEC Express 5800/Fault Tolerant Server Series Duplication Rule” is explained.

To set dual LAN configuration, log on as "Administrator" or a member of the group "Administrators."

1. Start Device Manager.

2. Select one target network adapter, right-click on it and select [Properties] from the displayed menu to display the Properties window.

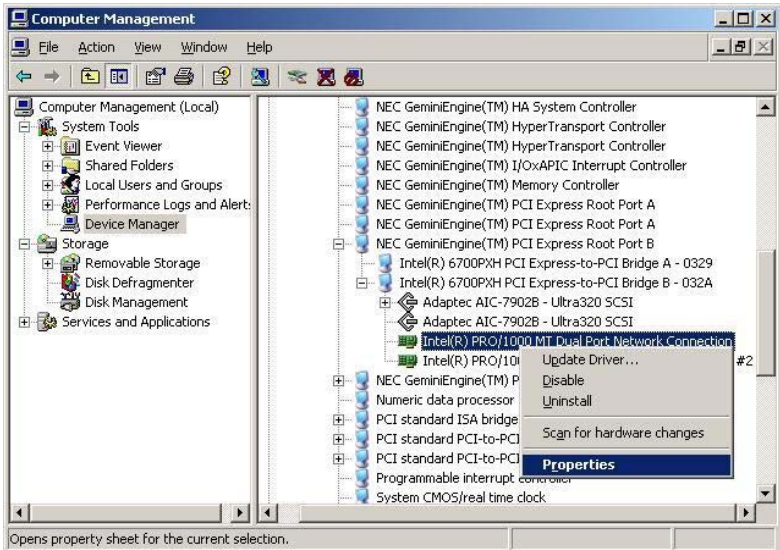

3. Select the [Teaming] tab in the Properties window. Check the radio button of [Team with other adapters] and click [New Team...].

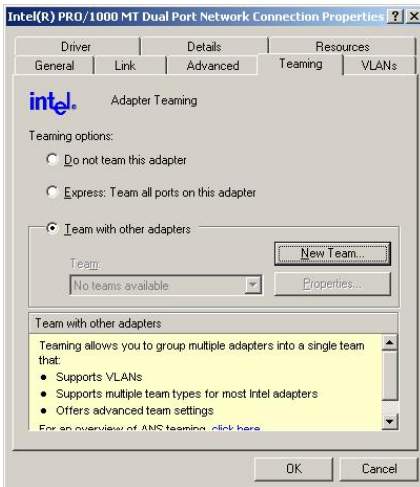

4. Enter the team name, and click [Next >].

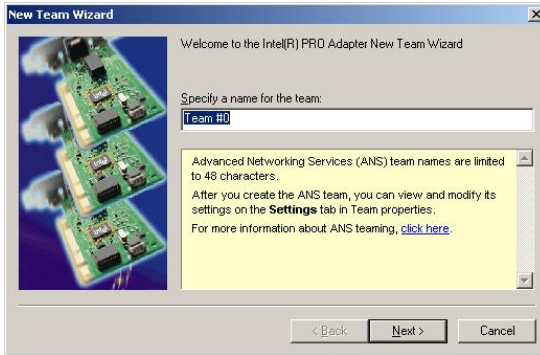

5. Select the check boxes of the adapters you want to include to the team, and click [Next>].

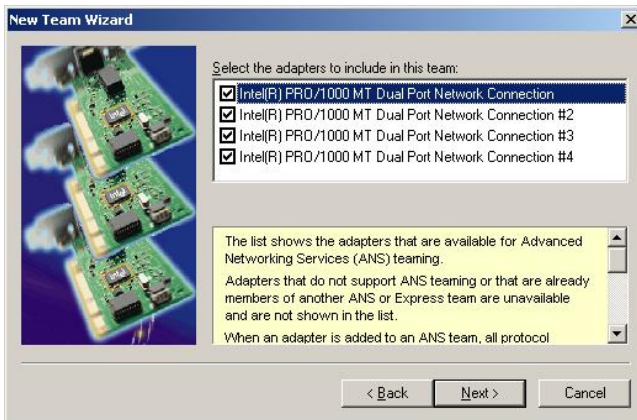

6. Select “Adapter Fault Tolerance” or “Adaptive Load Balancing” as a team mode. (Usually select “Adapter Fault Tolerance.”)

Click [Next >].

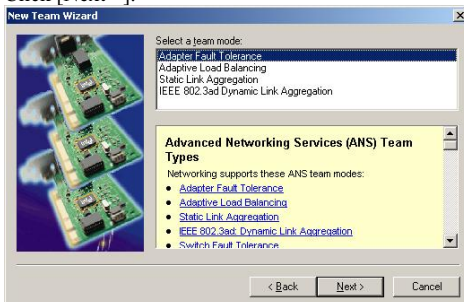

7. Click [Finish].

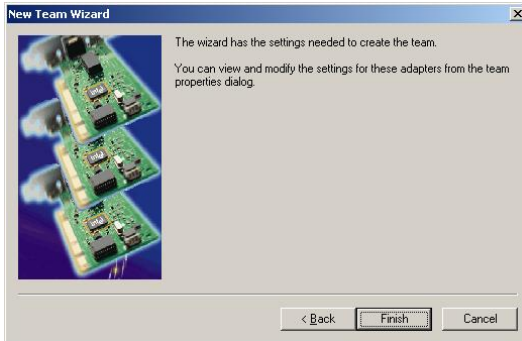

8. Start a command prompt, and confirm the physical MAC address of the team adapter with ipconfig /all.

```
Media State . . . . . : Media disconnected
Description . . . . . : TEAM : Team #0
Physical Address . . . . . : 00-30-13-B8-A1-5C
```

9. Select the team adapter that has been set, right-click on it and select [Properties] from the menu displayed to display the Properties window.

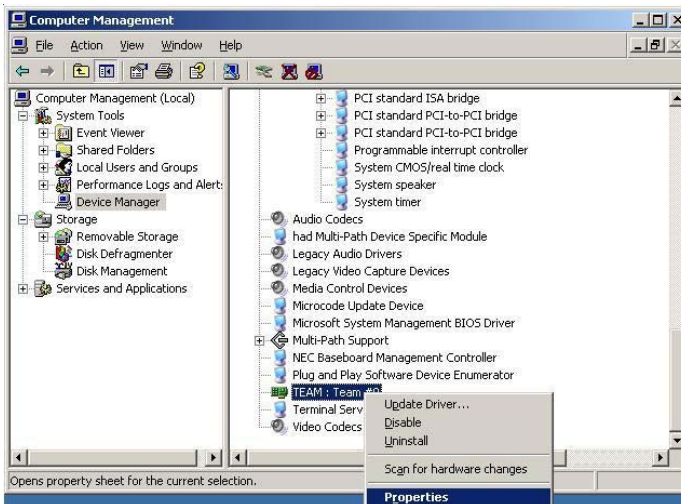

10. Select the [Advanced] tab in the Properties window. Select [Locally Administered Address] from the [Settings] list box, and enter the MAC address of team adapter that you have checked to the [Value:] text box, and click [OK].

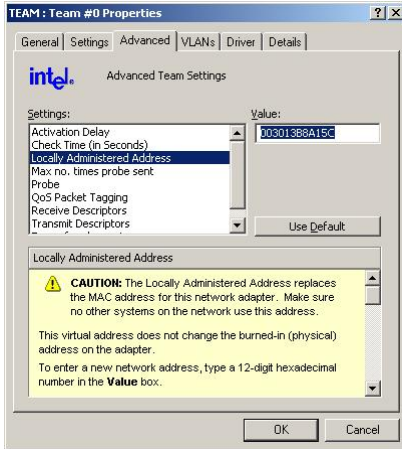

Step 6: Set Dual Disk Configuration

NEC Express5800/ft series secures data by setting dual disk configuration using "Disk Management." Be sure to make dual disk settings by referring to the procedure.

Setting Dual Disk Configuration by Disk Management

IMPORTANT:

- To set dual disk configuration, log on as "Administrator" or a member of the group "Administrators."
- Make sure to mirror the volumes not only when installing an operating system but also when creating partitions.
- After upgrading the volume that contains system partition to dynamic disk, set the hard disk for mirroring to the slot. Do not set the hard disk to the slot before upgrading.
- Set the mirroring for the hard disk with the designated target ID. See "Hard Disk Configurations That Can Be Built On The NEC Express5800/ft series" in the separate volume of User's Guide for details.

1. Click [Start], and then [Control Panel]. When the [Control Panel] screen appears, double-click [Administrative Tools], and then [Computer Management].
2. Click [Disk Management] under the Storage branch of the tree view menu.
3. Display the hard disk drive list in the right frame, right-click the hard disk where the system is installed and click [Convert to Dynamic Disk...].

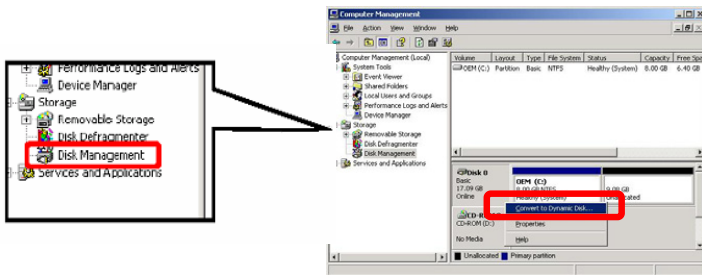

4. Confirm that the hard disk to be converted is the hard disk where the system is installed and click [Convert].

If the selected hard disk contains a system partition, you will have to restart the computer to complete the upgrade of the hard disk. The message also states that file systems on any of the hard disks to be upgraded will be forcedly dismounted. This means if any file systems are in use at the time of upgrade, they will be dismounted, so that the upgrade can continue.

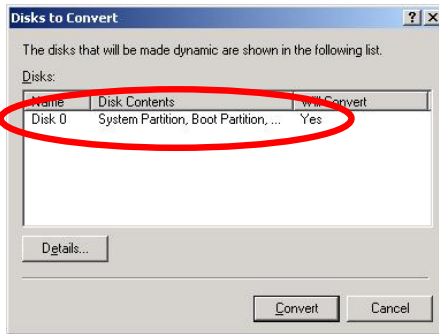

5. After the system has restarted, display [Disk Management] again and set the hard disks for creating mirror volume.

IMPORTANT:

When the hard disk status is “Not Initialized,” right-click that hard disk and initialize it.

If “Foreign” is displayed, perform “Convert to Basic Disk” and then perform “Convert to Dynamic Disk...”

Hard disks to be mirrored must be inserted to the corresponding slots. Make them in pairs (Slot0 and Slot3/ Slot1 and Slot4/ Slot2 and Slot5). For the details, see [DISK OPERATIONS] in the separate User’s Guide.

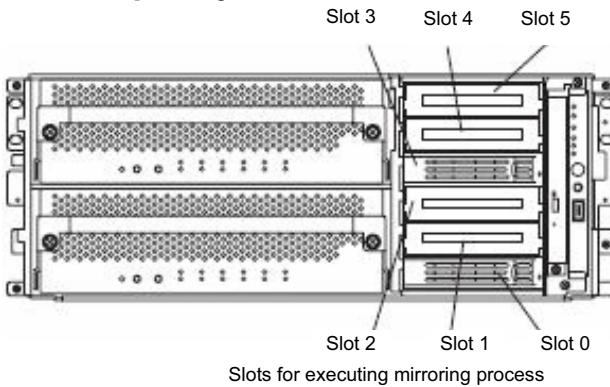

6. If the inserted hard disk is not a dynamic disk, right-click the disk and perform “Convert to Dynamic Disk.”

7. Right-click the dynamic disk volume for creating mirror, and click [Add Mirror...].

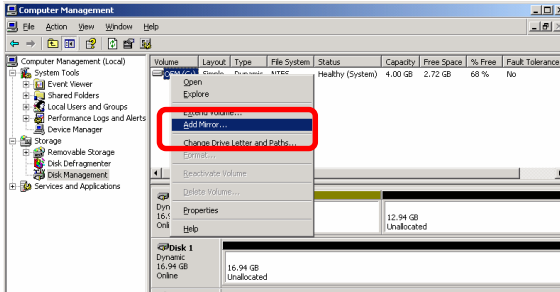

IMPORTANT:

- When you click [Add Mirror...], the [Logical Disk Manager] dialog box will appear. This is not an error. Click [OK].

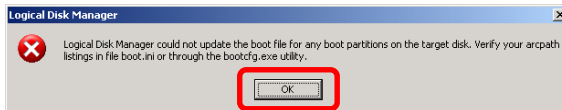

- If you restart the system while creating mirror, mirroring will not be completed. Do not reboot the system until the mirroring process is completed.

TIPS:

Creating mirror takes about 20 minutes for 10GB hard disks.

8. Confirm that the mirroring of the HDD has been started in the Disk Manager.

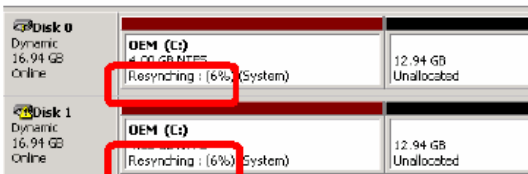

9. When the "Resyncing" shown in 8 changes to "Healthy," disk mirroring has completed.

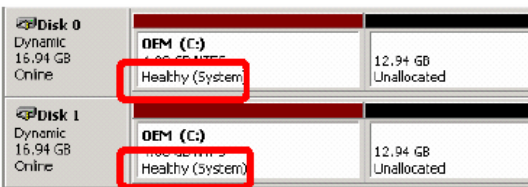

Step 7: Update Software

If you use GeminiEngine Control Software UPDATE CD-ROM, see “Installing GeminiEngine Control Software” (page 6-13) to update the software. When there are other update modules, apply them in this step.

Step 8: Connect and Configure Options

When there are option PCI boards or peripheral devices to connect to the main unit, power off the main unit. Then, for connecting them, follow the instructions in “PCI board” in the separate volume of the User’s Guide and the manual of the devices.

TIPS:

If LAN or hard disks are added, you need to set dual configurations. For details, see “Step 5: Set Dual LAN Configuration” (page 4-23) and “Step 8: Connect and Configure Options” (page 4-32).

When the mounted memory is 4GB or more, specify /PAE switch to BOOT.INI file.

In order to use the entire mounted memory from the Windows system, /PAE switch needs to be specified. If it is not specified, the Windows system only uses a part of the mounted memory.

Refer to Microsoft Product Support Services for details of specification method.

Display BOOT.INI file as described below:

1. Right-click [My Computer] and select “Properties” to display “System Properties.”
2. On the “Advanced” tab of “System Properties,” click the “Settings” button of “Startup and Recovery.”
3. Click the “Edit” button of “System startup” on the displayed window.

Below shows the example of the modification.

(Before modification)

```
[boot loader]
timeout=30
default=multi(0)disk(0)rdisk(0)partition(1)\WINNT
[operating systems]
multi(0)disk(0)rdisk(0)partition(1)\WINNT="Windows Server 2003, Enterprise" /fastdetect
```

(After modification)

```
[boot loader]
timeout=30
default=multi(0)disk(0)rdisk(0)partition(1)\WINNT
[operating systems]
multi(0)disk(0)rdisk(0)partition(1)\WINNT="Windows Server 2003, Enterprise" /fastdetect /PAE
```

Step 9: Create Volume

For NEC Express5800/ft series, you need to create mirrors for all volumes. In case of creating a new volume except for the one that stores the system partition, see “Hard Disk Configurations that can be built on the NEC Express5800/ft series” on the separate User’s Guide.

For how to create or mirror volume, see the Online Help of Windows and “Step 6: Set Dual Disk Configuration” (page 4-29).

IMPROTANT:

The creation of volume is available after the system operation is started.

For creating volume, refer to “Hard Disk Configurations that can be built on the NEC Express5800/ft series” in the separate User’s Guide.

Step 10: Set Network for NEC ESMPRO Agent

NEC ESMPRO Agent is required for continuous operation of the NEC Express5800/ft series. It is automatically installed when installing OS using Express Setup.

To operate NEC ESMPRO Agent, you need to set the SNMP.

To change the settings of the SNMP Service:

1. Double-click [Administrative Tools] in [Control Panel].
2. Open [Services] in [Administrative Tools].
3. Select [SNMP Service] from the service list and then [Properties] in the [Action] menu.
The “SNMP Properties” dialog box appears.
4. Enter “public” in the [Community name] box in the [Traps] property sheet and click the [Add to list] button.

IMPORTANT:

- To change the community name of traps to be received from the default “*” in the NEC ESMPRO Manager site, enter the same name as the community name newly set in the NEC ESMPRO Manager site.
 - To receive trap from NEC ESMPRO Agent at the NEC ESMPRO Manager machine, both community names should be the same.
-

5. Click the [Add...] button in [Trap destinations]. After entering the IP address of the NEC ESMPRO Manager machine of the send destination in the [Host name, IP or IPX address] box, click the [Add] button.

IMPORTANT: If the IP address (or host name) of the remote NEC ESMPRO Manager specified as the trap send destination in the setup of the manager report (TCP/IP), the message warning the duplication appears. The specification of the same NEC ESMPRO Manager causes to be reported doubly.

6. Open the [Security] property sheet and make settings as follows:

- Add the community name entered in 4 to [Accepted community names].
- Set its authority to [READ CREATE] or [READ WRITE].
- Select [Accept SNMP packets from any host].

IMPORTANT:

- If you entered any community name other than “public” in 4, add that name to “Accepted community names.”
 - Unless you set the acceptable community’s authority to “READ CREATE” or “READ WRITE,” you cannot perform monitoring from NEC ESMPRO Manager.
-

< Setup of receiving SNMP packets from specific hosts only >

Select [Accept SNMP packets from these hosts], specify IP addresses of the hosts, IP addresses of the servers to install Agent, and the loop-back address (127.0.0.1).

< Setup of receiving SNMP packets from specific communities only >

Change the name of the community receiving SNMP packets from the default “public” to any name.

IMPORTANT:

- If the community name is changed, the community of NEC ESMPRO Agent is changed and registered by starting from [Control Panel]. To change the community to another and register it, use the [SNMP Community] list box in the [General] tab.
 - To allow NEC ESMPRO Agent to receive SNMP packets sent from NEC ESMPRO Manager, set the send community name in NEC ESMPRO Manager to be the same as that accepted by the SNMP Service in NEC ESMPRO Agent.
-

7. Terminate the network setup.

IMPORTANT:

- If the SNMP service was added to the system after the service pack had been applied at OS installation, apply it again. If not, the SNMP service may not operate properly. This can cause the improper operation of NEC ESMPRO Agent.
 - The SNMP Service is required for operating NEC ESMPRO Agent. If the SNMP Service is deleted after the installation of NEC ESMPRO Agent, install the SNMP Service and then reinstall NEC ESMPRO Agent.
 - Some software products provided by other vendors use the SNMP Service. If the SNMP Service and NEC ESMPRO Agent are installed in the system in which such software as above is installed, it may be impossible to start NEC ESMPRO Agent services. If so, delete the SNMP Service once and install the service again. Then, reinstall NEC ESMPRO Agent and the other vendor’s software.
-

Step 11: Enable Boot Monitoring Function

When necessary for system operation, enable the “Boot Monitoring” setting which has been disabled in “Step 3: Disable Boot Monitoring Function” (page 4-9). Or, see “Step 3: Disable Boot Monitoring Function” (page 4-9) and set appropriate time (default is 10 min.).

Phoenix BIOS Setup Utility	
Advanced	
Monitoring Configuration	Item Specific Help
Option ROM Scan Monitoring: [Disabled] Option ROM Monitoring Time-out: [5] Boot Monitoring: [Enabled] Boot Monitoring Time-out Period: [8] POST Pause Monitoring: [Enabled] POST Pause Monitoring Time-out: [3]	Option ROM Scan Monitoring features
F1 Help ↑↓ Select Item -/+ Change Values F9 Setup Defaults Esc Exit ←→ Select Menu Enter Select → Sub-Menu F10 Save Changes & Exit	

Step 12: Make Settings for Failure Management

Make the following settings beforehand to ensure quick recovery from failure.

Set Memory Dump (Debug Information)

This section explains the setting for collecting memory dump (debug information) in the server.

IMPORTANT: Notes on memory dump

- The maintenance personnel designated by your sales agent are responsible for collecting memory dump. Customers should make settings of memory dump only.
- Sometimes a message indicating a shortage of virtual memory appears at the system startup, when a failure has occurred after making settings described here and you have restarted the system to save the memory dump. Continue the startup. If you restart the system, you may not be able to collect the memory dump accurately.
- If an error such as a stop error of the OS occurs, the normal dump function may run instead of the quick dump function depending on the system status. However, the memory dump file can be used for failure analysis equivalent to that of the quick dump function.

Take the following steps to set memory dump:

1. From the [Start] menu, select [Control Panel] and then click [System].
The [System Properties] dialog box appears.
2. Click the [Advanced] tab.
3. Click [Settings] in the [Startup and Recovery] box.

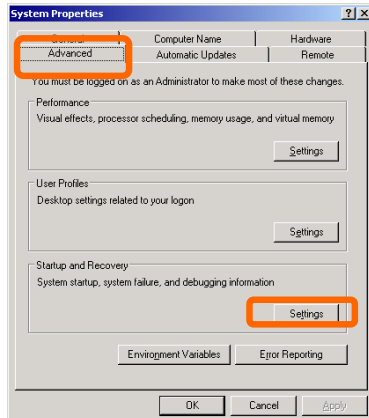

4. Enter the location, where debug information is to be written, in the text box.

When writing debug information under the file name "MEMORY.DMP" in the D drive:

D:\MEMORY.DMP

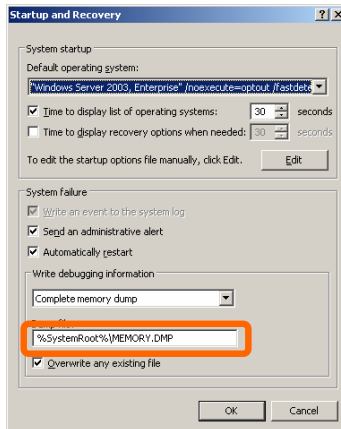

IMPORTANT:

- [Complete memory dump] should be specified for writing debug information. However, if the mounted memory size is over 2GB, specify [Kernel Memory Dump]; you cannot specify [Complete memory dump]. Quick dump function is enabled when specifying the [Complete memory dump]. If you specify the setting other than the [Complete memory dump], the dump function for OS standard works.
- Specify a drive which has a free space of the size of memory in the NEC Express5800/ft series + 12MB or more (If the memory size is over 2GB, 2048MB + 12MB).
- If the memory will be expanded to larger than 2 GB, change Write Debugging Information to [Kernel Memory Dump] before expanding the memory. Size of the debugging information (memory dump) to be collected will change due to memory increase. Check how much free space the hard disk to which debugging information is written has.
- Perform the steps below to change your memory dump setting, if a total memory capacity exceeds 2GB after additional memory has been installed in the system with complete memory dump enabled. If the setting is not changed, incorrect dump files may be collected.
 - 1) Go to [Control Panel], click [System], and then click [Advanced] to open the [Startup and Recovery] dialog box. Choose "Small memory dump" and click [OK].
 - 2) Return the setting to "Kernel memory dump" and click [OK].
- In the system failure settings, it is recommended to specify "Automatically restart." When this option is not selected, the operation cannot be switched to the disks that are mirrored if the system cannot be started due to a disk error.

5. Click [Settings] in the [Performance] box.

The [Performance Options] window appears.

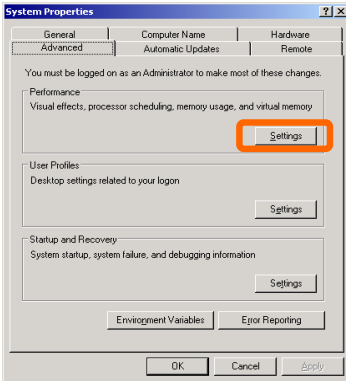

6. Click the [Advanced] tab on the [Performance Options] window.

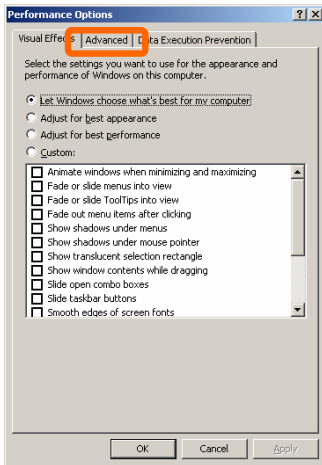

7. Click [Change] in the [Virtual memory] box.

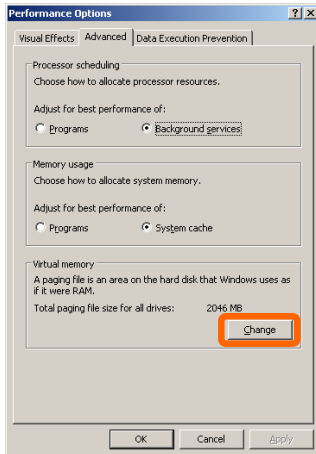

8. Change the value set for [Initial Size] in the [Paging file size for selected drive] box to the [Recommended] value or more, and then click [Set].

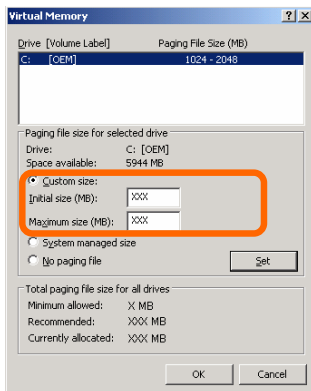

IMPORTANT:

- Be sure to create the file in the size more than [Recommended] value in the OS partition. If a value smaller than the [Recommended] value is set for [Initial Size] of the paging file, accurate debug information (memory dump) may not be collected.
- For the [Recommended] value, see "Size of the Partition to be Created" (page 4-5).
- To be prepared for failure, it is recommended to press the dump button to see if the memory dump can be collected in normally beforehand.
- If the memory has been expanded, re-set the paging file according to the memory size.

9. Click [OK].

A message is displayed asking you to restart the system depending on the changed settings. Restart the system according to the messages.

Set Dr. Watson

Dr. Watson of Windows Server 2003 is a debugger for application errors. When detecting an application error, Dr. Watson diagnoses the NEC Express5800/ft series, and records the diagnostic information (log). Take the following steps to collect diagnostic information:

1. Click [Run...] from [Start].
2. Enter "drwtsn32.exe" in the [Open] box, and click [OK].

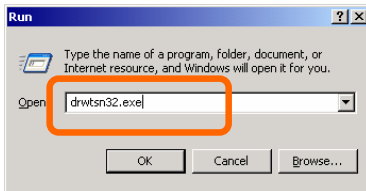

The [Dr. Watson for Windows] dialog box appears.

3. Specify where you want to save diagnostic information in the [Log File Path] box.

Diagnostic information is saved under the file name "DRWTSN32.LOG."

CHECK: Do not specify a network path. Be sure to specify a path on the local computer.

4. Specify the crash dump file save destination in the [Crash Dump] box.

TIPS: A "crash dump file" is a binary file that can be read by Windows Debugger.

5. Select the following check boxes in the [Options] box.

- [Dump Symbol Table]
- [Dump All Thread Contexts]
- [Append To Existing Log File]
- [Create Crash Dump File]

For the above functions, see the online help.

6. Click [OK].

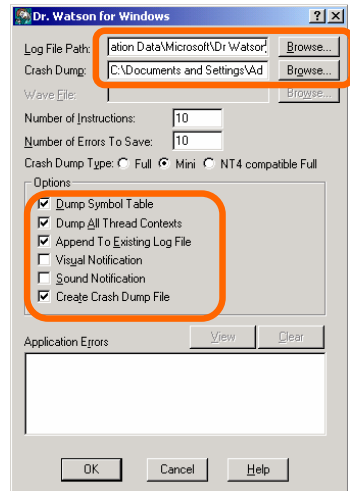

Install a Network Monitor

A network monitor is useful for examining the causes of network failures and taking the countermeasures. To use the network monitor, you need to restart the system after the installation. It is recommended to install the network monitor before a failure occurs.

1. From the [Start] menu, select [Control Panel] and click [Add/Remove Windows Programs].
The [Add/Remove Windows Programs] dialog box appears.
2. Click [Add/Remove Windows Components].
The [Windows Components Wizard] dialog box appears.
3. Select the [Management and Monitoring Tools] [Components] and click [Details...] at the bottom right of the window. [Management and Monitoring Tools] appears.

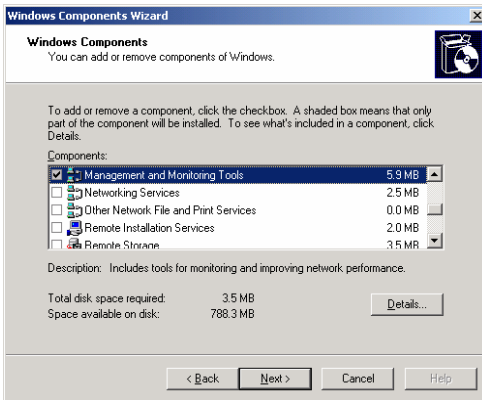

4. Check the [Network Monitor Tools] check box on the [Subcomponents of Management Monitoring Tools] dialog box and click [OK] at the bottom of the window.

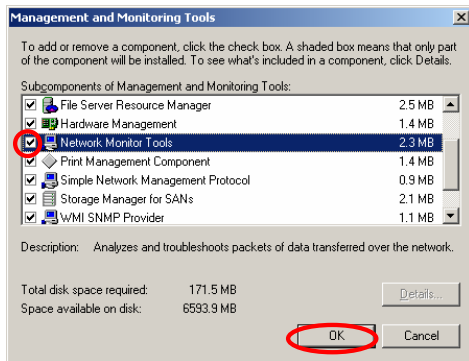

5. Click [Next].

6. If a message is displayed asking you to insert "Windows Server 2003 R2 Enterprise Edition CD-ROM," follow the instructions on the screen.

Close the menu that appears by inserting the CD-ROM. To close the menu, click the [X] mark on the menu.

7. Click [Finish] in the [Windows Components Wizard] dialog box.
8. Click the [X] mark on the [Add or Remove Programs] dialog box.

You can also activate the network monitor by clicking [Start], pointing to [All Programs], pointing to [Administrative Tools] then clicking [Network Monitor]. For details on the operation, see the online help.

Set Recovery Console

TIPS:

Recovery console is used for repairing the system when the system cannot be started for some reason.

There are cautions to be taken for using the Recovery console. Refer to "Cautions for using the Windows Server 2003 Recovery Console" of "SYSTEM REPAIR" in Chapter 6 "Troubleshooting" in the User's Guide (Setup).

Step 13: Back up System Information

After setting up the system, back up the system information using the Off-line Maintenance Utility.

Without backup for system information, the information and settings that are specific to your server cannot be restored if the server is repaired. Take the following steps to make a backup copy of the system information:

1. Get a 3.5-inch floppy disk.
2. Insert the "NEC EXPRESSBUILDER" CD-ROM into the CD-ROM drive of the server, and restart the system.
NEC EXPRESSBUILDER is activated and [NEC EXPRESSBUILDER Top Menu] is displayed.
3. Select [Off-line Maintenance Utility] from [Tools].
4. Select [Save System NVRAM/ROM Data] from [System Information Management].

Follow the instructions you see on the screen.

The setup is now completed.

Chapter 5

Procedures after Completion of Installation

This chapter describes how you install management utilities, how you back up system information, and setup of PCs on the network. You may need to confirm these procedures while the system is running.

INSTALLING MANAGEMENT UTILITIES

The provided "NEC EXPRESSBUILDER" CD-ROM contains "NEC ESMPRO Agent" for monitoring NEC Express5800/ft series and "NEC ESMPRO Manager" for managing the NEC Express5800/ft series. Install and setup these utilities in the NEC Express5800/ft series or the computer (management PC) that manages the NEC Express5800/ft series.

NEC ESMPRO Agent

NEC ESMPRO Agent is automatically installed by executing the "Fault Tolerant Server series setup program."

Click [Start] then [All Programs], and make sure that the installed utility folder exists. If it has not been installed while setting up the Fault Tolerant Server series, install it separately.

IMPORTANT:

Make sure that NEC ESMPRO Agent is installed because it is indispensable for continuous operation of NEC Express5800/ft series.

To set details about NEC ESMPRO Agent, double-click the [NEC ESMPRO Agent] icon in the [Control Panel] dialog box. The properties dialog box appears for changing the settings.

For details on the set items, see the online help displayed by clicking on [Help].

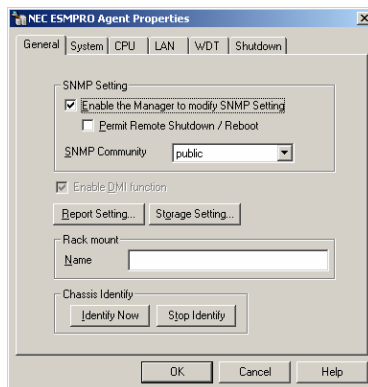
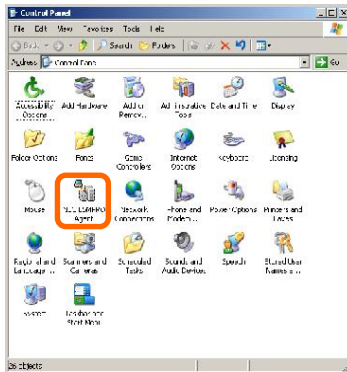

Operation Environment

NEC ESMPRO Agent can be operated in the hardware and software environments shown below.

■ Hardware

- Installation system NEC Express5800/ft series
- Memory Memory capacity required to operate OS + 25.0 MB or larger
- Empty capacity of hard disk 50.0 MB or larger

■ Software Windows Server 2003 SP1

Preparation before Setup

Be sure to read the following description before system installation or setup.

To operate NEC ESMPRO Agent, you need to make settings of TCP/IP and the SNMP of components associated with TCP/IP.

TCP/IP Setting

See the Help started from the Start menu for how to set TCP/IP.

SNMP Service Setting

To install the SNMP Service:

1. Open [Add/Remove Programs] in [Control Panel].
2. Click [Add/Remove Windows Components].
3. Select [Management and Monitoring Tools] in the Windows component wizard and click the [Details...] button.
4. Check the check box of [Simple Network Management Protocol].
5. Click the [Next] button.
The file copy operation is started.
6. After the file copy is finished, click the [Finish] button.

To change the settings of the SNMP Service:

1. Double-click [Administrative Tool] in [Control Panel].
2. Start [Services] in [Administrative Tool].
3. Select [SNMP Service] from the service list and then [Properties] in the [Action] menu.
The "SNMP Properties" dialog box appears.
4. Enter "public" in the [Community name] box in the [Traps] property sheet and click the [Add to list] button.

IMPORTANT:

- To change the community name of traps to be received from the default "*" in the NEC ESMPRO Manager site, enter the same name as the community name newly set in the NEC ESMPRO Manager site.
 - To receive trap from NEC ESMPRO Agent at the NEC ESMPRO Manager machine, both community names should be the same.
-

5. Click the [Add...] button in [Trap destinations]. After entering the IP address of the NEC ESMPRO Manager machine of the send destination in the [Host name, IP or IPX address] box, click the [Add] button.

IMPORTANT:

If the IP address (or host name) of the remote NEC ESMPRO Manager specified as the trap send destination in the setup of the manager report (TCP/IP), the message warning the duplication appears. The specification of the same NEC ESMPRO Manager causes to be reported doubly.

6. Open the [Security] property sheet and make settings as follows;
 - Add the community name entered in Step 4 to [Accepted community names].
 - Set its authority to [READ CREATE] or [READ WRITE].
 - Select [Accept SNMP packets from any host.]

IMPORTANT:

- If you entered any community name other than "public" in Step 4, add that name to "Accepted community names."
 - Unless you set the acceptable community's authority to "READ CREATE" or "READ WRITE," you cannot perform monitoring from NEC ESMPRO Manager.
-

< Setup of receiving SNMP packets from specific hosts only >

Select [Accept SNMP packets from these hosts], specify IP addresses of the hosts, IP addresses of the servers to install Agent, and the loop-back address (127.0.0.1).

< Setup of receiving SNMP packets from specific communities only >

Change the name of the community receiving SNMP packets from the default "public" to any name.

IMPORTANT:

- If the community name is changed, the community of NEC ESMPRO Agent is changed and registered by starting from [Control Panel]. To change the community to another and register it, use the [SNMP Community] list box in the [General] tab.
 - To allow NEC ESMPRO Agent to receive SNMP packets sent from NEC ESMPRO Manager, set the send community name in NEC ESMPRO Manager to be the same as that accepted by the SNMP Service in NEC ESMPRO Agent.
-

7. Terminate the network setup.

IMPORTANT:

- During OS installation, if the SNMP service is added to the system after applying the service package during OS installation, apply it again. If not, the SNMP service may not operate properly, and this can cause the improper operation of NEC ESMPRO Agent.
 - The SNMP Service is required for operating NEC ESMPRO Agent. If the SNMP Service is deleted after the installation of NEC ESMPRO Agent, install the SNMP Service and then reinstall NEC ESMPRO Agent.
 - Some software products provided by other vendors use the SNMP Service. If the SNMP Service and NEC ESMPRO Agent are installed in the system in which such software as above is installed, it may be impossible to start NEC ESMPRO Agent services. If so, delete the SNMP Service once and install the service again. After which, reinstall NEC ESMPRO Agent and the other vendor's software.
-

Installation

NEC ESMPRO Agent is automatically installed together with the installation or re-installation of the NEC Express5800/ft series. NEC ESMPRO Agent may be installed manually on the master control menu of NEC EXPRESSBUILDER as follows:

1. Login to the system with user name "Administrator."
2. Insert CD-ROM "NEC EXPRESSBUILDER" into the CD-ROM drive.

TIPS:

The CD-ROM drive may be either the drive connected to the system or any drive located on the network and connected by the LAN Manager. (These are collectively called CD-ROM drive hereafter).

IMPORTANT:

To use a CD-ROM drive on the network, assign the network driver to the drive and then execute MC\1ST.EXE of the drive. Do not start the CD-ROM drive from the network computer in Windows Explorer.

The autorun function automatically displays the master control menu of NEC EXPRESSBUILDER.

3. Click [NEC ESMPRO] in [Setup].

The NEC ESMPRO setup is started to display the main menu.

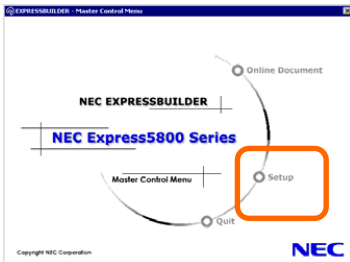

- Click [Agent] in the main menu of the NEC ESMPRO setup.



TIPS:

The available menus vary depending on OS types. (The menus that cannot be installed are displayed gray.)

IMPORTANT:

- Double-clicking to select a menu may display two same dialog boxes. Click the [End] button to close one of the dialog boxes.
 - If you click the [Cancel] button during setup, the message asking whether to stop or not to stop the installation will appear. You can stop the installation by clicking on the [Stop] button (the main menu remains displayed). However, the file having been setup halfway will not be deleted.
 - When NEC ESMPRO Agent is already installed, delete its older version from [Add or Remove Programs] in Control Panel, and install the new version.
-

- The setup program determines the machine type automatically.
-

IMPORTANT:

If the setup program is unable to determine the machine model, the setup of NEC ESMPRO Agent will be stopped.

- Click the [Next] button.

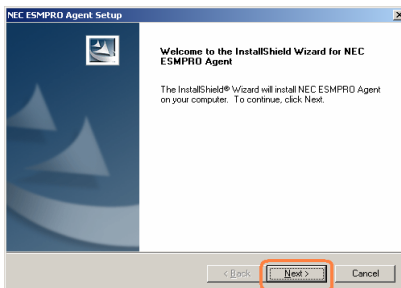

7. Enter the path in which NEC ESMPRO Agent is installed and click the [Next] button.

The NEC ESMPRO Agent module is installed below the ESM directory of the root partition in default. If no problem is found, click the [Next] button without any modification.

To change the installation directory, click the [Reference] button, specify the desired installation directory with the full path including the drive name, and click the [Next] button.

8. When the installation end window appears, click the [OK] button.

The installation is complete. The functions of installed NEC ESMPRO Agent will be enabled after the system is restarted.

IMPORTANT:

- After the installation of NEC ESMPRO Agent, SNMP Service is stopped. The SNMP Services will be started when the OS is restarted.
 - Even if the installation of NEC ESMPRO is completed, the main menu for the NEC ESMPRO setup remains displayed. Note that the main menu may be hidden by another dialog box. To terminate the NEC ESMPRO setup, click [End] in the main menu.
-

Setup of NEC ESMPRO Agent

The settings of installed NEC ESMPRO Agent remain unchanged from those at shipment. Click the [Start] button, [Setting], and [Control Panel] sequentially to open [Control Panel].

If you double-click the [NEC ESMPRO Agent] icon in [Control Panel], the property dialog box will appear. Modify the setting of each sheet in the dialog box to be fit to the used environment. The notes on setup and the necessary information are explained in “Supplement” in Chapter 5 of User’s Guide in the separate volume. See the supplement for setup or suspicion of malfunction.

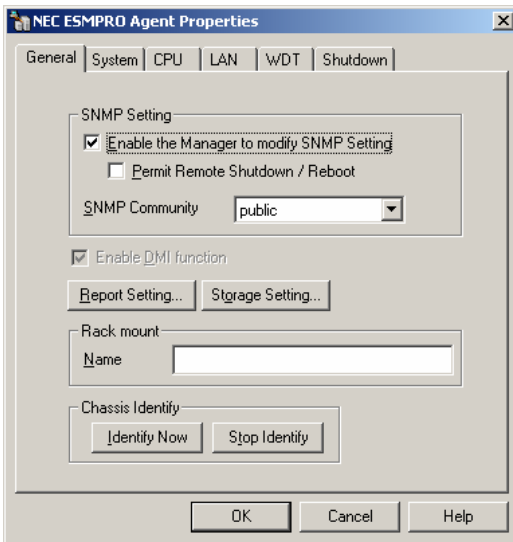

Uninstall

The configuration of NEC ESMPRO Agent and BMC and the uninstallation of BMC FW Update Service are described below.

Uninstallation of NEC ESMPRO Agent

The procedure of uninstalling NEC ESMPRO Agent is described below.

IMPORTANT:

Uninstallation of NEC ESMPRO Agent

- Start the uninstallation of NEC ESMPRO Agent after the system is started completely.
 - If NEC ESMPRO Agent is uninstalled just after the system startup, the setup program may freeze displaying the [Service Being Deleted...] dialog box. Shutdown the system by using "Task Manager" or other operation. Then uninstall NEC ESMPRO Agent after the system is started completely.
 - In the system that operates Windows Server 2003, do not change the setting of "Local security policy" from the default.
The error occurs by InstallShield if the uninstallation is executed with the setting changed, and the uninstallation fails.
-

- With using NEC EXPRESSBUILDER:
 1. Make the main menu of the NEC ESMPRO setup appear by referring to the section "Install" in this document.
 2. Click [NEC ESMPRO Agent].
The "Welcome" dialog box appears.
 3. Select [Delete] and then click the [Next] button.
Now NEC ESMPRO Agent is uninstalled.
- Without using NEC EXPRESSBUILDER:
 1. Start [Add/Remove Programs] in [Control Panel].
 2. Select [NEC ESMPRO Agent] and click [Change/Remove].
The "Welcome" dialog box appears.
 3. Select [Remove] and click [Next].
Now NEC ESMPRO Agent is uninstalled.

NEC ESMPRO Manager

Linked with NEC ESMPRO Agent installed in the server, NEC ESMPRO Manager monitors the server status and receives alerts from the server.

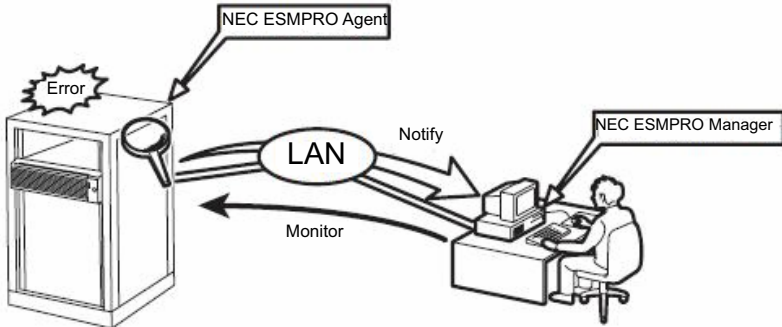

When a failing module in the server is to be replaced, NEC ESMPRO Manager enables logical module disconnection from the server and logical installation after module replacement.

For the installation of NEC ESMPRO Manager and notes on the operation, see the separate volume of the User's Guide.

NEC DianaScope

NEC DianaScope is software to remotely manage the NEC Express5800/ft series. NEC Express5800/ft series can be managed remotely, only when N8815-001/001A ft Remote Management Card (which comes with 320Fb-M and 320Fb-MR models) is installed.

For information on the functions and installation procedures of NEC DianaScope, refer to the online documents.

CONFIRMATION OF THE GeminiEngine Control Software VERSION

The following describes how to check the version of GeminiEngine Control Software, which consists of various types of software for fault tolerance. Perform the procedure when you need to check the GeminiEngine Control Software version of the current system before adding units or attachment to NEC Express5800/ft series.

Confirm the version following the steps below:

1. Log in the system as an authorized Administrator.
2. Open Control Panel from the Start menu.
3. Open “Add or Remove Programs.”

You can confirm the version that corresponds to the name of [GeminiEngine Control Software].

CAUTIONS FOR APPLYING Windows Service Pack

Do not use your own judgment and apply the Windows Service Pack to the NEC Express5800/ft series.

IMPORTANT:

If you desire to apply service packs, contact your sales agent about the application status, and apply service packs to NEC Express5800/ft series.

CHANGING THE COLOR QUALITY OF DISPLAY TO 32 BIT

The default color quality of the graphics driver is set to 16 bits for the NEC Express5800/ft series.

The server rarely displays the following message when accessing a floppy disk and becomes unable to access the floppy disk. The default color quality is 16 bit to prevent that from happening.

The volume does not contain a recognized file system. Please make sure that all required file system drivers are loaded and that the volume is not corrupted.

Even if this message is displayed and the server becomes unable to access the floppy disk, the processing completes by accessing the floppy disk again.

If you need to change the color quality to 32 bit knowing this limitation, apply a special graphic driver as described below:

- (1) Log on to Windows Server 2003 as a user with administrator authority.
- (2) Set the “NEC EXPRESSBUILDER” CD into the CD-ROM drive.
- (3) From the Start menu, select [Run...].
- (4) Enter “D:\HAS\W2K3\GA32SET.BAT” in the “Open” box (replace “D” with the drive letter of the CD-ROM drive), and click [OK].

Then, restart the server.

To change the color quality to the standard (16 bit), perform the above steps but run “GA16SET.BAT” in (4) instead of “GA32SET.BAT.”

COMPRESSING A SYSTEM DRIVE

Do not compress the root directory and the Windows directory when compressing the System Drive. (The Windows Server 2003 directory is labeled as “Windows.”) If you compress the root directory and the Windows directory, operational stability cannot be ensured because the Windows File Protection (WFP) may replace an unassigned driver with a signed driver.

ABOUT Windows Update (APPLYING SECURITY PATCHES)

Before updating Windows modules by using the Windows Update function on NEC Express5800/ft series, make sure to read the description of each module. Contact NEC sales agent for information about the test status of security patch and QFE on NEC Express5800/ft series. It is strongly recommended to contact NEC sales agent when updating the operating system on NEC Express5800/ft series.

- Under a support policy for security patches and QFE on NEC Express5800/ft series, security patches released by Microsoft are categorized into the following levels according to their importance:
- **IMPORTANT Patches (Considered as IMPORTANT by NEC and requires immediate application):** Tests will be performed upon publication of new patches and the results will be informed to NEC sales agents. The high-risk viruses (such as Nimba worm as a past example) will be immediately tested.
 - **Security Rollup Package (SRP):** Tests will be performed along with the publications of SRP and the results will be informed to NEC sales agents.
 - **Other patches:** Tests for the security patches regarding the standard functions of Windows Operating System will be periodically performed, and the results will be informed to NEC sales agents.

Contact NEC sales company if you have any questions or concerns regarding Windows Update.

(This page is intentionally left blank.)

Chapter 6

Troubleshooting

This chapter describes what to do when files needed to operate the OS are damaged and any trouble occurs on the product.

SYSTEM REPAIR

If the system cannot be operated by some reason, use Recovery Console to restore the system. However, this method is only recommended to users or administrators who have good knowledge of the system.

When you have restored a damaged file by using Recovery Console, always update the system as described later in this chapter.

IMPORTANT:

If hard disks cannot be recognized, the system cannot be repaired.

Cautions for using the Windows Server 2003 Recovery Console

For using the Recovery Console in a system where the system disk is a dynamic disk, the following settings need to be configured beforehand.

If these settings are not done, files on the hard disk cannot be updated on the Recovery Console, and the message “Access is denied” appears.

1. “Local Security Policy” setting

IMPORTANT:

This setting should be made on the Windows Server 2003 in advance.

- (a) Start Windows Server 2003, and log on as a user with the administrator authority.
- (b) From the Start menu, select [Administrative Tools] and select [Local Security Policy].
- (c) Select [Local Policies] and then select [Security Options] in the left pane of the [Local Security Settings] window.
- (d) Double-click [Recovery console: Allow floppy copy and access to all drives and all folders] in the right pane, and enable the Security Setting.

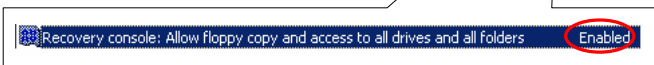
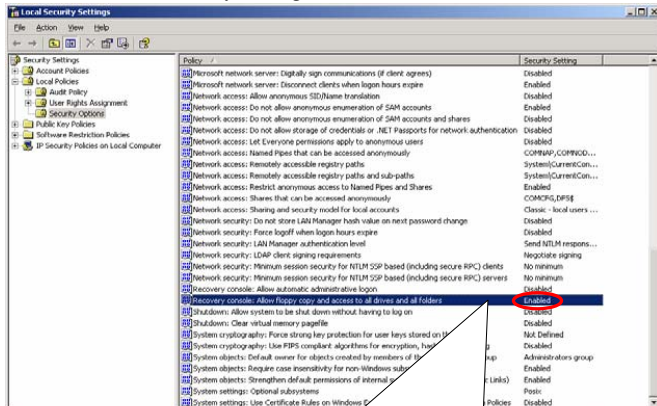

2. Environment variable “AllowRemovableMedia” setting

IMPORTANT:

This setting is made on the Windows Server 2003 Recovery Console when the Windows Server 2003 Recovery Console is in use. This should be set every time when the Recovery Console is started.

- (a) Start the Windows Server 2003 Recovery Console.
For how to start the Recovery Console, see “Preparation” (page 6-4) and “Starting up Recovery Console” (page 6-5).
- (b) Log on to the Recovery Console, and execute the following command.
(The default is FALSE)
set AllowRemovableMedia = TRUE

IMPORTANT:

- The dynamic disk can be written from the Windows Server 2003 Recovery Console after the setting shown above is made.
- As the default, the Windows Server 2003 Recovery Console is not allowed to write data from the basic/dynamic disk to a floppy disk. However, after the setting shown above is made, a floppy disk can be written (copy, access).

Default setting:

Write (copy, access)		Basic disk	Dynamic disk
Copy From	Copy To access destination		
HDD	HDD →	Copy available	Copy not available
FD	HDD →	Copy available	Copy not available
CD	HDD →	Copy available	Copy not available
CD	FD →	Copy not available	Copy not available
HDD	FD →	Copy not available	Copy not available



After the setting:

Write (copy, access)		Basic disk	Dynamic disk
Copy From	Copy To access destination		
HDD	HDD →	Copy available	Copy available
FD	HDD →	Copy available	Copy available
CD	HDD →	Copy available	Copy available
CD	FD →	Copy available	Copy available
HDD	FD →	Copy available	Copy available

Note: HDD : Hard disk (SystemDrive, SystemRoot only)
FD : Floppy disk
CD : CD-ROM

Preparation

You need a support disk, “Windows Server 2003 OEM-DISK for NEC EXPRESSBUILDER” to start up the Recovery Console. Have “Windows Server 2003 OEM-DISK for NEC EXPRESSBUILDER” ready before starting the Recovery Console.

If you do not have a computer that runs Windows Server 2003 or Windows 2000/XP/NT.

Follow the steps below to create a “Windows Server 2003 OEM-DISK for NEC EXPRESSBUILDER”:

1. Prepare a 3.5-inch floppy disk.
2. Power on the peripherals and then NEC Express5800/ft series.
3. Disable the configuration for boot monitoring function.

In the BIOS setup, select [Server] - [Monitoring Configuration] - [Boot Monitoring] and choose “Disabled.” See “Step 3: Disable Boot Monitoring Function” (page 4-9) for details.

4. Insert the NEC EXPRESSBUILDER CD-ROM into the drive of the server.
5. Then, reset (pressing **Ctrl + Alt + Delete**) or power off/on NEC Express5800/ft series to reboot it.

The system will start up from the CD-ROM to start NEC EXPRESSBUILDER.

6. From the [Tools] menu, select [Create Support Disk].
7. From the [Create Support Disk] menu, select [Windows Server 2003 OEM-DISK for NEC EXPRESSBUILDER].
8. Follow the instructions on the screen to insert the floppy disk.

“Windows Server 2003 OEM-DISK for NEC EXPRESSBUILDER” will be created on the floppy disk. Write-protect and place a label on the disk and keep it in a safe place.

IMPORTANT:

Enable the configuration for boot monitoring function to deploy the system without performing the system repair which uses the Recovery Console. In the BIOS setup, select [Server] - [Monitoring Configuration] - [Boot Monitoring] and set appropriate time. See “Step 11: Enable Boot Monitoring Function” (page 4-35) for details.

If you have a computer that runs Windows Server 2003 or Windows 2000/XP/NT.

You can also create a “Windows Server 2003 OEM-DISK for NEC EXPRESSBUILDER” by the steps below:

1. Prepare a 3.5-inch floppy disk.
2. Insert the NEC EXPRESSBUILDER CD-ROM into the drive of a computer that runs Windows Server 2003 or Windows 2000/XP/NT.
3. From [Setup], select [Make OEM-Disk].
4. Follow the instructions on the screen to insert the floppy disk.
 “Windows Server 2003 OEM-DISK for NEC EXPRESSBUILDER” will be created on the floppy disk. Write-protect and place a label on the disk and keep it in a safe place.

Starting up Recovery Console

You can start up Recovery Console in two ways:

- Start up Recovery Console installed on the system.
- Start up Recovery Console from the Windows Server 2003 CD-ROM.

■ Installing Recovery Console on the system

1. Start up the NEC Express5800/ft series and log on to Windows Server 2003.
2. Insert the Windows Server 2003 CD-ROM into the drive.
3. From [Start] of the taskbar, select [Run...] to run.
 CD-ROM drive:\i386\winnt32.exe /cmdcons /syspart:c: /tempdrive:c:
4. Follow the messages that appear on the screen to continue.

■ Starting up the Recovery Console

1. Disable the configuration for boot monitoring function.
 Select [Server] - [Monitoring Configuration] - [Boot Monitoring] and choose “Disabled.”
 See “Step 3: Disable Boot Monitoring Function” (page 4-9) for details.
2. Power on the system.

<When starting up Recovery Console installed on the system>

- (a) Select Microsoft Windows Recovery Console in “Please select the operating system to start:”

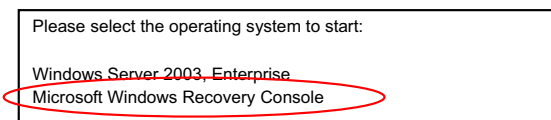

- (b) When the following message appears on the screen press **F6** quickly.

Starting Windows Recovery Console...
Press F6 if you need to install a third party SCSI or RAID driver...

<When starting Recovery Console from Windows Server 2003 CD-ROM>

- (a) Insert the Windows Server 2003 CD-ROM into the drive.
- (b) When the CD is set, reset the system (press **Ctrl + Alt + Delete**) or press the power switch to power off and on to reboot the NEC Express5800/Fault Tolerant server series.
- (c) When the following message appears, press any key to start up from the CD-ROM.

Press any key to boot from CD

IMPORTANT:

Press any key while the message is displayed. Otherwise the system will be started up from a hard disk and Recovery Console will not be started.

- (d) When the following message appears on the screen, press **F6** quickly.

Press F6 if you need to install a third party SCSI or RAID driver...

- 3. When the screen to select SCSI drivers appears, follow the steps below.

- (a) When the following screen is displayed, press the **S** key.

Setup could not determine the type of one or more mass storage devices installed in your system, or you have chosen to manually specify an adapter. Currently, Setup will load support for the following mass storage device(s):

<none>

- * To specify additional SCSI adapters, CD-ROM drives, or special disk controllers for use with Windows, including those for which you have a device support disks from a mass storage device manufacturer, press S.
- * If you do not have any device support disks from a mass storage device manufacturer, or do not want to specify additional mass storage devices for use with Windows, press ENTER.

- (b) Insert the “Windows Server 2003 OEM-DISK for NEC EXPRESSBUILDER” into the floppy disk drive, and then press **Enter**.

Please insert the disk labeled
 Manufacture-supplied hardware support disk
 into Drive A:
 * Press ENTER when ready.

- (c) Select all SCSI adapter list in the floppy disk and then press **Enter**.
 [Adaptec Ultra320 SCSI Cards (Win XP/Server 2003 IA-32)]

- (d) When the following screen appears, press the **S** key.

The driver you provided seems to be newer than the Windows default driver.
 Windows already has a driver that you can use for
 "Adaptec Ultra320 SCSI Cards (Win XP/Server 2003 IA-32)".
 Unless the device manufacturer prefers that you use the driver on the floppy
 disk, you should use the driver in Windows.

- (e) When the following screen appears, remove the floppy disk from the floppy disk drive
 and press the **Enter** key.

Setup will load support for the following mass storage device(s):
 Adaptec Ultra320 SCSI Cards (Win XP/Server 2003 IA-32)

Continue the operations by following the messages.

4. When you start up Recovery Console from Windows Server 2003 CD-ROM, the following
 message appears. Press the **R** key to boot Recovery Console.

Welcome to Setup.
 This portion of the Setup program prepares Microsoft(R)
 Windows(R) to run on your computer.
 - To set up Windows now, press ENTER.
 - To repair a Windows installation using
 Recovery Console, press R.
 - To quit Setup without installing Windows, press F3.

IMPORTANT:

- The message shown above does not appear when you have started up the
 Recovery Console installed on the system.
-

5. Follow the messages on the screen to start up the Recovery Console.

IMPORTANT:

- When you restored a damaged file using the Recovery Console, update the system described in the next section.
 - If you run the system without restoring files, enable the configuration for boot monitoring function. When necessary for system operation, select [Server] - [Monitoring Configuration] - [Boot Monitoring] and set appropriate time. See “Step 11: Enable Boot Monitoring Function” (page 4-35) for details.
 - To write data to a dynamic disk, settings described in “Cautions for using the Windows Recovery Console” in “System Repair” need to be configured in advance. For details, see “Cautions for using the Windows Recovery Console” in “System Repair.”
-

Updating the System

IMPORTANT:

NEC Express5800/ft series is a precision instrument. You should ask maintenance personnel to update the system.

You will need to update the system after you repair the system using Recovery Console.

IMPORTANT:

- Make sure to follow the steps below when you have restored the system by using Recovery Console.
 - Check the configuration for boot monitoring function.
If [Boot Monitoring] selected in [Monitoring Configuration] of [Server] is not set to “Disabled”, disable it. See “Step 3: Disable Boot Monitoring Function” (page 4-9) for details.
 - When updating the system, considerations on settings of Power and Screen Saver are required. If the following settings are enabled when updating the system, the process may stop or the system update may not be applied properly. Disable the settings by clearing the checkboxes before updating the system. Reconfigure the following settings as necessary afterwards.
 - Settings of Screen Saver
 - Power Schemes (Turn off monitor, Turn off hard disks)
 - Hibernation (enable Hibernation)
-

1. Log on to the system with OS installed as user with Administrative account.
-

IMPORTANT:

Check that the dual system is configured properly (Confirm that the FT STATUS LED on the front panel of the server illuminates green. See page 4-7 for location of the STATUS LED).

2. Remove duplications of all the LANs for both onboard and option boards.

When dual LAN is disabled, a setup of LAN will be deleted. Note down the setup information.

- (a) Start Device Manager.
- (b) Select the team adapter that you want to cancel duplication, and select [Properties] from the menu displayed by right-click, to display the Properties window.

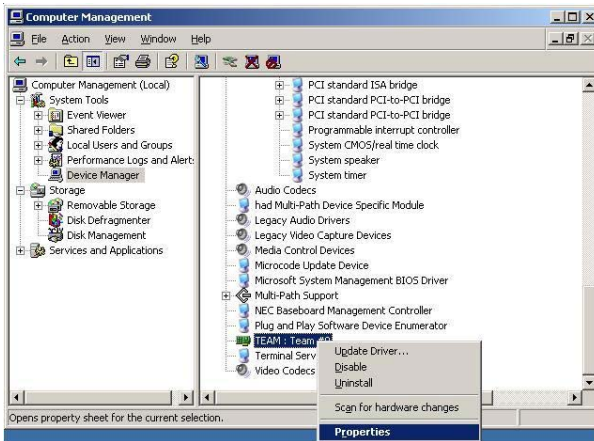

- (c) Select the [Settings] tab in the Properties window, and click [Remove Team].

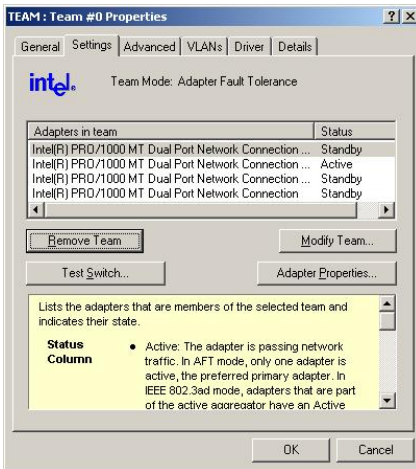

- (d) The confirmation dialog will be displayed. Click [Yes].

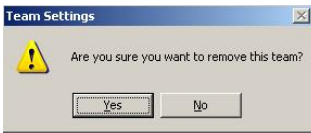

- 3. Follow the steps below to update the system.

Do not input or output data during the update process.

- a) After logging on to the system as a user with the Administrative account, insert NEC EXPRESSBUILDER CD-ROM into the drive of the server.
- b) When the "Master Control Menu" screen appears, click [Setup] and click [Update NEC Express5800 system] on the menu.

- 4. When the dialog box for confirmation of executing system update appears, click [OK].

The system update will start.

Follow the instructions.

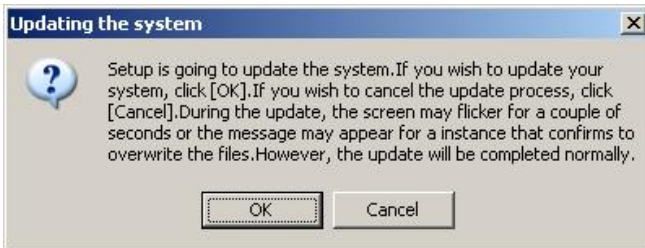

- 5. After the system update is completed, the dialog box below will be displayed. Click [OK].

The system will be rebooted. Eject a CD from CD-ROM drive after the reboot process starts.



IMPORTANT:

If the message, "Windows - FT Orphaning A disk that is part of a fault-tolerant volume can no longer be accessed" is displayed during the update process, an OS stop error may occur when restarting the OS. If an OS stop error occurs, Hold down the POWER switch, and turn off the system. In this case, the system will be successfully updated, however, disk mirroring is disabled. Make sure to check disk mirroring in 8.

When "Found New Hardware" wizard appears at the reboot, click [Cancel]. If the

same message appears again, click [Cancel] again.

6. Reinstall GeminiEngine Control Software.

Reinstall GeminiEngine Control Software referring to “Installing GeminiEngine Control Software” (page 6-13).

7. Check disk mirroring.

If the disk mirroring is disabled, enable the mirroring again. For the method to check disk mirroring, see “Step 6: Set Dual Disk Configuration.”

IMPORTANT:

- During disk re-synchronization, do not shut down the system until the resynchronization is completed.
- If the following dialog appears, confirm that the disk is mirrored and click [Yes] to restart the system.

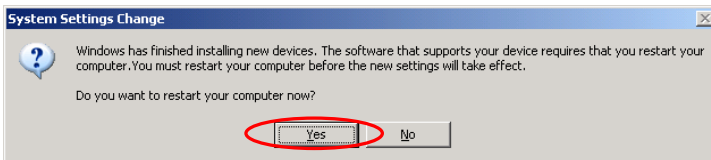

8. Reboot the system.

9. After the system has rebooted, log on as a user with Administrative account.

IMPORTANT:

Check that the dual system is configured properly (confirm that the FT STATUS LED on the front panel of the server illuminates green. See page 4-7 for location of the STATUS LED).

10. Duplicate the LAN again for both onboard and option boards.

Refer to “Step 5: Set Dual LAN Configuration” on page 4-23 or “DUAL LAN CONFIGURATION” in Chapter 3 of the separate volume of User’s Guide. Reconfigure the LAN based on the memo you have taken.

11. When it is necessary for the system operation, enable [Boot Monitoring] selected in [Monitoring Configuration] of [Server]. See “Step 11: Enable Boot Monitoring Function” on page 4-35 for details.

Installing GeminiEngine Control Software

Install GeminiEngine Control Software.

IMPORTANT:

- Terminate all programs before starting the installation. You must terminate all programs because the software will not be installed successfully, especially when Microsoft management console is running.
 - The LAN settings will be deleted by the installation. Write down the setting information for making the settings after the installation as necessary.
 - The dual configuration of LAN needs to be removed before starting the installation. If it is still set, remove the setting.
-

1. Follow the steps below to install GeminiEngine Control Software.
 - a) After logging on to the system as a user with the Administrative account, insert the “NEC EXPRESSBUILDER” CD-ROM into the CD-ROM drive of the server.
 - b) When the “Master Control Menu” screen appears, click [Setup] and select [GeminiEngine Control Software] on the menu.

Follow the instructions to with the installation. The message “GeminiEngine Control Software, Now Installing... Please Wait.” is displayed while GeminiEngine Control Software. Do not use the keyboard or mouse while this message is being displayed.

2. The system is rebooted during the installation.

The system is rebooted several times during the installation. Remove the CD from the CD-ROM drive once rebooting is started.

After the system is rebooted, log in again as the user logged in before rebooting. Installation of the GeminiEngine Control Software is continued.

3. The message “Installation finished.” is displayed.

Once installation is completed, the message “Installation finished.” is displayed and the rebooting starts.

For using “GeminiEngine Control Software UPDATE CD-ROM” to update GeminiEngine Control Software:

After installing the GeminiEngine Control Software, follow the procedure on the setup card attached to the “GeminiEngine Control Software UPDATE CD-ROM” and apply the update.

TROUBLESHOOTING

This section describes what you should do when a trouble occurs in the product.

Problems with NEC EXPRESSBUILDER

When the NEC Express5800/ft series is not booted from the NEC EXPRESSBUILDER CD-ROM, check the following:

- Did you set the NEC EXPRESSBUILDER CD-ROM during POST and restart the server?
 - If you do not set the NEC EXPRESSBUILDER CD-ROM during POST and restart the server, an error message will appear or the OS will boot.
- Is BIOS configuration correct?
 - The boot device order may be specified with the BIOS setup utility of the server. Use the BIOS setup utility to change the boot device order to boot the system from the CD-ROM drive first.
 - <Menu to check: [Boot]>

When an error occurs while the NEC EXPRESSBUILDER is in progress, the following message appears. After this message appears, check the error and take the appropriate corrective action according to the error codes listed in the table below.

Message	Cause and Remedy
This machine is not supported.	This NEC EXPRESSBUILDER version is not designed for this server. Execute the NEC EXPRESSBUILDER on the compliant server.
NvRAM access error	An access to the nonvolatile memory (NvRAM) is not acceptable.
Hard disk access error	The hard disk is not connected or it is failed. Check whether the hard disk is correctly connected.
Any device specific information does not exist on the mother board. Use [System Information Management] of 'Off-line Maintenance Utility' and list the backup information, or write the information. This operation should be executed only by maintenance personnel. Do you want to start the off-line maintenance utility?	This is displayed, if NEC EXPRESSBUILDER can not detect the device specific information, when changing a motherboard, etc. Maintenance personnel should use the off-line maintenance utility and write the information.

An error message will also be displayed when an error was detected during system diagnosis. Take a note or print the error message displayed, and contact your sales agent.

Problems with Windows Setup

The following message is displayed when the setup starts.

```
The specified disk is not found. Terminating SW
```

- The disk to install the system is not connected properly. Check if the hardware is properly installed and connected.

The following message is displayed while copying files from CD-ROM.

```
xxxxx : Not Ready xxxxxxxxxxxxxxxxxxxxxxxZ
xxxxxx(A), xxxxxx(R), xxxxxx(F)
```

- Press **R**. If this message still appears, perform the setup again. If the error persists, contact your sales agent to examine the CD-ROM drive.

Failed to setup in detail for network adapter.

- The detailed setup of network adapter is not available in setup of NEC Express5800/ft series. Open the control panel after starting Windows Server 2003 to configure the network adapter.

Failed to install Windows Server 2003 correctly.

- Have you checked instructions and information on installation?
 - See “Step 1: Things Required for Setup” (page 4-4) and “Step 2: Prepare for Express Setup” (page 4-6).

Rebooted during the setup.

- See “Step 3: Disable Boot Monitoring Function” (page 4-9), and set the parameter of this machine’s boot monitoring function to correct value.

GeminiEngine Control Software UPDATE CD-ROM is not included.

- GeminiEngine Control Software UPDATE CD-ROM is used to update GeminiEngine Control Software; it may not be shipped with the equipment. (Not included if “NEC EXPRESSBUILDER” CD-ROM contains the latest version of software programs at the time of shipment). For the latest release of GeminiEngine Control Software and purchase of the latest version of its GeminiEngine Control Software UPDATE CD-ROM, contact your sales agent.

During a setup, “Previous Operating System C:” was selected on a selection screen of the operating system.

- The process will be stopped along the display of DOS prompt or black screen. In this case, press **Ctrl + Alt + Delete**, or turn off the power to reboot the system. Installation will be continued after a reboot.

Windows can be operated after a setup but each module or PCI board is not duplicated. (FT Status LED does not light on green).

- Did you abort the installation during a setup such as by closing a window of the programs that are running?
 - Installation will be aborted if you finish the programs that are running such as by closing a window. Although the operation on Windows will be feasible, PCI boards will not be duplicated properly if you abort the installation. In this case, “Step 1: Things Required for Setup” needs to be done from the beginning.

DISK Access LED will be lit in amber.

- Did you properly setup the duplex of HDDs?
 - DISK Access LED will be lit in amber, if a setup for duplex is not performed. (See “LEDs” in the separate volume of the User’s Guide for details about the indication status of LED.) See “Step 6: Set Dual Disk Configuration” and set up the duplex of HDDs.

“Complete memory dump” cannot be specified to the write debug information on “Set Memory Dump” (Debug Information).

- “Complete memory dump” cannot be specified (not displayed) if the memory size exceeds 2GB. Specify “Kernel memory dump” in this case.

Cannot find the recommended value for a paging file.

- See “Size of the Partition to be Created” in “Step 1: Things Required for Setup.”

Cannot specify a network path for the storage location of diagnosis information (collect log) in “Set Dr. Watson.”

- You cannot specify a network path. Specify a path to a local computer.

The Telnet Service is not installed.

- Adjust the computer name to 14 characters or less, and then install the Telnet Service according to <How to install the Telnet Service>.
<How to install the Telnet Service>
 1. Select [Run] from the Start menu.
 2. Type “tlntsvr /service” in the [Open] box, and click [OK].
 3. From the Start menu, point to [Control Panel] and click [Administrative Tools] and then click [Services] to specify whether the Telnet Service is registered.

Note: Once the installation of Telnet Service is finished, you may change the computer name to 15 or more characters.

About the Express Setup

The following message appeared when installation has been attempted by using a hard disk drive whose size is smaller than the specified partition size:

The specified partition size has exceeded the capacity of the hard disk. The setup created the partition at the maximum size that can be reserved on the hard disk. Setup will continue the process.

OK

- The message does not mean there is a problem. Press the **Enter** key to continue the installation.

The screen did not show image correctly while files were copied from the CD-ROM or the CD-ROM was being checked.

- Press the **R** key. If the problem persists after you have press the **R** key for several times, start the Express Setup from the beginning again. If you still see the same result, contact your service agent to check the CD-ROM drive.

Automatic installation halted asking you to enter the setup information.

- The setup information you have configured is not correct. Enter correct values according to the message instructions. You do not need to cancel the installation. You may be required to press the **Enter** key again at the reboot at the end of a setup in Windows.

[OK] appears on the [Role of Computer] window.

- When you click [OK], in the rest of procedures, the default values of the Express Setup are automatically selected for the installation.

<Default values>

Network protocol settings

Protocol: TCP/IP [DHCP specified]

Service: Selecting sharing files for Microsoft network and printer

Client: client for Microsoft networks

Component: SNMP

Application: NEC ESMPRO Agent

[OK] does not appear on the [Role of Computer] window.

- [OK] does not appear if the setup information file that has been created is loaded.
- [OK] appears only when you have moved to the [Role of Computer] window. Once you have moved to the next window from the [Role of Computer] window, [OK] does not appear even if you use [Back].

Entire disk area is used as the OS area though “Use Existing Partition” has been selected for “System Partition.”

- Was there any partition other than the partition to be reused (except the maintenance area)?
 - If there was no area other than the partition to be reused, the entire area is reserved for Windows installation.

The settings for joining a domain was made, but the server was installed as a member of a workgroup.

- Workgroup settings are made in the installation. Join a domain after the OS is started.
- Did you use any double-byte characters in the host name?
 - If you use any double-byte character in a host name on Windows Server 2003, joining a domain will fail. If you have failed joining a domain, select [System] from Control Panel to make settings to join a domain.

Though a large value was specified for the partition size, it turned out when Windows started that the system partition created was 4095MB.

- Did you specify a value larger than the actual size of the area in the [Partition Size]?
 - If you want one partition for the entire area (except the maintenance area), select [All Area].

The cluster size is set to 512 bytes in the installation though installation was done on a partition whose size is 2GB or greater by NTFS.

- This is the specification of the Express Setup. If you want to perform installation with a cluster size other than 512 bytes, perform the manual setup.

Windows started up with a different resolution than the resolution specified for display.

- If the resolution you configured cannot be used, a resolution close to the one you specified or the default resolution will be used.

A wrong product key has been entered.

- Automatic installation begins even if you enter a wrong product key. However, the process stops during the automatic installation and you are asked to enter a product key. In this case, you are asked for entry at the reboot after the GUI setup in the automatic installation. If you successfully complete these two entries, entry of a wrong product key does not affect Windows setup.

Detailed network adapter settings are not available.

- You cannot make detailed network adapter settings in the Express Setup. Make the settings from Control Panel after starting up Windows.

Windows started up with the network adapter settings that were not configured in the Express Setup.

- Windows installs network adapters it recognizes and sets the default value to them. You can change the settings from Control Panel after Windows is started.
When the Express Setup is performed but no adapter is actually connected, adapter settings will not be made, but protocols will be installed.

Multiple network adapters have been installed with a different protocol set to each of them. However all protocols are set to all the adapters.

- This is the specification, which makes all installed protocols available to each adapter. What cannot be configured by the Express Setup will have default values.

When two or more network adapters have been set, the detailed settings of TCP/IP protocol are configured to use DHCP.

- When two or more network adapters are set, protocol detailed settings may have default values. Configure the detailed settings from Control Panel.

Default settings are used for the protocol detailed settings though not more than one network adapter is connected (for example, though IP address has been set to TCP/IP, DHCP is set).

- Have you set two or more protocols?

- In this case, the status is the same as the status where two or more network adapters are connected. Because of this default settings are used for the protocol detailed settings.

Configure the detailed settings from Control Panel after the OS is started.

The event log below is recorded after executing Express Setup:

Source	: HASSETUP
Type	: Error
Event ID	: 201
Description	: HASSETUP: The module in one side is not recognized.

- GeminiEngine Control Software is not properly installed because one of the CPU/IO modules could not be recognized during its installation. The possible reasons are:

- One of the CPU/IO modules is not mounted. (The screws that fix the removable handle of the CPU/IO module are not fastened properly, or the power is not supplied.)
- The CPU/IO module is faulty.

Take necessary actions such as checking the device status and mounting the CPU/IO module. Then, reinstall GeminiEngine Control Software with both CPU/IO modules mounted and the power supplied. For more information about installing procedure, see “Installing GeminiEngine Control Software” (page 6-13).

The event log below is recorded when starting the system, or the message “!ILLEGAL FILE” is displayed when logged on as a user who performed the installation.

Source : HASSETUP
 Type : Warning
 Event ID : 101
 Description : Some GeminiEngine Control Software files have been illegally updated in the system.

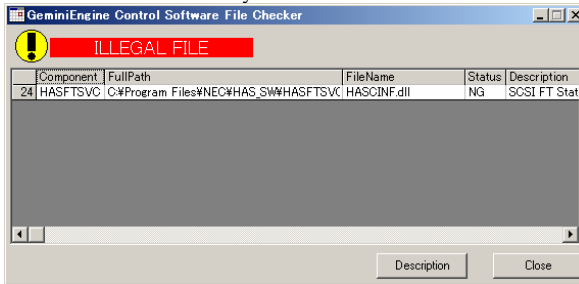

- Files of GeminiEngine Control Software installed on the system are updated to incorrect files. Refer to “Installing GeminiEngine Control Software” (page 6-13) and reinstall GeminiEngine Control Software.
- If “ILLEGAL FILE” message is displayed or only “adpu320.sys” is listed as invalid files in the event log, the SCSI driver file has been updated for some reason. In such a case, reinstallation of the entire GeminiEngine Control Software is not required. You only need to install the SCSI driver. For how to install it, see “N8803-32 SCSI Board” of “Setup of Optional PCI Board” (page 8-38) in the separate User’s Guide.

If only “FC” is displayed as the component name, the cause of it is considered to be that the dedicated driver has not been installed when the Fibre Channel board is mounted. See “N8803-033 Fibre Channel Board Set” of “Setup of Optional PCI Board” (page 8-39) in the separate User’s Guide.

Problems with NEC ESMPRO Setup

A menu which cannot be chosen with a setup main menu.

- The available menus vary depending on the OS types. (The menus that cannot be installed are displayed in gray.)

Stop the setup of NEC ESMPRO Agent on the way.

- If you click [Cancel] during the setup, the message asking whether to stop or not to stop the installation will appear. You can stop the installation by clicking [Stop] (the main menu remains displayed). However, the file having been setup halfway will not be deleted.

Start the uninstallation of NEC ESMPRO Agent after the system is started completely.

- If NEC ESMPRO Agent is uninstalled just after the system startup, the setup program may freeze displaying the [Service Being Deleted...] dialog box. Shutdown the system by using Task Manager or other operation. Then uninstall NEC ESMPRO Agent after the system is started completely.

* For installation procedure and detailed explanations on NEC ESMPRO Manager, refer to the online document in the NEC EXPRESSBUILDER CD-ROM.

Problems with System Repair

“Press F6 if you need to install a third party SCSI or RAID driver...” was not displayed and there was no chance to enter F5 and F6 when “When starting Recovery Console from Windows Server 2003 CD-ROM” was performed.

- Did you press any key when the message “Press any key to boot from CD” is displayed on top of the screen?
 - Start-up from Windows Server 2003 CD-ROM is required to start the Recovery Console from Windows Server 2003 CD-ROM. Press any key while the message “Press any key to boot from CD” is displayed on the screen. You cannot start the Recovery Console from the CD-ROM unless the any key is pressed while the message is being displayed. Restart the system when it does not start from CD-ROM and the message “Press F6 if you need to install a third party SCSI or RAID driver...” is not displayed. See “Starting up Recovery Console” in “SYSTEM REPAIR” in this chapter to start again.

The screen turns out to be black for a while when booting the Recovery Console.

- If you start the Recovery Console that is installed in the system, the screen turns out to be black for a while when booting the Recovery Console. Since the system is normally working, please wait for a while.

When the system’s update is being processed, Operating System Stop Error occurred at the system reboot.

- During the system update process, the message “Windows-FT Orphaning A disk that is part of a fault-tolerant volume can no longer be accessed” is displayed, and there is sometimes a case that OS Stop Error occurs on a reboot after this process. See IMPORTANT of step 6 in “Updating the System” in this chapter when OS Stop Error occurs, and reboot the system. In addition, the system’s update is successfully being performed when the message “Windows-FT Orphaning A disk that is part of a fault-tolerant volume can no longer be accessed” is displayed. However, the mirroring of HDD is not applied. Make sure to check the hard disk’s mirroring after the system start-up.

Appendix A

About Services

Information on NEC Express5800/ft series is provided the web at NEC Express5800 Web ASIA
PACIFIC

<http://www.nec.co.jp/express/>

N8800-096F, EXP320B

NEC Express5800/320Fb-L

N8800-097F, EXP320A

NEC Express5800/320Fb-LR

N8800-098F, EXP320D

NEC Express5800/320Fb-M

N8800-099F, EXP320C

NEC Express5800/320Fb-MR

User's Guide (Setup)



856-124126-411-00K

1st Edition

12-2006

856-124126-411-00

Free Manuals Download Website

<http://myh66.com>

<http://usermanuals.us>

<http://www.somanuals.com>

<http://www.4manuals.cc>

<http://www.manual-lib.com>

<http://www.404manual.com>

<http://www.luxmanual.com>

<http://aubethermostatmanual.com>

Golf course search by state

<http://golfingnear.com>

Email search by domain

<http://emailbydomain.com>

Auto manuals search

<http://auto.somanuals.com>

TV manuals search

<http://tv.somanuals.com>