

# Cordless Internet Phone with Skype™ Model SPH200D User Manual



## **NETGEAR®**

**NETGEAR, Inc.**  
4500 Great America Parkway  
Santa Clara, CA 95054 USA

202-10216-01  
November 2006

## Trademarks

NETGEAR, the NETGEAR logo, and Auto Uplink are trademarks or registered trademarks of NETGEAR, Inc. Skype, SkypeIn, SkypeOut, SkypeMe, Skype Voicemail, the Skype logo, and the S logo are trademarks of Skype Limited. Microsoft, Windows, and Windows NT are registered trademarks of Microsoft Corporation. Other brand and product names are registered trademarks or trademarks of their respective holders. Portions of this document are copyright Intoto, Inc.

November 2006

## Statement of Conditions

In the interest of improving internal design, operational function, and/or reliability, NETGEAR reserves the right to make changes to the products described in this document without notice.

NETGEAR does not assume any liability that may occur due to the use or application of the product(s) or circuit layout(s) described herein.

## Certificate of the Manufacturer/Importer

It is hereby certified that the Cordless Internet Phone with Skype has been suppressed in accordance with the conditions set out in the BMPT-AmtsblVfg 243/1991 and Vfg 46/1992. The operation of some equipment (for example, test transmitters) in accordance with the regulations may, however, be subject to certain restrictions. Please refer to the notes in the operating instructions.

The Federal Office for Telecommunications Approvals has been notified of the placing of this equipment on the market and has been granted the right to test the series for compliance with the regulations.

## Bestätigung des Herstellers/Importeurs

Es wird hiermit bestätigt, daß das Cordless Internet Phone with Skype gemäß der im BMPT-AmtsblVfg 243/1991 und Vfg 46/1992 aufgeführten Bestimmungen entstört ist. Das vorschriftsmäßige Betreiben einiger Geräte (z.B. Testsender) kann jedoch gewissen Beschränkungen unterliegen. Lesen Sie dazu bitte die Anmerkungen in der Betriebsanleitung.

Das Bundesamt für Zulassungen in der Telekommunikation wurde davon unterrichtet, daß dieses Gerät auf den Markt gebracht wurde und es ist berechtigt, die Serie auf die Erfüllung der Vorschriften hin zu überprüfen.

## Regulatory Compliance Information

This section includes user requirements for operating this product in accordance with National laws for usage of radio spectrum and operation of radio devices. Failure of the end user to comply with the applicable requirements may result in unlawful operation and adverse action against the end user by the applicable National regulatory authority.

**NOTE:** This product's firmware limits operation to only the channels allowed in a particular Region or Country. Therefore, all options described in this user's guide may not be available in your version of the product.

## Europe – EU Declaration of Conformity

Marking by the above symbol indicates compliance with the Essential Requirements of the R&TTE Directive of the European Union (1999/5/EC). This equipment meets the following conformance standards:

EN 301 406, EN 301 489

## Europe – Declaration of Conformity in Languages of the European Community

Cesky [Czech]	<i>NETGEAR Inc.</i> tímto prohlašuje, že tento Radiolan je ve shode se základními požadavky a dalšími příslušnými ustanoveními směrnice 1999/5/ES..
Dansk [Danish]	Undertegnede <i>NETGEAR Inc.</i> erklærer herved, at følgende udstyr Radiolan overholder de væsentlige krav og øvrige relevante krav i direktiv 1999/5/EF.
Deutsch [German]	Hiermit erklärt <i>NETGEAR Inc.</i> , dass sich das Gerät Radiolan in Übereinstimmung mit den grundlegenden Anforderungen und den übrigen einschlägigen Bestimmungen der Richtlinie 1999/5/EG befindet.
Eesti [Estonian]	Käesolevaga kinnitab <i>NETGEAR Inc.</i> seadme Radiolan vastavust direktiivi 1999/5/EÜ põhinõuetele ja nimetatud direktiivist tulenevatele teistele asjakohastele sätetele.
English	Hereby, <i>NETGEAR Inc.</i> , declares that this Radiolan is in compliance with the essential requirements and other relevant provisions of Directive 1999/5/EC.
Español [Spanish]	Por medio de la presente <i>NETGEAR Inc.</i> declara que el Radiolan cumple con los requisitos esenciales y cualesquiera otras disposiciones aplicables o exigibles de la Directiva 1999/5/CE.
Ελληνική [Greek]	ΜΕ ΤΗΝ ΠΑΡΟΥΣΑ <i>NETGEAR Inc.</i> ΔΗΛΩΝΕΙ ΟΤΙ Radiolan ΣΥΜΜΟΡΦΩΝΕΤΑΙ ΠΡΟΣ ΤΙΣ ΟΥΣΙΩΔΕΙΣ ΑΠΑΙΤΗΣΕΙΣ ΚΑΙ ΤΙΣ ΛΟΙΠΕΣ ΣΧΕΤΙΚΕΣ ΔΙΑΤΑΞΕΙΣ ΤΗΣ ΟΔΗΓΙΑΣ 1999/5/EK.
Français [French]	Par la présente <i>NETGEAR Inc.</i> déclare que l'appareil Radiolan est conforme aux exigences essentielles et aux autres dispositions pertinentes de la directive 1999/5/CE.
Italiano [Italian]	Con la presente <i>NETGEAR Inc.</i> dichiara che questo Radiolan è conforme ai requisiti essenziali ed alle altre disposizioni pertinenti stabilite dalla direttiva 1999/5/CE.
Latviski [Latvian]	Ar šo <i>NETGEAR Inc.</i> deklarē, ka Radiolan atbilst Direktīvas 1999/5/EK būtiskajām prasībām un citiem ar to saistītajiem noteikumiem.
Lietuvių [Lithuanian]	Šiuo <i>NETGEAR Inc.</i> deklaruoja, kad šis Radiolan atitinka esminius reikalavimus ir kitas 1999/5/EB Direktyvos nuostatas.
Nederlands [Dutch]	Hierbij verklaart <i>NETGEAR Inc.</i> dat het toestel Radiolan in overeenstemming is met de essentiële eisen en de andere relevante bepalingen van richtlijn 1999/5/EG.
Malti [Maltese]	Hawnhekk, <i>NETGEAR Inc.</i> , jiddikjara li dan Radiolan jikkonforma mal-htgijiet essenzjali u ma provvedimenti oħrajn rilevanti li hemm fid-Dirrettiva 1999/5/EC.
Magyar [Hungarian]	Alulírott, <i>NETGEAR Inc.</i> nyilatkozom, hogy a Radiolan megfelel a vonatkozó alapvető követelményeknek és az 1999/5/EC irányelv egyéb előírásainak.
Polski [Polish]	Niniejszym <i>NETGEAR Inc.</i> oświadcza, że Radiolan jest zgodny z zasadniczymi wymogami oraz pozostałymi stosownymi postanowieniami Dyrektywy 1999/5/EC.

Português [Portuguese]	<i>NETGEAR Inc.</i> declara que este Radiolan está conforme com os requisitos essenciais e outras disposições da Directiva 1999/5/CE.
Slovensko [Slovenian]	<i>NETGEAR Inc.</i> izjavlja, da je ta Radiolan v skladu z bistvenimi zahtevami in ostalimi relevantnimi določili direktive 1999/5/ES.
Slovensky [Slovak]	<i>NETGEAR Inc.</i> týmto vyhlasuje, že Radiolan spĺňa základné požiadavky a všetky príslušné ustanovenia Smernice 1999/5/ES.
Suomi [Finnish]	<i>NETGEAR Inc.</i> vakuuttaa täten että Radiolan tyyppinen laite on direktiivin 1999/5/EY oleellisten vaatimusten ja sitä koskevien direktiivin muiden ehtojen mukainen.
Svenska [Swedish]	Härmed intygar <i>NETGEAR Inc.</i> att denna Radiolan står i överensstämmelse med de väsentliga egenskapskrav och övriga relevanta bestämmelser som framgår av direktiv 1999/5/EG.
Íslenska [Icelandic]	Hér með lýsir <i>NETGEAR Inc.</i> yfir því að Radiolan er í samræmi við grunnkröfur og aðrar kröfur, sem gerðar eru í tilskipun 1999/5/EC.
Norsk [Norwegian]	<i>NETGEAR Inc.</i> erklærer herved at utstyret <i>Radiolan</i> er i samsvar med de grunnleggende krav og øvrige relevante krav i direktiv 1999/5/EF.

## FCC Requirements for Operation in the United States

### FCC Information to User

This product does not contain any user serviceable components and is to be used with approved antennas only. Any product changes or modifications will invalidate all applicable regulatory certifications and approvals

### FCC Guidelines for Human Exposure

This equipment complies with FCC radiation exposure limits set forth for an uncontrolled environment. This equipment should be installed and operated with minimum distance of 20 cm between the radiator and your body.

This transmitter must not be co-located or operating in conjunction with any other antenna or transmitter.

### FCC Declaration Of Conformity

We NETGEAR, Inc., 4500 Great America Parkway, Santa Clara, CA 95054, declare under our sole responsibility that the model SPH200D Cordless Internet Phone with Skype complies with Part 15 of FCC Rules. Operation is subject to the following two conditions:

- This device may not cause harmful interference, and
- This device must accept any interference received, including interference that may cause undesired operation.

### FCC Radio Frequency Interference Warnings & Instructions

This equipment has been tested and found to comply with the limits for a Class B digital device, pursuant to Part 15 of the FCC Rules. These limits are designed to provide reasonable protection against harmful interference in a residential installation. This equipment uses and can radiate radio frequency energy and, if not installed and used in accordance with the instructions, may cause harmful interference to radio communications. However, there is no guarantee that

interference will not occur in a particular installation. If this equipment does cause harmful interference to radio or television reception, which can be determined by turning the equipment off and on, the user is encouraged to try to correct the interference by one or more of the following methods:

- Reorient or relocate the receiving antenna
- Increase the separation between the equipment and the receiver
- Connect the equipment into an electrical outlet on a circuit different from that which the radio receiver is connected
- Consult the dealer or an experienced radio/TV technician for help.

Cordless Internet Phone with Skype



Tested to Comply  
with FCC Standards  
FOR HOME OR OFFICE USE

Modifications made to the product, unless expressly approved by NETGEAR, Inc., could void the user's right to operate the equipment.

## Equipment Compliance Information

Your telephone equipment is approved for connection to the Public Switched Telephone Network and is in compliance with Part 68 of FCC Rules and Regulations, and the Technical Requirements for Telephone Terminal Equipment adopted by ACTA

## Notification to the Local Telephone Company

On the bottom of this equipment is a label indicating, among other information, the US number and Ringer Equivalence Number (REN) for the equipment. You must, upon request, provide this information to your telephone company.

The REN is useful in determining the number of devices you may connect to your telephone line and still have all of these devices ring when your telephone number is called. In most (but not all) areas, the sum of the RENs of all devices connected to one line should not exceed 5. To be certain of the number of devices you may connect to your line as determined by the REN, you should contact your local telephone company.

The REN number is located on the bottom of the Base unit.

A plug and jack used to connect this equipment to the premise wiring and telephone network must comply with the applicable FCC Part 68 rules and requirements adopted by the ACTA. A compliant telephone cord and modular plug is provided with this product. It is designed to be connected to a compatible modular jack that is also compliant. See installation instructions for details.

## Notes

- This equipment may not be used on coin service provided by the telephone company.
- Party lines are subject to state tariffs. Therefore, you may not be able to use your own telephone equipment if you are on a party line. Check with your local telephone company.
- Notice must be given to the telephone company upon permanent disconnection of your telephone from your line.
- If your home has specially wired alarm equipment connected to the telephone line, ensure the installation of this product does not disable your alarm equipment. If you have questions about what will disable alarm equipment, consult your alarm equipment supplier or a qualified installer.

## **Rights of the Telephone Company**

Should your equipment cause trouble on your line that may harm the telephone network, the telephone company shall, where practicable, notify you that temporary discontinuance of service may be required. Where prior notice is not practicable and the circumstances warrant such action, the telephone company may temporarily discontinue service immediately. In case of such temporary discontinuance, the telephone company must: (1) promptly notify you of such temporary discontinuance; (2) afford you the opportunity to correct the situation; and (3) inform you of your right to bring a complaint to the Commission pursuant to procedures set forth in Subpart E of Part 68, FCC Rules and Regulations.

THE TELEPHONE COMPANY MAY MAKE CHANGES IN ITS COMMUNICATIONS FACILITIES, EQUIPMENT, OPERATIONS, OR PROCEDURES WHERE SUCH ACTION IS REQUIRED IN THE OPERATION OF ITS BUSINESS AND NOT INCONSISTENT WITH FCC RULES AND REGULATIONS. IF THESE CHANGES ARE EXPECTED TO AFFECT THE USE OR PERFORMANCE OF YOUR TELEPHONE EQUIPMENT, THE TELEPHONE COMPANY MUST GIVE YOU ADEQUATE NOTICE, IN WRITING, TO ALLOW YOU TO MAINTAIN UNINTERRUPTED SERVICE.

## **Privacy of Communications**

Privacy of communications may not be ensured when using this telephone.

## **Industry Canada Notice**

### **Terminal Equipment**

This equipment meets the applicable Industry Canada Terminal Equipment Technical Specifications.

This is confirmed by the registration number, which is the same as the certification number for Radio Equipment. The abbreviation, IC before the registration number signifies that registration was performed based on a Declaration of Conformity indicating that Industry Canada technical specifications were met. It does not imply that Industry Canada approved the equipment.

### **Radio Equipment**

The term "IC:" before the radio certification number signifies that Industry Canada technical specifications RSS-213 and ICES-003 were met.

### **RF Radiation Exposure Statement**

The equipment has been evaluated and found compliant in accordance with Industry Canada RSS-102 with respect to Health Canada Code 6 for Exposure of Humans to RF Fields.

The electrical network is classified as dangerous according to criteria in the standard EN 60950-1.

## **Telephone Connections**

The voltage on the network is classified as TNV-3 (Telecommunication Network Voltages, as defined in the standard IEC 60950-1).

## Equipment Compliance Information

Your telephone equipment is certified for connection to the Public Switched Telephone Network and is in compliance with Part 68 of the FCC Rules and Regulations, and the technical requirements for telephone terminal equipment adopted by ACTA.

## Product and Publication Details

<b>Model Number:</b>	SPH200D
<b>Publication Date:</b>	November 2006
<b>Product Family:</b>	Cordless Internet Phone
<b>Product Name:</b>	Cordless Internet Phone with Skype
<b>Home or Business Product:</b>	Home
<b>Language:</b>	English
<b>Publication Part Number:</b>	202-10216-01
<b>Publication Version Number:</b>	1.0





---

# Contents

## About This Manual

Conventions, Formats, and Scope .....	xiii
How to Use This Manual .....	xiv
How to Print this Manual .....	xiv

## Chapter 1

### Getting Started

Important Safety Information .....	1-1
Digital Security System .....	1-2
Hearing Aid Compatibility (HAC) .....	1-2
Package Contents .....	1-3
About Your Phone .....	1-4
Handset Light and Controls .....	1-4
Powering Your Handset On and Off .....	1-5
Handset Icons .....	1-6
Using the Menus .....	1-6
Locking and Unlocking the Handset Keypad .....	1-7
Base Unit .....	1-8
Paging Missing Handsets .....	1-9

## Chapter 2

### Installation

Requirements .....	2-1
Charging the Batteries .....	2-2
Connecting the Base Unit .....	2-3
Setting up the Handset .....	2-4
Signing In to Skype .....	2-4
Creating a Skype Name and Password .....	2-5
Standby Display .....	2-5
Linking to the Base Unit .....	2-6

---

## Chapter 3

### Skype Calling

Skype Features .....	3-1
Assigning a Preferred Line for a SkypeOut Contact .....	3-1
Making a Skype Call .....	3-2
Calling a Contact .....	3-2
Making a SkypeOut Call .....	3-3
Redialing the Last Number .....	3-4
Receiving Calls .....	3-4
Answering a Call .....	3-4
Rejecting a Skype Call .....	3-4
Auto Answer .....	3-4
Answering a Second Skype Call During a Call .....	3-5
Call Forwarding .....	3-5
Skype Voicemail .....	3-6
My Greeting .....	3-7
Skype Tools .....	3-7
Privacy .....	3-7
Your Skype Profile .....	3-8
Signing in Automatically .....	3-9
Viewing or Changing Your Skype Status .....	3-9
Changing Your Skype Password .....	3-10
Updating Skype Software .....	3-11

## Chapter 4

### Landline Calling

Making a Landline Call .....	4-1
Direct Dialing .....	4-1
Selecting the Landline Option .....	4-2
Redialing the Last Number .....	4-2
Making a Second Landline Call During a Call .....	4-2
Receiving Calls .....	4-3
Auto Answer .....	4-3
Turning off the Ringer During a Call .....	4-3
Answering a Second Landline Call during a Call .....	4-3
Landline Voicemail .....	4-4

---

## **Chapter 5**

### **Contacts**

Entering Text and Numbers .....	5-1
Contact Options .....	5-2
Adding Contacts .....	5-3
Finding a Contact .....	5-3
Searching for a Skype User .....	5-4
Blocking a Contact .....	5-4
Unblocking a Contact .....	5-4

## **Chapter 6**

### **Advanced Features**

Call History .....	6-1
Call History Options .....	6-1
Viewing Call Records .....	6-2
Making a Call from the Call History .....	6-3
Adding a Call Record to Your Contact List .....	6-3
Deleting a Call Record .....	6-4
Deleting All Records of a Call List .....	6-4
Intercom and Conference Calls .....	6-4
Calling Another Handset .....	6-4
Transferring a Call .....	6-5
Making a 3-Way Conference Call .....	6-5
Predialing .....	6-6
Personalizing Your Handset Display .....	6-7
Setting the Language .....	6-7
Changing the Screen Settings .....	6-7
Personalizing Your Phone's Sound .....	6-7
Adjusting the Sound Settings .....	6-7
Setting the Ring Tones .....	6-8
Turning Off All the Ringers with Silent Status .....	6-9

## **Chapter 7**

### **Settings and Maintenance**

Settings .....	7-1
Country Code .....	7-1
Area Code .....	7-2

---

Time and Date .....	7-2
Changing the System PIN .....	7-3
Resetting to Default Settings .....	7-3
Registering Your Handset .....	7-4
Registering Your Handset(s) with an Additional Base .....	7-5
Selecting a Base Unit .....	7-5
Deleting a Handset .....	7-5
Advanced Landline Calling Features .....	7-6
Dial Mode .....	7-6
Recall Selection .....	7-6
Setting a Pause .....	7-7
Category Number .....	7-7
Network Settings .....	7-8
Viewing Network Settings .....	7-8
Changing Network Settings .....	7-8
Web Page Configuration .....	7-9
Accessing the Web Page .....	7-9
Troubleshooting .....	7-10

## **Appendix A**

### **Default Factory Settings and Technical Specifications**

Default Factory Settings .....	A-1
Technical Specifications .....	A-2
Power and Safety .....	A-3

## **Appendix B**

### **Related Documents**

# About This Manual

The *NETGEAR® Cordless Internet Phone with Skype® Model SPH200D User Manual* describes how to install, configure, and troubleshoot the Cordless Internet Phone with Skype Model SPH200D. The information in this manual is intended for readers with intermediate computer and Internet skills.

## Conventions, Formats, and Scope

---

The conventions, formats, and scope of this manual are described in the following paragraphs:

- **Typographical Conventions.** This manual uses the following typographical conventions:

<i>Italics</i>	Emphasis, books, CDs, URL names
<b>Bold</b>	User input
Fixed	Screen text, file and server names, extensions, commands, IP addresses

- **Formats.** This manual uses the following formats to highlight special messages:

	<b>Note:</b> This format is used to highlight information of importance or special interest.
------------------------------------------------------------------------------------	----------------------------------------------------------------------------------------------

	<b>Tip:</b> This format is used to highlight a procedure that will save time or resources.
-------------------------------------------------------------------------------------	--------------------------------------------------------------------------------------------

	<b>Warning:</b> Ignoring this type of note may result in a malfunction or damage to the equipment.
-------------------------------------------------------------------------------------	----------------------------------------------------------------------------------------------------

	<b>Danger:</b> This is a safety warning. Failure to take heed of this notice may result in personal injury or death.
-------------------------------------------------------------------------------------	----------------------------------------------------------------------------------------------------------------------

- **Scope.** This manual is written for the Cordless Internet Phone with Skype Model SPH200D according to these specifications:

Product Version	Cordless Internet Phone with Skype Model SPH200D
Manual Publication Date	November 2006

For information about using Skype, see [www.skype.com](http://www.skype.com). For more information about network, Internet, firewall, and VPN technologies, see the links to the NETGEAR website in [Appendix B](#), “Related Documents”.







**Note:** Product updates are available on the NETGEAR, Inc. website at <http://kbserver.netgear.com/products/SPH200D.asp>.

## How to Use This Manual

---

The HTML version of this manual includes the following:

- Buttons,  and , for browsing forward or backward through the manual one page at a time
- A  button that displays the table of contents and  button that displays the index. Double-click on a link in the table of contents or index to navigate directly to where the topic is described in the manual.
- A  button to access the full NETGEAR, Inc. online knowledge base for the product model.
- Links to PDF versions of the full manual and individual chapters.

## How to Print this Manual

---

To print this manual you can choose one of the following several options, according to your needs.

- **Printing a Page in HTML View.**

Each page in the HTML version of the manual is dedicated to a major topic. Use the *Print* button on the browser toolbar to print the page contents.

- **Printing a Chapter.**

Use the *PDF of This Chapter* link at the top left of any page.

- Click the *PDF of This Chapter* link at the top left of any page in the chapter you want to print. The PDF version of the chapter you were viewing opens in a browser window.
- Your computer must have the free Adobe Acrobat reader installed in order to view and print PDF files. The Acrobat reader is available on the Adobe Web site at <http://www.adobe.com>.
- Click the print icon in the upper left of the window.

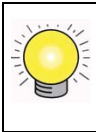

**Tip:** If your printer supports printing two pages on a single sheet of paper, you can save paper and printer ink by selecting this feature.

- **Printing the Full Manual.**

Use the *Complete PDF Manual* link at the top left of any page.

- Click the *Complete PDF Manual* link at the top left of any page in the manual. The PDF version of the complete manual opens in a browser window.
- Click the print icon in the upper left of the window.



**Tip:** If your printer supports printing two pages on a single sheet of paper, you can save paper and printer ink by selecting this feature.





# Chapter 1

## Getting Started

### Important Safety Information

---



**Warning:** No emergency calling. The Cordless Internet Phone requires a base station and power. Without them, you cannot make any landline or Internet calls.



No Emergency Calls.  
Skype is not a replacement for  
your ordinary telephone and  
cannot be used for emergency calling.



**Warning:** Follow basic safety precautions to reduce the risk of fire, electric shock and injury.

- Read and follow all warnings and instructions marked on the product.
- Do not use this product near water, a laundry tub, in a wet basement, or near a swimming pool.
- Do not place this product on an unstable table. The product may fall and be damaged.
- This product should never be placed near or over a radiator or heat register.
- This product should be operated only from the type of power source indicated on the label.
- Do not allow anything to rest on the power cord. Do not locate this product where the cord will be abused by people walking on it.
- Do not overload wall outlets and extension cords as this can result in the risk of fire or electric shock.
- Avoid using a telephone during a storm or severe weather with lightning. There may be a risk of electric shock from lightning.
- Do not use this product to report a gas leak in the vicinity of the leak.
- Do not use this product near intensive care medical equipment or by any people with pacemakers.

- Due to the radio signals between base station and handset, wearers of hearing aids may experience interference in the form of a humming noise.
- Use only the battery type provided in the box. Do not use lithium or non-rechargeable batteries. For more information about battery safety, see [“Batteries” in Appendix A](#).

## Digital Security System

---

Your cordless phone uses a digital security system to protect against false ringing, unauthorized access, and charges to your phone line.

There is a unique digital security code programmed into each unit. When the base and the handset are powered up the first time, the handset automatically links with the base ready for normal and secure use. If you have also purchased additional accessory handsets, you will need to follow the registration procedure in [“Registering Your Handset” in Chapter 7](#). This will help maintain the digital security.

## Hearing Aid Compatibility (HAC)

---

This telephone system meets FCC and Industry Canada standards for Hearing Aid Compatibility.



**Note:** This telephone works by sending radio signals between the base unit and the handset. These signals may interfere with some hearing aids, causing a humming noise.

## Package Contents

Unpack the box and make sure that you have all the items listed below. If there are missing items, contact your dealer.



base unit



handset

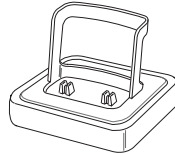

charger

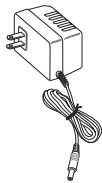

base power adapter

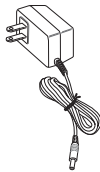

charger power adapter

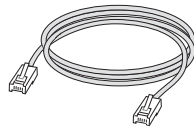

Ethernet cable  
with RJ45 connector

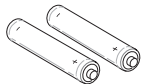

NiMH AAA batteries

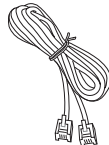

telephone line cord

**Figure 1-1**

- Base unit
- Phone (also called a handset)
- Charger
- Power adapter for base
- Power adapter for charger
- Two rechargeable NiMH batteries, size AAA 1.2V 750mAh (HR11/45)
- Telephone line cord
- Ethernet cable (with RJ45 connector)
- NETGEAR CD, which includes this User Manual and links to product registration and support.
- *Cordless Internet Phone with Skype Model SPH200D Quick Installation Guide*

## About Your Phone

### Handset Light and Controls

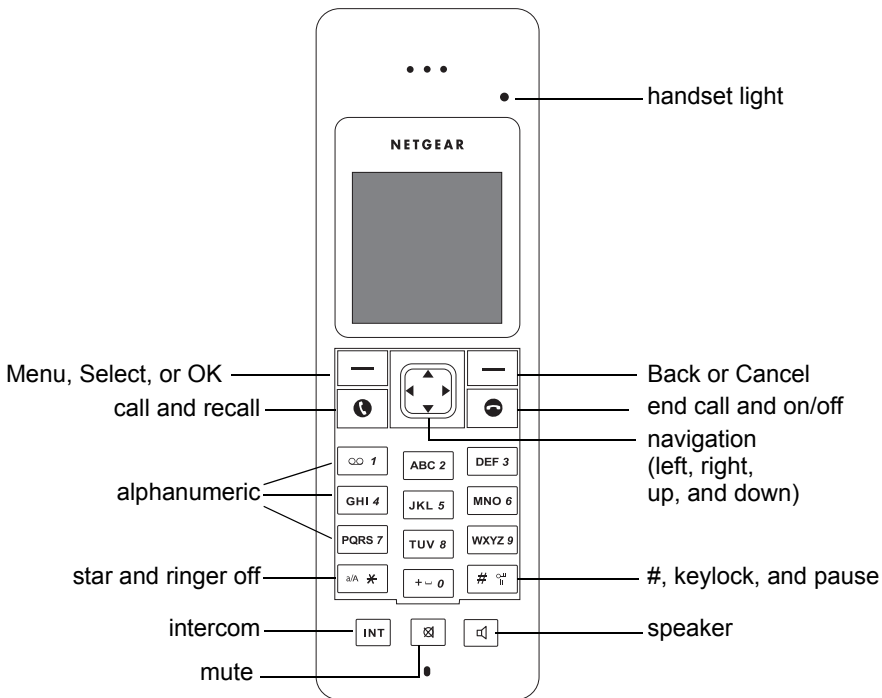

Figure 1-2

Table 1-1. Handset Light and Controls

Light and Controls	Action
Handset light	<ul style="list-style-type: none"> <li>• Lit when a call is in progress.</li> <li>• Blinks when receiving a call.</li> <li>• Blinks if there is voicemail.</li> </ul>
Menu, Select or OK	Use this button to press Menu, Select, or OK displayed on the screen.
Back or Cancel	Use this button to press Back or Cancel displayed on the screen.
Talk and recall	<ul style="list-style-type: none"> <li>• Make and receive calls.</li> <li>• Send flash signal for landline calls.</li> </ul>

**Table 1-1. Handset Light and Controls (continued)**

Light and Controls	Action
End call and on/off	<ul style="list-style-type: none"> <li>• End a call.</li> <li>• Exit menus.</li> <li>• Power on the handset.</li> <li>• Enter the power menu.</li> </ul>
Navigation (up, down, left, and right)	<ul style="list-style-type: none"> <li>• Scroll to menu items.</li> <li>• Move the cursor and change the selection</li> <li>• Up: Shortcut to Skype Change Status menu. Increase ringer and receiver volume.</li> <li>• Down: Shortcut to All Calls list. Decrease ringer and receiver volume.</li> </ul>
Alphanumeric	<ul style="list-style-type: none"> <li>• Dial digits.</li> <li>• Enter characters or numbers.</li> </ul>
Star and ringer off	<ul style="list-style-type: none"> <li>• Dial *.</li> <li>• Enter alphanumeric mode during standby.</li> <li>• Change text entry mode (a/A/1).</li> </ul>
Intercom	Make an intercom call.
Mute	Mute/un-mute the microphone.
#, keylock, and pause	<ul style="list-style-type: none"> <li>• Dial #.</li> <li>• Enter a pause.</li> <li>• Lock the keypad.</li> <li>• Display the symbols matrix.</li> </ul>
Speaker	Turn the speaker on or off.

## Powering Your Handset On and Off

### Powering On Your Handset

Press . The handset may take a few seconds to power up.

### Powering Off Your Handset

1. Press and hold  for two seconds. The power menu is displayed.
2. Scroll to Switch Off. Press Select. The handset is switched off.















**Note:** Your handset cannot receive any calls if the power is switched off.

## Handset Icons



Each icon gives you a visual message of what is happening on your handset.

**Table 1-2. Handset Icons**

Icon	Meaning	Icon	Meaning
	Signal strength		Battery level
	Call in progress		Line on hold
	Speaker on		Mute
	Ringer off		New voicemail
	New missed call		New request waiting
	Skype network alert		Keypad locked
	handset lost link		

## Using the Menus

Your phone offers a variety of features and functions grouped in the menus.

	<b>Tip:</b> Use  (Up or down) to navigate the menus.
-------------------------------------------------------------------------------------	-----------------------------------------------------------------------------------------------------------------------------------------

1. From the standby display, press Menu to go to the main menu.
2. You can select Contacts, History, or Status, or scroll to select the All Calls list.

To exit from any menu instantly, press . All unconfirmed changes will not be saved.

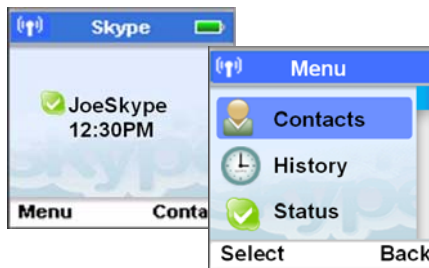



**Figure 1-3**

Table 1-3. Menus

Contacts	History	Status	Add Contact
Options Call Send Voicemail View profile Rename Remove Block Request detail	All calls Missed calls Incoming calls Outgoing calls Voicemails New contact	Change status My profile Sign out	Skype SkypeOut
Search	Services	Settings	
Enter name or e-mail	Skype credit SkypeIn Voicemail	General Call settings Privacy Tones Screen Time & Date Network Handset Information Advanced	

## Locking and Unlocking the Handset Keypad

You can lock the handset keypad to prevent accidental button presses. When you want to make a call you can unlock the keypad.

- **Locking the keypad.** Press and hold . The keypad is locked, and  is displayed.
- **Unlocking the keypad.** Press  to unlock. The keypad is unlocked.

## Base Unit

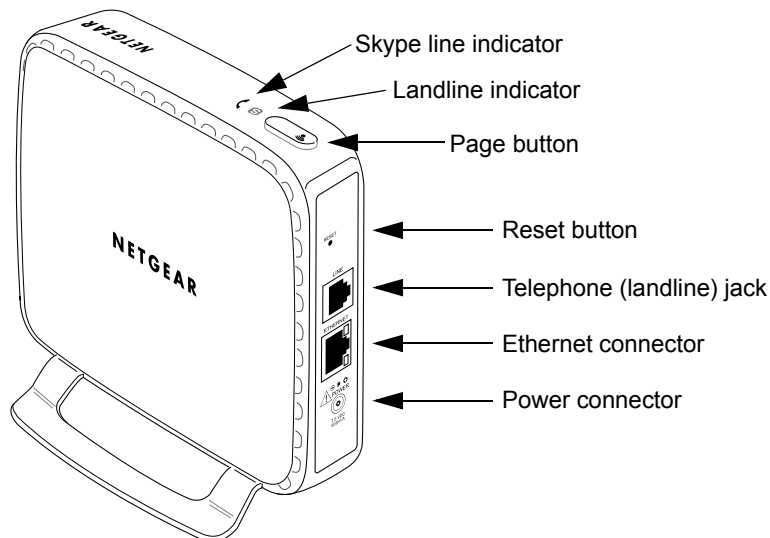

**Figure 1-4**

The following table describes the keys and connectors on the base unit.



**Table 1-4. Base Unit Keys and Connectors**

Indicators, Buttons, and Connectors	Description
Skype line indicator	<ul style="list-style-type: none"> <li>Blinks when receiving a Skype line call.</li> <li>Lit when the Skype line is in use.</li> </ul>
Landline indicator	Blinks when receiving a landline call.
Page button	<ul style="list-style-type: none"> <li>Find handsets.</li> <li>Register handsets.</li> </ul>
Reset button	<ul style="list-style-type: none"> <li>Push and release to reset the power.</li> <li>Push and hold for 5 seconds, and then release to reset to factory default settings.</li> </ul>
Telephone (landline) jack	Connect to the landline.
Ethernet jack	Connect to the Internet.
Power connector	Connect to the power adapter.



## **Paging Missing Handsets**

You can use the Page button on the base unit to locate missing handsets.

1. Press  on the base unit. All the handsets connected to this base unit ring.
2. To stop paging, press  on the base unit again OR  
Press any key on the handset to stop the paging of that handset.



# Chapter 2

## Installation

The Cordless Internet Phone with Skype Model SPH200D can connect to Skype through your broadband Internet connection, or it can work with a landline as an ordinary cordless phone. You can use the phone to make and receive calls and to manage Skype.

To set up and use your Cordless Internet Phone:

1. Check the package contents.  
See [“Package Contents” in Chapter 1](#).
2. Charge the batteries.  
See [“Charging the Batteries” on page 2-2](#).
3. Connect the base unit.  
See [“Connecting the Base Unit” on page 2-3](#).
4. Set up your handset.  
See [“Setting up the Handset” on page 2-4](#).
5. Sign in to Skype.  
See [“Signing In to Skype” on page 2-4](#).

## Requirements

---

To install the Cordless Internet Phone with Skype Model SPH200D, you need the following:

- Power as specified in [“Power and Safety” in Appendix A](#).
- For Internet calling:
  - Broadband Internet connection with ADSL or cable modem.
- For landline calling:
  - Telephone line with landline service.

## Charging the Batteries

---



**Danger:** There is a risk of explosion if the battery is replaced by an incorrect type. Never use non-rechargeable batteries. Use the rechargeable NiMH batteries, size AAA 1.2V 750mAh (HR11/45) that are supplied with this product.

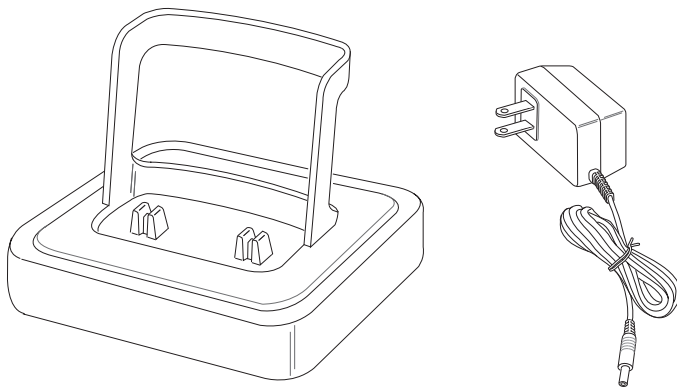

**Figure 2-1**





To charge the batteries, follow these steps:

1. Connect the power adapter of the charger to the charger and a standard wall outlet.
2. Place the two rechargeable batteries (provided) into the battery compartment of the handset.
3. Slide the battery door firmly into place.
4. Place the handset on the charger.

	<p><b>Note:</b> Charge for 14 hours before initial use.</p>
--	-------------------------------------------------------------

## Battery Level

The battery icon displays the current battery level.

			
100% full	60% full	30% full	Empty (charging required)

Your handset may power down if it is not charged after the battery is empty. If you are on the phone while the battery is nearly empty, you will hear warning tones. Your call maybe cut off shortly after the warning.

## Connecting the Base Unit

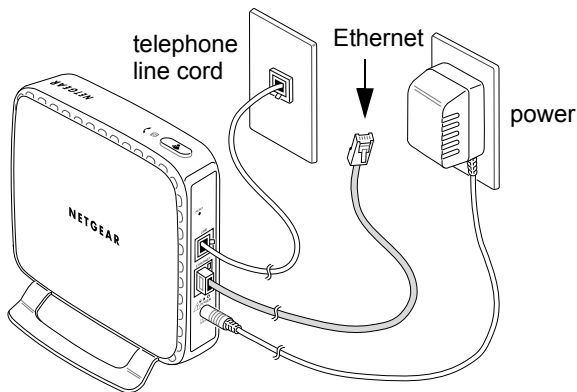

Figure 2-2

To connect the base unit, follow these steps:

1. Connect one end of the power adapter to the base unit, and the other to a standard wall outlet.
2. You can connect the Ethernet cable, the telephone line cord, or both.
  - For Internet calling, use the provided Ethernet cable to connect the base unit to your gateway, router, or modem (ADSL or cable).
  - For landline calling, connect the telephone line cord to the base unit and the wall phone socket.

## Setting up the Handset

---

The first time you use the handset, you must set it up. To set up the handset, follow these steps:

1. Remove the handset from the charger.  
The handset displays set up questions.
2. Use the arrow buttons to scroll, and press Select to confirm. For numbers, press Clear to make corrections. Press OK when you are done.
  - **Language.** Select the language.
  - **Agreement.** Read the entire Skype agreement and accept it.
  - **Country code.** This is the international calling code for your country (for example, 1 for US, 44 for UK, or 33 for France).
  - **Area code.** You need this to return local, national, or international calls received on the landline.
3. Your phone resets and updates itself. It powers up automatically after a few seconds.

## Signing In to Skype

---

After the phone resets itself, it powers up and links to the base unit. If the phone does not find the base unit, see [“Linking to the Base Unit”](#) on page 2-6. The phone shows the Sign In display.

Follow these steps:

1. Sign in to Skype, or create a new Skype Name if you do not have one. (See [“Creating a Skype Name and Password”](#) on page 2-5.)

If you have Skype contacts, they are downloaded to your phone. Depending on Internet traffic and the number of contacts, this can take several minutes.

2. If you want the phone to automatically sign you in, select Yes for Automatic Sign In.
3. Use the phone to make and receive calls.

For Skype calling, see [Chapter 3, “Skype Calling”](#). For landline calling, see [Chapter 4, “Landline Calling”](#).



**Figure 2-3**

## Creating a Skype Name and Password

Each Skype account has a unique Skype Name with a password. If your Skype Name is the same as another Skype user it will not be accepted. Follow these guidelines:

- **Characters:** You can use uppercase and lowercase characters, numbers, and punctuation marks. You cannot use spaces. You cannot start your Skype Name or password with a number or punctuation mark.
- **Length:** You can use 6-30 characters for your Skype Name, and 4-20 characters for your password.
- **Unique Password:** You cannot use your Skype Name as a password.”

**Note:** After you have created your Skype Name, it is strongly recommended that you register an email address for your Skype Name on the Skype website. This will allow Skype to generate a new password for you in the event that you lose your password. Go to [www.skype.com](http://www.skype.com) and sign in to your account. Then, follow the provided instructions for registering an email address for your account.

## Standby Display

Your phone is in standby mode when it is idle. It shows your Skype status icon, your Skype Name, the handset number, the system time, the signal icon, and the battery icon.



Figure 2-4



## Linking to the Base Unit

---

The signal icon on the handset shows the link status between your handset and the base unit.



**Note:** If your handset does not link, you will cannot make or receive any calls; and you will not be able to use many of the phone features.

- **Link icon.**  Your handset and base unit are linked. They can communicate.
- **Lost Link icon** . Your handset is not linked to the base unit. They cannot communicate. Make sure that the base unit is plugged in. Take your handset closer to the base unit to reconnect the link.
- **Unregistered.** This handset is not registered to the base unit. It may have been purchased separately. You must register the handset before it can link to the base unit. See [“Registering Your Handset” in Chapter 7.](#)

If you move too far away from the base unit while you are on the phone, you will hear warning tones notifying you that your handset is almost out of range (the link is lost). Take your handset closer to the base unit or your call will be cut off shortly after the warning.



# Chapter 3

## Skype Calling

### Skype Features

---

After you have created your Skype account, you can call other people with Skype accounts for free. Skype also offers additional features, including:

- **SkypeOut™.** Allows you to place calls to traditional landline and mobile phones.
- **SkypeIn™.** A subscription feature that provides you with a traditional phone number for receiving Skype calls from traditional landlines and mobile phones.
- **Skype Voicemail.** Skype Voicemail allows you to send and receive voicemail messages and record a greeting.

For more information on these features, go to [www.skype.com](http://www.skype.com).

### Assigning a Preferred Line for a SkypeOut Contact

Before you begin making Skype or SkypeOut calls, it is a good idea to assign a preferred line. After setting the preferred line, all SkypeOut contacts (except those on the outgoing call list) will always be dialed out from the preferred line when you press .

To assign a preferred line for a SkypeOut contact, follow these steps:

1. Press Menu>Settings>Call Settings>Preferred line.
2. Scroll and select the setting that you want.

**SkypeOut.** Use SkypeOut to dial this number.

**Landline.** Use the Landline to dial this number.

**Always Ask.** Ask which line to use when this number is dialed.

The new setting is saved.

## Making a Skype Call

You can make SkypeOut calls, call a contact, or call from the Call History (“[Viewing Call Records](#)” in [Chapter 6](#)).

### Calling a Contact

After your contacts are downloaded, or you create contacts, you can place Skype or SkypeOut calls to contacts.

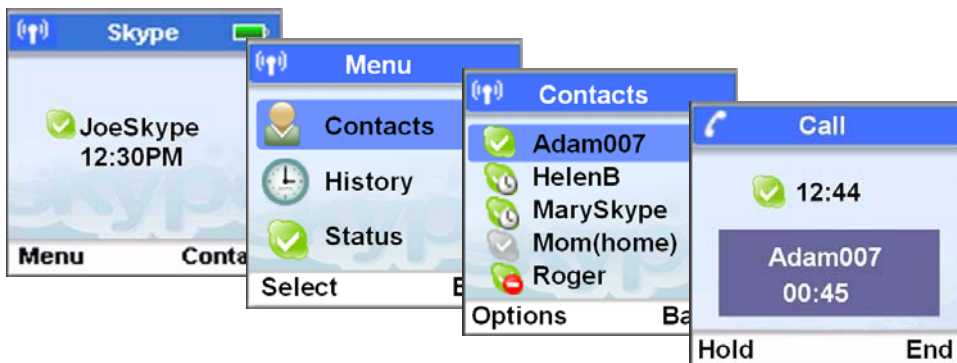

**Figure 3-1**

To call a contact, follow these steps:

1. Press Menu>Contacts>Select.
2. Highlight a contact and then press ■.

Wait for the call to connect, ring, and be answered.

	<p><b>Note:</b> The number is dialed out on the preferred line. For information about setting up a preferred line for a contact, see “<a href="#">Assigning a Preferred Line for a SkypeOut Contact</a>” on page 3-1.</p>
--	---------------------------------------------------------------------------------------------------------------------------------------------------------------------------------------------------------------------------

3. Press End ■ to end the call.

## Making a SkypeOut Call

You can call a traditional landline or mobile phone using SkypeOut.

	<p><b>Note:</b> Depending on your service, you might need Skype credit to make SkypeOut calls. Your phone alerts you when your Skype credits are low.</p>
--	-----------------------------------------------------------------------------------------------------------------------------------------------------------

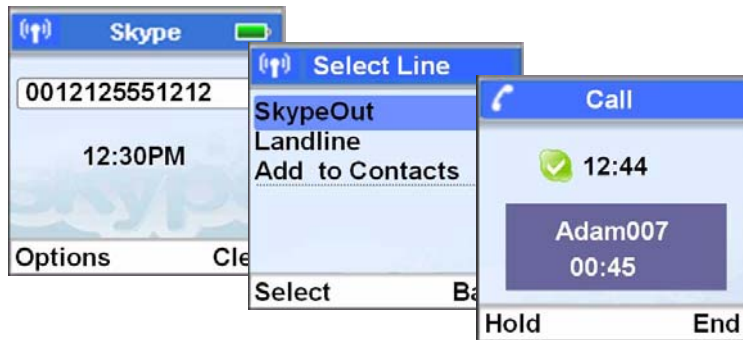

**Figure 3-2**

To make a SkypeOut call, follow these steps:

1. Use the keypad to dial the number.

SkypeOut numbers (even local numbers) must be entered in the following format:

“00” + “country code” + “area code” + “number”.

2. Press Options>SkypeOut.
3. Press .
4. Wait for the call to connect, ring, and be answered.

	<p><b>Note:</b> During a call, the call timer displays the talk time of your call.</p>
--	----------------------------------------------------------------------------------------

5. Press End  to end the call.

## Redialing the Last Number

Press  twice within one second. The last number that you called is dialed out using the same line as before.

## Receiving Calls

---

When you receive a call, your phone rings. You can answer the call, reject the call, or answer a second call that you receive during a phone call.

### Answering a Call

Press  to answer the call.



**Tip:** When a call is missed, your phone displays You have Missed Calls. Press View for more options.

### Rejecting a Skype Call

When a Skype call comes in, you can reject the call.

Press Reject. The handset returns to standby.

### Auto Answer

With Auto Answer you can answer an incoming call by simply picking up the handset from the charging cradle. You do not need to press a button to answer the call.

To set up Auto Answer, follow these steps:

1. Press Menu>Settings>General>Auto Answer.
2. Scroll and select On.

The new setting is saved.

## Answering a Second Skype Call During a Call

During a Skype call, your phone sounds a short beep periodically to notify you of another incoming Skype call.

To answer a second Skype call during a call, follow these steps:

1. Press  to put the first call on hold and answer the new call.

Your phone rings to notify you that a caller is on hold.

2. Press  to toggle between the two callers OR

Press  to end the current call and return to standby.

## Call Forwarding

You can redirect Skype calls to a landline or mobile number when you are away from your home or office. You can change the call forwarding number, and stop call forwarding when it is no longer needed.

- You can enter a Skype account name and forward to that account.
- If you want to forward your calls to a SkypeOut number, check your Skype credit.
- When entering the SkypeOut number, you must enter a + before the number. To enter + press and hold 0 (zero).
- Only calls unanswered will be forwarded. The phone will ring for 15 seconds before forwarding the call.

	<b>Note:</b> If you use Call Forwarding, your Skype Voicemail is turned off. All your calls are sent to the forwarded number. If you do not answer calls, callers cannot leave a message at your Skype Voicemail until you have stopped call forwarding.
-------------------------------------------------------------------------------------	----------------------------------------------------------------------------------------------------------------------------------------------------------------------------------------------------------------------------------------------------------

To go to Call Forwarding, follow these steps:

1. Press Menu>Settings>Call Settings>Call Forward.

The display shows the call forwarding setting:

- **No.** Call forwarding is not used.
- **Forward To.** Call forwarding is turned on, and calls are routed to this number.

2. Enter the setting that you want.
  - **Start Call Forwarding.** Answer Yes to Forward un-answered calls, and then enter the phone number.
  - **Edit the Forward To number.** Scroll and select Forward To, and then edit the number.
  - **Stop Call Forwarding.** Select No.
3. Press OK when finished.

Your calls will be forwarded to the number you entered.

## Skype Voicemail

---

You can use landline voicemail service and Skype Voicemail.

	<b>Note:</b> For information about Skype Voicemail, go to <a href="http://www.skype.com">www.skype.com</a> . For information about landline voicemail, contact your service provider.
-----------------------------------------------------------------------------------	---------------------------------------------------------------------------------------------------------------------------------------------------------------------------------------

A voicemail icon  shows when there is a voicemail waiting for you.

To go to the Skype Voicemail menu, follow these steps:

1. Press Menu> History> Voicemails> Skype VM.
2. Scroll to the voicemail that you want.
3. Scroll and select one of these choices:
  - **Play.** Plays the selected voicemail.
  - **Call.** Returns a call to the voicemail sender.
  - **Send Voicemail.** Record and send voicemail. Start recording after the beep.
  - **Delete.** Deletes a Skype voicemail. A confirmation request is displayed. Press Yes to confirm and the voicemail will be deleted.

## My Greeting

My Greeting is the message people hear before leaving you a voicemail. You use the Voicemail menu to work with this greeting.

To work with the My Greeting voicemail message, follow these steps:

1. Press Menu> Settings>Call Settings>Voicemail>My Greeting.
2. The first time you do this, the default My Greeting is automatically downloaded to your phone.
3. Press Options and then select Play, Record New, or Reset Default.
  - **Play.** Select Play, and then “My Greeting” starts playing.
  - **Record New.** Select Record New, and then start recording.
  - **Reset Default.** You can reset “My Greeting” to the default Skype Voicemail greeting. Select Reset Default, press Yes to confirm, and then “My Greeting” is reset.

## Skype Tools

---

This section describes the Skype tools that you can access from this phone.

### Privacy

The privacy feature lets you choose which contacts can call you: anyone, only contacts, or only authorized users. To go to your privacy settings, follow these steps:

1. Press Menu>Settings>Privacy.
2. Scroll and select the kind of calls that you want to modify:
  - **Skype Calls.** You can allow calls from Anyone, My Contacts, or Authorized.
  - **SkypeIn Calls.** Calls from other Skype users.
  - **Blocked Users.** Calls from blocked users.
3. Scroll and select the new setting to save it.

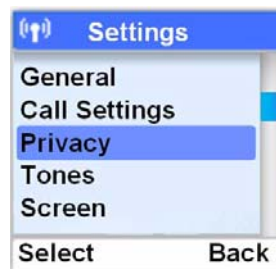

Figure 3-3

## Your Skype Profile

Your Skype profile stores information about you such as your name, gender, birthdate, phone numbers, and so on. Your profile has public and private details. Public details can be viewed by other Skype users, but private details cannot. You are not required to enter any information into your profile. However, it is a good idea to put in some details, such as your location, to make it easier for other users to locate you.

To view details and go to My Profile, follow these steps:

1. Press Menu>Status>My Profile.
2. Scroll and select the type of details that you want to view:
  - **Public Detail.** Information displayed to others such as Skype Name and Full Name.
  - **Private Detail.** This lets you work with up to three email addresses used by Skype. You can edit, remove, or add email addresses. Your friends can easily find you on the Skype network if they know your email address.



Figure 3-4

The current setting is displayed.

3. You can modify the settings. Press OK or Select when finished. The new setting is saved.

## Adding an Email Address

To add an email address, follow these steps:

1. Press Menu>Status>My Profile>Private Detail>Options>Add.
2. Enter the new email address.
3. Press OK when finished to save the new setting.

## Editing an Email Address

To edit an email address, follow these steps:

1. Press Menu>Status>My Profile>Private Detail.
2. Scroll to the email address that you want. Press Options.
3. Scroll to Edit. Press Clear to make corrections.
4. Press Enter when finished to save the new setting.



## Deleting an email address

To delete an email address, follow these steps:

1. Press Menu>Status>My Profile>Private Detail.
2. Scroll to the email address that you want. Press Options.
3. Scroll to Remove.
4. Press Yes to confirm and the email address is deleted.

## Signing in Automatically

The first time that you use the phone, you are asked if you want to sign in to your Skype account automatically. If you selected no, you can select Auto Sign in to use this feature.

To sign in automatically, follow these steps:

1. Press Menu>Settings>General>Auto Sign In.

The screen shows these choices:

- **Auto Sign In.** Automatically sign in to the Skype account that you used when you set up your phone.
- **Ask Password.** Enter a password when you sign in to Skype.

2. Select the new setting that you want, and press OK to save the new setting.

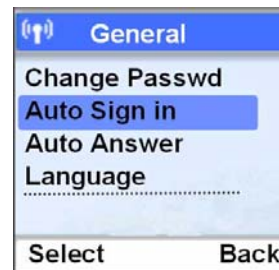



Figure 3-5

## Viewing or Changing Your Skype Status











You can view or change your Skype status from the Status menu.



**Tip:** For a shortcut to the Status menu, press  (Up) during standby.

The following table describes the Skype Status icons.

**Table 3-1. Skype Status Icons**

	Silent	Turn off the telephone ringer.
	Offline	You are not logged into Skype. When you are offline you can choose to have your calls forwarded to another phone, or be redirected to Skype Voicemail.
	Call forwarding	
	Voicemail	
	Online	This is the automatic status setting when you are on Skype and shows you are available.
	Skype Me	Invite users who are not in your contacts list to contact you.
	Away	You are logged in to Skype, but probably will not answer a call.
	Not Available	You are logged in to Skype, but are not available to answer your phone.
	DND (Do not disturb)	All ringers are turned off for Skype and SkypeIn calls. Your handset will not ring when it receives Skype calls
	Invisible	You are online, but do not want other Skype users to know. You appear to be offline to other Skype users.

To change your Skype status, follow these steps:

1. Press Menu>Status>Change Status.
2. Scroll and select the new setting. The new setting is saved.

## Changing Your Skype Password

Your password provides security to your Skype account, and it ensures no one can access your account. This password is different from the system PIN of this phone.

To change your Skype password, follow these steps:

1. Press Menu>Settings>General>Change Passwd.
2. Type your password and press OK.
3. Type your new password and press OK.
4. Retype your new password for verification.
5. Press OK. The new setting is saved.

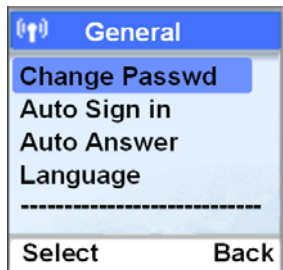

**Figure 3-6**

## Updating Skype Software

Skype provides periodic updates on its software. You can choose to check for updates manually, or to have your phone notify you when an update is available.

	<b>Note:</b> Some updates are optional and can be downloaded at anytime. Note that some updates are required and must be accepted immediately in order to continue using the phone.
-----------------------------------------------------------------------------------	-------------------------------------------------------------------------------------------------------------------------------------------------------------------------------------

To update Skype software, press Menu>Settings>Advanced>SW Update.

You can choose:

- **SW Update.** Check for updates manually. If an update is available, follow the onscreen instructions
- **Auto Update.** Set the phone to notify you of new Skype software updates. This takes less time than checking for new updates manually.

	<b>Note:</b> With Auto Update, your phone displays a message when there is a new update. You will be able to choose to update the software right away or to have your phone remind you again at a later time.
-----------------------------------------------------------------------------------	---------------------------------------------------------------------------------------------------------------------------------------------------------------------------------------------------------------



# Chapter 4

## Landline Calling

You can use your phone to make Skype calls over the Internet or to make landline calls with your regular phone line.



**Note:** Your phone stores the outgoing, incoming, and missed calls. For information about calling from the Call History, see [“Personalizing Your Handset Display”](#) in [Chapter 6](#).

### Making a Landline Call

---

There are two ways that you can make a landline call. You can use direct dialing, or select the landline option.



#### Direct Dialing

To use direct dialing, follow these steps:

1. Press .
2. Listen for a dial tone.
3. Use the keypad to dial the number.
4. Wait for the call to connect, ring, and be answered.
5. Press End to end the call.

## Selecting the Landline Option

To select the landline option, follow these steps:

1. Use the keypad to dial the number.
2. Press Options>Landline, and then press .
3. Wait for the call to connect, ring, and be answered.
4. Press End  to end the call.

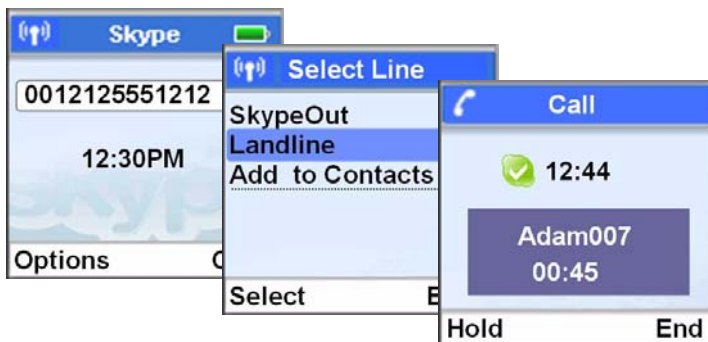



Figure 4-1

## Redialing the Last Number

Press  twice within one second. The last number that you called is dialed out using the same line as before.



**Tip:** Last Landline Number. Press , and then press Redial. The last number that you called using the landline will be dialed out.



## Making a Second Landline Call During a Call



**Note:** Second call service only applies to calls using the landline. Toggling between calls may not be available in all countries. Consult and subscribe from your landline service provider.

1. Press .
 

The current caller is put on hold.
2. Dial the number that you want.
 

The number displays on the screen and is dialed out.
3. If your landline allows toggling, press  to toggle between the two callers OR Press  to end the current call and return to the other caller.

## Receiving Calls

When you receive a call, your phone rings. Press  to answer the call. For caller ID service, contact your landline service provider.



**Tip: Missed Call Alert.** When a call is missed, your phone displays You have Missed Calls. Press View for more options.

## Auto Answer

With Auto Answer you can answer an incoming call by simply picking up the handset from the charging cradle. You do not need to press a button to answer the call.

To set up Auto Answer:

1. Press Menu>Settings>General>Auto Answer.
2. Scroll and select On.

The new setting is saved.

## Turning off the Ringer During a Call



When a landline call comes in, you can turn off the ringer during the current call. Press  to turn off the ringer for the current incoming landline call.

## Answering a Second Landline Call during a Call



**Note:** For second call service, contact your landline service provider.

During a landline call, your phone sounds a short beep periodically to notify you of another incoming landline call.

1. Press  to answer the call. You have put the first call on hold, and you are now connected to the second call.
2. Press  to toggle between the two callers OR  
Press  to end the current call and return to the other caller.

## Landline Voicemail

---

You can use landline voicemail service and Skype Voicemail.



**Note:** For information about landline voicemail service or to find out your service provider's phone number, consult your service provider. For information about Skype Voicemail, go to [www.skype.com](http://www.skype.com).

A voicemail icon  shows when there is a voicemail waiting for you.

You can call your landline voicemail, edit the phone number for the service provider, or delete the phone number for the service provider.

To go to the Landline Voicemails menu:

1. Press Menu>History>Voicemails>Landline VM.

You can work with two landline voicemail phone numbers, VM Number 1 and VM Number 2.

2. Scroll to the service provider that you want.
3. Press Options. You can use Call, Edit, or Delete.
  - **Call.** Call your voicemail service provider to retrieve your voicemails. Wait for voice instructions
  - **Edit.** Edit the landline voicemail service provider phone number. Edit the number and press Enter.
  - **Delete.** Delete a phone number for a landline voicemail service provider. Press Yes to confirm.



### Entering Text and Numbers

---

You can use the alphanumeric keys on your phone to enter text and numbers. You can enter lowercase, uppercase, numeric characters, and symbols.



To enter text, numbers, or symbols:

1. Press  to change to uppercase, lowercase, or numeric entry.

The lower right corner displays the method you have currently selected. A for uppercase; a for lowercase; 1 for numeric mode.

2. Find the button with the character that you want.
3. Press it as many times as needed for the character to display on the screen.

The preview area shows the available characters of the button.

	<b>Tip:</b> Use  (Left or Right) to move the cursor. To enter symbols, press  .
------------------------------------------------------------------------------------	-------------------------------------------------------------------------------------------------------------------------------------------------------------------------------------------------------------------------------------------------------

- To erase a single character, press Cancel.
- To erase all characters, press and hold Cancel.

## Contact Options

---

The Contacts screen shows your contacts in alphabetical order.

To view or work with contacts, follow these steps:

1. Press Menu>Contacts.

For a description of status, see [“Viewing or Changing Your Skype Status”](#) on page 3-9.

2. You can select Options to call a contact, see more detail, or work with contacts.



Figure 5-1

On the Contacts screen, the following features are available:

- **Call.** Choose the type of call that you want to make: Skype, SkypeOut or Landline.
- **Send Voicemail.** You can send Skype Voicemail or landline voicemail. See [“Skype Voicemail”](#) in Chapter 3 and [“Landline Voicemail”](#) in Chapter 4.
- **View Profiles.** View the Skype profile of a contact.
- **Rename.** Change the display name of a contact. Edit the name and press OK. Your edited contact is saved.
- **Remove.** Remove a contact from the list. A confirmation request is displayed. Press Yes to confirm. The contact is removed.
- **Block.** Block a user from contacting you. You will always appear as offline to the user that you have blocked. See [“Blocking a Contact”](#) on page 5-4 and [“Unblocking a Contact”](#) on page 5-4.
- **Request Auth.** Request authorization from a Skype Contact.

## Adding Contacts

**Note:** Your phone can store a total of 500 Skype and SkypeOut contacts. If you try to add more, the phone displays a Memory Full message. Delete unnecessary contacts before adding new ones.

To add a Skype or SkypeOut Contact, follow these steps:

1. Press Menu>Add Contact>Skype.
2. Choose Skype or SkypeOut:
  - **Skype.** Enter the Skype name or full name. To let this contact see when you are online, select Yes.
  - **SkypeOut.** Enter the name and phone number (including international calling code and area code).
3. Press OK.



Figure 5-2

**Note:** Contacts with identical numbers cannot be saved. Press  to change to upper case, lower case, or numeric entry

The new contact is added to the contact list. For Skype contacts, the phone sends a request to the contact for authorization.

## Finding a Contact

You can search the contact list by scrolling or by quick filtering.

- **Scrolling.** While at the contact list, press  (Up or Down) to scroll.
- **Quick filtering contacts.** While at the contact list, press the button with the letter that you want to search. For example, if you want to search a contact starting with N, press [6] twice. Contacts that begin with the letter N display in alphabetical order.

## Searching for a Skype User

You can search for a Skype user that is not on your contact list. After finding the user, you can make a call, view the profile or add the user to your contact list.

To search for a Skype user, follow these steps:

1. Press Menu>Search.
2. Enter the Skype name or full name and press OK.  
A list of matching names is displayed.
3. Scroll to the user that you want, and then press Options for more functions.

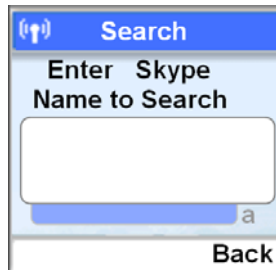

Figure 5-3

## Blocking a Contact

You can block a user from contacting you. You will always appear as offline to the user that you have blocked. You can unblock the contact if you change your mind.

To block a contact, follow these steps:

1. Press Menu>Contacts.
2. Scroll and select the contact.
3. Press Options>Block.
4. Press Yes to confirm.

## Unblocking a Contact

To unblock a contact, follow these steps:

1. Press Menu>Settings>Privacy>Blocked Users.
2. Scroll to the contact that you want to unblock.
3. Press Options>Unblock.  
The contact is unblocked.

# Chapter 6

## Advanced Features

Your phone supports both Skype line and landline calls. A Skype call is a call using the Skype line. A landline call is a call using your regular phone line.

### Call History

---

Your phone stores the call history of all the missed, outgoing, and incoming calls. The call history includes the caller name, number, call time, and date. Your phone also saves a history of received Skype Voicemail, new requests, and landline voicemail. our phone will not store any call history if you are not signed in to Skype.

	<b>Note:</b> When you sign out of Skype, your phone clears all the call history, voicemails, and new requests saved under your account. When you or another user signs in to Skype again, your phone starts saving the new call history under the signed-in account.
--	----------------------------------------------------------------------------------------------------------------------------------------------------------------------------------------------------------------------------------------------------------------------

### Call History Options

From the Call History screen, you can press Options to use these features:

- **Call.** Return a call in the call history. See [“Viewing Call Records” on page 6-2.](#)
- **Send Voicemail.** Send voicemail to a call in the call history.
- **Details.** View details about a caller.
- **Delete.** Delete a call from the call history.
- **View Profile.** View the Skype profile for a caller.
- **Add to Contact.** Add a phone number from the call history to your Contact list. See [“Adding a Call Record to Your Contact List” on page 6-3.](#)
- **Clear List.** Delete all records of a call list. See [“Deleting All Records of a Call List” on page 6-4.](#)

## Viewing Call Records

To view call records, follow these steps:

1. Press Menu>History.



**Figure 6-1**

2. Scroll and select the call list that you want.



Call List	Description
All Calls	All missed, incoming, and outgoing calls.
Missed Calls	Calls that you received but did not answer.
Incoming	Calls that you received and answered.
Outgoing	Calls that you made.

3. Scroll to the call record that you want.
4. To view call record details, press Options>Details.

## Making a Call from the Call History

Your phone stores the outgoing, incoming, and missed calls.

To call from the Call History, follow these steps:

1. Press Menu>History.
2. Scroll and select the call list that you want.
3. Scroll to the record that you want.
4. Press  to dial the number on the preferred line.
5. To end a call, press  or place the handset on the charger.

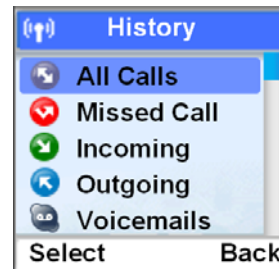

Figure 6-2

## Adding a Call Record to Your Contact List

### Adding a Skype Contact

To add a Skype contact, follow these steps:

1. Select a call record.
2. Press Options>Add To Contact and your record is saved.

### Adding a SkypeOut Contact

To add a SkypeOut contact, follow these steps:

1. Select a call record.
2. Press Options>Add to Contact.
3. Edit the name if necessary. Press OK.
4. Edit the number if necessary.
5. Press OK and your record is saved.

## Deleting a Call Record

To delete a call record, follow these steps:

1. Select a call record.
2. Press Options>Delete.
3. Press Yes to confirm. The record is deleted.

## Deleting All Records of a Call List

To delete all records of a call list, follow these steps:

1. Press Menu>History.
2. Go to the call list that you want.
3. Press Options>Clear List.
4. Press Yes to confirm. All records are deleted.

## Intercom and Conference Calls

---

An intercom call is a call to another handset that shares the same base unit. A conference call involves conversation between other handset(s) and outside caller(s).



**Tip:** Use  (Up or Down) to navigate the menus.

## Calling Another Handset



**Note:** An intercom call can only involve two handsets that share the same base unit.

To call another handset, follow these steps:

1. Press .
2. Scroll to the handset that you want.



3. Press Call. Wait for the other party to answer your call.
4. Press  to cancel or end the intercom call.



**Tip:** To customize your intercom ringer, see [“Personalizing Your Phone’s Sound”](#) on page 6-7.

### While You Are on the Phone

While talking on the phone on the Skype line or landline, you can call another handset.



1. Press  during the call.
2. Scroll to the handset that you want.
3. Press Call. Wait for the other party to answer your call.

### Returning to the Outside Caller

Press End during the intercom call. You are now connected to the outside caller.

### Transferring a Call

To transfer a call, follow these steps:

1. Press  during a call.
2. Scroll to the handset that you want. Press Call.
3. Press  after the other party answers your call. The outside call is now transferred to the other handset.

### Making a 3-Way Conference Call

A 3-way conference call is a call between you, an outside caller, and another handset in your house. Use this feature when you are talking on the phone with an outside caller, and you want to involve someone using another handset in this conversation.

**Note:** A 3-way conference call requires two handsets that share the same base unit.

To make a 3-way conference call, follow these steps:

1. Press  during your call with the outside caller.
2. Scroll to the handset that you want.
3. Press Call. Wait for the other person to answer your call.
4. Press Conf.

You are now on a 3-way conference call.

5. Press  to end the conference call.

## Predialing



---

You can enter a phone number or Skype contact name before pressing the Call button. For Skype contacts, the number will be dialed out on the preferred line.



**Tip: SkypeOut Shortcut.** Press  twice to call from SkypeOut. The preferred line setting will be ignored.

To predial, follow these steps:

1. Enter the phone number or Skype contact name.
  - Press and hold  to enter a pause after a digit has been entered. P displays on the screen.
  - Press Clear to erase a digit.
  - Use  left or right to move the cursor.
2. Press . The number is dialed out on the preferred line. For details on preferred line, see [“Assigning a Preferred Line for a SkypeOut Contact” in Chapter 3.](#)

## Personalizing Your Handset Display

---

You can change the display of the handset to suit your needs and preferences.



### Setting the Language

The first time that you use the phone, you set the language shown on the phone display. To change the language, follow these steps:

1. Press Menu>Settings>General>Language.
2. Scroll to the new setting.
3. Press OK when finished to save the new setting.

### Changing the Screen Settings

You can change the brightness, backlight, and contrast of the screen. To go to the Screen settings, follow these steps:

1. Press Menu>Settings>Screen.
  2. Scroll and select the setting that you want to change:
    - **Brightness.** This settings specifies the timeout period for the display backlight. Press  (left or right) to adjust the brightness.
    - **Backlight.** Scroll to the new setting.
    - **Contrast.** Press  (left or right) to adjust the contrast.
- Press OK when finished and the new setting is saved.

## Personalizing Your Phone's Sound





---

You can adjust the sound settings, change the ring tones for your phone, or turn off ringers.

### Adjusting the Sound Settings

The Cordless Internet Phone has several sound settings that you can adjust.

- **Earpiece volume.** Press  (up or down) to adjust the volume during a call.

- **Muting and Un-muting.** The mute feature turns off the microphone in the phone so that the caller cannot hear you. You will still be able to hear the caller.
  - To mute the microphone, press  during a call.
  - When the microphone is muted, press . The caller can now hear you again.
- **Hands Free Speaker.** You can talk on the phone without holding the handset.
  - To turn on the hands free speaker, press  during a call. Start talking.
  - Press  again to turn off the speaker.
- **Headset (not included).** If you have a headset, you can plug it into the headset jack at the side of your handset.

## Setting the Ring Tones

You can personalize your phone's sound by setting the ringer melody, keypad tone, and ringer volume on the Tones menu.

To go to the Tones menu, press Menu>Settings>Tones.

You can change these settings:

- **Ring Type.** Your handset has four ring types: Skype, SkypeIn, Landline, and Intercom. Select the ring type that you want. Scroll and select a melody, and then press OK. The new settings is saved.
- **Ring Tone.** Scroll and select a melody, and then press OK. The new settings is saved.
- **Ring Volume.** Press  (Up or Down) to scroll to a volume level, and then press Select.
- **Notification.** Scroll to the new setting, and then press Select when finished.
- **Keypad Tone.** The keypad tone is the sound you hear when you press a button on your handset. Scroll and select the new setting.
- **Confirmation.** You hear the confirmation tone when you place the handset on the charger, or after certain events.

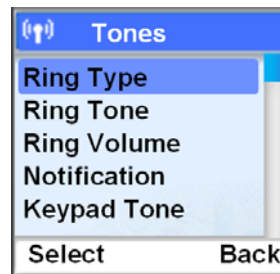

Figure 6-3

## Turning Off All the Ringers with Silent Status

You can turn off the ringers for all the incoming calls including Skype, landline, and intercom calls.



**Tip:** For a shortcut to the Status menu, press  (up) during standby.

To turn off all ringers, follow these steps:

1. Press Menu>Status>Change Status>Silent.

All the ringers are turned off.



**Note:** To turn the ringers back on, go to Change Status>Sounds On>Select. For details on the ringer setting, see [“Personalizing Your Phone’s Sound”](#) on page 6-7.



# Chapter 7

## Settings and Maintenance

### Settings

---

Use the Settings menu to change call settings and settings for the handset.

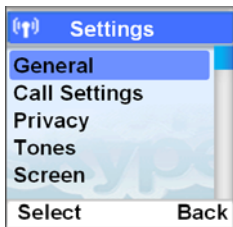



Figure 7-1

### Country Code

The country code is the international calling code for a country (for example, '1' for Canada). When you first set up the handset, you entered a country code.

To change the country code:

1. Press Menu>Settings>Call Settings>Country Code.
2. Edit the country code. Press Clear to make corrections.
3. Press OK when finished. The new setting is saved.

	<b>Note:</b> After you set up your country code, your handset's power switches off. It will switch back on in a few seconds after updating the country settings.
-------------------------------------------------------------------------------------	------------------------------------------------------------------------------------------------------------------------------------------------------------------

## Area Code

The area code feature automatically adds or removes the area code of an outgoing call based on the country setting for the handset. You can define an area code up to five digits.

	<b>Note:</b> The country code must be correct for the area code feature to work properly. See <a href="#">“Setting up the Handset” in Chapter 2.</a>
--	------------------------------------------------------------------------------------------------------------------------------------------------------

To set the area code follow these steps:

1. Press Menu>Settings>Call Settings>Area Code.
2. Enter your area code, or press Clear to erase it.
3. Press OK when finished.

The new setting is saved.

## Time and Date

Set the time zone before initial use of the phone. Once you have connected to the Internet, your phone updates the clock automatically according to your time zone setting. After resetting the phone, you may have to set the time zone again.

	<b>Note:</b> If you use this menu to set the time or date manually, your phone will use this new setting. It will stop automatic update until your base power is reset.
--	-------------------------------------------------------------------------------------------------------------------------------------------------------------------------

To set the time and date, follow these steps:

1. Press Menu>Settings>Time & Date.

You can adjust these settings:

- **Time.** You do not need to set the time. If you set the Time Zone, then the phone will automatically find the time on the Internet.
- **Time Zone.** GMT (Greenwich Mean Time), or the number of hours + or - for GMT.
- **Daylight Time.** Choose Standard or Daylight Time (Daylight Savings Time).
- **Time Format.** Choose 12 hour or 24 hour.
- **Time Separator.** The time separator is a symbol such as a colon that separates the hour and minute (i.e. 18:30). Your phone supports two styles: colon and period (: .).



- **Date Format (Month/Day/Year).** The default is MM/DD/YYYY.
  - **Date Separator.** The date separator is a symbol such as a slash that separates the month, day and year (for example, 08/25/2006). Your phone supports three styles: slash, colon, and period (/ : .).
2. Press OK when finished.  
The new setting is saved.

	<b>Note: Automatic Update.</b> Once you have connected to the Internet, your phone updates the clock automatically according to your time zone setting.
--	---------------------------------------------------------------------------------------------------------------------------------------------------------

## Changing the System PIN

The system PIN is used for registering, deleting handsets, and protecting the access rights to some of the other menus. The default system PIN is 0000. You can personalize the PIN for greater security.

1. Press Menu>Settings>Handset>Change PIN.
2. Enter the system PIN. Press Enter to confirm. Press Clear to make corrections.
3. Enter the new system PIN. Press Enter.
4. Re-enter the new system PIN again for verification.
5. Press Enter. The new setting is saved.

	<b>Note:</b> Write down your PIN and save it for future use. If you have forgotten the PIN, call your manufacturer for assistance.
--	------------------------------------------------------------------------------------------------------------------------------------

## Resetting to Default Settings

---

The default settings are the original factory settings of your phone. You can reset your phone settings to factory default. These settings are shown in [“Default Factory Settings” in Appendix A](#). You can reset all the settings, but keep the network settings.

1. Press Menu>Settings>Advanced>Reset Device.
2. Scroll and select either Reset All or Keep Network.

- **Reset All.** Reset all the settings including the network settings.
  - **Keep Network.** Reset all the settings except the network settings.
3. Enter the system PIN. Press Clear to make corrections.
  4. Press Yes to confirm.
  5. The settings will reset. Your handset's power switches off. It will switch back on in a few seconds after updating all the settings.

## Registering Your Handset



---

Registration lets your base unit and handsets communicate. Your handset must be linked to the base in order to make calls and to use many of features on the phone.

Your handset is already registered unless you have bought an extra handset individually, or you have de-registered a handset. For additional handsets, see [“Registering Your Handset\(s\) with an Additional Base” on page 7-5](#). If the handset is not registered, it displays “Unregistered.”

	<b>Note:</b> Your base unit can register up to four handsets. After registering four handsets, your base unit registration memory is full. If you try to register an additional handset, the registration process will not complete.
-----------------------------------------------------------------------------------	--------------------------------------------------------------------------------------------------------------------------------------------------------------------------------------------------------------------------------------

Follow the steps below to register your handset.

1. Press Menu>Settings>Handset>Register.
2. Enter the system PIN (Default: 0000). Press Clear to make corrections.
3. Press Enter to confirm. Your handset starts searching for the base.
4. Press  on the base unit until the LED starts flashing.
5. The handset registers to the particular base unit, and shows the signal icon  .

## Registering Your Handset(s) with an Additional Base

**Note:** Make sure that you have configured the language, country code, and area code of your phone before registering extra handsets.

This section shows you how to register your handset to additional base units. If your handset displays Unregistered, see to [“Registering Your Handset” on page 7-4](#).

1. Press Menu>Settings>Handset>Register.
2. Enter the system PIN (Default: 0000). Press Clear to make corrections.
3. Press Enter to confirm. Your handset starts searching for the base.
4. Press  on the base unit until the LED starts flashing.

## Selecting a Base Unit

You can switch your handset between different base units if your handset has registered to these base units. You can set up the handset to automatically connect to the closest base unit. You can also set up the handset to only connect to a fixed base unit you have specified.

**Note:** Your handset must be registered to a base unit before you can select that base unit.

1. Press Menu>Settings>Handset>Base.
2. Scroll to the base unit that you want, or select Auto if you want your handset to automatically connect to the closet base unit.
3. Press Select.  
The new setting is saved.

## Deleting a Handset

Use one handset to delete (de-register) another handset that shares the same base unit.

1. Press Menu>Settings>Handset>De-register.

2. Scroll to the handset (number) that you want to delete. Press Enter.



**Tip:** The handset number displays beside the word “Skype” during standby. For example, Skype (1)

3. Enter the system PIN. Press Clear to make corrections.
4. Press Enter.

The handset is deleted.

## Advanced Landline Calling Features

---

This section describes the call-related features that apply to the landline only.

### Dial Mode

Dial mode is the telephone signal used in your country. Your phone supports tone (DTMF) and pulse (rotary) dialing. During installation, you set up your phone for use in your country. For details, consult your service provider.

To go to dial mode, follow these steps:

1. Press Menu>Settings>Advanced> Landline>Dial Mode.
2. Scroll to the new setting.
3. Press OK.

The new setting is saved.



**Tip:** If your phone is set to pulse dialing, press and hold **d** during a call for temporary tone mode. The display shows d. Digits entered after the d are sent out as tone signals (on this call only).

### Recall Selection

Recall is a signal that is sent when using some of the calling features such as making or answering a second call. Your phone supports different recall signals. You can make changes depending on the requirements. Your phone is already set up for use in your country. For details, consult your service provider.

To select recall duration, follow these steps:

1. Press Menu>Settings>Advanced>Landline>Recall.
2. Scroll to the new setting and press OK.

The new setting is saved.

## **Setting a Pause**

A pause is a break you can enter when making a call. A pause is used for calls such as PABX and operator services. Your phone supports different pause durations. For details, consult your service provider.

To set the pause, follow these steps:

1. Press Menu>Settings>Advanced>Landline>Pause.
2. Scroll to the new setting.
3. Press OK.

The new setting is saved.

## **Category Number**

This section only applies to models with Category number support. Some telephone providers send a category number along with the CallerID. Consult your service provider on category number handling.

To call back from the history properly, change setting to Yes if your telephone service provider sends out a category number, or change setting to No if the category number is not sent.

To set the category number, follow these steps:

1. Press Menu>Settings>Advanced>Landline>Cat. Number.
2. Scroll to the new setting and press OK.

The new setting is saved.

## Network Settings

---

This section describes the information on viewing and changing the Internet network settings of your phone. You do not need to configure the network after setting up the phone. This section is recommended for advanced users who want to configure the network with their static IP (Internet Protocol) address.

	<b>Note:</b> Incorrect network settings will affect Skype usage on this phone. Consult your network administrator or service provider before making any changes to the network settings.
--	------------------------------------------------------------------------------------------------------------------------------------------------------------------------------------------

### Viewing Network Settings

To view the network settings, follow these steps:

1. Press Menu>Settings>Information.
2. Scroll to view the information.

### Changing Network Settings

To change the network settings, follow these steps:

1. Press Menu>Settings>Network.
2. Scroll and select the setting that you want, and follow the onscreen instructions.
  - **DHCP.** The Cordless Internet Phone uses Dynamic Host Configuration Protocol (DHCP) by default, which is correct for most customers. If you configure a static IP, this disables DHCP. Press Back when finished.
  - **PPPoE.** If your Internet service provider requires you to use Point-to-Point Protocol over Ethernet (PPPoE), you can configure your user name and password for the PPPoE connection.
  - **Static IP.** You can configure the network to use a static IP.
  - **Reset Network.** This resets the network with the changes that you made.

## Web Page Configuration

You can configure some of the network settings, Skype settings, system upgrade, and administrative settings from the Web page. You do not need to configure most of these settings after setting up the phone. This section is recommended for advanced users only.

**Note:** Incorrect network settings will affect Skype usage on this phone. Consult your network administrator or service provider before making any changes to the network settings.

## Accessing the Web Page

### Minimum System Requirements

The minimum system requirements to access the Web page are:

- SPH200D set
- Router
- Computer with a Web browser
- Internet connection

Make sure that your phone is properly connected and set up sharing the same network with your computer as shown below.

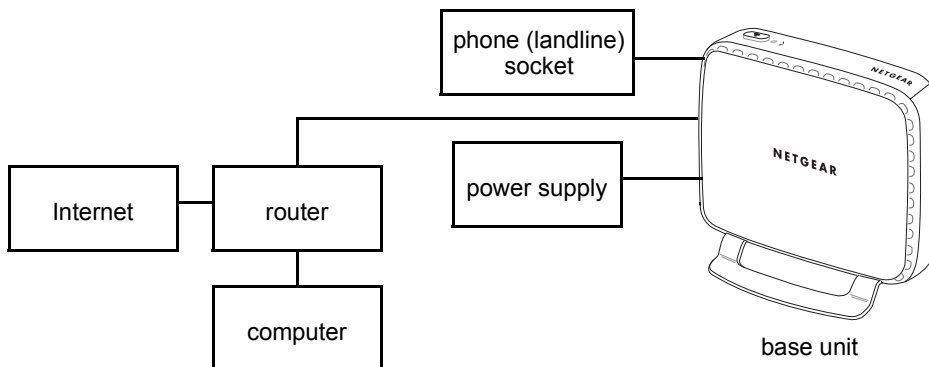

Figure 7-2

## Accessing the Web Page

To access the Web page, follow these steps:

1. Open a Web browser.
2. Enter your phone's IP address at the address bar. An authentication window pops up.



**Tip:** To find your phone's IP address, see "[Viewing Network Settings](#)" on page 7-8.

3. Enter the user name and password. The default user name is **admin** and the default password is **password**.

After verifying your user name and password, you will see the configuration home page.

- **Home page.** The home page shows your current system and network settings.
- **Network page.** The network page shows your current Internet connection type and Ethernet speed. You can make changes to these settings on this page.
- **Skype page.** The Skype page shows your current Skype status. You can create a new Skype account or sign in to Skype from this page.
- **System page.** You can upgrade your phone's operating system from this page. You will first need to download the latest software from the NETGEAR Web page, at [www.netgear.com](http://www.netgear.com).
- **Administration page.** You can change the Web page access password on this page. You can also reset your phone to factory default feature and network settings.

## Troubleshooting

**Table 7-1. Troubleshooting Tips**

Problem	Tip
No dial tone on landline.	<ul style="list-style-type: none"> <li>• Check the phone and power connections.</li> <li>• The handset may be out of range. Move closer.</li> <li>• The battery capacity may be low. Charge battery.</li> </ul>
Signal icon flashing.	<ul style="list-style-type: none"> <li>• The handset may be out of range. Move closer.</li> <li>• If the handset displays Unregistered, it is not registered. Register the handset. See "<a href="#">Registering Your Handset</a>" on page 7-4.</li> </ul>



**Table 7-1. Troubleshooting Tips (continued)**

No parking tone.	<ul style="list-style-type: none"> <li>• Check the power connections of the charger.</li> <li>• The handset may not be placed properly. Try again.</li> <li>• Charging contacts may be dirty. Clean contacts with a damp cloth.</li> <li>• Turn on the handset tone. See <a href="#">“Personalizing Your Handset Display” in Chapter 6</a>.</li> <li>• Switch on the handset’s power. See <a href="#">“Powering Your Handset On and Off” in Chapter 1</a>.</li> </ul>
Handset on the charger does not charge.	<ul style="list-style-type: none"> <li>• The battery may be defective. Purchase new batteries from your dealer.</li> <li>• Check that the batteries are inserted correctly.</li> <li>• Make sure that the handset is placed properly on the charger. The battery icon is animated while charging.</li> </ul>
No display.	<ul style="list-style-type: none"> <li>• Check that the battery is charged.</li> <li>• Check the connections.</li> </ul>
Bad audio (crackles, echo).	<ul style="list-style-type: none"> <li>• The handset may be nearly out of range. Move closer.</li> <li>• The phone may be interfered by nearby electrical appliance. Move the base unit to a different location.</li> <li>• The phone may be at a location with thick walls. Move the base unit to a different location.</li> </ul>
Handset does not ring.	Check that the handset ringer is turned on. See <a href="#">“Personalizing Your Handset Display” in Chapter 6</a> .
Caller ID does not display.	<ul style="list-style-type: none"> <li>• Caller ID service may not be activated. Check with your service provider.</li> <li>• The caller’s information may be withheld or unavailable.</li> </ul>
Cannot make or answer a second call.	<ul style="list-style-type: none"> <li>• Second call service may not be activated. Check with your service provider.</li> <li>• For landline calling, check that the recall selection is correct. See <a href="#">“Recall Selection” on page 7-6</a>.</li> </ul>



# Appendix A

## Default Factory Settings and Technical Specifications

### Default Factory Settings

---

Table A-1. Default Factory Settings

Item	Default Setting
General Settings	Time Zone: GMT Date: 1 Jan 2006 Time: 12:00 Date Format: MM-DD-YYYY or DD-MM-YYYY Time Format: 12 hour Date Separator: - Time separator: : Auto Answer: No LCD Contrast: Mid Level LCD Brightness: Mid Level Preferred Line: Always Ask Auto Sign in: Yes Dial Mode: Tone Recall Duration: Recall 1 Pause Selection: Pause 1 Area Code number: Empty Skype User Name: Empty Skype Password: Empty
Sounds Setting	Skype Ring Melody: Melody 2 Landline Ring Melody: Melody 1 SkypeIn Ring Melody: Melody 1 Intercom Ring Melody: Melody 1 Ring Volume: 3 Receiver Volume: 3 Ring Type: Ringing Notification Tone: On Keypad Tone: On Confirmation Tones: On

**Table A-1. Default Factory Settings**

Item	Default Setting
System Setting	PIN Code: 0000 Country: Empty
Network Setting	DHCP: Enabled Network Proxy Option: Auto Network Proxy Host: Auto Network Proxy Port: Auto Proxy Authentication: Disabled Authentication User Name: Empty Authentication Password: Empty Application Port: Skype default Alternate Application Ports: Skype defaults

## Technical Specifications

---

Technical Specifications	
Antenna	Internal
Frequency	<ul style="list-style-type: none"> <li>• DECT (1.8 GHz)</li> <li>• UPCS (1.9 GHz) North America</li> </ul>
Emissions	FCC, CE
Interface	<ul style="list-style-type: none"> <li>• Ethernet (RJ-45)</li> <li>• PSTN (RJ-11)</li> </ul>
Weight with battery	<ul style="list-style-type: none"> <li>• base station: 235g</li> <li>• handset: 130g with batteries</li> </ul>
Dimensions (H x W X D)	<ul style="list-style-type: none"> <li>• base station: 137 x 126.5 x 70 mm</li> <li>• handset: 141.5 x 46 x 26 mm</li> </ul>
Operating temperature	32°–104°F (0°–40°C)

## Power and Safety

### Power Requirements

To install the Cordless Internet Phone with Skype Model SPH200D, you need the following:

- North America:
  - 120 volts, single-phase AC.
  - This product requires an electrical supply of 120 volts, single-phase alternating current, excluding IT installations defined in standard UL 60950-1.
- Europe:
  - 220-230 volts, single-phase AC.
  - This product requires an electrical supply of 220-230 volts, single-phase alternating current, excluding IT installations defined in standard EN 60950-1.

	<b>Warning:</b> The electrical network is classified as dangerous according to criteria in the standard EN 60950-1. The only way to power down this product is by unplugging the power supply from the electrical outlet. Ensure the electrical outlet is located close to apparatus and is always easily accessible.
-----------------------------------------------------------------------------------	-----------------------------------------------------------------------------------------------------------------------------------------------------------------------------------------------------------------------------------------------------------------------------------------------------------------------

	<b>Warning:</b> Use only the adapter supplied with this equipment. Incorrect adapter polarity or voltage can seriously damage the unit.
------------------------------------------------------------------------------------	-----------------------------------------------------------------------------------------------------------------------------------------

**Table A-2.**

North America		Europe
Handset Charger Adapter Input: 120VAC 60Hz Output: 7.5VDC 150mA		Handset Charger Adapter Input: 230VAC 50Hz Output: 7.5VDC 150mA
	OR	
Base Unit Adapter Input: 120VAC 60Hz Output: 7.5VDC 500mA		Base Unit Adapter Input: 230VAC 50Hz Output: 7.5VDC 500mA

## Batteries



**Danger:** NIMH batteries must be disposed of in accordance with the applicable waste disposal regulations.

- Do not dispose of the batteries in a fire, as they can explode.
- Do not open or mutilate the battery. Released electrolyte is corrosive and can cause damage to the eyes or skin. It can be toxic if swallowed.
- Avoid contact with metal objects when handling the battery. These objects could make short circuit across the battery terminals that could cause the batteries or conductor to overheat resulting in burns.
- Do not attempt to recharge the battery cell by heating it. Sudden release of battery electrolyte can cause burns or irritation to the eyes or skin.
- Observe the proper polarity, or direction, of any battery. Reverse insertion of the battery cell can result in leakage or explosion.
- Remove the battery cells if you do not plan to use the product for several months at a time.
- Discard any “dead” batteries because they are likely to leak into the product.
- Do not store this product or the battery in a high temperature area. Battery stored in a freezer or refrigerator should be protected from condensation during storage and defrosting. Battery should be stabilized at room temperature before using.
- Your battery is rechargeable and can be recycled once it outlives its usefulness. Depending upon your local and state law, it might be illegal to dispose of this battery into a municipal waste system. Check with your local solid waste company for more information on your recycling options for the battery cells.

# Appendix B

## Related Documents

This appendix provides links to reference documents you can use to gain a more complete understanding of the technologies used in your NETGEAR product.

<b>Document</b>	<b>Link</b>
Internet Networking and TCP/IP Addressing	<a href="http://documentation.netgear.com/reference/enu/tcpip/index.htm">http://documentation.netgear.com/reference/enu/tcpip/index.htm</a>
Wireless Communications	<a href="http://documentation.netgear.com/reference/enu/wireless/index.htm">http://documentation.netgear.com/reference/enu/wireless/index.htm</a>
Preparing a Computer for Network Access	<a href="http://documentation.netgear.com/reference/enu/wsdhcp/index.htm">http://documentation.netgear.com/reference/enu/wsdhcp/index.htm</a>
Virtual Private Networking (VPN)	<a href="http://documentation.netgear.com/reference/enu/vpn/index.htm">http://documentation.netgear.com/reference/enu/vpn/index.htm</a>
Glossary	<a href="http://documentation.netgear.com/reference/enu/glossary/index.htm">http://documentation.netgear.com/reference/enu/glossary/index.htm</a>





## Free Manuals Download Website

<http://myh66.com>

<http://usermanuals.us>

<http://www.somanuals.com>

<http://www.4manuals.cc>

<http://www.manual-lib.com>

<http://www.404manual.com>

<http://www.luxmanual.com>

<http://aubethermostatmanual.com>

Golf course search by state

<http://golfingnear.com>

Email search by domain

<http://emailbydomain.com>

Auto manuals search

<http://auto.somanuals.com>

TV manuals search

<http://tv.somanuals.com>