



Sprint Printable User Guide

A downloadable, printable guide to your device's features.

NETGEAR® 341U USB Modem



Available applications and services are subject to change at any time.

Table of Contents

Get Started	1
Your Device	1
Package Contents	2
Care and Maintenance	2
System	2
Starting Your Device for the First Time	3
Getting Help	3
Visiting the Sprint Website	4
Contacting Sprint Customer Service	4
Device Basics	5
3G and LTE Networks	5
Mobile Broadband Information and Settings	5
Signal Information	6
Internet Connection Information	6
Restarting the Device	6
OLED Display	7
Micro-SIM	7
External Antennas	9
Alerts	9
Your Network Connection	10
Launching Your Network Connection	10
Connecting the Device	10
TRU-Install	11
OLED Display	14
Interpreting the OLED Display	14
Data Usage	15
Alerts	15
NETGEAR 341U Manager Interface	16
Home Page	16
Displaying the NETGEAR 341U Manager Home Page	17
Logging In as an Administrator	17
Data Usage	18
My Account Summary	19

Alerts	20
Status (Connection Details)	20
GPS Page	21
Settings Page	23
General > Device Tab	23
General > Software and Reset Tab	24
General > System Logs Tab	26
Network > Preferences Tab	27
Network > APN (Access Point Name) Tab	28
Network > SIM Security Tab	29
Network > Status Details Tab	30
Support Page	32
About Page	33
Feedback Page	35
Device Settings	36
Display Settings	36
Turning the OLED Display On or Off	36
Setting the OLED Display Data Usage Format	36
NETGEAR 341U Manager Home Page Settings	36
Changing the NETGEAR 341U Manager URL	37
Changing the NETGEAR 341U Manager IP Address	37
Changing the NETGEAR 341U Manager Password	37
Configuring Networks	39
Viewing Network Activation Information	39
Viewing Data Usage	39
Network Settings	40
Setting the Roaming Mode	40
Enabling / Disabling the Roaming Guard Warning Message	41
Setting the Allowed Network Mode	41
Configuring Access Point Names	42
Software and Reset	43
Exporting and Importing Settings	43
Exporting Settings	43
Importing Settings	43
Update USB Modem Software and Firmware	44
Downloading Software Updates	44
Upgrading Firmware From a File	45

Resetting Your Device	45
Clearing Account Details Only	45
Resetting Device Settings Only	45
Resetting to Factory Default Settings	45
GPS Settings	47
Enabling / Disabling GPS	47
Setting the GPS Mode	47
Using Metric Units	48
Frequently Asked Questions	49
How Can I Tell I'm Connected to 3G or LTE?	49
Is Roaming on LTE Supported?	49
What Do I Do if I Forget the Administrator Password?	49
If the Connection is "Always On," Am I Always Being Billed?	49
Questions About GPS	49
What is GPS?	50
Where Can I Use GPS?	50
How Do I Enable or Disable GPS?	50
What are some GPS Limitations?	50
How Can I Stream GPS Data to Use With a Third-party GPS Application?	50
How Do I Access My Corporate Network Through a VPN?	51
Are Terminal Sessions Supported?	51
Tips	52
USB Modem Location	52
Improving Signal Strength	52
Improving 3G Network Service	52
Troubleshooting	53
General Tips	53
OLED Display Is Dark	53
Insufficient Signal Strength	53
Cannot Display the Home Page	53
Cannot Connect to the Mobile Broadband Network	54
GPS Doesn't Seem to Be Available	55
Cannot Check for Updates	55
Technical Specifications	56
Radio Frequency and Electrical Specifications	56
Software Specifications	57
Environmental Specifications	57

Mechanical Specifications	58
Safety Information	59
Important Notice	59
Safety and Hazards	59
Regulatory Notices	60
Legal	62
Patents	62
Licenses	62
GNU General Public License (Version 2)	62
GNU General Public License (Version 3)	68
GNU Lesser General Public License (Version 2.1)	78
GNU Lesser General Public License (Version 3)	86
fontconfig License	88
libxml2 License	89
locapi License	91
pimd License	91
shadow License	92
ISC License	93
OpenSSL License	93
Original SSLeay License	94
Trademarks	96
Copyright	96
Limitation of Liability	96
Additional Information and Updates	97
Index	98

Get Started

The following topics give you all the information you need to set up your device and Sprint service the first time.

Your Device

The following illustrations show your device's primary external features and buttons.

Front View

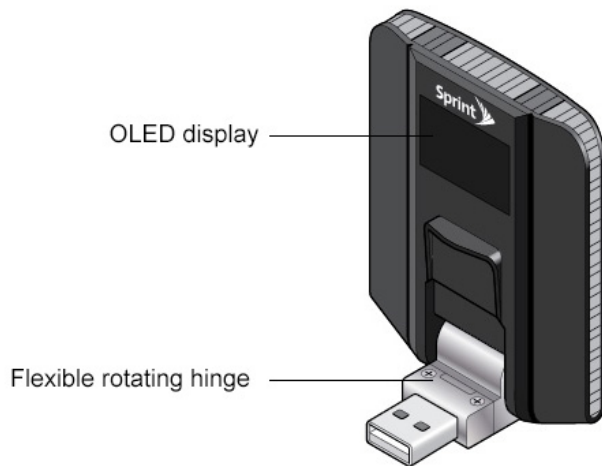

Back View (Cover Removed)

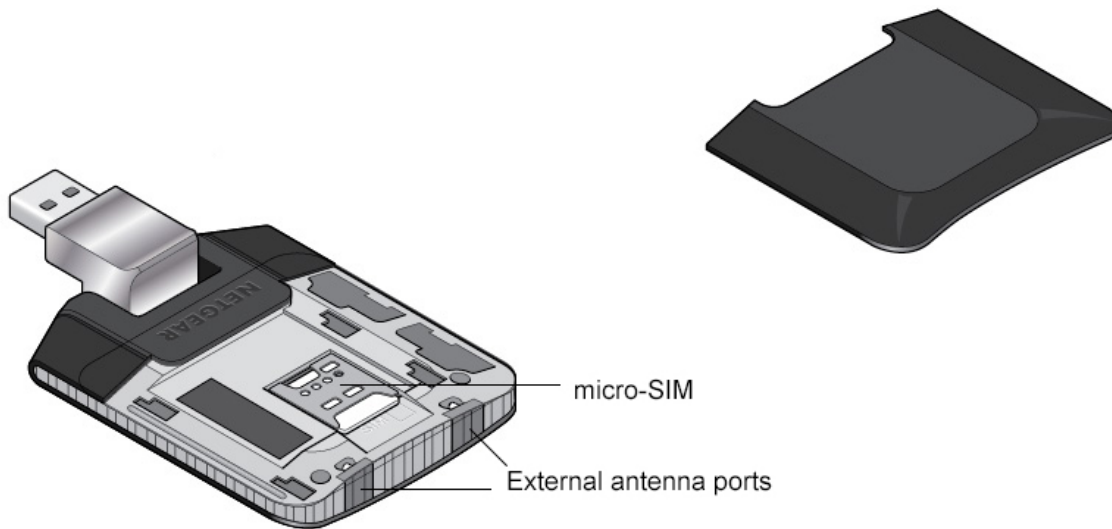

Package Contents

Your package includes several items.

- NETGEAR 341U USB Modem
- Back cover
- Micro-SIM (pre-installed)
- Get Started poster
- Recycling envelope

Care and Maintenance

As with any electronic device, you should handle your NETGEAR 341U USB Modem with care to ensure reliable operation. Follow these guidelines in using and storing the device.

- Protect the device from liquids, dust, and excessive heat.
- Do not handle or operate the device while driving or operating a vehicle. Doing so may distract you from properly operating the vehicle. In some jurisdictions, operating communication devices while in control of a vehicle is a criminal offense.
- Do not apply adhesive labels to the device. They may cause the device to overheat and may alter the antenna's performance.

System

The following items are required to use your NETGEAR 341U USB Modem.

- Web browser (required if you'll be using the NETGEAR 341U Manager browser interface to view status and to configure settings). The following browsers are supported:
 - Internet Explorer® (version 7.0 or higher)
 - Mozilla Firefox® (version 3.0 or higher)
 - Google Chrome™ (version 2.0.172.28 or higher)
 - Apple Safari® (version 4.0 or higher)
 - Opera™ (version 9.64)
- Computer running Windows® 8 (32/64 bit), Windows 7 (32/64 bit), Windows Vista, Windows XP, or Mac OS® X (version 10.5 or higher)
- USB 2.0 / 3.0 slot

Starting Your Device for the First Time

The NETGEAR 341U USB Modem is designed to activate automatically the first time that it is plugged in, using 'hands-free activation'. Typically, the activation process will be seamless, not requiring any action on your part; you might not even see any activation-related messages on the device's OLED display.

If your account did not activate for some reason (you are not in an area with Sprint 3G or LTE network coverage, you are in an area where you can't get signal such as a building or tunnel, etc.), a message will appear on the OLED display telling you to go to <http://sprintmodem/> to activate the account.

You must activate your account before you can use Sprint data services.

Plug in the Modem to Automatically Activate Your Account

1. Insert the USB modem into an available USB 2.0 or USB 3.0 slot. The device starts up and, if a Sprint 3G or LTE network signal is available, it will automatically try to activate your account (a message will appear indicating hands free activation is in progress).
2. If the activation succeeds, the OLED display shows the home screen. If the activation fails, you can try to activate the account from the NETGEAR 341U Manager, or repeat this procedure when you are in a Sprint coverage area.

Activate Your Account From the NETGEAR 341U Manager

If your account was not activated automatically when you inserted the USB modem, you cannot use Sprint data services.

You can attempt to activate the account from the NETGEAR 341U Manager:

1. Log in to the home page. (See [Logging In as an Administrator](#).) If a Sprint 3G or LTE network signal is available, hands free activation begins automatically.
2. Read the End User License Agreement that appears and, when you are ready, click **I Agree** to accept the terms of the agreement.
If the account is still activating, a Hands Free Activation message will display the current status. Wait for the process to finish (recommended) or click **Cancel**.

If you cancel the activation, follow the instructions that appear to finish the activation process.

If the activation succeeds, an Activation Complete message will appear.

Getting Help

Learn where you can get more information or assistance.

Visiting the Sprint Website

Sign on to [sprint.com](https://www.sprint.com) to get up-to-date information on Sprint services and options.

- Review coverage maps.
- Access your account information.
- Add additional options to your service plan.
- Purchase accessories.
- Check out frequently asked questions.
- And more.

Contacting Sprint Customer Service

You can reach Sprint Customer Service online or by calling toll-free.

- Log on to your account at [sprint.com](https://www.sprint.com).
- Call us toll-free at **1-888-788-4727** (business use) or **1-888-211-4727** (personal use).

Device Basics

Learn about the buttons, connectors, and other components of your NETGEAR 341U USB Modem.

3G and LTE Networks

These wireless networks connect you to the Internet.

Depending on your coverage area, you may have:



- Only LTE coverage
- Only 3G coverage
- A combination of these networks

Your device automatically connects to the fastest network that is available to you (customizable). If you have both 3G and LTE coverage and your connection happens to get disrupted, your device can automatically switch to the other network. For more information, see [Mobile Broadband Information and Settings](#).

- LTE – Newer technology, faster speeds compared with 3G and GSM
- 3G – CDMA technology, more widely available compared with LTE

Mobile Broadband Information and Settings

The network icon indicates the active network service type.

Icon	Description
	LTE service is available.
	3G service (1X/HRPD/1xHRPD) is available.
No icon	You have no service. Try the suggestions in Cannot Connect to the Mobile Broadband Network .

Your device is designed to always connect to an available network if possible. If your device is not connected (dropped signal, roaming not supported, etc.) an alert is displayed. The connection status can be seen on your device's [OLED Display](#), and on the NETGEAR 341U Manager's [Network > Status Details Tab](#).

Your device can be set to connect automatically to the best available network, or to LTE or 3G networks only. See [Setting the Allowed Network Mode](#).



Your device can also be set to allow roaming on Sprint networks, domestically, and internationally. See [Setting the Roaming Mode](#).

Signal Information

Learn how to determine the signal strength and get detailed network status information.

Signal Strength

The signal strength icon appears on your device's OLED display and in the NETGEAR 341U Manager's **Connection Details** panel.

Icon	Description
	No signal
	Very weak signal
	Excellent signal

Active Network

The network that is currently being used for your data connection appears on the device's home screen and in the Web page's **Connection Details** panel.

Network Status

Detailed network information (such as Connection Status, RSSI, Ec/Io, etc.) appear on the NETGEAR 341U Manager's [Network > Status Details Tab](#).

Internet Connection Information

Find information about your Internet connection.

- Data usage for the current connection session and the current billing period. (See [Viewing Data Usage](#).)
- Network connection type, signal strength, roaming status, and GPS status

Restarting the Device

If the device is not functioning properly, you can restart it using these methods.

- Eject and reinsert the device

- Reboot the computer

OLED Display

The OLED display has several icons that help you determine the status of your device and its connections, view data usage, and view system alerts. See [OLED Display](#) for details.

If the OLED display is not lit, see [Turning the OLED Display On or Off](#).

Micro-SIM

Your NETGEAR 341U USB Modem comes with a pre-installed micro-SIM that gives you access to the Sprint network.

To replace the micro-SIM if needed (your micro-SIM is damaged, you want to use a different account, etc.):

1. Slide the back cover off of the device.

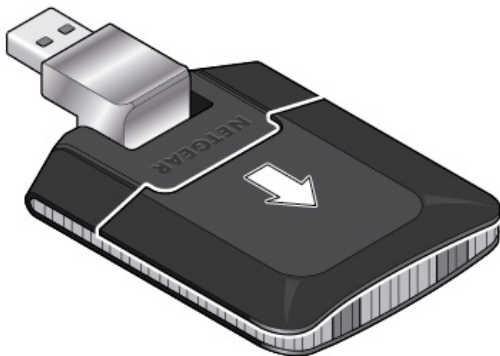

2. Slide the micro-SIM out of the tray.

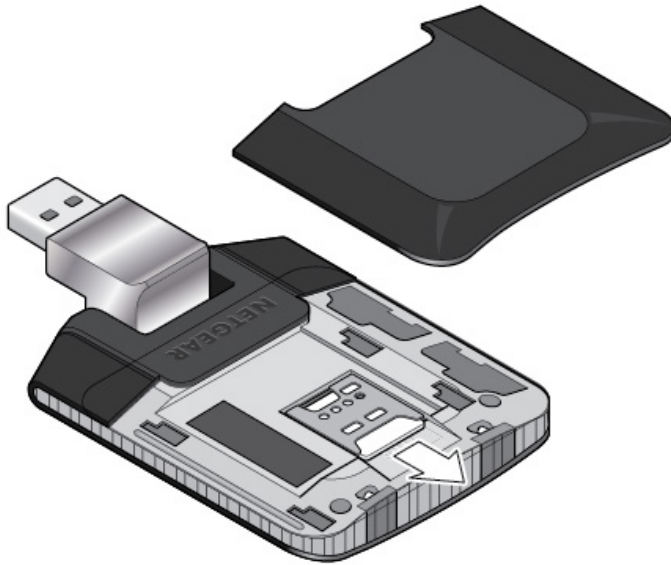

3. Slide the new micro-SIM into the tray.

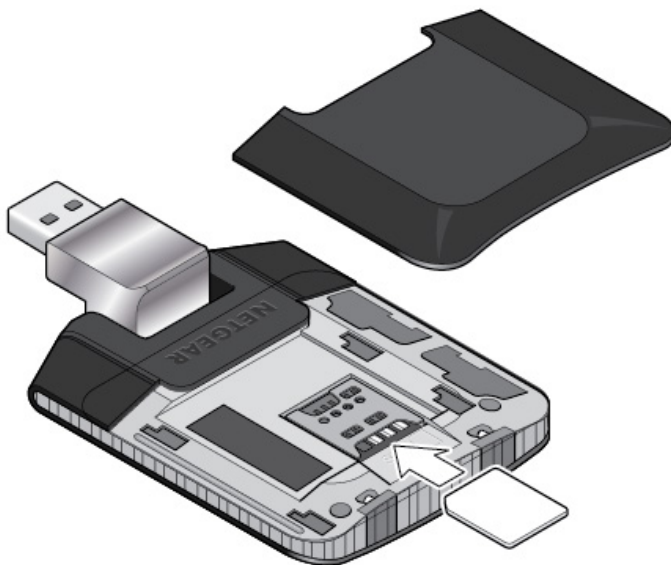

4. Replace the back cover.

External Antennas

Your NETGEAR 341U USB Modem supports the use of external MIMO antennas via two antenna connectors on the top edge of the device.

Important: If you choose to use external antennas, you **must** connect MIMO antennas to both antenna connectors, otherwise the device will not function correctly. Only antennas approved by NETGEAR for use with the NETGEAR 341U USB Modem are supported.

To connect external antennas:

1. Remove the back cover of the device.
2. Pull back the antenna connector covers and insert both of the antennas.
3. Replace the back cover.

Alerts

Alerts notify you about situations that require your attention and suggest the actions you need to take to resolve them.

Some of the alerts you may encounter include:

- SIM issues (SIM error, PIN locked, MEP locked, not installed)
- Roam Guard
- Mobile Broadband disconnected (Connection error)
- Add more data
- Downloading and Installing Firmware
- Airplane mode
- Temperature error

Your Network Connection

Find out how to launch and end your network connection.

Launching Your Network Connection

After the device is plugged in and boots up, a connection to the best available network is launched automatically.

The device will remain connected at all times, unless:

- You are out of signal range or the signal is blocked (in a tunnel, etc.).
- You are in a roaming area and you have chosen not to allow roaming.

Note: Even though the device is connected, you are only billed when data is sent or received. For more information, see [If the Connection is “Always On,” Am I Always Being Billed?](#)

See also:

- [Internet Connection Information](#)
- [Mobile Broadband Information and Settings](#)
- [Signal Information](#)

Connecting the Device

Connect the device to an available USB port on your computer.

Note: The NETGEAR 341U USB Modem includes TRU-Install, which is a feature that installs the necessary drivers the first time you connect your device to your Windows or Mac computer. An installation CD is not required. See [TRU-Install](#) for more information.

To connect the device to your computer:

- Insert the device's USB connector into a USB 2.0 or USB 3.0 slot in your computer.

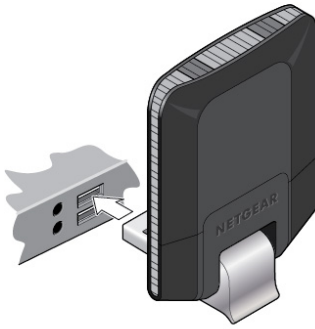

If the computer does not have device drivers installed for the NETGEAR 341U USB Modem, they are installed using TRU-Install.

TRU-Install

The NETGEAR 341U USB Modem includes TRU-Install, which is a feature that installs the necessary drivers the first time you connect your device to your Windows or Mac computer. An installation CD is not required.

Windows

When the device is connected to a Windows computer that does not have the required device drivers, the device starts up and then:

1. The device drivers will install and you must accept the license agreement:
 - If the driver **End user license agreement** is displayed, select **I've read and agree to the terms and conditions of my order**.

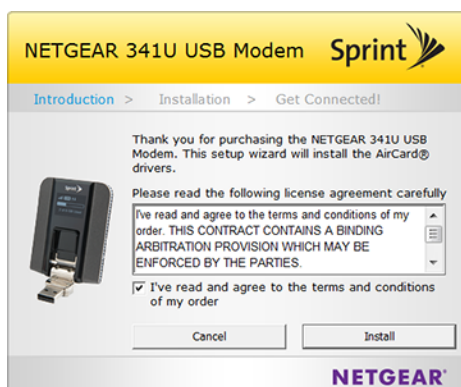

- if the AutoPlay window opens, click **Run setup.exe**, and when the End user license agreement is displayed, select **I've read and agree to the terms and conditions of my order**.

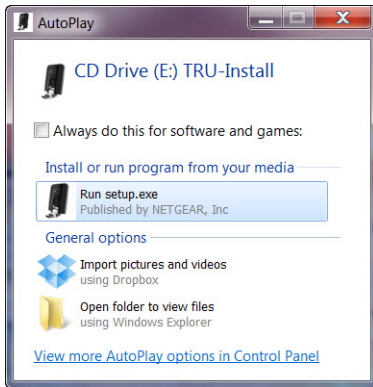

- If the driver End user license agreement does not display and the AutoPlay window does not open:
 - a. Press  +E to open My Computer.
 - b. Open the **TRU-Install** drive.
 - c. Open the **Win** folder.
 - d. Double-click **Setup.exe**.

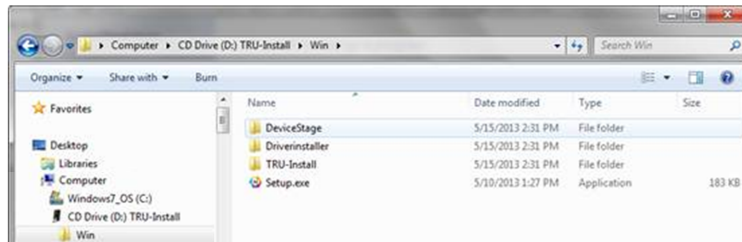

- e. When the End user license agreement is displayed, select **I've read and agree to the terms and conditions of my order**.
2. Click **Install**.
3. When the installation is complete, click **Finish**.

Mac

When the device is connected to a Mac computer that does not have the required device drivers:

1. The device starts up, and then the TRU-Install window opens.
Double-click the **Install Drivers** icon.
2. Follow the onscreen instructions.
3. When prompted for your password, enter your Mac password.

4. Click **Continue Installation**.
5. When the installation finishes, click **Restart** to reboot the computer and use the new drivers.

OLED Display

The NETGEAR 341U USB Modem's OLED display shows details (connection status, roaming status, and GPS info) and data usage for the current billing period or connection session.

If the OLED display is not lit, see [Turning the OLED Display On or Off](#).

Interpreting the OLED Display

The OLED display shows icons and text that reflect the status of the device and your connection, and screen elements that link to other configuration screens.

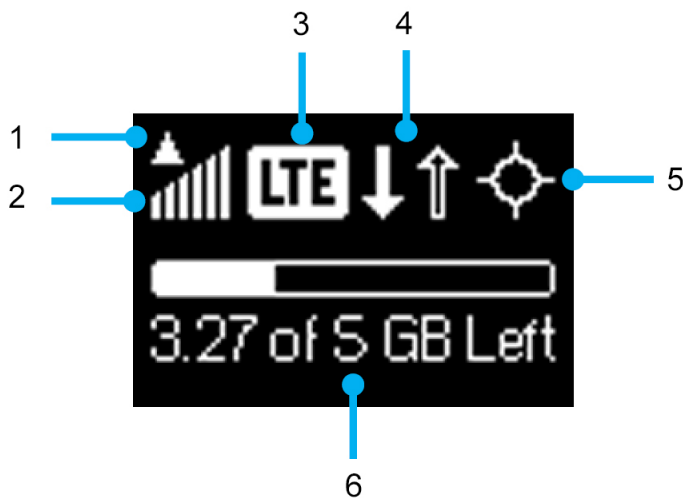

Item	Description
1	Roaming indicator – When the device is roaming, a triangle appears above the Signal strength icon. See also Setting the Roaming Mode .
2	Signal strength (1-6 bars, or no signal)
3	Network type (LTE, 3G)
4	Data transfer indicator (WAN traffic – upload (send) / download (receive)) – Arrows are solid when data is being transferred.
5	GPS indicator – Appears only when GPS tracking is on. The icon pulses/glows when searching for satellites or while tracking is in progress. See GPS Settings .
6	Data usage – Indicates the amount of data remaining (for the billing cycle) or the

Item	Description
	<p>amount of data used (for the current session). The bar (if shown) represents the amount of data remaining (the solid portion of the bar).</p> <p>See Data Usage and Setting the OLED Display Data Usage Format for details.</p>

Data Usage

The Data Usage section of the OLED display shows either billing cycle data usage or current session data usage, depending on the format selected in the NETGEAR 341U Manager (see [Setting the OLED Display Data Usage Format](#).)

See [Viewing Data Usage](#) for details.

Alerts

The OLED display shows network or device alerts for situations that require your attention. If one or more alerts are active, the OLED display shows the most severe alert. The alert remains on screen until it is resolved.

To view and resolve alerts, log in to the NETGEAR 341U Manager home page. (See [Logging In as an Administrator](#).) See the Alerts section of [Home Page](#) for details.

NETGEAR 341U Manager Interface

Access your device and connection information, and configure device settings from the NETGEAR 341U Manager (browser) interface.

Home Page

The home page is the entry page for the NETGEAR 341U Manager interface.

- View your data usage and status information for your data connection.
- Manage your mobile broadband network connection.
- View alert messages.

The screenshot displays the NETGEAR 341U Manager interface for a Sprint device. The interface is divided into several sections:

- Alerts:** Contains two messages: "SIM not installed" (Insert a SIM with the gold contacts facing each other) and "Updates available" (New firmware updates are now available, with an "Update now" link).
- Data Usage:**
 - Billing Cycle:** Shows a progress bar for data usage. It indicates "1.74GB of 2GB Left" (87% Remaining) and "3 Days Remaining (next plan begins on 6/1/13)". A "Reset" button is present.
 - Session:** Shows "Used: 0.88MB" and "Elapsed time 40m".
 - Used this month:** A table showing data usage for LTE, 3G, and Total.
- My Account:** Shows "My data plan: 2GB" and "My number: 9136179367".

Numbered callouts (1-13) point to various UI elements: 1 (Home button), 2 (GPS button), 3 (Settings button), 4 (Status section), 5 (Disconnect button), 6 (Social media icons), 7 (Feedback link), 8 (International Information link), 9 (Important Information link), 10 (My Account section), 11 (Alerts section), 12 (Data Usage section), and 13 (Reset button).

Item	Description
1	Home page – Click to view the Home Page .
2	GPS page – Click to view the GPS Page .
3	Settings page – Click to view the Settings Page .
4	Mobile broadband connection information – See Mobile Broadband Information

Item	Description
	and Settings.
5	Twitter® – Click to view the AirCard Twitter feed in a new browser window or tab. (Your device must be connected to the network for this option to work.)
6	Facebook® – Click to view the AirCard Facebook page in a new browser window or tab. (Your device must be connected to the network for this option to work.)
7	Feedback – Click to send NETGEAR your comments on your device. See Feedback Page . (Your device must be connected to the network for this option to work.)
8	International Information – Click to view Sprint’s International Coverage Areas search feature in a new browser window or tab. (Your device must be connected to the network for this option to work.)
9	Important Information – Click to read important safety information about the NETGEAR 341U USB Modem.
10	My Account Summary – Basic information about your Sprint data plan. For more details, click My Sprint to connect to your account at mysprint.sprint.com/mysprint .
11	Alerts – Alerts remain until issue is resolved.
12	Estimated data usage for current session.
13	Estimated data usage for current billing period.

Displaying the NETGEAR 341U Manager Home Page

There are two ways you can display the NETGEAR 341U Manager home page.

Note: You can display the home page only when your device is plugged in.

To display the home page, type one of the following in the address bar of your Web browser:

- <http://SprintModem>
- <http://192.168.1.1>

Note: If you’re using the Google Chrome Web browser, after typing in the address bar, press the Down Arrow key and then press the Enter key. (If you don’t press the Down Arrow first, a Google search starts instead of loading the NETGEAR 341U Manager.)

If your Web browser displays an error message, see [Cannot Display the Home Page](#).

Logging In as an Administrator

Logging in to the home page allows you to view more detailed information about your device, and to manage its settings and broadband network connection.

Note: If you don't log in, you can only view the current network connection status.

To log in:

1. In the address bar of your Web browser, type one of the following:
 - <http://SprintModem>
 - <http://192.168.1.1>
2. In the **Sign In** field, enter the NETGEAR 341U Manager administrator password (1-31 letters, numbers, and symbols). (The default password is **password**. It's recommended you change the password, if you haven't already. See [Changing the NETGEAR 341U Manager Password.](#))

The screenshot displays the NETGEAR 341U Manager interface. At the top left is the Sprint logo, and at the top right is the title 'NETGEAR 341U Manager' with links for 'Support', 'About', and 'Login'. A left sidebar contains navigation options: 'Home', 'GPS', 'Settings', 'Status', and social media links for Facebook and Twitter. The main content area is divided into two sections: 'Sign In' and 'Data Usage'. The 'Sign In' section has a text input field, a 'Sign In' button, and a 'Remember me' checkbox. The 'Data Usage' section is further divided into 'Billing Cycle' and 'Session' information. The 'Billing Cycle' section shows a progress bar for data usage, with text indicating '1.74GB of 2GB Left', '87% Remaining', and '3 Days Remaining (next plan begins on 6/1/13)'. Below this is a 'Reset' button. The 'Session' section shows 'Used: 0.88MB' and 'Elapsed time: 40m'. A table titled 'Used this month:' provides a breakdown of data usage by network type (LTE, 3G) and direction (Sent, Received, Combined). At the bottom, there is a disclaimer: 'Actual billed usage can be higher than estimated data usage displayed on the usage meter.' and a link to 'Check Carrier Usage'. A copyright notice for NETGEAR is visible at the very bottom.

	Sent	Received	Combined
LTE	4.61MB	8.13MB	12.74MB
3G	30.44MB	227.93MB	258.38MB
Total	35.05MB	236.06MB	271.11MB

3. Click **Sign In**.

After a period of inactivity, you will be automatically logged off (timeout security feature).

Data Usage

Data usage estimates are shown in the Data Usage section of the home page.

Data Usage

Billing Cycle

1.74GB of 2GB Left
87% Remaining
3 Days Remaining (next plan begins on 6/1/13)

Reset

Session

Used: 0.88MB
Elapsed time 40m

Used this month:

	Sent	Received	Combined
LTE	4.61MB	8.13MB	12.74MB
3G	30.44MB	227.93MB	258.38MB
Total	35.05MB	236.06MB	271.11MB

Actual billed usage can be higher than estimated data usage displayed on the usage meter.
[Check Carrier Usage](#)

Note: Data usage amounts are approximate and should not be used for billing purposes. For accurate data usage amounts, check with Sprint or click the [My Sprint](#) link in the My Account Summary section to view your account details.

The Data Usage section displays:

Item	Description
Current billing period	
Remaining this month	Amount of data still available from the monthly limit, and the number of days remaining before the next billing period begins.
Used this month	The amount of data sent and received during the billing period for each network type.
Reset button	Click to set the displayed monthly usage values to 0MB. Important: This does not reset the actual data usage for the billing cycle.
Current session	
Used	Data amount used since your device connected to the network
Elapsed time	Length of time that your device has been connected to the network

My Account Summary

The My Account Summary section shows basic information about your plan, and includes a link to see more detailed information.

My Account

My data plan: 2GB
My number: 9136179367
[My Sprint](#)

The following information is displayed.

Item	Description
My data plan	The type of Sprint data plan used on your device.
My number	The telephone number linked to your data plan.
My Sprint	Click to connect to your account at mysprint.sprint.com/mysprint .

Alerts

The Alerts section shows network or device alerts for situations that require your attention.

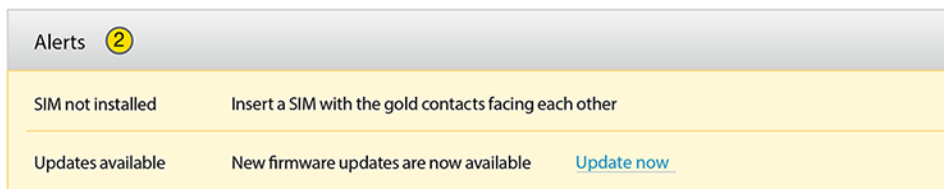

The following information is displayed for each alert.

Item	Description
Alert title	A short description of the issue to be addressed.
Description	The alert message and, if appropriate, links or buttons to take action on the alert. (For example, the “Update now” link in the second alert shown above would take you to the Software Update screen.)

The alerts disappear only when the issues they describe are resolved.

You can also view the most urgent alert on the USB modem’s OLED display.



See [Alerts](#) for a list of alerts you may encounter and the corrective actions required.

Status (Connection Details)

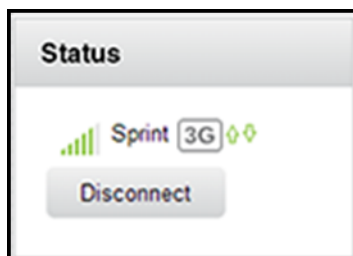
The Status section shows details about your mobile broadband service and connection state.



The following information is displayed.

Item	Description
Signal strength and roaming status	The more bars, the stronger the signal. A triangle in the icon means your device is roaming. See Signal Information for details.
Network carrier name	Name of the available network. For example, "Sprint".
Network type	LTE, 3G (1X / HRPD / 1xHRPD)
Send / Receive indicators	  Up (sending data) / Down (receiving data) This icon appears when you are connected to the mobile network.
Roaming message	Indicates whether your device is roaming on a Sprint network, domestically, or internationally.
Connect / Disconnect button	Click this button to connect or disconnect your device from the mobile network.

GPS Page

From the GPS page, you can obtain your current location coordinates (latitude, longitude, altitude, etc.).

You can also enable or disable GPS tracking, and choose the tracking method being used (one-time or continuous).

1. Log in to the home page. (See [Logging In as an Administrator](#).)

2. Click **GPS**.

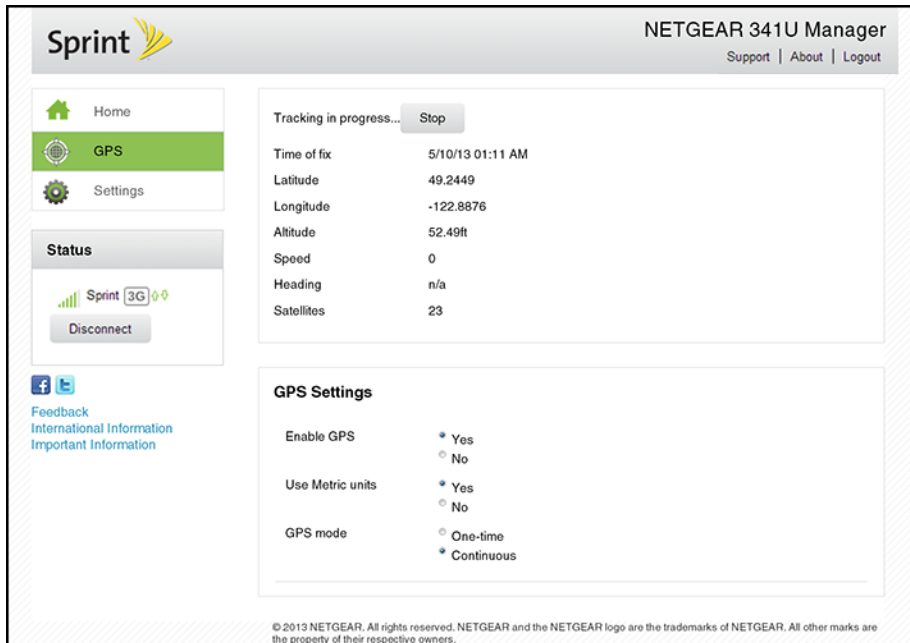

You can:

- Start or Stop tracking (if GPS Mode is Continuous)
- Update the current location information (if GPS Mode is One-time)

Note: The first time that you access GPS, you will be prompted to read and accept the Location-Based Services (LBS) end user license agreement. You must accept the agreement before you can use the GPS feature.

Note: For best results, minimize the number of obstructions between your device and the GPS satellites.

The following information is displayed.

Item	Description
Most recent position fix	
Update location / Cancel or Start / Stop	If the GPS Mode is: <ul style="list-style-type: none"> ■ One-time – Click Update location to get a location fix, or click Cancel to stop waiting for the fix to complete. ■ Continuous – Click Start to begin tracking and refreshing the location fix information regularly, or click Stop to stop tracking.
Status	Message indicating what the GPS system is doing (For example, “Tracking a fix”, “Searching for satellites”, “Inactive”)
Time of fix	This is the date and time that the last fix was taken.

Item	Description
Latitude	Latitude at time of last fix. (For example, "N32.51.73")
Longitude	Longitude at time of last fix. (For example, "W105.11.7")
Altitude	Elevation at time of last fix. (For example, "40 meters")
Speed	Speed at which device was moving at time of last fix. (For example, "3.1 mph")
Heading	Direction in which device was moving at time of last fix. (For example, "East")
Satellites	The number of satellites used to get the last fix.
GPS Settings	
Enable GPS	Turns the GPS service on or off. See Enabling / Disabling GPS . Note: For best results, minimize the number of obstructions between your device and the GPS satellites.
Use Metric units	This setting specifies whether to use metric units when displaying the GPS results (for example, for altitude, speed, and HEPE). See Using Metric Units .
GPS mode	This setting determines how often your device should obtain a fix. See Setting the GPS Mode . <ul style="list-style-type: none"> ▪ One-time – A single fix is used. Use this option if you'll be using your device at the same location. ▪ Continuous – Fixes are obtained every few seconds (also known as auto-tracking). This is useful for turn-by-turn (TBT) navigation applications, such as driving directions, and for NMEA-enabled applications.

Settings Page

From the Settings page, you can configure your device and network settings.

General > Device Tab

From the **General > Device** tab of the **Settings** page, you can turn your device's OLED display on/off, choose the type of data usage to show on the OLED display, and configure the Web browser URL and IP Address.

1. Log in to the home page. (See [Logging In as an Administrator](#).)

2. Click **Settings > General > Device**.

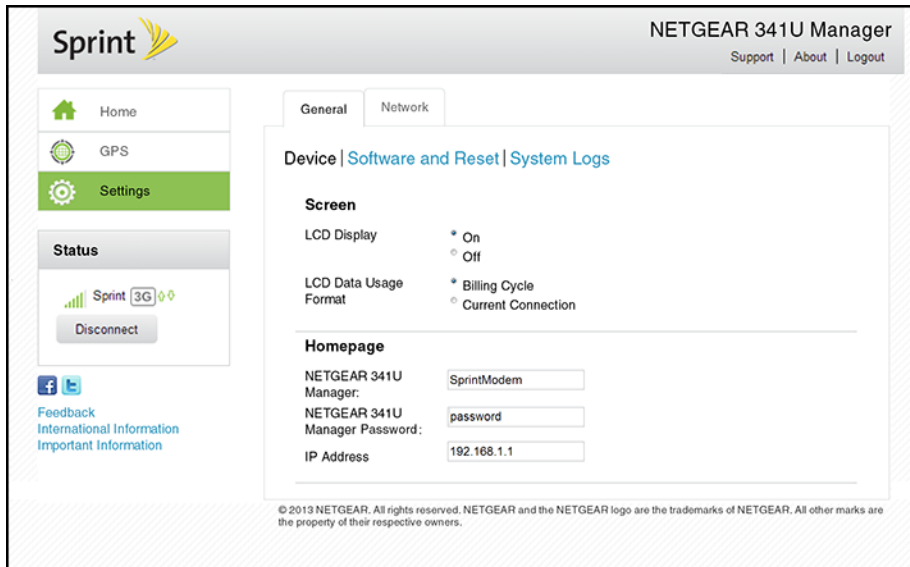

The following information is displayed.

Item	Description
Screen	
LCD Display	Turn the OLED display on or off. See Turning the OLED Display On or Off .
LCD Data Usage Format	Choose whether to show Billing cycle usage or current connection usage. See Setting the OLED Display Data Usage Format .
Homepage	
NETGEAR 341U Manager	The URL used to show the homepage. See Changing the NETGEAR 341U Manager URL .
NETGEAR 341U Manager Password	The password used to show the homepage. See Changing the NETGEAR 341U Manager Password .
IP Address	The IP address that will be used to access the NETGEAR 341U Manager page. You can change this from the default (192.168.1.1) if there are conflicts with other devices on your system.

General > Software and Reset Tab

From this tab, you can save your current device settings and restore them later, update your software, and reset your device to default settings.

1. Log in to the home page. (See [Logging In as an Administrator](#).)

2. Click **Settings > General > Software and Reset**.

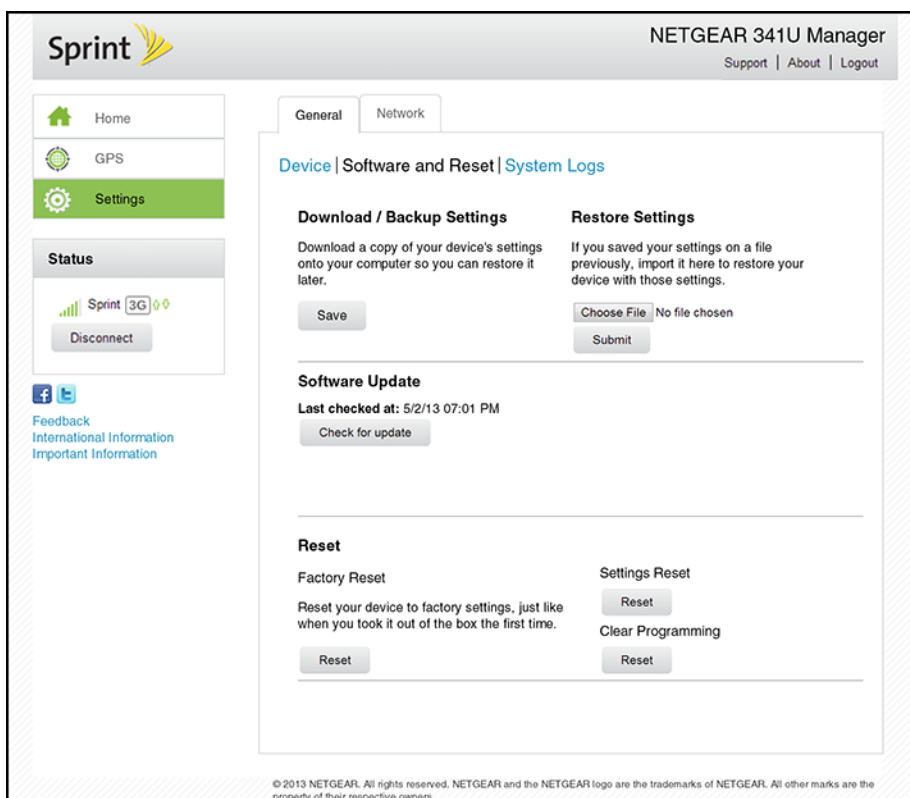

You can:

- Backup and restore your USB modem's configuration, if needed. See [Exporting Settings](#) and [Importing Settings](#).
- Update your device's software. See [Update USB Modem Software and Firmware](#).
- Reset some or all of your device's settings. See [Resetting to Factory Default Settings](#), [Resetting Device Settings Only](#) and [Clearing Account Details Only](#).

The following information is displayed.

Item	Description
Download / Backup Settings	Click Save to make a copy (export) of the USB modem's current configuration, so that you can restore it later if needed. See Exporting Settings .
Restore Settings	Click Choose file to use a previously saved copy of your device configuration. See Importing Settings .
Software Update	Click Check for update to see if a new version of your device's software has been released, and if there is, download and install it. The last time you checked is shown on the screen (Last checked at). See Update USB Modem Software and Firmware .

Item	Description
	Note: Software downloads count against your plan's data limit.
Reset	<ul style="list-style-type: none"> ▪ Factory Reset – Click to reset your device to factory default settings and clear your account details. See Resetting to Factory Default Settings. (You can only do this with assistance from Sprint.) ▪ Settings Reset – Click to reset your device to factory default settings, but leave your Sprint account details unchanged. See Resetting Device Settings Only. ▪ Clear Programming – Click to clear your account details. See Clearing Account Details Only.

General > System Logs Tab

Technical support staff may need you to configure system logging in this tab for the purpose of error diagnosis.

Note: You should only adjust settings in this tab under the direction of technical support staff.

1. Log in to the home page. (See [Logging In as an Administrator](#).)
2. Click **Settings > General > System Logs**.

The screenshot shows the NETGEAR 341U Manager interface. The top navigation bar includes the Sprint logo and the title "NETGEAR 341U Manager" with links for "Support", "About", and "Logout". The left sidebar contains navigation options: Home, GPS, Settings (highlighted), and Status. The main content area is titled "System Logs" and includes a "General" tab. Under "Enable Logs", there are checkboxes for Low, Medium, High, and Error. Below this is a "Clear logs" button and a table of system logs.

Date	Event	Args
5/22/13 04:32 PM	WLANTRUINSTALLMODE	0
09:57 PM	WLANTRUINSTALLMODE	1
5/22/13 04:32 PM	WLANTRUINSTALLMODE	0
10:07 PM	WLANTRUINSTALLMODE	1
5/22/13 04:32 PM	WLANTRUINSTALLMODE	0
10:10 PM	WLANTRUINSTALLMODE	1
5/22/13 04:32 PM	WLANTRUINSTALLMODE	0
10:40 AM	WLANTRUINSTALLMODE	1

© 2013 NETGEAR. All rights reserved. NETGEAR and the NETGEAR logo are the trademarks of NETGEAR. All other marks are the property of their respective owners.

You can:

- Enable logging

- Clear logs
- Download logs

Network > Preferences Tab

From this tab, you can configure your device's configuration for selecting networks and roaming, and receive network configuration updates from Sprint.

1. Log in to the home page. (See [Logging In as an Administrator.](#))
2. Click **Settings > Network > Preferences.**

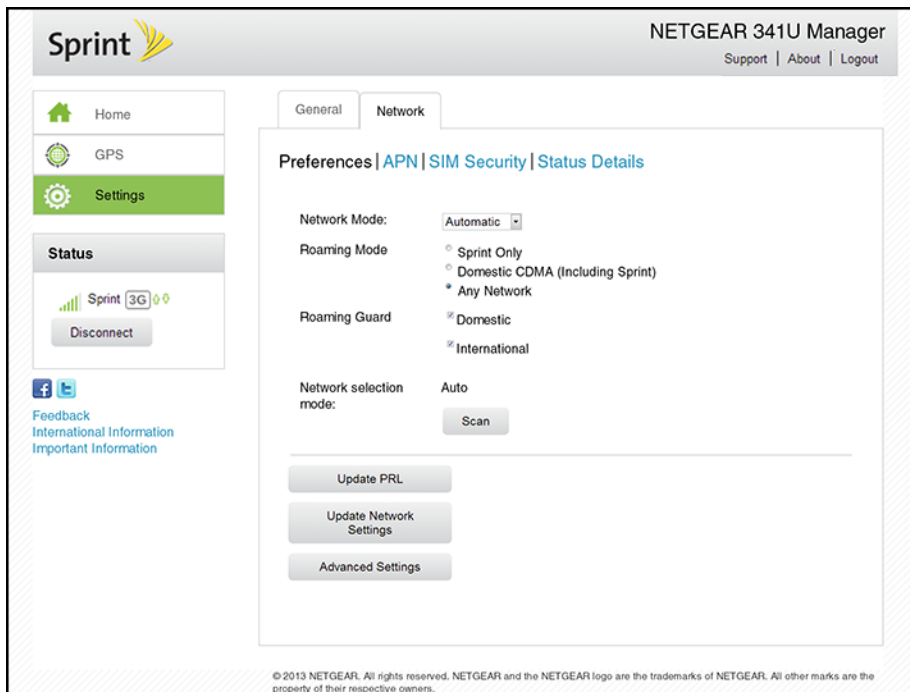

You can:

- Configure network selection and roaming options.
- Check the network for a new Preferred Roaming List.
- Re-run Hands Free Activation.

The following information is displayed.

Item	Description
Network Mode	The type of network that your device can connect to. See Setting the Allowed Network Mode.
Roaming Mode	The areas in which your device can roam. See Setting the Roaming Mode.

Item	Description
Roaming Guard	If selected, the roaming areas where a warning will appear when you enter them. See Enabling / Disabling the Roaming Guard Warning Message .
Update PRL	Click to check if a new PRL (Preferred Roaming List) is available on the network, and use it to update your device.
Update Network Settings	Click to re-run HFA (Hands Free Activation).
Manual Configuration	Use only when instructed by Sprint.
Advanced Settings	Use only when instructed by Sprint.

Network > APN (Access Point Name) Tab

To connect to a carrier's network when roaming, the device must be configured with an Access Point Name (APN) for that carrier. The APN is checked by the carrier to determine the type of network connection to establish.

Note: Your NETGEAR 341U USB Modem comes with the APN for Sprint preconfigured.

In this tab, you can add (or modify) APNs for the networks you want to connect to.

1. Log in to the home page. (See [Logging In as an Administrator](#).)
2. Click **Settings > Network > APN**.

The screenshot shows the NETGEAR 341U Manager interface. The top header includes the Sprint logo and 'NETGEAR 341U Manager' with links for Support, About, and Logout. The left sidebar contains navigation options: Home, GPS, Settings (highlighted), and Status. The main content area is titled 'Network' and contains a sub-menu with 'APN' selected. Below the sub-menu is a table with the following data:

Active	Name	APN	Username	Password	Authentication
<input checked="" type="radio"/>	internet	r.ispsn			None
<input type="radio"/>	WorldMode	cinet.spcs			None
<input type="radio"/>					None

At the bottom of the page, there is a copyright notice: © 2013 NETGEAR. All rights reserved. NETGEAR and the NETGEAR logo are the trademarks of NETGEAR. All other marks are the property of their respective owners.

To add (or modify) an APN, see [Configuring Access Point Names](#).

The list of all APNs that have been set up includes the following information.

Item	Description
Active	The APN currently in use. Only one APN can be marked as active.
Name	Network carrier name (for example, "Sprint").
APN	The operator's access point name (obtained from the operator).
Username	If required, the username (obtained from the operator) used to connect to the APN.
Password	If required, the password (obtained from the operator) used to connect to the APN.
Authentication	The network authentication code (None, PAP, CHAP, PAP or CHAP).

Network > SIM Security Tab

If you are using a SIM that has security enabled, you can disable SIM Security from this tab.

This tab shows the current status of this security feature, and allows you to disable SIM security if it has been enabled.

Note: The SIM PIN is required to disable SIM Security.

1. Log in to the home page. (See [Logging In as an Administrator.](#))
2. Click **Settings > Network > SIM Security**.

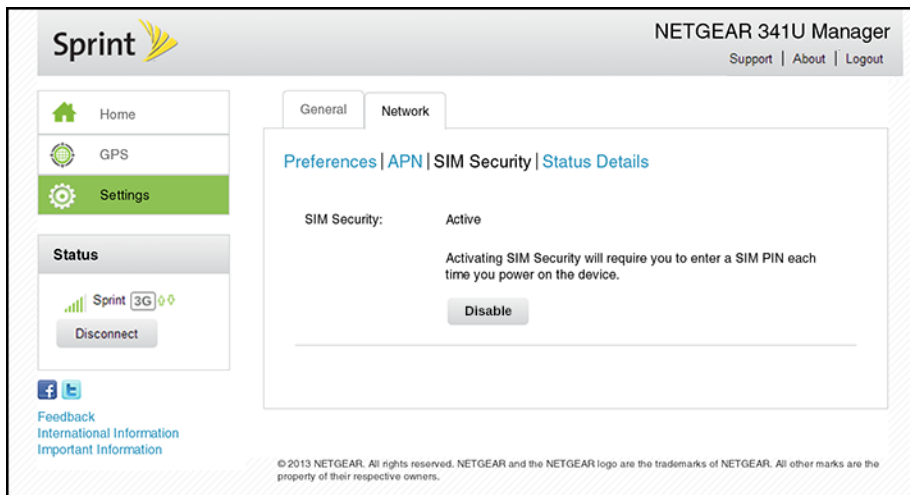

3. If the SIM has security enabled, SIM Security will be Active. Click **Disable** to disable SIM security.

The following information is displayed.

Item	Description
SIM Security	The current state of the SIM PIN feature (Inactive or Active). Click Disable to disable SIM security.

Network > Status Details Tab

This tab shows you details about the current mobile broadband connection (3G, LTE).

1. Log in to the home page. (See [Logging In as an Administrator.](#))
2. Click **Settings > Network > Status Details.**

The screenshot shows the NETGEAR 341U Manager interface. The top navigation bar includes the Sprint logo and the title 'NETGEAR 341U Manager' with links for 'Support', 'About', and 'Logout'. On the left, there is a sidebar with 'Home', 'GPS', and 'Settings' (highlighted in green). Below this is a 'Status' section showing a signal strength indicator, 'Sprint 3G', and a 'Disconnect' button. The main content area is titled 'Status Details' and contains the following information:

3G Details

Status: Disconnected
 PS service type: CDMA
 IP Address: 0.0.0.0

Coverage Type RSSI Ec/Io

3G 1x	-100	-31.5
3G EVDO	-81	-2

MDN: 0000000153
 MSID: 0000000153
 DRC Cover: 0
 DRC Value: 0
 Channel: 0
 Roaming: 228
 PRL Version: 25009
 1xRTT PN: 0
 EVDO PN: 0
 PRev: 6
 RX Power: -105
 Serving SID: 16420
 NID: 65535
 Packet Zone ID: 0
 Frame Error Rate: 0.0
 Subnet Color Code: 0
 AN-AAA: NotAuthenticated
 Packet Error Rate: 0.0
 MIP Error Code: 131

© 2013 NETGEAR. All rights reserved. NETGEAR and the NETGEAR logo are the trademarks of NETGEAR. All other marks are the property of their respective owners.

The information that is displayed depends on your current connection.

4G/LTE Details

Item	Description
Status	Indicates whether you are connected to an LTE network.
PS service type	Indicates the LTE service type.
RSRP	The signal strength of the LTE network. (Reference Signal Received

Item	Description
	Power)
RSRQ	The signal quality of the LTE network (Reference Signal Received Quality). RSRQ is the ratio between the RSRP and the Received Signal Strength Indicator (RSSI).
RS-SINR	Signal to Interference Noise Ratio based on Reference Signals (narrowband and wideband)
Cell ID	The LTE cell that is currently serving your device.
TX Power	The transmitter power. A higher number is better.
IP Address	The IP address of the 4G LTE connection.
Channel UL	The channel that is used to upload to the 4G LTE network.
Channel Number	The channel used by the 4G LTE radio. Technical support staff may request this value from you.
IMSI	The International Mobile Station Identity is an identifier of a device on the network.
Current radio band	The LTE band being used for the connection.
Reject Code	Technical support staff may request this value from you.
ICCID	The Integrated Circuit Card ID.

3G Details

Item	Description
Status	Indicates whether you are connected to a 3G network.
PS service type	Indicates the 3G service type (for example, CDMA, HRPD, CDMA_HRPD).
IP Address	The IP address of the 3G connection.
Coverage Type	The type of 3G network available.
RSSI	Signal strength of the network.
Ec/lo	Dimensionless ratio of the average power of a channel, typically the pilot channel, to the total signal power.
MDN	Mobile Directory Number. This is your 10-digit telephone number.
MSID	Mobile Station Identifier.
DRC Cover	Digital Rate Control Cover.
DRC Value	Digital Rate Control Value.
Channel	DRC Channel number.
Roaming	Indicates if you are roaming on Sprint, domestically, or internationally.

Item	Description
PRL Version	Preferred Roaming List version. To update the PRL, see Network > Preferences Tab .
1xRTT PN	Technical support staff may request this value from you.
EVDO PN	Technical support staff may request this value from you.
PRev	Technical support staff may request this value from you.
Rx Power	Technical support staff may request this value from you.
Serving SID	The Serving System ID identifies your home network area and is used to determine if you are 'home' or 'roaming'.
NID	Technical support staff may request this value from you.
Packet Zone ID	Technical support staff may request this value from you.
Frame Error Rate	Used to determine the quality of a signal connection. Technical support staff may request this value from you.
Subnet Color Code	Technical support staff may request this value from you.
AN-AAA	Technical support staff may request this value from you.
Packet Error Rate	Technical support staff may request this value from you.
MIP Error Code	The Mobile IP Error Code. Technical support staff may request this value from you.

Support Page

This page provides links to resources that can help you use your device and manage your Sprint account.

1. Log in to the home page. (See [Logging In as an Administrator](#).)
2. Click the **Support** link in the top right corner.

The screenshot displays the NETGEAR 341U Manager interface. At the top left is the Sprint logo, and at the top right is the title 'NETGEAR 341U Manager' with links for 'Support', 'About', and 'Logout'. A left-hand navigation menu includes 'Home', 'GPS', and 'Settings'. The main content area is titled 'Support' and contains the following text: 'User Guide Learn how to set up and use your device.', 'Web: Visit sprint.com/support for the complete User Guide, along with videos, tutorials, and community forums for your device.', 'Manage Account: 1-888-211-4727', and a 'Feedback' link. Below this is a 'Status' section showing signal strength and a 'Disconnect' button. At the bottom left are social media icons and links for 'Feedback', 'International Information', and 'Important Information'. The footer contains the copyright notice: '© 2013 NETGEAR. All rights reserved. NETGEAR and the NETGEAR logo are the trademarks of NETGEAR. All other marks are the property of their respective owners.'

The following information is displayed.

Item	Description
User Guide	Open an online copy of this guide in a new Web browser window or tab. (You must be connected to the Internet to use this link.)
Web	Click the link to open the online support website in a new Web browser window or tab where you can find a variety of resources to help you with your device. (You must be connected to the Internet to use this link.)
Manage Account	Contact Sprint Customer Service by telephone (for business use or personal use).
Feedback	Send NETGEAR your comments on your device. See Feedback Page .

About Page

View information about your device and account.

1. Log in to the home page. (See [Logging In as an Administrator](#).)
2. Click the **About** link in the top right corner.

The screenshot displays the NETGEAR 341U Manager web interface. At the top left is the Sprint logo, and at the top right is the title "NETGEAR 341U Manager" with links for "Support", "About", and "Logout".

The interface is divided into several sections:

- Home/Settings:** Includes links for Home, GPS, and Settings.
- Status:** Shows a "Disconnect" button and a "Sprint 3G" signal indicator.
- Account Details:** Lists "My number: 000000153", "MSID 000000153", "MEID 35574505000099", and "ICCID: 8901120000157194407".
- Firmware:** Lists "Firmware Version SWI9X15C_04.06.05.01", "Firmware Build Date 05/22/13", "Web App Version AC341U_03.01.29.00", and "Bootloader Version SWI9X15C_04.06.05.01".
- Device:** Lists "Model AirCard 341U", "NETGEAR 341U Manager: http://SprintModem", "PRL Version 25009", "Power State Offline", and "Current temperature 32 °C".
- WWAN Info:** Lists "Activation Date Not Activated 5/1/13 02:05 PM", "Refurbished Date Not Refurbished", "IP Address 0.0.0.0", "Lifetime LTE Transferred OMB", "Lifetime 3G Transferred OMB", and "Lifetime Total Transferred OMB".
- Network Status:** Includes a "View Details" link.

At the bottom, there are social media links for Facebook and Twitter, and a footer with copyright information: "© 2013 NETGEAR. All rights reserved. NETGEAR and the NETGEAR logo are the trademarks of NETGEAR. All other marks are the property of their respective owners."

You can:

- Save the image on this page to a file on your computer. Click **Save as a file**.

The following information is displayed.

Item	Description
Account Details	
My number	The USB modem's telephone number.
MSID	The Mobile Station ID associated with your phone number.
MEID	The MEID of your device (displayed on the packaging and inside the back compartment).
ICCID	The serial number of the SIM.
Firmware	
Firmware Version	The USB modem's firmware version.
Firmware Build Date	The date the firmware version was created.
Web App Version	The NETGEAR 341U Manager version.
Bootloader Version	The version of the software that starts up your device.
Device	
Model	The manufacturer's name for your device.
NETGEAR 341U Manager	Version number of the NETGEAR 341U Manager Web app.
PRL Version	Preferred Roaming List version number.
Power State	The USB modem's power state (Online, Offline).
Current temperature	The USB modem's temperature. If your device is too warm, make sure the area is well-ventilated and air can circulate around your device to cool it. (See Environmental Specifications .)
WWAN Info	
Activation Date	The date that the USB modem was activated on the Sprint network.
Refurbished Date	The date that your device was refurbished (if applicable).
IP Address	The IP address of the WWAN radio.
Lifetime LTE Transferred	The total amount of data sent and received while connected to LTE networks.
Lifetime 3G Transferred	The total amount of data sent and received while connected to 3G networks.
Lifetime Total Transferred	The total amount of data sent and received by your device.
Network Status	
View Details	Click the link to jump to the Network > Status Details Tab .

Feedback Page

Use the links on this page to send your comments on your device, look up support information, and participate in a customer survey.

1. Log in to the home page. (See [Logging In as an Administrator.](#))
2. Click the Feedback link in the bottom left corner of any page. The following page appears:

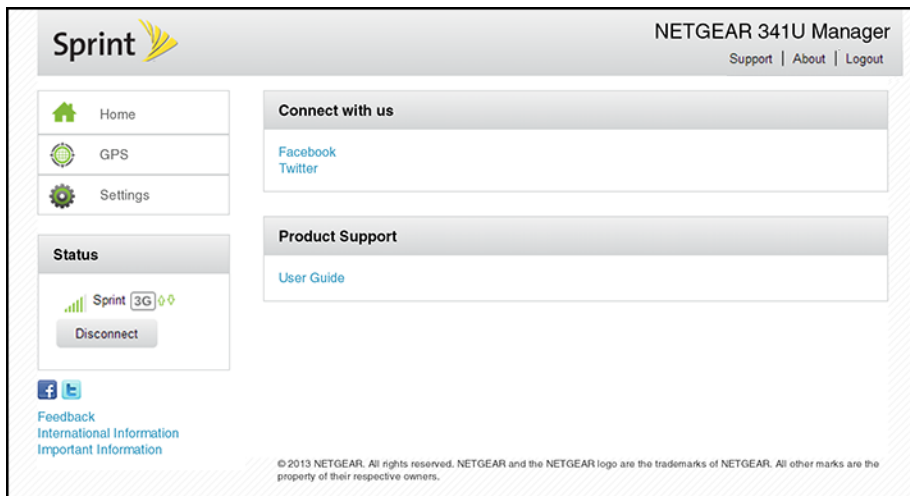

The following information is displayed.

Item	Description
Connect with us	
Facebook	Click to view the AirCard Facebook page in a new browser window or tab. (Your device must be connected to the network for this option to work.)
Twitter	Click to view the AirCard Twitter feed in a new browser window or tab. (Your device must be connected to the network for this option to work.)
Product Support	
User Guide	Open an online version of this user guide in a new window or tab.

Device Settings

Use the NETGEAR 341U Manager to configure and manage the device's appearance, performance, and access.

Display Settings

Adjust your screen's settings to suit your surroundings.

Turning the OLED Display On or Off

Use this feature to turn off the device's OLED display if you don't want to see it for some reason.

You can adjust this setting on the NETGEAR 341U Manager's **Settings > General** page.

1. Log in to the home page. (See [Logging In as an Administrator.](#))
2. Click **Settings > General > Device**.
3. Beside **LCD Display**, select **On** or **Off** as desired.
4. Click **Submit**.

Setting the OLED Display Data Usage Format

You can choose to show either Billing Cycle or Current Session data usage on the OLED display.

You can adjust this setting on the NETGEAR 341U Manager's **Settings > General** page.

1. Log in to the home page. (See [Logging In as an Administrator.](#))
2. Click **Settings > General**.
3. Beside **LCD Data usage format**, select the type of data usage to display (Billing cycle, or Current connection).
4. Click **Submit**.

NETGEAR 341U Manager Home Page Settings

The following topics provide information on changing the NETGEAR 341U Manager settings.

Changing the NETGEAR 341U Manager URL

You may want to change the URL for the NETGEAR 341U Manager to something more memorable.

To change the URL:

1. Log in to the home page. (See [Logging In as an Administrator.](#))
2. Click **Settings > General > Device**.
3. In the **NETGEAR 341U Manager** field (in the **Homepage** section), type the new value (maximum 31 letters and numbers).
4. Click **Submit**.

Changing the NETGEAR 341U Manager IP Address

You may want to change the IP address for the NETGEAR 341U Manager if it conflicts with other devices on your system.

To change the IP address:

1. Log in to the home page. (See [Logging In as an Administrator.](#))
2. Click **Settings > General > Device**.
3. In the **IP Address** field (in the **Homepage** section), type the new IP address.
4. Click **Submit**.

Changing the NETGEAR 341U Manager Password

For security reasons, you should change the NETGEAR 341U Manager password on a regular basis.

Note: If you forget the NETGEAR 341U Manager password, you'll need to reset your device to its default settings and go through the device setup. (See [What Do I Do if I Forget the Administrator Password?](#))

To change the NETGEAR 341U Manager administrator password:

1. Log in to the home page. (See [Logging In as an Administrator.](#))
2. Click **Settings > General > Device**.
3. In the **NETGEAR 341U Manager Password** field, type the new password (1-31 letters,

numbers, and symbols).

4. Click **Submit**.

Configuring Networks

The following topics provide information on configuring networks.

Viewing Network Activation Information

You can check whether network access is activated.

1. Log in to the home page. (See [Logging In as an Administrator](#).)
2. Click **About** in the top right corner of the page.
3. Check the **Activation Date** in the WWAN Info section. This is the date that the USB modem was activated on the Sprint network.

Viewing Data Usage

You can view an estimate of your data usage on the device's OLED display, and on the NETGEAR 341U Manager's home page.

Note: The data usage shown is an estimate only and is not accurate for billing purposes.

Note: The session data counter resets automatically each time the device is powered off and on, and when the mobile broadband network connection disconnects and reconnects (for example, when going through a tunnel). The billing plan data counter resets automatically when the next billing cycle starts.

On the OLED Display

The device's OLED display shows either billing cycle data usage or current session data usage, depending on the format selected in the NETGEAR 341U Manager (see [Setting the OLED Display Data Usage Format](#).)

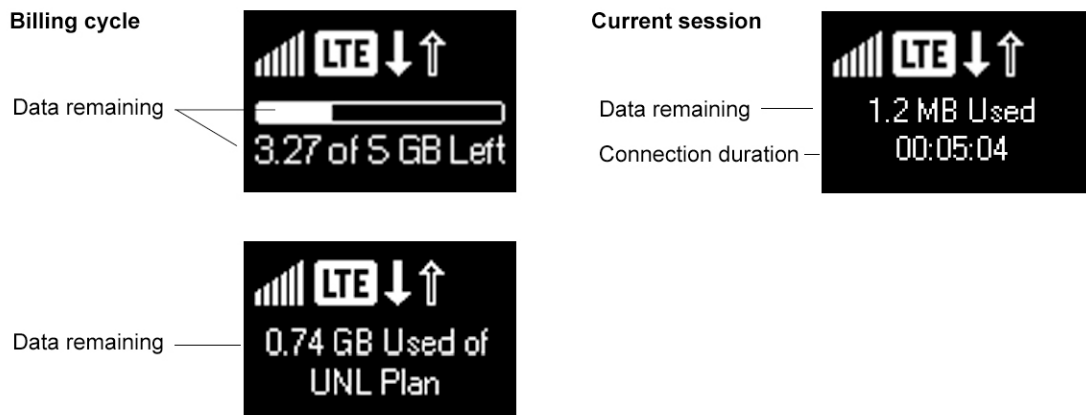

The **Billing Cycle** screen displays:

- A text description of the amount of data remaining in the current billing cycle.
- A data bar showing the amount of data remaining in the billing cycle (if the text description fits on one line).

The **Current Connection** screen displays:

- A text description of the amount of data used in the current session.
- The length of time the connection has been active.

In the NETGEAR 341U Manager (<http://SprintModem>)

- Log in to the home page. (See [Logging In as an Administrator.](#))

The Data Usage section of the home page shows:

- **Session**
 - Amount of data used in the current session
 - The length of time the connection has been active
- **Billing Cycle**
 - Total amount of data used in the current billing cycle, and amounts used for each network type
 - Number of days remaining in the current billing cycle
 - Date that the next billing cycle begins
- **Check Carrier Usage** – Click to connect to Sprint’s website and view detailed billing plan information.

Network Settings

Adjust your device’s network settings to select the network types that can be connected, and set roaming options.

Setting the Roaming Mode

Use this feature to choose where the device can be used in roaming mode.

You can adjust this setting on the NETGEAR 341U Manager’s **Settings > Network > Preferences** page, using the following options:

- **Sprint Only** – The device can be used only in Sprint service areas.
- **Domestic CDMA (Including Sprint)** – The device can roam only in North America.

- **Any Network** – The device can roam anywhere in the world.
 1. Log in to the home page. (See [Logging In as an Administrator.](#))
 2. Click **Settings > Network > Preferences.**
 3. Beside **Roaming Mode**, select the desired value.
 4. Click **Submit.**

Enabling / Disabling the Roaming Guard Warning Message

Use this feature to have your device display a warning when you enter a roaming area.

You can adjust this setting on the NETGEAR 341U Manager's **Settings > Network > Preferences** page:

1. Log in to the home page. (See [Logging In as an Administrator.](#))
2. Click **Settings > Network > Preferences.**
3. Beside **Roaming Guard**, select the warnings you would like to display (**Domestic** and/or **International**).
4. Click **Submit.**

Setting the Allowed Network Mode

Use this feature to select the types of networks that your device can connect to.

You can adjust this setting on the NETGEAR 341U Manager's **Settings > Network > Preferences** page to one of the following options:

- **Automatic** – The connection will be established on the fastest available network.
- **LTE only** – The connection can be established **only** on an LTE network. Your device **will not** connect to CDMA (3G) networks.
- **CDMA only** – The connection can be established **only** on a CDMA (3G) network. Your device **will not** connect to LTE networks.
 1. Log in to the home page. (See [Logging In as an Administrator.](#))
 2. Click **Settings > Network > Preferences.**
 3. Beside **Network Mode**, select the desired network mode that the device can connect to.
 4. Click **Submit.**

Configuring Access Point Names

Your device comes preconfigured with the Access Point Name (APN) for Sprint.

To add an APN for another network:

1. Log in to the home page. (See [Logging In as an Administrator](#).)
2. Click **Settings** > **Network** > **APN**.
3. In the blank line, enter the APN details:
 - In the **Name** field, enter a short description (for example, the carrier name).
 - In the **APN** field, enter the APN you obtained from the carrier.
 - Enter a **Username** and **Password**, if the network requires them.
 - Select the **Authentication** mode to be used (**None**, **PAP**, **CHAP**, **PAP or CHAP**).
4. Click the  beside the new APN entry.

To select the APN to be used:

- Select the **Active** button at the beginning of the entry.

To remove an APN from the list:

- Click the  beside the APN entry.

Software and Reset

The following topics provide information on managing your device's software.

Exporting and Importing Settings

The NETGEAR 341U USB Modem lets you save your device settings so that you can make changes to your configuration and, if necessary, restore the original settings.

Exporting Settings

Settings include configuration information for the device, network, and NETGEAR 341U Manager interface.

You can, for example, export (save) the current configuration, then make some changes and test them. You can then import (restore) the saved configuration.

To export the settings to a text file:

1. Log in to the home page. (See [Logging In as an Administrator.](#))
2. Click **Settings > General > Software and Reset.**
3. In the **Download / Backup Settings** section, click **Save.**
4. Save the file to an appropriate location in your computer. By default, the file (export.cfg) is saved to your Downloads folder.

Importing Settings

This feature lets you restore a saved configuration.

1. Log in to the home page. (See [Logging In as an Administrator.](#))
2. Click **Settings > General > Software and Reset.**
3. In the **Restore Settings** section, click **Choose File.**
4. Navigate to the folder where your previously saved configuration file is stored.
5. Click **Open** to restore your device with the imported settings.

Note: Your device may reset, and you may need to reconnect to the Internet. For more information, see [Launching Your Network Connection.](#)

Update USB Modem Software and Firmware

From time to time, updates may become available for your device, and your device will receive an alert. You can also check for new updates manually.

The updates may improve performance and add or modify features. The updates may include the following:

- Device firmware
- The NETGEAR 341U Manager interface
- Other files

Downloading Software Updates

You can download software updates from the NETGEAR 341U Manager.

When a software update becomes available:

- If the device is connected to Sprint's LTE network, the update downloads automatically and an Alert message appears on the device and in the NETGEAR 341U Manager.
- If the device is connected to Sprint's 3G network, an Alert message appears on the device and NETGEAR 341U Manager.

There are two ways to get the software update from the NETGEAR 341U Manager. You can get it from the Alert message, or from the **Software and Reset** page.

To get the update from the Alert:

1. Log in to the home page. (See [Logging In as an Administrator](#).)
2. In the Alert message for the available update, click the button to download or install the update.
3. Follow the onscreen instructions.
The device reboots automatically to use the new software.

To get the update from the **Software and Reset** tab:

1. Log in to the home page. (See [Logging In as an Administrator](#).)
2. Click **Settings** > **General** > **Software and Reset**.
3. Click **Check for update**. If an update is available, an **Install Now** button appears.
4. Click **Install Now**.
5. Click **Continue**. The device reboots automatically to use the new software.

Upgrading Firmware From a File

A one-click tool may be available for upgrading firmware from a file in enterprise environments. Contact Sprint for details.

Resetting Your Device

In some cases, you may want or need to clear your account information to use the device with another account, reset most settings (except for your account and network activation), or reset the device to its factory default settings.

You can clear these settings from the NETGEAR 341U Manager's **Software** page.

Clearing Account Details Only

If you want to use the device with another account, you need to clear your current account.

You can clear these settings from the NETGEAR 341U Manager's **Software** page.

1. Log in to the home page. (See [Logging In as an Administrator.](#))
2. Click **Settings** > **General** > **Software and Reset.**
3. Below **Clear Programming**, click **Reset.**
4. Click **Begin Reset.**

Resetting Device Settings Only

If you want to reset the device to its default behavior, but don't want to change your account or network activation, you need to reset the device settings.

You can reset these settings from the NETGEAR 341U Manager's **Software and Reset** page.

1. Log in to the home page. (See [Logging In as an Administrator.](#))
2. Click **Settings** > **General** > **Software and Reset.**
3. Below **Settings Reset**, click **Reset.**
4. Click **Begin Reset.**

Resetting to Factory Default Settings

In some cases you will need to reset the device's software to its factory default settings.

WARNING: If you reset the software to default settings, you must go through the device setup, as if you've just purchased the device. See [Starting Your Device for the First Time](#).

You can reset the device to factory settings from the NETGEAR 341U Manager's **Software and Reset** page.

Note: You can only do a factory reset of your device with Sprint's assistance. Contact Sprint Customer Service to obtain an MSL code that you will need to enter to perform the reset.

1. Contact Sprint Customer Service to obtain an MSL code and your device's PIN code, if needed.
2. Log in to the home page. (See [Logging In as an Administrator](#).)
3. Click **Settings** > **General** > **Software and Reset**.
4. Below **Factory Reset**, click **Reset**.
5. Enter the MSL code provided by Sprint, then click **Submit**.
6. Click **Begin Reset**.

GPS Settings

Your NETGEAR 341U USB Modem provides GPS functionality to help you figure out where you are and get you where you're going.

There are a couple of requirements to access the GPS service.

- You must accept the GPS privacy agreement.
- GPS must be enabled.

The GPS service may not be available if you are indoors. (You may be able to get a GPS lock if your device is very close to a window.) GPS receivers must be able to lock onto the global positioning satellites to accurately determine position. The number of obstructions present indoors often makes accurate position determination impossible.

Enabling / Disabling GPS

Before you can access GPS services, you must enable GPS on the NETGEAR 341U Manager's GPS page.

1. Log in to the home page. (See [Logging In as an Administrator](#).)
2. Click **GPS**.
3. In the GPS Settings section, select **Yes** next to "Enable GPS" (or select **No** to disable GPS).
4. Click **Submit**.

Setting the GPS Mode

The GPS mode determines how often location fixes are done.

Location fixes can be done:

- Once ("one-time"), or
- Periodically ("continuous")

You can set the GPS mode from the NETGEAR 341U Manager's GPS page:

1. Log in to the home page. (See [Logging In as an Administrator](#).)
2. Click **GPS**.
3. In the GPS Settings section beside **GPS Mode**, select the desired mode ("**One-time**" or "**Continuous**").
4. Click **Submit**.

Note: The GPS service must be enabled before you can set the GPS mode. (See [Enabling / Disabling GPS.](#))

Using Metric Units

You can use metric units in the display of location information (for example, speed and altitude).

You can choose the units on the NETGEAR 341U Manager's GPS page.

Note: The GPS service must be enabled before you can choose the units. For more information, see [Enabling / Disabling GPS.](#)

1. Log in to the home page. (See [Logging In as an Administrator.](#))
2. Click **GPS**.
3. In the **GPS Settings** section beside **Use Metric units**, select **Yes** (or select **No** to use standard measurements).
4. Click **Submit**.

Frequently Asked Questions

Find out answers to questions you may have.

How Can I Tell I'm Connected to 3G or LTE?

When you're connected to a network, in the NETGEAR 341U Manager (<http://SprintModem>), the network type icon (LTE, 3G) appears in the Connection Details section on the left side of the page, and the connection status is shown on the [Network > Status Details Tab](#).

Is Roaming on LTE Supported?

At the time of this release, roaming (that is, using a network other than Sprint) on LTE is not supported.

Roaming is supported on 3G (CDMA) networks.

To change the roaming setting, see [Setting the Roaming Mode](#).

What Do I Do if I Forget the Administrator Password?

Here's what to do if you forgot the Administrator Password.

- Reset the software to default settings. You will need to call Sprint Customer Support for assistance. (See [Resetting to Factory Default Settings](#).)

If the Connection is "Always On," Am I Always Being Billed?

No. The connection to the network goes dormant after a period of inactivity, but the connection can be re-established faster than having to reconnect. Billing occurs only when data is passed across the network.

Questions About GPS

Find answers to common questions about GPS.

What is GPS?

GPS stands for Global Positioning System, which is a system that uses a series of 24 geosynchronous satellites to provide location data.

GPS satellites transmit signals to equipment on the ground. GPS receivers passively receive satellite signals, but do not transmit.

Where Can I Use GPS?

GPS works wherever you have line-of-sight access to the GPS satellites.

How Do I Enable or Disable GPS?

By default, GPS is disabled. To enable GPS, see [Enabling / Disabling GPS](#).

What are some GPS Limitations?

Weather conditions or tall nearby buildings may affect your ability to get a clear view of the satellites and thus to acquire a GPS fix.

How Can I Stream GPS Data to Use With a Third-party GPS Application?

GPS NMEA data is streamed over a tethered USB connection using a virtual COM port.

Follow these steps to stream NMEA data for a third-party GPS application.

1. Set **GPS Mode** to **Continuous**. (See [Setting the GPS Mode](#).)
2. Determine the COM port number that your NETGEAR device (that is, your NETGEAR 341U USB Modem) is using.

In the following example for Windows, the Device Manager shows that COM 16 is used. In your case, the COM port number might be different.

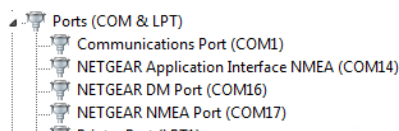

(If you don't know how to access the Device Manager, see http://kb.netgear.com/app/answers/detail/a_id/22868.)

3. Configure your GPS application to use the same COM port. For help, see the documentation of the GPS application.

How Do I Access My Corporate Network Through a VPN?

Once you complete a wireless connection, you may need to launch an extranet client provided by your company and supply the appropriate user name and password to gain access. For support, contact your company help desk.

Are Terminal Sessions Supported?

Terminal sessions (for example, via telnet or ssh) are not supported.

Tips

The following topics provide information on getting the most out of your device and your network connection.

USB Modem Location

Follow these guidelines in placing your device.

- Avoid moisture or extreme temperatures.
- For improved reception, place the device near a closed window.
- Place your device within easy reach of a reliable power supply and the computer to which it will be connected.

Improving Signal Strength

There are several ways you can improve the signal strength.

- Make sure you're inside a network coverage area.
- Try reorienting your device.
- Move your computer to another location — you may be in or near a structure that is blocking the signal. Every obstacle (for example, walls, ceilings, furniture) decreases the signal strength.
- Make sure there's plenty of space around your device to provide the best signal reception.
- If you cannot obtain service, contact Sprint — a network or account problem may be preventing you from obtaining service.

Improving 3G Network Service

To improve your network service, periodically check for PRL and profile updates.

The PRL (Preferred Roaming List) is an account configuration item set by your service provider. It controls the radio channels and network carrier used by the 3G modem.

To check for these updates:

1. Log in to the home page. (See [Logging In as an Administrator.](#))
2. Click **Settings > Network > Preferences.**
3. Click **Update PRL.**

Troubleshooting

Learn about various troubleshooting tips, and what to do when a specific message is displayed.

General Tips

Here are some general tips to get you started.

- Go to sprint.com/support to access troubleshooting and other resources.
- The knowledge base at the NETGEAR website (support.netgear.com) may also be useful.

OLED Display Is Dark

If the OLED display is dark, turn it on using the NETGEAR 341U Manager. See [Turning the OLED Display On or Off](#).

Insufficient Signal Strength

If you have insufficient signal strength, an icon is displayed on the device's home screen, and on the NETGEAR 341U Manager's Status section.

Insufficient signal strength, indicated by , may occur because:

- You are outside network coverage areas.
- Your device's internal antenna is pointing in the wrong direction.
- You are in or near a structure that is blocking the signal.
- You are near a device that is causing radio signal interference.
- A network or account problem is preventing you from obtaining service.

See also [Improving Signal Strength](#).

Cannot Display the Home Page

Your Web browser may display an error message when you try to display the home page. The error message depends on your Web browser.

- "Could not connect to remote server" (Opera)
- "Internet Explorer cannot display the webpage" (Internet Explorer)
- "Oops! This link appears to be broken" (Google Chrome)

- “Safari can’t open the page” (Safari)
- “The connection has timed out” (FireFox)

Check the following:

- Your device is seated correctly in the computer’s USB slot.
- Make sure you’re typing the correct address in the Web browser.
 - Try **http://SprintModem** (unless you’ve changed the URL in [Changing the NETGEAR 341U Manager URL.](#))
 - If the home page is still not displayed, try **http://192.168.1.1** (unless you’ve changed the IP address in [Changing the NETGEAR 341U Manager IP Address.](#))
- The Web browser is a recent version, and Java-enabled. The following are recommended:
 - Internet Explorer (version 7.0 or higher)
 - Mozilla Firefox (version 3.0 or higher)
 - Google Chrome (version 2.0.172.28 or higher)
 - Apple Safari (version 4.0 or higher)
 - Opera (version 9.64)
- If your computer has other adapters (for example, Ethernet) connected to other networks, disable or remove them from your computer.
- If Internet security software is running on your computer, disable it and see whether the error message still occurs. Some firewall software may block access to the home page.
- Check your Web browser settings:
 1. Open the Control Panel in Windows.
 2. Double-click **Internet Options**.
 3. From the **Security** tab, restore the default settings.
 4. From the **Connections** tab, select **Never dial a connection**.
 5. From the **Advanced** tab, restore the default settings.
 6. Close and reopen your Web browser.

If, after checking all of the above, you still cannot display the home page, consider resetting the software to default settings. See [Resetting to Factory Default Settings](#) for details.

Cannot Connect to the Mobile Broadband Network

If this message is displayed, go through the following steps.

- Make sure the device is seated correctly in the computer's USB slot.
- Make sure you're in a network coverage area.
- Check the **Network Mode** setting (See [Setting the Allowed Network Mode.](#)) For example, if it's set to **LTE Only**, you won't be able to connect if you don't have LTE coverage.
- If you're roaming on 3G, make sure that roaming is enabled. (See [Setting the Roaming Mode.](#)) (Roaming is not supported on LTE.)

Note: Roaming charges may apply.

- If you're roaming internationally, make sure that **Any Network** is selected. (See [Setting the Roaming Mode.](#))
- Try the tips in [Improving Signal Strength.](#)
- Check with Sprint — a network or account problem may be preventing your device from obtaining service.

GPS Doesn't Seem to Be Available

Make sure that GPS is enabled. (See [Enabling / Disabling GPS.](#))

For best results, minimize the number of obstructions between your device and the GPS satellites.

Cannot Check for Updates

Make sure the device is seated correctly in the computer's USB slot.

Technical Specifications

The following topics list the electrical, radio frequency, and other parameters of the device for those who require technical information.

Radio Frequency and Electrical Specifications

This section lists the radio frequency and electrical parameters of the device.

Item	Description
Approvals	FCC
Current	Maximum: ~700 mA Standby current: <ul style="list-style-type: none">– CDMA: ~38 mA– LTE: ~46 mA
Transmit	PCS: 1850-1910 MHz Cellular: 824-849 MHz Secondary 800 MHz: 817-824 MHz LTE: <ul style="list-style-type: none">– Band 25: 1850-1915 MHz– Band 26: 814-849 MHz– Band 41 (TDD): 2496-2690 MHz
Receive	PCS: 1930-1990 MHz Cellular: 869-894 MHz Secondary 800 MHz: 862-869 MHz LTE: <ul style="list-style-type: none">– Band 25: 1930-1995 MHz– Band 26: 859-894 MHz– Band 41 (TDD): 2496-2690 MHz– GPS: 1575.42 MHz

Software Specifications

This section lists the specifications that the device supports.

Item	Description
CDMA (3G) specification	IS-2000 Release 0
Data service	IS-707A
3GPP	Release 9
SMS (IS-637)	Not supported
FAX	Not supported
IOTA	Supported
OTASP (IS-683A, IS-683B, IS-683C)	Supported
OTAPA	Supported
PRL (Preferred Roaming List)	Supported
Authentication	Supported
Voice	Not supported
NAM	Single
Position Location	Standalone
TTY/Accessibility	Not supported
Mobile IP	Supported
Network protocols (routing hardware)	TCP, UDP, ARP, RARP, ICMP
VPN	Pass-through of the following VPN types: PPTP IPSec Tunneling of multiple VPN sessions simultaneously is supported.

Environmental Specifications

This section describes the environmental conditions that the device can be used in.

Item	Description
Operating temperature	32 to 113°F
Storage temperature	-4 to +185°F

Mechanical Specifications

This section describes the dimensions and physical features of your device.

Item	Description
Dimensions (W x L x H)	Width – 2.0" Length – 2.5" (hinge closed), 3.4" (hinge fully open) Thickness – 0.70" (hinge fully open)
Weight	55 g
OLED Display	Monochrome Area: 96 x 64 pixels Active area: 19.953 x 13.424 (mm) Pixel size: 0.193 x 0.194 (mm)

Safety Information

Read important safety information about your device.

Important Notice

Due to the nature of wireless communications, transmission and reception of data can never be guaranteed. Data may be delayed, corrupted (i.e., have errors) or be totally lost. Although significant delays or losses of data are rare when wireless devices such as the NETGEAR 341U USB Modem are used in a normal manner with a well-constructed network, the device should not be used in situations where failure to transmit or receive data could result in damage of any kind to the user or any other party, including but not limited to personal injury, death, or loss of property. NETGEAR accepts no responsibility for damages of any kind resulting from delays or errors in data transmitted or received using the device, or for failure of the device to transmit or receive such data.

Safety and Hazards

Do not operate your device under the following conditions.

- In areas where blasting is in progress
- Where explosive atmospheres may be present
- Near medical equipment
- Near life support equipment, or any equipment that may be susceptible to any form of radio interference.

In such areas, your device **MUST BE POWERED OFF**. The device can transmit signals that could interfere with this equipment.

Do not operate the device in any aircraft, whether the aircraft is on the ground or in flight. In aircraft, the device **MUST BE POWERED OFF**. When operating, the device can transmit signals that could interfere with various onboard systems.

Note: Some airlines may permit the use of cellular phones while the aircraft is on the ground and the door is open. The device may be used at this time.

The driver or operator of any vehicle should not operate the device while in control of a vehicle. Doing so will detract from the driver or operator's control and operation of that vehicle. In some jurisdictions, operating such communications devices while in control of a vehicle is an offense.

Regulatory Notices

This section contains regulatory information for your device.

The design of the NETGEAR 341U USB Modem complies with U.S. Federal Communications Commission (FCC) guidelines respecting safety levels of radio frequency (RF) exposure for mobile devices, which in turn are consistent with the following safety standards previously set by U.S. and international standards bodies:

- ANSI / IEEE C95.1-1999, **IEEE Standard for Safety Levels with Respect to Human Exposure to Radio Frequency Electromagnetic Fields, 3kHz to 300 GHz**
- National Council on Radiation Protection and Measurements (NCRP) Report 86, 1986, **Biological Effects and Exposure Criteria for Radio Frequency Electromagnetic Fields**
- International Commission on Non-Ionising Radiation Protection (ICNIRP) 1998, **Guidelines for limiting exposure to time-varying electric, magnetic, and electromagnetic fields (up to 300 GHz)**

FCC ID: PY3AC341U

RF Exposure - The NETGEAR 341U USB Modem has been tested for compliance with FCC RF exposure limits in a portable configuration. At least 1.0 cm of separation distance between the NETGEAR 341U USB Modem and the user's body must be maintained at all times. This device must not be used with any other antenna or transmitter that has not been approved to operate in conjunction with this device.

WARNING (EMI) - United States FCC Information - This equipment has been tested and found to comply with the limits for a Class B computing device peripheral, pursuant to Part 15 of the FCC rules. These limits are designed to provide reasonable protection against harmful interference in a residential installation.

This equipment generates, uses, and can radiate radio frequency energy and, if not installed and used in accordance with the instructions, may cause harmful interference to radio communications. However, there is no guarantee that interference will not occur in a particular installation.

If this equipment does cause harmful interference to radio or television reception, which can be determined by turning the equipment off and on, the user is encouraged to try to correct the interference by one or more of the following measures:

- Reorient or relocate the receiving antenna.
- Increase the separation between the equipment and receiver.
- Connect the equipment into an outlet on a circuit different from that to which the receiver is connected.
- Consult the dealer or an experienced radio/TV technician for help.

CAUTION: Any changes or modifications not expressly approved by NETGEAR could void the user's authority to operate the equipment.

This device complies with Parts 15, 24, and 27 of the FCC Rules. Operation is subject to the following two conditions: (1) This device may not cause harmful interference, and (2) this device must accept any interference received, including interference that may cause undesired operation.

Legal

This section contains important license and legal information.

Patents

This product may contain technology developed by or for NETGEAR, Inc.

This product includes technology licensed from QUALCOMM®.

Licenses

A large amount of the source code to this product is available under various free and open source licenses. Most is available under one or more versions of the GNU General Public License and/or GNU Limited General Public License.

The remainder of the open source software which is not under the GPL is available under one of a variety of more permissive licenses. Those that require reproduction of the license text in the distribution are listed in the sections that follow (starting with [fontconfig License](#)).

GNU General Public License (Version 2)

Below is the GNU General Public License.

Version 2, June 1991

Copyright (C) 1989, 1991 Free Software Foundation, Inc. 51 Franklin St, Fifth Floor, Boston, MA 02110-1301 USA

Everyone is permitted to copy and distribute verbatim copies of this license document, but changing it is not allowed.

Preamble

The licenses for most software are designed to take away your freedom to share and change it. By contrast, the GNU General Public License is intended to guarantee your freedom to share and change free software--to make sure the software is free for all its users. This General Public License applies to most of the Free Software Foundation's software and to any other program whose authors commit to using it. (Some other Free Software Foundation software is covered by the GNU Library General Public License instead.) You can apply it to your programs, too.

When we speak of free software, we are referring to freedom, not price. Our General Public Licenses are designed to make sure that you have the freedom to distribute copies of free software (and charge for this service if you wish), that you receive source code or can get it if you want it, that

you can change the software or use pieces of it in new free programs; and that you know you can do these things.

To protect your rights, we need to make restrictions that forbid anyone to deny you these rights or to ask you to surrender the rights. These restrictions translate to certain responsibilities for you if you distribute copies of the software, or if you modify it.

For example, if you distribute copies of such a program, whether gratis or for a fee, you must give the recipients all the rights that you have. You must make sure that they, too, receive or can get the source code. And you must show them these terms so they know their rights.

We protect your rights with two steps: (1) copyright the software, and (2) offer you this license which gives you legal permission to copy, distribute and/or modify the software.

Also, for each author's protection and ours, we want to make certain that everyone understands that there is no warranty for this free software. If the software is modified by someone else and passed on, we want its recipients to know that what they have is not the original, so that any problems introduced by others will not reflect on the original authors' reputations.

Finally, any free program is threatened constantly by software patents. We wish to avoid the danger that redistributors of a free program will individually obtain patent licenses, in effect making the program proprietary. To prevent this, we have made it clear that any patent must be licensed for everyone's free use or not licensed at all.

The precise terms and conditions for copying, distribution and modification follow.

GNU GENERAL PUBLIC LICENSE

TERMS AND CONDITIONS FOR COPYING, DISTRIBUTION AND MODIFICATION

0. This License applies to any program or other work which contains a notice placed by the copyright holder saying it may be distributed under the terms of this General Public License. The "Program", below, refers to any such program or work, and a "work based on the Program" means either the Program or any derivative work under copyright law: that is to say, a work containing the Program or a portion of it, either verbatim or with modifications and/or translated into another language. (Hereinafter, translation is included without limitation in the term "modification".) Each licensee is addressed as "you".

Activities other than copying, distribution and modification are not covered by this License; they are outside its scope. The act of running the Program is not restricted, and the output from the Program is covered only if its contents constitute a work based on the Program (independent of having been made by running the Program). Whether that is true depends on what the Program does.

1. You may copy and distribute verbatim copies of the Program's source code as you receive it, in any medium, provided that you conspicuously and appropriately publish on each copy an appropriate copyright notice and disclaimer of warranty; keep intact all the notices that refer to this License and to the absence of any warranty; and give any other recipients of the Program a copy of this License along with the Program.

You may charge a fee for the physical act of transferring a copy, and you may at your option offer warranty protection in exchange for a fee.

2. You may modify your copy or copies of the Program or any portion of it, thus forming a work based on the Program, and copy and distribute such modifications or work under the terms of Section 1 above, provided that you also meet all of these conditions: a) You must cause the modified files to carry prominent notices stating that you changed the files and the date of any change. b) You must cause any work that you distribute or publish, that in whole or in part contains or is derived from the Program or any part thereof, to be licensed as a whole at no charge to all third parties under the terms of this License. c) If the modified program normally reads commands interactively when run, you must cause it, when started running for such interactive use in the most ordinary way, to print or display an announcement including an appropriate copyright notice and a notice that there is no warranty (or else, saying that you provide a warranty) and that users may redistribute the program under these conditions, and telling the user how to view a copy of this License. (Exception: if the Program itself is interactive but does not normally print such an announcement, your work based on the Program is not required to print an announcement.)

These requirements apply to the modified work as a whole. If identifiable sections of that work are not derived from the Program, and can be reasonably considered independent and separate works in themselves, then this License, and its terms, do not apply to those sections when you distribute them as separate works. But when you distribute the same sections as part of a whole which is a work based on the Program, the distribution of the whole must be on the terms of this License, whose permissions for other licensees extend to the entire whole, and thus to each and every part regardless of who wrote it.

Thus, it is not the intent of this section to claim rights or contest your rights to work written entirely by you; rather, the intent is to exercise the right to control the distribution of derivative or collective works based on the Program.

In addition, mere aggregation of another work not based on the Program with the Program (or with a work based on the Program) on a volume of a storage or distribution medium does not bring the other work under the scope of this License.

3. You may copy and distribute the Program (or a work based on it, under Section 2) in object code or executable form under the terms of Sections 1 and 2 above provided that you also do one of the following: a) Accompany it with the complete corresponding machine-readable source code, which must be distributed under the terms of Sections 1 and 2 above on a medium customarily used for software interchange; or, b) Accompany it with a written offer, valid for at least three years, to give any third party, for a charge no more than your cost of physically performing source distribution, a complete machine-readable copy of the corresponding source code, to be distributed under the terms of Sections 1 and 2 above on a medium customarily used for software interchange; or, c) Accompany it with the information you received as to the offer to distribute corresponding source code. (This alternative is allowed only for noncommercial distribution and only if you received the program in object code or executable form with such an offer, in accord with Subsection b above.)

The source code for a work means the preferred form of the work for making modifications to it. For an executable work, complete source code means all the source code for all modules it contains, plus any associated interface definition files, plus the scripts used to control compilation and installation of the executable. However, as a special exception, the source code distributed need not

include anything that is normally distributed (in either source or binary form) with the major components (compiler, kernel, and so on) of the operating system on which the executable runs, unless that component itself accompanies the executable.

If distribution of executable or object code is made by offering access to copy from a designated place, then offering equivalent access to copy the source code from the same place counts as distribution of the source code, even though third parties are not compelled to copy the source along with the object code.

4. You may not copy, modify, sublicense, or distribute the Program except as expressly provided under this License. Any attempt otherwise to copy, modify, sublicense or distribute the Program is void, and will automatically terminate your rights under this License. However, parties who have received copies, or rights, from you under this License will not have their licenses terminated so long as such parties remain in full compliance.

5. You are not required to accept this License, since you have not signed it. However, nothing else grants you permission to modify or distribute the Program or its derivative works. These actions are prohibited by law if you do not accept this License. Therefore, by modifying or distributing the Program (or any work based on the Program), you indicate your acceptance of this License to do so, and all its terms and conditions for copying, distributing or modifying the Program or works based on it.

6. Each time you redistribute the Program (or any work based on the Program), the recipient automatically receives a license from the original licensor to copy, distribute or modify the Program subject to these terms and conditions. You may not impose any further restrictions on the recipients' exercise of the rights granted herein. You are not responsible for enforcing compliance by third parties to this License.

7. If, as a consequence of a court judgment or allegation of patent infringement or for any other reason (not limited to patent issues), conditions are imposed on you (whether by court order, agreement or otherwise) that contradict the conditions of this License, they do not excuse you from the conditions of this License. If you cannot distribute so as to satisfy simultaneously your obligations under this License and any other pertinent obligations, then as a consequence you may not distribute the Program at all. For example, if a patent license would not permit royalty-free redistribution of the Program by all those who receive copies directly or indirectly through you, then the only way you could satisfy both it and this License would be to refrain entirely from distribution of the Program.

If any portion of this section is held invalid or unenforceable under any particular circumstance, the balance of the section is intended to apply and the section as a whole is intended to apply in other circumstances.

It is not the purpose of this section to induce you to infringe any patents or other property right claims or to contest validity of any such claims; this section has the sole purpose of protecting the integrity of the free software distribution system, which is implemented by public license practices. Many people have made generous contributions to the wide range of software distributed through that system in reliance on consistent application of that system; it is up to the author/donor to decide if he or she is willing to distribute software through any other system and a licensee cannot impose that choice.

This section is intended to make thoroughly clear what is believed to be a consequence of the rest of this License.

8. If the distribution and/or use of the Program is restricted in certain countries either by patents or by copyrighted interfaces, the original copyright holder who places the Program under this License may add an explicit geographical distribution limitation excluding those countries, so that distribution is permitted only in or among countries not thus excluded. In such case, this License incorporates the limitation as if written in the body of this License.

9. The Free Software Foundation may publish revised and/or new versions of the General Public License from time to time. Such new versions will be similar in spirit to the present version, but may differ in detail to address new problems or concerns.

Each version is given a distinguishing version number. If the Program specifies a version number of this License which applies to it and “any later version”, you have the option of following the terms and conditions either of that version or of any later version published by the Free Software Foundation. If the Program does not specify a version number of this License, you may choose any version ever published by the Free Software Foundation.

10. If you wish to incorporate parts of the Program into other free programs whose distribution conditions are different, write to the author to ask for permission. For software which is copyrighted by the Free Software Foundation, write to the Free Software Foundation; we sometimes make exceptions for this. Our decision will be guided by the two goals of preserving the free status of all derivatives of our free software and of promoting the sharing and reuse of software generally.

NO WARRANTY

11. BECAUSE THE PROGRAM IS LICENSED FREE OF CHARGE, THERE IS NO WARRANTY FOR THE PROGRAM, TO THE EXTENT PERMITTED BY APPLICABLE LAW. EXCEPT WHEN OTHERWISE STATED IN WRITING THE COPYRIGHT HOLDERS AND/OR OTHER PARTIES PROVIDE THE PROGRAM “AS IS” WITHOUT WARRANTY OF ANY KIND, EITHER EXPRESSED OR IMPLIED, INCLUDING, BUT NOT LIMITED TO, THE IMPLIED WARRANTIES OF MERCHANTABILITY AND FITNESS FOR A PARTICULAR PURPOSE. THE ENTIRE RISK AS TO THE QUALITY AND PERFORMANCE OF THE PROGRAM IS WITH YOU. SHOULD THE PROGRAM PROVE DEFECTIVE, YOU ASSUME THE COST OF ALL NECESSARY SERVICING, REPAIR OR CORRECTION.

12. IN NO EVENT UNLESS REQUIRED BY APPLICABLE LAW OR AGREED TO IN WRITING WILL ANY COPYRIGHT HOLDER, OR ANY OTHER PARTY WHO MAY MODIFY AND/OR REDISTRIBUTE THE PROGRAM AS PERMITTED ABOVE, BE LIABLE TO YOU FOR DAMAGES, INCLUDING ANY GENERAL, SPECIAL, INCIDENTAL OR CONSEQUENTIAL DAMAGES ARISING OUT OF THE USE OR INABILITY TO USE THE PROGRAM (INCLUDING BUT NOT LIMITED TO LOSS OF DATA OR DATA BEING RENDERED INACCURATE OR LOSSES SUSTAINED BY YOU OR THIRD PARTIES OR A FAILURE OF THE PROGRAM TO OPERATE WITH ANY OTHER PROGRAMS), EVEN IF SUCH HOLDER OR OTHER PARTY HAS BEEN ADVISED OF THE POSSIBILITY OF SUCH DAMAGES.

END OF TERMS AND CONDITIONS

How to Apply These Terms to Your New Programs

If you develop a new program, and you want it to be of the greatest possible use to the public, the best way to achieve this is to make it free software which everyone can redistribute and change under these terms.

To do so, attach the following notices to the program. It is safest to attach them to the start of each source file to most effectively convey the exclusion of warranty; and each file should have at least the "copyright" line and a pointer to where the full notice is found.

```
<one line to give the program's name and a brief idea of what it does. >  
Copyright (C) <year > <name of author >
```

This program is free software; you can redistribute it and/or modify it under the terms of the GNU General Public License as published by the Free Software Foundation; either version 2 of the License, or (at your option) any later version.

This program is distributed in the hope that it will be useful, but WITHOUT ANY WARRANTY; without even the implied warranty of MERCHANTABILITY or FITNESS FOR A PARTICULAR PURPOSE. See the GNU General Public License for more details.

You should have received a copy of the GNU General Public License along with this program; if not, write to the Free Software Foundation, Inc., 51 Franklin St, Fifth Floor, Boston, MA 02110-1301 USA

Also add information on how to contact you by electronic and paper mail.

If the program is interactive, make it output a short notice like this when it starts in an interactive mode:

```
Gnomovision version 69, Copyright (C) year name of author
```

```
Gnomovision comes with ABSOLUTELY NO WARRANTY; for details type 'show w'.
```

```
This is free software, and you are welcome to redistribute it under certain conditions; type 'show c'  
for details.
```

The hypothetical commands 'show w' and 'show c' should show the appropriate parts of the General Public License. Of course, the commands you use may be called something other than 'show w' and 'show c'; they could even be mouse-clicks or menu items--whatever suits your program.

You should also get your employer (if you work as a programmer) or your school, if any, to sign a "copyright disclaimer" for the program, if necessary. Here is a sample; alter the names:

Yoyodyne, Inc., hereby disclaims all copyright interest in the program 'Gnomovision' (which makes passes at compilers) written by James Hacker.

```
<signature of Ty Coon > , 1 April 1989  
Ty Coon, President of Vice
```

This General Public License does not permit incorporating your program into proprietary programs. If your program is a subroutine library, you may consider it more useful to permit linking proprietary applications with the library. If this is what you want to do, use the GNU Library General Public License instead of this License.

GNU General Public License (Version 3)

Below is the GNU General Public License.

Version 3, 29 June 2007

Copyright © 2007 Free Software Foundation, Inc. <<http://fsf.org/>>

Everyone is permitted to copy and distribute verbatim copies of this license document, but changing it is not allowed.

Preamble

The GNU General Public License is a free, copyleft license for software and other kinds of works.

The licenses for most software and other practical works are designed to take away your freedom to share and change the works. By contrast, the GNU General Public License is intended to guarantee your freedom to share and change all versions of a program--to make sure it remains free software for all its users. We, the Free Software Foundation, use the GNU General Public License for most of our software; it applies also to any other work released this way by its authors. You can apply it to your programs, too.

When we speak of free software, we are referring to freedom, not price. Our General Public Licenses are designed to make sure that you have the freedom to distribute copies of free software (and charge for them if you wish), that you receive source code or can get it if you want it, that you can change the software or use pieces of it in new free programs, and that you know you can do these things.

To protect your rights, we need to prevent others from denying you these rights or asking you to surrender the rights. Therefore, you have certain responsibilities if you distribute copies of the software, or if you modify it: responsibilities to respect the freedom of others.

For example, if you distribute copies of such a program, whether gratis or for a fee, you must pass on to the recipients the same freedoms that you received. You must make sure that they, too, receive or can get the source code. And you must show them these terms so they know their rights.

Developers that use the GNU GPL protect your rights with two steps: (1) assert copyright on the software, and (2) offer you this License giving you legal permission to copy, distribute and/or modify it.

For the developers' and authors' protection, the GPL clearly explains that there is no warranty for this free software. For both users' and authors' sake, the GPL requires that modified versions be marked as changed, so that their problems will not be attributed erroneously to authors of previous versions.

Some devices are designed to deny users access to install or run modified versions of the software inside them, although the manufacturer can do so. This is fundamentally incompatible with the aim of protecting users' freedom to change the software. The systematic pattern of such abuse occurs in the area of products for individuals to use, which is precisely where it is most unacceptable.

Therefore, we have designed this version of the GPL to prohibit the practice for those products. If such problems arise substantially in other domains, we stand ready to extend this provision to those domains in future versions of the GPL, as needed to protect the freedom of users.

Finally, every program is threatened constantly by software patents. States should not allow patents to restrict development and use of software on general-purpose computers, but in those that do, we wish to avoid the special danger that patents applied to a free program could make it effectively proprietary. To prevent this, the GPL assures that patents cannot be used to render the program non-free.

The precise terms and conditions for copying, distribution and modification follow.

TERMS AND CONDITIONS

0. Definitions

“This License” refers to version 3 of the GNU General Public License.

“Copyright” also means copyright-like laws that apply to other kinds of works, such as semiconductor masks.

“The Program” refers to any copyrightable work licensed under this License. Each licensee is addressed as “you”. “Licensees” and “recipients” may be individuals or organizations.

To “modify” a work means to copy from or adapt all or part of the work in a fashion requiring copyright permission, other than the making of an exact copy. The resulting work is called a “modified version” of the earlier work or a work “based on” the earlier work.

A “covered work” means either the unmodified Program or a work based on the Program.

To “propagate” a work means to do anything with it that, without permission, would make you directly or secondarily liable for infringement under applicable copyright law, except executing it on a computer or modifying a private copy. Propagation includes copying, distribution (with or without modification), making available to the public, and in some countries other activities as well.

To “convey” a work means any kind of propagation that enables other parties to make or receive copies. Mere interaction with a user through a computer network, with no transfer of a copy, is not conveying.

An interactive user interface displays “Appropriate Legal Notices” to the extent that it includes a convenient and prominently visible feature that (1) displays an appropriate copyright notice, and (2) tells the user that there is no warranty for the work (except to the extent that warranties are provided), that licensees may convey the work under this License, and how to view a copy of this License. If the interface presents a list of user commands or options, such as a menu, a prominent item in the list meets this criterion.

1. Source Code.

The “source code” for a work means the preferred form of the work for making modifications to it. “Object code” means any non-source form of a work.

A “Standard Interface” means an interface that either is an official standard defined by a recognized standards body, or, in the case of interfaces specified for a particular programming language, one that is widely used among developers working in that language.

The “System Libraries” of an executable work include anything, other than the work as a whole, that (a) is included in the normal form of packaging a Major Component, but which is not part of that Major Component, and (b) serves only to enable use of the work with that Major Component, or to implement a Standard Interface for which an implementation is available to the public in source code form. A “Major Component”, in this context, means a major essential component (kernel, window system, and so on) of the specific operating system (if any) on which the executable work runs, or a compiler used to produce the work, or an object code interpreter used to run it.

The “Corresponding Source” for a work in object code form means all the source code needed to generate, install, and (for an executable work) run the object code and to modify the work, including scripts to control those activities. However, it does not include the work’s System Libraries, or general-purpose tools or generally available free programs which are used unmodified in performing those activities but which are not part of the work. For example, Corresponding Source includes interface definition files associated with source files for the work, and the source code for shared libraries and dynamically linked subprograms that the work is specifically designed to require, such as by intimate data communication or control flow between those subprograms and other parts of the work.

The Corresponding Source need not include anything that users can regenerate automatically from other parts of the Corresponding Source.

The Corresponding Source for a work in source code form is that same work.

2. Basic Permissions.

All rights granted under this License are granted for the term of copyright on the Program, and are irrevocable provided the stated conditions are met. This License explicitly affirms your unlimited permission to run the unmodified Program. The output from running a covered work is covered by this License only if the output, given its content, constitutes a covered work. This License acknowledges your rights of fair use or other equivalent, as provided by copyright law.

You may make, run and propagate covered works that you do not convey, without conditions so long as your license otherwise remains in force. You may convey covered works to others for the sole purpose of having them make modifications exclusively for you, or provide you with facilities for running those works, provided that you comply with the terms of this License in conveying all material for which you do not control copyright. Those thus making or running the covered works for you must do so exclusively on your behalf, under your direction and control, on terms that prohibit them from making any copies of your copyrighted material outside their relationship with you.

Conveying under any other circumstances is permitted solely under the conditions stated below. Sublicensing is not allowed; section 10 makes it unnecessary.

3. Protecting Users' Legal Rights From Anti-Circumvention Law.

No covered work shall be deemed part of an effective technological measure under any applicable law fulfilling obligations under article 11 of the WIPO copyright treaty adopted on 20 December 1996, or similar laws prohibiting or restricting circumvention of such measures.

When you convey a covered work, you waive any legal power to forbid circumvention of technological measures to the extent such circumvention is effected by exercising rights under this License with respect to the covered work, and you disclaim any intention to limit operation or modification of the work as a means of enforcing, against the work's users, your or third parties' legal rights to forbid circumvention of technological measures.

4. Conveying Verbatim Copies.

You may convey verbatim copies of the Program's source code as you receive it, in any medium, provided that you conspicuously and appropriately publish on each copy an appropriate copyright notice; keep intact all notices stating that this License and any non-permissive terms added in accord with section 7 apply to the code; keep intact all notices of the absence of any warranty; and give all recipients a copy of this License along with the Program.

You may charge any price or no price for each copy that you convey, and you may offer support or warranty protection for a fee.

5. Conveying Modified Source Versions.

You may convey a work based on the Program, or the modifications to produce it from the Program, in the form of source code under the terms of section 4, provided that you also meet all of these conditions:

- a) The work must carry prominent notices stating that you modified it, and giving a relevant date.
- b) The work must carry prominent notices stating that it is released under this License and any conditions added under section 7. This requirement modifies the requirement in section 4 to "keep intact all notices".
- c) You must license the entire work, as a whole, under this License to anyone who comes into possession of a copy. This License will therefore apply, along with any applicable section 7 additional terms, to the whole of the work, and all its parts, regardless of how they are packaged. This License gives no permission to license the work in any other way, but it does not invalidate such permission if you have separately received it.
- d) If the work has interactive user interfaces, each must display Appropriate Legal Notices; however, if the Program has interactive interfaces that do not display Appropriate Legal Notices, your work need not make them do so.

A compilation of a covered work with other separate and independent works, which are not by their nature extensions of the covered work, and which are not combined with it such as to form a larger program, in or on a volume of a storage or distribution medium, is called an "aggregate" if the compilation and its resulting copyright are not used to limit the access or legal rights of the compilation's users beyond what the individual works permit. Inclusion of a covered work in an aggregate does not cause this License to apply to the other parts of the aggregate.

6. Conveying Non-Source Forms.

You may convey a covered work in object code form under the terms of sections 4 and 5, provided that you also convey the machine-readable Corresponding Source under the terms of this License, in one of these ways:

- a) Convey the object code in, or embodied in, a physical product (including a physical distribution medium), accompanied by the Corresponding Source fixed on a durable physical medium customarily used for software interchange.
- b) Convey the object code in, or embodied in, a physical product (including a physical distribution medium), accompanied by a written offer, valid for at least three years and valid for as long as you offer spare parts or customer support for that product model, to give anyone who possesses the object code either (1) a copy of the Corresponding Source for all the software in the product that is covered by this License, on a durable physical medium customarily used for software interchange, for a price no more than your reasonable cost of physically performing this conveying of source, or (2) access to copy the Corresponding Source from a network server at no charge.
- c) Convey individual copies of the object code with a copy of the written offer to provide the Corresponding Source. This alternative is allowed only occasionally and noncommercially, and only if you received the object code with such an offer, in accord with subsection 6b.
- d) Convey the object code by offering access from a designated place (gratis or for a charge), and offer equivalent access to the Corresponding Source in the same way through the same place at no further charge. You need not require recipients to copy the Corresponding Source along with the object code. If the place to copy the object code is a network server, the Corresponding Source may be on a different server (operated by you or a third party) that supports equivalent copying facilities, provided you maintain clear directions next to the object code saying where to find the Corresponding Source. Regardless of what server hosts the Corresponding Source, you remain obligated to ensure that it is available for as long as needed to satisfy these requirements.
- e) Convey the object code using peer-to-peer transmission, provided you inform other peers where the object code and Corresponding Source of the work are being offered to the general public at no charge under subsection 6d.

A separable portion of the object code, whose source code is excluded from the Corresponding Source as a System Library, need not be included in conveying the object code work.

A “User Product” is either (1) a “consumer product”, which means any tangible personal property which is normally used for personal, family, or household purposes, or (2) anything designed or sold for incorporation into a dwelling. In determining whether a product is a consumer product, doubtful cases shall be resolved in favor of coverage. For a particular product received by a particular user, “normally used” refers to a typical or common use of that class of product, regardless of the status of the particular user or of the way in which the particular user actually uses, or expects or is expected to use, the product. A product is a consumer product regardless of whether the product has substantial commercial, industrial or non-consumer uses, unless such uses represent the only significant mode of use of the product.

“Installation Information” for a User Product means any methods, procedures, authorization keys, or other information required to install and execute modified versions of a covered work in that User

Product from a modified version of its Corresponding Source. The information must suffice to ensure that the continued functioning of the modified object code is in no case prevented or interfered with solely because modification has been made.

If you convey an object code work under this section in, or with, or specifically for use in, a User Product, and the conveying occurs as part of a transaction in which the right of possession and use of the User Product is transferred to the recipient in perpetuity or for a fixed term (regardless of how the transaction is characterized), the Corresponding Source conveyed under this section must be accompanied by the Installation Information. But this requirement does not apply if neither you nor any third party retains the ability to install modified object code on the User Product (for example, the work has been installed in ROM).

The requirement to provide Installation Information does not include a requirement to continue to provide support service, warranty, or updates for a work that has been modified or installed by the recipient, or for the User Product in which it has been modified or installed. Access to a network may be denied when the modification itself materially and adversely affects the operation of the network or violates the rules and protocols for communication across the network.

Corresponding Source conveyed, and Installation Information provided, in accord with this section must be in a format that is publicly documented (and with an implementation available to the public in source code form), and must require no special password or key for unpacking, reading or copying.

7. Additional Terms.

“Additional permissions” are terms that supplement the terms of this License by making exceptions from one or more of its conditions. Additional permissions that are applicable to the entire Program shall be treated as though they were included in this License, to the extent that they are valid under applicable law. If additional permissions apply only to part of the Program, that part may be used separately under those permissions, but the entire Program remains governed by this License without regard to the additional permissions.

When you convey a copy of a covered work, you may at your option remove any additional permissions from that copy, or from any part of it. (Additional permissions may be written to require their own removal in certain cases when you modify the work.) You may place additional permissions on material, added by you to a covered work, for which you have or can give appropriate copyright permission.

Notwithstanding any other provision of this License, for material you add to a covered work, you may (if authorized by the copyright holders of that material) supplement the terms of this License with terms:

- a) Disclaiming warranty or limiting liability differently from the terms of sections 15 and 16 of this License; or
- b) Requiring preservation of specified reasonable legal notices or author attributions in that material or in the Appropriate Legal Notices displayed by works containing it; or
- c) Prohibiting misrepresentation of the origin of that material, or requiring that modified versions of such material be marked in reasonable ways as different from the original version; or
- d) Limiting the use for publicity purposes of names of licensors or authors of the material; or

e) Declining to grant rights under trademark law for use of some trade names, trademarks, or service marks; or

f) Requiring indemnification of licensors and authors of that material by anyone who conveys the material (or modified versions of it) with contractual assumptions of liability to the recipient, for any liability that these contractual assumptions directly impose on those licensors and authors.

All other non-permissive additional terms are considered “further restrictions” within the meaning of section 10. If the Program as you received it, or any part of it, contains a notice stating that it is governed by this License along with a term that is a further restriction, you may remove that term. If a license document contains a further restriction but permits relicensing or conveying under this License, you may add to a covered work material governed by the terms of that license document, provided that the further restriction does not survive such relicensing or conveying.

If you add terms to a covered work in accord with this section, you must place, in the relevant source files, a statement of the additional terms that apply to those files, or a notice indicating where to find the applicable terms.

Additional terms, permissive or non-permissive, may be stated in the form of a separately written license, or stated as exceptions; the above requirements apply either way.

8. Termination.

You may not propagate or modify a covered work except as expressly provided under this License. Any attempt otherwise to propagate or modify it is void, and will automatically terminate your rights under this License (including any patent licenses granted under the third paragraph of section 11).

However, if you cease all violation of this License, then your license from a particular copyright holder is reinstated (a) provisionally, unless and until the copyright holder explicitly and finally terminates your license, and (b) permanently, if the copyright holder fails to notify you of the violation by some reasonable means prior to 60 days after the cessation.

Moreover, your license from a particular copyright holder is reinstated permanently if the copyright holder notifies you of the violation by some reasonable means, this is the first time you have received notice of violation of this License (for any work) from that copyright holder, and you cure the violation prior to 30 days after your receipt of the notice.

Termination of your rights under this section does not terminate the licenses of parties who have received copies or rights from you under this License. If your rights have been terminated and not permanently reinstated, you do not qualify to receive new licenses for the same material under section 10.

9. Acceptance Not Required for Having Copies.

You are not required to accept this License in order to receive or run a copy of the Program. Ancillary propagation of a covered work occurring solely as a consequence of using peer-to-peer transmission to receive a copy likewise does not require acceptance. However, nothing other than this License grants you permission to propagate or modify any covered work. These actions infringe copyright if you do not accept this License. Therefore, by modifying or propagating a covered work, you indicate your acceptance of this License to do so.

10. Automatic Licensing of Downstream Recipients.

Each time you convey a covered work, the recipient automatically receives a license from the original licensors, to run, modify and propagate that work, subject to this License. You are not responsible for enforcing compliance by third parties with this License.

An “entity transaction” is a transaction transferring control of an organization, or substantially all assets of one, or subdividing an organization, or merging organizations. If propagation of a covered work results from an entity transaction, each party to that transaction who receives a copy of the work also receives whatever licenses to the work the party's predecessor in interest had or could give under the previous paragraph, plus a right to possession of the Corresponding Source of the work from the predecessor in interest, if the predecessor has it or can get it with reasonable efforts.

You may not impose any further restrictions on the exercise of the rights granted or affirmed under this License. For example, you may not impose a license fee, royalty, or other charge for exercise of rights granted under this License, and you may not initiate litigation (including a cross-claim or counterclaim in a lawsuit) alleging that any patent claim is infringed by making, using, selling, offering for sale, or importing the Program or any portion of it.

11. Patents.

A “contributor” is a copyright holder who authorizes use under this License of the Program or a work on which the Program is based. The work thus licensed is called the contributor's “contributor version”.

A contributor's “essential patent claims” are all patent claims owned or controlled by the contributor, whether already acquired or hereafter acquired, that would be infringed by some manner, permitted by this License, of making, using, or selling its contributor version, but do not include claims that would be infringed only as a consequence of further modification of the contributor version. For purposes of this definition, “control” includes the right to grant patent sublicenses in a manner consistent with the requirements of this License.

Each contributor grants you a non-exclusive, worldwide, royalty-free patent license under the contributor's essential patent claims, to make, use, sell, offer for sale, import and otherwise run, modify and propagate the contents of its contributor version.

In the following three paragraphs, a “patent license” is any express agreement or commitment, however denominated, not to enforce a patent (such as an express permission to practice a patent or covenant not to sue for patent infringement). To “grant” such a patent license to a party means to make such an agreement or commitment not to enforce a patent against the party.

If you convey a covered work, knowingly relying on a patent license, and the Corresponding Source of the work is not available for anyone to copy, free of charge and under the terms of this License, through a publicly available network server or other readily accessible means, then you must either (1) cause the Corresponding Source to be so available, or (2) arrange to deprive yourself of the benefit of the patent license for this particular work, or (3) arrange, in a manner consistent with the requirements of this License, to extend the patent license to downstream recipients. “Knowingly relying” means you have actual knowledge that, but for the patent license, your conveying the covered work in a country, or your recipient's use of the covered work in a country, would infringe one or more identifiable patents in that country that you have reason to believe are valid.

If, pursuant to or in connection with a single transaction or arrangement, you convey, or propagate by procuring conveyance of, a covered work, and grant a patent license to some of the parties receiving the covered work authorizing them to use, propagate, modify or convey a specific copy of the covered work, then the patent license you grant is automatically extended to all recipients of the covered work and works based on it.

A patent license is “discriminatory” if it does not include within the scope of its coverage, prohibits the exercise of, or is conditioned on the non-exercise of one or more of the rights that are specifically granted under this License. You may not convey a covered work if you are a party to an arrangement with a third party that is in the business of distributing software, under which you make payment to the third party based on the extent of your activity of conveying the work, and under which the third party grants, to any of the parties who would receive the covered work from you, a discriminatory patent license (a) in connection with copies of the covered work conveyed by you (or copies made from those copies), or (b) primarily for and in connection with specific products or compilations that contain the covered work, unless you entered into that arrangement, or that patent license was granted, prior to 28 March 2007.

Nothing in this License shall be construed as excluding or limiting any implied license or other defenses to infringement that may otherwise be available to you under applicable patent law.

12. No Surrender of Others' Freedom.

If conditions are imposed on you (whether by court order, agreement or otherwise) that contradict the conditions of this License, they do not excuse you from the conditions of this License. If you cannot convey a covered work so as to satisfy simultaneously your obligations under this License and any other pertinent obligations, then as a consequence you may not convey it at all. For example, if you agree to terms that obligate you to collect a royalty for further conveying from those to whom you convey the Program, the only way you could satisfy both those terms and this License would be to refrain entirely from conveying the Program.

13. Use with the GNU Affero General Public License.

Notwithstanding any other provision of this License, you have permission to link or combine any covered work with a work licensed under version 3 of the GNU Affero General Public License into a single combined work, and to convey the resulting work. The terms of this License will continue to apply to the part which is the covered work, but the special requirements of the GNU Affero General Public License, section 13, concerning interaction through a network will apply to the combination as such.

14. Revised Versions of this License.

The Free Software Foundation may publish revised and/or new versions of the GNU General Public License from time to time. Such new versions will be similar in spirit to the present version, but may differ in detail to address new problems or concerns.

Each version is given a distinguishing version number. If the Program specifies that a certain numbered version of the GNU General Public License “or any later version” applies to it, you have the option of following the terms and conditions either of that numbered version or of any later version published by the Free Software Foundation. If the Program does not specify a version

number of the GNU General Public License, you may choose any version ever published by the Free Software Foundation.

If the Program specifies that a proxy can decide which future versions of the GNU General Public License can be used, that proxy's public statement of acceptance of a version permanently authorizes you to choose that version for the Program.

Later license versions may give you additional or different permissions. However, no additional obligations are imposed on any author or copyright holder as a result of your choosing to follow a later version.

15. Disclaimer of Warranty.

THERE IS NO WARRANTY FOR THE PROGRAM, TO THE EXTENT PERMITTED BY APPLICABLE LAW. EXCEPT WHEN OTHERWISE STATED IN WRITING THE COPYRIGHT HOLDERS AND/OR OTHER PARTIES PROVIDE THE PROGRAM "AS IS" WITHOUT WARRANTY OF ANY KIND, EITHER EXPRESSED OR IMPLIED, INCLUDING, BUT NOT LIMITED TO, THE IMPLIED WARRANTIES OF MERCHANTABILITY AND FITNESS FOR A PARTICULAR PURPOSE. THE ENTIRE RISK AS TO THE QUALITY AND PERFORMANCE OF THE PROGRAM IS WITH YOU. SHOULD THE PROGRAM PROVE DEFECTIVE, YOU ASSUME THE COST OF ALL NECESSARY SERVICING, REPAIR OR CORRECTION.

16. Limitation of Liability.

IN NO EVENT UNLESS REQUIRED BY APPLICABLE LAW OR AGREED TO IN WRITING WILL ANY COPYRIGHT HOLDER, OR ANY OTHER PARTY WHO MODIFIES AND/OR CONVEYS THE PROGRAM AS PERMITTED ABOVE, BE LIABLE TO YOU FOR DAMAGES, INCLUDING ANY GENERAL, SPECIAL, INCIDENTAL OR CONSEQUENTIAL DAMAGES ARISING OUT OF THE USE OR INABILITY TO USE THE PROGRAM (INCLUDING BUT NOT LIMITED TO LOSS OF DATA OR DATA BEING RENDERED INACCURATE OR LOSSES SUSTAINED BY YOU OR THIRD PARTIES OR A FAILURE OF THE PROGRAM TO OPERATE WITH ANY OTHER PROGRAMS), EVEN IF SUCH HOLDER OR OTHER PARTY HAS BEEN ADVISED OF THE POSSIBILITY OF SUCH DAMAGES.

17. Interpretation of Sections 15 and 16.

If the disclaimer of warranty and limitation of liability provided above cannot be given local legal effect according to their terms, reviewing courts shall apply local law that most closely approximates an absolute waiver of all civil liability in connection with the Program, unless a warranty or assumption of liability accompanies a copy of the Program in return for a fee.

END OF TERMS AND CONDITIONS

How to Apply These Terms to Your New Programs

If you develop a new program, and you want it to be of the greatest possible use to the public, the best way to achieve this is to make it free software which everyone can redistribute and change under these terms.

To do so, attach the following notices to the program. It is safest to attach them to the start of each source file to most effectively state the exclusion of warranty; and each file should have at least the “copyright” line and a pointer to where the full notice is found.

<one line to give the program's name and a brief idea of what it does. >

Copyright (C) <year > <name of author >

This program is free software: you can redistribute it and/or modify it under the terms of the GNU General Public License as published by the Free Software Foundation, either version 3 of the License, or (at your option) any later version.

This program is distributed in the hope that it will be useful, but WITHOUT ANY WARRANTY; without even the implied warranty of MERCHANTABILITY or FITNESS FOR A PARTICULAR PURPOSE. See the GNU General Public License for more details.

You should have received a copy of the GNU General Public License along with this program. If not, see <<http://www.gnu.org/licenses/>>.

Also add information on how to contact you by electronic and paper mail.

If the program does terminal interaction, make it output a short notice like this when it starts in an interactive mode:

<program > Copyright (C) <year > <name of author >

This program comes with ABSOLUTELY NO WARRANTY; for details type 'show w'.

This is free software, and you are welcome to redistribute it under certain conditions; type `show c' for details.

The hypothetical commands 'show w' and 'show c' should show the appropriate parts of the General Public License. Of course, your program's commands might be different; for a GUI interface, you would use an “about box”.

You should also get your employer (if you work as a programmer) or school, if any, to sign a “copyright disclaimer” for the program, if necessary. For more information on this, and how to apply and follow the GNU GPL, see <<http://www.gnu.org/licenses/>>.

The GNU General Public License does not permit incorporating your program into proprietary programs. If your program is a subroutine library, you may consider it more useful to permit linking proprietary applications with the library. If this is what you want to do, use the GNU Lesser General Public License instead of this License. But first, please read <<http://www.gnu.org/philosophy/why-not-lgpl.html>>.

GNU Lesser General Public License (Version 2.1)

Below is the GNU Lesser General Public License.

Version 2.1, February 1999

Copyright (C) 1991, 1999 Free Software Foundation, Inc.

51 Franklin Street, Fifth Floor, Boston, MA 02110-1301 USA

Everyone is permitted to copy and distribute verbatim copies of this license document, but changing it is not allowed.

[This is the first released version of the Lesser GPL. It also counts as the successor of the GNU Library Public License, version 2, hence the version number 2.1.]

Preamble

The licenses for most software are designed to take away your freedom to share and change it. By contrast, the GNU General Public Licenses are intended to guarantee your freedom to share and change free software--to make sure the software is free for all its users.

This license, the Lesser General Public License, applies to some specially designated software packages--typically libraries--of the Free Software Foundation and other authors who decide to use it. You can use it too, but we suggest you first think carefully about whether this license or the ordinary General Public License is the better strategy to use in any particular case, based on the explanations below.

When we speak of free software, we are referring to freedom of use, not price. Our General Public Licenses are designed to make sure that you have the freedom to distribute copies of free software (and charge for this service if you wish); that you receive source code or can get it if you want it; that you can change the software and use pieces of it in new free programs; and that you are informed that you can do these things.

To protect your rights, we need to make restrictions that forbid distributors to deny you these rights or to ask you to surrender these rights. These restrictions translate to certain responsibilities for you if you distribute copies of the library or if you modify it.

For example, if you distribute copies of the library, whether gratis or for a fee, you must give the recipients all the rights that we gave you. You must make sure that they, too, receive or can get the source code. If you link other code with the library, you must provide complete object files to the recipients, so that they can relink them with the library after making changes to the library and recompiling it. And you must show them these terms so they know their rights.

We protect your rights with a two-step method: (1) we copyright the library, and (2) we offer you this license, which gives you legal permission to copy, distribute and/or modify the library.

To protect each distributor, we want to make it very clear that there is no warranty for the free library. Also, if the library is modified by someone else and passed on, the recipients should know that what they have is not the original version, so that the original author's reputation will not be affected by problems that might be introduced by others.

Finally, software patents pose a constant threat to the existence of any free program. We wish to make sure that a company cannot effectively restrict the users of a free program by obtaining a restrictive license from a patent holder. Therefore, we insist that any patent license obtained for a version of the library must be consistent with the full freedom of use specified in this license.

Most GNU software, including some libraries, is covered by the ordinary GNU General Public License. This license, the GNU Lesser General Public License, applies to certain designated

libraries, and is quite different from the ordinary General Public License. We use this license for certain libraries in order to permit linking those libraries into non-free programs.

When a program is linked with a library, whether statically or using a shared library, the combination of the two is legally speaking a combined work, a derivative of the original library. The ordinary General Public License therefore permits such linking only if the entire combination fits its criteria of freedom. The Lesser General Public License permits more lax criteria for linking other code with the library.

We call this license the "Lesser" General Public License because it does Less to protect the user's freedom than the ordinary General Public License. It also provides other free software developers Less of an advantage over competing non-free programs. These disadvantages are the reason we use the ordinary General Public License for many libraries. However, the Lesser license provides advantages in certain special circumstances.

For example, on rare occasions, there may be a special need to encourage the widest possible use of a certain library, so that it becomes a de-facto standard. To achieve this, non-free programs must be allowed to use the library. A more frequent case is that a free library does the same job as widely used non-free libraries. In this case, there is little to gain by limiting the free library to free software only, so we use the Lesser General Public License.

In other cases, permission to use a particular library in non-free programs enables a greater number of people to use a large body of free software. For example, permission to use the GNU C Library in non-free programs enables many more people to use the whole GNU operating system, as well as its variant, the GNU/Linux operating system.

Although the Lesser General Public License is Less protective of the users' freedom, it does ensure that the user of a program that is linked with the Library has the freedom and the wherewithal to run that program using a modified version of the Library. The precise terms and conditions for copying, distribution and modification follow. Pay close attention to the difference between a "work based on the library" and a "work that uses the library". The former contains code derived from the library, whereas the latter must be combined with the library in order to run.

TERMS AND CONDITIONS FOR COPYING, DISTRIBUTION AND MODIFICATION

0. This License Agreement applies to any software library or other program which contains a notice placed by the copyright holder or other authorized party saying it may be distributed under the terms of this Lesser General Public License (also called "this License"). Each licensee is addressed as "you".

A "library" means a collection of software functions and/or data prepared so as to be conveniently linked with application programs (which use some of those functions and data) to form executables.

The "Library", below, refers to any such software library or work which has been distributed under these terms. A "work based on the Library" means either the Library or any derivative work under copyright law: that is to say, a work containing the Library or a portion of it, either verbatim or with modifications and/or translated straightforwardly into another language. (Hereinafter, translation is included without limitation in the term "modification".)

"Source code" for a work means the preferred form of the work for making modifications to it. For a library, complete source code means all the source code for all modules it contains, plus any associated interface definition files, plus the scripts used to control compilation and installation of the library.

Activities other than copying, distribution and modification are not covered by this License; they are outside its scope. The act of running a program using the Library is not restricted, and output from such a program is covered only if its contents constitute a work based on the Library (independent of the use of the Library in a tool for writing it). Whether that is true depends on what the Library does and what the program that uses the Library does.

1. You may copy and distribute verbatim copies of the Library's complete source code as you receive it, in any medium, provided that you conspicuously and appropriately publish on each copy an appropriate copyright notice and disclaimer of warranty; keep intact all the notices that refer to this License and to the absence of any warranty; and distribute a copy of this License along with the Library.

You may charge a fee for the physical act of transferring a copy, and you may at your option offer warranty protection in exchange for a fee.

2. You may modify your copy or copies of the Library or any portion of it, thus forming a work based on the Library, and copy and distribute such modifications or work under the terms of Section 1 above, provided that you also meet all of these conditions:

a) The modified work must itself be a software library.

b) You must cause the files modified to carry prominent notices stating that you changed the files and the date of any change.

c) You must cause the whole of the work to be licensed at no charge to all third parties under the terms of this License.

d) If a facility in the modified Library refers to a function or a table of data to be supplied by an application program that uses the facility, other than as an argument passed when the facility is invoked, then you must make a good faith effort to ensure that, in the event an application does not supply such function or table, the facility still operates, and performs whatever part of its purpose remains meaningful.

(For example, a function in a library to compute square roots has a purpose that is entirely well-defined independent of the application. Therefore, Subsection 2d requires that any application-supplied function or table used by this function must be optional: if the application does not supply it, the square root function must still compute square roots.)

These requirements apply to the modified work as a whole. If identifiable sections of that work are not derived from the Library, and can be reasonably considered independent and separate works in themselves, then this License, and its terms, do not apply to those sections when you distribute them as separate works. But when you distribute the same sections as part of a whole which is a work based on the Library, the distribution of the whole must be on the terms of this License, whose permissions for other licensees extend to the entire whole, and thus to each and every part regardless of who wrote it.

Thus, it is not the intent of this section to claim rights or contest your rights to work written entirely by you; rather, the intent is to exercise the right to control the distribution of derivative or collective works based on the Library.

In addition, mere aggregation of another work not based on the Library with the Library (or with a work based on the Library) on a volume of a storage or distribution medium does not bring the other work under the scope of this License.

3. You may opt to apply the terms of the ordinary GNU General Public License instead of this License to a given copy of the Library. To do this, you must alter all the notices that refer to this License, so that they refer to the ordinary GNU General Public License, version 2, instead of to this License. (If a newer version than version 2 of the ordinary GNU General Public License has appeared, then you can specify that version instead if you wish.) Do not make any other change in these notices.

Once this change is made in a given copy, it is irreversible for that copy, so the ordinary GNU General Public License applies to all subsequent copies and derivative works made from that copy.

This option is useful when you wish to copy part of the code of the Library into a program that is not a library.

4. You may copy and distribute the Library (or a portion or derivative of it, under Section 2) in object code or executable form under the terms of Sections 1 and 2 above provided that you accompany it with the complete corresponding machine-readable source code, which must be distributed under the terms of Sections 1 and 2 above on a medium customarily used for software interchange.

If distribution of object code is made by offering access to copy from a designated place, then offering equivalent access to copy the source code from the same place satisfies the requirement to distribute the source code, even though third parties are not compelled to copy the source along with the object code.

5. A program that contains no derivative of any portion of the Library, but is designed to work with the Library by being compiled or linked with it, is called a "work that uses the Library". Such a work, in isolation, is not a derivative work of the Library, and therefore falls outside the scope of this License.

However, linking a "work that uses the Library" with the Library creates an executable that is a derivative of the Library (because it contains portions of the Library), rather than a "work that uses the library". The executable is therefore covered by this License. Section 6 states terms for distribution of such executables.

When a "work that uses the Library" uses material from a header file that is part of the Library, the object code for the work may be a derivative work of the Library even though the source code is not. Whether this is true is especially significant if the work can be linked without the Library, or if the work is itself a library. The threshold for this to be true is not precisely defined by law.

If such an object file uses only numerical parameters, data structure layouts and accessors, and small macros and small inline functions (ten lines or less in length), then the use of the object file is unrestricted, regardless of whether it is legally a derivative work. (Executables containing this object code plus portions of the Library will still fall under Section 6.)

Otherwise, if the work is a derivative of the Library, you may distribute the object code for the work under the terms of Section 6. Any executables containing that work also fall under Section 6, whether or not they are linked directly with the Library itself.

6. As an exception to the Sections above, you may also combine or link a "work that uses the Library" with the Library to produce a work containing portions of the Library, and distribute that work under terms of your choice, provided that the terms permit modification of the work for the customer's own use and reverse engineering for debugging such modifications.

You must give prominent notice with each copy of the work that the Library is used in it and that the Library and its use are covered by this License. You must supply a copy of this License. If the work during execution displays copyright notices, you must include the copyright notice for the Library among them, as well as a reference directing the user to the copy of this License. Also, you must do one of these things:

a) Accompany the work with the complete corresponding machine-readable source code for the Library including whatever changes were used in the work (which must be distributed under Sections 1 and 2 above); and, if the work is an executable linked with the Library, with the complete machine-readable "work that uses the Library", as object code and/or source code, so that the user can modify the Library and then relink to produce a modified executable containing the modified Library. (It is understood that the user who changes the contents of definitions files in the Library will not necessarily be able to recompile the application to use the modified definitions.)

b) Use a suitable shared library mechanism for linking with the Library. A suitable mechanism is one that (1) uses at run time a copy of the library already present on the user's computer system, rather than copying library functions into the executable, and (2) will operate properly with a modified version of the library, if the user installs one, as long as the modified version is interface-compatible with the version that the work was made with.

c) Accompany the work with a written offer, valid for at least three years, to give the same user the materials specified in Subsection 6a, above, for a charge no more than the cost of performing this distribution.

d) If distribution of the work is made by offering access to copy from a designated place, offer equivalent access to copy the above specified materials from the same place.

e) Verify that the user has already received a copy of these materials or that you have already sent this user a copy.

For an executable, the required form of the "work that uses the Library" must include any data and utility programs needed for reproducing the executable from it. However, as a special exception, the materials to be distributed need not include anything that is normally distributed (in either source or binary form) with the major components (compiler, kernel, and so on) of the operating system on which the executable runs, unless that component itself accompanies the executable.

It may happen that this requirement contradicts the license restrictions of other proprietary libraries that do not normally accompany the operating system. Such a contradiction means you cannot use both them and the Library together in an executable that you distribute.

7. You may place library facilities that are a work based on the Library side-by-side in a single library together with other library facilities not covered by this License, and distribute such a combined library, provided that the separate distribution of the work based on the Library and of the other library facilities is otherwise permitted, and provided that you do these two things:

a) Accompany the combined library with a copy of the same work based on the Library, uncombined with any other library facilities. This must be distributed under the terms of the Sections above.

b) Give prominent notice with the combined library of the fact that part of it is a work based on the Library, and explaining where to find the accompanying uncombined form of the same work.

8. You may not copy, modify, sublicense, link with, or distribute the Library except as expressly provided under this License. Any attempt otherwise to copy, modify, sublicense, link with, or distribute the Library is void, and will automatically terminate your rights under this License. However, parties who have received copies, or rights, from you under this License will not have their licenses terminated so long as such parties remain in full compliance.

9. You are not required to accept this License, since you have not signed it. However, nothing else grants you permission to modify or distribute the Library or its derivative works. These actions are prohibited by law if you do not accept this License. Therefore, by modifying or distributing the Library (or any work based on the Library), you indicate your acceptance of this License to do so, and all its terms and conditions for copying, distributing or modifying the Library or works based on it.

10. Each time you redistribute the Library (or any work based on the Library), the recipient automatically receives a license from the original licensor to copy, distribute, link with or modify the Library subject to these terms and conditions. You may not impose any further restrictions on the recipients' exercise of the rights granted herein. You are not responsible for enforcing compliance by third parties with this License.

11. If, as a consequence of a court judgment or allegation of patent infringement or for any other reason (not limited to patent issues), conditions are imposed on you (whether by court order, agreement or otherwise) that contradict the conditions of this License, they do not excuse you from the conditions of this License. If you cannot distribute so as to satisfy simultaneously your obligations under this License and any other pertinent obligations, then as a consequence you may not distribute the Library at all. For example, if a patent license would not permit royalty-free redistribution of the Library by all those who receive copies directly or indirectly through you, then the only way you could satisfy both it and this License would be to refrain entirely from distribution of the Library.

If any portion of this section is held invalid or unenforceable under any particular circumstance, the balance of the section is intended to apply, and the section as a whole is intended to apply in other circumstances.

It is not the purpose of this section to induce you to infringe any patents or other property right claims or to contest validity of any such claims; this section has the sole purpose of protecting the integrity of the free software distribution system which is implemented by public license practices. Many people have made generous contributions to the wide range of software distributed through that system in reliance on consistent application of that system; it is up to the author/donor to decide if he or she is willing to distribute software through any other system and a licensee cannot impose that choice.

This section is intended to make thoroughly clear what is believed to be a consequence of the rest of this License.

12. If the distribution and/or use of the Library is restricted in certain countries either by patents or by copyrighted interfaces, the original copyright holder who places the Library under this License may add an explicit geographical distribution limitation excluding those countries, so that distribution is permitted only in or among countries not thus excluded. In such case, this License incorporates the limitation as if written in the body of this License.

13. The Free Software Foundation may publish revised and/or new versions of the Lesser General Public License from time to time. Such new versions will be similar in spirit to the present version, but may differ in detail to address new problems or concerns.

Each version is given a distinguishing version number. If the Library specifies a version number of this License which applies to it and "any later version", you have the option of following the terms and conditions either of that version or of any later version published by the Free Software Foundation. If the Library does not specify a license version number, you may choose any version ever published by the Free Software Foundation.

14. If you wish to incorporate parts of the Library into other free programs whose distribution conditions are incompatible with these, write to the author to ask for permission. For software which is copyrighted by the Free Software Foundation, write to the Free Software Foundation; we sometimes make exceptions for this. Our decision will be guided by the two goals of preserving the free status of all derivatives of our free software and of promoting the sharing and reuse of software generally.

NO WARRANTY

15. BECAUSE THE LIBRARY IS LICENSED FREE OF CHARGE, THERE IS NO WARRANTY FOR THE LIBRARY, TO THE EXTENT PERMITTED BY APPLICABLE LAW. EXCEPT WHEN OTHERWISE STATED IN WRITING THE COPYRIGHT HOLDERS AND/OR OTHER PARTIES PROVIDE THE LIBRARY "AS IS" WITHOUT WARRANTY OF ANY KIND, EITHER EXPRESSED OR IMPLIED, INCLUDING, BUT NOT LIMITED TO, THE IMPLIED WARRANTIES OF MERCHANTABILITY AND FITNESS FOR A PARTICULAR PURPOSE. THE ENTIRE RISK AS TO THE QUALITY AND PERFORMANCE OF THE LIBRARY IS WITH YOU. SHOULD THE LIBRARY PROVE DEFECTIVE, YOU ASSUME THE COST OF ALL NECESSARY SERVICING, REPAIR OR CORRECTION.

16. IN NO EVENT UNLESS REQUIRED BY APPLICABLE LAW OR AGREED TO IN WRITING WILL ANY COPYRIGHT HOLDER, OR ANY OTHER PARTY WHO MAY MODIFY AND/OR REDISTRIBUTE THE LIBRARY AS PERMITTED ABOVE, BE LIABLE TO YOU FOR DAMAGES, INCLUDING ANY GENERAL, SPECIAL, INCIDENTAL OR CONSEQUENTIAL DAMAGES ARISING OUT OF THE USE OR INABILITY TO USE THE LIBRARY (INCLUDING BUT NOT LIMITED TO LOSS OF DATA OR DATA BEING RENDERED INACCURATE OR LOSSES SUSTAINED BY YOU OR THIRD PARTIES OR A FAILURE OF THE LIBRARY TO OPERATE WITH ANY OTHER SOFTWARE), EVEN IF SUCH HOLDER OR OTHER PARTY HAS BEEN ADVISED OF THE POSSIBILITY OF SUCH DAMAGES.

END OF TERMS AND CONDITIONS

GNU Lesser General Public License (Version 3)

Below is the GNU Lesser General Public License.

Version 3, 29 June 2007

Copyright © 2007 Free Software Foundation, Inc. <<http://fsf.org/>>

Everyone is permitted to copy and distribute verbatim copies of this license document, but changing it is not allowed.

This version of the GNU Lesser General Public License incorporates the terms and conditions of version 3 of the GNU General Public License, supplemented by the additional permissions listed below.

0. Additional Definitions.

As used herein, “this License” refers to version 3 of the GNU Lesser General Public License, and the “GNU GPL” refers to version 3 of the GNU General Public License.

“The Library” refers to a covered work governed by this License, other than an Application or a Combined Work as defined below.

An “Application” is any work that makes use of an interface provided by the Library, but which is not otherwise based on the Library. Defining a subclass of a class defined by the Library is deemed a mode of using an interface provided by the Library.

A “Combined Work” is a work produced by combining or linking an Application with the Library. The particular version of the Library with which the Combined Work was made is also called the “Linked Version”.

The “Minimal Corresponding Source” for a Combined Work means the Corresponding Source for the Combined Work, excluding any source code for portions of the Combined Work that, considered in isolation, are based on the Application, and not on the Linked Version.

The “Corresponding Application Code” for a Combined Work means the object code and/or source code for the Application, including any data and utility programs needed for reproducing the Combined Work from the Application, but excluding the System Libraries of the Combined Work.

1. Exception to Section 3 of the GNU GPL.

You may convey a covered work under sections 3 and 4 of this License without being bound by section 3 of the GNU GPL.

2. Conveying Modified Versions.

If you modify a copy of the Library, and, in your modifications, a facility refers to a function or data to be supplied by an Application that uses the facility (other than as an argument passed when the facility is invoked), then you may convey a copy of the modified version:

a) under this License, provided that you make a good faith effort to ensure that, in the event an Application does not supply the function or data, the facility still operates, and performs whatever part of its purpose remains meaningful, or

b) under the GNU GPL, with none of the additional permissions of this License applicable to that copy.

3. Object Code Incorporating Material from Library Header Files.

The object code form of an Application may incorporate material from a header file that is part of the Library. You may convey such object code under terms of your choice, provided that, if the incorporated material is not limited to numerical parameters, data structure layouts and accessors, or small macros, inline functions and templates (ten or fewer lines in length), you do both of the following:

a) Give prominent notice with each copy of the object code that the Library is used in it and that the Library and its use are covered by this License.

b) Accompany the object code with a copy of the GNU GPL and this license document.

4. Combined Works.

You may convey a Combined Work under terms of your choice that, taken together, effectively do not restrict modification of the portions of the Library contained in the Combined Work and reverse engineering for debugging such modifications, if you also do each of the following:

a) Give prominent notice with each copy of the Combined Work that the Library is used in it and that the Library and its use are covered by this License.

b) Accompany the Combined Work with a copy of the GNU GPL and this license document.

c) For a Combined Work that displays copyright notices during execution, include the copyright notice for the Library among these notices, as well as a reference directing the user to the copies of the GNU GPL and this license document.

d) Do one of the following:

0) Convey the Minimal Corresponding Source under the terms of this License, and the Corresponding Application Code in a form suitable for, and under terms that permit, the user to recombine or relink the Application with a modified version of the Linked Version to produce a modified Combined Work, in the manner specified by section 6 of the GNU GPL for conveying Corresponding Source.

1) Use a suitable shared library mechanism for linking with the Library. A suitable mechanism is one that (a) uses at run time a copy of the Library already present on the user's computer system, and (b) will operate properly with a modified version of the Library that is interface-compatible with the Linked Version.

e) Provide Installation Information, but only if you would otherwise be required to provide such information under section 6 of the GNU GPL, and only to the extent that such information is necessary to install and execute a modified version of the Combined Work produced by recombining or relinking the Application with a modified version of the Linked Version. (If you use option 4d0, the Installation Information must accompany the Minimal Corresponding Source and Corresponding Application Code. If you use option 4d1, you must provide the Installation Information in the manner specified by section 6 of the GNU GPL for conveying Corresponding Source.)

5. Combined Libraries.

You may place library facilities that are a work based on the Library side by side in a single library together with other library facilities that are not Applications and are not covered by this License, and convey such a combined library under terms of your choice, if you do both of the following:

a) Accompany the combined library with a copy of the same work based on the Library, uncombined with any other library facilities, conveyed under the terms of this License.

b) Give prominent notice with the combined library that part of it is a work based on the Library, and explaining where to find the accompanying uncombined form of the same work.

6. Revised Versions of the GNU Lesser General Public License.

The Free Software Foundation may publish revised and/or new versions of the GNU Lesser General Public License from time to time. Such new versions will be similar in spirit to the present version, but may differ in detail to address new problems or concerns.

Each version is given a distinguishing version number. If the Library as you received it specifies that a certain numbered version of the GNU Lesser General Public License “or any later version” applies to it, you have the option of following the terms and conditions either of that published version or of any later version published by the Free Software Foundation. If the Library as you received it does not specify a version number of the GNU Lesser General Public License, you may choose any version of the GNU Lesser General Public License ever published by the Free Software Foundation.

If the Library as you received it specifies that a proxy can decide whether future versions of the GNU Lesser General Public License shall apply, that proxy's public statement of acceptance of any version is permanent authorization for you to choose that version for the Library.

fontconfig License

Below is the fontconfig license.

Copyright © 2001 Keith Packard

Permission to use, copy, modify, distribute, and sell this software and its documentation for any purpose is hereby granted without fee, provided that the above copyright notice appear in all copies and that both that copyright notice and this permission notice appear in supporting documentation, and that the name of Keith Packard not be used in advertising or publicity pertaining to distribution of the software without specific, written prior permission. Keith Packard makes no representations

about the suitability of this software for any purpose. It is provided "as is" without express or implied warranty.

THE AUTHOR(S) DISCLAIMS ALL WARRANTIES WITH REGARD TO THIS SOFTWARE, INCLUDING ALL IMPLIED WARRANTIES OF MERCHANTABILITY AND FITNESS, IN NO EVENT SHALL THE AUTHOR(S) BE LIABLE FOR ANY SPECIAL, INDIRECT OR CONSEQUENTIAL DAMAGES OR ANY DAMAGES WHATSOEVER RESULTING FROM LOSS OF USE, DATA OR PROFITS, WHETHER IN AN ACTION OF CONTRACT, NEGLIGENCE OR OTHER TORTIOUS ACTION, ARISING OUT OF OR IN CONNECTION WITH THE USE OR PERFORMANCE OF THIS SOFTWARE.

Copyright © 2002-2003 by Juliusz Chroboczek

Permission is hereby granted, free of charge, to any person obtaining a copy of this software and associated documentation files (the "Software"), to deal in the Software without restriction, including without limitation the rights to use, copy, modify, merge, publish, distribute, sublicense, and/or sell copies of the Software, and to permit persons to whom the Software is furnished to do so, subject to the following conditions:

The above copyright notice and this permission notice shall be included in all copies or substantial portions of the Software.

THE SOFTWARE IS PROVIDED "AS IS", WITHOUT WARRANTY OF ANY KIND, EXPRESS OR IMPLIED, INCLUDING BUT NOT LIMITED TO THE WARRANTIES OF MERCHANTABILITY, FITNESS FOR A PARTICULAR PURPOSE AND NONINFRINGEMENT. IN NO EVENT SHALL THE AUTHORS OR COPYRIGHT HOLDERS BE LIABLE FOR ANY CLAIM, DAMAGES OR OTHER LIABILITY, WHETHER IN AN ACTION OF CONTRACT, TORT OR OTHERWISE, ARISING FROM, OUT OF OR IN CONNECTION WITH THE SOFTWARE OR THE USE OR OTHER DEALINGS IN THE SOFTWARE.

libxml2 License

Below is the libxml2 license.

Except where otherwise noted in the source code (e.g. the files hash.c, list.c and the trio files, which are covered by a similar licence but with different Copyright notices) all the files are:

Copyright (C) 1998-2003 Daniel Veillard. All Rights Reserved.

Permission is hereby granted, free of charge, to any person obtaining a copy of this software and associated documentation files (the "Software"), to deal in the Software without restriction, including without limitation the rights to use, copy, modify, merge, publish, distribute, sublicense, and/or sell copies of the Software, and to permit persons to whom the Software is furnished to do so, subject to the following conditions:

The above copyright notice and this permission notice shall be included in all copies or substantial portions of the Software.

THE SOFTWARE IS PROVIDED "AS IS", WITHOUT WARRANTY OF ANY KIND, EXPRESS OR IMPLIED, INCLUDING BUT NOT LIMITED TO THE WARRANTIES OF MERCHANTABILITY, FITNESS FOR A PARTICULAR PURPOSE AND NONINFRINGEMENT. IN NO EVENT SHALL THE DANIEL VEILLARD BE LIABLE FOR ANY CLAIM, DAMAGES OR OTHER LIABILITY, WHETHER IN AN ACTION OF CONTRACT, TORT OR OTHERWISE, ARISING FROM, OUT OF OR IN CONNECTION WITH THE SOFTWARE OR THE USE OR OTHER DEALINGS IN THE SOFTWARE.

Except as contained in this notice, the name of Daniel Veillard shall not be used in advertising or otherwise to promote the sale, use or other dealings in this Software without prior written authorization from him.

hash.c License

hash.c: chained hash tables

Reference: Your favorite introductory book on algorithms

Copyright (C) 2000 Bjorn Reese and Daniel Veillard.

Permission to use, copy, modify, and distribute this software for any purpose with or without fee is hereby granted, provided that the above copyright notice and this permission notice appear in all copies.

THIS SOFTWARE IS PROVIDED "AS IS" AND WITHOUT ANY EXPRESS OR IMPLIED WARRANTIES, INCLUDING, WITHOUT LIMITATION, THE IMPLIED WARRANTIES OF MERCHANTABILITY AND FITNESS FOR A PARTICULAR PURPOSE. THE AUTHORS AND CONTRIBUTORS ACCEPT NO RESPONSIBILITY IN ANY CONCEIVABLE MANNER.

Author: breese@users.sourceforge.net

list.c License

list.c: lists handling implementation

Copyright (C) 2000 Gary Pennington and Daniel Veillard.

Permission to use, copy, modify, and distribute this software for any purpose with or without fee is hereby granted, provided that the above copyright notice and this permission notice appear in all copies.

THIS SOFTWARE IS PROVIDED "AS IS" AND WITHOUT ANY EXPRESS OR IMPLIED WARRANTIES, INCLUDING, WITHOUT LIMITATION, THE IMPLIED WARRANTIES OF MERCHANTABILITY AND FITNESS FOR A PARTICULAR PURPOSE. THE AUTHORS AND CONTRIBUTORS ACCEPT NO RESPONSIBILITY IN ANY CONCEIVABLE MANNER.

Author: Gary.Pennington@uk.sun.com

trio.c License

Copyright (C) 1998 Bjorn Reese and Daniel Stenberg.

Permission to use, copy, modify, and distribute this software for any purpose with or without fee is hereby granted, provided that the above copyright notice and this permission notice appear in all copies.

THIS SOFTWARE IS PROVIDED "AS IS" AND WITHOUT ANY EXPRESS OR IMPLIED WARRANTIES, INCLUDING, WITHOUT LIMITATION, THE IMPLIED WARRANTIES OF MERCHANTABILITY AND FITNESS FOR A PARTICULAR PURPOSE. THE AUTHORS AND CONTRIBUTORS ACCEPT NO RESPONSIBILITY IN ANY CONCEIVABLE MANNER.

locapi License

Below is the locapi license.

Copyright (c) 2009, QUALCOMM USA, INC.

All rights reserved.

Redistribution and use in source and binary forms, with or without modification, are permitted provided that the following conditions are met:

- Redistributions of source code must retain the above copyright notice, this list of conditions and the following disclaimer.
- Redistributions in binary form must reproduce the above copyright notice, this list of conditions and the following disclaimer in the documentation and/or other materials provided with the distribution.
- Neither the name of the QUALCOMM USA, INC. nor the names of its contributors may be used to endorse or promote products derived from this software without specific prior written permission.

THIS SOFTWARE IS PROVIDED BY THE COPYRIGHT HOLDERS AND CONTRIBUTORS "AS IS" AND ANY EXPRESS OR IMPLIED WARRANTIES, INCLUDING, BUT NOT LIMITED TO, THE IMPLIED WARRANTIES OF MERCHANTABILITY AND FITNESS FOR A PARTICULAR PURPOSE ARE DISCLAIMED. IN NO EVENT SHALL THE COPYRIGHT HOLDER OR CONTRIBUTORS BE LIABLE FOR ANY DIRECT, INDIRECT, INCIDENTAL, SPECIAL, EXEMPLARY, OR CONSEQUENTIAL DAMAGES (INCLUDING, BUT NOT LIMITED TO, PROCUREMENT OF SUBSTITUTE GOODS OR SERVICES; LOSS OF USE, DATA, OR PROFITS; OR BUSINESS INTERRUPTION) HOWEVER CAUSED AND ON ANY THEORY OF LIABILITY, WHETHER IN CONTRACT, STRICT LIABILITY, OR TORT (INCLUDING NEGLIGENCE OR OTHERWISE) ARISING IN ANY WAY OUT OF THE USE OF THIS SOFTWARE, EVEN IF ADVISED OF THE POSSIBILITY OF SUCH DAMAGE.

pimd License

Below is the pimd license.

Copyright (c) 1998-2001

University of Southern California/Information Sciences Institute.

All rights reserved.

Redistribution and use in source and binary forms, with or without modification, are permitted provided that the following conditions are met:

1. Redistributions of source code must retain the above copyright notice, this list of conditions and the following disclaimer.
2. Redistributions in binary form must reproduce the above copyright notice, this list of conditions and the following disclaimer in the documentation and/or other materials provided with the distribution.
3. Neither the name of the project nor the names of its contributors may be used to endorse or promote products derived from this software without specific prior written permission.

THIS SOFTWARE IS PROVIDED BY THE PROJECT AND CONTRIBUTORS "AS IS" AND ANY EXPRESS OR IMPLIED WARRANTIES, INCLUDING, BUT NOT LIMITED TO, THE IMPLIED WARRANTIES OF MERCHANTABILITY AND FITNESS FOR A PARTICULAR PURPOSE ARE DISCLAIMED. IN NO EVENT SHALL THE PROJECT OR CONTRIBUTORS BE LIABLE FOR ANY DIRECT, INDIRECT, INCIDENTAL, SPECIAL, EXEMPLARY, OR CONSEQUENTIAL DAMAGES (INCLUDING, BUT NOT LIMITED TO, PROCUREMENT OF SUBSTITUTE GOODS OR SERVICES; LOSS OF USE, DATA, OR PROFITS; OR BUSINESS INTERRUPTION) HOWEVER CAUSED AND ON ANY THEORY OF LIABILITY, WHETHER IN CONTRACT, STRICT LIABILITY, OR TORT (INCLUDING NEGLIGENCE OR OTHERWISE) ARISING IN ANY WAY OUT OF THE USE OF THIS SOFTWARE, EVEN IF ADVISED OF THE POSSIBILITY OF SUCH DAMAGE.

Part of this program has been derived from mrouted.

The mrouted program is covered by the license in the accompanying file named "LICENSE.mrouted".

The mrouted program is COPYRIGHT 1989 by The Board of Trustees of Leland Stanford Junior University.

shadow License

Below is the shadow license.

Copyright (c) 1989 - 1994, Julianne Frances Haugh

Copyright (c) 1996 - 2000, Marek Michałkiewicz

Copyright (c) 2001 - 2006, Tomasz Kłoczko

Copyright (c) 2007 - 2009, Nicolas François

All rights reserved.

Redistribution and use in source and binary forms, with or without modification, are permitted provided that the following conditions are met:

1. Redistributions of source code must retain the above copyright notice, this list of conditions and the following disclaimer.
2. Redistributions in binary form must reproduce the above copyright notice, this list of conditions and the following disclaimer in the documentation and/or other materials provided with the distribution.
3. The name of the copyright holders or contributors may not be used to endorse or promote products derived from this software without specific prior written permission.

THIS SOFTWARE IS PROVIDED BY THE COPYRIGHT HOLDERS AND CONTRIBUTORS "AS IS" AND ANY EXPRESS OR IMPLIED WARRANTIES, INCLUDING, BUT NOT LIMITED TO, THE IMPLIED WARRANTIES OF MERCHANTABILITY AND FITNESS FOR A PARTICULAR PURPOSE ARE DISCLAIMED. IN NO EVENT SHALL THE COPYRIGHT HOLDERS OR CONTRIBUTORS BE LIABLE FOR ANY DIRECT, INDIRECT, INCIDENTAL, SPECIAL, EXEMPLARY, OR CONSEQUENTIAL DAMAGES (INCLUDING, BUT NOT LIMITED TO, PROCUREMENT OF SUBSTITUTE GOODS OR SERVICES; LOSS OF USE, DATA, OR PROFITS; OR BUSINESS INTERRUPTION) HOWEVER CAUSED AND ON ANY THEORY OF LIABILITY, WHETHER IN CONTRACT, STRICT LIABILITY, OR TORT (INCLUDING NEGLIGENCE OR OTHERWISE) ARISING IN ANY WAY OUT OF THE USE OF THIS SOFTWARE, EVEN IF ADVISED OF THE POSSIBILITY OF SUCH DAMAGE.

ISC License

Below is the ISC license.

Copyright 2004-2010 by Internet Systems Consortium, Inc. ("ISC")

Copyright 1995-2003 by Internet Software Consortium

Permission to use, copy, modify, and/or distribute this software for any purpose with or without fee is hereby granted, provided that the above copyright notice and this permission notice appear in all copies.

THE SOFTWARE IS PROVIDED "AS IS" AND ISC DISCLAIMS ALL WARRANTIES WITH REGARD TO THIS SOFTWARE INCLUDING ALL IMPLIED WARRANTIES OF MERCHANTABILITY AND FITNESS. IN NO EVENT SHALL ISC BE LIABLE FOR ANY SPECIAL, DIRECT, INDIRECT, OR CONSEQUENTIAL DAMAGES OR ANY DAMAGES WHATSOEVER RESULTING FROM LOSS OF USE, DATA OR PROFITS, WHETHER IN AN ACTION OF CONTRACT, NEGLIGENCE OR OTHER TORTIOUS ACTION, ARISING OUT OF OR IN CONNECTION WITH THE USE OR PERFORMANCE OF THIS SOFTWARE.

OpenSSL License

Below is the OpenSSL license.

Copyright (c) 1998-2007 The OpenSSL Project. All rights reserved.

Redistribution and use in source and binary forms, with or without modification, are permitted provided that the following conditions are met:

1. Redistributions of source code must retain the above copyright notice, this list of conditions and the following disclaimer.
2. Redistributions in binary form must reproduce the above copyright notice, this list of conditions and the following disclaimer in the documentation and/or other materials provided with the distribution.
3. All advertising materials mentioning features or use of this software must display the following acknowledgment:

“This product includes software developed by the OpenSSL Project for use in the OpenSSL Toolkit. (<http://www.openssl.org/>)”

4. The names “OpenSSL Toolkit” and “OpenSSL Project” must not be used to endorse or promote products derived from this software without prior written permission. For written permission, please contact openssl-core@openssl.org.
5. Products derived from this software may not be called “OpenSSL” nor may “OpenSSL” appear in their names without prior written permission of the OpenSSL Project.
6. Redistributions of any form whatsoever must retain the following acknowledgment:

“This product includes software developed by the OpenSSL Project for use in the OpenSSL Toolkit (<http://www.openssl.org/>)”

THIS SOFTWARE IS PROVIDED BY THE OpenSSL PROJECT “AS IS” AND ANY EXPRESSED OR IMPLIED WARRANTIES, INCLUDING, BUT NOT LIMITED TO, THE IMPLIED WARRANTIES OF MERCHANTABILITY AND FITNESS FOR A PARTICULAR PURPOSE ARE DISCLAIMED. IN NO EVENT SHALL THE OpenSSL PROJECT OR ITS CONTRIBUTORS BE LIABLE FOR ANY DIRECT, INDIRECT, INCIDENTAL, SPECIAL, EXEMPLARY, OR CONSEQUENTIAL DAMAGES (INCLUDING, BUT NOT LIMITED TO, PROCUREMENT OF SUBSTITUTE GOODS OR SERVICES; LOSS OF USE, DATA, OR PROFITS; OR BUSINESS INTERRUPTION) HOWEVER CAUSED AND ON ANY THEORY OF LIABILITY, WHETHER IN CONTRACT, STRICT LIABILITY, OR TORT (INCLUDING NEGLIGENCE OR OTHERWISE) ARISING IN ANY WAY OUT OF THE USE OF THIS SOFTWARE, EVEN IF ADVISED OF THE POSSIBILITY OF SUCH DAMAGE.

This product includes cryptographic software written by Eric Young (eay@cryptsoft.com). This product includes software written by Tim Hudson (tjh@cryptsoft.com).

Original SSLeay License

Below is the SSLeay license.

Copyright (C) 1995-1998 Eric Young (eay@cryptsoft.com)

All rights reserved.

This package is an SSL implementation written by Eric Young (eay@cryptsoft.com).

The implementation was written so as to conform with Netscapes SSL.

This library is free for commercial and non-commercial use as long as the following conditions are adhered to. The following conditions apply to all code found in this distribution, be it the RC4, RSA, lhash, DES, etc., code; not just the SSL code. The SSL documentation included with this distribution is covered by the same copyright terms except that the holder is Tim Hudson (tjh@cryptsoft.com).

Copyright remains Eric Young's, and as such any Copyright notices in the code are not to be removed. If this package is used in a product, Eric Young should be given attribution as the author of the parts of the library used. This can be in the form of a textual message at program startup or in documentation (online or textual) provided with the package.

Redistribution and use in source and binary forms, with or without modification, are permitted provided that the following conditions are met:

1. Redistributions of source code must retain the copyright notice, this list of conditions and the following disclaimer.
2. Redistributions in binary form must reproduce the above copyright notice, this list of conditions and the following disclaimer in the documentation and/or other materials provided with the distribution.
3. All advertising materials mentioning features or use of this software must display the following acknowledgement:

“This product includes cryptographic software written by Eric Young (eay@cryptsoft.com)”

The word ‘cryptographic’ can be left out if the routines from the library being used are not cryptographic related : -).

4. If you include any Windows specific code (or a derivative thereof) from the apps directory (application code) you must include an acknowledgement:

“This product includes software written by Tim Hudson (tjh@cryptsoft.com)”

THIS SOFTWARE IS PROVIDED BY ERIC YOUNG “AS IS” AND ANY EXPRESS OR IMPLIED WARRANTIES, INCLUDING, BUT NOT LIMITED TO, THE IMPLIED WARRANTIES OF MERCHANTABILITY AND FITNESS FOR A PARTICULAR PURPOSE ARE DISCLAIMED. IN NO EVENT SHALL THE AUTHOR OR CONTRIBUTORS BE LIABLE FOR ANY DIRECT, INDIRECT, INCIDENTAL, SPECIAL, EXEMPLARY, OR CONSEQUENTIAL DAMAGES (INCLUDING, BUT NOT LIMITED TO, PROCUREMENT OF SUBSTITUTE GOODS OR SERVICES; LOSS OF USE, DATA, OR PROFITS; OR BUSINESS INTERRUPTION) HOWEVER CAUSED AND ON ANY THEORY OF LIABILITY, WHETHER IN CONTRACT, STRICT LIABILITY, OR TORT (INCLUDING NEGLIGENCE OR OTHERWISE) ARISING IN ANY WAY OUT OF THE USE OF THIS SOFTWARE, EVEN IF ADVISED OF THE POSSIBILITY OF SUCH DAMAGE.

The licence and distribution terms for any publicly available version or derivative of this code cannot be changed. I.e. this code cannot simply be copied and put under another distribution licence [including the GNU Public Licence.]

Trademarks

SPRINT and the logo are trademarks of Sprint.

NETGEAR, the NETGEAR logo and AirCard are trademarks and/or registered trademarks of NETGEAR, Inc. and/or its subsidiaries in the United States and/or other countries.

Windows® is a registered trademark of Microsoft Corporation.

Mac and Mac OS are trademarks of Apple Inc., registered in the U.S. and other countries.

Linux® is the registered trademark of Linus Torvalds in the U.S. and other countries.

QUALCOMM® is a registered trademark of QUALCOMM Incorporated.

Other trademarks are the property of the respective owners.

Information is subject to change without notice.

Copyright

©2013 Sprint. All rights reserved. No reproduction in whole or in part without prior written approval.

Limitation of Liability

The information in this manual is subject to change without notice and does not represent a commitment on the part of NETGEAR. NETGEAR AND ITS AFFILIATES SPECIFICALLY DISCLAIM LIABILITY FOR ANY AND ALL DIRECT, INDIRECT, SPECIAL, GENERAL, INCIDENTAL, CONSEQUENTIAL, PUNITIVE OR EXEMPLARY DAMAGES INCLUDING, BUT NOT LIMITED TO, LOSS OF PROFITS OR REVENUE OR ANTICIPATED PROFITS OR REVENUE ARISING OUT OF THE USE OR INABILITY TO USE ANY NETGEAR PRODUCT, EVEN IF NETGEAR AND/OR ITS AFFILIATES HAS BEEN ADVISED OF THE POSSIBILITY OF SUCH DAMAGES OR THEY ARE FORESEEABLE OR FOR CLAIMS BY ANY THIRD PARTY.

Notwithstanding the foregoing, in no event shall NETGEAR and/or its affiliates aggregate liability arising under or in connection with the NETGEAR product, regardless of the number of events, occurrences, or claims giving rise to liability, be in excess of the price paid by the purchaser for the NETGEAR product.

Additional Information and Updates

For up-to-date product descriptions, documentation, application notes, firmware upgrades, troubleshooting tips, and press releases, visit support.netgear.com.

Index

3

3G
Cannot connect 54
Coverage type 31
Ec/Io of network connection 31
network service, improving 52
Overview 5
Roaming support 49
RSSI of network connection 31
Service type (PS) 31

4

4G
Cannot connect 54
4G LTE
Cannot connect 54

A

About page 33
Accessories, purchasing 4
Account
 Summary 19
Account information, accessing 4
activating the device 3
Activation
 Date, Sprint network 34
 Date, viewing 39
Active APN 29
Administrator
 Logging in as 17
 Password, changing 37
Administrator password
 Forgotten; what do I do? 49
Advanced settings 28
Alert
 Description 20
 Title 20
Alerts 15
 Common types 9
 In NETGEAR 341U Manager 20
Allowed network mode, setting the 41
Altitude 23
Antennas, external 9

APN
 Active 29
 Authentication code 29
 Configuring 42
 Parameters 29
 Password 29
 Username 29
APN tab, Settings page 28
Apple Safari 2
Application notes 97
Authentication code
 APN 29

B

Backup settings 25
Band
 LTE network connection 31
Bands supported
 Receive 56
 Transmit 56
Basics 5
Billing and ;\ 49
Billing cycle
 Data usage 18-19
 Reset displayed data usage 19
Bottom view of device 1
Box contents 2
Browsers supported 2
Buttons
 On device (drawing) 1

C

Cannot check for updates 55
Cannot connect to the 3G/4G network 54
Cannot display the home page 53
Care of your device 2
Carrier name 21
Changing the NETGEAR 341U Manager IP
 address 37
Changing the NETGEAR 341U Manager
 URL 37
Channel
 Number, LTE 31
 UL, LTE 31
Check for Update 25

- Chrome browser 2
- Clear Programming 26
- Common alert types 9
- Configure
 - Device 23
 - Network settings 23
 - OLED display 23
- Configure Networks 39
- Connect to Internet
 - 3G network service, improving 52
 - Cannot connect 54
 - Launching a connection 10
- Connect to mobile network, button 21
- Connected
 - How to tell you're connected to 3G/LTE 49
- Connection
 - 3G network service, improving 52
 - Information 6
 - Launching 10
 - Status 30
- ConnectionStatus 31
- Connectors on device (drawing) 1
- Contents, package 2
- Continuous GPS fix 23
- Copyright information 96
- Corporate network, accessing through VPN 51
- Could not connect to remote server 53
- Coverage
 - Type, 3G 31
- Coverage maps 4
- Current power state 34
- Current, electrical (specifications) 56
- Customer Service, contacting 4

D

- Dark OLED display 53
- Data
 - Plan type 20
 - Transmit indicators 21
- Data connection
 - Launching 10
- Data usage
 - OLED display format 36
- Data Usage 15
- Data Usage details 18
- Data usage, viewing 39

- Default settings
 - Software, resetting 45
- Default settings, software reset 45
- Device
 - Drawing (connectors and buttons) 1
 - Information, viewing 33
 - Model name 34
 - Power state 34
 - Resetting 45
 - Setting up 3
 - Settings, resetting 45
 - Settings, restoring 43
 - Settings, saving 43
 - Telephone number 34
 - Temperature 34
 - User Guide 35
- Device driver
 - Installing, TRU-Install (automatic driver installation), enabling or disabling 11
- Device driver, installing
 - Mac 12
 - Windows 11
- Device tab, Settings page 23
- Digital Rate Control
 - Channel number 31
 - Cover 31
 - Value 31
- Dimensions of device 58
- Disable
 - GPS 47
- Disconnect from mobile network, button 21
- Display Settings 36
- Domestic roaming guard 28
- Downloading
 - Firmware 45
 - Software updates 44
- Drawing of hardware 1
- DRC
 - Channel number 31
 - Cover 31
 - Value 31
- Driver, installing
 - Mac 12
 - TRU-Install (automatic driver installation), enabling or disabling 11
 - Windows 11

E

Ec/lo
 3G 31
Electrical specifications 56
Enable / disable GPS 23
Enable GPS 47
Environmental specifications 57
Export (device settings) 43
Export Settings 43
Exporting
 Device settings 43
External antennas 9

F

Facebook link 35
Factory Reset 26
FAX 57
FCC (regulatory) notices 60
FCC ID 60
Feedback
 Link 33
Feedback page
 Settings tab 35
Firefox browser 2
Firewall software 54
Firmware
 Bootloader version 34
 Upgrading 45
 Version 34
 Version, NETGEAR 341U Manager 34
first time usage 3
Fix
 GPS, type of fix 23
fontconfig License 88
Forgot administrator password 49
Frequencies, transmit and receive 56
Front view of device 1

G

General Public License, GNU 62
General Tips 53
GNU General Public License 62
Google Chrome 2
GPL (v2) License 62
GPL (v3) License 68
GPS
 Altitude 23
 Availability 50

 Disable 50
 Enable 50
 Enable ./ disable 23
 Enable/disable 47
 FAQ 49
 Heading 23
 Latitude 23
 Limitations 50
 Longitude 23
 Metric units 23
 Mode 23
 Mode, setting 47
 Not working or doesn't seem to be
 available 55
 Overview 50
 Satellites, number used 23
 Speed 23
 Standard units 23
 Status 22
 Streaming data 50
 Timestamp 22
 Units, select metric or standard 48
GPS page 21
GPS Settings 47

H

hands-free activation 3
Hands-free activation
 Re-run 28
Hardware (drawing) 1
Hazards 59
Heading 23
Height of device 58
Help 3
Help, getting
 Customer Service, contacting 4
 FAQ (Frequently Asked Questions) 49
 Sprint website 4
 Tips 52
 Troubleshooting 53
Home page 16
 Cannot display 53
Home Page 16

I

ICCID 31, 34
Icons
 network service type, active 5

- OLED display 14
- Signal strength 6
- Import (router settings) 43
- Import Settings 43
- Important notice 59
- Importing device settings 43
- IMSI, LTE 31
- Information about your device 33
- Installation requirements 2
- Installing the device 3
- International roaming guard 28
- Internet connection
 - data usage, viewing 39
 - Information 6
 - Launching 10
- Internet Explorer browser 2
- Internet Explorer cannot display the webpage 53
- IOTA 57
- IP address
 - 3G 31
 - LTE 31
 - NETGEAR 341U Manager 24
 - NETGEAR 341U Manager, changing 37
 - NETGEAR 341U Manager, configure 23
 - WWAN radio 34
- ISC License 93

K

- Knowledge base 53

L

- Latitude 23
- LBS 21
- Legal 62
- Length of device 58
- LGPL (v2.1) License 78
- LGPL (v3) License 86
- Liability, limitation of 96
- libxml2 License 89
- Licenses 62
- Limitation of liability 96
- Limitations, GPS 50
- locapi License 91
- Location Based Services 21
- Logging events 26

- Login password
 - Changing 37
 - Forgotten; what do I do? 49
- Longitude 23
- LTE
 - IP address of 3G network connection 31
 - IP address of LTE network connection 31
 - Overview 5
 - Radio channel number for LTE network connection 31
 - Roaming support 49
 - RS-SINR of LTE network connection 31
 - RSRP of LTE network connection 30
 - RSRQ of LTE network connection 31
 - TX power of LTE network connection 31
 - Upload channel for LTE network connection 31

M

- Mac operating system
 - Driver, installing 12
- Maintenance of your device 2
- Manage your Sprint account by telephone 33
- Manager
 - Settings 36
- Manual configuration 28
- MDN 31
- Mechanical specifications 58
- MEID 34
- Metric units for GPS 23, 48
- Micro-SIM 7
- micro-SIM, slot location 1
- MIMO antennas 9
- Mobile broadband
 - Connection details 30
 - overview 5
 - settings 5
 - Signal strength 6
- Mobile Directory Number of device 31
- Mobile Station Identifier 31
- Model
 - Name, device 34
- Mozilla Firefox 2

MSID 31, 34
My Sprint link 20

N

NETGEAR 341U Manager
Data Usage details 18
GPS page 21
IP address 24
IP address, changing 37
IP address, configure 23
Password, changing 37
Settings page 23
URL 24
URL, changing 37
URL, configure 23
Version 34
Version number 34
NETGEAR 341U Manager Home page
Description 16
Displaying 17
Logging in as an administrator 17
NETGEAR 341U Modem
Model name 34
NETGEAR 341U USB
Settings, resetting 45
NETGEAR knowledge base 53
Network
3G, overview 5
Activation date, viewing 39
Cannot connect 54
Carrier name 21
Connection details 30
Connection status 30-31
Indicator 6
LTE, overview 5
Mode allowed, setting the 41
Protocols supported 57
Service, 3G, improving 52
Status indicator 6
Type to connect 27
Type, current connection 21
Network Connection 10
Network Preferences tab, Settings page 27
Network Settings 40
Network, corporate, accessing through
VPN 51
Notice, important 59
Notices, regulatory 60

O

OLED display 7, 14
Alerts 15
Data Usage 15
Dimensions 58
Icons on OLED display 14
Not lit 53
Set data usage display format 36
Show billing cycle or session usage 24
Turn on/off 24, 36
OLED Display 14
One-time GPS fix 23
Oops! This link appears to be broken 53
OpenSSL License 93
Opera browser 2
Operating temperature 58
Operator name 21
Original SSLeay License 94
OTAPA 57
OTASP 57

P

Package contents 2
Password
Administrator, changing 37
Administrator, forgotten - what do I
do? 49
APN 29
Patents 62
pimd License 91
Place for your device, tips 52
Preferred Roaming List 28
PRL
Version 32
Version number 34
PRL, update 28
Problems 57
Protocols, network, supported 57
PS service type, 3G 31

Q

Questions, frequently asked (FAQ) 49

R

Radio frequency (RF) specifications 56
Receive data indicator 21
Receive frequencies 56

- Refurbished date 34
- Regulatory notices 60
- Require SIM PIN to use device 29
- Requirements
 - Installation 2
- Reset 43
- Resetting
 - NETGEAR 341U USB settings 45
 - Software to default settings 45
 - Your device 45
- Resetting the software to default settings 45
- Restarting the device 6
- Restore settings 25, 43
- RF (Radio Frequency) specifications 56
- RF Exposure notice 60
- Roaming
 - 3G support 49
 - Indicator, Zing Manager 31
 - LTE support 49
 - Message 21
 - Mode 27
 - Mode, setting 40
 - Status 21
- Roaming Guard 28
- Roaming Guard warnings,
 - enable/disable 41
- Routing hardware
 - Resetting to default settings 45
- Routing hardware settings reset
 - Performing 45
- RS-SINR
 - LTE 31
- RSRP 30
- RSRQ 31
- RSSI 31
 - Improving 52
 - Insufficient 53
- Rx (receive) frequencies 56

S

- Safari browser 2
- Safari can't open the page 54
- Safety and hazards 59
- Safety Information 59
- Satellites, number used for GPS fix 23
- Saving device settings 43
- Security
 - SIM PIN required to use device 29
- Send data indicator 21

- Service plan, add additional options 4
- Serving Cell ID 31
- Serving SID (home network area identifier) 32
- Session
 - Data usage 18
- Session data usage 19
- Session duration 19
- Setting up the device 3
- Settings 36
 - Backup 25
 - Exporting 43
 - Importing 43
 - Restore 25
- Settings page 23
 - APN tab 28
 - Device tab 23
 - Network Preferences tab 27
 - SIM Security tab 29
 - Software and Reset tab 24
 - Status Details tab 30
 - System Logs tab 26
- Settings Reset 26
- shadow License 92
- Short text messaging (SMS) 57
- Signal Information 6
- Signal strength 21
 - Improving 52
 - Insufficient 53
 - Mobile broadband 6
- SIM
 - ICCID 34
 - Security, activate or deactivate 29
- SIM Security tab, Settings page 29
- Size of device 58
- SMS 57
- Software 43
 - Resetting to default settings 45
 - Specifications 57
 - Updates, downloading 44
- Software and Reset tab, Settings page 24
- Specifications
 - Electrical 56
 - Environmental 57
 - Mechanical 58
 - Radio frequency (RF) 56
 - Software 57
- Speed, GPS 23
- Sprint Customer Service, contacting 4

- Sprint website 4
- ssh support 51
- SSLLeay License, Original 94
- Standard units
 - Use for GPS 23
- Standard units for GPS 48
- Standby current 56
- Start 1
- Status
 - Connection details in NETGEAR 341U Manager 20
- Status Details tab, Settings page 30
- Storage
 - Temperature 58
- Storage guidelines 2
- Streaming GPS data 50
- Support
 - Website link 33
- Support page 32
- Support, contacting 4
- System Logs tab, Settings page 26
- System requirements 2

T

- Technical Specifications 56
- Technical support, contacting 4
- Telephone number, device 20, 31, 34
- telnet support 51
- Temperature 34
 - Operating 58
 - Storage 58
- Terminal sessions 51
- Text messaging (SMS) 57
- The connection has timed out (message) 54
- Timeout
 - Connection timeout (cannot display the home page) 53
- Tips 52
- Trademarks 96
- Transferred amount total
 - 3G 34
 - LTE 34
- Transmit
 - Data indicators 21
- Transmit frequencies 56
- Transmitter power
 - LTE 31
- Troubleshooting
 - Cannot connect to the 3G/4G

- network 54
 - Cannot display the home page 53
 - General tips 53
- TRU-Install 11
- TTY support 57
- Twitter link 35
- TX
 - Power, LTE 31
- Tx (transmit) frequencies 56

U

- Update network settings 28
- Update PRL 28
- Updates
 - Cannot check for 55
- Upload channel for LTE network connection 31
- URL
 - NETGEAR 341U Manager 24
- Usage guidelines for your device 2
- USB
 - Connecting device to your computer 10
 - Connecting device to your computer through USB 10
- USB Modem
 - Firmware 44
 - Software 44
- User guide
 - Location 33
 - On device 35
- Username, APN 29

V

- VPN
 - Accessing 51
 - Passthrough types supported 57

W

- Warning (EMI) 60
- Web browsers supported 2
- Website
 - NETGEAR 97
 - Sprint 4
- Weight of device 58
- Width of device 58
- WiMAX (4G)
 - Frequencies 56
- Windows driver, installing 11

WWAN radio IP address 34

Free Manuals Download Website

<http://myh66.com>

<http://usermanuals.us>

<http://www.somanuals.com>

<http://www.4manuals.cc>

<http://www.manual-lib.com>

<http://www.404manual.com>

<http://www.luxmanual.com>

<http://aubethermostatmanual.com>

Golf course search by state

<http://golfingnear.com>

Email search by domain

<http://emailbydomain.com>

Auto manuals search

<http://auto.somanuals.com>

TV manuals search

<http://tv.somanuals.com>