

NETGEAR®

Connect with Innovation™

Powerline 500 Nano PasThru (2-pack) XAVB5602 Installation Guide

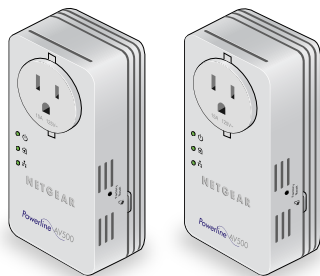

© 2012 NETGEAR, Inc. All rights reserved.

No part of this publication may be reproduced, transmitted, transcribed, stored in a retrieval system, or translated into any language in any form or by any means without the written permission of NETGEAR, Inc.

DO NOT stack equipment, or place equipment in tight spaces or in drawers. Be sure your equipment is surrounded by at least 2 in. of air space.

For indoor use only in EU countries and Switzerland.

Technical Support

Thank you for choosing NETGEAR. To register your product, get the latest product updates, or get support online, visit us at <http://support.netgear.com>.

Phone (US & Canada only): 1-888-NETGEAR

Phone (Other Countries):

See http://support.netgear.com/app/answers/detail/a_id/984.

Trademarks

NETGEAR, the NETGEAR logo, and Connect with Innovation are trademarks and/or registered trademarks of NETGEAR, Inc. and/or its subsidiaries in the United States and/or other countries. Information is subject to change without notice. Other brand and product names are registered trademarks or trademarks of their respective holders. © 2012 NETGEAR, Inc. All rights reserved.

Statement of Conditions

In the interest of improving internal design, operational function, and/or reliability, NETGEAR reserves the right to make changes to the products described in this document without notice. NETGEAR does not assume any liability that may occur due to the use or application of the product(s) or circuit layout(s) described herein.

Package Contents

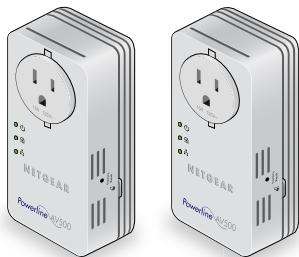

Ethernet cables (2)

Powerline adapters (2)

Products sold in some locations include a *Resource CD*.

Your Powerline adapter may look like one of these:



France



Germany/Europe



Switzerland

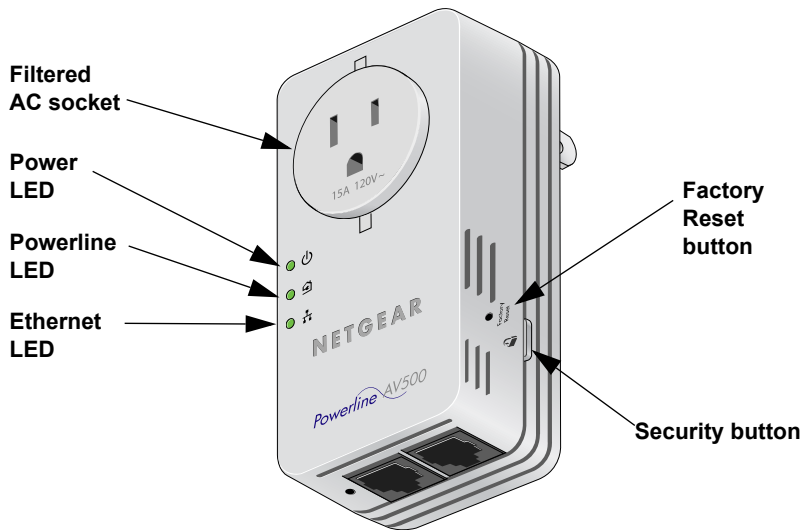

Hardware Features





Compatible Powerline and HomePlug AV certified devices include the NETGEAR XAV101, XAV1501, XAV1004, XAV2001, XAV2501, XAV2602, XAVN2001, XAV5001, XAV5004, and XAV5501. For a complete list of HomePlug AV certified devices, go to www.homeplug.org/certified_products.

LEDs

The LEDs indicate the status of your Powerline adapters.

- When you plug in the adapter, the Power LED  lights up and turns green.
- The adapter is not active when no Ethernet link has occurred for more than 10 minutes. The adapter enters power saving mode, and the Power LED turns amber.
- The Ethernet LED  lights up when you connect a powered-on Ethernet device to at least one Ethernet port.
- The Powerline LED turns on when the adapter detects at least one other compatible Powerline device.

The Pick A Plug diagnostic feature lets you pick the electrical outlet with the strongest throughput, indicated by the color displayed by the Powerline LED:

-  Green: Link rate > 80 Mbps (Best)
-  Amber: Link rate > 50 and < 80 Mbps (Better)
-  Red: Link rate < 50 Mbps (Good)

Install Your Powerline Adapters

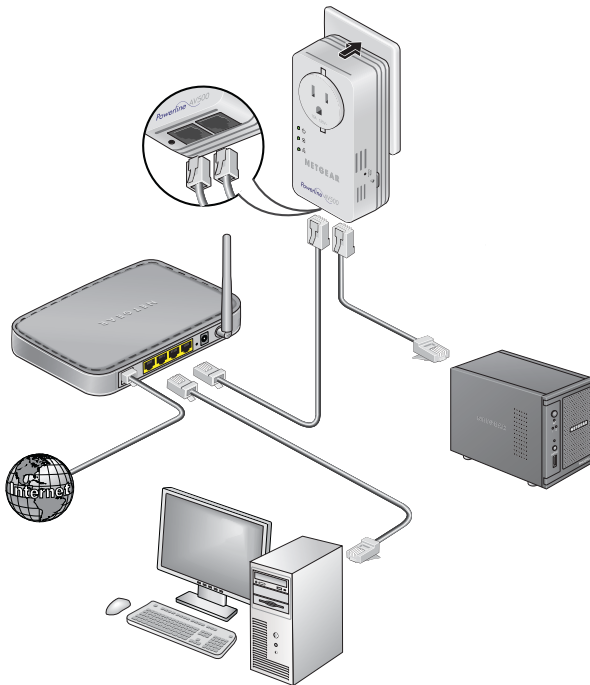

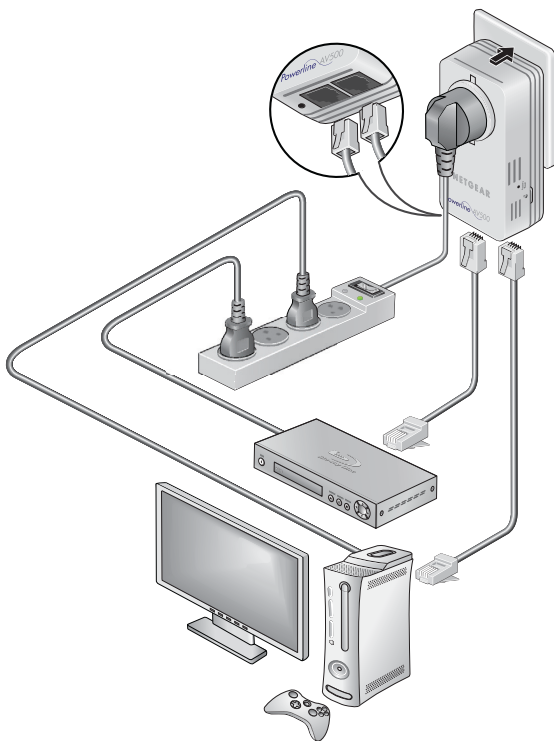

The filtered AC socket removes some electrical noise. Plugging a nearby device into the filtered AC socket improves performance.

You can plug a power strip into the filtered outlet, but do not plug your Powerline adapter into a power strip.

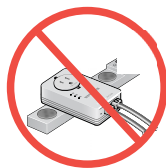

Secure Your Powerline Network

A Powerline network forms when at least two compatible Powerline devices communicate. After the Powerline network is up and running, you can use the Security buttons on the adapters to add encryption to your Powerline network.

CAUTION: *Do not press the **Security** button until each adapter has powered up and its Power LED is solid green. Pressing this button too soon can temporarily disable Powerline communication. If this occurs, use the **Factory Reset** button to return the Powerline adapter to its factory settings.*

To secure your Powerline network:

1. Make sure the Power LED is solid green. If it is amber, connect a device to one of the Ethernet ports so the adapter exits power saving mode.
2. On the first Powerline adapter, press its **Security** button for 2 seconds. The Power LED blinks green while you are setting up security.
3. Within 2 minutes, go to the next Powerline adapter and press its **Security** button for 2 seconds.

After security is set, the Power LED turns solid green. The adapters can communicate over the network. The Powerline LEDs are blinking or solid.

Technical Support

Thank you for selecting NETGEAR products.

After installing your device, locate the serial number on the label of your product and use it to register your product at <http://www.netgear.com/register>. Registration is required before you can use the telephone support service. Registration through the NETGEAR website is strongly recommended.

Go to <http://support.netgear.com> for product updates and web support.

For additional information about setting up, configuring, and using your Powerline 500 Nano Adapter, see the *User Manual*.

For complete DoC, visit the NETGEAR EU Declarations of Conformity website at

http://support.netgear.com/app/answers/detail/a_id/11621/.

For GNU General Public License (GPL) related information, visit

http://support.netgear.com/app/answers/detail/a_id/2649.

Safety Information

- For national approvals (approval schemes other than CB), relevant national standards for plug, socket-outlet, and direct plug-in units (for example, US) shall also be consulted while testing and approving such products according to national standards.
- AC input rating (NA): 100–125V, 0.2A (Max); 50–60Hz excluding socket outlet rating.
- AC input rating (AU, UK, FR, EU): 200–250V, 0.2A (Max), 50–60Hz excluding socket outlet rating.
- XAV5602 ratings (maximum load): EU: 16A 250V~, UK: 13A 250V~, FR: 16A, 250V~, NA: 15A 125V~, AU: 10A, 250V~.
- Operating temperature: 0° C~40° C.
- Check the electrical current for any device plugged into the filtered AC socket. Do not exceed home and product outlet ratings and electrical requirements.
- The socket-outlet shall be installed near the equipment and be easily accessible.
- Only power cords are allowed to be inserted into the filtered AC outlet; no other equipment with a direct plug-in is allowed. Power

cord needs to be a maximum of 1 m long and a minimum of 0.75 mm square of cross-sectional area.

- Do not plug devices into the XAV5602 filtered AC outlet that exceed the product ratings. The output voltage of the filtered AC outlet is the same as the power outlet that the XAV5602 is plugged into. To help avoid damaging your system, be sure that the attached devices are electrically rated to operate with the power available in your location.
- If the input AC voltage is less than 100 Vac, the device plugged into the filtered AC socket of the XAV5602 might not perform as well as expected.
- **DO NOT PLUG MAJOR HOME APPLIANCES** into the filtered AC socket or into an attached powerstrip. The device is not intended to be used with home appliances such as air conditioners, power tools, space heaters, fans, hair dryers, ovens, or refrigerators.

Compliance



This symbol was placed in accordance with the European Union Directive 2002/96 on the Waste Electrical and Electronic Equipment (the WEEE Directive). If disposed of within the European Union, this product should be treated and recycled in accordance with the laws of your jurisdiction implementing the WEEE Directive.



NETGEAR, Inc.
350 East Plumeria Drive
San Jose, CA 95134 USA



201-14947-01

May 2012

Free Manuals Download Website

<http://myh66.com>

<http://usermanuals.us>

<http://www.somanuals.com>

<http://www.4manuals.cc>

<http://www.manual-lib.com>

<http://www.404manual.com>

<http://www.luxmanual.com>

<http://aubethermostatmanual.com>

Golf course search by state

<http://golfingnear.com>

Email search by domain

<http://emailbydomain.com>

Auto manuals search

<http://auto.somanuals.com>

TV manuals search

<http://tv.somanuals.com>