

NETGEAR

MODEL
DS104/DS106/DS108/DS116

Dual Speed Hub Installation Guide

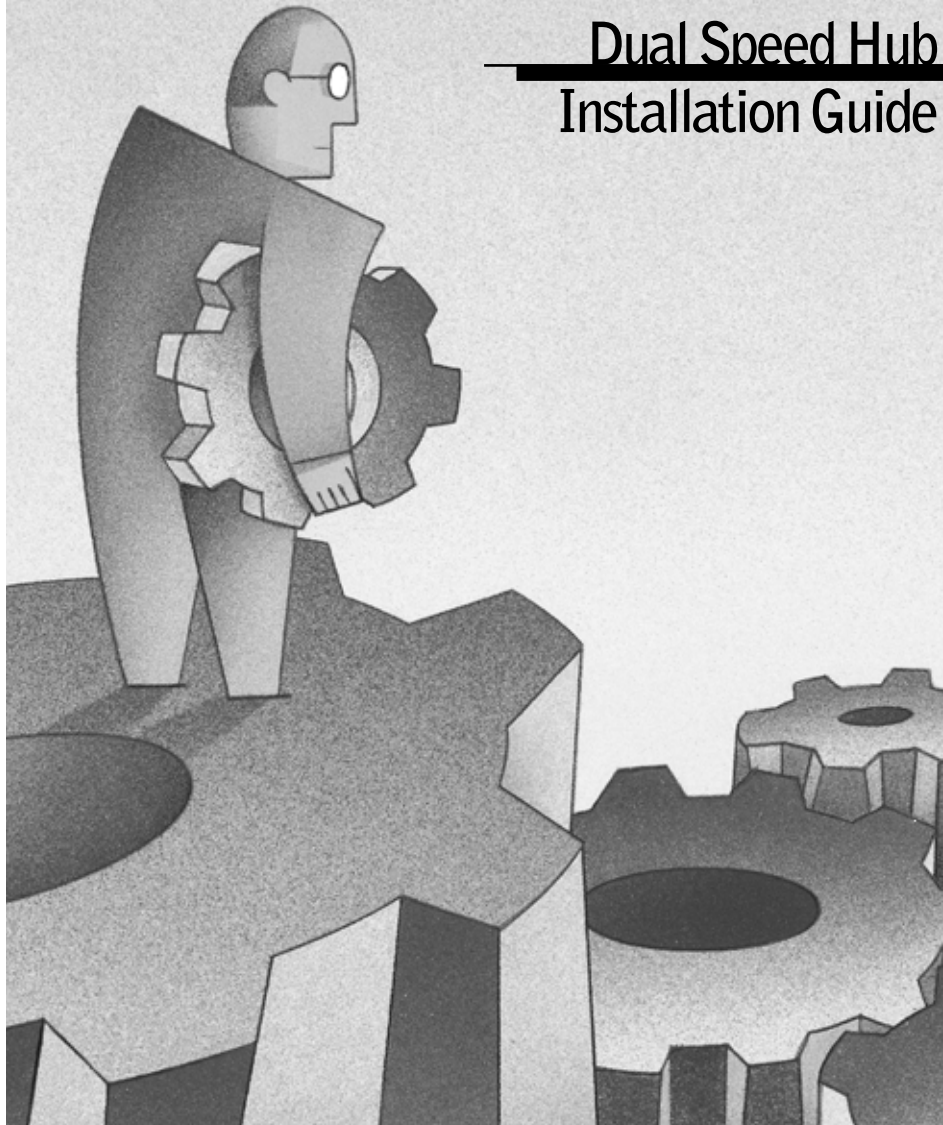



Start Here

The NETGEAR™ Model DS104, Model DS106, Model DS108, and Model DS116 Dual Speed Hubs are network hubs that enable users to mix and match 10 and 100 megabit per second (Mbps) devices on the same network. This capability eliminates the high cost and complexity of separate network equipment for 10 and 100 Mbps users. These four hubs, also known as the DS100 Series hubs, are ideal for small networks in transition from 10 to 100 Mbps and for linking networks operating at different speeds.

All four hub models connect PCs to share printers, files, Internet access, and e-mail communications. Each network port coordinates with the connected PC to run at 10 or 100 Mbps, making network configuration and upgrade effortless. In addition, the 10 and 100 Mbps network segments are internally bridged to form one network, providing full connectivity among all users.



Features

The DS100 Series hubs have the following key features:

- Per port, autosensing, dual-speed (10/100 Mbps) operation
- IEEE 802.3u standard compliance for interoperation with all 100BASE-TX Fast Ethernet (100 Mbps) products and 802.3i standard compliance for interoperation with all 10BASE-T Ethernet products
- Easy Plug-and-Play installation with no software to configure, saving time and minimizing the potential for configuration errors
- Ability of each port on the hub to independently detect the speed of the attached device and to automatically connect at the appropriate speed
- Internally bridged 10 and 100 Mbps network segments to form one network, providing full connectivity among all users
- Chassis equipped with:
 - Four (Model DS104), six (Model DS106), eight (Model DS108), or 16 (Model DS116) 10BASE-T or 100BASE-TX ports to provide fast information exchange, resource sharing, and client or peer-to-peer communication using simple Category 5 UTP wiring
 - Built-in vista LEDs on each network port clearly indicating individual port status
 - Additional LEDs providing network traffic status for the hub
 - Two LED bar graphs (on the Model DS104, Model DS106, and Model DS108 only) providing online status of network utilization and alerting you to potential network overload
 - Normal/Uplink push button for simplifying network extension
- Compact, durable design that enables tabletop or wall mounting
- Limited five-year warranty on the hub and three-year warranty on the power adapter



Package Contents

Verify that the package contains the following items, as shown in the diagram:

- DS100 Series hub
- Wall mount hardware
- Rubber footpads for tabletop installation
- This installation guide
- Warranty & Owner Registration Card
- Support Information Card
- Power adapter

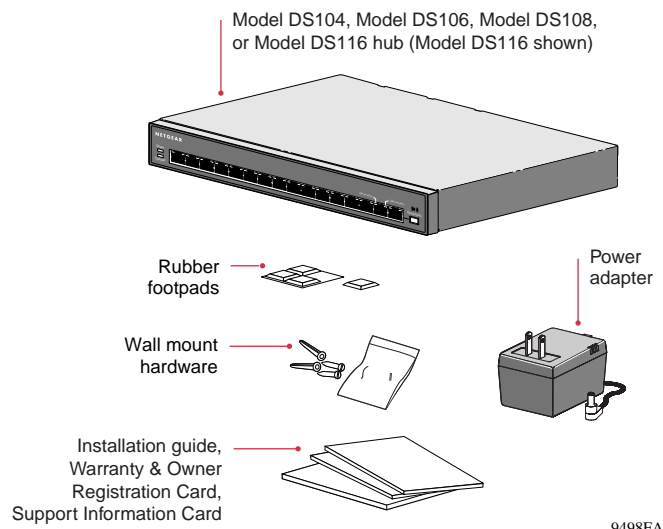

Caution: Use the appropriate power cord as required by your national electrical codes and ordinances.



Typical Applications

Refer to the following illustration when connecting your DS100 Series hub. The illustration shows a Model DS116 hub connecting users to a printer, servers, and a router. You can substitute a Model DS104, Model DS106, or Model DS108 hub, depending on the number of connections required.

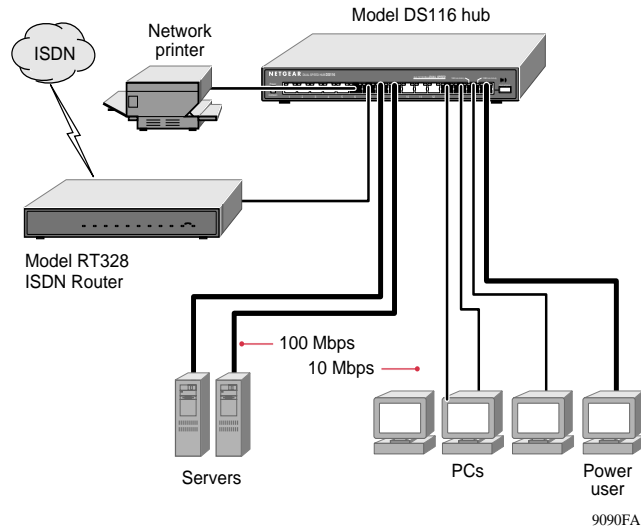



Product Illustration

Front Panel of the Model DS104 Hub

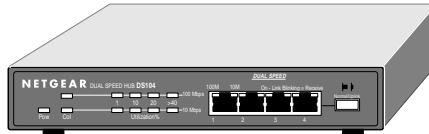

Front Panel of the Model DS106 Hub

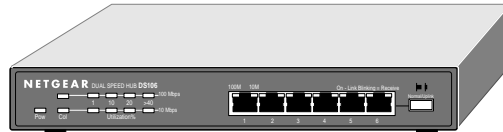

Front Panel of the Model DS108 Hub

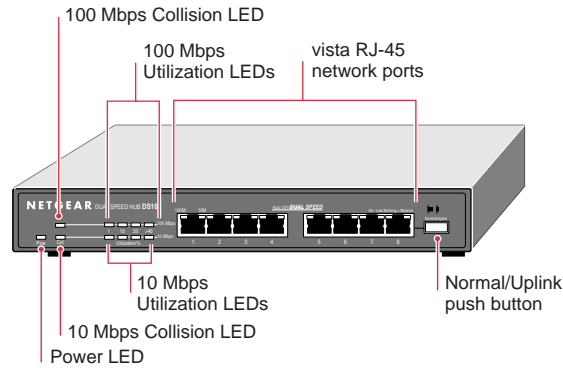

Front Panel of the Model DS116 Hub

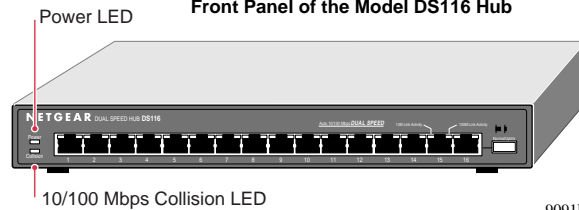

9091FB

Front-Panel LEDs

The DS100 Series hubs provide front-panel LEDs for monitoring individual ports and hub status. The following tables describe the front-panel LEDs and their functions.

Model DS104, Model DS106, and Model DS108 LEDs

Label	Color	Activity	Description
Power	Green	On	Power is supplied to the hub.
Collision			
10 Mbps	Amber	On	Data collision is occurring on the 10 Mbps network segment (some collisions are normal).
100 Mbps	Amber	On	Data collision is occurring on the 100 Mbps network segment (some collisions are normal).
Utilization%			
10 Mbps	Green	Blinking	Indicates the amount of data traffic on the 10 Mbps segment. (If a 100 Mbps user is sending data to a 10 Mbps user, the 10 Mbps utilization will be high.)
100 Mbps	Green	Blinking	Indicates the amount of data traffic on the 100 Mbps segment.
10M or 100M Link/Receive (built into each vista RJ-45 network port)	Green	On	A link is successfully established between the hub and the PC.
		Off	No data link is established and/or the cable is not connected, is defective, or is the wrong type.
		Blinking	There is incoming data on the port.

Model DS116 LEDs

Label	Color	Activity	Description
Power	Green	On	Power is supplied to the hub.
Collision	Amber	On	Data collision is occurring on a 10 Mbps or 100 Mbps network segment (some collisions are normal).
10M or 100M Link/Receive (built into each vista RJ-45 network port)	Green	On	A link is successfully established between the hub and the PC.
		Off	No data link is established and/or the cable is not connected, is defective, or is the wrong type.
		Blinking	There is incoming data on the port.

Vista RJ-45 Network Ports with Built-in LEDs

The front panel of the Model DS104 hub provides four vista RJ-45 network ports (six on the Model DS106 hub, eight on the Model DS108 hub, 16 on the Model DS116 hub). These standard RJ-45 connectors accept two-pair or four-pair Category 5 unshielded twisted pair (UTP) copper wiring (only two pairs are used). The RJ-45 connector uses an 8-pin interface. Two LEDs are positioned at the top corners of each RJ-45 connector. The left indicator is the 100 Mbps Link/Receive LED, and the right indicator is the 10 Mbps Link/Receive LED. The illustration shows the Model DS116 Link/Receive LEDs. The LEDs for the Model DS104, Model DS106, and Model DS108 hubs are identical. The table that follows describes the LEDs for all three models.

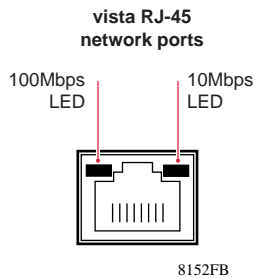

LED Status	Description
On	Link (Good Connection)
Blinking	RX (Receive Data)

Rear Panel

The rear panels of the DS100 Series hubs are identical. Each has a ground clip and a receptacle for the power adapter.

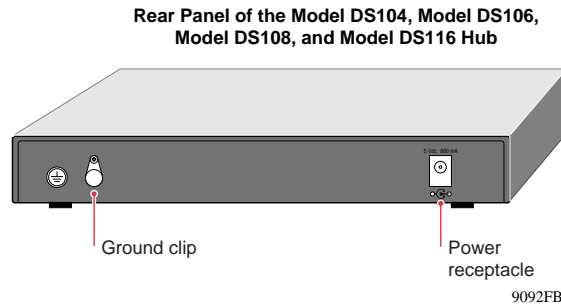



Installation Procedures



Prepare the Site

Before you begin installing the hub, prepare the installation site. Make sure the site meets the operating environment requirements of the equipment.

Characteristic	Requirement
Temperature	Ambient temperature between 0° and 40° C (32° and 104° F). No nearby heat sources such as direct sunlight, warm air exhausts, or heaters.
Humidity	90% maximum relative humidity, noncondensing.
Ventilation	Minimum 2 inches (5.08 cm) on all sides for cooling. Adequate airflow in room or wiring closet.
Operating conditions	At least 6 feet (1.83 m) to nearest source of electromagnetic noise (such as photocopier machine or arc welder).
Service access	Minimum 12 inches (19.68 cm) front and back for service access and maintenance. Front and back clearance for cables and wiring hardware such as punchdown blocks.
Power	Adequate power source within 6 feet (1.83 m).
Wiring hardware	Wiring hardware, such as punchdown blocks or patch panels, complete before installing the hub.



Install the Hub

Install the Hub on a Flat Surface

If installing the hub on a flat surface such as a tabletop, make sure the bottom of the chassis is clean and dry.

To install the hub on a flat surface:

- 1. Set the hub on a table or shelf so that it has at least 2 inches (5 cm) of space on all sides.**
- 2. Connect the power cord(s) first to the power entry receptacle on the hub rear panel and then to the wall.**

Install the Hub on a Wall

If installing the hub on a wall, make sure you have a Phillips screwdriver.

To install the hub on a wall:

- 1. Set the mounting screws and anchors (supplied with the wall mount hardware) in the wall.**
- 2. Using the slots on the bottom of the hub, hang the hub on the wall.**
- 3. Connect the power cord(s) first to the power entry receptacle on the hub rear panel and then to the wall.**

3

Connect a PC to the Hub

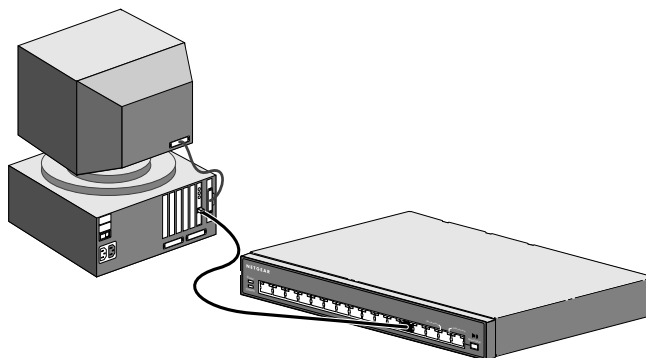

9097FA

Set Normal/Uplink Push Button

The Normal/Uplink push button on the front panel of the hub allows you to select the Uplink (MDI) or Normal (MDI-X) position for port 4 on the Model DS104 hub, port 6 on the Model DS106 hub, port 8 on the Model DS108 hub, and port 16 on the Model DS116 hub. All other ports are wired Normal for direct connection to PCs.

Select Normal if connecting a PC, server, or router to the port. Select Uplink if connecting a hub or switch. The Normal/Uplink push button eliminates the need to use a crossover cable.



Caution: 100 Mbps operation requires the use of Category 5 UTP wiring with 100 Mbps certified connectors. NETGEAR highly recommends using Category 5 cable so your network can operate at either 10 or 100 Mbps.

4 Connect Hubs at 10/100 Mbps

10 or 100 Mbps Transmission with the Hub

Two Model DS104 hubs, two Model DS106 hubs, two Model DS108 hubs, two Model DS116 hubs, or a combination of DS100 Series hubs can be daisy-chained together at 100 Mbps to support a growing number of PCs. For larger networks, use a 10/100 Mbps switch such as the NETGEAR Model FS104 switch, as shown in the illustration below.

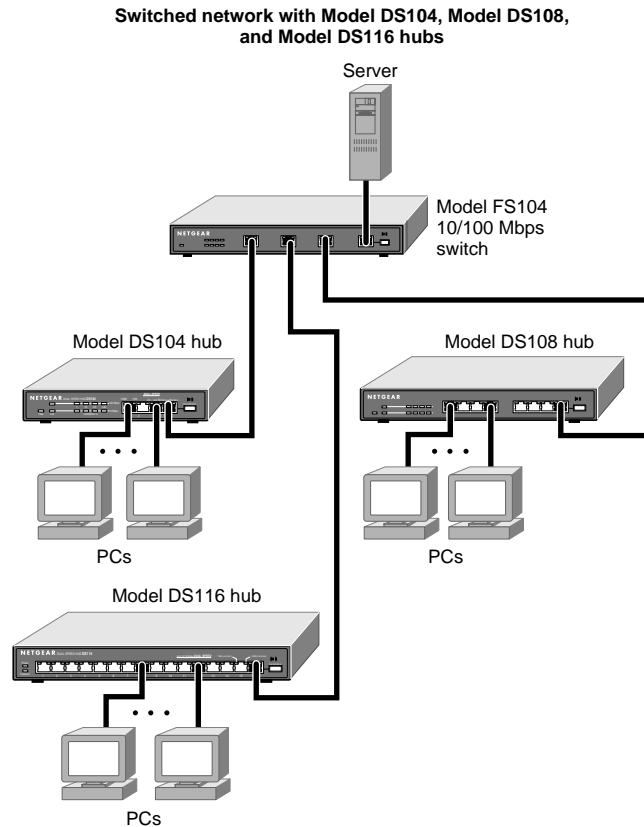

The following illustration shows a two-hub daisy-chain configuration. This illustration shows the Model DS104 hub and the Model DS116 hub daisy-chained together. You can use any two DS100 Series hubs in this configuration.

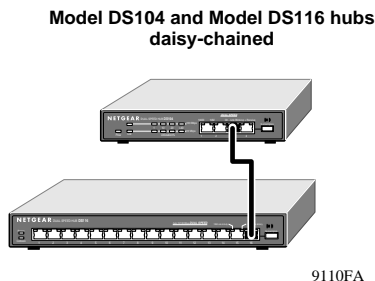

5

Verify the Installation

When installation is complete and power has been applied to the hub, the following conditions should exist:

- Power LED is on.
- Link LED on each connected port is on.
- Utilization LEDs on the front panel are blinking when data is being received by any port in the hub, and the Link/Receive LED on the connected port is blinking when data is being received by that port.

If there are any problems, refer to the Troubleshooting table.



Troubleshooting Information

Symptom	Cause	Solution
Link LED off or intermittent	Port connection not functioning	Make sure the power cord is properly connected and functioning. Check the crimp on the RJ-45 connectors and make sure that the plug is properly inserted and locked into the port at both the hub and the device. Make sure cabling is Category 5 and meets the requirements for 100 Mbps operation. Check installation of the network interface cards and verify that they are 100 Mbps capable. Be sure that the proper software driver is loaded. Check link LEDs on the network adapter card and PC or workstation. Make sure cables and connectors are correct.
Collision LED on or blinking	Collisions taking place on network segment(s)	Excessive collisions can be caused by incorrect cabling, connectors, or wiring techniques or can occur when the network is too busy. Ensure that the PC at the far end is set to half-duplex mode and is operating properly.
Problems with port 4 (DS104) or port 6 (DS106) or port 8 (DS108) or port 16 (DS116)	Normal/Uplink push button in the wrong position	Check the Normal/Uplink push button on the front panel.



Technical Specifications

Specification	Model DS116 Hub	Model DS108 Hub	Model DS106 Hub	Model DS104 Hub
Network Ports (RJ-45)	16	8	6	4
Dimensions				
Width	11.3 in. (286 mm)	9.3 in. (235 mm)	9.3 in. (235 mm)	6.2 in. (158 mm)
Height	1.1 in. (27 mm)	1.1 in. (27 mm)	1.1 in. (27 mm)	1.1 in. (27 mm)
Depth	4.0 in. (101 mm)	4.0 in. (101 mm)	4.0 in. (101 mm)	4.0 in. (101 mm)
Weight	2.1 lb (0.9 kg)	1.7 lb (0.74 kg)	1.32 lb (0.58 kg)	0.87 lb (0.4 kg)
Power Specifications				
Input voltage	100 to 240 V AC, 50 to 60 Hz	JP 100 V NA 120 V UK 240 V AU 240 V GE 230 V	50 or 60 Hz 60 Hz 50 Hz 50 Hz 50 Hz	
Output voltage	5 V DC at 5.0 A, max	12 V DC @ 1.2 Amps, maximum		
Power consumption	18 W	8 W	7 W	5 W
Standards Compliance	IEEE 802.3i 10BASE-T Ethernet IEEE 802.3u 100BASE-TX Fast Ethernet Compatible with all popular network software, including Windows®, NetWare, and UNIX			
Environmental Specifications				
Operating temperature	0° to 40° C (32° to 104° F)			
Operating humidity	90% maximum relative humidity, noncondensing			
Electromagnetic Compliances	CE mark, commercial FCC Part 15, Class A EN 55 022 (CISPR 22), Class A VCCI Class A. C-Tick			
Safety Agency Approvals	CE mark, commercial UL listed Power adapter cUL listed TUV licensed T-Mark			
Warranty				
Hub	Limited Lifetime			
Power adapter	3 YEARS			



Replacement Power Adapter

If, for any reason, the power adapter for any of the hubs fails, please contact NETGEAR immediately to order a replacement adapter. Use the following table to when ordering a specific power adapter.

Order code	DS104, DS106, DS108
PWR-002-004	Power adapter (12 V DC, 1.2 A), North America
PWR-002-005	Power adapter (12 V DC, 1.2 A), Japan
PWR-002-006	Power adapter (12 V DC, 1.2 A), Europe
PWR-002-008	Power adapter (12 V DC, 1.2 A), United Kingdom
PWR-002-010	Power adapter (12 V DC, 1.2 A), Australia

Order code	DS116
PWR-023-002	Power adapter kit (5 V DC, 5 A), North America
PWR-023-002	Power adapter kit (5 V DC, 5 A), Japan
PWR-023-002	Power adapter kit (5 V DC, 5 A), Europe
PWR-023-002	Power adapter kit (5 V DC, 5 A), United Kingdom
PWR-023-002	Power adapter kit (5 V DC, 5 A), Australia



Note: Keep the power cord for the DS116 power supply.
A new cord is not provided.

If you are replacing a power supply, please confirm the voltage required by looking on the back of the hub. If you own an early version of the DS104, DS106, or DS108 that is 5 V, please order the DS116 power supply.

© 2000 by NETGEAR, Inc. All rights reserved.

Trademarks

NETGEAR™ is a trademark of NETGEAR, Inc. Windows® is a registered trademark of Microsoft Corporation. Other brand and product names are trademarks or registered trademarks of their respective holders. Information is subject to change without notice.

Statement of Conditions

In the interest of improving internal design, operational function, and/or reliability, NETGEAR reserves the right to make changes to the products described in this document without notice.

NETGEAR does not assume any liability that may occur due to the use or application of the product(s) or circuit layout(s) described herein.

Certificate of the Manufacturer/Importer

It is hereby certified that the Model DS104 Dual Speed Hub, Model DS106 Dual Speed Hub, Model DS108 Dual Speed Hub, and Model DS116 Dual Speed Hub have been suppressed in accordance with the conditions set out in the BMPT-AmtsblVfg 243/1991 and Vfg 46/1992. The operation of some equipment (for example, test transmitters) in accordance with the regulations may, however, be subject to certain restrictions. Please refer to the notes in the operating instructions.

Federal Office for Telecommunications Approvals has been notified of the placing of this equipment on the market and has been granted the right to test the series for compliance with the regulations.

Voluntary Control Council for Interference (VCCI) Statement

This equipment is in the first category (information equipment to be used in commercial and/or industrial areas) and conforms to the standards set by the Voluntary Control Council for Interference by Data Processing Equipment and Electronic Office Machines that are aimed at preventing radio interference in commercial and/or industrial areas.

Consequently, when this equipment is used in a residential area or in an adjacent area thereto, radio interference may be caused to equipment such as radios and TV receivers.

Federal Communications Commission (FCC) Compliance Notice: Radio Frequency Notice

Note: This equipment has been tested and found to comply with the limits for a Class A digital device, pursuant to Part 15 of the FCC rules. These limits are designed to provide reasonable protection against harmful interference when the equipment is operated in a commercial environment. This equipment generates, uses, and can radiate radio frequency energy. If it is not installed and used in accordance with the instruction manual, it may cause harmful interference to radio communications. Operation of this equipment in a residential area is likely to cause harmful interference, in which case users will be required to take whatever measures may be necessary to correct the interference at their own expense.

EN 55 022 Statement

This is to certify that the Model DS104 Dual Speed Hub, Model DS106 Dual Speed Hub, Model DS108 Dual Speed Hub, and Model DS116 Dual Speed Hub are shielded against the generation of radio interference in accordance with the application of Council Directive 89/336/EEC, Article 4a. Conformity is declared by the application of EN 55 022 Class A (CISPR 22).

	Warning: This is a Class A product. In a domestic environment, this product may cause radio interference, in which case, the user may be required to take appropriate measures.
---	--

Canadian Department of Communications Radio Interference Regulations

This digital apparatus (Model DS104 Dual Speed Hub, Model DS106 Dual Speed Hub, Model DS108 Dual Speed Hub, and Model DS116 Dual Speed Hub) does not exceed the Class A limits for radio-noise emissions from digital apparatus as set out in the Radio Interference Regulations of the Canadian Department of Communications.

Règlement sur le brouillage radioélectrique du ministère des Communications

Cet appareil numérique (Model DS104 Dual Speed Hub, Model DS106 Dual Speed Hub, Model DS108 Dual Speed Hub, et Model DS116 Dual Speed Hub) respecte les limites de bruits radioélectriques visant les appareils numériques de classe A prescrites dans le Règlement sur le brouillage radioélectrique du ministère des Communications du Canada.

NETGEAR

NETGEAR, Inc.
4500 Great America Parkway
Santa Clara, CA 95054
USA

Phone: 1-888-NETGEAR
E-mail: support@NETGEAR.com
<http://www.NETGEAR.com>



Free Manuals Download Website

<http://myh66.com>

<http://usermanuals.us>

<http://www.somanuals.com>

<http://www.4manuals.cc>

<http://www.manual-lib.com>

<http://www.404manual.com>

<http://www.luxmanual.com>

<http://aubethermostatmanual.com>

Golf course search by state

<http://golfingnear.com>

Email search by domain

<http://emailbydomain.com>

Auto manuals search

<http://auto.somanuals.com>

TV manuals search

<http://tv.somanuals.com>