

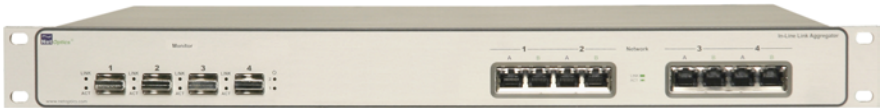

Installation Guide for Link Aggregator Tap 10/100 In-Line to GigaBit with SFP Monitor Ports



Doc. PUBLAIF4CU4SFPU Rev. 1, 10/08

Contents

Introduction	1
Key Features	2
Application Diagram	3
Cabling Guidelines	3
Product Diagrams	4
LED Indicators	5
Connecting to the Network	5
Connecting to the Monitoring Device	6
Dip Switch Settings	7
Specifications	8
Limitations on Warranty and Liability	9

PLEASE READ THESE LEGAL NOTICES CAREFULLY.

By using a Net Optics Tap you agree to the terms and conditions of usage set forth by Net Optics, Inc. No licenses, express or implied, are granted with respect to any of the technology described in this manual. Net Optics retains all intellectual property rights associated with the technology described in this manual. This manual is intended to assist with installing Net Optics products into your network.

Trademarks and Copyrights

© 2007 by Net Optics, Inc. Net Optics® is a registered trademark of Net Optics, Inc. Additional company and product names may be trademarks or registered trademarks of the individual companies and are respectfully acknowledged.

Additional Information

Net Optics, Inc. reserves the right to make changes in specifications and other information contained in this document without prior notice. Every effort has been made to ensure that the information in this document is accurate.

Introduction

Thank you for choosing the most versatile monitoring Tap available today. Net Optics Link Aggregator Taps are an efficiency breakthrough for passively monitoring multiple full-duplex links. Whether you are a novice or an expert, this installation guide is designed to help answer any questions and to provide a quick set-up reference.

Net Optics Link Aggregator Tap provides superior monitoring coverage while leveraging monitoring resources. Providing traffic from multiple network links, the Link Aggregator Tap combines up to four full-duplex 10/100BaseT links (eight half-duplex data streams) into one, two or four GigaBit monitor ports.

Installing a monitoring device in each segment of the network is often time consuming and expensive. Restricted by tight budgets, security managers must make compromises that leave portions of the network exposed to attacks. Net Optics' Link Aggregator addresses this challenge by increasing the number of links covered by monitoring devices already installed.

No Packets Left Behind

The Link Aggregator Tap buffers and scans incoming traffic from the network ports on a round-robin basis. Buffer size and scan rate is optimized to ensure that no packets are dropped and there is no bandwidth limitation on incoming data streams. The buffers and the high bandwidth of GigaBit monitor ports guarantee that no data is lost during traffic surges.

Security and Visibility

Without an IP address, monitoring devices are isolated from the network, dramatically reducing their exposure to attacks. However, the monitoring device connected to the Tap still sees all full-duplex traffic as if it were in-line, including Layer 1 and Layer 2 errors.

Reliability

For extra uptime protection, Net Optics Taps offer redundant power connections. Should the primary power source fail, the Tap automatically switches to the backup power source. Power LEDs on the front of the Tap indicate the current power source.

Key Features

Passive, Secure Technology

- Supports full-duplex monitoring of four links with a single NIC, increasing monitoring efficiency
- Optional Regeneration Tap technology enables up to four devices to simultaneously monitor all aggregated traffic
- Unique Zero Delay™ technology ensures no packet delay or loss if power is lost to the Tap
- Provides complete full-duplex visibility at 10 or 100 Mbps without data stream interference or introducing a point of failure
- Passes all traffic (including errors) from all layers for comprehensive troubleshooting
- No IP address is needed for the Tap or monitoring device, enhancing monitoring security
- Redundant power ensures monitoring uptime
- Fully RoHS compliant
- Fully IEEE 802.3 compliant

Ease of Use

- LED indicators show redundant power, speed, link, and activity status
- Front-mounted connectors support easy installation and operation
- Monitoring and network cables included for plug-and-play deployment
- Silk-screened application diagram illustrates all connections for easy deployment
- Small form-factor pluggable (SFP) monitor port connectors increase monitoring options
- Compatible with all major manufacturers' monitoring devices, including protocol analyzers, probes, and intrusion detection/prevention systems

Support

- Net Optics offers free technical support throughout the lifetime of your purchase. Our technical support team is available from 8 am to 5 pm Pacific Time, Monday through Friday at +1 (408) 737-7777 and via email at ts-support@netoptics.com. FAQs are also available on Net Optics website at www.netoptics.com.

Application Diagram

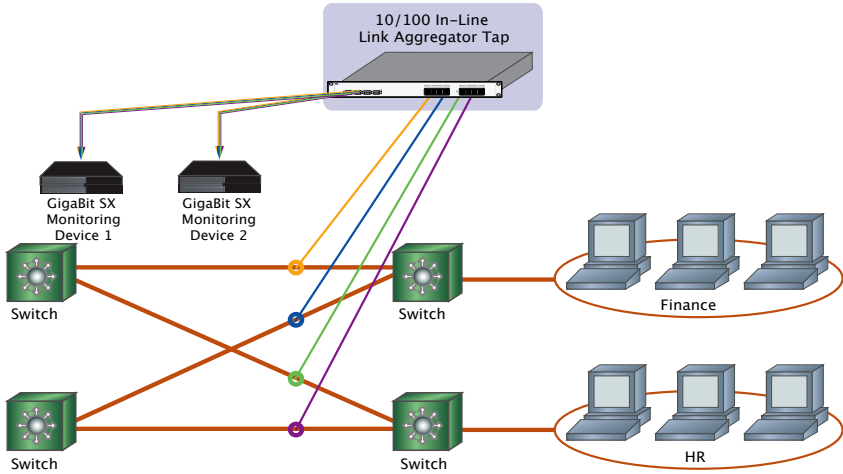

Figure 1: Application Diagram

Zero Delay™ - A Net Optics Breakthrough

Highly sensitive network locations can improve monitoring performance via the innovative features of Net Optics Taps. If power is lost to other 10/100 Taps, the connected devices may introduce delays as they detect the power loss and try to re-establish their link. Net Optics' pioneering design ensures that any loss of power to the Tap is transparent to the network and does not affect the flow of traffic through the Tap – eliminating packet delay and loss as potential security issues.

Cabling Guidelines

- If connecting to Switches or Hubs, use CAT5e RJ45 cross-over cabling
- If connecting to routers or NICs, use CAT5e RJ45 straight-through cabling

Unpacking and Inspection

Carefully unpack the 10/100 In-Line Link Aggregator Tap and check for damaged or missing parts. The Link Aggregator Tap ships with the following:

- 10/100 In-Line Link Aggregator Tap
- Two power cords
- Installation Guide

In addition to the Port Aggregator, you should have ordered at least one SFP module. You may have also ordered an extended warranty. Carefully check the packing slip against parts received. If any part is missing or damaged, contact Net Optics' Customer Service immediately.

Part Number	Description
LA-IF4CU/4SFP	In-line 10/100 to SFP Link Aggregator
LA-IF4CU/4SFP-48V	In-line 10/100 to SFP Link Aggregator, -48V DC

Product Diagrams

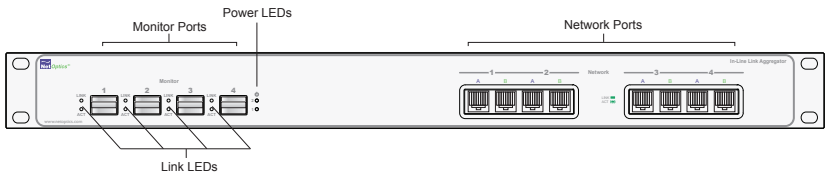

Figure 2: Front Panel

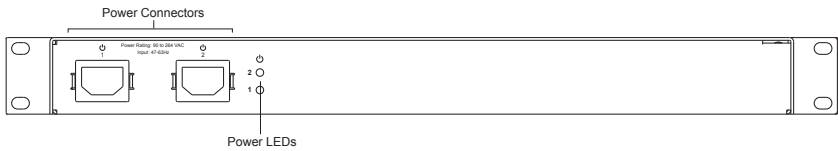

Figure 3: Rear Panel

LED Indicators

- **PWR 1/ PWR 2:** Main and Redundant Power. If the Tap is deployed with both power supplies, both LEDs illuminate when the Tap is plugged in. If an LED is off, this indicates that the corresponding power supply is not connected or not functioning.
- **Activity Indicator:** When there is activity on the link, LED flashes green.
- **Link Indicator:** When a good link is established, the LED is a solid green.

Connecting to the Network

To connect to the network:

1. Connect Network Port 1 to the appropriate switch, server or router device using a CAT5e RJ45 cable.
2. Connect Network Port 2 to the appropriate switch, server or router device using a CAT5e RJ45 cable.

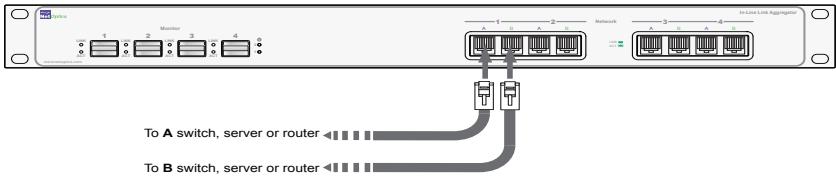

Figure 4: Connecting to the Network

3. Repeat Steps 1 and 2 for the rest of the network ports of the Link Aggregator Tap.
4. Verify that the Link Aggregator Tap Network Ports are cabled in-line between two devices.

Note:

The second power supply is available to support the flow of traffic to the monitoring device should the first power supply fail. If the first power supply is unavailable, the second power supply supplies all power for the Tap.

NOTE:

At 10Mbps, if any of the network links are unplugged during operation, it will be necessary to restart traffic from the connected network devices upon re-connecting to the Link Aggregator. This is to ensure that traffic is properly copied to the monitor ports and only applies to networks running at 10Mbps.

Connecting Monitoring Devices

1. Supply power to the Tap using the power supply adapter included with the unit. Verify that the power LED illuminates.
2. Remove the SFP from its protective packaging.
3. Remove the temporary plug from Monitor Port 1.

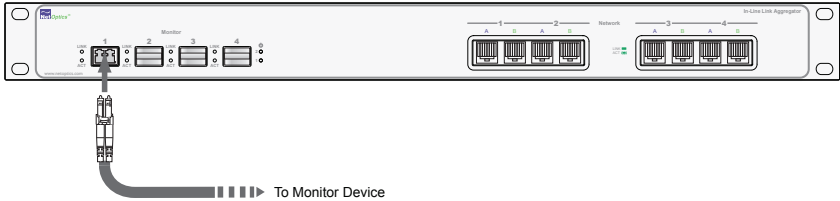
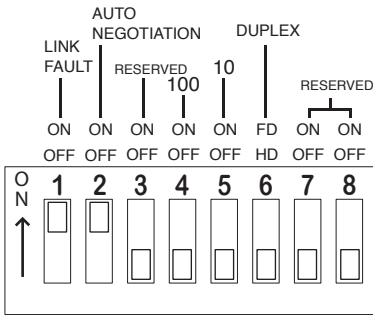

Figure 5: Connecting to Monitoring Devices using SFP modular connectors

4. Insert the SFP in the Monitor 1 Port until you hear it click into place.
5. Connect Monitoring Port 1 to the appropriate port on the monitoring device. This will monitor all aggregated links connected to the network ports.
6. If you are installing multiple SFPs, repeat Steps 1 through 4 for Monitor Port 2.

Note:

The 10/100 Link Aggregator is shipped with the following default dip-switch settings. It is strongly recommended that you do not make any changes to these settings, except when needed, and only to switches 2,4,5 and 6. If Switch 3, for example, is toggled to "on," the Link Aggregator will not get a valid link. In the event that the aforementioned occurs, it will be necessary to return the dip-switches to the default states and to power-cycle the unit.



NOTE: To activate, push buttons UP.
(This diagram shows all segments in the OFF position)

Figure 6: Default Dip-switch Settings

Specifications

Environment

Operating Temperature: 0°C to 55°C

Storage Temperature: -10°C to 70°C

Relative Humidity: 10% min, 95% max, non-condensing

Power

Power Supply Input: 100-240VAC, 0.5A, 47-63Hz

DC Power Input: -48 VDC typical, -36 VDC min, -75 VDC max

Mechanical

Dimensions: 1.75" high x 17.125" deep x 17" wide

Certifications

Fully RoHS compliant

Copper Interface

Cable Type: 22-24 AWG unshielded twisted pair cable, CAT5/CAT5e

Link Distance Supported: 100 meters

Optical Interface

Fiber Type: Multimode: Corning 62.5/125 μ m, wavelength, 850nm

Fiber Type: Singlemode: Corning 8.5/125 μ m, wavelength, 1310nm

Connectors

LA-IF4CU/4SFP and LA-IF4CU/4SFP-48V:

(8) RJ45, 8-pin connectors (network ports)

(4) SFP ports for SFP modular connectors

Accessories

SFP Conversion Kits

SFPKT-SX Multimode fiber SFP with cable

SFPKT-LX Singlemode fiber SFP with cable

SFPKT-CU GigaBit copper SFP with cable

Limitations on Warranty and Liability

Net Optics offers a limited warranty for all its products. IN NO EVENT SHALL NET OPTICS, INC. BE LIABLE FOR ANY DAMAGES INCURRED BY THE USE OF THE PRODUCTS (INCLUDING BOTH HARDWARE AND SOFTWARE) DESCRIBED IN THIS MANUAL, OR BY ANY DEFECT OR INACCURACY IN THIS MANUAL ITSELF. THIS INCLUDES BUT IS NOT LIMITED TO LOST PROFITS, LOST SAVINGS, AND ANY INCIDENTAL OR CONSEQUENTIAL DAMAGES ARISING FROM THE USE OR INABILITY TO USE THIS PRODUCT, even if Net Optics has been advised of the possibility of such damages. Some states do not allow the exclusion or limitation of implied warranties or liability for incidental or consequential damages, so the above limitation or exclusion may not apply to you.

Net Optics, Inc. warrants this Tap to be in good working order for a period of ONE YEAR from the date of purchase from Net Optics or an authorized Net Optics reseller.

Should the unit fail anytime during the said ONE YEAR period, Net Optics will, at its discretion, repair or replace the product. This warranty is limited to defects in workmanship and materials and does not cover damage from accident, disaster, misuse, abuse or unauthorized modifications.

If you have a problem and require service, please call the number listed at the end of this section and speak with our technical service personnel. They may provide you with an RMA number, which must accompany any returned product. Return the product in its original shipping container (or equivalent) insured and with proof of purchase.

Additional Information

Net Optics, Inc. reserves the right to make changes in specifications and other information contained in this document without prior notice. Every effort has been made to ensure that the information in this document is accurate. Net Optics is not responsible for typographical errors.

THE WARRANTY AND REMEDIES SET FORTH ABOVE ARE EXCLUSIVE AND IN LIEU OF ALL OTHERS, EXPRESS OR IMPLIED. No Net Optics reseller, agent, or employee is authorized to make any modification, extension, or addition to this warranty.

Net Optics is always open to any comments or suggestions you may have about its products and/or this manual.

Send correspondence to
Net Optics, Inc.
5303 Betsy Ross Drive
Santa Clara, CA 95054 USA
Telephone: +1 (408) 737-7777
Fax: +1 (408) 745-7719
Email: info@netoptics.com/Internet: www.netoptics.com

All Rights Reserved. Printed in the U.S.A. No part of this publication may be reproduced, transmitted, transcribed, stored in a retrieval system, or translated into any language or computer language, in any form, by any means, without prior written consent of Net Optics, Inc., with the following exceptions: Any person is authorized to store documentation on a single computer for personal use only and that the documentation contains Net Optics' copyright notice.

www.netoptics.com

© 2008 by Net Optics, Inc. All Rights Reserved.

Download from Www.Somanuals.com. All Manuals Search And Download.

Free Manuals Download Website

<http://myh66.com>

<http://usermanuals.us>

<http://www.somanuals.com>

<http://www.4manuals.cc>

<http://www.manual-lib.com>

<http://www.404manual.com>

<http://www.luxmanual.com>

<http://aubethermostatmanual.com>

Golf course search by state

<http://golfingnear.com>

Email search by domain

<http://emailbydomain.com>

Auto manuals search

<http://auto.somanuals.com>

TV manuals search

<http://tv.somanuals.com>