

# TRANSDUCTION



## USER'S MANUAL

Version 1.3

06/19/09

## TR-5001 NEMA 4 Panel Mount PC with LCD TFT Touch Screen

5155-23 Spectrum Way, Mississauga, ON, Canada L4W 5A1  
TEL: 1-800-268-0427, 905-625-1907

FAX: 905-625-0531

# Table of Contents

Important Information .....	i
Warranty .....	i
Recommended Use .....	ii
 <i>Chapter 1 - Introduction</i>	
Contents .....	2
TR-5001 Specifications .....	3
Driver Installation .....	4
Touchscreen .....	5-12
 <i>Chapter 2 - SBC introduction</i>	
Checklist .....	14
Description .....	14-15
Features .....	16
Specifications .....	17-20
 <i>Chapter 3 - Installations</i>	
CPU Installation .....	22
Memory Installation .....	23
Jumpers on the TR-979 .....	24-29
Connectors on the TR-979 .....	30-45
Watchdog Timer Configuration .....	46
 <i>Chapter 4 - BIOS Configuration</i>	
BIOS Introduction .....	48-50
Main Menu .....	51-52
Standard CMOS Setup .....	53-57
Advanced BIOS Features .....	58-63
Advanced Chipset Features .....	64-67
Integrated Peripherals .....	68-74
Power Management Setup .....	75-78
PnP/PCI Configuration .....	79-81
PC Health Status .....	82-83
Frequency/Voltage Control .....	84
Load Fail-Safe Defaults .....	85
Load Optimized Defaults .....	85
Supervisor/User Password Settings .....	86
Exit Selecting .....	87
 <i>Appendix</i>	
I/O Port Address Map .....	89
Interrupt Request Lines (IRQ) .....	90
POST Beep .....	91
TR-5001 Mechanical Drawings .....	92-100

### ***Important Information***

*The information in this document is subject to change without notice.*

*All relevant issues have been considered in the preparation of this document. Should you notice an omission or any questionable item in this document, please feel free to notify Transduction.*

*Regardless of the foregoing statement, Transduction assumes no responsibility for any errors that may appear in this document nor for results obtained by the user as a result of using this product.*

### ***Copyright © 2009 Transduction. All rights reserved.***

*This document is protected by copyright. No part of this document may be reproduced, copied or translated in any form or means without prior written permission from Transduction.*

*All other trademarks, brand and product names are the property of their respective owners.*

### ***Return policy***

*Products returned for repair must be accompanied by a Return Material Authorization (RMA) number; obtained from Transduction prior to return. Freight on all returned items must be prepaid by the customer. The customer is responsible for any loss or damage caused by the carrier in transit.*

*To obtain an RMA number, call us at 905-625-1907. We will need the following information:*

- *Return company address and contract*
- *Model name, model number and serial number*
- *Description of the failure*

*Mark the RMA number clearly on the outside of each box, include a failure report and return the product to:*

*Transduction  
5155 – 23 Spectrum Way  
Mississauga ON Canada L4W 5A1  
Attn: RMA Department*

# Recommended Use

## Safety Precautions and Maintenance



FOR OPTIMUM PERFORMANCE, PLEASE NOTE  
THE FOLLOWING WHEN SETTING UP  
AND USING THE TR-5001-PM:

- **DO NOT OPEN THE MONITOR.** There are no user serviceable parts inside and opening or removing covers may expose you to dangerous shock hazards or other risks. Refer all servicing to qualified service personnel.
- Do not spill any liquids into the cabinet or use your monitor near water.
- Do not insert objects of any kind into the cabinet slots, as they may touch dangerous voltage points, which can be harmful or fatal or may cause electric shock, fire or equipment failure.
- Do not place any heavy objects on the power cord. Damage to the cord may cause shock or fire.
- Do not place this product on a sloping or unstable cart, stand or table, as the monitor may fall, causing serious damage to the monitor.
- When operating the TR-5001 with its AC 125-240V power supply, use a power supply cord that matches the power supply voltage of the AC power outlet being used. The power supply cord you use must have been approved by and comply with the safety standards of your country. (Type H05VV-F should be used in Europe)
- In UK, use a BS-approved power cord with molded plug having a black (5A) fuse installed for use with this monitor. If a power cord is not supplied with this monitor, please contact your supplier.
- Do not place any objects onto the monitor and do not use outdoors.
- The inside of the fluorescent tube located within the LCD monitor contains mercury. Please follow the bylaws or rules of your municipality to dispose of the tube properly.

Immediately unplug your unit from the power source and refer servicing to qualified service personnel under the following conditions:

- When the power supply cord or plug is damaged.
- If liquid has been spilled, or objects have fallen into the unit.
- If the unit has been exposed to rain or water.
- If the unit has been dropped or the cabinet damaged.
- If the unit does not operate normally by following operating instructions.
- Do not bend power cord.
- Do not use in high temperature, humid, dusty, or oily areas.
- If glass is broken, handle with care.
- Do not cover vents on unit.
- If monitor or glass is broken, do not come in contact with the liquid crystal and handle with care.
- Allow adequate ventilation around the unit so that heat can properly dissipate. Do not block ventilated openings or place near a radiator or other heat sources.
- Handle with care when transporting. Save packaging for transporting.

# 1

---

## Introduction

This chapter is designed to give you an overview on the TR-5001 industrial PC. The topics covered are as follows:

Contents .....	2
TR-5001 Specifications .....	3
Driver Installation .....	4
Touchscreen .....	5-12

# Contents

Your new **TR-5001** box\* should contain the following:

- **TR-5001** PC/LCD
- Power Cord
- User's Manual
- CD-ROM with drivers

Power Cord



TRANSDUCTION



TR-5001 Model 401 Panel Mount PC  
with LCD TFT Touch Screen

User's Manual



CD-ROM with drivers

*\*Remember to save your original box and packing material to transport or ship the monitor.*

# TR-5001 Specifications

<b>Model</b>	TR-5001 NEMA 4 Panel Mount and Rack Mount Industrial PC with TFT LCD Touch Screen
<b>Processor</b>	Intel Socket 478 for Pentium 4 or Celeron up to 3.6GHz with 800MHz FSB
<b>Display</b>	15" TFT LCD display Resolution - 1024 x 768 (XGA) Backlight MTBF 50,000 hours Brightness - 250cd/m <sup>2</sup> Contrast Ratio - 350:1 USB resistive touch screen
<b>Memory</b>	2 x 184 pin DIMM sockets, up to 2GB DDR memory
<b>Expansion Slots</b>	Seven slot backplane with one PICMG CPU card 4 x PCI, 2 x ISA and 1 x SBC slot
<b>Drive Bay</b>	2 x 3.5" HDD (RAID 1 Ok) or Flash SSD 1 x 5.25" SLIM CD-ROM or 1 x 5.25" SLIM DVD-ROM/CD-RW
<b>SVGA</b>	Intel 82865GV 16MB graphics controller 1600 x 1200 32-bit @ 60Hz
<b>Ethernet</b>	2 x Intel Pro 100/1000+ Mbps Fast Ethernet ports
<b>Solid State Disk</b>	High speed flash SATA SSD 16GB ~ 128GB
<b>I/O</b>	1 x internal XGA LVDS 1 x external SVGA DB15 2 x Serial RS-232 1 x Parallel 2 x USB 2.0 2 x RJ-45 LAN PS/2/keyboard/mouse connectors
<b>Watchdog Timer</b>	1 ~ 256 seconds
<b>Air Flow</b>	Optimized air flow with 62CFM (card cage) and 43CFM (power supply) quality NIDEC fans
<b>Power</b>	Output rating - 300W Input Voltage - 100 ~ 240VAC @ 47/63Hz Optional DC input power - 12V, 24V, 48V, 125V and 250V MTBF 80,000 hours Safety - UL, cUL, TUV, FCC and CE approved
<b>System Monitor</b>	Monitor processor temperature, system temperature and DC power voltages
<b>Operating Temperature</b>	Operating Temperature: 0° ~ 50°C (32° ~ 122°F), 60°C (144°F) for 2 hours Relative Humidity: 5 ~ 95%
<b>Dimensions</b>	17.25" (W) x 14.25" (H) x 6.4" (D) (6.25" (D) behind front panel) Rack mount version is 8U high N.W. 25 lbs, G.W. 30 lbs, CUFT. 6
<b>Chassis Colour</b>	Black, OEM colour optional
<b>Warranty</b>	3 years or 10% initial cost for 5 years
<b>Additional Options</b>	8U rack mount version Rear access Floppy/CD option Wall mounting bracket High speed flash SATA SSD 32 ~ 128GB IDE RAID 1 option BNC IRIG A/B time sync option

# Driver Installation

The Driver CD will auto-run when inserted in the CDROM drive. It will detect and select your single board computer and will help you to install the drivers automatically.

## **Install Related Chipset INF Driver**

The selection helps you to install the INF of related chipset interface.

## **Install VGA Driver**

The selection helps you to install the driver of the on-board VGA interface.

## **Install LAN Driver**

The selection helps you to install the driver of the on-board LAN interface.

## **Install Audio Driver**

The selection helps you to install the driver of the on-board audio interface.

## **Install Hi-Speed USB 2.0 Driver**

The selection helps you to install the driver of the on-board USB 2.0 interface.

## **Browse the CD**

The selection helps you to find the drivers in this CD directly.



# Touchscreen

## USB Controller Driver Installation

All Windows drivers are included on the Transduction **TR-5001** 8-wire Touchscreen Drivers CD along with Troubleshooting.

**NOTE:** For Win XP and 2000 you **MUST** logon with administrator's password.

**TouchKit** software on the driver CD has the required drivers and the utility for toggling between left and right mouse buttons and configuration support. These will all be installed when Setup.exe is run from the CD.

### For Windows 2000/XP

When the New Hardware Found message comes up, choose **Cancel**. Run the **Setup.exe** program from the driver CD.

Please note that the touch screen controller in the TR-5001 is **USB** and follow the prompts accordingly.

Windows will copy the files to your hard drive and setup will be complete. (Windows XP will give a warning message about the TouchKit Controller certification, press **Continue** anyway.)

Please reboot your computer.

Windows will now find the device automatically and it will be listed in the Device Manager as: *TouchKit USB Controller*.

### TouchKit Software

There are five property pages:

1. **GENERAL:** Language selection, add/remove devices, 4-point Calibration, Draw Test and Advanced

#### 4 pts Cal

Choose to calibrate your screen by touching the blinking symbol on the panel until you get a beep or it stops blinking



#### Draw Test

Test the drawing position in relation to the display screen to verify panel linearity, calibration capability and drawing line quality.

### Advanced

A 25 Point calibration utility for the touch sensor.

Press **Clear** to clear previous calibration records.

Press **25 pts Cal** to do 25 point calibration by touching the blinking symbol on the panel until you get a beep or it stops blinking. After calibration, the new record will overwrite the old one.



## 2. SETTING: Sound, Mouse Mode and Double Click Adjustment

### Sound

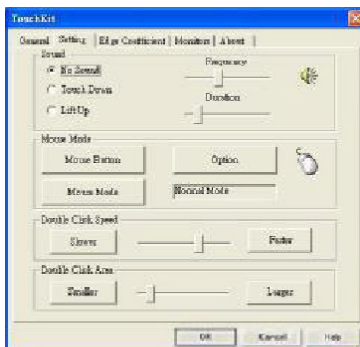

#### No Sound

Choose to make no sound when panel is touched.

#### Touch Down

Beep will sound when panel is touched.

#### Lift Up

The system will not make any sound until finger leaves the touch panel.

#### Frequency

Sound frequency, drag the cursor from left to right = low to high.

#### Duration

Sound duration, drag the cursor from left to right = short to long.

## Mouse Mode

The **Mouse Mode** provides users different operating options.

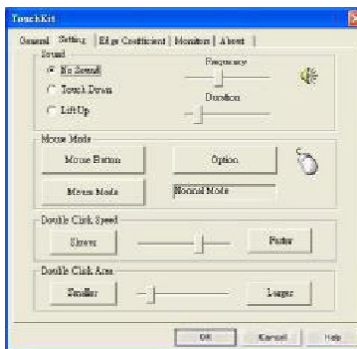

## Mouse Button

Click it to **show/hide Touch Tray** on the right bottom corner of the desktop. Users can choose show or hide **Touch Tray** from the mouse icon in the taskbar.

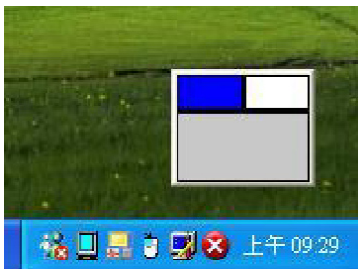

Change **right/left** button by clicking the upper small rectangular box of **Touch Tray**. Blue area indicates which button has been selected.

## Shutdown utility



Click on shutdown utility in the task bar



Shutdown utility dialog

There are five modes in shutdown utility:

**[Standby]** to enter standby mode that saves power consumption.

**[Shutdown]** to turn off PC.

**[Reboot]** to restart PC.

**[Cancel]** to escape from the Shutdown utility dialog.

**[Exit]** to disable the Shutdown utility.

**Please note that Windows NT does not support this function.**

## Mouse Mode

There are three mouse modes:

### [Normal Mode]

Provides all the mouse functions, including the dragging function.

### [Click on Touch]

Click action is executed as soon as panel is touched.

### [Click on Release]

Click action will not be executed until finger leaves the panel.

## Option

*Touchkit* provides an option for advanced Mouse Emulation setting. When the **Option** button is pressed, a setting property sheet will pop up. **Support Constant Touch** and **Support Auto Right Button** check boxes are shown in the property sheet to enable/disable constant touch and Auto right button support.

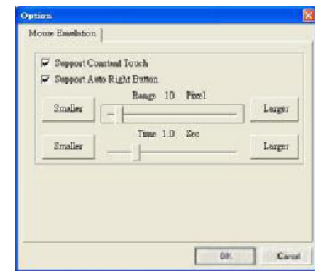

## Constant Touch

Enable **Constant Touch** to force driver to stop reporting touch points when movement is slight. You will see a stabilized cursor instead of a chattering cursor when users touch the same point. Eliminates unwanted noise.

## Auto Right Button

Enable **Auto Right Button** to force driver to report a **right click mouse event** to OS when users lift up from a **constant touch**. You no longer need to touch the **right button** in the touchtray to activate a right click. This makes it easier to right click.

## Cursor Visibility

Cursor visibility function allows the cursor to be hidden.

Go to **Start / Control Panel / Mouse / Pointers / Scheme**, and choose **TouchKit Hide Cursor**. Press **[Apply]** to make the setting change, and press **[OK]** to escape the property page.

## Double Click Adjustment

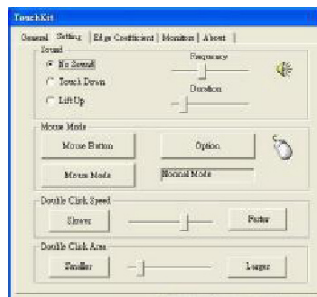

### Double Click Speed

Double Click Speed is the double click response time for the Windows system. Users can adjust the speed for easy double click by touch panel.

### Double Click Area

Each individual touch has its own touch tolerance. If the Double Click Area is set to <Smaller>, the panel will be very sensitive about micro-movements when you want to fix on a point. If set to <Larger>, larger touch point movement is tolerated when you want to point at a fixed position.

### 3. EDGE COEFFICIENT: Edge compensation for Top, Bottom, Left, Right, X Axis and Y Axis

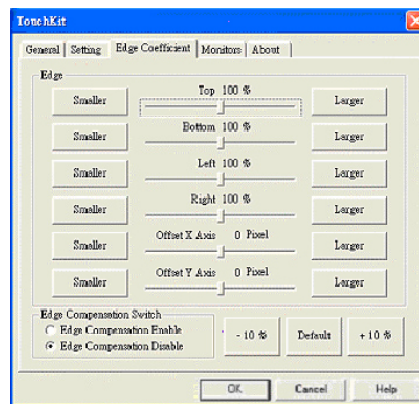

If it is difficult to touch items at the edges of the touch panel, you can adjust the edges of the screen image.

#### Top

If you set the Edge to <Smaller>, TouchKit will reduce the horizontal position of the top edge. If you set the Edge to <Larger>, TouchKit will extend the horizontal position of the top edge.

#### Bottom

If you set the Edge to <Smaller>, TouchKit will reduce the horizontal position of the bottom edge. If you set the Edge to <Larger>, TouchKit will extend the horizontal position of the bottom edge.

#### Left

If you set the Edge to <Smaller>, TouchKit will reduce the vertical position of the left edge. If you set the Edge to <Larger>, TouchKit will extend the vertical position of the left edge.

#### Right

If you set the Edge to <Smaller>, TouchKit will reduce the vertical position of the right edge. If you set the Edge to <Larger>, TouchKit will extend the vertical position of the right edge.

In some cases, the cursor will be behind the finger when you touch the panel. If you cannot see the cursor, you can set the X Axis or Y Axis to move the cursor.

### Offset X Axis

If you set the Offset X Axis to **<Smaller>**, cursor will be moved one pixel to the left of the X Axis. If you set the Offset X Axis to **<Larger>**, cursor will be moved one pixel to the right of the X Axis.

### Offset Y Axis

If you set the Offset Y Axis to **<Smaller>**, cursor will be moved one pixel above the Y Axis. If you set the Offset Y Axis to **<Larger>**, cursor will be moved one pixel below the Y Axis.

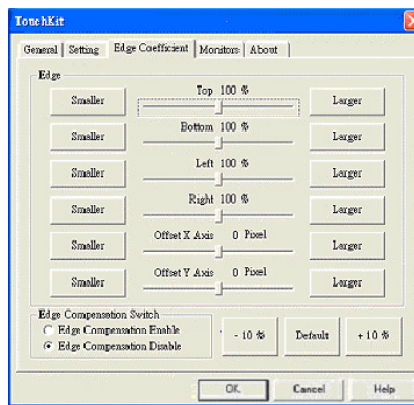

### Edge Compensation Switch

Use the **+10%** and **-10%** button to adjust. If you press the **+10%** button, the top, bottom, left and right edges will extend 10%, and the cursor will be moved 10 pixels from the X and Y Axis to the right and top. If you press the **-10%** button, the top, bottom, left and right edges will contract 10%, and cursor will be moved 10 pixels from the X and Y Axis to the left and bottom.

Choose the **Default** button to restore the default settings.

## 4. MONITORS: Multiple Monitors, Split Monitor

### Multiple Monitors

To configure the mapping relationship between the monitors and the touch panels, select the monitor page as below.

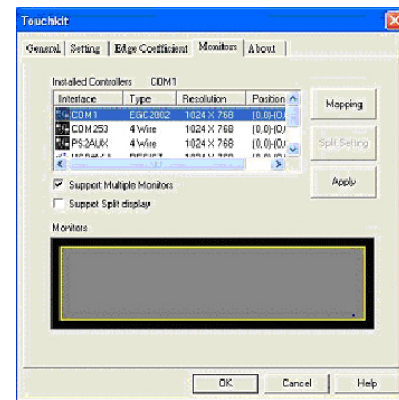

Set the check box (Use Multiple Monitors) to enable multiple monitors mapping. Unchecking this box will disable multiple-monitor configuration, and all of the touch panel controllers will be mapped to the primary monitor. The gray shadow area is the monitor mapped to the selected controller/panel. The button **[Mapping]** is used to find the mapping relationships between the monitors and touch panel controllers. Press **[Mapping]** and the software will guide you to touch the corresponding monitor to obtain the mapping relationship.



After completing monitor mapping, Press **[Apply]** to apply the mapping relationship.

### Split Monitors

To use the Split Monitor function, you need to select which controller you want to launch this function, then check the Multiple Monitors box and Split Monitor at the same time as shown below. Press the **[Split Monitor]** button to set up the active area.

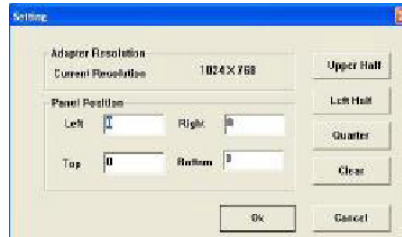

It shows the current resolution of the display and you can set the active area by inputting the value or use the default button **[Upper Half]**, **[Left Half]** or **[Quarter]**. The default value of panel resolution should be full screen as Left: **0**, Right: **0**, Top: **0** and Bottom: **0**.

5. **ABOUT**: General information about TouchKit.

### Uninstalling TouchKit

To uninstall, use the TouchKit/Uninstall from the Programs menu on the Start button.

**Declaration of the Manufacturer**

We hereby certify that the  
TR-5001 is in compliance with

**UL  
cUL  
TUV  
FCC  
CE**

TRANSDUCTION  
5155 Spectrum Way Bldg 23  
Mississauga, ON  
L4W 5A1  
Canada  
905-625-1907

[www.transduction.com](http://www.transduction.com)





# 2

---

## TR-979 SBC Introduction

This chapter provides information on the TR-5001 single board computer, TR-979 . The topics covered are:

Checklist .....	14
Description .....	14-15
Features .....	16
Specifications .....	17-20

## Checklist

Please check that your package is complete and contains the items below. If you discover damaged or missing items, please contact your dealer.

- ✓ The TR-979 Industrial SBC Card
- ✓ 1 ATA100 IDE Ribbon Cable
- ✓ 1 Floppy Ribbon Cable
- ✓ 1 Serial Port Ribbon Cable and 1 Parallel Port attached to a Mounting Bracket
- ✓ 1 Serial Port Ribbon Cable attached to a Mounting Bracket
- ✓ 1 Serial ATA cable
- ✓ 1 CD Disc Containing 865G VGA Drivers, Intel 82547 and 82541 LAN Driver, Intel chipset drivers, BIOS Update Utility and this User's manual.
- ✓ PS/2 Keyboard and Mouse 1-to-2 Y-cable
- ✓ PS/2 to AT Keyboard Cable

## Description

The TR-979 is a Pentium 4 Industrial single board computer (SBC) card based on Intel 865G chipset and is designed for harsh industrial environment. It features one 478-pins Socket, which is compatible with Intel uFC-PGA package Pentium 4 processor. This card accommodates up to 2GB of DDR400 SDRAM memory.

The TR-979 is a high integration design. Two Intel Gigabit Ethernet Controllers, RealTek Audio Codec and Chrontel LVDS Encoder are integrated into the system. The high-integration design prevents the system compatibility issues and increases the PCI add-on cards scalability. This makes TR-979 an ideal SBC card for CTI, ISP servers, workstations, automation as well as other industrial applications.

TR-979 provides the most complete features needed for system operation. These include Two Gigabits LAN, Audio, LVDS Encoder, Dual channel UDMA100 IDE drive controller, Dual

SATA-150 ports with RAID 0 and 1 support, high performance serial ports, enhanced parallel port, and the most updated BIOS. Four USB 2.0 ports and a programmable watchdog timer are available on-board. What's more, the Intel 865G on-board incorporates the latest microprocessor technology to provide the increased bandwidth needed to operate your system bus at speeds up to 800MHz FSB.

TR-979 comes with integrated hardware monitoring device that monitors system and CPU temperature, voltages of all system power rails, and CPU fan speeds to prevent system crashes by warning the user of adverted conditions. The power management feature provides power savings by slowing down the CPU clock, turning off the monitor screen and stopping the HDD spindle motor.

## Features

- Support Pentium 4 Prescott (90nm) and Northwood(0.13um) CPU with 400/533/800M FSB speed selectable. Intel VRD 10.1 compliant to support future advanced processor.
- Dual Channel Memory bus doubles the data rate, up to 6.4GBytes/s. System memory speed can be DDR266,330 or 400, selectable by BIOS setup.
- Dual SATA ports with classic IDE, RAID0 or RAID 1 mode configurable. Rebuild supported at RAID 1 mode with Intel IAA software.
- Dual Intel Gigabit Ethernet controller on board boost networking throughputs up to 4Gbits/s in full-duplex mode.
- Support Server-grade LAN features like Teaming, Load-balancing and Fault-Tolerance in wire-speed.
- Boot Agent with both RPL and PXE protocol support is integrated in system BIOS for remote Boot functions.
- LAN LED built-in RJ45 connector to display Speed, Link activities. External connector is available to display LAN status on front Panel.
- Two serial ports. One is RS232/422/485 selectable for remote control and data access.
- AC97 3D Audio CODEC on-board with Line-IN, Line-OUT, Microphone and CD-IN interface. Audio + USB 2.0 cable kit is available.
- One LVDS connector supports diffused LVDS TFT 18-bits panels. LVDS cable kit is available.
- On-Board AT-P8 and ATX-12V Power connector support stand-alone system configuration.
- Four USB2.0 ports. USB2.0 cable kit is available to mount UBS connector on chassis or bracket.
- Support Hardware Monitor and Watch-Dog timers. System will alert administrators while abnormal operation condition happened.
- Support remote wake up on LAN and Modem.

## Specifications

- Processor Socket 478 supports Intel® Pentium® 4 series processors:
  - Intel® Celeron® based on 0.13  $\mu$  core, 400MHz FSB, up to 2.80GHz
  - Intel® Pentium® 4 based on 0.13  $\mu$  core, 512KB L2, 533MHz FSB, without HT Technology, up to 2.80 GHz
  - Intel® Pentium® 4 based on 0.13  $\mu$  core, 512KB L2, 533MHz FSB, with HT Technology, up to 3.06 GHz
  - Intel® Pentium® 4 based on 0.13  $\mu$  core, 512KB L2, 800MHz FSB, with HT Technology, up to 3.20 GHz
  - Intel® Pentium® 4 based on 90nm core, 1MB L2, 533MHz FSB, with HT Technology, up to 2.80 GHz
  - Intel® Pentium® 4 based on 90nm core, 1MB L2, 800MHz FSB, with HT Technology, up to 3.4 GHz
  
- **System Memory:**
  - Two DDR DIMM Sockets support DDR 266/333/400 unregistered non-ECC Memory up to 2.0 GB.
  - Support Dual-Channel Turbo Mode while identical DIMM modules are installed.
  
- **Video Controller:**
  - 865G Integrated Intel Extreme Graphic Engine with 266MHz Core Frequency.
  - VGA/UMA shares System Memory as frame buffer. Buffer Size can be configured through BIOS setup.
  - High Performance and High Quality 3D graphic rendering Engine.
  - Video DVD and PC-VCR support.
  - One 15-pins D-type connector on bracket for CRT display.
  - One 20-pins 2mm pin-header for LVDS interface LCD panel
  - VBIOS support diffused 18/24/48-bits TFT LCD. Panel type selectable through BIOS setup.
  - Dual Display to both CRT and TFT-Panel.

- **PIDE and SATA:**
  - Two Enhanced PIDE interfaces for up to four devices, support PIO Mode 3/4 or Ultra ATA33/66 /100 IDE Hard Disk, ATAPI CD-ROM and LS-120 drive.
  - Two SATA connectors support up to two SATA-150 HDDs.
  - Two SATA ports can be configured as RAID-0 and RAID-1 with RAID BIOS and Intel IAA drivers.
  - SATA RAID BIOS is integrated in System BIOS.

**FDD Interface:**

- ◆ Two floppy drives (360KB, 720KB, 1.2MB, 1.44MB, 2.88MB)

- **Super I/O:**

- **Parallel Port:** One high-speed parallel port with SPP/EPP/ECP mode support.
- **Serial Port:** Two 16550 UART compatible ports. COM2 can be configured as RS232 as well as RS422/RS485 interface.
- **IrDA Interface:** Pin-header connector for the optional IrDA external connector

- **Gigabit Ethernet:**

- Intel 82547GI and 82541GI Gigabit Ethernet controller on-boards.
- Two LED to display the Speed, Link and Activity.  
LINK/ACT → GREEN ON: LINK  
Blinking: Activity.  
SPEED → ORANGE: 1000M bps  
Green: 100M bps  
Off: 10M bps
- Support Teaming, load balancing and fault-tolerance with Intel Bay-City 3.0 drivers.
- Support Wake-on-LAN while ATX power supply is attached.

- **CMOS:**

- On-board RTC with 242 bytes of Battery-back CMOS RAM.
- One 3-pins Jumper to clear CMOS data.

- **Audio:**
  - RealTek ALC201A AC97 Audio chip on-board.
  - One 10-pins pin-header for Audio Line-IN, Line-OUT and MIC cabling.
  - One CD-ROM Audio-In 4-pins connector on-board.
  
- **BIOS:**
  - Phoenix-Award Standard PnP BIOS 6.2.
  
  - 4Mbit FlashROM with BootBlock for Fail-safe.
  - Enhanced ACPI and DMI2.0 compliant.
  - BIOS utility for field update.
  - VBIOS and LAN remote Boot Agent integrated.
  - 32-pins PLCC type socket for easy field replacement.
  
- **ISA and PCI Expansion Slot:**
  - Full-Size PICMG 2.0 Compliant form-factor with ISA and 32-bits PCI golden-edge.
  
- **Power Connector:**
  - One ATX12V 2x2 connector on-board to support CPU Vcore power.
  - One AT P8 6-pins connector on-board to support without Backplane operation.
  - One 4-pins ATX STBPWR connector on board to supply 5V Standby power and support Power-button operation when use ATX PSU.
  
- **Cooling:**
  - One CPU cooling FAN connector near by CPU socket.
  - One System cooling FAN connector on board.
  - CPU heatsink retention module with metal plat on the backside of CPU socket.
  
- **USB Interface:**
  - Four USB pin-header connectors, compliant with USB Specification Rev. 2.0 and support USB Hot-Plug function.
  - Support Legacy Usb devices and Boot from USB devices like USB-HDD, USB-Floppy and USB-CDROM.

- **ATX Power Supply support:**
  - On-board 4-pin ATX power supply header (requires the passive backplane supports ATX power supply)
  - On-board power button header for Soft power off, i.e. front panel turn off system power.
  - Support Windows2K/XP shutdown automatically turn off the system power.
  - Instant-off or delay-4-seconds selectable via BIOS setup.
  
- **Hardware Monitor System:**
  - PC Health Monitoring ASIC supports system power voltages, FAN speed and system temperatures monitoring.
  - One FAN connector and one thermal couple header reserved for chassis FAN and temperature monitoring.
  
- **Watchdog Timer:**
  - Read I/O port 0843H to enable watchdog.
  - Read I/O port 043H to disable watchdog.
  - 10s, 20s, 30s and 80s timeout period selectable.
  
- **Keyboard and Mouse Connectors:** One 6-pin mini-DIN connector is located on the mounting bracket for easy connection to a keyboard and PS/2 mouse. A 5-pin on-board keyboard pin header connector is also available to support PC/AT style external keyboard connector on backplane.
  
- **PICMG Compliance:** Fully compliant to PICMG 2.0 standards.
  
- **Environmental and Mechanical:**
  - **Power Supply:** 12A@ +5v typical; 300mA@ +12v typical  
100mA@ -12V typical; 200mA@ +5VSTB (Option)
  - **Temperature:** 0°C to 60°C operating; -40°C to 70°C storage
  - **Humidity:** 5% to 95%
  - **Dimensions:** 13.3"(L) x 4.8"(W) or  
338mm (L) x 124mm (W)



# 3

---

## Installations

This chapter provides information on how to use the jumpers and connectors on the TR-979 in order to set up a workable system. The topics covered are:

CPU Installation .....	22
Memory Installation .....	23
Jumpers on the TR-979.....	24-29
Connectors on the TR-979.....	30-45
Watchdog Timer Configuration .....	46

## CPU Installation

The TR-979 Industrial SBC Card provides a 478-pins ZIF socket for Pentium 4 processors with FC-PAG2 package.

To Install a CPU, first turn off your system and remove its cover. Locate the ZIP socket and open it by first pulling the lever sideways away from the socket then upwards to a 90-degree right angle. Insert the CPU with the correct orientation. Use the notched corner of the CPU with the white dot as your guide. The white dot should point towards the end of the lever. Notice that there is a blank area where one hole is missing from that corner of the square array of pin holds. Because the CPU has a corner pin for three of the four corners, the CPU will only fit in one orientation. With the added weight of the CPU fan, no force is required to insert the CPU. Once completely inserted, hold down on the fan and close the socket lever.

To disassembly the processor, simply pull the lever sideways away from the socket then upward to a 90-degree right angle. You can take the CPU out from the socket without help of any tool.

After installing the processor into the Socket, ensure that the CPU fan is installed first. Without a fan circulating air on the CPU, the CPU can overheat and cause damage to both CPU and SBC card.

**WARNING!:** If no FAN circulating Air on the CPU, the processor might be overheated and damage both CPU and SBC components.

**IMPORTANT:** You must set jumpers for “CPU FSB speed” depending on the CPU that you install.

## Memory Installation

The TR-979 Industrial CPU Card provides two 184-pin DIMM sockets for a maximum total memory of 2GB SDRAM. The memory modules can come in sizes of 128MB, 256MB, 512MB and 1GB SDRAM.

The TR-979 Industrial CPU Card supports two 184-pin DIMM (Dual In-line Memory Module) sockets. In populating the DIMM sockets, DIMM1 bank should be populated first for less signal reflection. However, we do not see any issue while populate DIMM2 only. Refer to the following table on how to configure the memory.

**NOTE:** Use SDRAM modules with PC2100 specification when running DDR266 Memory bus speed. With DDR200 Memory bus speed, SDRAM modules meet PC1600 or PC2100 specification can be used.

### 184-pin DIMM (2.5V) Unregistered SDRAM

Bank0 (DIMM1)	Bank1 (DIMM2)	Total Memory
128MB	-----	128MB
256MB	-----	256MB
512MB	-----	512MB
1GB	-----	1GB
128MB	128MB	256MB
128MB	256MB	384MB
128MB	512MB	640MB
256MB	128MB	384MB
256MB	256MB	512MB
256MB	512MB	768MB
256MB	1GB	1280MB
512MB	128MB	640MB
512MB	256MB	768MB
512MB	512MB	1GB
512MB	1GB	1536MB
1GB	1GB	2GB

## Jumpers on the TR-979

The jumpers on the TR-979 allow you to configure your SBC card according to the needs of your applications. If you have doubts about the best jumper configuration for your needs, contact your dealer or sales representative. The following picture below shows the jumpers on TR-979 and their respective functions.

## Jumper Locations on the TR-979

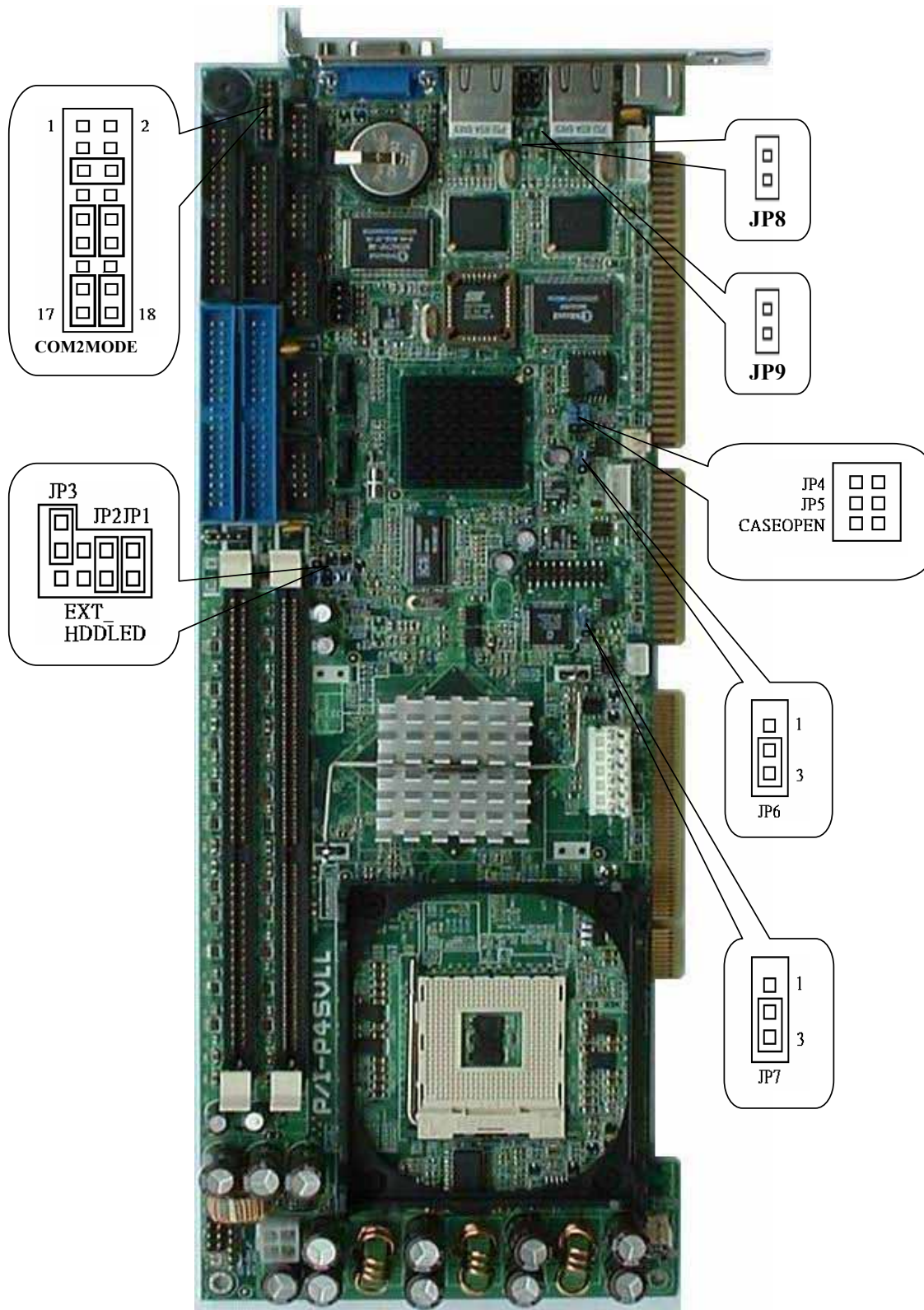

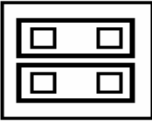
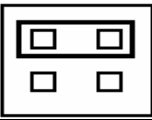
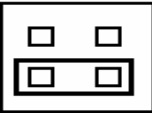

## JP1 ~ 2: CPU Frequency Selector

JP1 and JP2 allow users to select the CPU FSB speed. It can be 400MT/s, 533MT/s or 800MT/s. User should select the correct FSB speed to make their CPU run on correct speed and ensure the system runs stably.

JP1~JP2	Setting	Function
 JP2 JP1	JP2: Pin 1-2 Short JP1: Pin 1-2 Short	400MT/s CPU FSB
 JP2 JP1	JP2: Pin 1-2 Short JP1: Pin 1-2 Open	533MT/s CPU FSB
 JP2 JP1	JP2: Pin 1-2 Open JP1: Pin 1-2 Short	800MT/s CPU FSB

## JP3: CMOS RAM Data

This 3-pin Jumper allows the user to disconnect the built-in 3V battery power to clear the information stored in the CMOS RAM. To clear the CMOS data: (1) Turn off the system power, (2) Remove Jumper cap from pin1&2, (3) Short the pin2 and pin3 for three seconds, (4) Put Jumper cap back to pin1 & 2. (5) Turn on your computer, (6) Hold Down <Delete> during bootup and enter BIOS setup to enter your preferences.

JP3	Setting	Function
 1	Pin 1-2 Short/Closed	Normal Operation (default)
 1	Pin 2-3 Short/Closed	Clear CMOS Content

## JP4 ,JP5: WatchDog Timer Period Selection

The WatchDog Timer time-out period can be set as 10 sec, 20 sec, 30 sec and 80 sec. The following table describes the jumper settings for the period.

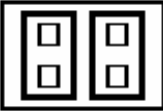
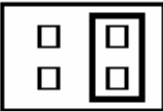
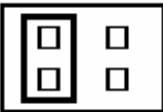
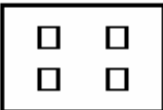

JP4 JP5	Time-out Period
 JP5 JP4	10 Sec
 JP5 JP4	20 Sec
 JP5 JP4	30 Sec
 JP5 JP4	80 Sec

## JP6: WatchDog Timer Mode Selection

The WatchDog Timer is enabled by reading I/O port 843H. It should be triggered before the Watch-Dog Timer time-out period ends, otherwise the Watch-Dog Timer assumes the program operation is abnormal and will issue either a reset signal to re-boot system again, or activate NMI (By pull-low IOCHK#) to the CPU.

The WatchDog Timer can be disabled by reading I/O port 043H.

The JP8 jumper is used to select time-out signal. It can be RESET to re-boot system, NMI to signal CPU or disable this function.

JP6	Setting	Function
 1	Pin 1-2 Short/Closed	NMI to signal CPU
 1	Pin 2-3 Short/Closed	RESET to re-boot system

### **JP7: LCD PANEL Power Selection**

---

JP7 can be used to select the Panel LCD supply power: +3.3V or +5V. The default setting is on +3.3V. User need to check the LCD panel spec and adjust this jumper and make Panel work in specified power rail.

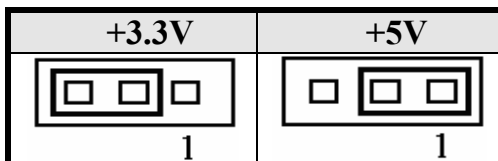

### **JP8~ 9: On-Board LAN Enable/Disable selection**

---

On-Board Fast Ethernet LAN chips can be disabled by shorting the JP8 or/and JP9 jumper.

Port #	Enable	Disable
PORT 1	 JP8	 JP8
PORT 2	 JP9	 JP9



## COM2MODE: COM2 RS232/RS422/RS485 Selection

---

COM2MODE		I/F TYPE
17	1	RS-232
18	2	RS-422
17	1	
18	2	RS-485
17	1	
18	2	

## Connectors on the TR-979

The connectors on the TR-979 allows you to connect external devices such as keyboard, floppy disk drives, hard disk drives, printers, etc. The following picture below lists the connectors on TR-979.

## Connector Locations on the TR-979

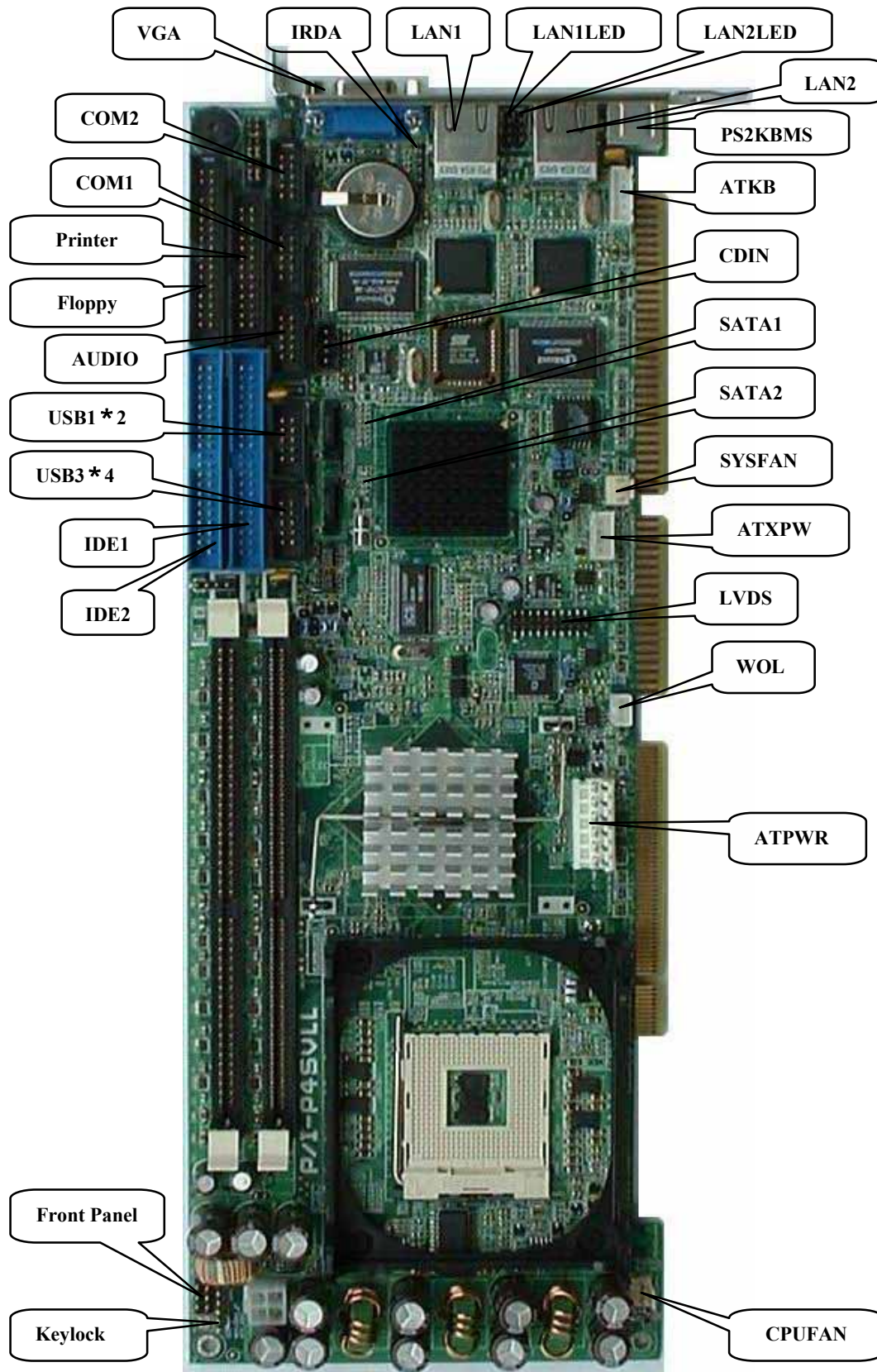

## Front Panel Connector

The front panel of the case has a control panel, which provides light indication of the computer activities and switches to change the computer status.

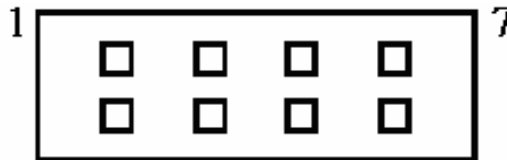

**RESET PWR HDD PWR**  
**LED LED BTN**

### ➤ RESET Switch

The reset switch allows the user to reset the system without turning the main power switch Off and then On. Orientation is not required when making a connection to this header.

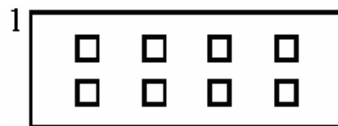

Reset

RESET Pin #	Signal Name
1	Reset
2	Ground

### ➤ Power-On LED

This connector allows users to connect to Front Panel Power indicator.

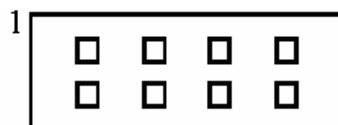

PWR  
LED

IDE LED Pin #	Signal Name
3	+5V
4	Ground

➤ **IDE Hard Disk LED Connector**

This connector connects to the hard drive activity LED on control panel. This LED will flash when the HDD is being accessed.

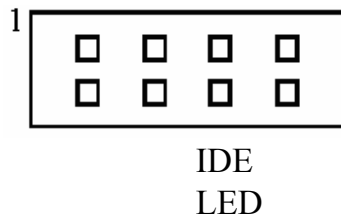

IDE LED Pin #	Signal Name
5	IDE ACT
6	Ground

➤ **ATX Power ON/OFF Button**

This 2-pin connector acts as the “Power Supply On/Off Switch” on the SBC card. When pressed, the switch will force the SBC card to power on. When pressed again, it will force the SBC card to power off.

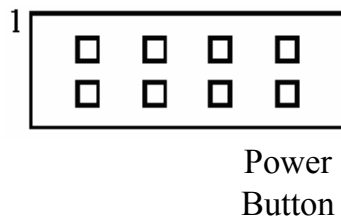

PWR BTN Pin #	Signal Name
7	PWR-BTN
8	GND

**Keylock and Power-ON LED Connector**

The Power LED provide a interface to wire the system power on signal to front panel. The keylock switch, when closed, will disable the keyboard function.



Power LED Pin #	Signal Name
1	Power on
2	NC
3	Ground
4	Keylock
5	Ground

## EIDE Connectors

### Primary IDE Connector

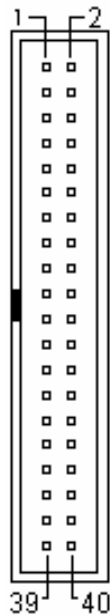

Signal Name	Pin #	Pin #	Signal Name
Reset IDE	1	2	Ground
Host data 7	3	4	Host data 8
Host data 6	5	6	Host data 9
Host data 5	7	8	Host data 10
Host data 4	9	10	Host data 11
Host data 3	11	12	Host data 12
Host data 2	13	14	Host data 13
Host data 1	15	16	Host data 14
Host data 0	17	18	Host data 15
Ground	19	20	Key
DRQ0	21	22	Ground
Host IOW	23	24	Ground
Host IOR	25	26	Ground
IOCHRDY	27	28	Host ALE
DACK0	29	30	Ground
IRQ14	31	32	No connect
Address 1	33	34	No connect
Address 0	35	36	Address 2
Chip select 0	37	38	Chip select 1
Activity	39	40	Ground

## Secondary IDE Connector

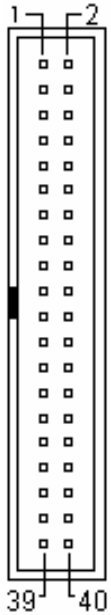

Signal Name	Pin #	Pin #	Signal Name
Reset IDE	1	2	Ground
Host data 7	3	4	Host data 8
Host data 6	5	6	Host data 9
Host data 5	7	8	Host data 10
Host data 4	9	10	Host data 11
Host data 3	11	12	Host data 12
Host data 2	13	14	Host data 13
Host data 1	15	16	Host data 14
Host data 0	17	18	Host data 15
Ground	19	20	Key
DRQ1	21	22	Ground
Host IOW	23	24	Ground
Host IOR	25	26	Ground
IOCHRDY	27	28	Host ALE
DACK1	29	30	Ground
IRQ15	31	32	No connect
Address 1	33	34	No connect
Address 0	35	36	Address 2
Chip select 0	37	38	Chip select 1
Activity	39	40	Ground

## Floppy Drive Connector

Floppy connector is a 34-pin header and will support up to 2.88MB floppy drives.

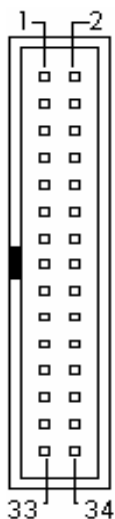

Signal Name	Pin #	Pin #	Signal Name
Ground	1	2	RM/LC
Ground	3	4	No connect
Ground	5	6	No connect
Ground	7	8	Index
Ground	9	10	Motor enable 0
Ground	11	12	Drive select 1
Ground	13	14	Drive select 0
Ground	15	16	Motor enable 1
Ground	17	18	Direction
Ground	19	20	Step
Ground	21	22	Write data
Ground	23	24	Write gate
Ground	25	26	Track 00
Ground	27	28	Write protect
Ground	29	30	Read data
Ground	31	32	Side 1 select
Ground	33	34	Diskette change



## Parallel Port Connector

The following table describes the pin out assignments of this connector.

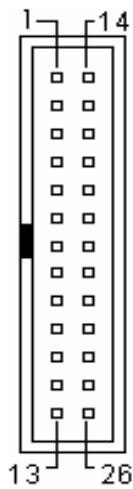

Signal Name	Pin #	Pin #	Signal Name
Line printer strobe	1	14	AutoFeed
PD0, parallel data 0	2	15	Error
PD1, parallel data 1	3	16	Initialize
PD2, parallel data 2	4	17	Select
PD3, parallel data 3	5	18	Ground
PD4, parallel data 4	6	19	Ground
PD5, parallel data 5	7	20	Ground
PD6, parallel data 6	8	21	Ground
PD7, parallel data 7	9	22	Ground
ACK, acknowledge	10	23	Ground
Busy	11	24	Ground
Paper empty	12	25	Ground
Select	13	N/A	N/A

## COM1 Serial Port

COM1, a 10-pin header connector, is the onboard COM1 serial port of the TR-979. The following table shows its pin assignments.

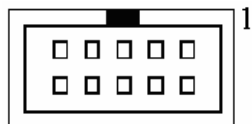

Pin #	Signal Name
1	DCD, Data carrier detect
2	RXD, Receive data
3	TXD, Transmit data
4	DTR, Data terminal ready
5	GND, ground
6	DSR, Data set ready
7	RTS, Request to send
8	CTS, Clear to send
9	RI, Ring indicator
10	N.C.

## COM2 Serial Port

COM2, a 10-pin header connector, is the onboard COM2 serial port of the TR-979. The following table shows its pin assignments while it is configured as RS-232, RS-422 or RS-485 interface.

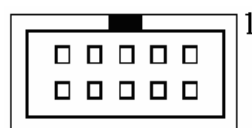

Pin #	RS232 Mode Signal Name	RS422/RS485 Mode Signal Name
1	DCD, Data carrier detect	TX- (422/485)
2	RXD, Receive data	TX+ (422/485)
3	TXD, Transmit data	RX+ (422)
4	DTR, Data terminal ready	RX- (422)
5	GND, ground	GND
6	DSR, Data set ready	N.C.
7	RTS, Request to send	N.C.
8	CTS, Clear to send	N.C.
9	RI, Ring indicator	N.C.
10	N.C.	N.C.

## External Keyboard Connector

---

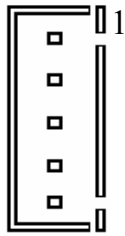

Pin #	Signal Name
1	Keyboard clock
2	Keyboard data
3	PG
4	GND
5	+5V

## PS/2 Keyboard & Mouse Connector

---

The following table describes the pin assignment of PS/2 Keyboard and Mouse connector, which is mount on button of bracket. To attach PS/2 Keyboard and mouse, users need to connect trough a PS/2 1-to-2 Y-cable and plug into this Mini-Din connector. All the TR-979 SBC boards come with a Y-cable. Contact your dealer if the Y-cable is missing.

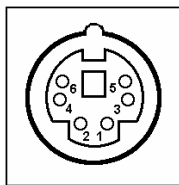

Pin #	Signal Name
1	Keyboard data
2	Mouse data
3	GND
4	5V
5	Keyboard clock
6	Mouse clock

## VGA Connector

The pin assignments of VGA CRT connector are as follows:

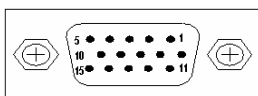

Signal Name	Pin	Pin	Signal Name
Red	1	2	Green
Blue	3	4	N.C.
GND	5	6	GND
GND	7	8	GND
N.C.	9	10	GND
N.C.	11	12	N.C.
HSYNC	13	14	VSYNC
NC	15		

## CPU Fan Power Connector

This is a 3-pin header for the CPU fan. The fan must be a 12V fan.

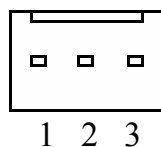

Pin #	Signal Name
1	Rotation
2	+12V
3	Ground

## USB Connectors

The following table shows the pin outs of the USB connectors.

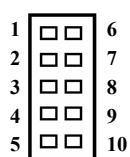

USB1 Pin#	USB0 Pin #	Signal Name
10	1	+5V
9	2	USB-
8	3	USB+
7	4	Ground
6	5	N.C.

## IrDA Connector

This connector is used for an IrDA connector for wireless communication.

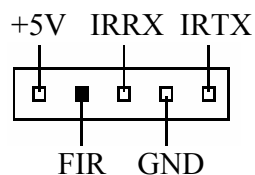

IrDA Pin #	Signal Name
1	+5V
2	FIR
3	Ir RX
4	Ground
5	Ir TX

## ATX Power Connector

This is a four-pin connector to support the ATX power and corresponding back-plane. When your back-plane is configured to perform ATX power supply Soft-on/off function, you have to connect the control signals and stand-by power on this connector to your back-plane by a corresponding cable.

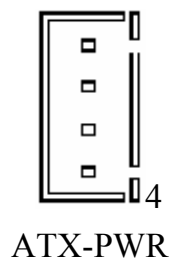

Pin #	Signal Name
1	PWR_GD
2	5V_SB (standby +5V)
3	PS-ON (soft on/off)
4	GND

## Chassis Fan Power Connector

This is a 3-pin header for the chassis fan. The fan must be a 12V fan.

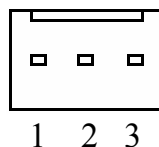

Pin #	Signal Name
1	Rotation
2	+12V
3	Ground

## LAN- RJ45 Connector

This connector is for the 10/100Mbps Ethernet capability of the CPU card. The figure below shows the pin out assignments of this connector and its corresponding input jack.

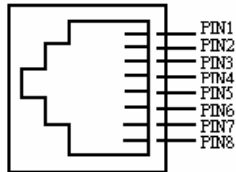

Pin #	Signal Name
1	MDI0+
2	MDI0-
3	MDI1+
4	MDI1-
5	MDI2+
6	MDI2-
7	MDI3+
8	MDI3-

## LAN LEDs

The LAN LEDs on top of RJ45 are to display the current network connection status. The green color LED on the right-hand side shows the link status and TX/RX activity. The Yellow/Green Dual color LED on the left-hand side indicates the operation mode, i.e. 10Base-T, 100Base-T or 1000Base-T.

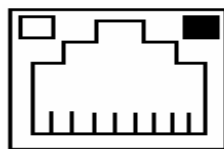

LNK/ACT	STATUS
ON	Link
OFF	Disconnected
FLASH	Packets TX/RX

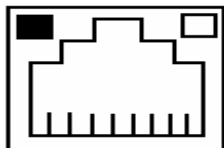

SPEED	MODE
Orange	1000 Mbps
Green	100 Mbps
OFF	10 Mbps

## LANLED Connectors

The 4-pins LANLED connector designed for each LAN port is for applications need to display LAN port status on front panel or the places administrators are easy to access.



LAN LED Pin #	Signal Name
1	ACTLED-
2	LINKLED-
3	ORGLED-
4	GRNLED-

## AT Power P8 Connector

The following table describes the pin assignment of on-board AT Power P8 connector. This connector is for the applications which do not require a backplane. Users can connect it to an AT SPS P8 connector to supply the system power. The Power good signal will be generated by the circuit on the SBC card. Pin 1 is replace with +5V power to increase supply current.



Pin #	Signal Name
1	+5V
2	+5V
3	+12V
4	-12V
5	GND
6	GND

## CD\_IN Connectors

---

CD\_IN connector is designed for wire the CD\_ROM audio signals to the on-board Audio CODEC.

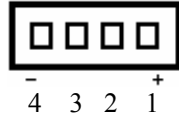

LAN LED Pin #	Signal Name
1	CD_Left
2	CD_AGND
3	CD_AGND
4	CD_Right

## Audio Connectors

---

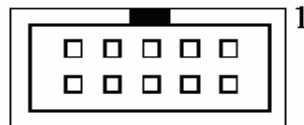

LAN LED Pin #	Signal Name
1	Jack Detect
2	+5V
3	Vreference
4	MIC-IN
5	AGND
6	AGND
7	LINE-OUT-L
8	LINE-IN-L
9	LINE-OUT-R
10	LINE-IN-R



## LCD LVDS Connector

LCD LVDS connector is designed for wiring the LVDS signals to the LCD Panel.



Signal Name	Pin #	Pin #	Signal Name
TX0+	1	2	TX0-
GND	3	4	GND
TX1+	5	6	TX1-
TX2+	7	8	TX2-
GND	9	10	GND
TX3+	11	12	TX3-
GND	13	14	GND
TXC+	15	16	TXC-
LCD VCC	17	18	LCD VCC
12V	19	20	12V

Note: Contact your dealer for LCD Cable kit and Video BIOS customization.

## WOL Connectors



3 2 1

Pin #	Signal Name
1	5VSB
2	GND
3	PME-

## SATA Connectors

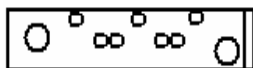

7 1

Pin #	Signal Name
1	GND
2	SATARX+
3	SATARX-
4	GND
5	SATATX-
6	SATATX+
7	GND

## Watchdog Timer Configuration

The function of the watchdog timer is to reset the system automatically and is defined at I/O port 0843H. To enable the watchdog timer and allow the system to reset, read I/O port 0443H. To disable the timer, read I/O port 043H for the system to stop the watchdog function. The timer has a tolerance of 20% for its intervals.

The following describes how the timer should be programmed.

### **Enabling Watchdog**

```
MOV  DX, 0843H  
IN   DX, AX
```

### **Disabling Watchdog**

```
MOV  DX, 043H  
OUT  DX, AX
```

# 4

---

## BIOS Configuration

This chapter describes the different settings available in the Award BIOS that comes with the TR-979 CPU card. The topics covered in this chapter are as follows:

BIOS Introduction .....	48-50
Main Menu .....	51-52
Standard CMOS Setup .....	53-57
Advanced BIOS Features .....	58-63
Advanced Chipset Features .....	64-67
Integrated Peripherals.....	68-74
Power Management Setup.....	75-78
PnP/PCI Configurations .....	79-81
PC Health Status.....	82-83
Frequency/Voltage Control .....	84
Load Fail-Safe Defaults.....	85
Load Optimized Defaults .....	85
Supervisor/User Password Setting .....	86
Exit Selecting .....	87

## BIOS Introduction

This Chapter discusses Award™ Setup program built into the TR-979 BIOS. The Setup program allows users to modify the basic system configuration. This special information is then stored in battery-backed RAM so that it retains the Setup information when the power is turned off.

The AwardBIOS™ installed in TR-979 SBC is a custom version of an industry standard BIOS. This means that it supports Intel PentiumIV in a standard IBM-AT compatible input/output system. The BIOS provides critical low-level support for standard devices such as disk drives and serial and parallel ports.

It also adds non-standard, features such as virus and password protection as well as special support for detailed fine-tuning of the chipset controlling the entire system.

The rest of this chapter is intended to guide you through the process of configuring your system using Setup.

### Starting Setup

---

The AwardBIOS™ is immediately activated when you first power on the computer. The BIOS reads the system information contained in the CMOS and begins the process of checking out the system and configuring it. When it finishes, the BIOS will seek an operating system on one of the disks and then launch and turn control over to the operating system.

While the BIOS is in control, the Setup program can be activated in one of two ways:

1. By pressing <Del> immediately after switching the system on, or
2. by pressing the <Del> key when the following message appears briefly at the bottom of the screen during the POST (Power On Self-Test).

#### **Press DEL to enter SETUP.**

If the message disappears before you respond and you still wish to enter Setup, restart the system to try again by turning it OFF then ON or pressing the "RESET" button on the system case. You may also restart by simultaneously pressing <Ctrl>, <Alt>, and <Delete> keys. If you

do not press the keys at the correct time and the system does not boot, an error message will be displayed and you will again be asked to...

## **PRESS F1 TO CONTINUE, DEL TO ENTER SETUP**

### **Using Setup**

---

In general, you use the arrow keys to highlight items, press <Enter> to select, use the PageUp and PageDown keys to change entries, press <F1> for help and press <Esc> to quit. The following table provides more detail about how to navigate in the Setup program using the keyboard.

Key	Function
Up Arrow	Move to the previous item
Down Arrow	Move to the next item
Left Arrow	Move to the item on the left (menu bar)
Right Arrow	Move to the item on the right (menu bar)
Esc	Main Menu: Quit without saving changes Submenus: Exit Current page to the next higher level menu
Move Enter	Move to the item you desired
PgUp key	Increase the numeric value or make changes
PgDn key	Decrease the numeric value or make changes
+ key	Increase the numeric value or make changes
- key	Decrease the numeric value or make changes
Esc key	Main Menu -- Quit and not save changes into CMOS Status Page Setup Menu and Option Page Setup Menu -- Exit current page and return to Main Menu
F1 key	General help on Setup navigation keys
F5 key	Load previous values from CMOS
F6 key	Load the fail-safe defaults from BIOS default table
F7 key	Load the optimized defaults
F10 key	Save all the CMOS changes and exit

### **Navigating through the menu bar**

Use the left and right arrow keys to choose the menu you want to be in.

### **To display a sub menu**

Use the arrow keys to move the cursor to the sub menu you want. Then press <Enter>. A “>” pointer marks all sub menus.

## **Getting Help**

---

Press F1 to pop up a small help window that describes the appropriate keys to use and the possible selections for the highlighted item. To exit the Help Window press <Esc> or the F1 key again.

## **In Case of Problems**

---

If, after making and saving system changes with Setup, you discover that your computer no longer is able to boot, the AwardBIOS™ supports an override to the CMOS settings which resets your system to its defaults.

The best advice is to only alter settings that you thoroughly understand. To this end, we strongly recommend that you avoid making any changes to the chipset defaults. These defaults have been carefully chosen by both Award and TR-979 manufacturer to provide the absolute maximum performance and reliability. Even a seemingly small change to the chipset setup has the potential for causing you to use the override.

## Main Menu

Once you enter the AwardBIOS™ CMOS Setup Utility, the Main Menu will appear on the screen. The Main Menu allows you to select from several setup functions and two exit choices. Use the arrow keys to select among the items and press <Enter> to accept and enter the sub-menu.

### Phoenix – AwardBIOS CMOS Setup Utility

➤ Standard CMOS Features	➤ Frequency/Voltage Control
➤ Advanced BIOS Features	Load Fail-Safe Defaults
➤ Advanced Chipset Features	Load Optimized Defaults
➤ Integrated Peripherals	Set Supervisor Password
➤ Power Management Setup	Set User Password
➤ PnP/PCI Configurations	Save & Exit Setup
➤ PC Health Status	Exit Without Saving
Esc : Quit	↑ ↓ ← → : Select Item
F10 : Save & Exit Setup	
Time, Date, Hard Disk Type....	

Note that a brief description of each highlighted selection appears at the bottom of the screen.

## Setup Items

The main menu includes the following main setup categories.

### Standard CMOS Features

Use this menu for basic system configuration.

### Advanced BIOS Features

Use this menu to set the Advanced Features available on your system.

**Advanced Chipset Features**

Use this menu to change the values in the chipset registers and optimize your system's performance.

**Integrated Peripherals**

Use this menu to specify your settings for integrated peripherals.

**Power Management Setup**

Use this menu to specify your settings for power management.

**PnP / PCI Configuration**

Use this menu to set up the PnP/PCI configuration.

**PC Health Status**

Use this menu to display the CPU temperature, FAN speed and voltages.

**Frequency/Voltage Control**

Use this menu to specify your settings for frequency/voltage control.

**Load Fail-Safe Defaults**

Use this menu to load the BIOS default values for the minimal/stable performance for your system to operate.

**Load Optimized Defaults**

Use this menu to load the BIOS default values that are factory settings for optimal performance system operations. While Award has designed the custom BIOS to maximize performance, the factory has the right to change these defaults to meet their needs.

**Supervisor / User Password**

Use this menu to set User and Supervisor Passwords.

**Save & Exit Setup**

Save CMOS value changes to CMOS and exit setup.

**Exit Without Save**

Abandon all CMOS value changes and exit setup.



## Standard CMOS Setup

The items in Standard CMOS Setup Menu are divided into 10 categories. Each category includes no, one or more than one setup items. Use the arrow keys to highlight the item and then use the <PgUp> or <PgDn> keys to select the value you want in each item.

Phoenix – AwardBIOS CMOS Setup Utility		Item Help
Standard CMOS Features		
Date:	Mon, Feb 8 2004	
Time:	16 : 19 : 20	
➤ IDE Channel 0 Mast	[None]	Menu Level ➤
➤ IDE Channel 0 Slave	[None]	Change the day, month, year and century
➤ IDE Channel 1 Master	[None]	
➤ IDE Channel 1 Slave	[None]	
Drive A	[1.44M, 3.5 in.]	
Drive B	[None]	
Video	[EGA/VGA]	
Halt On	[All Errors]	
Based Memory	640K	
Extended Memory	121856K	
Total Memory	122880K	
↑↓←→Move Enter: Select +/-/PU/PD: Value F10:Save ESC: Exit F1:General Help F5:Previous Values F6:Fail-safe defaults F7:Optimized Defaults		

This table shows the selections that you can make on the Standard CMOS Menu

<b>Item</b>	<b>Options</b>	<b>Description</b>
Date	Month DD YYYY	Set the system date. Note that the 'Day' automatically changes when you set the date
Time	HH : MM : SS	Set the system time
IDE Channel 0 Master	Options are in its sub menu	Press <Enter> to enter the sub menu of detailed options
IDE Channel 0 Slave	Options are in its sub menu	Press <Enter> to enter the sub menu of detailed options
IDE Channel 1 Master	Options are in its sub menu	Press <Enter> to enter the sub menu of detailed options
IDE Channel 1 Slave	Options are in its sub menu	Press <Enter> to enter the sub menu of detailed options
Drive A Drive B	None 360K, 5.25 in 1.2M, 5.25 in 720K, 3.5 in 1.44M, 3.5 in 2.88M, 3.5 in	Select the type of floppy disk drive installed in your system
Video	EGA/VGA CGA 40 CGA 80 MONO	Select the default video device
Halt On	All Errors No Errors All, but Keyboard All, but Diskette All, but Disk/Key	Select the situation in which you want the BIOS to stop the POST process and notify you
Base Memory	N/A	Displays the amount of conventional memory detected during boot up
Extended Memory	N/A	Displays the amount of extended memory detected during boot up
Total Memory	N/A	Displays the total memory available in the system

## Channel 0 HDDs / Channel 1 HDDs

The IDE adapters control the hard disk drive. Use a separate sub menu to configure each hard disk drive. Figure 2 shows the IDE primary

Phoenix – AwardBIOS CMOS Setup Utility		Item Help
IDE Cannel 0 Master		
IDE HDD Auto-Detection	[Press Enter]	
IDE Channel 0 Master	[Auto]	Menu Level >>
Access Mode	[Auto]	To auto-detect the HDD's size, head... on this channel
Capacity	0 MB	
Cylinder	0	
Head	0	
Precomp	0	
Landing Zone	0	
Sector	0	
↑↓←→Move Enter: Select +/-/PU/PD:Value F10:Save ESC:Exit F1:General Help F5:Previous Values F6:Fail-safe defaults F7:Optimized Defaults		

master sub menu.

Use the legend keys to navigate through this menu and exit to the main menu. Use the Table listed below to configure the hard disk.

<b>Item</b>	<b>Options</b>	<b>Description</b>
IDE HDD Auto-detection	Press Enter	Press Enter to auto-detect the HDD on this channel. If detection is successful, it fills the remaining fields on this menu.
IDE Channel 0 Master	None Auto Manual	Selecting 'manual' lets you set the remaining fields on this screen. Selects the type of fixed disk. "User Type" will let you select the number of cylinders, heads, etc. Note: PRECOMP=65535 means NONE !
Capacity	Auto Display your disk drive size	Disk drive capacity (Approximated). Note that this size is usually slightly greater than the size of a formatted disk given by a disk checking program.
Access Mode	CHS LBA Large Auto	Choose the access mode for this hard disk
The following options are selectable only if the 'IDE Channel 0 Master' item is set to 'Manual'		
Cylinder	Min = 0 Max = 65535	Set the number of cylinders for this hard disk.
Head	Min = 0 Max = 255	Set the number of read/write heads
Precomp	Min = 0 Max = 65535	**** Warning: Setting a value of 65535 means no hard disk
Landing zone	Min = 0 Max = 65535	****
Sector	Min = 0 Max = 255	Number of sectors per track

## **Drive A / Drive B**

---

These fields identify the types of floppy disk drive A or drive B that has been installed in the computer. The available specifications are:

Non	360KB	1.2MB	720KB	1.44MB	2.88MB
	5.25 in.	5.25 in.	3.5 in.	3.5 in.	3.5 in.

## **Video**

---

This field selects the type of video display card installed in your system.

You can choose the following video display cards:

EGA/VGA	For EGA, VGA, SEGA, SVGA or PGA monitor adapters. (default)
CGA 40	Power up in 40 column mode.
CGA 80	Power up in 80 column mode.
MONO	For Hercules or MDA adapters.

## **Halt On**

---

This field determines whether the system will halt if an error is detected during power up.

All errors	Whenever the BIOS detects a non-fatal error, the system will stop and you will be prompted.
No errors	The system boot will not be halted for any error that may be detected. (default)
All, But Keyboard	The system boot will not be halted for a keyboard error; it will stop for all other errors
All, But Diskette	The system boot will not be halted for a disk error; it will stop for all other errors.
All, But Disk/Key	The system boot will not be halted for a keyboard or disk error; it will stop for all others.

## Advanced BIOS Features

This section allows you to configure your system for basic operation. You have the opportunity to select the system's default speed, boot-up sequence, keyboard operation, shadowing and security.

Phoenix – AwardBIOS CMOS Setup Utility		
Advanced BIOS Features		
		Item Help
CPU Feature	[Press Enter]	
Hard Disk Boot Priority	[Press Enter]	
Virus Warning	[Disabled]	Menu Level ➤
CPU L1 and L2 Cache	[Enabled]	
Hyper-Threading Technology	[Enabled]	
Quick Power On Self Test	[Enabled]	
First Boot device	[Floppy]	
Second Boot device	[HDD]	
Third Boot device	[LS120]	
Boot other device	[Enabled]	
Swap Floppy Drive	[Disabled]	
Boot Up Floppy Seek	[Enabled]	
Boot Up NumLock Status	[On]	
Gate A20 Option	[Fast]	
Typematic Rate Setting	[Disabled]	
x Typematic Rate (Chars/Sec)	[6]	
x Typematic Delay (Msec)	[250]	
Security Option	[Setup]	
x APC Mode	[Enabled]	
MPS Version Control For OS	[1.4]	
OS Select For DRAM > 64MB	[Non-OS2]	
Report No FDD for Win95	[No]	
Small Logo (EPA) Show	[Disabled]	
↑↓←→Move Enter: Select +/-/PU/PD: Value F10:Save ESC: Exit F1:General Help F5:Previous Values F6:Fail-safe defaults F7:Optimized Defaults		

## CPU Feature

Phoenix – AwardBIOS CMOS Setup Utility		
CPU Feature		
Delay Prior Thermal	[16Min]	Item Help
Thermal Management	Thermal Monitor 1	
Limit CPUID MaxVal	[Disabled]	Menu Level ➤

↑↓←→Move Enter: Select +/-/PU/PD: Value F10:Save ESC: Exit F1:General Help  
F5:Previous Values F6:Fail-safe defaults F7:Optimized Defaults

### Delay Prior Thermal

The choice: 4Min, 8Min, 16Min, 32Min.

### Thermal Management

### Limit CPU MaxVal

Set Limit CPUID MaxVal to 3, Should Be “Disabled” for WinXp.

The choice: Enabled, Disabled

## Hard Disk Boot Priority

Phoenix – AwardBIOS CMOS Setup Utility Hard Disk Boot Priority	
1. Bootable Add-in Cards	Item Help
	Menu Level >
	Use < > or < > to select a device, then press <+> to move it up, or < - > to move it down the list. Press <ESC> to exit this menu
↑↓←→Move Enter: Select +/-/PU/PD: Value F10:Save ESC: Exit F1:General Help F5:Previous Values F6:Fail-safe defaults F7:Optimized Defaults	

### Bootable Add-in Cards

Use < > or < > to select a device, then press <+> to move it up, or < - > to move it down the list. Press <ESC> to exit this menu.

### Virus Warning

Allows you to choose the VIRUS Warning feature for IDE Hard Disk boot sector protection. If this function is enabled and someone attempt to write data into this area, BIOS will show a warning message on screen and alarm beep.

Enabled	Activates automatically when the system boots up causing a warning message to appear when anything attempts to access the boot sector or hard disk partition table.
Disabled	No warning message will appear when anything attempts to access the boot sector or hard disk partition table.

### CPU L1 & L2 Cache

These two categories speed up memory access. However, it depends on CPU/chipset design.

Enabled	Enable cache
Disabled	Disable cache



## **Hyper-Threading Technology**

---

Enabled	For windows XP and Linux 2.4.x (OS optimized for Hyper Threading Technology)
Disabled	For other OS (OS not optimized for Hyper Threading Technology)

## **Quick Power On Self Test**

---

Allows the system to skip certain tests while booting. This will decrease the time needed to boot the system.

Enabled	Enable quick POST
Disabled	Normal POST

## **First/Second/Third/Other Boot Device**

---

The BIOS attempts to load the operating system from the devices in the sequence selected in these items.

The Choice: Floppy, LS120, ZIP100, HDD, CDROM, LAN, Disabled, USB-FDD, USB-ZIP, USB-CDROM.

## **Swap Floppy Drive**

---

If the system has two floppy drives, choose enable to assign physical drive B to logical drive A and vice-versa.

The choice: Enabled/Disabled.

## **Boot Up Floppy Seek**

---

Enabled tests floppy drives to determine whether they have 40 or 80 tracks.

The choice: Enabled/Disabled.

## **Boot Up NumLock Status**

---

Select power on state for NumLock.

The choice: On/Off.

## Gate A20 Option

---

Select if chipset or keyboard controller should control GateA20.

Normal	A pin in the keyboard controller controls GateA20
Fast	Lets chipset control GateA20

## Typematic Rate Setting

---

Key strokes repeat at a rate determined by the keyboard controller. When enabled, the typematic rate and typematic delay can be selected.

The choice: Enabled/Disabled.

## Typematic Rate (Chars/Sec)

---

Sets the number of times a second to repeat a key stroke when you hold the key down.

The choice: 6, 8, 10, 12, 15, 20, 24, 30.

## Typematic Delay (Msec)

---

Sets the delay time after the key is held down before it begins to repeat the keystroke.

The choice: 250, 500, 750, 1000.

## Security Option

---

Select whether the password is required every time the system boots or only when you enter setup.

System	The system will not boot and access to Setup will be denied if the correct password is not entered at the prompt.
Setup	The system will boot, but access to Setup will be denied if the correct password is not entered at the prompt.

Note: To disable security, select PASSWORD SETTING at Main Menu and then you will be asked to enter password. Do not type anything and just press <Enter>, it will disable security. Once the security is disabled, the system will boot and you can enter Setup freely.

## **APIC Mode**

---

## **MPS Version Control For OS**

---

The choice: 1.1, 1.4.

## **OS Select For DRAM > 64MB**

---

Select the OS2 only if you are running OS/2 operating system with greater than 64MB of RAM on the system.

The choice: Non-OS2, OS2.

## **Report No FDD For WIN 95**

---

This option allows Windows 95 to share with other peripherals IRQ6 which is assigned to a floppy disk drive if the drive is not existing. The default setting is *No*.

The choice: Yes, No.

## **Small Logo (EPA) show**

---

The choice: Enabled/Disabled.

## Advanced Chipset Features

Phoenix – AwardBIOS CMOS Setup Utility		
Advanced Chipset Features		
		Item Help
DRAM Timing Selectable	[By SPD]	
x CAS Latency Time	[2.5]	
x Active to Precharge Delay	[6]	Menu Level ➤
x DRAM RAS# to CAS# Delay	[3]	
x DRAM RAS# Precharge	[3]	
Memory Frequency For	[Auto]	
System BIOS Cacheable	[Enabled]	
Video BIOS Cacheable	[Disabled]	
Memory Hole At 15M-16M	[Disabled]	
AGP Aperture Size (MB)	[128]	
Init Display First	[PCI Slot]	
***On-Chip VGA Setting***		
On-Chip VGA	[Enabled]	
On-Chip Frame Buffer Size	[8MB]	
Boot Display	[Auto]	
Panel Number	[Auto]	
↑↓←→Move Enter: Select +/-/PU/PD: Value F10:Save ESC: Exit F1:General Help F5:Previous Values F6:Fail-safe defaults F7:Optimized Defaults		

This section allows you to configure the system based on the specific features of the installed chipset. This chipset manages bus speeds and access to system memory resources, such as DRAM and the external cache. It also coordinates communications between the conventional ISA bus and the PCI bus. It must be stated that these items should never need to be altered. The default settings have been chosen because they provide the best operating conditions for your system. The only time you might consider making any changes would be if you discovered that data was being lost while using your system.

### DRAM Settings

The first chipset settings deal with CPU access to dynamic random access memory (DRAM). The default timings have been carefully chosen and should only be altered if data is being lost. Such a scenario might well occur if your system had mixed speed DRAM chips installed so that greater delays may be required to preserve the integrity of the data held in the slower memory chips.

### **DRAM Timing Selectable**

---

This item allows you to select the DRAM timing determined by the timing information stored in SPD or set by the User manually. The default is By SPD. When this field is set as By SPD, the DRAM Timing items below will become read-only.

The choice: By SPD, Manual.

### **CAS Latency Time**

---

When synchronous DRAM is installed, the number of clock cycles of CAS latency depends on the DRAM timing. Do not reset this field from the default value specified by the system designer.

The choice: 3, 2.5, 2, 1.5.

### **Active to Precharge Delay**

---

This item allows you to set the Active to Precharge Delay of DRAM timing. Do not reset this field from the default value specified by the system designer.

The choice: 6, 5.

### **DRAM RAS# to CAS# Delay**

---

When DRAM is refreshed, both rows and columns are addressed separately. This field allows you to determine the timing of transition from Row Address Strobe (RAS) to Column Address Strobe (CAS).

The choice: 3, 2.

### **DRAM RAS# Precharge**

---

The precharge time is the number of cycles it takes for the RAS to accumulate its charge before DRAM refresh. If insufficient time is allowed, refresh may be incomplete and the DRAM may fail to retain data.

The choice: 3, 2.

## **Memory Frequency For**

---

This item allows user to set the DDR DRAM operation frequency. The Auto is default.

The choice: DDR266, Auto.

## **System BIOS Cacheable**

---

Selecting *Enabled* allows caching of the system BIOS ROM at F0000h-FFFFFh, resulting in better system performance. However, if any program writes to this memory area, a system error may result.

The choice: Enabled, Disabled.

## **Video BIOS Cacheable**

---

Selecting *Enabled* allows caching of the Video BIOS ROM, resulting in better system performance. However, if any program writes to this memory area, a system error may result.

The choice: Enabled, Disabled.

## **Memory Hole at 15MB - 16MB**

---

In order to improve performance, certain space in memory can be reserved for ISA cards. This field allows you to reserve 15MB to 16MB memory address space to ISA expansion cards. This makes memory from 15MB and up unavailable to the system. Expansion cards can only access memory up to 16MB. The default of this field is set to *Disabled*.

The choice: Enabled, Disabled.

## **AGP Aperture Size (MB)**

---

Select the size of Accelerated Graphics Port (AGP) aperture. The aperture is a portion of the PCI memory address range dedicated for graphics memory address space. Host cycles that hit the aperture range are forwarded to the AGP without any translation.

The choice: 4M, 8M, 16M, 32M, 64M, 128M, 256M.

## **Init Display First**

---

The choice: PCI Slot, Onboard/AGP

## **On-Chip VGA Setting**

---

### **On-Chip VGA**

The choice: Enabled, Disabled.

### **On-Chip Frame Buffer Size**

The choice: 1MB, 8MB, 16MB.

### **Boot Display**

The choice: Auto, CRT, LFP, CRT+LFP, EFP, TV, CRT+EFP, CRT+TV.

### **Panel Number**

The choice: 1, 2, 3, 4, 5, 6, 7, 8, 9, 10, 11, 12, 13, 14, 15, 16.

## Integrated Peripherals

Phoenix – AwardBIOS CMOS Setup Utility		
Integrated Peripherals		
OnChip IDE Device	[Press Enter]	Item Help
Onboard Device	[Press Enter]	
SuperIO Device	[Press Enter]	
		Menu Level ➤
↑↓←→ Move Enter: Select +/-/PU/PD: Value F10:Save ESC: Exit F1:General Help F5:Previous Values F6:Fail-safe defaults F7:Optimized Defaults		

### OnChip IDE Device

Phoenix – AwardBIOS CMOS Setup Utility		
OnChip IDE Device		
IDE HDD Block Mode	[Enabled]	Item Help
IDE DMA transfer access	[Enabled]	
On-Chip Primary PCI IDE	[Enabled]	
IDE Primary Master PIO	[Auto]	Menu Level ➤
IDE Primary Salve PIO	[Auto]	
IDE Primary Master UDMA	[Auto]	
IDE Primary Salve UDMA	[Auto]	
On-Chip Secondary PCI IDE	[Enabled]	
IDE Secondary Master PIO	[Auto]	
IDE Secondary Master PIO	[Auto]	
IDE Secondary Master UDMA	[Auto]	
IDE Secondary Salve UDMA	[Auto]	
***On-Chip Serial ATA Setting***		
x SATA Mode	IDE	
On-Chip Serial ATA	[Disabled]	
x Serial ATA Port0 Mode	Primary Master	
Serial ATA Port1 Mode	[Primary Slave]	
↑↓←→ Move Enter: Select +/-/PU/PD: Value F10:Save ESC: Exit F1:General Help F5:Previous Values F6:Fail-safe defaults F7:Optimized Defaults		



### **IDE HDD Block Mode**

---

If your IDE hard drive supports block mode select Enabled for automatic detection of the optimal number of block read/writes per sector the drive can support

The choice: Enabled, Disabled.

### **IDE DMA transfer access**

---

The choice: Enabled, Disabled.

### **On-Chip Primary PCI IDE**

---

The chipset contains a PCI IDE interface with support for two IDE channels. Select Enabled to activate the primary IDE interface. Select Disabled to deactivate this interface

The choice: Enabled, Disabled.

### **On-Chip Secondary PCI IDE**

---

The chipset contains a PCI IDE interface with support for two IDE channels. Select Enabled to activate the secondary IDE interface. Select Disabled to deactivate this interface

The choice: Enabled, Disabled.

### **IDE Primary/Secondary Master/Slave PIO**

---

The four IDE PIO (Programmed Input/Output) fields let you set a PIO mode (0-4) for each of the four IDE devices that the onboard IDE interface supports. Modes 0 through 4 provide successively increased performance. In Auto mode, the system automatically determines the best mode for each device.

The choice: Auto, Mode 0, Mode 1, Mode 2, Mode 3, Mode 4.

## **Primary/Secondary Master/Slave UDMA**

---

Ultra DMA/33/66/100 implementation is possible only if your IDE hard drive and cable supports it and the operating environment includes a UDMA driver. If your hard drive and your system software both support Ultra DMA/33/66/100, select Auto to enable BIOS support. The System BIOS will also check the IDE cable. Only if the 80-way ATA66/100 cable is installed, the ATA66/100 models can be enabled by the OS driver. Otherwise, the system will be limited to run up to ATA33 mode.

The Choice: Auto, Disabled.

## **On-Chip Serial ATA Setting**

---

### **SATA Mode**

### **On-Chip Serial ATA**

Disabled	Disabled SATA Controller.
Auto	Auto arrange by BIOS.
Combined Mode	PATA and SATA are combined. Max. of 2 IDE drives in each channel.
Enhanced Mode	Enable both SATA and PATA. Max. of 6 IDE drives are supported.
SATA Only	SATA is operating in legacy mode

### **Serial ATA Port0 Mode**

The choice: Primary Master, Primary Slave, Secondary Master, Secondary Slave, Primary Master, Secondary Master, SATA0 master, SATA1 master.

### **Serial ATA Port1 Mode**

The choice: Primary Master, Primary Slave, Secondary Master, Secondary Slave, Primary Master, Secondary Master, SATA0 master, SATA1 master.

## Onboard Device

Phoenix – AwardBIOS CMOS Setup Utility		
Onboard Device		
USB Controller	[Enabled]	Item Help
USB 2.0 Controller	[Enabled]	
USB Keyboard Support	[Disabled]	
USB Mouse Support	[Disabled]	
AC97 Audio	[Auto]	Menu Level ➤
CSA LAN (Giga-LAN)	[Enabled]	

↑↓←→ Move Enter: Select +/-/PU/PD: Value F10:Save ESC: Exit F1:General Help  
F5:Previous Values F6:Fail-safe defaults F7:Optimized Defaults

### USB Controller

This should be enabled if your system has a USB installed on the system board and you wish to use it. Even when so equipped, if you add a higher performance controller, you will need to disable this feature.

The choice: Enabled, Disabled.

### USB 2.0 Controller

This entry is for disable/enable EHCI controller only. This BIOS itself may/may not have high speed USB support. If the BIOS has high speed USB support built in, the support will be automatically turn on when high speed device were attached.

The choice: Enabled, Disabled.

### USB Keyboard Support

Select *Enabled* if your system contains a Universal Serial Bus (USB) controller and you have a USB keyboard.

The choice: Enabled, Disabled.

## USB Mouse Support

---

The choice: Enabled, Disabled.

## AC97 Audio

---

The choice: Auto, Disabled.

## CSA LAN(Giga-LAN)

---

The choice: Enabled, Disabled.

## SuperIO Device

---

Phoenix – AwardBIOS CMOS Setup Utility		
SuperIO Device		
Onboard FDC Controller	[Enabled]	Item Help
Onboard Serial Port 1	[3F8/IRQ4]	
Onboard Serial Port 2	[2F8/IRQ3]	
UART Mode Select	[Normal]	Menu Level ➤
x RxD , TxD Active	Hi, Lo	
x IR Transmission Delay	Enabled	
x UR2 Duplex Mode	Half	
Onboard Parallel Port	[378/IRQ7]	
Parallel Port Mode	[SPP]	
x EPP Mode Select	EPP1.7	
x ECP Mode Use DMA	3	
PWRON After PWR-Fail	[Off]	

↑↓←→ Move Enter: Select +/-/PU/PD: Value F10:Save ESC: Exit F1:General Help  
F5:Previous Values F6:Fail-safe defaults F7:Optimized Defaults

## Onboard FDC Controller

---

Select Enabled if your system has a floppy disk controller (FDC) installed on the system board and you wish to use it. If you install and-in FDC or the system has no floppy drive, select Disabled in this field.

The choice: Enabled, Disabled.

## **Onboard Serial Port 1/Port 2**

---

Select an address and corresponding interrupt for the first and second serial ports.

The choice: 3F8/IRQ4, 2F8/IRQ3, 3E8/IRQ4, 2E8/IRQ3, Disabled, Auto.

## **UART Mode Select**

---

The choice: IrDA, ASKIR, Normal.

## **RxD, TxD Active**

---

This item allows you to choose Hi-Active or Low-Active of TX and RX signal, which depends on different H/W requirement. This field is not recommended to change its default setting for avoiding any error in your system

The Choice: Hi, Hi / Hi, Lo (Default) / Lo, Hi / Lo, Lo.

## **IR Transmission Delay**

---

This item allows you to Enable/Disable IR transmission delay.

The choice: Enabled, Disabled.

## **IR2 Duplex Mode**

---

This item allows you to select the IR half/full duplex function.

The Choice: Half, Full.

## **Onboard Parallel Port**

---

This item allows you to determine onboard parallel port controller I/O address setting.

The choice: 378/IRQ7, 278/IRQ5, 3BC/IRQ7, Disabled.

## **Parallel Port Mode**

---

Select an operating mode for the onboard parallel (printer) port. Select *Normal*, *Compatible*, or *SPP* unless you are certain your hardware and software both support one of the other available modes.

The choice: SPP, EPP, ECP, ECP+EPP, Normal.

### **EPP Mode Select**

---

Select EPP port type 1.7 or 1.9.

The choice: EPP1.7, 1.9.

### **ECP Mode Use DMA**

---

Select a DMA channel for the parallel port for use during ECP mode.

The choice: 3, 1.

### **PWRON After PWR-Fail**

---

The choice: Off, On, Former-Sts.

## Power Management Setup

The Power Management Setup allows you to configure you system to most effectively save energy while operating in a manner consistent with your own style of computer use.

Phoenix – AwardBIOS CMOS Setup Utility		
Power Management Setup		
		Item Help
Power-Supply Type	[AT]	
ACPI Function	[Enabled]	
Power Management	[User Define]	Menu Level ➤
Video Off Method	[DPMS]	
Video Off In Suspend	[Yes]	
MODEM Use IRQ	[3]	
Suspend Mode	[Disabled]	
HDD Power Down	[Disabled]	
Soft-Off by PWR-BTTN	[Instant-Off]	
CPU THRM-Throttling	[50.0%]	
Wake-Up by PCI Card	[Enabled]	
Power On by Ring	[Enabled]	
Wake Up On LAN	[Enabled]	
Resume by Alarm	[Disabled]	
x Date (of Month) Alarm	0	
x Time (hh:mm:ss) Alarm	0 : 0 : 0	
** Reload Global Timer Events **		
Primary IDE 0	[Disabled]	
Primary IDE 1	[Disabled]	
Secondary IDE 0	[Disabled]	
Secondary IDE 1	[Disabled]	
FDD, COM, LPT Port	[Disabled]	
PCI PIRQ[A-D]#	[Disabled]	
↑↓←→Move Enter: Select +/-/PU/PD: Value F10:Save ESC: Exit F1:General Help F5:Previous Values F6:Fail-safe defaults F7:Optimized Defaults		

### Power-Supply Type

This should be AT if you use AT power supply or ATX power supply but force to AT mode. This selection help BIOS provide the information to OS what kind power-supply the system use. The correct information provide to OS can avoid the Windows Shutdown issue.

The choice: AT, ATX.

## **ACPI Function**

---

This item allows you to enable/disable the Advanced Configuration and Power Management (ACPI).

The choice: Enabled, Disabled.

## **Power Management**

---

This category allows you to select the type (or degree) of power saving and is directly related to the following modes:

1. HDD Power Down
2. Suspend Mode

There are three selections for Power Management, three of which have fixed mode settings.

Disable (default)	No power management. Disables all four modes
Min. Power Saving	Minimum power management. Suspend Mode = 1 hr., and HDD Power Down = 15 min.
Max. Power Saving	Maximum power management. Suspend Mode = 1 min., and HDD Power Down = 1 min.
User Defined	Allows you to set each mode individually. The Suspend mode ranges are from 1 min. to 1 hr. The HDD Power Down ranges are from 1 min. to 15 min. and disable.

## **Video Off Method**

---

This determines the manner in which the monitor is blanked.

V/H SYNC+Blank	This selection will cause the system to turn off the vertical and horizontal synchronization ports and write blanks to the video buffer.
Blank Screen	This option only writes blanks to the video buffer.
DPMS	Initial display power management signaling. Allows the BIOS to control video display card if it supports the DPMS feature.



### **Video Off In Suspend**

---

This determines the if the turn off the video display when system enter suspend mode.

The choice: Yes, No.

### **MODEM Use IRQ**

---

This determines the IRQ in which the MODEM can use.

The choice: 3, 4, 5, 7, 9, 10, 11, NA.

### **Suspend Mode**

---

When enabled and after the set time of system inactivity, CPU will be put into the suspend mode.

The choice: Disabled, 1 min, 2 min, 4 min, 8min, 12min, 20min, 30min, 40min, 1 hour.

### **HDD Power Down**

---

When enabled and after the set time of system inactivity, the hard disk drive will be powered down while all other devices remain active.

The choice: Disabled, 1 min, 2 min, 4 min, ..... 15 min.

### **Soft-Off by PWR-BTTN**

---

The choice: Instant-Off, Delay 4 Sec.

### **CPU THRM-Throttling**

---

The choice: 75.0%, 50.0%, 25.0%

### **Wake-Up by PCI card**

---

The choice: Enabled, Disabled.

## **Power On By Ring**

---

An input signal on the serial Ring Indicator (RI) line (in other words, an incoming call on the modem) awakens the system from a soft off state.

The choice: Enabled, Disabled.

## **Wake Up On LAN**

---

The choice: Enabled, Disabled.

## **Resume by Alarm**

---

When *Enabled*, you can set the date and time at which the RTC (real-time clock) alarm awakens the system from Suspend mode.

The choice: Enabled, Disabled.

## **Reload Global Timer Events**

---

PM events are I/O events whose occurrence can prevent the system from entering a suspend mode or can awaken the system from such a mode. In effect, the system remains alert for anything which occurs to a device which is configured as *Enabled*, even when the system is in a Suspend down mode.

### **Primary/Secondary IDE 0/1**

When *Enabled*, any activity from one of the listed system peripheral devices or IRQs wakes up the system.

The choice: Enabled, Disabled.

### **FDD, LPT & COM**

When Enabled, any activity from one of the listed system peripheral devices or IRQs wakes up the system.

The choice: Enabled, Disabled.

### **PCI PIRQ[A-D]#**

When Enabled, any activity from one of the listed PCI IRQ signals wakes up the system.

The choice: Enabled, Disabled.

## PnP/PCI Configuration Setup

This section describes configuring the PCI bus system. PCI, or **Personal Computer Interconnect**, is a system which allows I/O devices to operate at speeds nearing the speed the CPU itself uses when communicating with its own special components. This section covers some very technical items and it is strongly recommended that only experienced users should make any changes to the default settings.

Phoenix – AwardBIOS CMOS Setup Utility		
PnP/PCI Configurations		
PnP OS Installed	[No]	Item Help
<b>Reset Configuration Data</b>	[Disabled]	
Resources Controlled By	[Auto(ESCD)]	Menu Level ➤
x IRQ Resources	Press Enter	Default is Disabled. Select Enabled to reset Extended System Configuration Data(ESCD) when you exit Setup if you have installed a new add-on and the system reconfiguration has caused such a serious conflict that the OS cannot boot
x Memory Resources	Press Enter	
PCI/VGA Palette Snoop	[Disabled]	
INTA Assignment	[Auto]	
INTB Assignment	[Auto]	
INTC Assignment	[Auto]	
INTD Assignment	[Auto]	
INTE Assignment	[Auto]	
INTF Assignment	[Auto]	
INTG Assignment	[Auto]	
INTH Assignment	[Auto]	
↑↓←→Move Enter: Select +/-/PU/PD: Value F10:Save ESC: Exit F1:General Help F5:Previous Values F6:Fail-safe defaults F7:Optimized Defaults		

### **PNP OS Installed**

This item allows you to determine install PnP OS or not.

Yes	If you are using a Plug and Play capable operating system.
No	If you need the BIOS to configure non-boot devices.

### **Reset Configuration Data**

Default is Disabled. Select Enabled to reset Extended System Configuration Data (ESCD) when you exit Setup if you have installed a new add-on and the system reconfiguration has caused such a serious conflict that the OS cannot boot.

The choice: Enabled, Disabled.

### **Resource controlled by**

---

BIOS can automatically configure all the boot and Plug and Play compatible devices. If you choose Auto, you cannot select IRQ DMA and memory base address fields, since BIOS automatically assigns them.

The choice: Auto(ESCD), Manual.

### **IRQ Resources**

---

When resources are controlled manually, assign each system interrupt a type, depending on the type of device using the interrupt. This item allows you to determine the IRQ assigned to the ISA bus and is not available to any PCI slot. Legacy ISA for devices compliant with the original PC AT bus specification, PCI/ISA PnP for devices compliant with the Plug and Play standard whether designed for PCI or ISA bus architecture.

The Choice: *Legacy ISA* and *PCI/ISA PnP*.

### **Memory Resources**

---

#### **PCI/VGA Palette Snoop**

---

Leave this field at *Disabled*.

Choices are Enabled, Disabled.

#### **INTA Assignment**

---

Device(s) using this INT:

Display Cntrlr- Bus 0 Dev 2 Func 0 USB 1.0/1.1 UHCI Cntrlr  
- Bus 0 Dev29 Func 0 USB 1.0/1.1 UHCI Cntrlr  
- Bus 0 Dev29 Func3

Choices are Auto, 3, 4, 5, 7, 9, 10, 11, 12, 14, 15.

#### **INTB Assignment**

---

Device(s) using this INT:

Multimedia Device- Bus 0 Dev31 Func 5 Simple COMM. Cntrlr

- Bus 0 Dev31 Func 6 SMBus Cntrlr
- Bus 0 Dev31 Func 3

Choices are Auto, 3, 4, 5, 7, 9, 10, 11, 12, 14, 15.

### **INTC Assignment**

---

Device(s) using this INT:

Network Cntrlr-Bus 1 Dev 1 Func 0 USB 1.0/1.1 UHCI Cntrlr  
-Bus 0 Dev29 Func 2

Choices are Auto, 3, 4, 5, 7, 9, 10, 11, 12, 14, 15.

### **INTD Assignment**

---

Device(s) using this INT:

USB 1.0/1.1 UHCI Cntrlr-Bus 0 Dev29 Func 1

Choices are Auto, 3, 4, 5, 7, 9, 10, 11, 12, 14, 15.

### **INTE Assignment**

---

Choices are Auto, 3, 4, 5, 7, 9, 10, 11, 12, 14, 15.

### **INTF Assignment**

---

Device(s) using this INT:

Choices are Auto, 3, 4, 5, 7, 9, 10, 11, 12, 14, 15.

### **INTG Assignment**

---

Device(s) using this INT:

Network Cntrlr-Bus 2 Dev10 Func 0

Choices are Auto, 3, 4, 5, 7, 9, 10, 11, 12, 14, 15.

### **INTH Assignment**

---

Device(s) using this INT:

USB 2.0 EHCI Cntrlr- Bus 0 Dev29 Func7

Choices are Auto, 3, 4, 5, 7, 9, 10, 11, 12, 14, 15.

## PC Health Status

This section helps you to get more information about your system including CPU temperature, FAN speed and voltages. It is recommended that you contact with your motherboard supplier to get proper value about your setting of the CPU temperature.

Phoenix – AwardBIOS CMOS Setup Utility		
PC Health Status		
		Item Help
CPU Warning Temperature	[Disabled ]	
Current CPU Temperature	52°C / 125°F	
Current CPU Die Temperature	32°C / 95°F	Menu Level ➤
Current System Temperature	35°C / 95°F	
CPU FAN Speed	4500 RPM	
CHASSIS FAN Speed	0 RPM	
Vcore	1.7V	
+1.5V	1.5V	
+3.3V	3.31V	
+5V	5.01V	
+12V	12.0V	
-12V	-12.03V	
-5V	-5.09V	
VBAT(V)	3.28V	
5VSB(V)	4.95V	
Shutdown Temperature	[Disabled]	
↑↓←→ Move Enter: Select +/-/PU/PD: Value F10:Save ESC: Exit F1:General Help F5:Previous Values F6:Fail-safe defaults F7:Optimized Defaults		

### **CPU Warning Temperature**

Select the CPU over-heated warning temperature.

The choice: Disabled, 50°C/122°F, 53°C/127°F, 56°C/133°F, 60°C/140°F, 63°C/145°F, 66°C/151°F, 70°C/158°F.

### **Current CPU Temperature**

Shows CPU Temperature.

### **Current CPU Die Temperature**

Shows CPU Die Temperature.

### **Current System Temperature**

Show System Temperature.

### **CPU FAN Speed**

---

Shows CPU FAN speed.

### **CHASSIS FAN Speed**

---

Shows System FAN speed.

### **Vcore/1.5V/3.3V/5V/12V/-12V/-5V/VBAT/5VSB Voltages**

---

Shows Power rails voltage.

### **Shutdown Temperature**

---

Select the CPU over-heated shutdown temperature.

The choice: Disabled, 60°C/140°F, 65°C/149°F, 70°C/158°F, 75°C/167°F.

## Frequency/Voltage Control

Phoenix – AwardBIOS CMOS Setup Utility		
Frequency/Voltage Control		
CPU Clock Ratio	[14X]	Item Help
Auto Detect PCI Clk	[Disabled]	
Spread Spectrum	[Enabled]	
		Menu Level ➤

↑↓←→ Move Enter: Select +/-/PU/PD: Value F10:Save ESC: Exit F1:General Help  
F5:Previous Values F6:Fail-safe defaults F7:Optimized Defaults

### **CPU Clock Ratio**

---

Min=14

Max=14

Key in a DEC number:

### **Auto Detect PCI Clk**

---

This item allows you to enable/disable auto detect PCI Clock. Turning off the un-used PCI clocks may help to EMI issue. Since there is no PCI clock routing specification for PICMG backplane, some system may have PCI card detect issue. In that case, please disable this item.

The choice: Enabled, Disabled.

### **Spread Spectrum**

---

This item allows you to enable/disable the spread spectrum modulation. The spread spectrum technology also helps to alleviate the EMI.

The choice: Enabled, Disabled.



## Load Fail-Safe Defaults

When you press <Enter> on this item you get a confirmation dialog box with a message similar to:

**Load Fail-Safe Defaults (Y/N) ?**  **N**

Pressing 'Y' loads the BIOS default values for the most stable, minimal-performance system operations.

## Load Optimized Defaults

When you press <Enter> on this item you get a confirmation dialog box with a message similar to:

**Load Optimized Defaults (Y/N) ?**  **N**

Pressing 'Y' loads the default values that are factory settings for optimal performance system operations.

## Supervisor/User Password Setting

You can set either supervisor or user password, or both of them. The differences between are:

**supervisor password** : can enter and change the options of the setup menus.

**user password** : just can only enter but do not have the right to change the options of the setup menus. When you select this function, the following message will appear at the center of the screen to assist you in creating a password.

### **ENTER PASSWORD:**

Type the password, up to eight characters in length, and press <Enter>. The password typed now will clear any previously entered password from CMOS memory. You will be asked to confirm the password. Type the password again and press <Enter>. You may also press <Esc> to abort the selection and not enter a password.

To disable a password, just press <Enter> when you are prompted to enter the password. A message will confirm the password will be disabled. Once the password is disabled, the system will boot and you can enter Setup freely.

### **PASSWORD DISABLED.**

When a password has been enabled, you will be prompted to enter it every time you try to enter Setup. This prevents an unauthorized person from changing any part of your system configuration.

Additionally, when a password is enabled, you can also require the BIOS to request a password every time your system is rebooted. This would prevent unauthorized use of your computer.

You determine when the password is required within the BIOS Features Setup Menu and its Security option. If the Security option is set to "System", the password will be required both at boot and at entry to Setup. If set to "Setup", prompting only occurs when trying to enter Setup.

# Exit Selecting

## **Save & Exit Setup**

---

**Pressing <Enter> on this item asks for confirmation:**

**Save to CMOS and EXIT (Y/N)?**  **Y**

Pressing “Y” stores the selections made in the menus in CMOS – a special section of memory that stays on after you turn your system off. The next time you boot your computer, the BIOS configures your system according to the Setup selections stored in CMOS. After saving the values the system is restarted again.

## **Exit Without Saving**

---

**Pressing <Enter> on this item asks for confirmation:**

**Quit without saving (Y/N)?**  **N**

This allows you to exit Setup without storing in CMOS any change. The previous selections remain in effect. This exits the Setup utility and restarts your computer.

## Appendix

- ◆ **I/O Port Address Map**
- ◆ **Interrupt Request Lines (IRQ)**
- ◆ **POST Beep**

## A. I/O Port Address Map

Each peripheral device in the system is assigned a set of I/O port addresses which also becomes the identity of the device. There are a total of 1K port address space available. The following table lists the I/O port addresses used on the Industrial CPU Card.

<b>Address</b>	<b>Device Description</b>
000h - 01Fh	DMA Controller #1
020h - 03Fh	Interrupt Controller #1
040h - 05Fh	Timer
060h - 06Fh	Keyboard Controller
070h - 07Fh	Real Time Clock, NMI
080h - 09Fh	DMA Page Register
0A0h - 0BFh	Interrupt Controller #2
0C0h - 0DFh	DMA Controller #2
0F0h	Clear Math Coprocessor Busy Signal
0F1h	Reset Math Coprocessor
1F0h - 1F7h	IDE Interface
278 - 27F	Parallel Port #2(LPT2)
2F8h - 2FFh	Serial Port #2(COM2)
2B0 - 2DF	Graphics adapter Controller
378h - 3FFh	Parallel Port #1(LPT1)
360 - 36F	Network Ports
3B0 - 3BF	Monochrome & Printer adapter
3C0 - 3CF	EGA adapter
3D0 - 3DF	CGA adapter
3F0h - 3F7h	Floppy Disk Controller
3F8h - 3FFh	Serial Port #1(COM1)

## B. Interrupt Request Lines (IRQ)

There are a total of 15 IRQ lines available on the Industrial CPU Card. Peripheral devices use interrupt request lines to notify CPU for the service required. The following table shows the IRQ used by the devices on the Industrial CPU Card.

<b>Level</b>	<b>Function</b>
IRQ0	System Timer Output
IRQ1	Keyboard
IRQ2	Interrupt Cascade
IRQ3	Serial Port #2
IRQ4	Serial Port #1
IRQ5	Reserved
IRQ6	Floppy Disk Controller
IRQ7	Parallel Port #1
IRQ8	Real Time Clock
IRQ9	Software Redirected to Int 0Ah
IRQ10	Reserved
IRQ11	Reserved
IRQ12	PS/2 Mouse
IRQ13	80287
IRQ14	Primary IDE
IRQ15	Secondary IDE

## C. POST Beep

Currently there are two kinds of beep codes in BIOS. This code indicates that a **video error** has occurred and the BIOS cannot initialize the video screen to display any additional information. This beep code consists of a single long beep followed by two short beeps.

The other code indicates that your **DRAM error** has occurred. This beep code consists of a single long beep repeatedly.

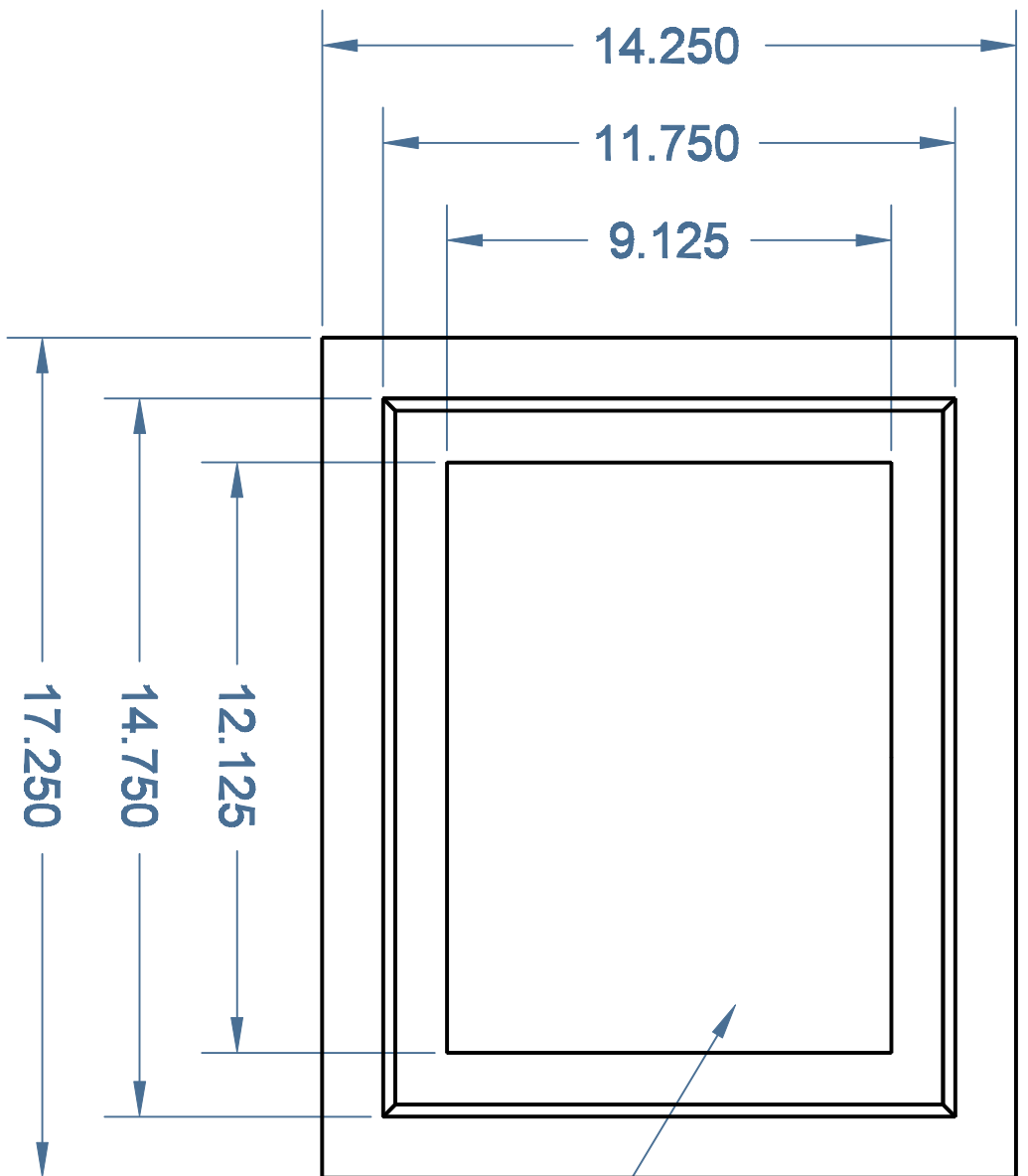

15" LCD MONITOR

**FRONT VIEW**

DATE	11-26-2003	DRAWN BY	B.G.	MODEL	TR-5001
PRODUCT	PANEL PC		REVISION		
FINISH	CRINKLE BLACK	TRANSDUCTION	CHECKED BY	NTS	
TITLE	LAYOUT			DRAWING No	B-323
SCALE					



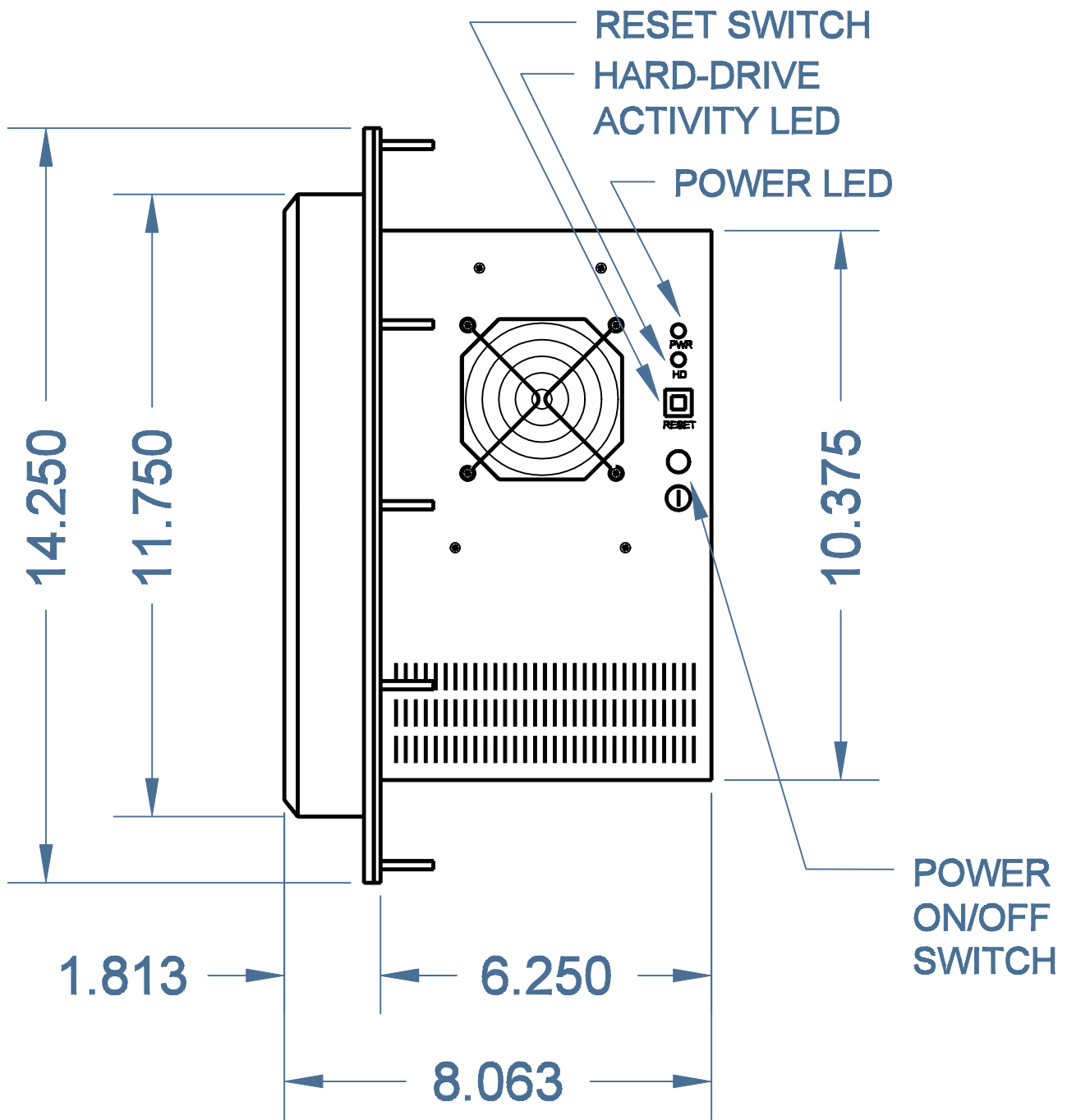

## RIGHT SIDE VIEW

DATE <b>11-25-2003</b>	DRAWN BY <b>B. G.</b>	MODEL <b>TR-5001</b>
PRODUCT <b>PANEL PC</b>		REVISION
FINISH <b>CRINKLE BLACK POWDER PAINT</b>		CHECKED BY <b>NTS</b>
TITLE <b>LAYOUT</b>		DRAWING No <b>B-324</b>

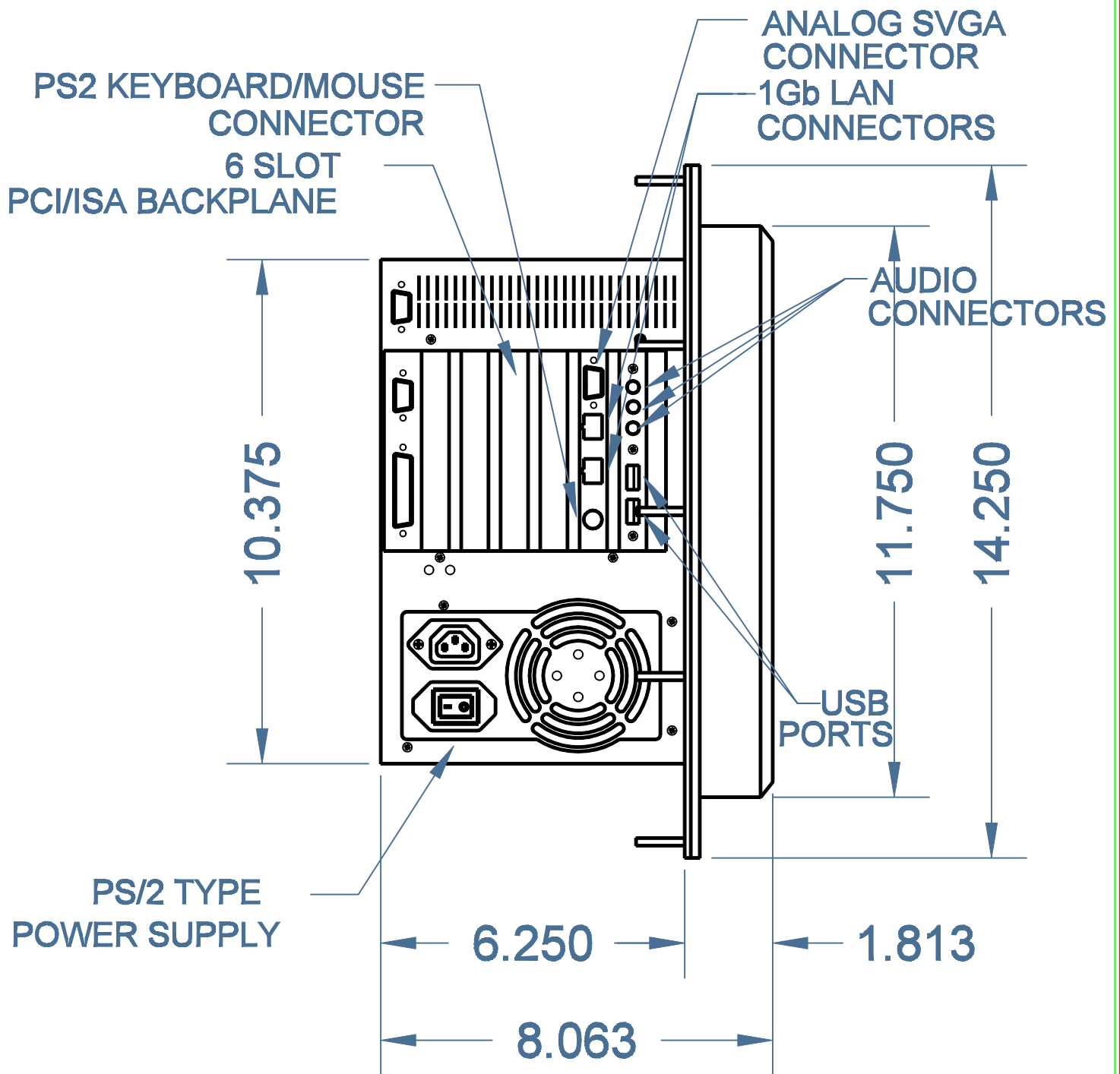

### LEFT SIDE VIEW

DATE <b>11-25-2003</b>	DRAWN BY <b>B. G.</b>	MODEL <b>TR-5001</b>		
PRODUCT <b>PANEL PC</b>			REVISION	SCALE
FINISH <b>CRINKLE BLACK POWDER PAINT</b>		Transduction		CHECKED BY <b>NTS</b>
TITLE <b>LAYOUT</b>			DRAWING No <b>B-325</b>	

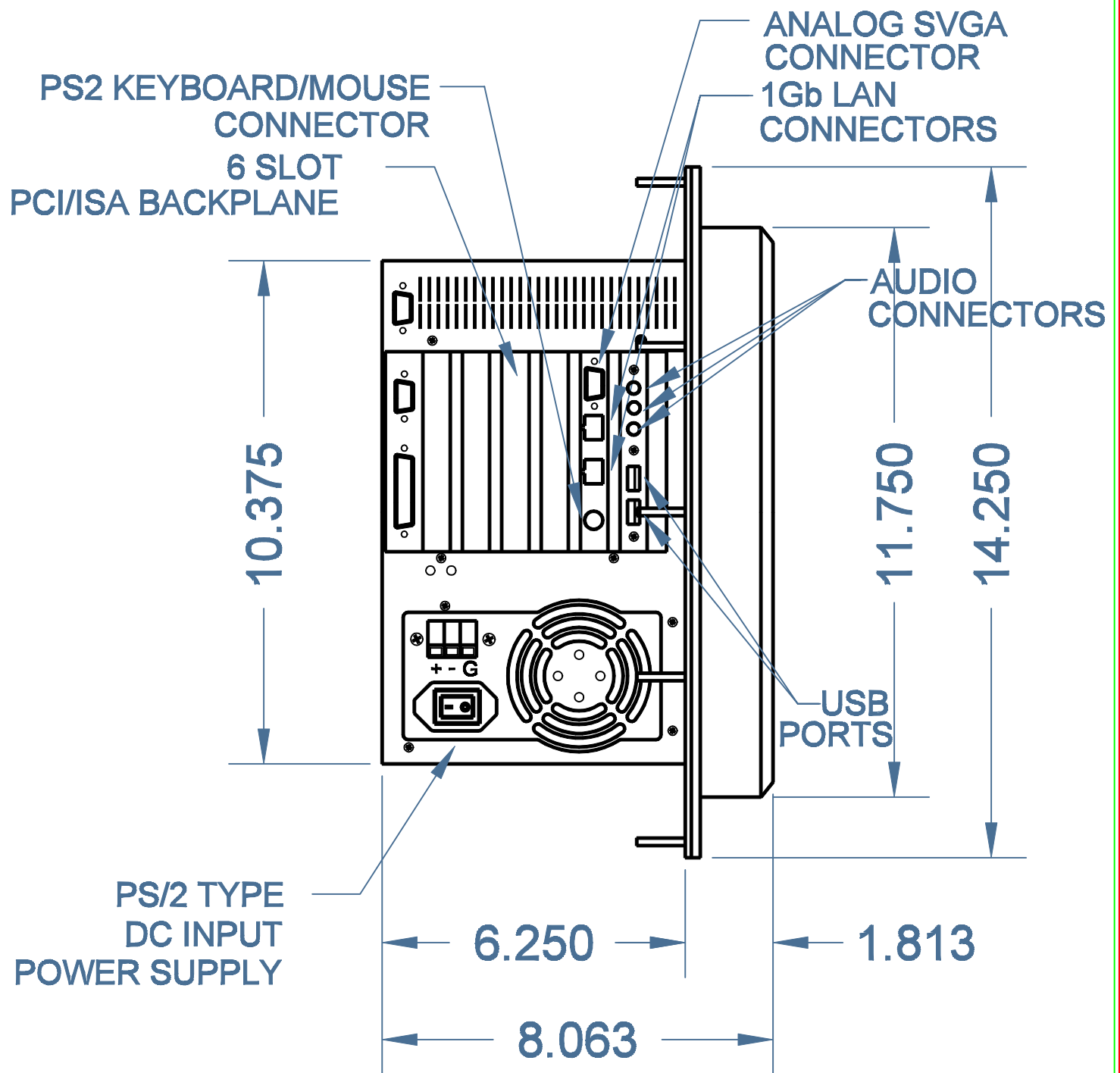

**LEFT SIDE VIEW**

DATE 11-25-2003	DRAWN BY B. G.	MODEL TR-5001	
PRODUCT PANEL PC		REVISION	SCALE
FINISH CRINKLE BLACK POWDER PAINT	Transduction	CHECKED BY	NTS
TITLE LAYOUT		DRAWING No B-325A	

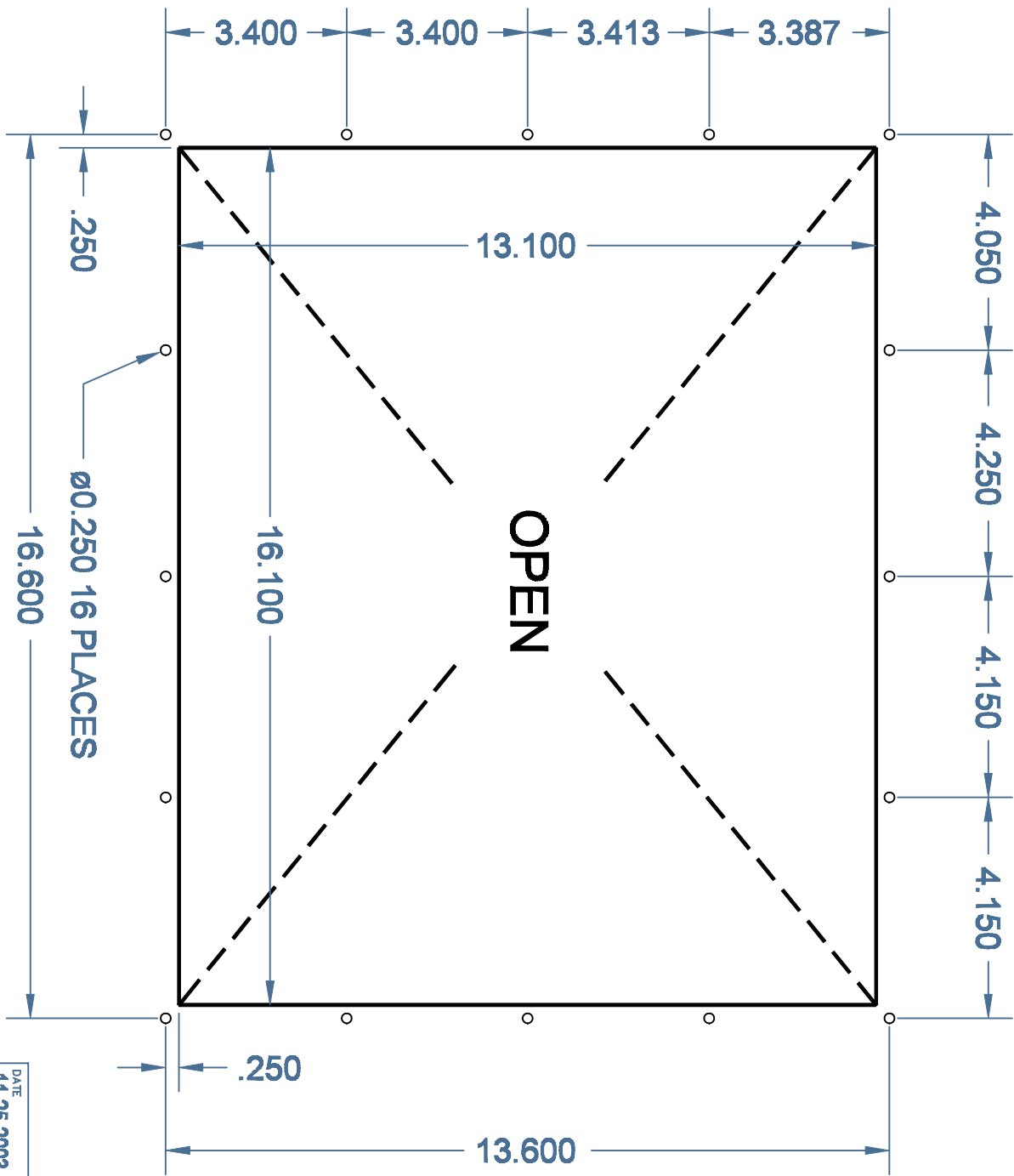

DATE	11-25-2003	DRAWN BY	B.G.	MODEL	TR-5001
PRODUCT	PANEL PC		REVISION		
FINISH	Transduction		CHECKED BY	NTS	
TITLE	CUTOUT			DRAWING No	B-326

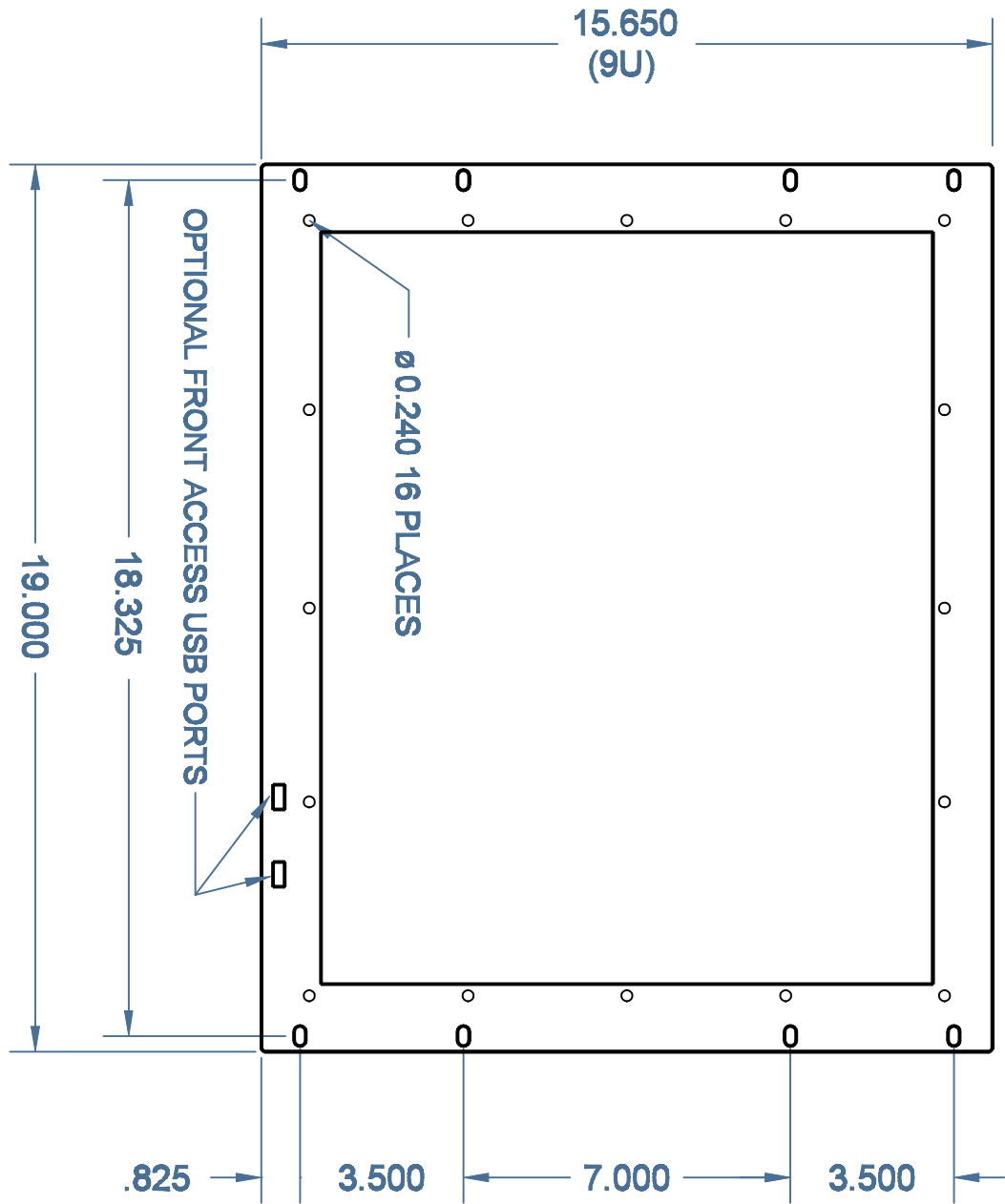

DATE	11-06-2004	DRAWN BY	B.G.	MODEL	TR-5001-RM
FINISH	RACKMOUNT VERSION	CHECKED BY	NTS	SCALE	
TITLE	RACKMOUNT PLATE	DRAWING No	B-345		
	Transduction				

SLIM DVD/CD RW DRIVE

17.250

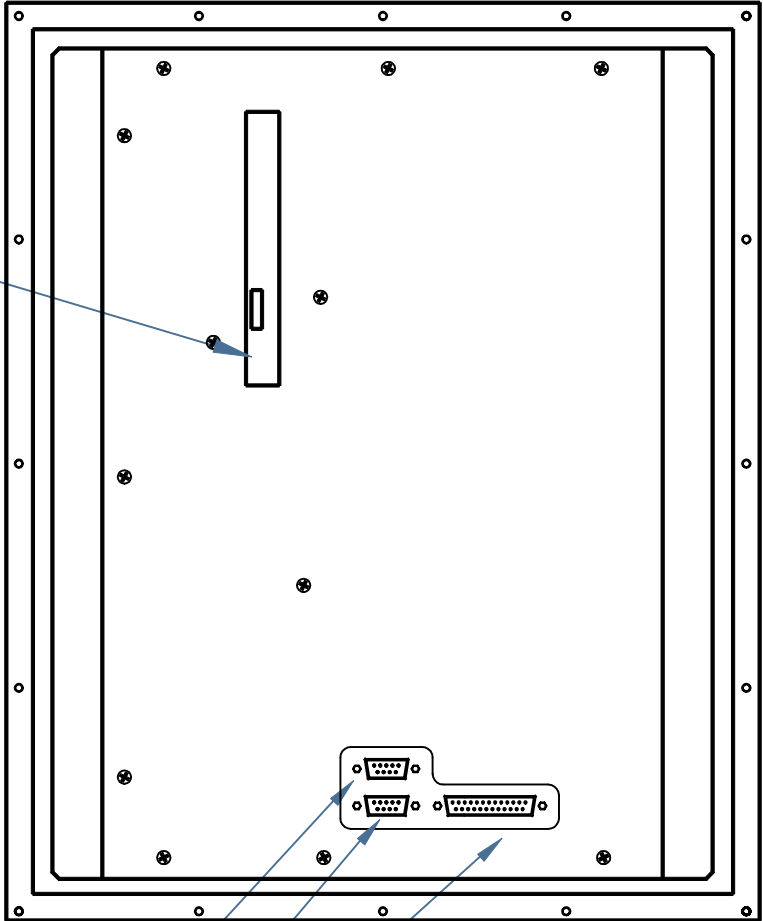

14.250

LPT  
COM1  
COM2

## REAR VIEW

DATE	11-06-2004	DRAWN BY	B.G.	MODEL	TR-5001
FINISH	PANEL PC		Transduction	CHECKED BY	NTS
TITLE	LAYOUT		DRAWING No	B-345A	

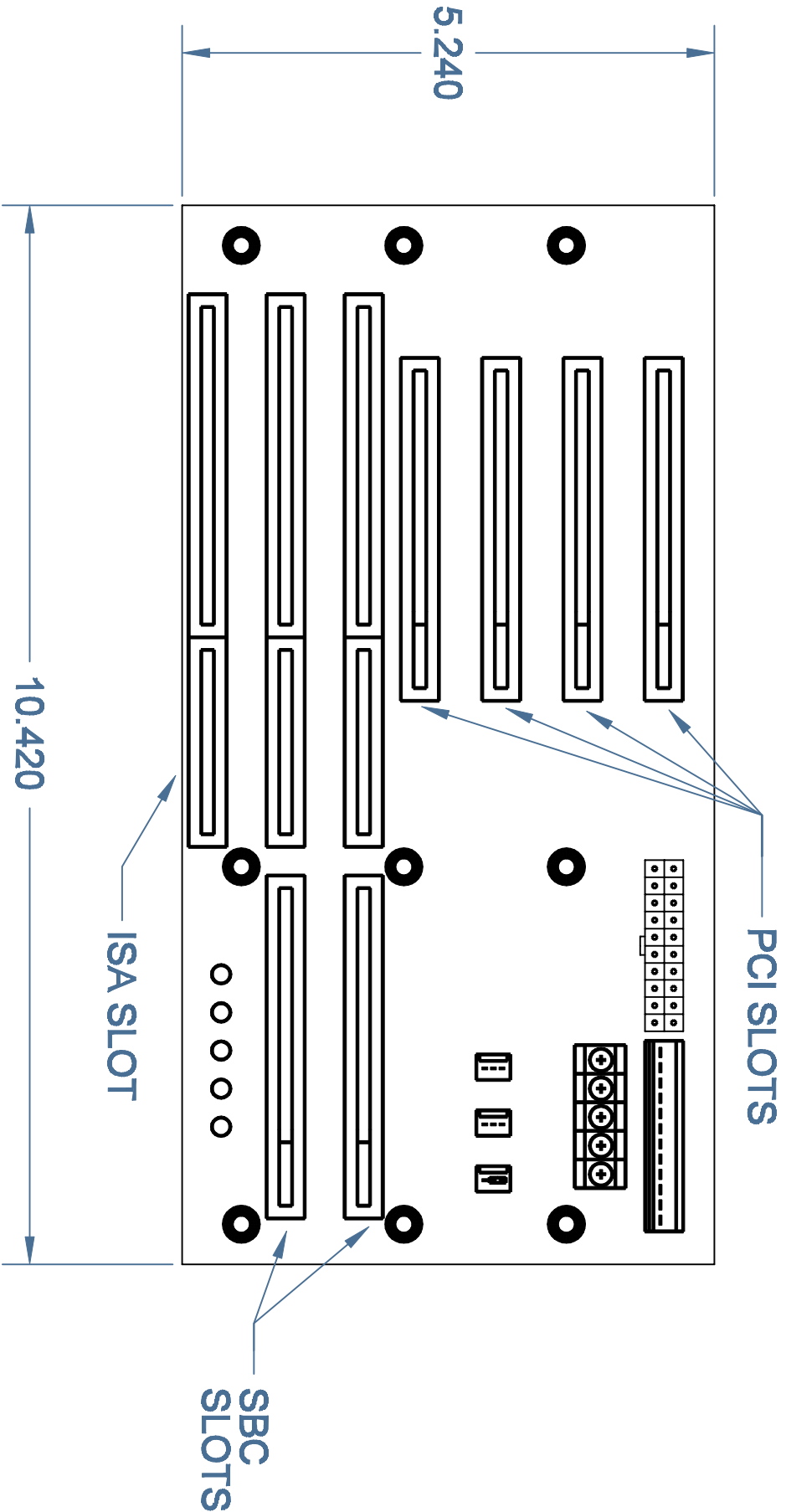

**NOTE: ALL DIMENSIONS IN INCHES**

DATE	03-02-2005	DRAWN BY	B.G.	MODEL	PCI-6S
FINISH		REVISION		SCALE	NTS
TITLE	LAYOUT	DRAWING No	B-366	CHECKED BY	NTS

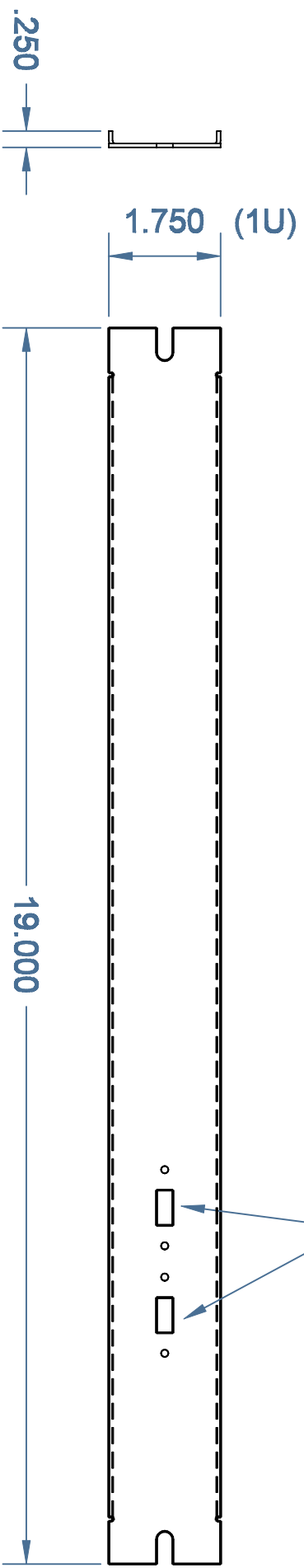

**SIDE VIEW**

**FRONT VIEW**

DATE	06-22-2009	DRAWN BY	B.G.	MODEL	1U USB FILLER
FINISH	SANDTEX BLACK PAINT	Transduction		CHECKED BY	NTS
TITLE	LAYOUT	DRAWING No	B-436		



## Free Manuals Download Website

<http://myh66.com>

<http://usermanuals.us>

<http://www.somanuals.com>

<http://www.4manuals.cc>

<http://www.manual-lib.com>

<http://www.404manual.com>

<http://www.luxmanual.com>

<http://aubethermostatmanual.com>

Golf course search by state

<http://golfingnear.com>

Email search by domain

<http://emailbydomain.com>

Auto manuals search

<http://auto.somanuals.com>

TV manuals search

<http://tv.somanuals.com>