

M
O
B
I
L
E

NEXT BASE[®]

MODEL NO.
TV850F
OPERATING INSTRUCTIONS

E
N
T
R
T
A
I
N
M
E
N
T

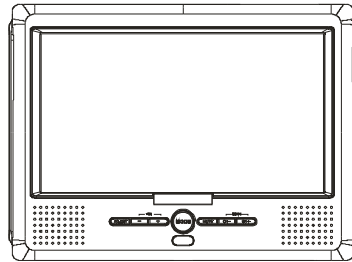

DVB
Digital Video
Broadcasting

Thank you for purchasing this TV850F tablet digital / analog TV.
Please read this manual carefully before operating your unit and keep it handy for future reference. It will be helpful to you if you encounter any operational problem.

IMPORTANT SAFETY INSTRUCTIONS

1. Read these instructions.
2. Keep these instructions.
3. Heed all warnings.
4. Follow all instructions.
5. Do not use this unit near water.
6. Clean only with dry cloth.
7. Do not block any ventilation openings. Install in accordance with the manufacture's instructions.
8. Do not install the unit near any heat sources such as radiators, heat registers, stoves, or other apparatus including amplifiers that produce heat.
9. Position the cables well so that they cannot be walked on or pinched by items placed on or against them.
10. Do not dispose of the unit into fire, to prevent the danger of explosion.
11. Refer all servicing to qualified service personnel. Servicing is required when the apparatus has been damaged in any way.
12. Only the original AC-DC adapter can be used.
13. Do not defeat the safety purpose of the polarized or grounding-type plug. A polarized plug has two blades with one wider than the other. A grounding type plug has two blades and a third grounding prong. The wide blade or the third prong are provided for your safety. If the provided plug does not fit into your outlet, consult an electrician for replacement of the obsolete outlet.
14. Unplug this apparatus during lightning storms or when unused for long periods of time.
15. Do not expose this appliance to rain or moisture, dripping or splashing and that no objects filled with liquids, such as vases, or naked flame sources, such as candles, shall be placed on the unit.

WARNING :

- *Please note that this unit may not receive analog TV signal well if using in a moving vehicle.
- *Do not touch the antenna with your hands while scanning the TV channel. Doing so would lower down the receiving quality.

CAUTION:

Do not take the unit apart. No user serviceable parts inside. Do not perform any servicing other than contained in this operating instructions unless you are qualified to do so. These servicing instructions are for use by qualified service personnel only.

NOTICES:

1. Fully charge the Ni-MH battery before using it for the first time or reusing it after being stored for a long period. It would need 3 to 5 circles of charging and discharging operations to get the optimum performance of the battery.
2. The surrounding temperature has much to do with the charging efficiency and should be between 0°C and 40°C. The charging performance will be in the most efficient state from 10°C to 30°C.
3. It is suggested to carry out the actions of charging and discharging the battery at least every one or two months if the battery is stored for a long time. Fully recharge it again to be stored. This action can avoid the leakage or the bad performance of the battery for its self-discharging action.

IMPORTANT SAFETY INSTRUCTIONS	
IMPORTANT SAFETY INSTRUCTIONS.....	1
PACKAGE CONTENTS	
PACKAGE CONTENTS	4
PARTS IDENTIFICATION	
MAIN UNIT.....	5
MAIN UNIT CONTROL SECTION.....	5
MAIN UNIT LEFT SIDE.....	6
MAIN UNIT RIGHT PANEL.....	7
MAIN UNIT REAR SIDE.....	8
HOW TO STAND.....	8
REMOTE CONTROL.....	9
KEY DESCRIPTION OF REMOTE CONTROL.....	10
NOTES ON USING THE REMOTE CONTROL UNIT.....	11
REPLACING THE BATTERY.....	11
DTV PARTS IDENTIFICATION	
SPECIAL KEYS.....	12
USB PLAYBACK OPERATIONS	
USING THE USB PORT.....	15

DTV MENU	
GENERAL STEPS OF SETUP.....	17
DTV CHANNEL	
TV CHANNELS AND RADIO CHANNELS	18
FAVORITE.....	18
DTV CONFIGURATION	
SYSTEM SETTING.....	20
AUTO SCAN.....	25
MANUAL SCAN.....	25
GAME	
BOXMAN.....	26
BURNING TETRIS.....	26
HIT RAT.....	27
FM INSTRUCTIONS	
FM.....	28
OTHERS	
DIMENSION AND PARAMETER.....	30
TECHNICAL INFORMATION	
TROUBLE SHOOTING.....	31

PACKAGE CONTENTS

After unpacking, first check that all the accessories listed below are included:

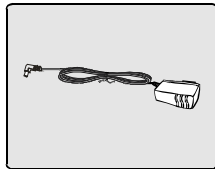

AC / DC adapter

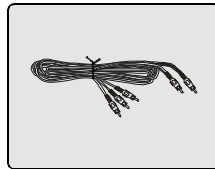

Audio and video cables

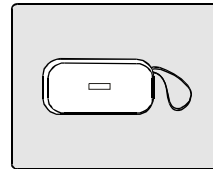

Accessory bag

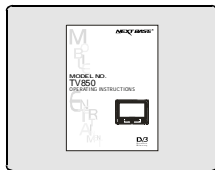

Operating manual

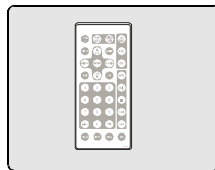

Remote control



Carrying bag

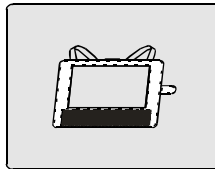

Car bag



Mini-magnetic Antenna

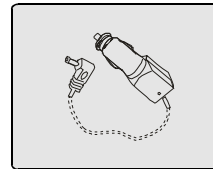

Car power cable

NOTES: Actual products' appearance might vary slightly from the pictures shown.

MAIN UNIT

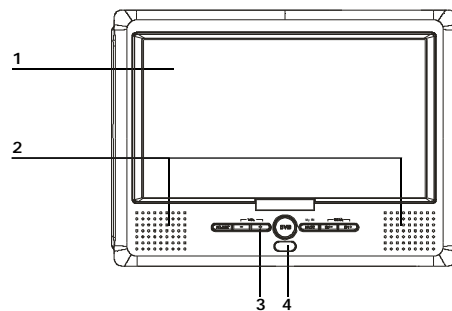
**1. Liquid crystal display****2. Speakers****3. Control section**

Control buttons.

4. Remote control sensor

The remote control signals are received from here.

MAIN UNIT CONTROL SECTION

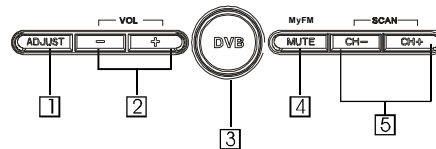
**1. ADJUST button**

Press it to enter the adjustment menu. Use the +/- button to choose the Picture /OSD/ FM/ EXIT items, then press the ADJUST button to enter you want .Then use the +/- and ADJUST buttons to handle what you want to do.

1. Picture ()

CONTRAST: Level 0 to 8.
BRIGHTNESS: Level 0 to 8.
SATURATION: Level 0 to 8.
SCREEN SIZE: Switch screen between 16:9 and 4:3.
DISPLAY MODE: Switch screen between normal and rotate.



2. OSD ()

OSD languages: English, French, German, Spanish and Italian.
 OSD Timeout : Level 10 to 60.
 Transparency: Level 0 to 7.

3. FM ()

See the detail in page 28.

2. - / + button

In the menu state, they are used as down and up button. If not, they are used as volume control button.

3. DVB button

In the AV IN/USB state, press it to enter DVB. In the DVB state, it is an invalid button. Press it for 3 seconds it will close the the TFT, then press any key can open the TFT again.

4. MUTE(My FM) button

Press it to mute the audio press it again the mute is cancelled. If you hold it on for 3 seconds it will turn on the FM , then the second time you do the same thing it will turn off the FM.

5. CH-/CH+ button

Press these two buttons respectively to channel down/up.
 Press them simultaneously to go to the AUTO SCAN.

MAIN UNIT TOP PANEL

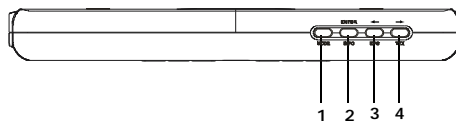

1. MODE button

Press it to choose DVB/AV IN/ USB mode.

2. INFO button(ENTER)

Press it once to show the primary program information menu. Press it twice to show the particular program information menu and then press it again to exit from the interface.
 It is only useful for the USB operation as the enter button.

3. EPG button (←)

Press it to show the electric program menu, press it again to exit from it. It is only useful for the USB operation as the left button.

4. TTX button (→)

Press it to show the teletext information menu. It is only useful for the USB operation as the right button.

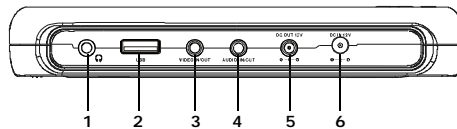
MAIN UNIT LEFT PANEL**1. EARPHONE jack**

For connecting a stereo earphone or an amplifier.

2. USB jack

Support USB 1.1 use.

3. VIDEO IN/OUT jack

Input or output video signals to the connected device by setting AV IN/OUT mode value.

The included AV cable is connected here.

4. AUDIO IN/OUT jack

Input or output audio signals to the connected device by setting the AV IN/OUT mode value.

The included AV cable is connected here.

5. DC OUT

DC OUTPUT.

6. DC IN

Connect the included AC adapter here.

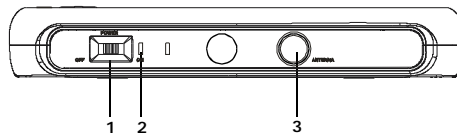
MAIN UNIT RIGHT PANEL

1. POWER ON/OFF switch

Push the button to "ON" or "OFF" to turn on or turn off the power.

2. POWER indicator

The LED will be red when the unit is on.

3. ANTENNA Jack

DVB-T type aerial input.

MAIN UNIT REAR SIDE

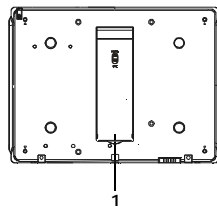

1. Support

The unit can stand with this device.

HOW TO STAND

1. Pull out the support.
2. Draw out the support to a proper position .
3. Push down the button to lock it.

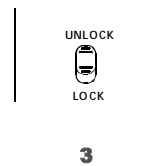
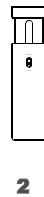
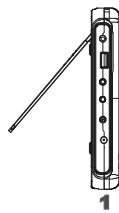

REMOTE CONTROL

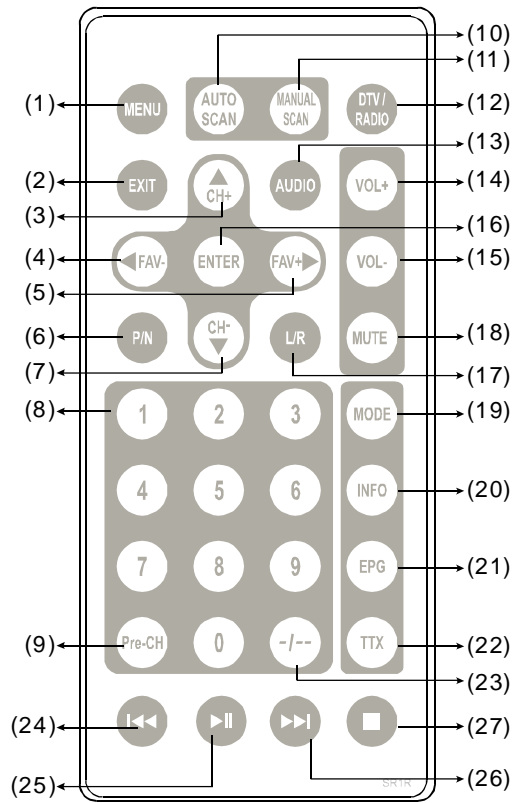

KEY DESCRIPTION OF REMOTE CONTROL

- | | |
|--|--|
| <p>1. MENU
Press it to show the menu.</p> <p>2. EXIT
Exit from the current item.</p> <p>3. CH+/UP
Press it to change channels up or move the cursor up.</p> <p>4. FAV-
Switch to previous favorite program if you have setted some programs as your favorite programs. If not, it is invalid key.</p> <p>5. FAV+
Switch to next favorite program if you have setted some programs as your favorite programs. If not, it is invalid key.</p> <p>6.P/N
Output the TV type.</p> <p>7. CH-/DOWN
Press it to change channels down or move the cursor down.</p> <p>8. DIGITS
Number keys.</p> <p>9. Pre-CH
Jump back to the previous channel.</p> <p>10.AUTO SCAN
Automatic search.</p> <p>11.MANUAL SCAN
Manual search.</p> <p>12.DTV/RADIO
Choose TV program or radio program.</p> <p>13.AUDIO
Multi-track selection.</p> | <p>14.VOL+
Volume up.</p> <p>15.VOL-
Volume down.</p> <p>16.ENTER
Confirm the selection action.</p> <p>17.L/R
Switch the audio channels.</p> <p>18.MUTE
Audio mute on/off.</p> <p>19. MODE
Press it to pop out the play modes selecting menu:DVB-T/ AV IN.</p> <p>20.INFO
To display program information.</p> <p>21.EPG
Electronic Program Guide.</p> <p>22.TTX
Show the teletext information.</p> <p>23.-/--
Press this button to select channel numbers of one figure or double digits.</p> <p>24. ◀◀
It is fast backward key when play the USB files.(Invalid in DVB-T state)</p> <p>25. ▶▶
Press it to play or pause playback of USB files.(Invalid in DVB-T state).</p> <p>27. ■
Press it to stop playback of USB files. (Invalid in DVB-T state)</p> <p>26. ▶▶
It is fast forward key when play the USB files. (Invalid in DVB-T state)</p> |
|--|--|

NOTES ON USING THE REMOTE CONTROL UNIT

- Do not drop or step on the remote control unit or subject it to shocks.
- Note that the remote control unit may not work if there are obstacles between it and the remote sensor.
- Do not expose the remote sensor to strong light. Doing so may make operation impossible.
- Use the remote control unit within the specified operating range.

REPLACING THE BATTERY

1. Insert your finger nails into A and B on the diagram below. Press A according to the direction, then pull out the battery holder.

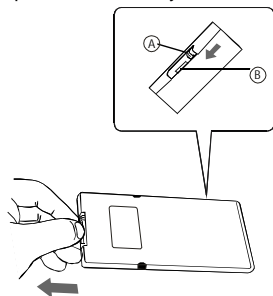

2. Remove the old battery, then insert the new battery into the battery holder with the + side facing upwards.

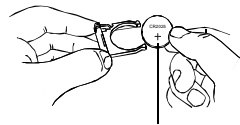

Lithium battery (CR2025)

3. Fit the battery holder back to its place.

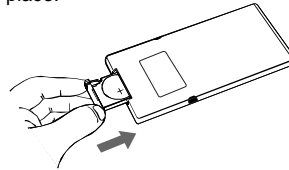

NOTE:

- To prevent leakage of fluid from the lithium battery, remove the battery when not using the remote control unit for long periods of time (One month or more). If the battery leaks fluid, carefully wipe it out of the battery case, then change to a new lithium battery.
- Caution: The battery may present a risk of fire if mistreated. Do not recharge, disassemble, heat above 100 °C. Replace battery with same type.
- Dispose of used battery properly, keep away from children and do not dispose of in fire.

SPECIAL KEYS

EPG (Electronic Program Guide)

A quick program guide that the user can easily move up/down to view the brief description of the selected program.

Press the EXIT button or the EPG button again to exit from this interface.



If the current channel is scrambled, the prompt message "scrambled channel." will appear on the screen.

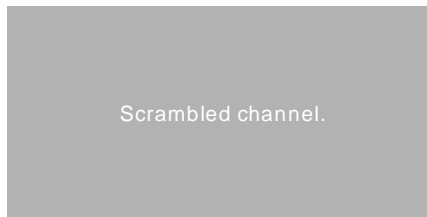

L/R

Press this button to change the audio channels at non-menu status.

- ▶ Stereo
- ▶ Left
- ▶ Right



MANUAL SCAN

Perform program scanning. (Found programs will be appended to the program list.)

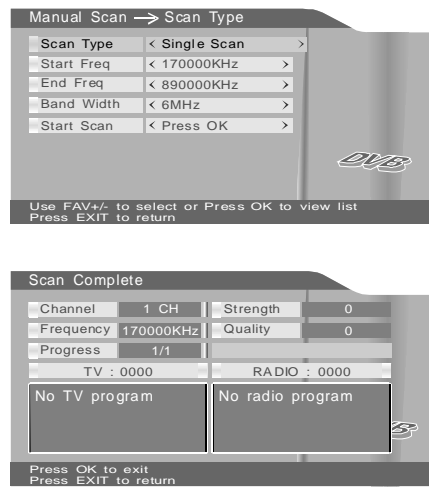

There are 4 items:

- Scan Type: Range Scan and Single Scan.
- Start Freq: Input the start frequency of your preferred scan range.
- End Freq: Input the end frequency of your preferred scan range.
- Band Width: 6MHz, 7MHz and 8MHz.

You can use **↑ ↓ ← →** buttons to select the options with your actual need.
Press OK to start scanning.

NOTE:

If Single Scan is your selection, you cannot edit the End Freq but only the Start Freq as the appointed scanning frequency.

INFO

Press this button to bring forth the primary program information.

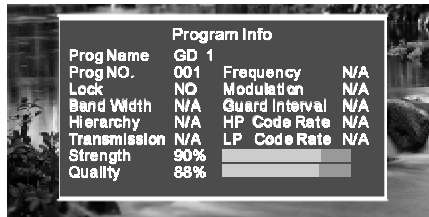

Press this button twice to bring forth the particular program information, and press it again to exit from this interface .

**AUDIO**

Audio channel information displays.



USING THE USB PORT

Only in the DTV status can it read the MP3, JPG, BMP and MPEG files stored in a USB device which is plugged into the USB port on the left side of the unit.

1. If a USB device is connected before the unit is turned on, there will be a prompt message shown on the screen, press the \leftarrow/\rightarrow and ENTER buttons on the remote control or on the top panel of the main unit to select the media.
2. If the unit is playing TV when a USB device is connected, there will be a prompt message shown on the screen for selecting the media.



3. During the playback of MP3 and MPEG or at the stopping state of JPG and BMP files ,the following picture will appear:

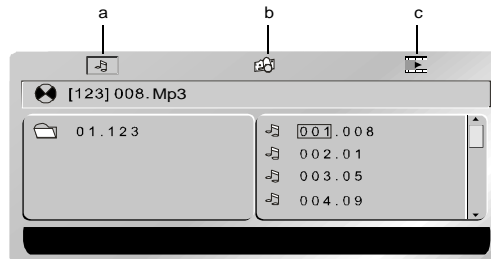

- a. **MP3 ICON**
- b. **JPG and BMP ICON**
- c. **MPEG ICON**

- USE ↑/↓/←/→ keys to move the cursor to a folder, a file ,MP3 ICON, JPEG ICON or MPEG ICON.
 - Press OK to enter the folder or play the file highlighted.
 - You can press ↑/↓/←/→ keys to rotate or flip the picture when you are viewing the JPG or BMP files.
 - You can control the playback of USB files by pressing ►/■/◀/▶ keys.
4. If there is a USB device connected, you can enter the media selecting interface by pressing the EXIT button during the playback of USB or TV.

NOTE:

1. The unit may not work properly if using USB connecting cable. Suggested not to use it.
2. Support USB 1.1 .
3. The USB function cannot be available in AV IN state.

GENERAL STEPS OF SETUP

1. Press the MENU key on the remote control to bring "main menu".
There are three classifications: DTV Channel, Configuration and Game .

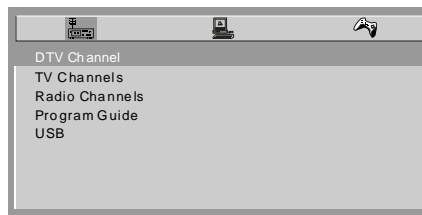

2. Press ◀ and ▶ buttons to highlight the icon of the desired page, then press the Down or Up button to activate that page.

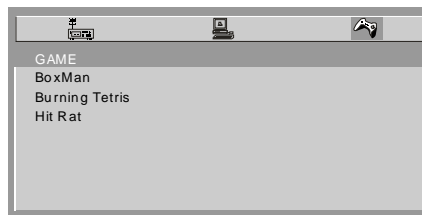

3. Press ▲ and ▼ buttons to highlight the desired option. Press OK to select.

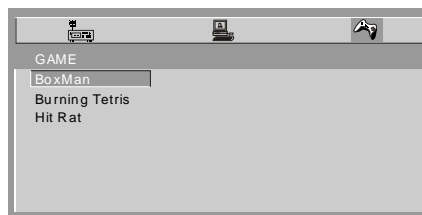

4. You can press MENU or EXIT again to exit MENU.

TV CHANNELS AND RADIO CHANNELS

There are two different kinds of channels: TV Channels and Radio Channels. You can manage the current channels by labeling your favorites, deleting the non-favorites, moving the program's order and locking the channels. The default is FAVORITE. If there are no programs saved in the database when entering TV Channels or Radio Channels, the prompt message "No TV channels." or "No radio channels." will pop out and disappear within several seconds.

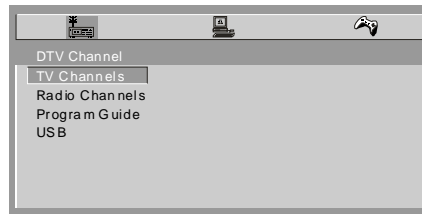

FAVORITE

If you often watch some specific programs and wish to get to these programs quickly, you can label these to be your favorites through the program management actions. You can enter the FAVORITE interface by pressing the MENU button on the remote control to enter the main menu, then press the "↓" button to choose the "TV channel" item under the DTV channel. Press the "←" button to enter the FAVORITE interface. Exit after finishing the favorite programs selection action, you can use the remote control to select your favorite program conveniently.



- You can use **↑** and **↓** buttons to select any programs at FAVORITE management status.
- If the selected program is not labeled with the FAVORITE symbol, you can set it as your favorite program by pressing the OK button and the FAVORITE symbol will appear behind the program name.
- If the selected program has already been labeled, press the OK button to cancel the symbol.
- You can set multi-program to be your favorites at the same time.

Choose "Configuration" item and you will see that there are three options for selecting:
System Setting, Auto Scan and Manual Scan.

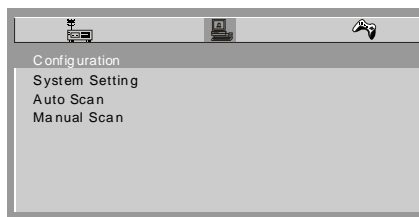

SYSTEM SETTING

Use ↓ and ↑ buttons to select your need. Then press OK key to bring forth all the options for selecting.

OSD LANGUAGE

Seven available OSD languages:

- ▶ English
- ▶ Deutsch
- ▶ Español
- ▶ Français
- ▶ Português
- ▶ Italiano
- ▶ Nederlands

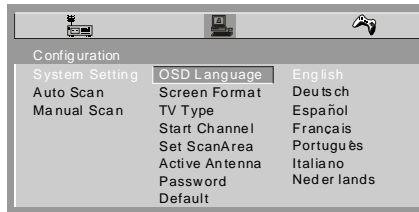

The default is English.

SCREEN FORMAT

Choose the right screen format depending on your equipment. Three options for choosing:

- ▶ 4:3PS (Pan & Scan)
- ▶ 4:3LB (Letter Box)
- ▶ 16:9 (Wide Screen)

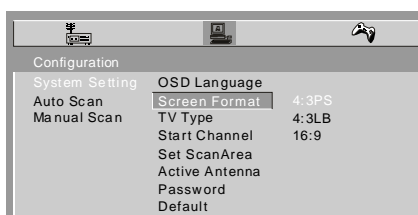
**NOTE:**

If the screen format is incorrectly set, the images on the screen might be distorted or clipped out. Therefore, adjust the screen format wisely in order to get the perfect video display.

The default is 4:3PS.

TV Type

Select the TV type. (Auto means the output signal format will be changed automatically according to the received signal.)

- ▶ NTSC
- ▶ PAL
- ▶ AUTO

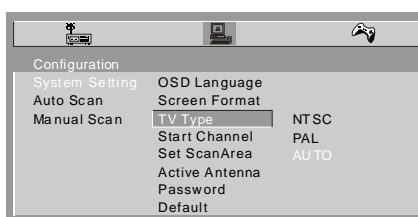

The default is AUTO.

Start Channel

If you want to watch the same channel each time the unit is turned on, you can set the First Channel here.

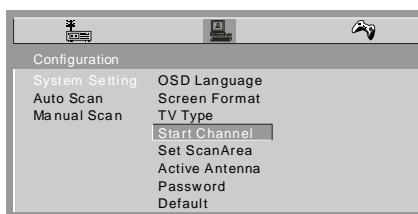

After pressing OK in the Start Channel state, the following picture will appear:

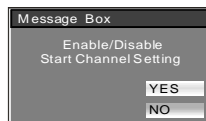

Choose "YES" to show all the channels for selecting or "NO" to exit.

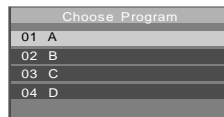

You have to select one of them to be the First Channel when the unit is turned on. The default is NO.

- The selection action will be saved and become effective when turning on the unit next time.
- The First Channel will be closed automatically if the selected channel is deleted after the next scanning.
- The First Channel will remain to be the same channel even when the First Channel is moved.
- If there is no selected First Channel, the last-playing channel will become the First Channel when turning on the unit next time.

SET SCAN AREA

Select the proper region according to the place you are located. After setting, press the AUTO SCAN key to scan the channels going on this region premise.

- ▶ Germany
- ▶ England
- ▶ Italy
- ▶ France
- ▶ Spain
- ▶ Holland
- ▶ Taiwan
- ▶ China
- ▶ Norway
- ▶ Sweden
- ▶ Finland
- ▶ Portugal
- ▶ Others

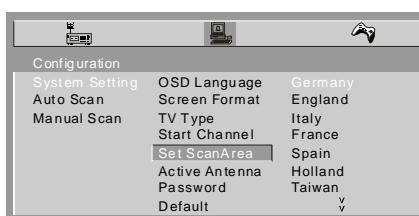
**ACTIVE ANTENNA**

This function will help the unit get a better TV signal with the active antenna turned on.

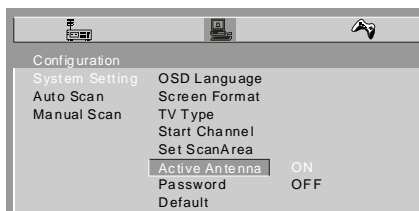

The default is ON.

PASSWORD

Renew your password here.

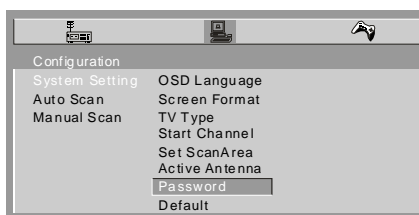

1. Input your old password first.

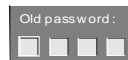

2. Enter the new password.



3. Confirm your new password.



NOTE:

1. If the confirmed password differs from the new password, you have to reenter them until the two are the same.
2. The default password is 0000.

DEFAULT

Resume the factory settings.

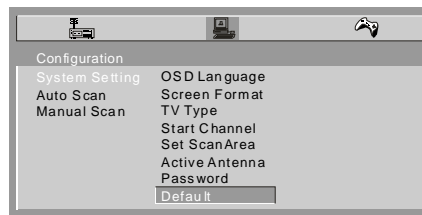

After pressing OK in the Default state, the following picture will appear:

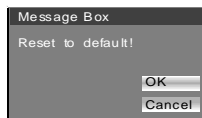

NOTE:

The default settings action will resume all the factory settings, including the deletion of all the saved programs.

AUTO SCAN

Auto scanning.

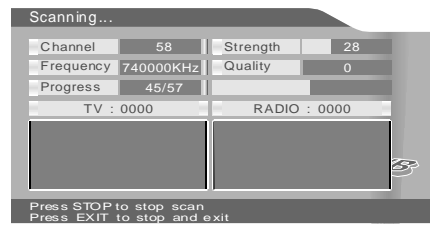

NOTE:

Press STOP to stop scanning and EXIT button to exit.

MANUAL SCAN

Please refer to Special Keys.(Page 13)

Get to the game function from the main menu. You will find three kinds of games in DTV state.

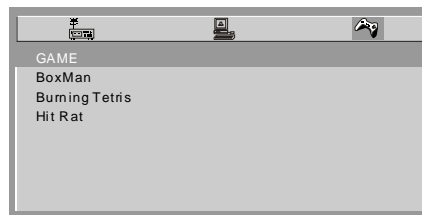

BOXMAN

Use ↑, ↓, ← and → buttons to control the little man to move the boxes to the appointed place. Only one box can be moved at a time.

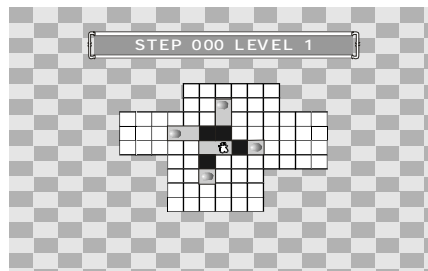

Press the MENU key to replay the current game and the OK key to play the higher level.
Press EXIT to quit at any time.

BURNING TETRIS

1. Use ← and → to move Tetris left and right.
2. Press ↑ to shift the direction of the Tetris.
3. Press ↓ to accelerate the Tetris downwards.

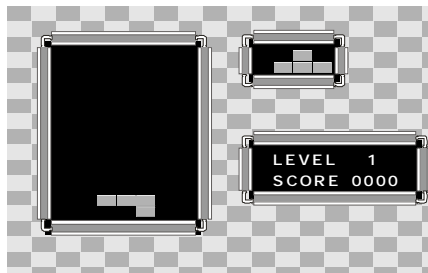

Press the MENU key to replay the current game and the OK key to pause/play the higher level.
Press EXIT to quit at any time.

HIT RAT

Press 1,2,3,4,5,6,7,8,9 to hit the rat according to its corresponding directions of where it appears on the screen.
Press EXIT to quit at any time.



FM

1. Press the "ADJUST" button to pop out the menu of adjustment, OSD and FM.
2. Use the - / + buttons on the main unit board or remote control to choose FM, then press ADJUST enter button.

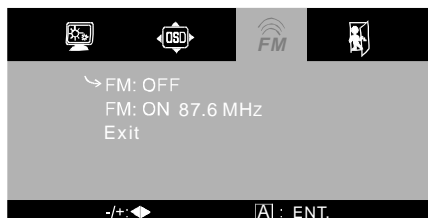

3. Use the - / + buttons to choose "ON", then press ADJUST enter button to enter frequency input mode.



4. There are two frequency input modes: one is to input numbers directly; the other is to increase or decrease frequencies by the direction buttons. Press the +/- buttons to move right/left to choose the number inputted place and press the ADJUST button to confirm. Then press the +/- button to increase /decrease the frequency number and press the ADJUST button to confirm the inputted number.



5. The input frequency range is from 87.6-107.9MHZ. The default is OFF.
6. If the input frequency is bigger than the maximum frequency it will output with the 107.9MHZ frequency. If the input frequency is smaller than the minimum frequency it will output with the 87.6 MHZ frequency.
7. Press ADJUST button to save the choice after selecting the preferable frequency within the permissible range. Then the player will transmit audio signal according to this frequency. Choose "OFF" to turn off the FM function.
8. Adjust your receiving set (eg. car stereo) to the corresponding frequency to receive the transmitted audio signal from the player.
9. The transmission range will be within approximately 3 meters.

DIMENSION AND PARAMETER

Product name:	TV850F
Power supply:	DC 12V
Dimension:	230 x 170 x 26mm
Net weight:	635g

TROUBLE SHOOTING

Phenomenon	Solution
No sound	<ol style="list-style-type: none"> 1. Check that the unit has been turned on, and that the volume wheel is turned up. 2. Please scan channels before watching. 3. Check antenna is connected and working OK. 4. Check setup for correct TV regional setting system.
No picture	<ol style="list-style-type: none"> 1. Check that the unit has been turned on. 2. Please scan channels before watching. 3. Check antenna is connected and working OK.
Sounds only with no picture	<ol style="list-style-type: none"> 1. This phenomenon may appear when playing with the low-capacity battery. 2. Please recharge the battery fully to be played once again.
Bad image	<ol style="list-style-type: none"> 1. This phenomenon may appear when using in a moving vehicle. 2. Please replace the antenna to another place with a stronger signal. 3. Check that the settings of the TV system are right.
Low volume	<ol style="list-style-type: none"> 1. Position the volume setting of the unit to a suitable level.
No channel can be searched	<ol style="list-style-type: none"> 1. The antenna may not be connected well. 2. Wrong regional setting . 3. Channels setting may be encrypted at your location.

DAMAGE REQUIRING SERVICE

Have the unit serviced by a qualified service technician if:

- The unit has been exposed to rain or water.
- The unit does not seem to operate normally.
- The unit exhibits a marked change in performance.

DO NOT ATTEMPT TO SERVICE THE UNIT BY YOURSELF!

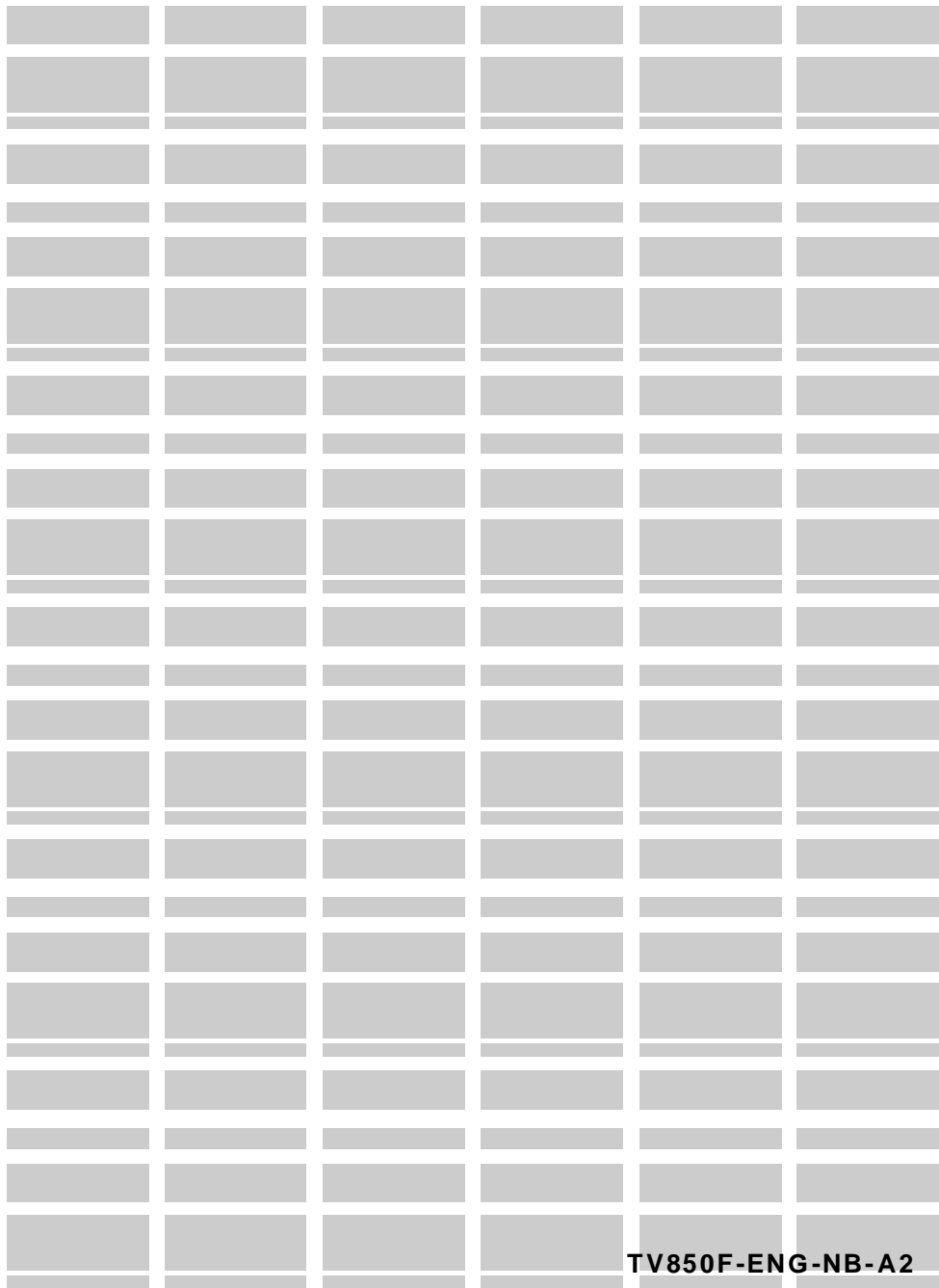

TV850F-ENG-NB-A2

Free Manuals Download Website

<http://myh66.com>

<http://usermanuals.us>

<http://www.somanuals.com>

<http://www.4manuals.cc>

<http://www.manual-lib.com>

<http://www.404manual.com>

<http://www.luxmanual.com>

<http://aubethermostatmanual.com>

Golf course search by state

<http://golfingnear.com>

Email search by domain

<http://emailbydomain.com>

Auto manuals search

<http://auto.somanuals.com>

TV manuals search

<http://tv.somanuals.com>