

**Nextel<sup>®</sup>**

**iDEN<sup>®</sup>**

*Digital Multi-Service Data-Capable Phone*

***i700plus*<sup>™</sup> Phone User's Guide**



NTN9368-A

---

## ***i700plus* Phone Features Bookmark**

You can use this fold-out diagram as a bookmark, making it easy to refer to while you learn to use your *i700plus* phone.

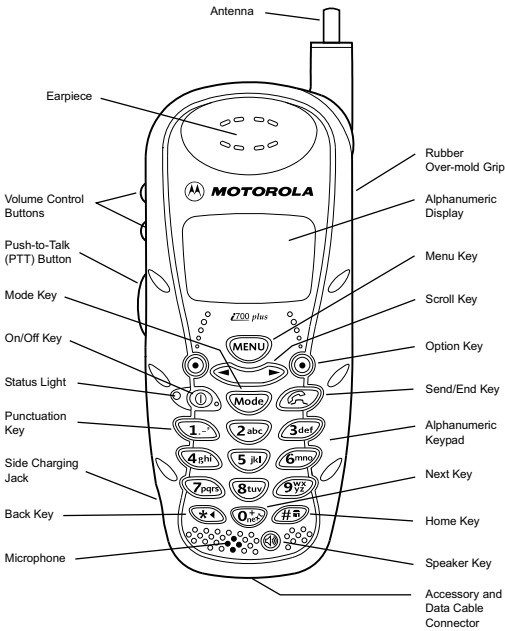

### **Learning to Use Your *i700plus* Phone**

- |          |  |
|----------|--|
| <b>1</b> | Tear off the Quick Reference Card located on the back cover, complete the information and keep it handy. |
| <b>2</b> | Read Safety and General Information.   |
| <b>3</b> | Familiarize yourself with the Table of Contents.   |
| <b>4</b> | Read Getting Started, which includes a Quick Guide to <i>i700plus</i> Phone Functions.                   |
| <b>5</b> | View the <i>i700plus</i> Phone Video included in the box.  |

**NOTE:** Remove the plastic film lens protector from the display.

**NOTE:** The display backlight is activated by pressing any key or button.

---

# Table of Contents

<b>Introduction .....</b>	<b>1</b>
Welcome to Nextel® .....	1
Questions? .....	3
Driver Safety .....	3
Nextel Business Solutions.....	4
<b>Getting Started .....</b>	<b>5</b>
About This Section .....	5
Batteries .....	5
Attaching the Battery .....	6
Detaching the Battery .....	6
Charging the Battery .....	6
Battery Charging Status .....	7
Turning Your <i>i700plus</i> Phone On/Off.....	7
Activating Your <i>i700plus</i> Phone.....	8
Your Nextel Phone Status.....	8
Keypad Lock .....	9
Activating Keypad Lock .....	9
Receiving Incoming Calls.....	9
Receiving New Message Mail.....	10
Receiving Voice Mail.....	10
Receiving Nextel Direct Connect® Calls.....	11
Deactivating Keypad Lock .....	11
Display Icons.....	12
Modes and Menus .....	13
Quick Guide to <i>i700plus</i> Phone Functions.....	14
Phone Mode .....	14
Private Mode .....	15
Group Mode .....	15
Net Mode .....	15
<b>Creating, Editing and Using Stored Lists .....</b>	<b>17</b>
About This Section .....	17
Phone Based .....	17
Storing Names and Numbers .....	17
Pause Digit Entry .....	19
Editing Stored List Entries .....	20
Edit a Phone Number or Associated Name or Speed Dial Number .....	20
Edit a Private ID or Associated Name .....	20

---

Erasing List Entries .....	21
List Manager .....	21
iDEN Organizer .....	24
<b>Phone Mode .....</b>	<b>25</b>
Digital Cellular .....	25
About This Section .....	25
Making Domestic Phone Calls .....	25
Direct Dial .....	25
Making Phone Calls From the Stored List.....	26
Automatic Redial .....	27
Emergency Calling .....	27
Special Dialing Codes .....	27
Placing International Phone Calls .....	27
Plus Dialing .....	28
Receiving a Phone Call .....	28
Missed Call Indicator.....	28
Retrieving a List of Missed Calls .....	28
Last 10 Numbers Received/Sent Calls List.....	29
Quickstore of Phone Numbers .....	29
Ending a Phone Call .....	30
Standard Features .....	30
Call Hold .....	30
Call Forwarding.....	30
Call Waiting.....	32
Three-Way Calling .....	33
Additional Phone Services .....	33
Alternate Line Service .....	34
Call Restrictions .....	35
Caller ID .....	35
Directory Assistance .....	36
Nextel Voice Mail Service .....	38
About This Section .....	38
Setting Up Your Voice Mail Box .....	38
Using Voice Mail .....	39
Logging Into Voice Mail.....	39
Main Voice Mail Menu.....	40
Playing Messages .....	40
Saving and Deleting Messages.....	41
Changing Your Password .....	41
Recording Your Name.....	42
Recording Your Active Greeting.....	42
Receiving Voice Mail Messages .....	43
New Message Indicators.....	43

---

Transferring Calls to Voice Mail .....	43
Alert Receipt .....	43
Advanced Voice Mail Features .....	44
Automatic Playback .....	44
Changing the Playback Order of Messages.....	44
Greeting Schedule .....	45
Working With Group Lists .....	46
Recording, Copying and Replying to Messages .....	47
Recovering Deleted Messages .....	50
Message Forwarding .....	50
Pager Notifications.....	51
Paging and Messaging Services.....	53
About This Section .....	53
Nextel Online Two-Way Messaging <sup>SM</sup> .....	54
Text and Numeric Paging .....	54
Notification of New Pages .....	55
Alert Receipt .....	55
Accessing New Pages .....	55
Viewing a Page Immediately .....	55
Viewing a Page Later.....	56
Viewing Stored Pages.....	56
Sending a Page .....	56
Web Paging (Web Messaging) .....	57
Email Paging.....	58
Numeric Paging .....	58
Operator Assisted Paging .....	58
Using Your Phone as a Modem .....	59
<b>Private/Group Mode .....</b>	<b>61</b>
Nextel Direct Connect® .....	61
About This Section .....	61
Displaying Your Private ID .....	62
Using the Private/Group Speaker .....	62
Turning the Speaker Off .....	62
Turning the Speaker On .....	62
Placing Private Calls .....	63
Entering the Private ID.....	63
Selecting a Name from a Stored List .....	63
Receiving Private Calls .....	64
Quickstore of Private IDs .....	64
Sending a Call Alert .....	64
Receiving/Responding to a Call Alert .....	65
Call Alert Queuing .....	65
Group Calls .....	66

---

Naming a Talkgroup.....	66
Making a Group Call .....	66
Receiving a Group Call .....	67
Group-Silent Programming .....	67
Turning Group-Silent On/Off .....	67
<b>Net Mode .....</b>	<b>69</b>
About This Section .....	69
Net Mode Navigation Keys.....	70
Changing the Phone Display .....	70
Launching the Microbrowser.....	71
Using T9® Text Input.....	72
Entering Characters, Numbers and Symbols .....	72
T9 Navigation Keys .....	72
Entering Text Using T9 Text Input (word mode) .....	73
Entering Text Using Alpha Mode & Adding Words to the User Database .....	74
Entering Punctuation and Symbols .....	75
Smart Punctuation .....	75
Symbols Mode (SYM).....	75
Numbers Mode (NUM) .....	76
Entering Email Addresses .....	76
Nextel Online Wireless Internet Services.....	77
MyApplications .....	77
Shopping .....	77
Sites .....	78
MSN Mobile .....	78
NextelServices .....	81
List Manager .....	81
Bookmarks .....	81
To Recall a Bookmark .....	82
To Delete a Bookmark .....	82
Search .....	82
Entering Internet Addresses .....	83
Frequently Asked Questions .....	84
<b>Customizing the i700plus Phone .....</b>	<b>87</b>
About This Section .....	87
Changing the Display Language.....	87
Setting the Time and Date .....	88
Backlight Timer .....	89
Setting the Ringer Volume .....	89
Selecting a Ring Style.....	90

---

Setting the VibraCall™ Feature .....	91
Using Vibrate Alert .....	91
Using Phone, Mail and Group/Prvt Vibrate Option .....	92
Programming Menus.....	92
Programming Menus Shortcut and Options .....	93
Ordering Information .....	98
Accessories.....	99
Batteries .....	99
Travel Chargers .....	100
Cigarette Lighter Adapter .....	101
Desktop Dual-Pocket Charger .....	102
Audio Adapter .....	105
Dash Mount Holder .....	106
Swivel Belt Clip .....	107
Leather Carry Case .....	107
Hands-Free Car Kit .....	108
<b>Other Important Information .....</b>	<b>111</b>
Nextel Customer Care.....	111
Understanding Status Messages .....	111
Nextel Terms and Conditions of Service.....	113
Terms and Conditions .....	113
Safety and General Information .....	117
Safety and General .....	119
Use While Driving.....	119
Cleaning and Drying Considerations.....	120
Antenna Considerations.....	120
Accessory Safety Information .....	121
Limited Warranty Motorola Communication Products.....	122
Patent and Trademark Information .....	128
<b>Index .....</b>	<b>129</b>





---

# Introduction

## Welcome to Nextel®

Thank you for choosing Nextel as your wireless communications provider. From virtually any state in the U.S., your *i700plus* phone enables you to enjoy crystal-clear connections through Nextel's All Digital National Network. But that's not all! The *i700plus* phone also includes upgraded software that lets you make international calls through Nextel Worldwide<sup>SM</sup> service. This means, whether you're traveling to Canada, Mexico City, Manila or Brazil, your Nextel phone will use **iDEN** networks to keep you in touch with business partners, colleagues or clients.

Before you get started, please refer to the "i700plus Phone Features Bookmark", attached to the front cover of this guide, which you can use as a placeholder. It has a picture of the *i700plus* phone with all of the components clearly labeled. Also, the back of this guide includes a topic Index to help you look up specific information throughout the guide.

This guide contains all the information you need to take full advantage of your Nextel service and *i700plus* phone, including:

Digital Cellular Calling—Nextel's All-Digital National Network lets you enjoy a crystal-clear connection, with built-in call security, every time you place a phone call. Digital Cellular Calling includes features such as Call Hold, Call Forwarding, Call Waiting, and Three-Way Calling. Find out more about placing calls in this section.	Page 25
Nextel Direct Connect®—An innovative feature for communicating instantly with one or more co-workers at a fraction of the cost of cellular. Read more about Nextel Direct Connect in this section.	Page 61
Text and Numeric Paging—Lets you receive numeric pages and important, short messages right over the phone. Learn more about Paging in this section.	Page 54
Voice Mail—Takes messages 24 hours a day and includes Message Forwarding, Automatic Playback and more. Read more about Voice Mail in this section.	Page 38

Additional Phone Services—Includes Alternate Line Service, Call Restrictions, Caller ID, and Enhanced Directory Assistance. Find out more in this section.	Page 33
Nextel Online Wireless Internet Services—Stay connected to the critical information you need to make business decisions and get business done.	Page 77
Dial-Up Service—Dial-Up capability without landline access. Also see “Nextel Online Dial-Up Service User’s Guide.”	Page 59
International Roaming—Enables you to make phone calls, check Voice Mail, and more while traveling in select cities internationally.	Page 27
Programming—At Nextel, we know one size doesn’t fit all—and this feature proves it! You can customize your <i>i700plus</i> phone and make it behave the way you want it to. Learn how in this section.	Page 87
Quick Guide to <i>i700plus</i> Phone Functions—Enables experienced digital cellular phone and two-way radio users to get started right away!	Page 14
Other Nextel Advantages—In addition to all of the previously mentioned benefits, there’s more...Nextel features also include the following: <ul style="list-style-type: none"><li>• The guaranteed All-Digital Nextel National Network</li><li>• No Roaming Fees while traveling throughout the U.S.</li><li>• One-second call rounding after the first minute</li><li>• Flat-rate long distance pricing to anywhere in the continental U.S.</li><li>• No landline connection charges</li></ul>	

**NOTE: Are you an experienced digital cellular phone and two-way radio user? Turn to the Getting Started section beginning on page 5. This section might be all you need to get started.**

For more information about Nextel or to view this guide on our Web site, visit us at [nextel.com](http://nextel.com).

## Questions?

Domestically, for customer care issues including billing issues, general service needs, or to order additional services, call Nextel Customer Care at 1-800-639-6111, or dial 611 from your *i700plus* phone.

To complement the *i700plus* phone and Nextel Worldwide Service, Nextel has also launched International Roaming Customer Care support. When traveling outside of the U.S. and Canada, call 1 (201) 531-5202 for your Customer Care Service needs. This Customer Care number will be toll-free from your Nextel handset both domestically and internationally.

International and Domestic Coverage, Rates and other information is also available at [nextel.com](http://nextel.com).

## Driver Safety

Safe driving is far more important than anything else. So please follow these tips for using your wireless phone when you're behind the wheel.

- 1 **Give driving your full attention.** Don't let anything interfere with your concentration.
- 2 **Assess road conditions** before making or taking a call.
- 3 **Let Voice Mail pick up** when you're in heavy traffic or hazardous road conditions.
- 4 **Program your most frequently dialed numbers** into your phone for Speed Dialing. When dialing manually without the Turbo Dial™ (one-touch dialing) feature, dial only when your vehicle is stopped—or have a passenger dial for you.
- 5 **Position your phone** where it is easy to see and reach.
- 6 **Keep your eyes on the road.** Never take notes while driving.
- 7 **Consider using a hands-free speakerphone,** which allows you to keep both hands on the wheel when speaking. Hands-free mobile accessories and car adapter accessories can be ordered by calling 1-800-914-3240, visiting [nextel.com](http://nextel.com) or contacting your Nextel Authorized Representative.
- 8 **Be a Good Samaritan.** Dial 9-1-1 in emergencies to report accidents, impaired or aggressive drivers, crimes or fires. It's a free call. Know your Nextel phone number, so emergency services personnel can call you back if necessary.



a safety reminder from  
**NEXTEL**

## **Nextel Business Solutions**

The *i700plus* phone and Nextel's All-Digital National Network join forces to provide the only office small enough to fit in your pocket. Below is a list of Nextel's all new innovative features developed for business people on the go!

*Ever wish you could take your assistant with you? The i700plus phone has the right business solutions for you.*

Personalized 24-hour Voice Mail, which takes messages when you're not available and a whole lot more. (For details see "Nextel Voice Mail Service" on page 38.) Schedule a Page helps you remember those important dates by sending a text message directly to your phone. (See "Web Paging (Web Messaging)" on page 57.)

*Ever head for a meeting and forget the company's address?*

Call Directory Assistance (For details see "Directory Assistance" on page 36.) Or, have your assistant send a text page to your *i700plus* phone. That's right, you can receive text and numeric pages right to your *i700plus* phone. (For details see "Text and Numeric Paging" on page 54.)

*Need to remind everyone on the committee you chair about an upcoming meeting?*

Create a Group List for any committee, project task force, etc. Then, create a voice message and send it to everyone in the group! It's just that simple with the *i700plus* phone. (For details see "Using Group Lists" on page 49.)

*Responsible for keeping in touch with building maintenance workers or project team members?*

You can use your *i700plus* phone as a two-way radio for a fraction of the cost of cellular calls. (For details see "Nextel Direct Connect®" on page 61.)

*Holding conference calls has never been easier. Your i700plus phone includes Three-Way calling.*

With Three-Way calling, you can conduct a conference call with clients or co-workers whether you're in the office or on the go! (For details see "Three-Way Calling" on page 33.)

*Need to monitor phone call length for charging purposes?*

You can with the *i700plus* phone. Just turn on the Display Timer and the duration of the most recent phone call will display. (For details see "Display Timer: On/Off" on page 94.)

---

# Getting Started

In this section you will learn everything you need to know to begin using your *i700plus* phone. This section also includes a Quick Guide portion so experienced digital cellular phone and two-way radio users can get started right away.

## About This Section

This section includes instructions for the following tasks:

Batteries: Attaching, Detaching, and Charging	Page 6
Turning Your <i>i700plus</i> Phone On/Off	Page 7
Activating Your <i>i700plus</i> Phone	Page 8
<b>NOTE: Your phone must be activated before you can use it.</b>	
Your Nextel Phone Status	Page 8
Display Icons	Page 12
Modes and Menus	Page 13
Quick Guide to Using <i>i700plus</i> Phone Functions	Page 14

## Batteries

Your *i700plus* phone comes with a standard NiMH-AA 1500 mAh battery. After attaching the battery, charge it for at least ten hours before you use it for the first time. After the initial charging, the battery can be charged more quickly.

## Attaching the Battery

- 1 Remove the battery cover located on the back of the phone. To do so, release the lock at the bottom of the battery cover by pressing up on the latch.

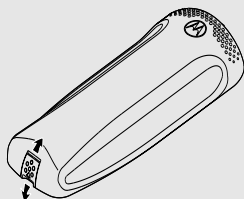

- 2 Remove the cover by sliding it away from the antenna.
- 3 Insert the battery with the “+” and “-” at the top. Install the battery bottom first, then press down on the battery to secure it.
- 4 Replace the battery cover and lock by pressing down on the latch.

## Detaching the Battery

- 1 Release the battery cover by pressing the battery cover latch upward.
- 2 Remove the cover by sliding it away from the antenna and lift the battery out of the phone.

## Charging the Battery





Your *i700plus* phone comes with the Standard Travel Charger. You can charge your battery with the phone on or off.

To charge your *i700plus* phone using the Standard Travel Charger:

- 1 Attach the charger to your phone’s Side Charging Jack. (See Features Bookmark on inside cover for jack location.)
- 2 Plug the charger into an electrical outlet.

### Battery Charging Status

The battery strength indicator icon, found on your phone's display screen, shows the charge amount remaining in the battery.

					
	Icon Flashes	Icon Displays	Icon Displays	Icon Displays	Icon Displays
Charge Strength	Low Battery	0-30%	31-60%	61-90%	91-100% Fully Charged

A short, chirp-like sound indicates a low battery. The icon flashes when you have 5 minutes of talk time remaining.

### Turning Your *i700plus* Phone On/Off

#### Phone On

1	Extend the antenna.
2	<p>Press and hold .</p> <p>As your phone connects to the Nextel National Network, you will see a <b>Welcome to Nextel</b> message and a connecting message. When <b>Phone Ready</b> appears on the display, you are ready to use your <i>i700plus</i> phone!</p>



#### Phone Off

1	Press and hold  until you see the message <b>Powering Off</b> .
2	Push in the antenna.

## Activating Your i700plus Phone

Before using your i700plus phone, it must be activated.

- **If you purchased your phone through a Nextel Sales Representative:** Your phone should be active already.
- **If you purchased your phone through an authorized dealer other than Nextel:** Follow the step-by-step instructions on the enclosed activation sheet to activate your Nextel service.

If your display reads **No Service** or doesn't change to the **Phone Ready** screen when you turn on your phone—and you know you are in a Nextel coverage area, call Nextel Customer Care at 1-800-639-6111. (For details on Nextel coverage areas, visit Nextel at nextel.com.)

**NOTE:** To register for the first time on the Nextel National Network, you must turn on your i700plus phone in your local calling area.

## Your Nextel Phone Status

Your i700plus phone has a “Status Light” indicator. The “Status Light” shows you, at a glance, the status of your connection (see Features Bookmark on inside cover).

Status Light Indicator	Nextel Phone Status
Flashing Red	Signing on to the network—Please Wait.
Solid Red	No service or out of coverage area. If you are in a coverage area, keep your phone on and it will attempt to connect every two minutes. If you cannot connect after 15 minutes or more, call Nextel Customer Care at 1-800-639-6111.
Flashing Green	In service/Ready to use. <b>NOTE: Nextel Direct Connect calls are not available outside of your home market area.</b>
Solid Green	In use.





## Keypad Lock

The *i700plus* phone includes a Keypad Lock feature that enables you to quickly lock the phone's keypad to avoid inadvertently pressing keys or placing calls. It is highly recommended that you activate your Keypad Lock while your phone is on but not in use to avoid inadvertent 911 emergency calls. Once Keypad Lock is activated, you can only perform the following tasks (unless you receive an incoming call, page, etc.):

- Turn your phone On/Off
- Unlock the keypad

**NOTE:** Before locking your phone's keypad, you may want to read this entire section to learn how to respond to incoming calls, pages, etc.

### Activating Keypad Lock

From the **Phone Ready** screen, simultaneously press  and . The message **Keypad Locked** displays on your phone.



**NOTE:** Whenever a key is pressed, while in Keypad Lock mode, the "Keypad Locked" message displays as a reminder.

### Receiving Incoming Calls

When you receive an incoming phone call (see "*Phone Mode*" on page 25 for more details), Keypad Lock will be temporarily disabled. You may perform the following:

Press  to answer the call.

Or, press  under "End" to send the call to Voice Mail and reactivate Keypad Lock.

### *Receiving New Message Mail*

When you receive new Message Mail (see “*Notification of New Pages*” on page 55 for more information), the Keypad Lock will be temporarily disabled. You may perform the following:

Press  under “Later” to return to **Phone Ready** and reactivate the lock.



Or, press  under “Now”. Press  under “Read”. Press  under “Save” or “Erase”. Once you have finished, press  under “Exit” to return to **Phone Ready** and reactivate the lock.

**NOTE:** If you have disabled Message Mail Notification, only the  icon will display. You will not receive the Read Now/ Later options.

### *Receiving Voice Mail*

When you receive a new Voice Mail (see “*New Message Indicators*” on page 43 for more information), Keypad Lock will be temporarily disabled. You may perform the following:

When **New Voice Mail Waiting** displays, press  under “Exit” to return to **Phone Ready** and reactivate the lock.

Or, press  under “Dial” to access Voice Mail. Once you have finished, press  to exit Voice Mail, return to **Phone Ready** and reactivate the lock.

**NOTE:** If you have disabled Voice Mail Notification, only the  icon will display. You will not receive the New Voice Mail Waiting message.

### Receiving Nextel Direct Connect® Calls

When you receive an incoming Direct Connect call (see “Nextel Direct Connect®” on page 61 for additional information), the phone will automatically activate the applicable mode (i.e., **Group**, **Private**, etc.). Once the call is terminated and the Display Timer (see “Display Timer: On/Off” on page 94) has expired, the phone will return to **Phone Ready** and reactivate the lock.

### Deactivating Keypad Lock





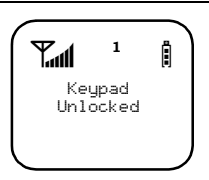





Simultaneously press  and . The message **Keypad Unlocked** displays.

Or, press  followed by . The message **Keypad Unlocked** displays.







## Display Icons

After you turn on your phone, the following icons may appear on the display:

	<b>Signal Strength Indicator:</b> Shows the signal strength. Six bars indicate the strongest signal. Calls and messages cannot be sent or received when there is no signal.
	<b>Battery Strength Indicator:</b> Shows the remaining charge in your battery.
	<b>Voice Mail Indicator:</b> Indicates that you have messages in your Voice Mail box. A flashing Voice Mail icon indicates that you have new, unheard messages.
	<b>New Text and Numeric Paging Flashing Indicator:</b> Indicates that you have new incoming pages.
	<b>Unread Text and Numeric Paging Indicator:</b> Indicates that you have unread but saved pages.
	<b>VibraCall™ Indicator:</b> Indicates that the Vibrate All option is turned on. Your <i>i700plus</i> phone will vibrate instead of emitting ring tones.
1 2	<b>Active Line Indicator:</b> Indicates the active phone line (1 or 2).
	<b>Call Forward Indicator:</b> Indicates that incoming phone calls have been forwarded for a specified line (1, 2, or both).
	<b>Private/Group Speaker Indicator:</b> Indicates that the Private/Group speaker is off. You will hear Nextel Direct Connect calls through the earpiece.
	<b>More Information Indicator:</b> Indicates that there is more text to read above and/or below the current screen.
	<b>Disk Icon:</b> Indicates that you have subscribed to Nextel Online. Arrows indicate when data is being transferred.

## Modes and Menus

When you first turn on your phone, the display defaults to **Phone** mode. However, your *i700plus* phone operates in four different modes. To switch between modes, press **Mode**. The table below provides more details about the four modes:

Mode	What the Display Looks Like	Function
<b>Phone Mode</b>		To make digital cellular phone calls.
<b>Private Mode</b>		To make private two-way radio calls using Nextel Direct Connect.
<b>Group Mode</b>		To make group two-way radio calls using Nextel Direct Connect.
<b>Net Mode</b>		To access Nextel Online services.

If the word **Ready** does not appear after the mode name in the display, that mode is either unavailable or it has not been activated. Once a mode is activated, there are various menu options (within each mode) that allow you to access different functions. To switch between menu options follow the steps below:

1 Press <b>MENU</b> .
2 Press <b>◉</b> under the displayed menu option that you want to select.

## Quick Guide to i700plus Phone Functions

Now that you understand different modes, here's a quick way to get started using them. This Quick Guide highlights some of the most commonly used functions in **Phone**, **Private**, **Group**, and **Net** modes. These functions are described in more detail in later sections.

### Phone Mode

You must be in **Phone** mode to perform the following functions:



Function	Action
<b>Programming Your Own Phone Number</b>	<ol style="list-style-type: none"><li>1 Press <b>*←</b> then <b>#→</b> then <b>1.-</b> then <b>⊙</b> under "OK". After you program your phone number, this option will read "Edit".</li><li>2 Enter your phone number and press <b>⊙</b> under "Store" then <b>⊙</b> under "Exit".</li></ol>
<b>Displaying Your Phone Number</b>	Press <b>*←</b> then <b>#→</b> then <b>1.-</b> .
<b>Making a Phone Call</b>	Enter the phone number and press <b>↶</b> .
<b>Ending a Phone Call</b>	Press <b>↶</b> .
<b>Last Number Redial</b>	Press <b>↶</b> .
<b>Receiving a Phone Call</b>	Press <b>↶</b> , <b>*←</b> , <b>#→</b> , or any key 0 - 9.

## Private Mode

You must be in **Private** mode to perform private two-way radio functions. Press  to switch from **Phone** to **Private** mode.



Function	Action
<b>Sending a Private Call</b>	<p>From the <b>Prvt Ready</b> screen, your most recently used Nextel Direct Connect call displays. To scroll other names, press . Select the name of the individual you would like to call or enter the Private ID number.</p> <p>To place the call, press and hold the Nextel Direct Connect Push-To-Talk button. Wait for the chirp, then speak into the microphone.</p> <p>To listen, release the Nextel Direct Connect Push-To-Talk button.</p>

## Group Mode

You must be in **Group** mode to perform group two-way radio functions. Press  to switch from **Private** to **Group** mode.



Function	Action
<b>Sending a Group Call</b>	<p>From the <b>Group Ready</b> screen, your most recently used Talkgroup displays. To scroll other Talkgroups, press .</p> <p>To place a call to a Talkgroup, press and hold the Nextel Direct Connect Push-To-Talk button. Wait for the chirp, then speak into the microphone.</p> <p>To listen, release the Nextel Direct Connect Push-To-Talk button.</p>

## Net Mode

See “*Net Mode*” on page 69.





---

# Creating, Editing and Using Stored Lists

A stored list is made up of names, phone numbers, Private IDs and Speed Dial numbers. Stored lists are convenient because you do not need to remember names and numbers. Instead, you simply scroll through your stored list, press a button and the number is dialed for you.

You can create and edit your lists using any of the following methods:

- Phone based using the Programming functions
- Web/Phone based using List Manager
- Computer/Phone based using Nextel's iDEN organizer

## About This Section

This section includes instructions for the following tasks:



Phone Based	Page 17
• Storing Names and Numbers	Page 17
• Pause Digit Entry	Page 19
• Editing Stored List Entries	Page 20
List Manager	Page 21
iDEN Organizer	Page 24

## Phone Based















**NOTE:** You may want to read *“Pause Digit Entry” on page 19* and *“Plus Dialing” on page 28* before you create a stored list from your phone. Using Pause Digit Entry and Plus Dialing will enable you to create stored lists that will save time when placing calls.

## Storing Names and Numbers

This programming function allows you to store up to 100 names, phone numbers and Private ID numbers. Your *i700plus* phone will automatically assign the next available Speed Dial number, which you can change. Once you have stored an individual, you can call them by scrolling through the list and finding their name, using the Speed Dial number or using Nextel Direct Connect (see *“Nextel Direct Connect®” on page 61*). And, whenever the person calls you, your phone will display their name if you entered their 10-digit phone number. The display holds 12 phone-number characters. If the phone number exceeds

12 characters, you can press  under “More” to see the remaining characters. To return to the start of the number, press  under “Numbr”.

You can store up to 100 names, phone numbers and Private IDs using the following steps:

- |   |   |
|---|---|
| 1 | Press  then  then  then  .  |
| 2 | The message: <b>20=Phone / Prvt List</b> displays. Press  under “OK”. Another message will display with the remaining number of slots available. The phone will then display the <b>Enter Name</b> screen.   |
| 3 | Enter the name of the individual you want to store.<br><br>(Notice, each key has a number and several letters. To select different letters on a key, quickly press the key until the desired letter displays. For example, to enter the letter Y you must press  3 times quickly. Also, you can press and hold  to change the case of the letter you just entered (lower to uppercase and upper to lowercase). The default style is uppercase.)<br><br><b>NOTE: Press the left side of  to backspace or delete a letter. Press the right side of the  to insert a space.</b><br><br>After you have entered the name, press  under “Store”. |
| 4 | <b>Enter Phone Number</b> displays. Enter the person’s area code and phone number and press  under “Store”.<br><br>Remember to add plus and pause entries if desired. See “ <i>Pause Digit Entry</i> ” on page 19 and “ <i>Plus Dialing</i> ” on page 28.  |
| 5 | The <b>name and Spd# =</b> displays. The system automatically assigns a Speed Dial number, which you can change by entering a new number. Press  under “Store”.  |
| 6 | <b>Enter PrvtID</b> displays. Enter the person’s Direct Connect Private ID. Press  under “Store”.  |
| 7 | Repeat steps 2 through 6 to add additional names/numbers.   |
| 8 | Press  under “Exit” when you have finished.  |

**NOTE: To see the name with Caller ID, enter the caller’s 10-digit regular phone number (703-555-9999) in your phone list (see “*Caller ID*” on page 35).**

---

## Pause Digit Entry

When storing a number, you can program your phone so that it will not only dial a number but also pause and enter another series of numbers such as a personal identification number (PIN) or password. This feature is particularly useful for automated services such as voice mail and banking systems.

Here's how it works! Let's say you have a company voice mail account that you frequently check while traveling. And, to access that account you must do the following:

- Dial your work number;
- Press # while the voice mail greeting is being played; and
- Enter your PIN to access your messages.

You can program your *i700plus* phone to enter all of the above information for you. All you have to do is separate each entry with a pause. If you were to program your phone to automatically input the above information, the stored data would look like this 17035551234P#P1234. In this example, the first eleven digits represent the number that must be dialed to access your voice mail. The P represents a 3 second pause. The # interrupts your greeting. The second P represents another 3 second pause. The last four digits represent your PIN.

You can use this feature not only to enter PINs and passwords but also to have the phone automatically select menu options (i.e., press 1 to hear messages).

To create a three-second pause follow the steps below:

Press and hold  for two seconds. The pause symbol (P) will appear on the display screen.

**NOTE:** You can enter up to 20 numbers/characters in a single entry, stored or dialed.

**NOTE:** If you use a system that will not let you enter an option until the automated message has played in its entirety, you can program your phone to pause for more than 3 seconds. For example, performing the above step twice will program two pauses and cause your phone to wait 6 seconds before entering the next set of numbers.

## Editing Stored List Entries

Once you have created lists, you can edit them as necessary. Select the applicable option below to edit a portion of a list.

### Edit a Phone Number or Associated Name or Speed Dial Number

1	Press  then  then  then .
2	At the <b>Phone List Edit</b> screen, press  under “OK”.
3	At the <b>Edit Entry?</b> screen, press  under “OK”.
4	Press  until the desired entry appears.
5	Press  under “OK”.
6	Edit the desired information (Number, Name, Speed Dial Number) and press  under “Store”. If you do not wish to edit one or more of the components, just press  under “Store”.
7	Press  under “Exit” until you see the <b>Phone Ready</b> screen.

### Edit a Private ID or Associated Name

1	Press  then  then  then .
2	At the <b>Prvt ID List Edit</b> screen, press  under “OK”.
3	At the <b>Edit Entry?</b> screen, press  under “OK”.
4	Press  until the desired entry appears, press  under “OK”.
5	Edit the desired information (Private ID, Name) and press  under “Store”. If you do not wish to edit one or more of the components, just press  under “Store”.
6	Press  under “Exit” until you see the <b>Phone Ready</b> screen.

## Erasing List Entries

Erasing stored list entries is as easy as creating them. To erase an entry item, follow the steps below:

1	Press  then  then  then  to erase a phone number entry or     to erase a Private ID entry.
2	At the <b>Phone (or Prvt ID) List Edit</b> screen, press  under “OK”.
3	Press   at the <b>Edit Entry?</b> screen until you see <b>Erase Entry?</b>
4	Press  under “OK”.
5	Press   until the desired entry appears.
6	Press  under “OK”.
7	Press  under “Yes” at the <b>Erase?</b> screen.
8	Press  under “Exit” until you see the <b>Phone Ready</b> screen.

## List Manager

With List Manager, you won't have to enter each name and number using your phone's keypad. Use the convenience of your computer keyboard to quickly generate phone lists from the Web. You'll also have the ability to initiate changes from your phone and “Send” them to List Manager. Account Administrators can send lists to large groups of phones and synchronize the lists across multiple work groups.

**NOTE: Use of List Manager requires the purchase of a Nextel Online Service Plan.**

To use List Manager, you must first:

- register at nextel.com (see “Registration” on page 22)
- and then:
- activate List Manager from your phone (see “Activate List Manager from Your Nextel Phone” on page 22).

## Registration

To register, go to nextel.com. You will need to provide your Nextel phone number and IMEI, the number found on the back of your phone underneath the battery. Account Administrators will also need the account number, billing address zip code, and last account balance.

## Activate List Manager from Your Nextel Phone

Activating List Manager on your Nextel phone sends essential information from your phone to the List Manager site.

**NOTE: You must register at nextel.com before attempting to access List Manager from your phone.**

- 1 From the **Net** mode home page (see page 71), select “NextelServices” then select “List Manager”. Follow the prompts and enter your member name and password exactly as they are registered with nextel.com.



**NOTE: The default to enter information is lowercase. To change to uppercase, press and hold #m until the word “alpha” changes to “ALPHA.”**

- 2 After you complete the login, the List Manager main screen will appear.





## Send a Stored List from Your Phone to List Manager

To send a list from your phone to List Manager on your computer, follow the steps below:

- 1 From the List Manager main menu, scroll down to “Send” and press  under “OK”.



- 2 Select the list you want to send from your phone to the Web site. You may select Speed Dial, Private ID, Talkgroup, or All.

- |          |   |
|----------|---|
| <b>3</b> | Press  under “OK”. A verification message, “Send changes from phone’s lists to the Web site?” will be displayed.   |
| <b>4</b> | Press  under “OK” to verify. The screen will briefly display “ <b>Sending</b> ” at the bottom of the screen. When the transfer is complete, the Send menu will reappear. |
| <b>5</b> | To exit List Manager and return to your home page, press  .  |

### List Manager User Tips

- If you have already created lists on your phone, to avoid losing your existing lists, send that information to List Manager before modifying your lists on the List Manager Web site.
- When sending lists from your phone, the transmission to the Web is immediate. It’s not necessary to confirm the transaction on the Web site.
- When sending information from the Web site to the phone, you must confirm the action on your phone.
- If you send information from the Web site to the phone and realize you have made a mistake, you can decline the update from the phone. When the **New Net Mail** message arrives on your phone, select “Later” then delete the message “\*Receive List?” from your Net Mail Inbox.
- If you have more than one phone, you must register each phone individually with Nextel. Or, you can register as an Account Administrator and manage multiple phones.

### For List Manager Account Administrators

Account Administrators can manage large groups of phones and synchronize phone lists across multiple workgroups. To do this, however, there are a few things you’ll want to know.

- You must register with Nextel as an Account Administrator. To do so, you will need to provide the following information:
  - Account Number
  - Billing address zip code
  - Last account balance
- If you have registered as an Account Administrator on a master account, you will have access to all accounts associated with the master account. If you do not have access to your company’s Nextel master account, you must register separately for each individual account you wish to access.

- Talkgroups cannot be created through List Manager. Please call Nextel Customer Care at 1-800-639-6111 to have your Talkgroups set up by a Nextel Customer Care Representative.
- Administrators may register as an individual user and/or an Account Administrator. However, you do not need to have a Nextel phone to act as an Account Administrator.
- Administrators can create master lists or templates to send to multiple users. When sent to a group of users, those templates will occupy certain positions on the user's phone list and will overwrite information already in those positions. For example, an Account Administrator for the Marketing Department creates a template for the 30-employee group. If the employee accepts the Administrator's template, it will occupy positions 71-100 on each employee's phone list. Employees cannot edit, change, delete or modify information stored in those 30 positions (71-100).
- To avoid loss of information, individual users should be notified in advance which list positions a template will occupy.

### **iDEN Organizer**

If you want to use your computer to create stored lists for your *i700plus* phone, use Nextel's iDEN Organizer. It's available for programming names, phone numbers, and Private IDs into your phone. To order, call Nextel Nextday<sup>SM</sup> Accessories at 1-800-914-3240 or contact your Nextel Authorized Representative.



---

# Phone Mode

## Digital Cellular

In addition to making and receiving domestic and international phone calls in **Phone** mode, you can make emergency calls, be notified of a missed call, and more. To learn how to perform these functions review the following section.



**NOTE:** For most phone functions, you will need to be in Phone mode. Press  until you see *Phone Ready*. For more information, see “Modes and Menus” on page 13.

## About This Section

This section includes the following:



Making Domestic Phone Calls	Page 25
Placing International Phone Calls	Page 27
Receiving a Phone Call	Page 28
Ending a Phone Call	Page 30
Standard Features	Page 30
Additional Phone Services	Page 33

## Making Domestic Phone Calls



There are five ways to make a phone call: Direct Dial, Scroll, Name Search, Speed Dial, and Turbo Dial™.

**NOTE:** Keypad Lock must be deactivated in order to place a phone call.

### Direct Dial

- 1 From **Phone Ready**, enter the number using the keypad.
- 2 Press  to place the call.
- 3 Press  to end the call.



If you make a mistake:

To Clear One Digit	To Clear All Digits	To Cancel
Press 	Press and hold 	Press  under "Cancel"

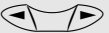

## Making Phone Calls From the Stored List

Before you can use the Scroll, Name Search, Speed Dial or Turbo Dial methods, you first must create a phone list. To learn how to create stored lists, see "Creating, Editing and Using Stored Lists" on page 17.



### Scroll

- 1 Press  to select the individual you want to call.
- 2 Press .

### Name Search

- 1 Press  under "Name".
- 2 Using the keypad, enter the first letter of the desired name.
- 3 Press  to scroll names.
- 4 Press .

### Speed Dial

- 1 Press  until you see the "Spd#" option.
- 2 Press  under "Spd#".
- 3 Enter the Speed Dial number.
- 4 Press .

## Turbo Dial





Allows you to call any one of your first eight phone list entries by pressing and holding the corresponding numeric key (1-8).

## Automatic Redial

Press  to redial the last number you called.

**NOTE:** If you receive “System Busy, Try Later”, press  to redial the number automatically. You will hear a ring-back tone when the call is successful.

## Emergency Calling

Nextel phones fully support emergency calling. To place a call in an emergency, dial    . You will be connected to the nearest emergency dispatch center. If you are on an active call, you must end it before calling 911.

## Special Dialing Codes

Nextel supports “non-emergency” numbers (such as #77, 311, ...) provided by local and state governments. These numbers are used to report traffic accidents, motorist problems, careless drivers or any other non-emergency incidents. If the situation includes imminent danger or loss of life, you should dial 911. Nextel does not yet support all local and state non-emergency numbers but is continuously expanding support.

## Placing International Phone Calls

Nextel Worldwide Service allows for International Roaming of your Nextel phone to other iDEN networks. When dialing internationally, you can either enter the international access code (011 in the United States) directly or use “Plus Dialing”.

**NOTE:** Your phone’s default is “International Calls Restricted.” Therefore, you must call Customer Care at 1-800-639-6111 to obtain international dialing access.

## Plus Dialing

This feature enables you to place an international call from most countries—without entering the local international access code.



- 1 Press and hold  for two seconds. A “0” appears, then changes to a “+”.

**NOTE: The network translates the “+” into the appropriate international access code needed to place the call.**

- 2 Enter the country code, city code, and phone number.
- 3 Press .

## Receiving a Phone Call

An incoming call is indicated by a ring, vibration or backlight illumination.



You can answer the call by pressing any numeric key (0-9), or by pressing , , or .

## Missed Call Indicator

Your *i700plus* phone notifies you of unanswered phone calls. If you subscribe to Caller ID, your *i700plus* phone temporarily stores the caller's phone number in your Last 10 Received Calls list. Your screen displays a flashing message with the number of missed calls. Press any key to clear the flashing indicator.



## Retrieving a List of Missed Calls

- 1 Press  until you see the “Calls” option.
- 2 Press  under “Calls”.
- 3 Press  to scroll the list.

### Last 10 Numbers Received/Sent Calls List

If you subscribe to Caller ID, you can view, dial, and store the last ten received and last ten sent telephone numbers. The most recently received or sent calls appear first in your call list (see “*Caller ID*” on page 35). If the name is not stored, the phone number displays.

### Quickstore of Phone Numbers

Quickstore allows you to quickly store a received or sent phone number without going through the Programming menu.



### Reviewing/Storing/Dialing Received Calls

- 1 Press until you see the “Calls” option.
- 2 Press under “Calls”. The **Rcvd Calls** screen appears.
- 3 Press to scroll entries. Press under “Store” to store the number in the first available storage space. Or press to dial the number.
- 4 Enter the name using the keypad. (Notice, each key has a number and several letters. To select different letters on a key, quickly press the key until the desired letter displays. For example, to enter the letter Y you must press 3 times quickly.)
- 5 Press under “Store” after you have entered the name.
- 6 Press under “Cancl” to close the **Rcvd Calls** screen.

### Reviewing/Storing/Dialing Sent Calls

- 1 Press until you see the “Calls” option.
- 2 Press under “Calls”.
- 3 Press until you see “Sent” if this option isn’t already visible.
- 4 Press under “Sent”.
- 5 Press to scroll entries. (To store an entry from the Sent list, press under “Store” and follow steps 4-6 above). Or press to dial the number.

## Ending a Phone Call

Press  to hang up.

## Standard Features

### *Call Hold*

When you are on an active call, you can place the call on hold and make a second call.

1 Press  under “Hold”.

2 Place the second call. Repeat steps to toggle between calls.

### *Call Forwarding*

Nextel’s Call Forwarding features forward calls to the number you designate. There are four versions of Call Forwarding available:

#### **Using Call Forwarding For All Calls**

When this service is turned on, all calls will be sent automatically to the number you select.

#### **Using Call Forwarding When Busy**

This service send calls to the designated number when your phone is engaged in other activities.

#### **Using Call Forwarding When You Do Not Answer**







This service sends calls to the designated number when you do not answer the call. The phone will ring 4 times before forwarding the call.



#### **Using Call Forwarding When You Are Not Available**

This service send calls to the designated number when your phone is not on the network. This includes when the unit is powered off or out of the coverage area.





**NOTE: The default setting for all versions of Call Forwarding, except All Calls, is the Voice Mail access number (NPA-NXX-6245) for your primary line.**

## Turning On Call Forwarding For All Calls

<p>1 Press  until you see “Forwd”.</p>	
<p>2 Press  under “Forwd”.</p>	
<p>3 Enter the phone number you want incoming calls forwarded to. (Or, you may press  to select a number from your stored list.)</p>	
<p>4 Press  under “On”.</p>	
<p>5 Press  under “Exit” after the <b>Please Wait</b> message displays.</p>	



Your calls will now be forwarded to the number that you selected and you will see ,  or  (the Call Forward Indicator with the forwarded line number(s) display(s) on your screen). You can forward Line 1 and Line 2 independently.

## Turning Off Call Forwarding For All Calls

<p>1 Press  until you see “Forwd”.</p>
<p>2 Press  under “Forwd”.</p>
<p>3 Press  under “Off”.</p>
<p>4 Press  under “Exit” after the <b>Please Wait</b> message displays.</p>

**NOTE:** You must be in a coverage area to activate or modify Call Forwarding.

## Changing Setting for Call Forwarding

<p>1 Press  until you see “Forwd”.</p>
<p>2 Press  under “Forwd”.</p>

3 Press **MENU** until you see the Call Forward version you want to modify:

- “Busy” for Call Forward When Busy
- “No Ans” for Call Forward No Answer
- “No Rch” for Call Forward Not Reachable

4 Enter the forwarding phone number.

## Call Waiting

Call Waiting allows you to receive a second call while you are talking on the phone. With the *i700plus* phone you can switch between calls so you never have to miss a call. By default, Call Waiting is always ON unless you turn it OFF for a specific call.

If you're on a call and you receive a second call, you will:

- **Hear** a tone; and
- **See** a message on your display informing you of another incoming call.

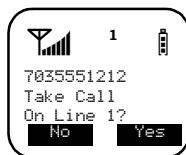

**NOTE:** If your phone is activated with two lines and you select the Call Waiting option for one line, the alternate line is automatically activated with Call Waiting.

## Accepting Calls

Press **OK** under “Yes”.

## Declining Calls

Press **OK** under “No”. If you're a Nextel Voice Mail customer, the call will be forwarded to your Nextel Voice Mail box.

## Switching Between Calls

Press **OK** under “Hold”. Your phone will refer to the first call as Call-1 and the second call as Call-2. If call 1 is on hold your display will read: **Call 1 - Hold 7035551234**.





## Ending the Active Call

Press .

## Turning Call Waiting Off

If you do not want to be interrupted during a call, you can turn Call Waiting off prior to making/receiving a call.

1 Press  until you see “Wait”.

2 Press  under “Wait”.

3 Press  under “Off”.

Call Waiting is now disabled for the next call. It will automatically reset to “On” when you hang up.

## Three-Way Calling

Using Three-Way Calling, you can combine two ongoing phone calls into one conversation. This option is available only when you initiate the second call. To do so, follow the steps below:

1 Place or receive a phone call.

2 Press  under “3Way” to place the first call on hold.

3 Enter the phone number of the second individual you want to call and press .

4 After you reach the second individual, press  under “3Way”. Both numbers will appear on your display.

## Additional Phone Services

In addition to the standard features that are included for all Nextel Digital Cellular subscribers, there are also several features that are available at an additional monthly fee or cost for each use. Contact Nextel Customer Care at 1-800-639-6111 for more information about these services.

## Alternate Line Service

If you are an Alternate Line customer, you will be given a unique phone number for each line. With alternate lines, you can separate business and personal calls, or designate one as a “priority line.”

- Line 2 shares the Voice Mail box with Line 1; there is only one monthly charge.
- You cannot forward Line 2 to Line 1 and have the phone ring; the call defaults to Voice Mail.
- Text and Numeric Paging is not available on Line 2.

The following settings are independent for each phone line. When you enable a setting, it applies only to the active line.

- Ringer Volume, Selectable Ring Styles, Call Forwarding numbers, One-Minute Beep, Display Timer, Reset Timer and Total Timer.

## Selecting an Alternate Line

<p>1 Press <b>MENU</b> until you see the alternate “Line1”. (If you are already using Line 1, “Line2” will appear as an option).</p>	
<p>2 Press <b>1</b> under “Line1” to select Line 1; or, press <b>2</b> under “Line2” to select Line 2, whichever is applicable.</p>	

## Receiving Calls on Your Alternate Line

You can receive calls on either line, regardless of the active line setting.

- If the call is on the same line as the currently active line, the Active Line Indicator simply flashes.
- If the call is on the line that is not currently active, the Active Line Indicator remains lit and the other line number icon flashes.

## Accepting Calls

- 1 Press  under “Yes” to answer the call on the other line. Your original call will be placed on hold.

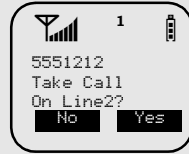

- 2 Press  under “Hold” to toggle between calls and revert to the other call. When both calls end, the phone remains active in the last line selected.

## Declining Calls

Press  under “No”. If you’re a Nextel Voice Mail customer, the call will be forwarded to your Nextel Voice Mail box.

## Call Restrictions

You can prevent your phone from making or receiving specific types of calls. Nextel currently offers three types of Call Restrictions:

- no long distance calls allowed
- no incoming calls
- no outgoing calls (except 911).

## Caller ID

If you subscribe to Caller ID, your *i700plus* phone automatically displays the phone number and/or name of the person calling (unless blocked by the caller), enabling you to decide whether to take the call or forward it to Voice Mail (purchase required).

**NOTE: Caller ID information may not be received for all calls.**

## Displaying the Caller’s Name

A caller’s name is displayed on your Nextel phone if you previously programmed the person’s name into your phone list (see “*Storing Names and Numbers*” on page 17). Otherwise the caller’s phone number will be displayed.

## Maintaining Your Privacy with Per-Call/Per-Line Blocking

Nextel provides two methods to prevent those you call from seeing your number on their own Caller ID displays.

**NOTE: Your Nextel phone number cannot be blocked from calls made to 911, 800, 855, 866, 877, 888, or 900 phone numbers.**

Block Setting	What This Setting Does	To Set
<b>Per-Call Blocking</b>	Selectively blocks delivery of your phone number to other Caller ID units.	Press *4 6mno 7pqrs before dialing the call.
<b>Per-Line Blocking</b>	Permanently blocks delivery of your phone number on every call you make.	You must order this feature by calling Nextel Customer Care at 1-800-639-6111. You can disable this feature on a per-call basis by pressing *4 8tuv 2abc before the call.

### Directory Assistance

Nationwide White Page Listings, Yellow Page Listings and Call Completion are available by dialing 411 or (area code)-555-1212.

#### White Page Listings

You can request the telephone number for any person, business or government agency in the Continental United States plus Hawaii.

#### Yellow Page Listings

By providing basic information such as city and type of business, you can find a company anywhere in the Continental United States plus Hawaii.

## Nationwide Call Completion

Operators will connect you to the listing you requested. There are no charges beyond normal airtime costs for this service (airtime will count against your bucket of minutes; overage charges will apply if the bucket of minutes has been exhausted). If you prefer, the operator will stay on the line while connecting to the number.

In the event you need another listing, you can return to an operator at any time during the call by pressing **\*←**. By pressing **#→** you can hear the phone number dialed.

## **Nextel Voice Mail Service**

Nextel Voice Mail Service is a flexible, easy-to-use system that takes messages when you're not available—so you never miss an important call!

### **About This Section**

The main topics covered in this section are listed below:

Setting Up Your Voice Mail Box	Page 38
Using Voice Mail	Page 39
Receiving Voice Mail Messages	Page 43
Advanced Voice Mail Features	Page 44

This section covers the most commonly used Voice Mail features. Once you log into Voice Mail, there are a number of innovative features you can access. They are also covered in this chapter. After you access Voice Mail, an automated system tells you each menu option and which button to press to make a menu selection.

### **Setting Up Your Voice Mail Box**

You must set up your Voice Mail box before you can retrieve messages. The following steps will tell you how to set up your mailbox. However, before proceeding you may want to read “*Recording Your Active Greeting*” on page 42, which provides information you may want to include in your greeting:

- |  |
|--|
| <p><b>1</b> Using your Nextel phone, dial your 10-digit Nextel Personal Telephone Number (PTN).</p> <p>If you are calling from a phone other than your Nextel <i>i700plus</i> phone, dial your 10-digit Nextel Personal Telephone Number (PTN). When you hear the greeting, press * to access your Voice Mail account.</p> |
| <p><b>2</b> When prompted, enter your password. (New users should enter the last seven digits of your phone number. This is your temporary password).</p>  |

- 3 The first time you access Voice Mail, you will be prompted to follow a tutorial in order to:
- Create a new four- to seven-digit password (see “*Changing Your Password*” on page 41).
  - Record your name (see “*Recording Your Name*” on page 42).
  - Record a greeting (see “*Recording Your Active Greeting*” on page 42).
- 4 When the system says, “Enjoy using Nextel Voice Mail,” your mailbox is set up.

## Using Voice Mail

### Logging Into Voice Mail

- 1 From the **Phone Ready** screen, press  under “Mail” to open the **Mail** screen.

- 2 **Voice Mail** should be highlighted to indicate that it is selected. If it isn’t selected, press  to select it. An asterisk indicates new messages.

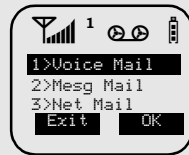

- 3 Press  under “OK.” The **Voice Mail** screen appears.

The screen displays the number of new messages and the total number of messages in the system. An exclamation point (!) indicates an urgent message.



- 4 Press  under “Dial” to log into Nextel Voice Mail Service. **Phone-In Use** displays as you are connected to the network.

**NOTE:** If you hear a message that says, “Enter the phone number of the subscriber you are trying to reach,” enter your own Nextel Personal Telephone Number. When the greeting plays, press  to interrupt it.

- 5 When prompted, enter your password.

**NOTE:** You must receive a message before you can access Voice Mail by pressing  under “Dial” from your *i700plus* phone. (Tip: You can leave yourself a message.)

## Main Voice Mail Menu

You are at the main Voice Mail menu when you hear the options listed below.

- To play your messages press **1** (This option plays only if you have new or saved messages.)
- To record a Message press **2**.
- To change your Greeting press **3**.
- To access your Personal Options press **4**.

If you press **\*** while you are at a sub-menu, you will go to the previous menu. If you press **\*** **\***, you will go to the main Voice Mail menu.

From the main Voice Mail menu, press **#** to exit Voice Mail. At any time, of course, you may simply hang up.

## Playing Messages

Once you have selected to play your messages from the main menu, Nextel Voice Mail Service will immediately start playing your messages. You have several options available during and after the playing of each message.

Options available while listening to your messages:

Replay previous six seconds.	Press <b>1</b> .
Rewind to beginning of message.	Press <b>1</b> then <b>1</b> .
Pause/continue the current message.	Press <b>2</b> .
Fast forward 6 seconds.	Press <b>3</b> .
Fast forward to end of message.	Press <b>3</b> then <b>3</b> .
Play the date and time stamp.	Press <b>5</b> then <b>5</b> .

Options available while a message is playing or after it has played:

Copy the message to another subscriber. (See "Advanced Voice Mail Features" on page 44.)	Press <b>6</b> .
Delete the message.	Press <b>7</b> .



Reply to the message.	Press <b>8</b> <sup>tuv</sup> .
Save the message.	Press <b>9</b> <sup>wyz</sup> .
Skip to the next message.	Press <b>#</b> <sup>m</sup> .

### Saving and Deleting Messages

While a message is playing or after you have finished listening to it, you can save it or delete it. To save a message press **9**<sup>wyz</sup> when prompted to do so. To delete a message press **7**<sup>pqrs</sup> when prompted to do so (see “Automatic Playback” on page 44 to have messages automatically saved).

**NOTE:** To retrieve deleted messages, press **\***<sup>1</sup> then **3**<sup>def</sup>. This option only applies to the current Voice Mail session. If you hang up, the messages will be permanently deleted. Messages that are not saved or deleted remain in your mailbox as new messages for 30 days. All messages are automatically deleted after 30 days.

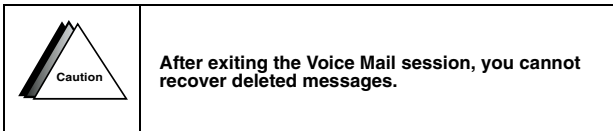

### Changing Your Password

To change your current password follow the steps below:

1	From the main Voice Mail menu, press <b>4</b> <sup>ghi</sup> to access Personal Options.
2	Press <b>4</b> <sup>ghi</sup> to access Personal Preferences.
3	Press <b>1</b> <sup>.</sup> to modify password.
4	Enter your new password (four- to seven digits).
5	Press <b>*</b> <sup>1</sup> <b>*</b> <sup>1</sup> to return to the main menu.

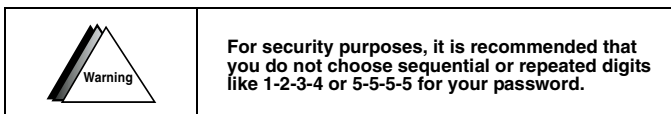

## Recording Your Name

When you send, reply to, or copy a message, your name response precedes the message. To record or rerecord your name at any time use the following steps:

1	From the main Voice Mail menu, press <b>4<sup>ghi</sup></b> to access Personal Options.
2	Press <b>4<sup>ghi</sup></b> to access Personal Preferences.
3	Press <b>3<sup>def</sup></b> to access the Record Your Name option.
4	Press <b>2<sup>abc</sup></b> to record your name.
5	Press <b>*← *←</b> to return to the main menu.

## Recording Your Active Greeting

**NOTE:** Through the Nextel Voice Mail Service, there are a number of ways people can reach you. You may want to include one or all of the following options in your greeting so that callers will know they are available. Also, in your greeting, you should tell callers to press the pound sign (#) after they have finished recording. This will prompt Nextel Voice Mail Service to play the list of menu options shown below:

- Press **1<sup>.-</sup>** to send a numeric page.
- Press **2<sup>abc</sup>** to send an operator assisted message. (This option is available only if you are a subscriber of Operator Assisted Paging. Contact Nextel Customer Care for more information.)
- Press **9<sup>wxyz</sup>** for other options (after pressing **9<sup>wxyz</sup>** the caller will need to press **5<sup>ijkl</sup>** for Delivery Options, which enables them to mark the message as Urgent, Private, etc.).
- Press **#<sup>m</sup>** to skip the greeting and record message immediately.

## Sample Greeting

Below is a sample greeting. You can add the above options as you see fit.

“Hello, you’ve reached \_\_\_\_\_. I’m sorry I missed your call. If you leave a message at the tone, I’ll return your call as soon as possible. If you would like to bypass this greeting in the future, press pound. Thank you for calling.”

To record or alter your greeting at any time follow the steps below:

1	From the main Voice Mail menu, press <b>3def</b> to change your greeting.
2	Press <b>1.-</b> to play, <b>2abc</b> to record, or <b>3def</b> to delete your active greeting.
3	Record your message and press <b>#m</b> when you have finished.
4	Press <b>*←</b> <b>*←</b> to return to the main menu.

## Receiving Voice Mail Messages

### New Message Indicators

When you receive a new message, the following occurs:

- **New Voice Mail Waiting** will display on the screen once your phone is turned on (if your phone is off when the call is received).

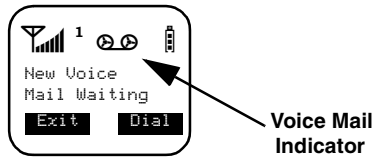

- The **📞** icon will flash at the top of the display.
- Press **📞** under “Exit” to listen later or press **📞** under “Dial” to listen now.
- Your *i700plus* phone will alert you every 30 seconds until you press “Exit” or “Dial”.

### Transferring Calls to Voice Mail

Press **📞** under “End” while your phone is ringing to transfer incoming calls directly to Voice Mail (purchase required).

### Alert Receipt

Through your programming menu (**\*←** **#m** **1.-** **5jkl**), you can delay Voice Mail and Message Mail alerts so that you are not interrupted by the alert tone while on a call. You can choose to receive all alerts, delay all alerts, or receive Message Mail alerts only.

## Advanced Voice Mail Features

### *Automatic Playback*

By default, the Playback Mode of your Nextel Voice Mail Service is set to Normal. Nextel's Automatic Playback feature enables Nextel Voice Mail Service to automatically play and save new messages, which saves you time. To activate Automatic Playback follow the steps below:

1	From the main Voice Mail menu, press <b>4<sup>ghi</sup></b> to access Personal Options.
2	Press <b>4<sup>ghi</sup></b> to access Personal Preferences.
3	Press <b>2<sup>abc</sup></b> to access Playback Preferences.
4	Press <b>2<sup>abc</sup></b> to switch to Automatic Playback.
5	Press <b>*←</b> <b>*←</b> to return to the main menu.

**NOTE: You can deactivate Automatic Playback (after it has been activated) by following the above steps.**

### *Changing the Playback Order of Messages*

With Nextel Voice Mail Service, you can select the order you want unheard messages to be played in. You may listen to the last received message first. Or, you may listen to the first received message first. To select the order new messages should be played in, follow the steps below:

1	From the main Voice Mail menu, press <b>4<sup>ghi</sup></b> to access Personal Options.
2	Press <b>4<sup>ghi</sup></b> to access Personal Preferences.
3	Press <b>2<sup>abc</sup></b> to access Playback Preferences.
4	Press <b>1<sup>↔</sup></b> to switch the playback order.
5	Press <b>*←</b> <b>*←</b> to return to the main menu.

## Greeting Schedule

Nextel Voice Mail Service allows you to record up to five separate greetings that can be played based on pre-determined time frames. After you have recorded a greeting for each time frame, you can then select any of those greetings as your active greeting (see the following table). For example, if you activate the greeting schedule after you record Morning and Afternoon Greetings, the system will automatically play greetings 2 and 3 at the appropriate times. See the list of pre-determined schedules—then refer to the steps in the following table to record your greetings:

<b>Greeting 1</b>	Generic Greeting	24 hours a day/7 days a week. (This is the default setting if you haven't activated your greeting schedule.)
<b>Greeting 2</b>	Morning Greeting	7:30 am–11:59 am Monday–Friday
<b>Greeting 3</b>	Afternoon Greeting	Noon–6:00 pm Monday–Friday
<b>Greeting 4</b>	All Hours	24 hours a day/7 days a week
<b>Greeting 5</b>	All Hours	24 hours a day/7 days a week

To record Greetings 2–4, your Greeting Schedule must be active.

To record your greetings, follow the steps below:

1	From the main Voice Mail menu, press <b>3def</b> to access the Greetings menu.
2	Press <b>4ghi</b> to modify greetings.
3	Enter the greeting number you wish to create or modify.
4	Press <b>2abc</b> to record a greeting.
5	Record your greeting and press <b>#m</b> when you have finished.
6	Press <b>*← *←</b> to return to the main menu.

## Activating Your Greeting Schedule

To activate your greeting schedule according to the pre-determined time frames (Morning, Afternoon, etc.) follow the steps below:

- |   |   |
|---|---|
| 1 | From the main Voice Mail menu, press <b>3</b> def to access the Greetings menu. |
| 2 | Press <b>9</b> wxyz to activate your greeting schedule.                         |
| 3 | Press <b>*1</b> <b>*1</b> to return to the main menu.                           |

## Working With Group Lists

The Group List feature enables you to create a list and assign it a unique name. Then, you can add mailbox numbers, group lists or individuals—by name—to the list. Once you create a list you can send a voice message to everyone on the list by simply entering the group list number. You can have up to 40 group lists. Each list can hold up to 50 addresses (see “Using Group Lists” on page 49).

## Creating A Group List

To set up a Group List follow the steps below:

- |   |   |
|---|---|
| 1 | From the main Voice Mail menu, press <b>4</b> ghi to access Personal Options. |
| 2 | Press <b>2</b> abc to access your Group Lists.                                |
| 3 | Press <b>2</b> abc to create a Group List.                                    |
| 4 | Enter the one- or two-digit group list number and press <b>#</b> m.           |
| 5 | Record a name for the list and press <b>#</b> m.                              |
| 6 | Select group members by mailbox number, group list, or name.                  |
| 7 | Press <b>#</b> m to save all entries added to the list.                       |
| 8 | Press <b>*1</b> <b>*1</b> to return to the main menu.                         |

---

## Modifying a Group List

1	From the main Voice Mail menu, press <b>4</b> ghi to access Personal Options.
2	Press <b>2</b> abc to access Group Lists.
3	Press <b>4</b> ghi to modify a Group List.
4	Enter the number of the Group List you want to modify.
5	Press <b>1</b> .-> to add a new recipient.
6	Press <b>#</b> ⏪ to save your changes.
7	Press <b>*</b> ⏪ <b>*</b> ⏪ to return to the main menu.

## Deleting a Group List

1	From the main Voice Mail menu, press <b>4</b> ghi to access Personal Options.
2	Press <b>2</b> abc to access Group Lists.
3	Press <b>3</b> def to delete a group list.
4	Enter the number of the Group List you want to delete. The system will play the name of the group list.
5	Press <b>#</b> ⏪ to delete the list.
6	Press <b>*</b> ⏪ <b>*</b> ⏪ to return to the main menu.

## Recording, Copying and Replying to Messages

These functions allow you to record and send, reply to, or copy a message to a mailbox number, a name in the Nextel Voice Mail Service directory, or a Group List number, to an assigned destination address.

**NOTE:** If you record a complete or partial message—but do not send it, Nextel Voice Mail Service will refer to this message as an “in preparation” message. (Before sending messages you may want to see “Delivery Options” on page 48.)

To record and send a message, proceed to the table below:

1	From the main Voice Mail menu, press <b>2<sup>abc</sup></b> to record a message.
2	Record your message and press <b>#<sup>m</sup></b> to end the message.
3	Press <b>9<sup>wz</sup></b> at the prompt to indicate that you want to send the message or press <b>5<sup>jd</sup></b> for Delivery Options.
4	Enter the mailbox number and/or group list number(s).
5	Press <b>#<sup>m</sup></b> to send.
6	Press <b>*<sup>l</sup></b> <b>*<sup>l</sup></b> to return to the main menu.

To send a message to another mailbox, enter the 10-digit Personal Telephone Number of the Nextel customer. The name response of the recipient plays if it is recorded.

You can only send messages using this method to other Nextel users in your home market.

## Delivery Options

After you have created a message, you can assign delivery options before you send it. Below is a list of the options that can be applied to a message:

<b>Urgent</b>	Recipient will hear this message before other messages.
<b>Private</b>	Recipient cannot copy the message to another mailbox or phone number.
<b>Notification of Non-Delivery</b>	You will be notified if the recipient has not listened to your message by a certain date and time.
<b>Future Delivery</b>	You can specify a time and date (up to three months in advance) for the message to be delivered.  Important: Once a message has been sent for future delivery, it cannot be retrieved or deleted.



To set a special delivery option, follow the steps below:

<b>1</b>	After recording your message but before sending it, press <b>5</b> <small>ijkl</small> for Delivery Options.
<b>2</b>	Press the number that corresponds with the desired delivery option: <ul style="list-style-type: none"> <li>• Press <b>1</b> <small>.-&gt;</small> for Urgent.</li> <li>• Press <b>2</b> <small>abc</small> for Private.</li> <li>• Press <b>3</b> <small>def</small> for Notification of Non-Delivery. At prompt, specify time.</li> <li>• Press <b>4</b> <small>ghi</small> for Future Delivery of Messages. At prompt, specify time.</li> <li>• Press <b>9</b> <small>wxyz</small> to send the message immediately.</li> </ul>
<b>3</b>	The list of options will be presented again. Select another option or press <b>9</b> <small>wxyz</small> to send the message.
<b>4</b>	Enter the destination mailbox or group number of the recipient(s).
<b>5</b>	Press <b>#</b> <small>0</small> to send.
<b>6</b>	Press <b>*</b> <small>1</small> <b>*</b> <small>1</small> to return to the main menu.

### Using Group Lists

Enter the one- or two-digit Group List Number. You must have previously created this list. (See *“Working With Group Lists”* on page 46.)

### Time and Date Charts

Time and Date Charts can be referenced for specific tasks throughout Nextel Voice Mail Service.

### 24-hour Clock

Nextel Voice Mail Service uses a 24-hour clock:

**NOTE:** To compute the 24-hour clock time for pm, add 1200.

Below is a list of hours translated into 24-hour time:

Hour	12:00 am	4:00 am	8:00 am	12:00 pm	4:00 pm	10:00 pm
24-hour	0000	0400	0800	1200	1600	2200

## Dates

All dates must have 4 digits in the MM/DD format (2 digits for the month and 2 digits for the day). January is 01, February is 02, etc. The first day of the month is 01, the second day of the month is 02, etc.

## Recovering Deleted Messages

To retrieve deleted messages, press **\*4** then **3<sup>def</sup>**. This option only applies to the current Voice Mail session. If you hang up, the messages will be permanently deleted.

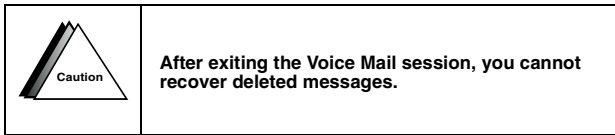

## Message Forwarding

This feature allows you to program your phone to automatically forward incoming messages to another mailbox. There are three types of forwarding: Immediate, Silent and Delayed.

- **Immediate Forwarding**—Caller is notified that the message will be forwarded.
- **Silent Forwarding**—Caller is not notified that the message will be forwarded.
- **Delayed Forwarding**—If a caller's message is not retrieved after a certain amount of time, the message will automatically be forwarded to another mailbox or telephone number.

1 From the main Voice Mail menu, press **4<sup>ghi</sup>** to access Personal Options.

2 Press **5<sup>jkl</sup>** to modify Forwarding Options.

3 Select the applicable option below:

- To create a forwarding number, press **2<sub>abc</sub>**.
- If you have already created a forwarding number, press **2<sub>abc</sub>** to modify the number.
- To enable or disable Message Forwarding, press **3<sub>def</sub>**.
- To change the forwarding type, press **4<sub>ghi</sub>**.
  - Press **1.<sub>-></sub>** for Immediate Forwarding.
  - Press **2<sub>abc</sub>** for Silent Forwarding.
  - Press **3<sub>def</sub>** for Delayed Forwarding.

4 Press **\*<sub>left</sub>** **\*<sub>left</sub>** to return to the main menu.

### Pager Notifications

If you have purchased a pager and you would like your pager to notify you of incoming messages to your *i700plus* phone when it is turned off, you can activate this feature. To do so, call Nextel Customer Care at 1-800-639-6111 or dial 611 from your Nextel phone and provide them with the pager number.

#### Enabling/Disabling Pager Notification

1 From the main Voice Mail menu, press **4<sub>ghi</sub>** to access Personal Options.

2 Press **3<sub>def</sub>** to change Pager Notification Options.

3 Select the applicable option below:

- If Pager Notification is enabled press **3<sub>def</sub>** to disable it.
  - If Pager Notification is disabled press **3<sub>def</sub>** to enable it.
- \*Press **4<sub>ghi</sub>** to enable notification of urgent messages only.

4 Press **\*<sub>left</sub>** **\*<sub>left</sub>** to return to the main menu.

### Limiting Notification to Specific Times

This feature allows you to choose the hours you want the Pager Notification feature to be enabled. By default, it is enabled for 24 hours a day. However, you can change this. For example, you can select to be paged between 8:00 am and 5:00 pm only. This enables you to control the time frame Pager Notification will be activated. If a call comes in after 5:00 pm, you will not be paged until 8:00 am the next morning. (Before using this option, you may want to refer to “*Time and Date Charts*” on page 49 since the phone will only accept times in a 24-hour clock format.)

- |   |  |
|---|--|
| 1 | From the main Voice Mail menu, press <b>4</b> <small>ghi</small> to access Personal Options. |
| 2 | Press <b>3</b> <small>def</small> to change Pager Notification Options.                      |
| 3 | Press <b>5</b> <small>ijkl</small> to modify your notification time window.                  |
| 4 | Enter the starting and ending times for your time window.                                    |
| 5 | Press <b>*&lt;</b> <small>ijkl</small> <b>*&lt;</b> to return to the main menu.              |

## Paging and Messaging Services

Your Nextel phone offers two choices in Messaging Services—Text and Numeric Paging and the ultimate messaging product, Nextel Online Two-Way Messaging<sup>SM</sup>.

Text and Numeric Paging allows others to send you a message that is displayed directly on your Nextel phone. Nextel Paging helps keep you in touch with co-workers and customers, regardless of where you travel on the Nextel National Network.

Building on the success of Text and Numeric Paging, Two-Way Messaging uses the flexibility and convenience of Nextel Online Wireless Internet Services to provide immediate contact with the people important to you, even when you can't make or take a call. Two-Way Messaging allows you to send, receive and respond to text messages quickly and discreetly.

### About This Section

The main topics covered in this section are as follows:

Nextel Online Two-Way Messaging <sup>SM</sup>	Page 54
Text and Numeric Paging	Page 54
Notification of New Pages	Page 55
Alert Receipt	Page 55
Accessing New Pages	Page 55
Sending a Page	Page 56

## **Nextel Online Two-Way Messaging<sup>SM</sup>**

With Two-Way Messaging, you can:

- Receive messages (up to 500 characters in length) with built-in replies and respond to them at the touch of a button.
- Create and store your own frequently used responses that let you send informative answers without keying in text.
- Send messages to one individual from your phone or contact several at once from any email system or nextel.com
- Respond to messages when you're in a meeting or noisy location.

To activate this service, call Nextel Customer Care at 1-800-639-6111 or dial 611 from your Nextel phone. For additional information on how to use this service, download the Nextel Online Wireless Internet Service User's Guide from the nextel.com Web site.

## **Text and Numeric Paging**

With Nextel Text and Numeric Paging, Nextel will:

- Allow numeric pages up to 20 characters in length and text pages up to 140 characters in length.
- Accept your pages even if you are unavailable, if your phone is turned off, or if you are busy on another call.
- Alert you of a new text or numeric page, even if you are on another call.
- Store a page if you are using Nextel Direct Connect and deliver it upon completion of the call.
- Store the page if you are outside of the coverage area and deliver it as soon as you are back in a coverage area.
- Attempt continuous delivery of pages until successful, for up to 7 days.

With Nextel Text and Numeric Paging, your Nextel phone will:

- Refer to text and numeric pages as Message Mail.
- Stamp the page with the time and date the page was left.
- Store up to 16 pages at a time that will remain until you delete them.
- Allow for “Auto Call Back” of a phone number that is included within a page, by pressing . If the page contains two phone numbers, Auto Call Back will dial the last number.







**NOTE:** “Mail Waiting, Memory Full” displays when 16 message registers are full. (Messages must be erased before you can receive others.)

### Notification of New Pages

When a new page arrives:

- “New Mail Read?” displays.
-  flashes at the top of the screen.
- Phone rings every 30 seconds as an alert/reminder.





### Alert Receipt

Through your programming menu (    **1**  **5** ), you can delay Message Mail (and Voice Mail) alerts so that you are not interrupted by the alert tone while on a call. You can choose to receive all alerts, delay all alerts, or receive Message Mail alerts only.



### Accessing New Pages

When you receive a page, you can view it immediately or later:









#### *Viewing a Page Immediately*

1	Press  under “Now”. The number of new and saved pages is displayed briefly, followed by your first page.
2	Press  under “Read”.
3	Use the   on the side of the phone to scroll through messages.

## Viewing a Page Later

- 1 Press  under “Later”. The  icon will stop flashing but the  icon will remain on the display to remind you that you have a page.

## Viewing Stored Pages

- 1 While in **Phone** mode (see “Modes and Menus” on page 13) press  under “Mail”.
- 2 If **Mesg Mail** isn’t highlighted already, press  to select it.
- 3 Press  under “OK”.
- 4 Press  under “Read”.
- 5 Use the  on the side of the phone to scroll through messages.
- 6 Press  under “Save” to Save the message.  
Or, press  under “Erase” to delete the message.
- 7 Press  under “Exit” to exit **Mesg Mail**.

## Sending a Page

Nextel’s Paging feature includes four options: Web Paging (Web Messages), Email Paging, Numeric Paging and Operator Assisted Paging. To use these features review the following information.



### Web Paging (Web Messaging)

Nextel's Web Paging enables you to page yourself, someone else or a group of Nextel customers and includes "Schedule for Later" option, which allows you to send yourself reminders. To use Web Paging, follow the steps below:

<p><b>1</b> From your computer's Internet browser, go to nextel.com and click "Send a Message".</p>
<p><b>2</b> The browser automatically opens to "Send an Individual Message". To page an individual, or yourself, type the applicable 10-digit Nextel phone number (for example, 7035551234) in the "To" field.</p> <ul style="list-style-type: none"><li>• To send a Group Page, select "Group Messaging". In the "To" field, type an individual's 10-digit Nextel phone number. Next, click the "Add" button. The information is inserted in a new window and the "To" field is cleared so you can enter another 10-digit Nextel phone number. You can send a Group Message to up to 20 Nextel users at one time.</li><li>• To schedule a message for future delivery (up to 6 months in advance), click on "Schedule for Later". A new page appears with the following fields: Month, Day, Year, Hour, Min. (Minutes) and AM/PM. Click the down arrows at the end of each field to select the desired month, day, etc. Then click on the "OK" button to store your selections. (The "Cancel" button closes the page without saving your selections.)</li></ul>
<p><b>3</b> Type a Subject and a message in the message box.</p> <p>You can click on the "Count Characters" button to have the system tell you the number of characters in your message. The total includes characters from the "To", "From", and "Subject" fields as well as system generated characters. You can send text messages up to 280 characters in length, sent as two sequential 140 character messages.</p>
<p><b>4</b> Click "Send Message" to send the message. (The "Clear" button removes the information from every field.)</p>
<p><b>5</b> A new browser page opens with a copy of your message, the recipient's telephone number and a Claim Number. You can write down the Claim Number to check on the delivery status later.</p>

## Checking Delivery Status

To find out whether or not a message was delivered, and, if so—when—follow the steps below:

1	Visit Nextel's home page at <a href="http://nextel.com">nextel.com</a> .
2	Select "Message Center".
3	Select "Message Status".
4	Enter the Recipient Telephone Number and the Claim Number.
5	Click on the "Check Status" button. The system will display the requested information.

## *Email Paging*

From any email account, type the 10-digit phone number, of a Nextel customer, in the "To" field and add [@page.nextel.com](mailto:@page.nextel.com) (for example, [7035551234@page.nextel.com](mailto:7035551234@page.nextel.com)). The entire message can be up to 140 characters.

## *Numeric Paging*

- The caller must press "1" during your Voice Mail greeting.
- Only numeric pages can be sent.

## *Operator Assisted Paging\**

- The caller can press "2" during your Voice Mail greeting. Or, call 1-800-NEXGRAM (1-800-639-4726).
- A text page can be sent immediately or for future delivery.
- The operator will send the page.

*\* The Operator Assisted Paging feature is required. There is also an additional charge for each message sent. For more information you can visit Nextel at [nextel.com](http://nextel.com) or call 1-800-639-6111 or dial 611 from your Nextel phone.*

## Using Your Phone as a Modem

With Nextel Online<sup>SM</sup> Dial-Up Service, you can use your *i700plus* phone as a wireless modem! You can connect your IBM<sup>TM</sup>-compatible computer (using Microsoft<sup>®</sup> Windows 95/98 operating system), or Personal Digital Assistant (PDA), such as a Palm<sup>TM</sup> Pilot or Windows<sup>®</sup> CE handheld computer, to your *i700plus* phone and access your company's network or the Internet—all without the hassle of locating a telephone jack for a landline connection.

From anywhere within the guaranteed All-Digital Nextel National Network, you can conveniently access the time-critical information you need when you're on the go. With Nextel Online Dial-Up Service, simply connect the data cable (sold separately) to your *i700plus* phone and your computer or PDA to access email, field service reports, or the Internet.

**NOTE: For coverage area and billing information, visit us at [nextel.com](http://nextel.com).**



---

# Private/Group Mode

## Nextel Direct Connect®

Nextel Direct Connect is a revolutionary way to communicate with your co-workers and clients...for a fraction of the cost of traditional cellular calls.

You may want to talk to a co-worker right away, but you don't want to page that person or leave a lengthy message. Using Nextel Direct Connect's Private Call feature in **Private** mode, you can find them wherever they are in your home coverage area. Or, maybe you need to communicate a last-minute schedule change to your sales people...all 100 of them. It's easy using Nextel Direct Connect's Group Call feature in **Group** mode. This digital two-way radio feature lets you contact all of them at once!

In addition, Nextel has created Nextel Business Networks<sup>SM</sup>, which allows you to communicate with individuals outside as well as inside your company. These Networks link Nextel customers in similar industries or geographies. So, if you need to reach a client, vendor, or contractor instantly, work smarter by joining the Nextel Business Networks. For more information, call 1-888-NEXTEL2 (1-888-639-8352).



## About This Section

This section includes everything you will need to know to take advantage of Nextel Direct Connect (two-way radio) service:

Displaying Your Private ID	Page 62
Using the Private/Group Speaker	Page 62
Placing Private Calls	Page 63
Receiving Private Calls	Page 64
Quickstore of Private IDs	Page 64
Sending a Call Alert	Page 64
Receiving/Responding to a Call Alert	Page 65
Call Alert Queuing	Page 65
Group Calls	Page 66
Group-Silent Programming	Page 67

## Displaying Your Private ID



To display your Private ID:

Press  then  then .

## Using the Private/Group Speaker

You can disable or enable the speaker on your *i700plus* phone for Nextel Direct Connect use. (The default setting is Speaker On.) When the speaker is on, the caller's voice can be heard over the speaker. When the speaker is off, the caller's voice can only be heard through the earpiece of your phone.

### *Turning the Speaker Off*

Press   will appear on your display. A brief alert tone will notify you of incoming Private or Group calls.

### *Turning the Speaker On*

Press .





## Placing Private Calls

From **Private** mode, there are also two ways to reach an individual using Nextel Direct Connect. You can enter the person's Private ID number then press the Push-To-Talk button. Or, you can store the person's name and Private ID number, then recall the number from a stored list. Whether you dial the person's Private ID directly or store it in a list—you must have the individual's Private ID to use Nextel Direct Connect. To learn how to store names and numbers, see “*Storing Names and Numbers*” on page 17.

### Entering the Private ID

1	Press  until you see <b>Prvt Ready</b> .
2	Enter the Private ID.
3	Press and hold the Push-To-Talk button on the side of the phone to talk. Both phones will chirp before your voice can be heard.
4	Release the Push-To-Talk button to listen.

### Selecting a Name from a Stored List

1	Press  until you see <b>Prvt Ready</b> .
2	Press  to scroll through the names. Or, press  until “Name” appears. Press  under “Name” and enter the first initial of the name then press  to scroll through the names.
3	Press and hold the Push-To-Talk button on the side of the phone to talk. Both phones will chirp before your voice can be heard.
4	Release the Push-To-Talk button to listen.

**NOTE:** You may receive certain display messages when making a Direct Connect call. See “*Understanding Status Messages*” on page 111.



## Receiving Private Calls

When you receive a Direct Connect Private call, your phone will automatically switch to **Private** mode. You will hear a chirp indicating that someone is calling you. Press and hold the Push-To-Talk button to talk and release it to listen.

## Quickstore of Private IDs



Quickstore allows you to quickly store the Private ID for a received or sent call without having to enter the Programming menu.

With the Private ID displayed:

1	Press  under “Store”.
2	Enter the name associated with the Private ID.
3	Press  under “Store”. The Stored message displays with the name that you entered.

## Sending a Call Alert

You can send a call alert, which lets the recipient know that you would like to talk with them. When you send an alert, the recipient’s phone will chirp several times and your name/number will appear on their display, if they have stored your Private ID.

1	Press  until you see <b>Prvt Ready</b> .
2	Press  under “Alert”.
3	Select the person you want to alert by entering their Private ID or selecting their name from a stored list. (See “ <i>Selecting a Name from a Stored List</i> ” on page 63.)
4	Press and hold the Push-To-Talk button until “ <b>Alert-Sent Successful</b> ” displays. The alert plays intermittently until the individual clears it.



## Receiving/Responding to a Call Alert

When you receive an alert, your phone will automatically change to **Private** mode. It will also chirp and you will see the name or the number (if you have not stored the individual in a list) of the caller.

- 1 Press and hold the Push-To-Talk button to answer the call alert.
- 2 Press  under “Clear”, or any key, to clear the call alert.

**NOTE:** Call alert allows you to contact another Nextel Direct Connect subscriber at no cost, avoiding airtime charges.

**NOTE:** Until you answer, clear or queue the call alert, you will not receive any additional Phone, Private, or Group calls.



## Call Alert Queuing

Call alert queuing is a feature that allows you to save up to eight call alerts in a queue or list.

### Placing/Clearing a Call Alert in the Queue

When you receive a call alert, you can either clear the call alert or save it to the list for later recall.



To clear a call alert, press  under “Clear”.

To place a call alert in the queue, press  under “Queue” or  under “Mode”.

**NOTE:** If you receive multiple call alerts, the last received call alert displays and the remaining call alerts are stacked at the beginning of the queue.

### Responding to a Call Alert within the Queue

You can respond to the call alerts in any order. To select a call alert for response:

- 1 Press  under “Queue”.
- 2 Press  to scroll to the desired call alert.
- 3 Press and hold the Push-To-Talk button to answer the call alert. After you respond to the alert, it is removed from the queue.

## Group Calls

In a Group call, you can communicate instantly with a group of people that you have previously set up as a “Talkgroup”. Your Sales Representative or Nextel Customer Care must set up your Talkgroup by providing you with a Talkgroup number for each Talkgroup. After you have the number, you can assign each Talkgroup number a name and store it in your *i700plus* phone (see “*Naming a Talkgroup*” on page 66).

Talkgroups appear on your display as numbers or programmed names such as **SALES TEAM** or **Talkgrp 5**. Your Nextel phone can store up to 30 Talkgroups. You can receive Group calls only in the Talkgroups that you have predefined. Any communication activity within a Talkgroup automatically switches your phone to **Group** mode.

### *Naming a Talkgroup*

1	Press  then  then  then .
2	Press  under “OK”.
3	At <b>Add New Entry?</b> , press  under “OK”.
4	At <b>Enter ID</b> , enter the desired Talkgroup number.
5	Press  under “Store”.
6	At <b>Enter Name</b> , enter the desired Talkgroup name.
7	Press  under “Store”.

### *Making a Group Call*

1	From <b>Group</b> mode, press   to scroll to the desired Talkgroup.
2	Press  under “OK”.
3	Press and hold the Push-To-Talk button to talk. Release the Push-To-Talk button to listen.

## Receiving a Group Call

When you receive a Group call, you will hear a chirp. Your Nextel phone automatically switches to **Group** mode and the Talkgroup name displays. To join a Group call:

- |   |  |
|---|--|
| 1 | Wait for the caller to finish speaking.  |
| 2 | Press and hold the Push-To-Talk button to talk. Release the Push-To-Talk button to listen. |

**NOTE:** You can receive Group calls only in the Talkgroups that you have predefined.

## Group-Silent Programming

Group-Silent Programming enables you to silence incoming Group alerts and communication:

### Turning Group-Silent On/Off

- |   |   |
|---|---|
| 1 | Press <b>*←</b> then <b>#↗</b> then <b>3<sup>def</sup></b> then <b>8<sup>tuv</sup></b> .  |
| 2 | Press <b>⊙</b> under “On” or “Off”. (The available option depends on the current setting being used. For example, if “On” is the current setting, “Off” will be an option.) |
| 3 | Press <b>⊙</b> under “Exit”. The <b>Group Ready</b> screen displays as <b>Group-Silent</b> .  |



---

# Net Mode

**Net** mode uses your phone's built-in microbrowser to access a new suite of wireless data products known as Nextel Online<sup>SM</sup>. You can use your Nextel data-capable phone to access your itinerary, obtain driving directions, check weather and news updates, send and receive email, or even view the latest stock quotes from Wall Street. Access the specific information you need to get business done...easily...wirelessly!

To order Nextel Online Wireless Internet Services, call Nextel Customer Care at 1-800-639-6111. Nextel Online Wireless Internet Service is activated if the disk icon appears and the phone display reads **Net Ready** when in **Net** mode.

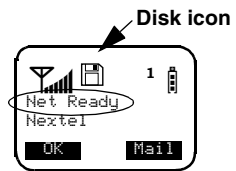

## About This Section

This section includes all the information you need to take advantage of the content and services available from Nextel Online Wireless Internet Service.

Net Mode Navigation Keys	Page 70
Launching the Microbrowser	Page 71
Using T9® Text Input	Page 72
Nextel Online Wireless Internet Services	Page 77

**NOTE:** Nextel Online Wireless Internet Services are part of the dynamic environment of the World Wide Web. Images and home pages presented throughout this guide may change. Additionally, the appearance of screens depends on the features and services to which you have subscribed. The screens illustrated in this manual are shown as a guide only and may be different than the ones on your actual phone screen display.

**NOTE:** Transmission and reception speed may vary, based on your relative position within the coverage area. If you are in a marginal location (close to the border of the coverage area), the throughput of your phone during data transmission may be affected. The maximum effective throughput for Nextel Online Wireless Internet Service is 19200 bps.



## Net Mode Navigation Keys

Some keys and buttons assume different functions when you are in **Net** mode. You can quickly and easily navigate within the phone's microbrowser by using the following keys:

**Mode:** Your data-capable phone operates in four different modes: **Phone** mode, **Private** mode, **Group** mode, and **Net** mode. Press  to switch between the four different modes.









**Home:** Press  to return to the home page.

**Back:** Press  to return to a previous page or screen.

**Scroll:** Arrows at the bottom of the phone screen () indicate that additional text can be viewed. Press  (scroll keys) or  (volume control/list buttons) to scroll one line at a time or press and hold to scroll one page at a time.

## Changing the Phone Display

You can change the phone display to enlarge the text on your screen. The factory default, and recommended setting, is 6 lines, 16 characters in length. To change the display to 4 lines with 12 characters in length, use the Programming Menu and follow the steps below:

- |   |  |
|---|--|
| 1 | Press  ,  ,  ,  to access the <b>Lines per Screen Programming Menu</b> . |
| 2 | Press  under "OK".  |
| 3 | Press the right arrow key  to change the setting.   |
| 4 | Press  under "OK".  |
| 5 | Press  under "Exit".  |

## Launching the Microbrowser

Just as you use Netscape Navigator® or Microsoft® Internet Explorer to browse the Web from your desktop, the microbrowser contained in your Nextel data-capable phone allows you to explore and use a variety of Internet services. Follow the steps below to begin using Nextel Online Wireless Internet Service:

1 Press **Mode** until the **Net Ready** screen displays.

2 Press **OK** under “OK”. A series of screens display in succession.

3 The first time you access your home page, you will be asked to enable security on your phone. Enabling this security feature ensures that the communications and transactions you complete on your phone and transmit over the Nextel National Network remain private and secure.

Press **OK** under “Yes” to enable the phone’s network security feature. The phone screen will display the following short messages: **Generating key..., Computing key..., Sending)**)).

4 After security is enabled, your home page displays and may appear similar to the one shown here. To return to this home page from anywhere within the various menus and sub-menus, press **#m**, the home key.



**NOTE: Home pages will vary depending on the Wireless Internet Service package to which you have subscribed.**

5 Scroll to highlight the service you wish to access and press **OK** under “OK”, or press the number shown to the left of your desired selection to automatically jump to that service.

6 You may press **Mode** at any time to return to another mode such as **Phone** mode, **Private** mode or **Group** mode.

## Using T9® Text Input

As you compose email or enter street and Web addresses on your Nextel phone, you will need to type words, numbers and symbols. Your Nextel data-capable phone has embedded software, called T9 Text Input, that makes typing on a phone keypad much like typing on a computer keyboard: it eliminates the traditional “multi-tap” method of text entry. As you type, you press only one key per letter. As you type, T9 Text Input matches your keystrokes to words in its linguistic database of approximately 60,000 words and proper names. You may also store additional words you frequently use in your own User Database, which is incorporated into the entire T9 Database.

### Entering Characters, Numbers and Symbols

In applications that require text input, such as Hotmail, Two-Way Messaging, and Search, there are four text entry modes available: Word, Alpha, Number, and Symbol.

**WORD or Word**—activates single-key-press T9 Text Input.

**ALPHA or Alpha**—activates standard keypad text entry called “multi-tap”.

**NUM**—allows entry of keypad numbers.

**SYM**—allows entry of punctuation symbols such as “@” or “?”.

The menu option in the lower right corner of the phone screen indicates your current text entry mode. If the option is “word,” you are in T9 Text Input mode. To change text entry modes, press the right  until you see the desired text entry mode.

### T9 Navigation Keys

Your phone keys assume different functions while in T9 Text Input mode just as they did when in **Net** mode. The following keys will be instrumental while using T9:

**Backspace/Erase:** Press  once to backspace or to erase a single character. Press and hold to erase the entire message.



**Space:** Press  once to accept a word and insert a space when entering text.

**Next:** Press  to display more words that match the keystroke sequence you entered. Words that you have added to your User Database will begin appearing after words stored in the T9 Database.



**Shift:** Press and hold  until you see the text entry mode indicator change to reflect the desired case. For example, when in lowercase the text entry mode will appear as “word” or “alpha.” When in uppercase, the text entry mode will appear as “WORD” or “ALPHA.”

**NOTE:** The default for word and alpha mode is uppercase at the beginning of a sentence, lowercase elsewhere.

**Punctuation:** Press  to automatically insert a period, a comma or an apostrophe. Press  to display additional punctuation choices.

Press  to accept the punctuation and continue typing.

**NOTE:** Additional punctuation and symbols are available in SYM mode (see “Symbols Mode (SYM)” on page 75).

## Entering Text Using T9 Text Input (word mode)



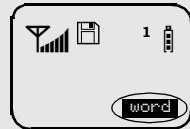

To learn how to enter text using T9 Text Input technology, follow the instructions below:

- 1 From any screen that displays one of the four text entry modes (**word**, **alpha**, **SYM**, **NUM**), press the right  until “word” displays.



- 2 Type your word by using one key-press per desired letter. The displayed word may change as you type it. Do not try to correct the word as you go. Type to the end of the word before editing. T9 Text Input matches your key strokes to words in its database and will display the most commonly used matching word.

- 3 If the word that appears is not the desired word, press  to change the word on the display to the next most likely word in the database. Repeat until the desired word appears.

**NOTE:** If the phone is not able to guess the word you are attempting to spell, press  to erase the current word on your screen. Press the right  until you see “alpha” and enter the word using the standard multi-tap option (see “Entering Text Using Alpha Mode & Adding Words to the User Database” on page 74). Do not add a space after your word. Return to T9 Text Input (word mode) by pressing  until “word” displays. Then press  to add a space. The word you just typed is automatically added to the User Database.





## Entering Text Using Alpha Mode & Adding Words to the User Database



Words that do not appear in the T9 Database may be added easily using multi-tap text entry in “alpha” mode. The “unknown” word is added to the User Database automatically so you can type it in “word” mode in the future. To add a word to the User Database, follow the steps below.

**NOTE: The User Database cannot store alphanumeric combinations (i.e., Y2K) or Web URLs.**

- 1 From any screen that displays one of the four text entry modes (**word, alpha, SYM, NUM**), press the right  until “alpha” displays.



- 2 Enter the word using multiple key presses as required for the desired letters. For example, to type “test”: press  once,  twice,  four times, and  once. Do not add a space.

- 3 Return to T9 Text Input (word mode) by pressing the right  until the T9 indicator “word” appears in the display. Press   to add a space. The word is automatically added to the User Database.

**NOTE: You must return to T9 mode to save your word in the User Database for future use.**

## Entering Punctuation and Symbols

There are two methods of entering punctuation: Smart Punctuation and Symbols Mode.

### Smart Punctuation



T9 Text Input uses Smart Punctuation to quickly apply basic rules of grammar to insert the correct punctuation within a word and at the end of a sentence. To insert punctuation, press **1**. If the punctuation mark displayed is not the one you want, press **0+** until you see the desired punctuation mark. Then press  to accept the punctuation and continue typing.

There are eight symbols available using Smart Punctuation (including . , - ' @ : ? ; ). For additional symbols, see Symbols Mode (SYM) below.

### Symbols Mode (SYM)

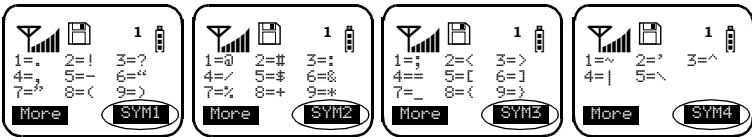
You can also enter punctuation and additional symbols using Symbols Mode (SYM). There are four screen pages within symbols mode, offering 32 different symbols.























- 1 From any screen that displays one of the four text entry modes (**word**, **alpha**, **SYM**, **NUM**), press the right  until "SYM" displays and the first page of symbols appears.
- 2 To select a symbol, press the number that corresponds with the symbol you want to enter. If the symbol you want to enter is not displayed, proceed to step 3.
- 3 Press  under "More". The SYM2 screen displays. Repeat to access additional symbol pages SYM3 and SYM4. To select the desired punctuation, press the number that corresponds with the symbol you want to enter.

## Numbers Mode (NUM)

- 1 From any screen that displays one of the four text entry modes (**word**, **alpha**, **SYM**, **NUM**), press the right  until “NUM” displays.
- 2 Press the desired number on your phone’s keypad.

## Entering Email Addresses





To enter an email address, you will need to toggle between the text entry modes. For example, to type the email address: john@company.com, follow the steps below:

- 1 In “word” mode, enter the username **john** by pressing    .
- 2 Press the right  until “SYM” is displayed. Press  under “More” until “SYM2” is displayed. Select “@” by pressing the corresponding number on the keypad.  
or  
Use Smart Punctuation to add “@”. Press  then  until the “@” symbol appears.
- 3 The phone automatically returns to “word” mode. Enter the company name: **company** by pressing       
 .
- 4 Press the right  until “SYM” is displayed. Press  under “More” until “SYM1” is displayed. Select “.” by pressing the corresponding number on the keypad.
- 5 The phone automatically returns to “word” mode. Enter the word “**com**” by pressing   . You may need to press  to display this word selection if necessary.

## Nextel Online Wireless Internet Services

Nextel Online extends the power of the Internet to your Nextel data-capable phone by allowing you to retrieve and send email, receive customized message alerts and access the specific Web information you need. Use of the following services requires the purchase of a Nextel Online Service Plan. This section gives you a general overview of the Internet services available on your Nextel data-capable phone.

To access any content or service, do the following:

- 1 Press   or   to scroll and highlight the service you wish to access and press  under “OK”, or press the number shown to the left of your desired selection to automatically jump to that service.
- 2 Follow the on-screen prompts in each individual sub-menu.

## MyApplications

Nextel Online Two-Way Messaging is the ultimate messaging product—allowing you to reach people important to you quickly and discreetly without talking on the phone. Two-Way Messaging uses the flexibility and convenience of Nextel Online Wireless Internet Services to allow you to send, receive and reply to text messages. With Two-Way Messaging, it’s never been easier to stay connected, informed and in control. To activate this service, call Nextel Customer Care at 1-800-639-6111 or dial 611 from your Nextel phone. For additional information on how to use this service, download the Nextel Online Wireless Internet Service User’s Guide from the [nextel.com](http://nextel.com) Web site.

Internet-based business applications are available to assist you in getting your business done, faster and without wires. Visit us at [nextel.com](http://nextel.com) for information on the business applications that are currently available.

## Shopping

Shop at the largest online stores with your Nextel data-capable phone, anytime it’s convenient for you. Search for product information and reviews; purchase business and personal merchandise, books and electronics, even construction tools and equipment—anything you need to get business done—from leading Internet shopping sites.

## Sites

Access information from selected Web sites that fit your business needs in areas such as finance, leisure, sports, travel, weather, and news. Content and content providers within this menu option are dynamic and may change frequently.

## MSN Mobile

MSN Mobile delivers customized content to you on your Nextel phone. For instructions on how to customize email filters and information that is important to you and your business, go to [nextel.com](http://nextel.com) and click on the Nextel Online button.

<p>Email and more...</p> <ul style="list-style-type: none"><li>• MSN Hotmail</li><li>• MSN Hotmail Address Book</li></ul>	<p>Access your existing Hotmail account or establish a new one from your phone. Read or delete your email, compose new email, reply or forward mail to others. Define the critical information you need to know about by creating email filters. Email filters will notify you of specific new email that has been sent to your Hotmail account. You can filter by name, subject or sender address.</p> <p>Access your Hotmail address book from your phone. View, create, edit and delete contact records including name, company name, phone numbers, Nextel numbers, and postal and email addresses. Dial directly from your phonebook by highlighting a contact's phone number and pressing  under "Call".</p>
<p>Find a...</p>	<p>Find local businesses close to home, work or other zip codes by entering a business name or searching by business category. <b>Find a...</b> also provides step-by-step driving directions from your point of origin.</p>

<p>Travel</p>	<p>Travel services include the following:</p> <p><b>Itinerary:</b> If you've booked travel arrangements through Expedia.com, you can access your itinerary, including flight and boarding information, as well as hotel and rental car accommodations and confirmations.</p> <p><b>Directions:</b> Obtain location specific directions on the quickest route possible from Sidewalk.com.</p> <p><b>Headlines:</b> View the latest travel, business and leisure headlines and excerpts from MSNBC.</p>
<p>Weather</p>	<p>MSN AccuWeather displays an abbreviated 5-day forecast for your zip code along with the option to change the city for which weather is displayed.</p>
<p>News</p>	<p>View the top 3 local and national news headlines from MSNBC.</p>
<p>Finance</p>	<p>Obtain the latest financial information from MoneyCentral. Options include:</p> <p><b>Portfolio:</b> View your personalized portfolio including individual stock quotes and market and trading activity.</p> <p><b>Quotes:</b> Enter a ticker symbol to obtain a stock quote as well as market and trading activity.</p> <p><b>Indexes:</b> Display the values of the top market indices and their respective market activity.</p> <p><b>News:</b> View the top business news headlines from MSNBC, WSJ, and MS Investor.</p> <p><b>NOTE:</b> Stock quotes and related information are delayed up to 20 minutes.</p>

Sports	<p>Obtain the latest sports scores and news with MSNBC Sports:</p> <p><b>Scoreboard:</b> Follow your favorite professional and college sporting events. Personalized and displayed by individual league, the scoreboard will present real-time scores from games within a 24-hour window.</p> <p><b>Headlines:</b> View the top sports headlines. Additional league-specific headlines are provided for MLB, NBA, NFL, NHL, golf, college football, and college basketball.</p>
Entertainment	<p>Access links to the top entertainment information, including:</p> <p><b>Lottery:</b> Check the lottery results for your preferred zip code or change cities to view lottery results for additional areas.</p> <p><b>Horoscope:</b> Access your personal horoscope or display a list of all signs.</p> <p><b>Headlines:</b> View the top entertainment headlines and abstracts from MSNBC. Additional headlines are available specifically for books, movies, TV and health.</p>
Personalize	<p>Customize the MSN Mobile information you obtain on your Nextel phone. Enter your zip code for weather forecasts, news headlines and lottery results; identify your favorite sports teams for your scoreboard; choose stock ticker symbols for your portfolio display; and pick your zodiac sign for your daily horoscope.</p>



## NextelServices

### List Manager

With List Manager, you won't have to enter each name and number using your phone's keypad. Use the convenience of your computer keyboard to quickly generate phone lists from the Web. You'll also have the ability to initiate changes from your phone and "Send" them to List Manager. Account Administrators can send lists to large groups of phones and synchronize the lists across multiple work groups.

See "List Manager" on page 21 for more information.

### Bookmarks

Bookmarks provide quick and easy access to your favorite Web sites and pages.

To add a bookmark, follow the steps below:

<p>1 In <b>Net</b> mode, navigate to the Web page or menu that you wish to bookmark.</p>	
<p>2 Push and hold <b>MENU</b> until the phone beeps and you are presented with the Browser Sub-Menu.</p>	
<p>3 Scroll down to "Mark Site" and press <b>○</b> under "OK".</p>	
<p>4 The bookmark name appears. Press <b>○</b> under "Save" to save the bookmark.</p>	
<p>5 The bookmark for that page will now be saved in the Bookmarks directory on your home page.</p>	

## To Recall a Bookmark

- 1 From your home page's Bookmarks directory, scroll down and highlight the bookmark representing the site you wish to visit. You can also press the number to the left of your desired bookmark to jump to that bookmark.

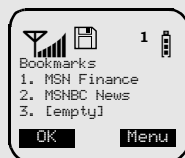

- 2 Press **OK** under "OK".

## To Delete a Bookmark

- 1 From your Bookmarks directory, scroll down and highlight the bookmark you wish to delete.
- 2 Press **Menu** under "Menu".
- 3 Scroll down to "Delete" and press **OK** under "OK".
- 4 If you would like to delete the bookmark, press **Yes**; otherwise, press **No**.

## Search

Browse the Internet from your phone! Under Search, Go to Site allows you to access wireless-enabled (Wireless Application Protocol or WAP) Internet sites. These WAP sites are specially developed Web sites for wireless devices, such as your Nextel data-capable phone, and omit the large pictures and graphics of typical Web sites. The phone screen will display similar information as on your computer screen except in a streamlined text format. Hyperlinks embedded within the site are usually functional and can be accessed by scrolling to and highlighting the desired link, then pressing **Link**. Should you happen to access a non-WAP enabled site, your phone may display fragments of text or an error message. The list of wireless-enabled sites is constantly growing to provide you with more ways to get business done.

## Entering Internet Addresses

To access a commercial (.com) Internet site from the Go to Site screen, you need not type in the full Web site address. The microbrowser defaults to “.com” Web address categories, so all you need to type is the name of the organization. The microbrowser will automatically add the “http://www.” prefix and the “.com” suffix for commercial sites. If you would like to access other Web site categories such as education (.edu), government (.gov), or networks (.net), you must type the entire Web address, including the *www.* and the applicable extension (i.e., .gov, .org, or .net). (Before typing on your phone, you may want to review Using T9 Text Input on “*Using T9® Text Input*” on page 72.) Examples are as follows:

### Commercial site

To visit [www.espn.com](http://www.espn.com), type:



### Government site

to visit [www.irs.gov](http://www.irs.gov), type:



**NOTE:** Search is not part of the basic Nextel Online pricing package.

---

**Frequently Asked Questions**

<b>Question</b>	<b>Answer</b>
What is a bookmark?	A bookmark is a shortcut to a Web page or pages that you plan to visit often. By creating bookmarks, you have an easy way to return to sites that you like, without having to remember the Web address.
Is there a limit to the number of sites I can bookmark?	You can store 100 bookmarks.
Are entries such as passwords case sensitive?	Yes, passwords are case sensitive and must be typed exactly as originally entered.
When can I change the text input mode?	You can change modes at any time during text entry. The current text entry mode is displayed in the lower right corner of your phone screen.
Is there a limit to the number of new words I can add to the User Database?	You may add approximately 150 words to the User Database before the database reaches capacity. At that point, any additional words that you add will replace the least used word in the database. Therefore, there is no actual limit to the number of new words you can add to the User Database.
How long will my words be saved in the User Database?	All words are saved in the database until it becomes full. When the database becomes full, the word used least recently is removed to allow entry of an additional word.

Question	Answer
Can words be removed from the T9 Database?	Words cannot be removed from the database. When the database becomes full, the least used word is removed to allow entry of an additional word.
Is there a limit to the length of the word to be added to the User Database?	Words in the User Database are limited to 32 characters in length.
When entering text, how can I change cases?	To create a capital letter, press and hold <b>#</b> until the text entry mode appears in all capital letters (i.e. "word" will change to "WORD"). The next letter you type will be a capital letter. The text entry mode will then return to the default, lowercase.
What's the best way to synchronize existing lists on my phone with List Manager?	To avoid losing your existing lists, you must send them from your phone to the Web site first.
I don't have phone numbers stored on my Nextel data-capable phone. What's the quickest way to enter my frequently used numbers?	Use the convenience of List Manager to set up your Speed Dial, Private ID, or Talkgroup list. Once the names and numbers are entered, "send" the list(s) from the Web site to your phone.

<b>Question</b>	<b>Answer</b>
List Manager data is not being transmitted from the Web to my phone. Why?	There are three potential reasons data sent from the Web site does not appear on your phone. 1. You may not have sent the data to your phone. Verify that you selected "send" from the Web site. 2. Your phone is not registered with List Manager. To register, on your phone, you must enter your member name and password (as originally registered with nextel.com). 3. You didn't accept the transmission from the Web site.
Where is the IMEI number?	The IMEI is the number found on the back of your phone. To locate the IMEI, turn off your phone and remove the battery. The IMEI is the 15-digit number located underneath the barcode.
Why does an error message appear when I try to access a Web site?	There are a number of reasons you may receive an error message when attempting to access a Web site, such as: the Web site is temporarily unavailable, the Internet is experiencing a heavy amount of traffic, or the page is having difficulty loading.

---

# Customizing the *i700plus* Phone









## About This Section

This section includes everything you will need to know to customize your *i700plus* phone:

Changing the Display Language	Page 87
Setting the Time and Date	Page 88
Backlight Timer	Page 89
Setting the Ringer Volume	Page 89
Selecting a Ring Style	Page 90
Setting the VibraCall™ Feature	Page 91
Programming Menus	Page 92

## Changing the Display Language

You can customize the *i700plus* phone to display menus in English, Spanish, French, or Portuguese. The default language is English. To change the display language:

1	Press  then  then  then  .
2	Press  under “OK”.
3	Press  to scroll the language options.
4	Press  under “OK” to select the desired language.
5	Press  under “Exit”.

## Setting the Time and Date

**IMPORTANT:** The Time and Date may not be available in your area and may not appear on your display. Once this feature becomes available, your *i700plus* phone will automatically display the local time and date.



You have a choice of a 12- or a 24-hour clock format, as shown in the table below:

<b>12-Hour Display</b>	12:00 am	6:25 am	12:00 pm	10:25 pm
<b>24-Hour Display</b>	00:00	06:25	12:00	22:25

You have a choice of either a MM/DD (month/day) or a DD/MM (day/month) date format as shown in the table below.

<b>Date</b>	<b>Month/Day Format (MM/DD)</b>	<b>Day/Month Format (DD/MM)</b>
January 2nd	01/02	02/01
December 31st	12/31	31/12

All of the modes (**Phone, Private, Group, Net**) display the time and date on the third line of the display. To set the time and date format once this feature is activated, follow the steps below:

- 1 Press then then then .
- 2 Press under "OK". The **Time/Date Display** screen appears. The default (preset) time and date format is "On". However, the time and date does not display until the Nextel National Network activates this feature. You may turn "off" this feature at this point.
- 3 Press until you see the **Time Format:** screen.



- 4 The hour format currently being used appears under **Time Format:**. To keep the current setting, simply skip to the next step.

Or, press  under the available option. (For example, if “12 hour” format is the current setting, “24hr” will appear as an option.)







- 5 Press  until you see the **Date Format:** screen. The format being used appears under **Date Format:**.

- 6 To keep your current format, press  under “Exit”.

Or, press  under the available date format. (For example, if MM/DD is the current setting, “DD/MM” will appear as an option.)

- 7 Press  under “Exit”. The **Phone, Prvt, Group, and Net Ready** screens display the selected time and date formats.







## Backlight Timer



Your phone’s backlight is what illuminates the display when you, for example, first receive or make calls. Through your Programming Menu (     ), you can customize the amount of time that your backlight remains illuminated, either 10, 20, or 30 seconds. See “*Programming Menus Shortcut and Options*” on page 93 for more information.

## Setting the Ringer Volume

You can adjust the ringer volume for incoming calls. For Alternate Line users, be sure to select the phone line before setting the ringer volume (See “*Selecting an Alternate Line*” on page 34).



- 1 Press   then   then  then . The display shows your current ringer volume.

- 2 Press  or  on the side of your phone to raise or lower the volume. The lowest setting is “Volume Silent.”

- 3 Once the desired level is found, press  under “Exit”.

## Selecting a Ring Style

With your *i700plus* phone, you even have a choice on how you'd like to be notified of incoming calls. Your Nextel phone has nine selectable ring styles. Users with Alternate Line Service can use the same ring style or different ring styles for each phone line, so you can tell which line is ringing. Be sure you are on the correct line when selecting a ring style.





- |   |   |
|---|---|
| 1 | Press <b>*</b> then <b>#</b> then <b>3</b> then <b>1</b> . The display shows your current ring style. |
| 2 | Press <b>OK</b> .   |
| 3 | Press <b>Left Arrow</b> or <b>Right Arrow</b> to scroll through the available <b>Ring Styles</b> .    |
| 4 | Press <b>Volume Up</b> on side of phone to listen to selected ring style.                             |
| 5 | Once the desired <b>Ring Style</b> is found, press <b>OK</b> .  |
| 6 | Press <b>OK</b> under "Exit".   |

## Setting the VibraCall™ Feature





The VibraCall alert is a vibration alert system that notifies you of incoming Phone, Private, or Group calls and messages by a repetitive vibration rather than a ring. You can select this alert system for all incoming calls/messages, or select individual services for VibraCall.

**NOTE:** When you set vibration alerts, they are set only for the current line. If you have a second phone line, you must select “Line 2” and repeat the procedure for selecting all services or selecting individual services to vibrate.





VibraCall Settings	What this setting does
<b>Vibrate Alert</b>	Vibrates for all incoming calls and messages.  —Vibrate All appears on the display.  —Speaker Off appears on the display to remind you that the audio will be heard through the earpiece instead of the speaker.
<b>Phone Vibrate</b>	Vibrates only for incoming phone calls and Nextel Online data calls.
<b>Phone Vibrate/Ring</b>	Vibrates and rings for phone calls and Nextel Online data calls and Net alerts.
<b>Mail Vibe</b>	Vibrates for Message Mail and Net alerts.
<b>Group/Prvt Vibe</b>	Vibrates for incoming group and private calls.

### Using Vibrate Alert

To activate Vibrate Alert:

Press  then  then  then  under “All”. The *i700plus* phone will emit a brief vibration and will also vibrate briefly on subsequent power-ups.

To deactivate Vibrate Alert:

Press  then  then  then  under “Off” then  under “Exit”. The *i700plus* phone will emit a brief ring and will also ring briefly on subsequent power-ups.

## Using Phone, Mail and Group/Prvt Vibrate Option

To use **Phone Vibrate**, **Phone Vibrate/Ring**, **Mail Vibe** or **Group/Prvt Vibe** follow the steps below:

- |   |   |
|---|---|
| 1 | Press  then  then .   |
| 2 | Press  until you see the “Selct” option.  |
| 3 | Press  under “Selct”. The first selection is <b>Phone Vibrate:</b> . Then press  to scroll to <b>Mail Vibe:</b> , then <b>Group/Prvt Vibe:</b> . To use <b>Phone Vibrate/Ring</b> , from <b>Phone Vibrate:</b> display, press  then press  under “V/Rng”. |
| 4 | Press  under “On” or “Off” (whichever is applicable).   |
| 5 | Press  under “Exit”.  |

## Programming Menus

You can customize the settings on your phone using the Programming menus. Many of them have been discussed throughout this guide.

You can access this menu from the **Phone**, **Private**, or **Group** modes.

- |   |  |
|---|--|
| 1 | Press  until you see the “Prgm” option.  |
| 2 | Press  under “Prgm”.   |
| 3 | Press  under “OK”.   |
| 4 | Press  to scroll the Programming menu options. Or, enter the option using the Programming Menus Shortcut on page 93. |

## Programming Menus Shortcut and Options

Press **\*←** , **#→** then enter the Option Number from the following table:

Option Number	Menu Option	Function
1	<b>Own Ph#</b>	Store and display your Nextel handset's telephone number. See " <i>Programming Your Own Phone Number</i> " on page 14 and " <i>Displaying Your Phone Number</i> " on page 14.
2	<b>Own PvtID</b>	Display your Nextel handset's Private ID. See " <i>Displaying Your Private ID</i> " on page 62.
3	<b>Mail Display</b>	Turn on or off the New Mail message that is displayed with incoming Voice, Message, or Net Mail.
4	<b>Manual Lock: On/Off</b>	Lock your phone to prevent unauthorized use. You must enter a password to unlock it.
5	<b>Auto Lock: On/Off</b>	Automatically lock your phone each time it is powered off to prevent unauthorized use.
6	<b>Auto Answer: On/Off</b>	Turn on or off automatic answering of incoming phone calls after 1-4 rings.
9	<b>Vibrate Alert: On/Off</b>	Provide non-audible notification of incoming phone and Nextel Online data calls and messages. See " <i>Setting the VibraCall™ Feature</i> " on page 91.
10	<b>Last Call Timer</b>	Display the duration of the most recent phone call.

<b>Option Number</b>	<b>Menu Option</b>	<b>Function</b>
11	<b>Display Timer: On/Off</b>	Turn on or off automatic display of the Last Call Timer at the end of each phone call.
12	<b>Reset Timer</b>	Display cumulative airtime of all phone calls since the last time the timer was reset.
13	<b>Total Timer</b>	Display cumulative airtime of all phone calls.
14	<b>1 Minute Beep: On/Off</b>	Automatically signal each minute of elapsed phone airtime with an audible beep.
15	<b>Alert Receipt</b>	Delays Voice Mail and Message Mail alerts so that you are not interrupted by the alert tone while on a call. You can choose to receive all alerts, delay all alerts, or receive Message Mail alerts only.
16	<b>Backlight Timer</b>	Specify the duration of the Backlight Timer (10, 20, or 30 seconds).
20	<b>Phone/Prvt List</b>	Add phone and Private ID numbers in one procedure. See <i>“Creating, Editing and Using Stored Lists”</i> on page 17.
21	<b>Phone List Edit</b>	Edit or erase up to 100 frequently called phone numbers and associated names. See <i>“Editing Stored List Entries”</i> on page 20.
22	<b>Prvt ID List Edit</b>	Edit or erase up to 100 Private ID numbers and associated names. See <i>“Editing Stored List Entries”</i> on page 20.
23	<b>Talkgrp List Program</b>	Add, edit, or erase numbers and associated names for up to 10 pre-programmed Talkgroups. See <i>“Naming a Talkgroup”</i> on page 66.

Option Number	Menu Option	Function
24	<b>Area List Program</b>	Add, edit, or erase numbers and associated names for up to 50 targeted areas.
30	<b>Ringer Volume</b>	Set the ringer volume using the volume control keys, or lower the volume to silence the ringer.
31	<b>Set Ring Style</b>	Select a distinct ring style for incoming phone calls.
32	<b>Mail Volume</b>	Set the volume of Message Mail, Voice Mail, and Net Mail alert tones using the volume control keys. Or lower the volume to silence the mail alert tones.
33	<b>Earpiece Volume</b>	Set the default earpiece volume using the volume control keys.
34	<b>Keypad Volume</b>	Set the volume of the keypad tones using the volume control keys, or to silence the keypad tones.
35	<b>Speaker Volume</b>	Temporarily adjust the Private/Group speaker volume for noisy environments.
36	<b>Spkr Vol Set Tone</b>	Turn the speaker volume set tones on or off.
38	<b>Silent Group: On/Off</b>	Silence all incoming Group call alerts and voice activity. When set, your screen displays the message, "Group-Silent". See "Turning Group-Silent On/Off" on page 67.
40	<b>Change Passcode</b>	Change your secret four-digit password from the initial setting 0000.

Option Number	Menu Option	Function
60	<b>Set Baud Rate</b>	Set the modem baud rate between the phone and the PC. See Nextel Online Dial-Up Service User's Guide.
61	<b>Data Ring Volume</b>	Set the default data ringer volume using the volume control buttons. See Nextel Online Dial-Up Service User's Guide.
62	<b>Pgm Data#</b>	View your circuit data number. See Nextel Online Dial-Up Service User's Guide.
63	<b>IP Address</b>	View the Internet Protocol (IP) Address-1 for your microbrowser, as programmed in your phone. If your phone is cabled to a computer, view IP Address-2, the stored IP address of your computer. Use the scroll keys to view either one.
64	<b>Reset KBytes Tx/Rx</b>	View the number of Kilobytes sent and received for data.
65	<b>Lines per Screen</b>	Select 4 lines, 12 characters or 6 lines, 16 characters (default).
70	<b>Language</b>	Select one of four languages for your display text. The default is English. See <i>"Changing the Display Language"</i> on page 87.
71	<b>Time/Date*</b>	Select the standard or 24-hour time and MM/DD or DD/MM date format. <i>*Not available in all areas.</i>



**Do not try to program menus 41 through 51 as you could permanently damage your phone. They are for Nextel Customer Care use only and should never be programmed by customers.**



<b>Option Number</b>	<b>Menu Option</b>	<b>Function</b>
<b>41</b>	<b>Feature Reset</b>	Returns all feature settings to their original defaults.
<b>42</b>	<b>Master Clear</b>	Performs Feature Reset and erases all stored lists.
<b>43</b>	<b>Master Reset</b>	Resets the phone's identification number.
<b>44</b>	<b>Change Service Key</b>	Changes or resets the fraud prevention service key.
<b>50</b>	<b>NAM</b>	Selects alternate Numeric Assignment Module (NAM).
<b>51</b>	<b>Network ID</b>	Edits the pre-programmed Network number list and select roaming options.

## Ordering Information

*Nextel Business Networks<sup>SM</sup> allow you to communicate with individuals outside as well as inside your company. These Networks link Nextel customers in similar industries or geographies. So, if you need to reach a client, vendor, or contractor instantly, work smarter by joining the Nextel Business Networks. Call 1-888-NEXTEL2 (1-888-639-8352).*

*Various accessories are available for use with your i700plus phone, including a Hands-Free Car Kit, Swivel Belt Clip, and Cigarette Lighter Adapter. To order accessories discussed in this guide, or for a brochure of additional accessories, call Nextel Nextday<sup>SM</sup> Accessories at 1-800-914-3240 or contact your Nextel Authorized Representative.*

*Call Nextel Customer Care at 1-800-639-6111 or 611 from your i700plus phone to order any of the services discussed in this guide, including Nextel Online Services, Direct Connect, Additional Phone Services, Voice Mail, Paging Features and much more!*

*For information on Direct Protect<sup>SM</sup> Insurance protection for your Nextel phone and more, call 1-888-352-9182 or contact your Nextel Authorized Representative.*

*Visit us at [nextel.com](http://nextel.com) to learn more about Nextel products and services!*

## Accessories

### Batteries

**NOTE:** For best results, charge the batteries within the temperature range of 10°C to 40°C (50°F to 104°F). Prolonged charging is not recommended. See below for battery charging times.

#### *Charging the Battery*

To get the maximum use from the battery, charge it for at least 10 hours before you use it for the first time. See Table below for battery charging times. While your *i700plus* phone is attached to a charger you can leave the phone off, turn it on, or use it. For best charging results, leave it off.

Attach the charger to the *i700plus* phone via the Side Charging Jack (see Features Bookmark), and plug the charger into an electrical outlet.

#### Battery Charging Times

Motorola Battery	Charging Time to 90%:	
Description Chemistry	Standard Travel Charger	Rapid Travel Charger
Standard NiMH	7 hours	105 minutes

#### *Battery Operating Instructions*

- Extreme temperatures will degrade battery performance. Do not store your battery where temperatures exceed 60°C (140°F) or fall below -20°C (4°F).
- The battery capacity will be degraded if stored for long periods while fully charged. If long term storage is required, store at half capacity.
- For optimal battery life, use a Motorola iDEN approved NiMH charger with your Motorola iDEN NiMH battery. Other chargers may not fully charge your NiMH or may yield reduced number of charge cycles.

## Travel Chargers

Using a Travel Charger, you can charge a battery from an electrical outlet.

You can use:

- The Standard Travel Charger
- The Rapid Travel Charger with U.S. adaptor plug

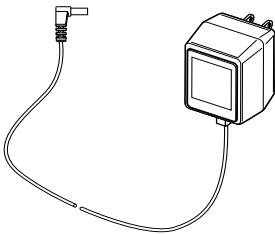

**Standard Travel Charger**

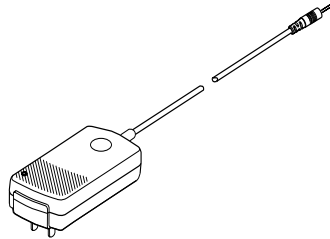

**Rapid Travel Charger**

### *Using the Standard Travel Charger*

- |  |
|--|
| <b>1</b> Insert the Standard Travel Charger's power supply plug into an electrical outlet (110V U.S.). |
| <b>2</b> Insert the charger's DC plug into the Side Charging Jack on your <i>i700plus</i> phone.       |

### *Using the Rapid Travel Charger (110V/220V/240V)*

- |   |
|---|
| <b>1</b> Insert the wall plug adapter into the Rapid Travel Charger's power supply.   |
| <b>2</b> Insert the charger's power supply into an electrical outlet (110V/220V/240V International).  |
| <b>3</b> Insert the DC plug into the Side Charging Jack of your <i>i700plus</i> phone. The power light (green LED) turns on when the Rapid Travel Charger is receiving power. |

### Standard Travel Charger Operating Specifications

Input voltage range: 110V - U.S.  
 Operating temperature range: 0°C to +50°C.

### Rapid Travel Charger Operating Specifications

Input voltage range: 110V/220V/240V - International.  
 Operating temperature range: 0°C to +50°C.

## Cigarette Lighter Adapter

The Cigarette Lighter Adapter enables in-vehicle communications by charging the NiMH battery and providing power to your *i700plus* phone.

The power light (green LED) will light when the Cigarette Lighter Adapter is receiving power.

### Using the Cigarette Lighter Adapter

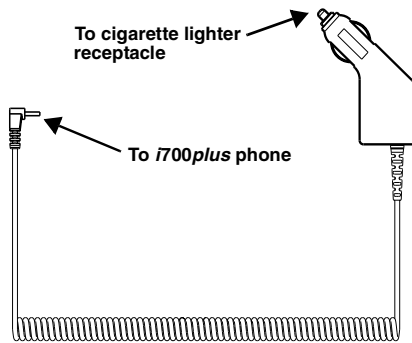

- |   |   |
|---|---|
| 1 | Insert the Cigarette Lighter Adapter's DC plug into the Side Charging Jack of your <i>i700plus</i> phone.           |
| 2 | Push firmly until the plug rests securely in the accessory charger connector.                                       |
| 3 | Remove the vehicle's cigarette lighter plug (if one exists) from the cigarette lighter receptacle.                  |
| 4 | Plug the Cigarette Lighter Adapter into the cigarette lighter receptacle. The power light (green LED) will turn on. |

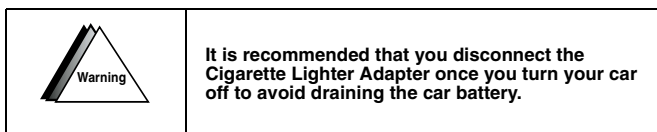

## Removing the Cigarette Lighter Adapter

- 1 Unplug the Cigarette Lighter Adapter from the vehicle's cigarette lighter receptacle.
- 2 Gently pull the plug from the Side Charging Jack of your i700plus phone.

## Cigarette Lighter Adapter Operating Specifications

Operating voltage range: 10.8 - 33.0 Vdc.

Operating temperature range: -30°C to +60°C.

## Desktop Dual-Pocket Charger

The Desktop Dual-Pocket Charger charges Motorola authorized batteries, as listed on page 99, for the i700plus phone.

**NOTE:** The Desktop Dual-Pocket Charger should only be powered by the included Rapid Power Supply. The charger will flash both LEDs red if the Standard Travel charger is attached.

## Charging a Battery

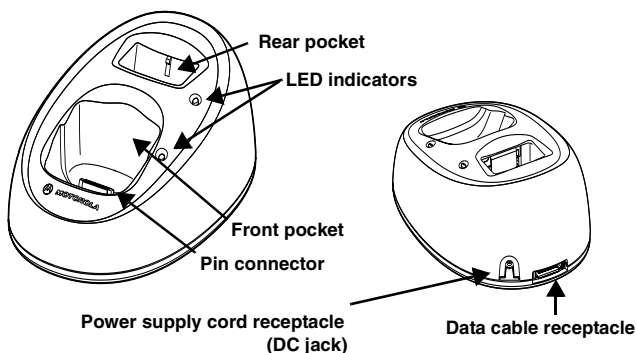

**NOTE:** Charging times may vary when performing data operations.

- 1 Insert the power supply's DC jack plug into the DC jack receptacle on the back of the charger.

**NOTE:** Use only with the Motorola rapid charger included with your Desktop Charger package.

- 2 Plug the power supply end of the power-supply cord into any standard AC outlet. The charger performs a quick power-up self-test. The LED indicators will flash once to indicate a successful power-up.

- 3 Attach a battery to your *i700plus* phone.

- 4 Place the accessory and data cable connector on your *i700plus* phone into the pin connector located in the charger's front pocket.

### Adding and Removing a Battery from the Rear Pocket

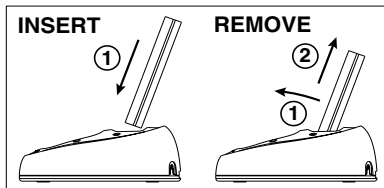

- 1 Insert the battery with the Motorola label facing forward and the (+) and (-) symbols pointing downward.
- 2 To remove the battery, pull it forward, then up and out of the charger.

**NOTE:** If a battery is in the rear pocket and the *i700plus* phone with a battery is inserted into the front pocket, the battery in the front pocket will charge to full capacity before the battery in the rear pocket is charged. The LED for the rear pocket flashes yellow, indicating that its battery is waiting to be charged. To remove the battery from the rear pocket, hold the base of the charger and pull the battery forward then straight up.

## *Desktop Charger Status*

The charger displays the battery's charge status. The indicator will show one of the following:

solid red =1-30%; solid yellow =31-60%; flashing green =61-90%;  
solid green =91-100%.

## *Desktop Charger Troubleshooting*

If the battery is not charging and there is:

A flashing yellow indicator—

- If a battery is in the rear pocket, the rear pocket's LED continues to flash yellow (indicating that the charger's pocket is in a "Wait State") until the battery in the front pocket is more than 90% charged (front pocket's LED is solid green). This is normal operation.
- To protect your battery's life expectancy, the charger does not rapid charge a battery when its temperature is below 5°C (41°F) or above 45°C (113°F).

No LED indication—

- Check that the *i700 plus* phone with battery, or a battery alone, is inserted correctly.
- Make sure that the power supply is plugged into an appropriate AC outlet and that the connector is properly seated.
- *Rear pocket only:* Remove the battery from the charger. Use an ordinary pencil eraser to clean the three metal contacts on the battery and then place the battery in the charger.
- If the LED indicator remains turned OFF, the battery may be defective and should be replaced.

A flashing red indicator—

- Remove the battery from the charger. Use an ordinary pencil eraser to clean the metal contacts on the battery and then place the battery into the charger.
- If the LED indicator continues to flash red, the battery may be defective and should be replaced.
- If both LEDs flash red, this indicates that the incorrect power supply is plugged in.



## Audio Adapter

**NOTE:** The use of wireless devices and their accessories (“devices”) may be prohibited or restricted in certain areas. Always obey the laws and regulations on the use of these devices.

The Audio Adapter connects an earpiece microphone or headset to your *i700plus* phone for privacy and hands-free operation.

The Audio Adapter fits onto the bottom of the *i700plus* phone and provides a standard 2.5mm jack connection for an earpiece microphone or headset.

### Using the Audio Adapter

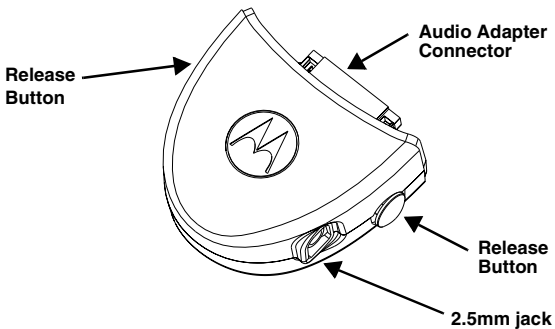

- 1 Hold the phone and the Audio Adapter facing you so that you see the Motorola logo on the adapter.
- 2 Insert the Audio Adapter's connector into the *i700plus* phone Accessory and Data Cable Connector. You will hear the connector snap into place.

### Attaching/Detaching the Earpiece Microphone or Headset

- 1 Insert the 2.5mm plug of the earpiece microphone or headset cord into the jack of the Audio Adapter.
- 2 Pull on the plug, not the cord, to remove the earpiece microphone.

**NOTE:** When the Audio Adapter and earpiece are connected, all audio, including tones, will be routed to the audio accessory's earpiece.

## Removing the Audio Adapter

- 1 Simultaneously press the release buttons located on each side of the Audio Adapter.
- 2 Pull the Audio Adapter from the *i700plus* phone.

## Dash Mount Holder

The Dash Mount Holder provides a convenient holder for your *i700plus* phone. The Dash Mount Holder can be installed either horizontally or vertically.

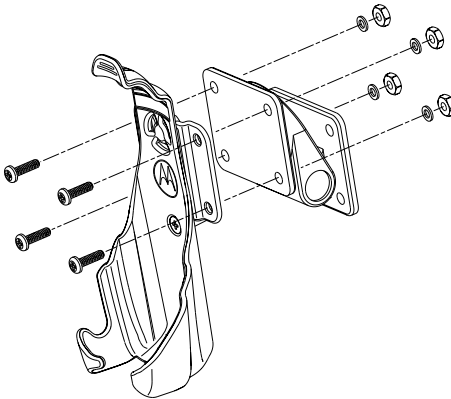
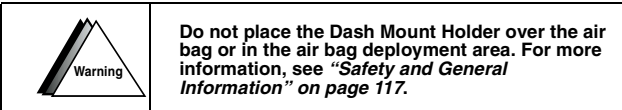

## Using the Dash Mount Holder

- 1 Mount the Dash Mount Holder to the dash of your vehicle by securing the four self-tapping screws to the base of the holder. Or, for a semi-permanent installation, use the included adhesive strip.
- 2 Snap your phone securely into the holder.

## Swivel Belt Clip

The Swivel Belt Clip provides a convenient means by which to carry your *i700plus* phone with you.

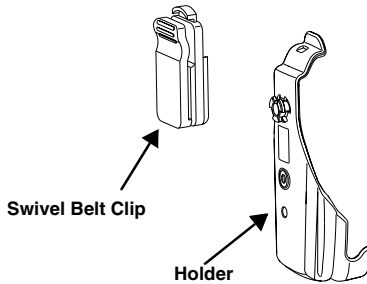

1	Attach the Swivel Belt Clip to your belt.
2	Insert your <i>i700plus</i> phone into the belt clip holder and attach the holder to the Swivel Belt Clip.
3	To remove your <i>i700plus</i> phone from the holder, push the holder tab inward while pulling the phone outward.
4	To remove your <i>i700plus</i> phone and the holder from the Swivel Belt Clip, push down on the button on top of the Swivel Belt Clip and lift the phone out.

## Leather Carry Case

The Leather Carry Case helps to protect your *i700plus* phone while on the go. Its leather belt clip attaches easily to your belt or purse. The front of the carry case is a clear plastic cover which enables you to use your *i700plus* phone without removing it from its case.

The Leather Carry Case accommodates most *i700plus* phone accessories, including Travel Chargers, audio accessories, vehicle accessories, and data accessories. (See Nextel Online Dial-Up Service User's Guide.)

## Hands-Free Car Kit

**NOTE: The use of wireless devices and their accessories (“devices”) may be prohibited or restricted in certain areas. Always obey the laws and regulations on the use of these devices.**

	<p>The Hands-Free Car Kit is also a charger. Therefore, <b>DO NOT</b> operate this kit and the Cigarette Lighter Adapter at the same time.</p>
---	--

The Hands-Free Car Kit enables in-vehicle communications by providing a built-in speaker, a power supply for the phone’s internal battery charger, hands-free visor microphone, Dash Mount Holder and power to the phone.

An external Push-To-Talk (PTT) switch is also present. When the phone is turned off, the Hands-Free Car Kit charges the Standard battery in 105 minutes to 90% capacity. Charging time will be longer if the phone is operational during charge time.

### Using the Hands-Free Car Kit

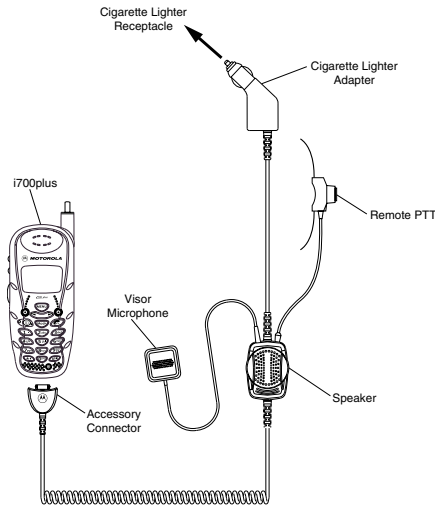

- 1 While holding the *i700plus* phone with its front toward you, insert the accessory connector (Motorola logo facing you) into the Accessory and Data Cable Connector until it clicks into place.
- 2 Remove the vehicle's cigarette lighter from the cigarette lighter receptacle.
- 3 Plug the Hands-Free Car Kit's cigarette lighter adapter into the cigarette lighter receptacle. The power light (green LED) will come on.
- 4 Selecting the correct position for the Hands-Free Visor Microphone is vital for the performance of the hands-free circuitry. It is recommended that the microphone be mounted either on the sun visor directly above (and facing) the driver, or on the headliner, just above (and facing) the driver.



The Visor Microphone should NOT be located within 12 inches of the speaker box.

It should never be mounted near the vehicle's window, or in a spot where the road and ambient noise are substantially high.

It should be mounted so that it does not come into contact with the airbag, or interfere with airbag deployment.

- 5 Turn on your *i700plus* phone.
- 6 Adjust the speaker volume using the volume control buttons on your *i700plus* phone.

To remove the *i700plus* phone:

Push the Motorola logo button on the accessory connector and remove the connector from the phone.

**NOTE:** The *i700plus* phone should only be used with a Hands-Free Car Kit that has a gray button on the accessory connector. The use of any other hands-free car kit will result in an "incompatible accessory" message on the phone's display.



---

# Other Important Information

## Nextel Customer Care

Relax! Nextel Customer Care is here to help. There are lots of features packed into your Nextel service...and into your *i700plus* phone. But don't worry. If, after reading this guide, you still have questions about coverage, billing, Nextel Direct Connect or any other service or feature, call us.

- **Domestic Customer Care Support:** 1-800-639-6111 or dial 611 from your Nextel phone.
- **International Roaming Customer Care Support:** 1-201-531-5202 (toll-free from your Nextel phone).

We'll be happy to give you help, explanations and anything else you need to enjoy your Nextel service as soon as possible!

Before you call Nextel Customer Care for service or to resolve an issue, be sure to have your IMEI number and your Model number ready. These numbers are located on a sticker behind the battery on the back of your Nextel phone. Your IMEI number is a 15-digit number beginning with "000". The Model number is a 10-digit alpha-numeric code. You'll want to record these numbers, and keep them handy, so that you can replace the battery prior to making your call. Use the Quick Reference Card located on the back cover for easy reference.

## Understanding Status Messages

You may receive status messages under certain conditions. Before contacting your carrier, note the message, numeric code, and the conditions under which it appeared. The following table lists and describes the status messages.

Status Messages	Message Description
<b>Number Not in Service</b>	The number that you entered is not valid.
<b>User Not Available</b>	The phone that you called is either busy, out-of-range, or turned off. Please try again later.

<b>Status Messages</b>	<b>Message Description</b>
<b>User Not Authorized</b>	The party that you called has not purchased this service.
<b>Please Try Later</b>	This service is temporarily not available. Please try again later.
<b>User Busy in Private</b>	The phone that you called is busy in a Private call.
<b>User (Target) Busy in Data</b>	The phone that you called is busy using Nextel Online services.
<b>Service Restricted</b>	This service was restricted by your service provider or it was not purchased.
<b>Service Not Available</b>	This feature is not available on the current network.
<b>System Busy Try Later</b>	The system is experiencing heavy traffic. Please try again later.
<b>Status Messages</b>	<b>Message Description</b>
<b>Service Conflict</b>	This service cannot be enabled because an incompatible service has already been turned on.
<b>Please Try Again</b>	An error occurred. Note the error code and try again.
<b>Self Check Error</b>	A fault was detected with your Nextel phone. If this error recurs, note the error code and contact Customer Care.
<b>Self Check Fail</b>	An operational fault was detected with your phone. Note the numeric code, turn your Nextel phone off, and contact Customer Care.



## **Nextel Terms and Conditions of Service**

### **Terms and Conditions**

**TERMS AND CONDITIONS OF SERVICE:** Before calling the Nextel Customer Service Activation Number contained in these materials, you ("Customer") must read and agree to the following terms and conditions of Nextel wireless telephone service ("Service"). By calling to activate service, Customer applies and subscribes for Services provided by Nextel (the "Company") and confirms that Customer has read, understands, agrees to and accepts the terms and conditions stated herein. Customer understands that Company will rely upon the information provided by Customer including credit information, in making a decision to provide Services. Customer understands that Company may request and verify Customer's bank references and perform a credit history check utilizing standard commercial credit reference services in connection with Company's review of the Customer's credit worthiness. Customer understands that a security deposit or air time usage limit may be required.

1. **USE OF SERVICE**—Customer must comply with all FCC rules and regulations. Customer will not use the Service for any unlawful purpose. Customer will not use the Service in aircraft.

2. **CREDIT APPLICATION**—This Agreement shall be contingent upon Company's approval of Customer's credit. Company may require Customer to update credit information from time to time. Customer warrants and represents that all credit information furnished is complete, accurate and true. If Company subsequently determines that any statements regarding Customer's credit are false, incomplete or inaccurate, Company may declare Customer to be in default and may exercise any remedies it has under these Terms and Conditions of Service and at law or in equity.

3. **CUSTOMER RADIO EQUIPMENT**—Company is not responsible for the installation, operation, quality of transmission or maintenance of the equipment. Company reserves the right to change or remove assigned codes and/or telephone numbers when such change is reasonably necessary in the conduct of its business. Customer does not have any proprietary interest in such codes or telephone numbers. Federal and state laws make it illegal for third parties to listen in on service, however complete privacy cannot be guaranteed.

4. **SECURITY DEPOSITS**—Company has the right, in its sole discretion, to require Customer to make a deposit to guarantee payment of Service charges. Customer grants Company a security interest in such deposits, to secure the payment of all sums due thereunder as well as the performance of all other obligations Customer may have to the Company whether now existing or hereafter arising. Upon termination of Service, Company may apply the deposit against any outstanding Service charges of Customer or any other amount owed to Company. Company reserves the right to interrupt services if service appears to have excessive charges or any unusual calling patterns are observed on Customer's account. Such interruption may be done to protect Customer or Company as the Company determines in its sole discretion.

5. **RATES, CHARGES AND PAYMENTS**—Company shall issue invoices for Service on a monthly basis which are due and payable upon receipt. Monthly Access Charges shall be invoiced in advance. Airtime and long-distance charges shall be invoiced in arrears. Customer is responsible to pay Company on a timely basis, for charges for Service payments as set forth on the Company's then-current rate plans, and any modifications thereto. Customer acknowledges that chargeable time for telephone calls originated by a unit begins when a connection is established with Company facilities. Customer accepts responsibility for Airtime charges from invoicing telephone calls to its mobile unit from the time that Customer responds to the call. If Customer disputes any Service charges,

Customer must pay entire amount set forth in the invoice by the due date and submit a written explanation within forty-five (45) days from the date on the invoice. If Company determines that an error was made on Customer's invoice, Company shall credit Customer's account in the amount of the error. If Customer does not pay the amount in dispute, Company may exercise any remedies it may have for non-payment of Service charges. Company reserves the right to modify any and all elements of the Service charges at any time. Payments which are not received within thirty (30) days from the day of the invoice shall be subject to late payment charges. If Customer does not make payments, such failure shall be a default and Company shall be entitled to exercise any remedies it may have under these Terms and Conditions of Service or at law or in equity.

6. **NONPAYMENT/BREACH**—A late payment charge of 1.5% (or the maximum interest rate permitted by law) per month, may be applied to Customer's account if monthly invoices are not paid by the due date. The later payment charge is applied to the total unpaid balance due and outstanding. The late payment charge is for costs related to the non-timely payment and shall be deemed an interest payment. A charge of \$25.00 will be made by Company for any check or negotiable instrument tendered by Customer and returned unpaid by a financial institution for any reason. Company may demand payment by money order, cashier's check or similarly secure form of payment, at Company's discretion. If Company obtains the service of a collection or repossession agency or an attorney to assist the Company in remedying Customer's breach of any payment obligations, Customer shall be liable for this expense. Customer understands that in the event of nonpayment of charges or any other breach of these Terms and Conditions of Service in addition to any other remedies the Company may have, Company may temporarily or permanently terminate Service to Customer. If Company disconnects the Service, Customer shall be liable to pay a re-connect charge of \$25.00 per unit, in addition to the outstanding Service charges before the Company will reactivate Service. Company reserves the right to modify the terms of service as a precondition to reactivating service.

7. **TAXES**—Customer is responsible for all federal, state and local taxes for fees which are computed in accordance with the appropriate tax laws for Services.

8. **LIMITATION AND CONDITION OF LIABILITY/INDEMNITY**—The Company's sole liability for Service disruption, whether caused by the negligence of the Company or otherwise, is limited to a credit allowance not exceeding an amount equal to the proportionate charge to the Customer for the period of Service disruption. In no event is the company or lessor liable for actual consequential or special damages caused by its negligence or otherwise nor for economic loss, personal injuries or property damages sustained by customer or any third parties. Customer agrees to indemnify, defend and hold Company harmless from any Customer violations of FCC rules and regulations or Customer violation of any statutes, ordinances or laws of any local, state or federal public authority.

9. **NOTICE REGARDING USE OF SERVICE FOR 911 OR OTHER EMERGENCY CALLS**—The Service provider hereunder does not interact with 911 and other emergency services in the same manner as land line telephone service. Depending on the circumstances of a particular call, the Service provided hereunder may not be able to identify your location to emergency services and may not always be connected to the appropriate emergency services provider. Customer agrees to hold company harmless against any and all claims, demands, actions or causes of action (including all actions by third parties) arising out of the use or attempted use of the company's service to access 911 or other emergency services.

10. **NO WARRANTY (SERVICE)**—Company makes no warranties, express or implied, including without limitation, any implied warranty of merchantability or fitness for a particular purpose to customer in connection with its use of the service. In no event shall company be liable for incidental or consequential damages to the full extent the same may be disclaimed by law. Customer acknowledges that service interruptions will occur from time to time and agrees to hold company harmless for all such interruptions.

11. **NO WARRANTY (EQUIPMENT)**—Company makes no warranties or representations of any kind, statutory, expressed or implied, to customer or any other purchaser of equipment activated on the service. Without limiting the foregoing, company specifically makes no express or implied warranties of merchantability or fitness for a particular purpose. Customer hereby waives all other warranties, guarantees, conditions or liabilities, express or implied, arising by law or otherwise. In no event shall company be liable for consequential, special or incidental damages, whether or not occasioned by company negligence and including, without limitation, liability for any loss or damage resulting from the interruption or failure in the operation of any equipment activated on the service. There are no warranties which extend beyond the description contained herein. Customer assumes the entire risk as to the quality and performance of the equipment. If the equipment proves defective, the costs of all necessary servicing and repair will be borne by the customer.

12. **NEXTEL BUSINESS NETWORKS**—There is no group call available on the Nextel Business Networks. There is no pooling of Nextel Direct Connect minutes between companies on the Nextel business networks. It is possible that participants on the Nextel Business Network could determine the private identification numbers of customer's units and be able to private call those units. It is also possible that users of customer units could determine the private identification numbers of other Nextel Business Network participants and private call them.

© 2000 Nextel Communications, Inc. All rights reserved. Nextel, the Nextel logo, Nextel Worldwide, Nextel Direct Connect, Nextel Nextday and Nextel Business Networks are trademarks and/or service marks of Nextel Communications, Inc.

MOTOROLA, the Stylized M Logo and all other trademarks indicated as such herein are trademarks of Motorola, Inc. \* Reg. U.S. Pat. & Tm. Off. \* 2000 Motorola, Inc. All rights reserved. Manufactured under one or more of the U.S. patents listed in the User's Guide.

## **[Notice of] Addendum to Nextel Subscriber Agreement Terms and Conditions**

The parties hereby agree to the following additional terms and conditions with respect to Company's [data service]. By activating any of the Company [data services], Customer agrees to the terms and conditions set forth herein.

1. **APPLICATION COMPATIBILITY.** Certain applications offered by Company or authorized third parties may be compatible with the Equipment and/or the Service offered by Nextel (the "Applications"). Customer acknowledges and agrees that there is no guarantee or assurance that the Applications are compatible, or will continue to be compatible, with Nextel's System or any of its product or service offerings. Such compatibility or approval from Nextel of compatibility shall not be construed as an endorsement of the Application or a commitment on the part of Nextel that the Applications will continue to be compatible with the System, Equipment or Service for any period of time. Company reserves the right, in its sole discretion, to disable and discontinue an Application for any reason.

2. **APPLICATION CUSTOMER CARE AND SUPPORT.** Customer acknowledges and agrees that in most cases, the developer of an Application is responsible for providing customer care and Application support to all Customers using the Application. In the event Customer contacts Company customer care with an issue that has arisen as a result of the use of an Application, the Customer may be referred to the Application developer's customer care.

3. **NO WARRANTY—COMPANY MAKES NO WARRANTIES, EXPRESS OR IMPLIED, INCLUDING WITHOUT LIMITATION, ANY IMPLIED WARRANTY OF MERCHANTABILITY OR FITNESS FOR A PARTICULAR PURPOSE TO CUSTOMER IN CONNECTION WITH COMPANY'S [DATA SERVICE] OR ANY APPLICATION AND THE COMPATIBILITY, FUNCTIONALITY AND USABILITY OF THE APPLICATION WITH THE SYSTEM OR NEXTEL'S PRODUCTS AND SERVICES.**

4. **NON-LIABILITY OF THE COMPANY.** COMPANY SHALL NOT BE RESPONSIBLE FOR SPECIAL, INDIRECT, INCIDENTAL, CONSEQUENTIAL OR PUNITIVE DAMAGES OF ANY KIND, INCLUDING WITHOUT LIMITATION, LOST PROFITS OR OTHER MONETARY LOSS, ARISING OUT OF THE PERFORMANCE OR FAILURE OF NEXTEL'S SYSTEM, PRODUCTS OR SERVICES, INCLUDING BUT NOT LIMITED TO COMPANY'S [DATA SERVICE] AND ANY APPLICATION, WHETHER OR NOT ANY SUCH MATTERS OR CAUSES ARE WITHIN COMPANY'S CONTROL OR DUE TO NEGLIGENCE OR OTHER FAULT ON THE PART OF COMPANY, ITS AGENTS, AFFILIATES, EMPLOYEES OR OTHER REPRESENTATIVES.

5. All terms and conditions of Company's subscriber agreement shall continue in full force and effect.

## Safety and General Information

**IMPORTANT INFORMATION ON SAFE AND EFFICIENT OPERATION.**

**READ THIS INFORMATION BEFORE USING YOUR INTEGRATED MULTI-SERVICE PORTABLE RADIO.**

### **For the safe and efficient operation of your radio, observe these guidelines:**

Your radio product contains a transmitter and a receiver. When it is *ON*, it receives and transmits radio frequency (RF) energy. The radio operates in the frequency range of 806 MHz to 870 MHz and employs digital modulation techniques. When you communicate with your radio product, the system handling your call controls the power level at which your radio product transmits. The output power level typically may vary over a range from 0.00024 watts to 0.6 watts.

### **Exposure To Radio Frequency Energy**

Your Motorola Radio Product is designed to comply with the following national and international standards and guidelines regarding exposure of human beings to radio frequency electromagnetic energy:

- United States Federal Communications Commission, Code of Federal Regulations; 47 CFR part 2 sub-part J
- American National Standards Institute (ANSI) IEEE. C95. 1-1992
- National Council on Radiation Protection and Measurements (NCRP). Report 86
- International Commission on Non-Ionizing Radiation Protection (ICNIRP) 1998
- National Radiological Protection Board of the United Kingdom, GS 11, 1988
- Verband Deutscher Elektrotechniker (VDE) DIN-0848
- Department of Health and Welfare Canada. Safety Code 6

To assure optimal radio product performance and make sure human exposure to radio frequency electromagnetic energy is within the guidelines set forth in the above standards, always adhere to the following procedures:

When placing or receiving a phone call, or using the group and private call functions with a Group/Private Speaker OFF (muted speaker icon visible in the display), hold your radio product as you would a telephone. Speak directly into the microphone and position the antenna up and over your shoulder.

When using your radio product as a traditional two-way radio while making group or private calls with the Group/Private Speaker ON (no speaker icon visible in the display), hold the radio product in a vertical position with the microphone one to two inches (2.5 to 5 cm) away from the lips.

For body-worn operation, with or without an earpiece or any other accessory, the antenna should be kept at least one inch (2.5 cm) from the body when transmitting. A Motorola plastic carry holder with a belt clip and a leather carry case are available as accessories to this radio product for body-worn use.



When using any data feature of the radio product, with or without an accessory cable, position the antenna of the radio product at least one inch (2.5 cm) from the body.

DO NOT hold the antenna when the radio is "IN USE". Holding the antenna affects call quality and may cause the radio product to operate at a higher power level than needed.

## **Interference to Medical and Personal Electronic Devices**

Most electronic equipment is shielded from RF energy. However, certain equipment may not be shielded against the RF signals from your radio product.

### **Pacemakers**

The Health Industry Manufacturers Association recommends that a minimum separation of 6 inches (15 cm) be maintained between a handheld wireless phone and a pacemaker to avoid potential interference with the pacemaker. These recommendations are consistent with the independent research by and recommendations of Wireless Technology Research.

Persons with pacemakers should:

- ALWAYS keep the radio product more than six inches from the pacemaker when the radio product is turned ON.
- Not carry the radio product in a breast pocket.
- Use the ear opposite the pacemaker to minimize the potential for interference.
- Turn the radio product OFF immediately if you have any reason to suspect that interference is taking place.

### **Hearing Aids**

Some radio products may interfere with some hearing aids. In the event of such interference, you may want to consult your hearing aid manufacturer to discuss alternatives.

### **Other Medical Devices**

If you use any other personal medical device, consult the manufacturer of your device to determine if it is adequately shielded from external RF energy. Your physician may be able to assist you in obtaining this information.

Turn your radio product OFF in health care facilities when any regulations posted in these areas instruct you to do so. Hospitals or health care facilities may be using equipment that could be sensitive to external RF energy.

### **Interference to Other Electronic Devices**

- RF energy may affect improperly installed or inadequately shielded electronic operating and entertainment systems in motor vehicles. Check with the manufacturer or representative to determine if these systems are adequately shielded from external RF energy. Also check with the manufacturer of any equipment that has been added to the vehicle.
- Turn your radio product OFF before boarding any aircraft to prevent possible interference to aircraft systems. Regulations of the United States Federal Communications Commission prohibit use when the plane is airborne. The United States Department of Transportation regulations require you have permission from a crew member to use your radio product while the plane is on the ground.

## Safety and General

### Use While Driving

Check the laws and regulations on the use of wireless telephones in the area where you drive. Always obey them.

When using the radio product while driving, please:

- Give full attention to driving and to the road.
- Use hands-free operation, if available.
- Pull off the road and park before making or answering a call if driving conditions so require.



### Operational Warnings

#### Potentially Explosive Atmospheres

Turn off your radio product when you are in any area with a potentially explosive atmosphere, unless it is a radio product type especially qualified for use in such areas (for example, Factory Mutual Approved). Sparks in a potentially explosive atmosphere can cause an explosion or fire resulting in bodily injury, or even death.

**NOTE:** The areas with potentially explosive atmospheres referred to above include fueling areas such as: below decks on boats; fuel or chemical transfer or storage facilities; areas where the air contains chemicals or particles such as grain, dust or metal powders; and any other area where you would normally be advised to turn off your vehicle engine. Areas with potentially explosive atmospheres are often, but not always posted.

#### Batteries

Do not replace or charge batteries in a potentially explosive atmosphere. Contact sparking may occur while installing or removing batteries and cause an explosion.

#### Blasting Caps and Areas

To avoid possible interference with blasting operations, turn off your radio product when you are near electrical blasting caps, in a blasting area, or in areas posted: "Turn off two-way radio". Obey all signs and instructions.

#### For Vehicles Equipped with an Air Bag

Do NOT place objects, including both installed and portable wireless equipment, in the area over the air bag or in the air bag deployment area. An air bag inflates with great force. If in-vehicle wireless equipment is improperly installed and the air bag inflates, serious injury could result.



## Operational Cautions

### Damaged Antennas

**Do not use any portable radio product that has a damaged antenna. If a damaged antenna comes into contact with your skin, a minor burn can result.**

### Batteries

**All batteries can cause property damage and/or bodily injury such as burns if a conductive material such as jewelry, keys, or beaded chains touch exposed terminals. The conductive material may complete an electrical circuit (short circuit) and become quite hot. Exercise care in handling any charged battery, particularly when placing it inside a pocket, purse, or other container with metal objects.**

## Cleaning and Drying Considerations

Using a leather carry case may help protect the surfaces and help prevent liquids (e.g., rain) from entering into the interior of the radio product. This product is not water proof, and exposing the unit to liquids may result in permanent damage to the unit.

If your radio product interior gets wet, then do not try to accelerate drying with the use of an oven or a dryer as this will damage the radio product and void the warranty. Instead, do the following:

1. Immediately power off the radio product.
2. Remove Battery from radio product.
3. Shake excess liquid from phone.
4. Place phone and battery in an area that is at room temperature and has good air flow.
5. Let phone and battery dry for 72 hours before reconnecting the battery and/or powering on the phone.

If the phone does not work after following the steps listed above, contact your dealer for servicing information.

Clean the external surfaces of the radio product with a damp cloth, using a mild solution of dishwashing detergent and water. Some household cleaners may contain chemicals that could seriously damage the radio product. Avoid the use of any petroleum-based solvent cleaners. Also, avoid applying liquids directly on the radio product.

## Antenna Considerations

Use only the supplied or an approved antenna. Unauthorized antennas, modifications, or attachments could impair call quality, damage the radio product, or result in violation of local agency regulations.



## Accessory Safety Information

### IMPORTANT: SAVE THESE ACCESSORY SAFETY INSTRUCTIONS

- Before using any battery or battery charger, read all the instructions for and cautionary markings on (1) the battery, (2) the battery charger, which may include a separate wall-mounted power supply or transformer, and (3) the radio product using the battery.
- Do not expose any battery charger to water, rain, or snow as they are designed for indoor or in-vehicle use only.

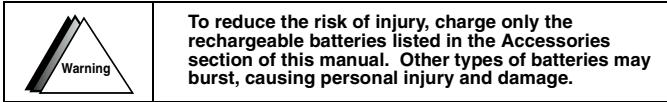

- To reduce the risk of damage to the cord or plug, pull by the plug rather than the cord when you disconnect the battery charger from the power source outlet.
- Do not operate any battery charger with a damaged cord or plug - replace them immediately.
- Battery chargers may become warm during operation, but not hot. If it becomes hot to the touch, unplug it from the power outlet immediately and discontinue its use.
- Use of a non-recommended attachment to a battery charger may result in a risk of fire, electric shock, or injury to persons.
- Make sure the battery charger power cord is located so that it will not be stepped on, tripped over, or subjected to damage or stress.
- An extension cord should not be used with any battery charger unless absolutely necessary. Use of an improper extension cord could result in a risk of fire and electric shock. If an extension cord must be used, make sure that:
  - The pins on the plug of the extension cord are the same number, size, and shape as those on the plug of the charger.
  - The extension cord is properly wired and in good electrical condition.
  - The cord size is 18AWG for lengths up to 100 feet and 16AWG for lengths up to 150 feet.
- Do not operate any battery charger if it has received a sharp blow, has been dropped, or has been damaged in any way; take it to a qualified service technician.
- Do not disassemble a battery charger; take it to a qualified service technician when service or repair is required. Incorrect reassembly may result in a risk of electric shock or fire.
- Maximum ambient temperature around the power supply or transformer of any battery charger should not exceed 40°C (104°F).
- The output power from the power supply or transformer must not exceed the rating given on the Desktop Dual-Pocket Charger.
- The disconnection from the line voltage is made by unplugging the power supply from the AC receptacle.
- To reduce risk of electric shock, unplug any battery charger from the outlet before attempting any maintenance or cleaning.
- For optimum charging performance, turn off the radio product while charging it in any battery charger.

---

## Limited Warranty Motorola Communication Products

**NOTE: This Limited Warranty applies within the fifty (50) United States and the District of Columbia**

### I. WHAT THIS LIMITED WARRANTY COVERS AND FOR HOW LONG:

MOTOROLA, INC. ("MOTOROLA") warrants the MOTOROLA manufactured iDEN Communication Products listed below ("Product") against defects in material and workmanship under normal use and service for a period of time from the date of purchase as scheduled below:

iDEN Subscriber Digital Mobile and Portable Units	One (1) Year
Product Accessories	One (1) Year

Rechargeable Batteries will be replaced during the applicable warranty period if:  
the battery capacity falls below 80% of rated capacity, or  
the battery develops leakage.

MOTOROLA, at its option, will at no charge either repair the Product (with new or reconditioned parts), replace it (with a new or reconditioned Product), or refund the purchase price of the Product during the warranty period provided it is returned in accordance with the terms of this warranty. Replaced parts or boards are warranted for the balance of the original applicable warranty period. All replaced parts of Product shall become the property of MOTOROLA.

This express limited warranty is extended by MOTOROLA to the original end user purchaser only and is not assignable or transferable to any other party. This is the complete warranty for the Product manufactured by MOTOROLA. MOTOROLA assumes no obligations or liability for additions or modifications to this warranty unless made in writing and signed by an officer of MOTOROLA. Unless made in a separate agreement between MOTOROLA and the original end user purchaser, MOTOROLA does not warrant the installation, maintenance or service of the Product.

MOTOROLA cannot be responsible in any way for any ancillary equipment not furnished by MOTOROLA which is attached to or used in connection with the Product, or for operation of the Product with any ancillary equipment, and all such equipment if expressly excluded from this warranty. Because each system which may use the Product is unique, MOTOROLA disclaims liability for range, coverage, or operation of the system as a whole under this warranty.

### II. GENERAL PROVISIONS:

This warranty sets forth the full extent of MOTOROLA'S responsibilities regarding the Product, Repair, replacement or refund of the purchase price, at MOTOROLA'S options, is the exclusive remedy. THIS WARRANTY IS GIVEN IN LIEU OF ALL OTHER EXPRESS WARRANTIES. IMPLIED WARRANTIES, INCLUDING WITHOUT LIMITATION, IMPLIED WARRANTIES OF MERCHANTABILITY AND FITNESS FOR A PARTICULAR PURPOSE, ARE LIMITED TO THE DURATION OF THIS LIMITED WARRANTY. IN NO EVENT SHALL MOTOROLA BE LIABLE FOR DAMAGES IN EXCESS OF THE PURCHASE PRICE OF THE PRODUCT, FOR ANY

LOSS OF USE, LOSS OF TIME, INCONVENIENCE, COMMERCIAL LOSS, LOST PROFITS OR SAVINGS OR OTHER INCIDENTAL, SPECIAL OR CONSEQUENTIAL DAMAGES ARISING OUT OF THE USE OR INABILITY TO USE SUCH PRODUCT, TO THE FULL EXTENT SUCH MAY BE DISCLAIMED BY LAW.

### III. STATE LAW RIGHTS:

SOME STATES DO NOT ALLOW THE EXCLUSION OR LIMITATION OF INCIDENTAL OR CONSEQUENTIAL DAMAGES, OR LIMITATION ON HOW LONG AN IMPLIED WARRANTY LASTS, SO THE ABOVE LIMITATIONS OR EXCLUSIONS MAY NOT APPLY.

This warranty gives specific legal rights, and there may be other rights which may vary from state to state.

### IV. HOW TO GET WARRANTY SERVICE:

You must provide proof of purchase (bearing the date of purchase and Product item serial number) in order to receive warranty service and, also, deliver or send the Product item, transportation and insurance prepaid, to an authorized warranty service location. Warranty service will be provided by MOTOROLA through one of its authorized warranty service locations. If you first contact the company which sold you the Product (e.g., dealer or communication service provider), it can facilitate your obtaining warranty service. You can also call MOTOROLA at 1-800-453-0920 for warranty service location information.

### V. WHAT THIS WARRANTY DOES NOT COVER:

- a. Defects or damage resulting from use of the Product in other than its normal and customary manner.
- b. Defects or damage from misuse, accident, water, or neglect.
- c. Defects or damage from improper testing, operation, maintenance, installation, alteration, modification, or adjustment.
- d. Breakage or damage to antennas unless caused directly by defects in material workmanship.
- e. A Product subjected to unauthorized Product modifications, disassemblies or repairs (including, without limitation, the addition to the Product of non-MOTOROLA supplied equipment) which adversely affect performance of the Product or interfere with MOTOROLA'S normal warranty inspection and testing of the Product to verify any warranty claim.
- f. Product which has had the serial number removed or made illegible.
- g. Rechargeable batteries if:
  1. Any of the seals on the battery enclosure of cells are broken or show evidence of tampering.
  2. The damage or defect is caused by charging or using the battery in equipment or service other than the Product for which it is specified.
- h. Freight costs to the repair depot.
- i. A Product which, due to illegal or unauthorized alteration of the software/firmware in the Product, does not function in accordance with MOTOROLA'S published specifications or the FCC type acceptance labeling in effect for the Product at the time the Product was initially distributed from MOTOROLA.

- j. Scratches or other cosmetic damage to Product surfaces that does not effect the operation of the Product.
- k. Normal and customary wear and tear.

**VI. PATENT AND SOFTWARE PROVISIONS:**

MOTOROLA will defend, at its own expense, any suit brought against the end user purchaser to the extent that it is based on a claim that the Product or parts infringe a United States patent, and Motorola will pay those costs and damages finally awarded against the end user purchaser in any such suit which are attributable to any such claim, but such defense and payments are conditioned on the following:

- a. That MOTOROLA will be notified promptly in writing by such purchaser of any notice of such claim;
- b. That MOTOROLA will have sole control of the defense of such suit and all negotiations for its settlement or compromise; and
- c. Should the Product or parts become, or in MOTOROLA'S opinion be likely to become, the subject of a claim of infringement of a United States patent, that such purchaser will permit MOTOROLA, at its option and expense, either to procure for such purchaser the right to continue using the Product or parts or to replace or modify the same so that it becomes non-infringing or to grant such purchaser a credit for the Product or parts as depreciated and accept its return. The depreciation will be an equal amount per year over the lifetime of the Product or parts as established by MOTOROLA.

MOTOROLA will have no liability with respect to any claim of patent infringement which is based upon the combination of the Product or parts furnished hereunder with software, apparatus or devices not furnished by MOTOROLA, nor will MOTOROLA have any liability for the use of ancillary equipment or software not furnished by MOTOROLA which is attached to or used in connection with the Product or any parts thereof.

Laws in the United States and other countries preserve for MOTOROLA certain exclusive rights for copyrighted MOTOROLA software, such as the exclusive rights to reproduce in copies and distribute copies of such MOTOROLA software. MOTOROLA software may be used in only the Product in which the software was originally embodied and such software in such Product may not be replaced, copied, distributed, modified in any way, or used to produce any derivative thereof. No other use including, without limitation, alteration, modification, reproduction, distribution, or reverse engineering of such MOTOROLA software or exercise or rights in such MOTOROLA software is permitted. No license is granted by implication, estoppel or otherwise under MOTOROLA patent rights or copyrights.

## Limited Warranty Motorola Communication Products (International)

**NOTE: This Limited Warranty applies in Singapore and the Philippines.**

### I. WHAT THIS LIMITED WARRANTY COVERS AND FOR HOW LONG:

MOTOROLA warrants the MOTOROLA manufactured iDEN Communication Products listed below ("Product") against defects in material and workmanship under normal use and service for a period of time from the date of purchase as scheduled below:

iDEN Subscriber Digital Mobile and Portable Units	One (1) Year
Product Accessories (manufactured by or under license from MOTOROLA)	One (1) Year

Rechargeable Batteries will be replaced during the applicable warranty period if:  
the battery capacity falls below 80% of rated capacity, or  
the battery develops leakage.

MOTOROLA, at its option, will at no charge either repair the Product (with new or reconditioned parts), replace it (with a new or reconditioned Product), or refund the purchase price of the Product during the warranty period provided it is returned in accordance with the terms of this warranty. Replaced parts or boards are warranted for the balance of the original applicable warranty period. All replaced parts of Product shall become the property of MOTOROLA.

This express limited warranty is extended by MOTOROLA to the original end user purchaser only and is not assignable or transferable to any other party. This is the complete warranty for the Product manufactured by MOTOROLA. MOTOROLA assumes no obligations or liability for additions or modifications to this warranty unless made in writing and signed by an officer of MOTOROLA. Unless made in a separate agreement between MOTOROLA and the original end user purchaser, MOTOROLA does not warrant the installation, maintenance or service of the Product.

MOTOROLA cannot be responsible in any way for any ancillary equipment not furnished by MOTOROLA which is attached to or used in connection with the Product, or for operation of the Product with any ancillary equipment, and all such equipment if expressly excluded from this warranty. Because each system which may use the Product is unique, MOTOROLA disclaims liability for range, coverage, or operation of the system as a whole under this warranty.

### II. GENERAL PROVISIONS:

This warranty sets forth the full extent of MOTOROLA'S responsibilities regarding the Product, Repair, replacement or refund of the purchase price, at MOTOROLA'S options, is the exclusive remedy. THIS WARRANTY IS GIVEN IN LIEU OF ALL OTHER EXPRESS WARRANTIES. IMPLIED WARRANTIES, INCLUDING WITHOUT LIMITATION, IMPLIED WARRANTIES OF MERCHANTABILITY AND FITNESS

FOR A PARTICULAR PURPOSE, ARE LIMITED TO THE DURATION OF THIS LIMITED WARRANTY TO THE FULL EXTENT SUCH MAY BE DISCLAIMED BY LAW. IN NO EVENT SHALL MOTOROLA BE LIABLE FOR DAMAGES IN EXCESS OF THE PURCHASE PRICE OF THE PRODUCT, FOR ANY LOSS OF USE, LOSS OF TIME, INCONVENIENCE, COMMERCIAL LOSS, LOST PROFITS OR SAVINGS OR OTHER INCIDENTAL, SPECIAL OR CONSEQUENTIAL DAMAGES ARISING OUT OF THE USE OR INABILITY TO USE SUCH PRODUCT, TO THE FULL EXTENT SUCH MAY BE DISCLAIMED BY LAW.

### **III. HOW TO GET WARRANTY SERVICE:**

You must provide proof of purchase (bearing the date of purchase and Product item serial number) in order to receive warranty service and, also, deliver or send the Product item, transportation and insurance prepaid, to an authorized warranty service location. Warranty service will be provided by MOTOROLA through one of its authorized warranty service locations. If you first contact the company which sold you the Product (e.g., dealer or communication service provider), it can facilitate your obtaining warranty service.

### **IV. WHAT THIS WARRANTY DOES NOT COVER:**

- a. Defects or damage resulting from use of the Product in other than its normal and customary manner.
- b. Defects or damage from misuse, accident, water, or neglect.
- c. Defects or damage from improper testing, operation, maintenance, installation, alteration, modification, or adjustment.
- d. Breakage or damage to antennas unless caused directly by defects in material workmanship.
- e. A Product subjected to unauthorized Product modifications, disassemblies or repairs (including, without limitation, the addition to the Product of non-MOTOROLA supplied equipment).
- f. Product which has had the serial number removed or made illegible.
- g. Rechargeable batteries if:
  1. Any of the seals on the battery enclosure of cells are broken or show evidence of tampering.
  2. The damage or defect is caused by charging or using the battery in equipment or service other than the Product for which it is specified.
- h. Freight costs to the repair depot.
- i. A Product which, due to illegal or unauthorized alteration of the software/firmware in the Product, does not function in accordance with MOTOROLA'S published specifications or the local type acceptance labeling in effect for the Product at the time the Product was initially distributed from MOTOROLA.
- j. Scratches or other cosmetic damage to Product surfaces that does not effect the operation of the Product.
- k. Normal and customary wear and tear.
- l. Exclusion for defects or damage arising from use of the products in connection with non-MOTOROLA equipment.

## **V. PATENT AND SOFTWARE PROVISIONS:**

MOTOROLA will defend, at its own expense, any suit brought against the end user purchaser to the extent that it is based on a claim that the Product or parts infringe a patent, and Motorola will pay those costs and damages finally awarded against the end user purchaser in any such suit which are attributable to any such claim, but such defense and payments are conditioned on the following:

- a. That MOTOROLA will be notified promptly in writing by such purchaser of any notice of such claim;
- b. That MOTOROLA will have sole control of the defense of such suit and all negotiations for its settlement or compromise; and
- c. Should the Product or parts become, or in MOTOROLA'S opinion be likely to become, the subject of a claim of infringement of a patent, that such purchaser will permit MOTOROLA, at its option and expense, either to procure for such purchaser the right to continue using the Product or parts or to replace or modify the same so that it becomes non-infringing or to grant such purchaser a credit for the Product or parts as depreciated and accept its return. The depreciation will be an equal amount per year over the lifetime of the Product or parts as established by MOTOROLA.

MOTOROLA will have no liability with respect to any claim of patent infringement which is based upon the combination of the Product or parts furnished hereunder with software, apparatus or devices not furnished by MOTOROLA, nor will MOTOROLA have any liability for the use of ancillary equipment or software not furnished by MOTOROLA which is attached to or sued in connection with the Product or any parts thereof. In no event shall MOTOROLA be liable for any incidental, special or consequential damages arising from any claim of patent infringement or alleged infringement.

Laws in the United States and other countries preserve for MOTOROLA certain exclusive rights for copyrighted MOTOROLA software, such as the exclusive rights to reproduce in copies and distribute copies of such MOTOROLA software. MOTOROLA software may be used in only the Product in which the software was originally embodied and such software in such Product may not be replaced, copied, distributed, modified in any way, or used to produce any derivative thereof. No other use including, without limitation, alteration, modification, reproduction, distribution, or reverse engineering of such MOTOROLA software or exercise of rights in such MOTOROLA software is permitted. No license is granted by implication, estoppel or otherwise under MOTOROLA patent rights or copyrights.

## Patent and Trademark Information

This product is protected under one or more of the following patents:

4817157, 4896361, 4857928, 5041793, 5060294, 5066923, 5134718, 5140156, 5239963, 5257411, 5287387, 5265219, 5289504, 5316168, 5317247, 5338396, 5389927, 5406588, 5424921, 5457376, 5460906, 5551063, 5557079, 5596487, 5615412, 5638403, 5559468, 5469465, 5170413, 5140615, 5519730, 5241544, 5584059, 5574992, 5396656, 5487091, 5533004, 5299199, 5343499, 5369501, 5509031, 5515379, 5528723, 5598417, 5066923, 5241650, 5278833, 5359696, 5548631, 5410632, 5440582, 5457735, 5457818, 5471670, 5477550, 5481537, 5566181, 5229767, 5208804, 5295140, 5381449, 5440590, 5467398, 5490230, 5620242, 5623523, 5655913, 5715240, 5771440, 5854578, 5675281, 5721787, 5729539, 5788523, 5869204, 5911124, 5946620, 5949774, 5949821, 5951317, 5987332, 6002948

Additional patents are pending.

© 2000 Nextel Communications, Inc. All rights reserved. Nextel, the Nextel logo, Nextel Worldwide, Nextel Direct Connect, Nextel Nextday, Nextel Business Networks, Nextel Online, Two-Way Messaging and How Business Gets Done are trademarks and/or service marks of Nextel Communications, Inc. [www.nextel.com](http://www.nextel.com).

MOTOROLA, the Stylized M Logo and all other trademarks indicated as such herein are trademarks of Motorola, Inc. \* Reg. U.S. Pat. & Tm. Off. \* 2000 Motorola, Inc. All rights reserved. Manufactured under one or more of the U.S. patents listed in the User's Guide.

Microsoft, Microsoft Internet Explorer, MSN, MSN Mobile, MSN Hotmail, MSNBC, Expedia.com, Sidewalk.com, and MoneyCentral are registered trademarks of Microsoft Corporation.

Netscape Navigator is a registered trademark of Netscape Communications Corporation.

T9 is a trademark owned by Tegic Communications.

T9® Text Input Patent and Trademark Information

This product is covered by U.S. Pat. 5,818,437, U.S. Pat. 5,953,541, U.S. Pat. 6,011,554 and other patents pending.

All other product or service names mentioned in this manual are the property of their respective trademark owners.



---

# Index

## Numerics

24-hour Clock **49**

## A

Accessing New Pages **55**  
Accessories **99**  
Accessory Safety Information **121**  
Account Administrator **22, 23, 81**  
Activate List Manager **22**  
Activating Your Greeting Schedule **46**  
Activating Your *i700plus* phone **8**  
Active Line Indicator **12**  
Alert Receipt **94**  
Alpha **72**  
Alpha Mode **74**  
Alternate Line **34**  
Alternate Line Service **34**  
Attaching the Battery **6**  
Audio Adapter **105**  
Automatic Redial **27**

## B

Back **70**  
Backlight Timer **89, 94**  
Backspace/Erase **72**  
Batteries **5, 99**  
Battery Charging Status **7**  
Battery Strength Indicator Icon **12**  
Bookmarks **81, 82, 84**  
Business Networks **61**

## C

Call Alert Queuing **65**  
Call Forward Indicator **12**  
Call Hold **30**  
Call Waiting **32**  
Caller ID **35**  
Change cases **85**  
Change the Case of the Letter **18**  
Changing the Display Language **87**  
Changing the Phone Display **70**  
Changing Your Password **41**  
Charge Strength **7**  
Charging the Battery **6, 99**  
Cigarette Lighter Adapter **101**  
Coverage Areas **8**  
Creating Group Lists **46**

Customer Care **98, 111**  
Customizing the *i700plus* phone **87**

## D

Dash Mount Holder **106**  
Delayed Forwarding of Messages **50**  
Deleting a Group List **47**  
Delivery Options **48**  
Desktop Dual-Pocket Charger **102**  
Detaching the Battery **6**  
Dialing **25, 28**  
Direct Dial **25**  
Direct Protect<sup>SM</sup> Insurance **98**  
Display Icons **12**  
Displaying of the Caller's Name **35**  
Displaying Your Private ID **62**

## E

Editing Stored List Entries **20**  
Email Addresses **76**  
Email Paging **58**  
Emergency Calling **27**  
Enable security **71**  
Enabling/Disabling Pager Notification  
**51**  
Ending a Phone Call **30**  
Entering the Private ID **63**  
Erasing List Entries **21**  
Error message **86**

## F

Future Delivery **48**

## G

Getting Started **5**  
Go to Site **82**  
Greetings **45**  
Group Calls **66**  
Group Lists **46, 49**  
Group Mode **13, 15**  
Group/Prvt Vibe **91**  
Group-Silent Programming **67**

## H

Hands-Free Car Kit **108**  
Home **70**  
Home page **71**

Hotmail 78

## I

iDEN Organizer 24  
IMEI number 86, 111  
Immediate Forwarding 50  
International Calls 27  
International Phone Numbers 28  
Internet Addresses 83

## K

Keypad Lock 9

## L

Last 10 Numbers Received/Sent 29  
Launching the Microbrowser 71  
Limiting Notification to Specific Times 52  
Lines per Screen 70  
List Manager 21, 81, 86  
List Manager Account Administrators 23  
List Manager User Tips 23

## M

Mail Vibe 91  
Making Calls From the Stored List 26  
Making Phone Calls 25  
Menu Options 13  
Menus 13  
Message  
    Delivery Status checking 58  
Microbrowser 71  
Missed Call Indicator 28  
Model Number 111  
Modes 13, 70  
Modes and Menus 13  
Modifying a Group List 47  
More Information Indicator 12  
MSN Mobile 78  
MyApplications 77

## N

Name Search 26  
Net Mode 13, 69, 81  
    Navigation Keys 69, 70  
Net Ready 69  
New Message Indicators 43  
New Text and Numeric Paging Flashing Indicator 12

Next 72

Nextel Business Networks 61, 98  
Nextel Direct Connect 13, 61  
Nextel Nextday<sup>SM</sup> Accessories 24, 98  
Nextel Online Two-Way Messaging 77  
Nextel Online Two-Way MessagingSM 54  
Nextel Online Wireless Internet Services 13, 69, 77  
Nextel Terms and Conditions of Service 113  
Nextel Voice Mail Service 38  
NextelServices 81  
Notification of New Pages 55  
Notification of Non-Delivery 48  
Num 72  
Numbers Mode 76  
Numeric Paging 58

## O

Operator Assisted Paging 58  
Ordering Information 98

## P

Pager Notifications 51  
Pages  
    Accessing 55  
    Viewing 55  
Paging  
    Email 58  
    Numeric 54, 58  
    Operator Assisted 58  
    Web 57  
Paging and Messaging Services 53  
Password 39, 84  
    Changing 41  
Patent and Trademark Information 128  
Pause Digit Entry 19  
Per-Call Blocking 36  
Per-Line Blocking 36  
Phone Calls 25  
Phone Mode 13, 25  
Phone Status 8  
Phone Vibrate 91  
Phone Vibrate/Ring 91  
Placing International Calls 27  
Placing/Clearing a Call Alert in the Queue 65  
Plus Dialing 28  
Privacy 36  
Private 48

Private Calls **63**  
 Private IDs  
   Programming Your Own **24**  
   Quickstore **64**  
 Private Mode **13, 15**  
 Private/Group Mode **61**  
 Private/Group Speaker Indicator **12**  
 Programming Menus **92**  
   Shortcut and Options **93**  
 Punctuation **73**  
   Symbols **75**

**Q**

Questions? **3**  
 Quick Guide to *i700plus* Phone  
   Functions **14**  
 Quick Reference Card **111**  
 Quickstore of Phone Numbers **29**  
 Quickstore of Private IDs **64**

**R**

Receiving a Group Call **67**  
 Receiving a Phone Call **28**  
 Receiving Calls on Your Alternate Line  
   **34**  
 Receiving Private Calls **64**  
 Receiving/Responding to a Call Alert  
   **65**  
 Recording Your Active Greeting **42**  
 Recording Your Name **42**  
 Recording, Copying and Replying to  
   Messages **47**  
 Redial **27**  
 Registration **22**  
 Responding to a Call Alert within the  
   Queue **65**  
 Retrieve Deleted Messages **41**  
 Retrieving a List of Missed Calls **28**  
 Reviewing/Storing/Dialing Received  
   Calls **29**  
 Reviewing/Storing/Dialing Sent Calls  
   **29**

**S**

Safety and General Information **117**  
 Sample Greeting **42**  
 Saving and Deleting Messages **41**  
 Scroll **26, 70**  
 Search **82**  
 Selecting a Name from a Stored List **63**  
 Selecting a Ring Style **90**

Sending a Call Alert **64**  
 Sending a Page **56**  
 Setting the Ringer Volume **89**  
 Setting Up Your Voice Mail Box **38**  
 Shift **73**  
 Shopping **77**  
 Signal Strength Indicator **12**  
 Silent Forwarding **50**  
 Sites **78**  
 Smart Punctuation **75**  
 Space **72**  
 Speed Dial **26**  
 Status Light **8**  
 Status Light Indicator **8**  
 Status Messages **111**  
 Status of Your Connection **8**  
 Stored List **17**  
 Storing Names and Numbers **17**  
 Swivel Belt Clip **107**  
 Sym **72**  
 Symbols Mode **75**  
 Synchronize **85**

**T**

T9 database **84**  
 T9 Navigation Keys **72**  
 T9® Text Input **72**  
 Talkgroup  
   Naming **66**  
 Text and Numeric Paging **54**  
 Text input mode **84**  
 Three-Way Calling **33**  
 Time and Date Charts **49**  
 Transferring Calls to Voice Mail **43**  
 Travel Charger **6, 100**  
 Turbo Dial **27**  
 Turning Call Waiting Off **33**  
 Turning Your *i700plus* Phone On/Off **7**  
 Two-Way Messaging **54**  
 Two-Way Radio **61**

**U**

Urgent **48**  
 Using T9® Text Input **69**  
 Using the Private/Group Speaker **62**  
 Using Your Phone as a Modem **59**

**V**

VibraCall™ **91**  
 VibraCall™ Indicator **12**  
 VibraCall™ Settings **91**

Vibrate Alert **91**

Viewing a Page **55**

Viewing a Page Immediately **55**

Voice Mail

    Changing Your Password **41**

    Indicator **12**

Voice Mail Box **38**

## **W**

Warranty Information **122**

Web Paging **57**

Word **72**

Word Mode **73**

## Free Manuals Download Website

<http://myh66.com>

<http://usermanuals.us>

<http://www.somanuals.com>

<http://www.4manuals.cc>

<http://www.manual-lib.com>

<http://www.404manual.com>

<http://www.luxmanual.com>

<http://aubethermostatmanual.com>

Golf course search by state

<http://golfingnear.com>

Email search by domain

<http://emailbydomain.com>

Auto manuals search

<http://auto.somanuals.com>

TV manuals search

<http://tv.somanuals.com>