

Limited Warranty

Warranty Registration

To register for your five year factory warranty, please fill out the enclosed warranty card completely, apply necessary postage and place in the mail. You may place the warranty card in a separate envelope if you wish.

Please use the following address for warranty registration ONLY:

KIDDE Safety
Product Registration Department
PO Box 8748
Denver, CO 80201-8748

Please send products and all other correspondence to:

KIDDE Safety
Attn.: Customer Service Department
1394 South Third Street
Mebane, NC 27302

Warranty information is located on the label on the back of the CO alarm. For your convenience, please complete the warranty information before installing the CO alarm.

The model number and assembly number can be found on the label on the back of the CO alarm.

For Warranty Service:

In many cases the quickest way to exchange your CO alarm is to return it to the original place of purchase. If you have questions, call the KIDDE Safety customer service department at 1-800-880-6788 for assistance.

KIDDE
SAFETY

1394 South Third Street, Mebane, NC 27302
Consumer Hotline: 1-800-880-6788
www.kiddesafety.com



NIGHTHAWK™

By KIDDE Safety

AC Powered Carbon Monoxide Alarm

User's Guide

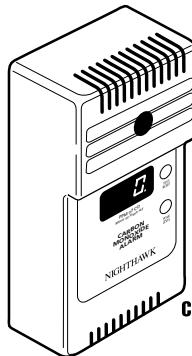

Nighthawk CO Alarm with Digital Display and Peak Level Memory

Power Cord Models (KN-COP-C)
Hardwire Models (KN-COP-HW)
Direct Plug Models (KN-COP-DP)

*For questions concerning your
Carbon Monoxide Alarm, please
call our Consumer Hotline at
1-800-880-6788.*

*Please have the following
information ready when calling:*

CO Alarm Model Number (Located on the back of alarm):

CO Alarm Assembly Number (Located on back of alarm):

Date of Manufacture (Located on back of alarm):

Date of Purchase:

Where Purchased:

Table of Contents

| | |
|--|---------|
| About this User's Guide | i |
| Introduction | ii |
| Quick Set Up Guide | iii,iv |
| Part One – Your Nighthawk CO Alarm | |
| •About your CO alarm | 1-1,2,3 |
| •What CO alarms can and cannot do | 1-4 |
| •Where you should install your alarm | 1-5 |
| •Where you should not install your alarm | 1-5,6 |
| •How to install your alarm | 1-7,8 |
| •Normal operating characteristics | 1-9 |
| •How to test your alarm | 1-10,11 |
| •How to know if your alarm is malfunctioning | 1-12,13 |
| •How to care for your alarm | 1-13 |
| •The peak level memory button | 1-14 |
| Part Two – Carbon Monoxide - The Silent Killer | |
| •What is CO? | 2-1 |
| •What are the effects of CO exposure? | 2-1 |
| •Could your family be at risk for CO poisoning | 2-1 |
| •Where does CO come from? | 2-1,2 |
| •What can you do to protect your family? | 2-2 |
| •Home safety tips | 2-3,4 |
| •Clues you can and cannot see | 2-4 |
| Part Three – What You Should Know Before the Alarm Sounds | |
| •Learn the difference between dangerous levels, high levels, mid levels and low levels | 3-1 |
| •Determine if anyone in the household is at high risk for CO poisoning | 3-1,2 |
| •Understand the effects of carbon monoxide exposure | 3-2 |

Table of Contents

| | |
|---|-----------|
| Part Four – What to Do When the Unit Alarms | |
| •How to respond: to a CO emergency; to a high, mid, or low level alarm or reading | 4-1,2,3,4 |
| •Who you should call if you suspect you have CO in your home | 4-2,3,4 |
| •Sometimes it is difficult to find the source of CO | 4-4 |
| Part Five – Technical Information | |
| •Product Specifications | 5-1 |
| •How the unit determines when to alarm | 5-2 |
| Part Six – Frequently Asked Questions | 6-1,2,3,4 |
| Limited Warranty | |
| •Warranty Registration | Back Page |
| •Warranty Service | Back Page |

IMPORTANT

THIS CARBON MONOXIDE ALARM IS DESIGNED TO DETECT CARBON MONOXIDE FROM ANY SOURCE OF COMBUSTION. IT IS NOT DESIGNED TO DETECT SMOKE, FIRE, OR ANY OTHER GAS.

NOT SUITABLE FOR INSTALLATION IN HAZARDOUS LOCATIONS AS DEFINED IN THE NATIONAL ELECTRIC CODE.

UNIT WILL NOT OPERATE DURING A POWER OUTAGE, BUT AUTOMATICALLY RESETS WHEN POWER IS RESTORED.

| | |
|---|--|
| KIDDE Safety | |
| This manual and the products described in it are copyrighted, with all rights reserved. Under these copyright laws, no part of this manual or these products may be copied for any use without prior consent from KIDDE Safety. The only exception to this is to distribute information on carbon monoxide in a effort to help educate others on the dangers of this silent killer. If you wish to do this, please contact KIDDE Safety for additional educational materials. | |
| ©KIDDE Safety, 1998 | |
| 1394 South Third Street, Mebane, NC 27302 | |
| Consumer Hotline: 1-800-880-6788 | |

About This User's Guide

Notice we call this booklet a "User's Guide" and not an "Owner's Manual." This is because our intention is you *use* this guide just as you will be using your Nighthawk CO alarm. Keep the guide in a handy location and refer to it when you have questions about your CO alarm, its functions and features, or if you have questions about carbon monoxide. It will take about an hour of your time, but it's well worth it. Please read it in the sequence presented. Reading this guide is the only way to learn how to use your CO alarm wisely and to know how to react in the event of an alarm.

Part One

Your Nighthawk Carbon Monoxide Alarm, covers the unique features of your Nighthawk carbon monoxide alarm, how and where to install it, as well as information on testing and maintaining your CO alarm.

Part Two

Carbon Monoxide - The Silent Killer, contains valuable information about carbon monoxide (CO). From discovering the most common sources of CO in your home to recognizing the symptoms of CO poisoning, this section provides tips and information that could help protect your family from carbon monoxide poisoning.

Part Three

What You Should Know Before the Alarm Sounds, describes the effects of exposure to CO levels over time and when your Nighthawk CO alarm will alarm. It also tells you how to determine who is at high risk for CO poisoning.

Part Four

What to do When the Unit Alarms, gives you step-by-step information on how to respond to an alarm situation. Also covered is whom to call for help if you think you have CO in your home.

Part Five

Technical Information, covers the technical specifications of your Nighthawk CO alarm.

Part Six

Frequently Asked Questions, contains the most commonly asked questions about our alarms. Part six was written by KIDDE Safety customer service representatives who handle thousands of calls per month, year-round. This section provides you with answers and tips that will most likely answer any questions you might have after reading this user's guide.

Introduction

This Nighthawk carbon monoxide (CO) alarm is an important part of your family's home safety plan. So important, the U.S. Consumer Product Safety Commission (CPSC) recommends that every household should have at least one carbon monoxide alarm. In fact, the CPSC chairman has said that CO alarms are "as important to home safety as smoke alarms." Yet because CO alarms for the home haven't been available until recently, most people haven't had much experience using them. As a new owner of a CO alarm, there are some basic facts you should know for your protection *and* convenience.

Many people think that CO alarms operate like smoke alarms. And in some basic ways, this is true. Like smoke alarms, CO alarms continuously monitor the air in your home and sound a loud alarm to warn you of trouble.

But, the similarities end here. The way you respond to a CO alarm is quite different than that of a smoke alarm. That's because a house fire and a carbon monoxide problem are two distinctly different situations. If your smoke alarm were to alarm, you would quickly be able to judge the level of danger you were in (if any) with your five senses: you could see and smell the smoke, you could feel the heat, you could see and even hear the fire burning. You could also readily see if your smoke alarm were alarming in a non-emergency situation, say if someone smoked up the kitchen with some seriously burnt toast. Because your sense of sight, smell, hearing and touch give you so much information, you could almost instantly judge what action to take if you heard your smoke alarm.

But now, what about a CO alarm? Carbon monoxide (CO) is invisible, odorless, tasteless and non-irritating—completely undetectable to your five senses. That's why it's so important to your safety that you have a carbon monoxide alarm. But, how do you know what to do if your unit alarms?

You have to *learn* what to do, because your five senses won't tell you. That's why this user's guide is so important. Please take the time to read this guide from cover to cover, to familiarize yourself with the facts about carbon monoxide, how your new alarm works, and what to do if it alarms. Then, find a handy place to keep the guide so it will be readily available in the future when you have a question. You might want to write down KIDDE Safety's toll-free customer service number and keep it with your other important phone numbers for the same reason.

Thank you for making Nighthawk a part of your complete home safety program. With proper installation and use, your new Nighthawk CO alarm should provide you with years of dependable service.

Quick Set Up Guide

We urge you to read this entire manual in the sequence it is presented. But, if you only read one part of this manual initially, read these two pages!

Listed below are six easy steps for setting up your Nighthawk CO alarm. Please read the entire guide for complete information.

Setting up your CO alarm for first time operation:

Step 1

Determine the best location for your CO alarm(s). Usually this is in or near bedrooms. Refer to page 1-5 for complete information.

Step 2

If your CO alarm is equipped with a **power cord**, mount the alarm on the wall at eye level using the hardware provided. Eye level is the best position to easily see the digital display. If your CO alarm is equipped with a **direct plug**, simply plug in (you can rotate the plug if necessary) For **hardware** units and for detailed instructions on mounting all alarms, refer to page 1-7,8.

Step 3

Plug the CO alarm into a standard, unswitched 120 volt AC electric outlet. If you have a direct plug model, mount the CO alarm with digital display at the top. You will hear the alarm sound briefly to indicate the unit is receiving power. Refer to page 1-9 for more details.

Step 4

You will first see three eights **888** in the digital display indicating the CO alarm is warming up. After approximately 30 seconds, the first reading will appear on the digital display. The number on the digital display should be zero (0). If not, see page 1-9 for complete information on normal operating characteristics.

Quick Set Up Guide

Step 5

Make sure the red dot in the digital display is blinking. Then test the alarm's operation by pressing the Test/Reset button and releasing. Within 15 seconds you will hear 4 quick beeps – 5 seconds off – then 4 quick beeps. For complete testing information, refer to page 1-10.

Step 6

While testing the alarm, have someone else check that the alarm can be heard easily from the sleeping areas. The CO alarm should be located where it can wake you if it alarms at night. See page 1-5 for complete information on the best locations for your CO alarm.

Caution: Continuous exposure to the loud 85 decibel alarm at close range over an extended period of time may cause hearing loss.

That's it. Your Nighthawk CO alarm is now monitoring for the presence of carbon monoxide.

Part One – Your Nighthawk CO Alarm

About Your CO Alarm

The number one feature that sets Nighthawk apart from other alarms is its unique digital display that gives you a continuous read-out of CO levels from 30-999 parts per million. The digital display serves as an early warning of CO presence. Additionally, the digital display gives you added time to find the source of the CO and correct the problem, limiting the risk of unrecognized long term exposure. Of course, the loud 85 decibel alarm warns of higher levels, even while you're sleeping.

While many other CO alarms require costly sensor or battery pack replacement, there are no replacement parts on Nighthawk CO alarms. And Nighthawk is the only CO alarm that gives you the choice of a direct-plug, a 6' power cord or a hardwire unit. Depending on how or where you wish to mount your alarm, you can get exactly what you need for a perfect application. These are just a few reasons over 4.5 million families have chosen Nighthawk over every other brand for this kind of life-saving protection.

Nighthawk CO Alarm – front view

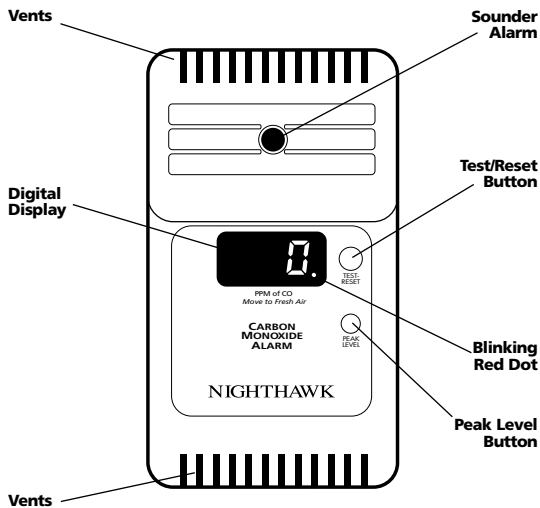

Part One – Your Nighthawk CO Alarm

Nighthawk CO Alarm– rear view

Power cord unit
(KN-COP-C)

Direct plug unit
(KN-COP-DP)

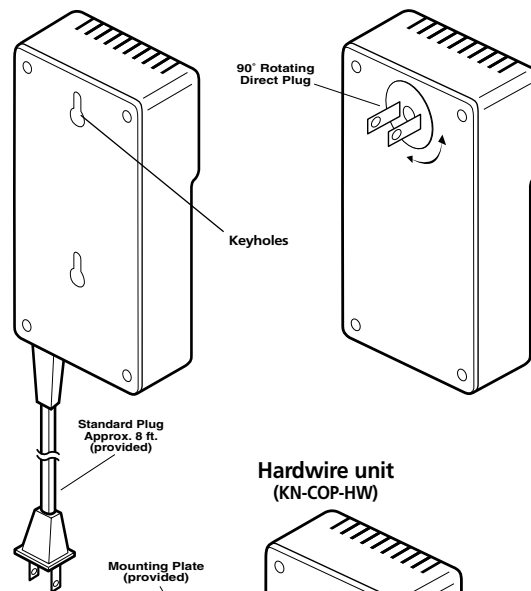

Hardwire unit
(KN-COP-HW)

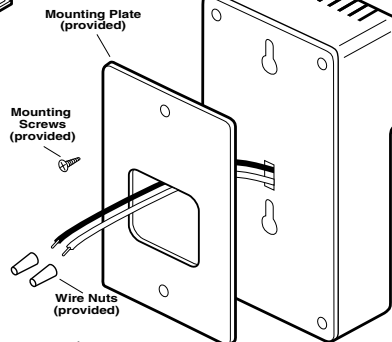

Part One – Your Nighthawk CO Alarm

Nighthawk's Unique Features

Digital Display

This continuous digital display shows you the level of carbon monoxide (if any) the unit is sensing. The unit updates this reading every 15 seconds so you can watch levels rise or fall.

Note: If the alarm does not sense any CO, the reading is zero (0). In most homes, the alarm reads "0" all the time. A reading of "0" is expected under normal conditions, and is good. The blinking dot after the number shows you the unit is operating.

Test/Reset Button

This button has two functions. First, this is the button you press when you test the unit weekly (see pages 1-9,10,11 for further details). Secondly, you press this button if the unit alarms and you want to turn it off. This will *reset* the unit and it will then again start monitoring for CO. If CO concentration is above 70 ppm, the CO alarm will sound within 60 minutes. (More on this on page 5-2).

Peak Level Button

By depressing this button, you can see the peak CO level recorded by the alarm since it was last reset or unplugged. This Nighthawk feature allows you (or heating contractor or fireman) to see exactly how big a CO problem you have so you can react accordingly. (More on the peak level memory feature on page 1-14).

Vents

Air (and CO) enters into the alarm at the bottom vent and circulates through the sensing chamber, exiting through the top vent. For proper air circulation, keep vents free of dust, dirt or grease, (see "How to care for your CO alarm" page 1-13). Do not obstruct or block vents, (see "Where to install your CO alarm" on page 1-5).

Sensor

The sensor is a highly sensitive, electrochemical sensor that is CO-specific to help avoid false alarms. Turn to page 1-13 for more information on how to care for and protect the CO alarm.

Sounder Alarm

This is the loud 85 decibel pulsing alarm that will sound to alert you to a potential problem. Alarm condition is 4 quick beeps – followed by 5 seconds off – then 4 quick beeps, repeat. **Caution:** Continuous exposure to this sound level at close range over an extended period of time may cause hearing loss. We recommend you cover the sounder with your finger while testing. More on testing on pages 1-10,11.

Keyholes

When the CO alarm is mounted to the wall, these keyholes slide onto the screws in the wall. (See "How to install your CO alarm on pages 1-7,8).

Part One – Your Nighthawk CO Alarm

What Carbon Monoxide Alarms Can and Cannot Do

CO alarms provide early warning of the presence of carbon monoxide, usually before a healthy adult would experience symptoms.

This early warning is possible, however, only if your Nighthawk CO alarm is located, installed and maintained as described in this user's guide.

This CO alarm is designed to act as a continuous monitor, it is not designed for use as a short-term testing device to perform a quick check for the presence of CO.

CO alarms have limitations. Like any other electronic device, CO alarms are not fool-proof.

CO alarms have a limited operational life. You must test your CO alarm weekly, because it could fail to operate at any time. If your CO alarm fails to test properly, or if its self-diagnostic test reveals a malfunction, immediately have the CO alarm replaced. See back page for warranty information.

CO alarms will not work without power. This CO alarm requires a continuous supply of electric power.

CO alarms can only sense CO that reaches the alarm's sensor. Carbon monoxide may be present in other areas without reaching the alarm. The rate at which CO reaches the alarm may be affected by doors or other obstructions. In addition, fresh air from a vent or open window or any other source may prevent CO from reaching the sensor. Please observe cautions on page 1-5 "Where to install your CO alarm."

CO could be present on one level of the home and not reach a CO alarm installed on a different level. For example, CO in the basement may not reach a CO alarm on the second level, near the bedrooms. For this reason, we recommend you provide complete coverage by placing a CO alarm on every level of the home.

CO alarms are not smoke alarms. CO alarms do not sense smoke or fire. For early warning of fire you must install smoke alarms, even though carbon monoxide can be generated by a fire.

CO alarms should not be used to detect the presence of natural gas (methane), propane, butane, or other combustible fuels.

CO alarms are not a substitute for property, disability, life or other insurance of any kind. Appropriate insurance coverage is your responsibility. Consult your insurance agent.

Part One – Your Nighthawk CO Alarm

Where to Install Your CO Alarm

Your Nighthawk CO alarm should be mounted in or near bedrooms and living areas. It is recommended that you install a Nighthawk CO alarm on each level of a multi-level home. You may use the number and location of smoke alarms installed in your home according to current building code requirements as a guide to the location of your Nighthawk CO alarm(s).

WHEN CHOOSING YOUR INSTALLATION LOCATIONS, MAKE SURE YOU CAN HEAR THE ALARM FROM ALL SLEEPING AREAS. IF YOU INSTALL ONLY ONE CARBON MONOXIDE ALARM IN YOUR HOME, INSTALL THE ALARM NEAR BEDROOMS, NOT IN THE BASEMENT OR FURNACE ROOM.

TWO SELF ADHESIVE LABELS ARE INCLUDED WITH THE CO ALARM. ADD THE PHONE NUMBER OF YOUR EMERGENCY SERVICE PROVIDER IN THE SPACE PROVIDED. PLACE ONE LABEL NEXT TO THE ALARM AND ONE LABEL NEAR A FRESH AIR SOURCE SUCH AS A DOOR OR WINDOW.

CAUTION: This CO alarm will only indicate the presence of carbon monoxide at the sensor. Carbon monoxide may be present in other areas.

IMPORTANT: Improper location can affect the sensitive electronic components in this CO alarm. Please see the next section describing where NOT to install this CO alarm.

Where Not to Install Your CO Alarm

To avoid causing damage to the CO alarm, to provide optimum protection, and to prevent unnecessary alarms, follow the directions below where NOT to install this CO alarm:

It is not recommended that you install this CO alarm in garages, kitchens or furnace rooms. Installation in these areas could lead to nuisance alarms, may expose the sensor to substances that could damage or contaminate it, or the alarm may not be heard by persons in other areas of the home, especially if they are sleeping.

In the garage, vehicle exhaust can contain some carbon monoxide. These levels are higher when the engine is first started. CO levels in a garage may not be sufficient to activate the alarm immediately. Within hours of starting a vehicle and backing it out of the garage, the levels present over time can activate the alarm and become a nuisance.

In the kitchen and furnace room, some gas appliances can emit a short burst of carbon monoxide upon startup. This is normal. If your CO alarm is mounted too close to these appliances, it may alarm often and become a nuisance.

Part One – Your Nighthawk CO Alarm

If you must install a Nighthawk CO alarm near a cooking or heating appliance, **install AT LEAST 15 feet away from the appliance.**

Do not install in excessively dusty, dirty or greasy areas such as kitchens, garages and furnace rooms. Dust, grease or household chemicals can contaminate or coat the CO alarm's sensor, causing the unit not to operate properly.

Do not obstruct the vents located at the top and bottom of the CO alarm. Place the CO alarm where drapes, furniture or other objects do not block the flow of air to the vents.

Do not install in dead air space, such as peaks of vaulted ceilings or gabled roofs, where carbon monoxide may not reach the sensor in time to provide early warning.

Do not install in turbulent air from ceiling fans. Do not install near doors and windows that open to the outside, near fresh air vents, or anywhere that is drafty. Rapid air circulation from fans or fresh air from outside may affect the unit's alarm response time.

Do not install this CO alarm in a switch- or dimmer-controlled outlet.

Do not install in areas where the temperature is colder than 40°F (4.4°C) or hotter than 100°F (37.8°C). These areas include unconditioned crawl spaces, attics, porches and garages. Extreme temperatures will affect the sensitivity of the alarm.

Do not install CO alarm near deep cell large batteries. Large batteries have emissions that can cause the CO alarm to perform at less than optimal performance.

Part One – Your Nighthawk CO Alarm

How to Install Your Alarm

Power Cord Units (KN-COP-C)

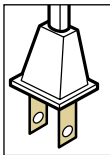

First, refer to “Where to Install Your CO Alarm” on page 1-5 for general guidelines as to where to locate your CO alarm.

Installation tips for power cord models:

The power cord provides more flexibility in mounting locations and allows the CO alarm to be easily installed at eye level.

Note: If you mount the alarm high on a wall, make sure it is **at least 6" from the ceiling**. Any higher than this, it will be in “dead air space” and carbon monoxide may not reach the sensor. Below is a list of suggested mounting locations if you wish to conceal the power cord:

- Above a tall bureau, chest of drawers or bookcase
- Above a doorway or closet, securing the cord to the side of the molding
- Near a curtain, with the cord behind the curtain.

Note: Do not cover the alarm itself with the curtain. See additional cautions on 1-6. **Note:** Plastic casing available in most hardware stores in an inexpensive way to secure and cover the power cord.

To install:

Single-Screw Mount (for standard wall mount)–

1. Insert the screw provided until head is approx 1/8" from wall (If mounting in plaster board or drywall, drill 3/16 hole and use plastic anchor provided).
2. Hook the Nighthawk CO Alarm unit over the screw onto keyhole in back of unit.
3. Plug cord into electrical outlet.

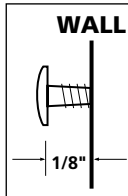

Minimum 6" from ceiling



Reminder:

If you are mounting alarm high on a wall, make sure it is at least 6" from ceiling. Any higher and it will be in “dead air” space.

Note: KIDDE Safety does not recommend mounting alarm on ceiling as we have not tested our alarms for this type application.

Part One – Your Nighthawk CO Alarm

Direct Plug Unit (KN-COP-DP)

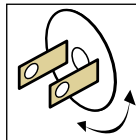

First, refer to “Where to Install Your CO Alarm” on page 1-5 for general guidelines as to where to locate your CO alarm.

To install:

1. Choose a standard 120V outlet to plug alarm into.
2. If outlet is mounted sideways (horizontally),

rotate plug and simply plug in.

CAUTION: Do not rotate unit while plugged in, as damage to plug may result.

Hardwire Unit (KN-COP-HW)

First, refer to “Where to Install Your CO Alarm” on page 1-5 for general guidelines as to where to locate your CO alarm.

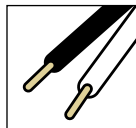

To install:

Double-Screw Mount with Mounting Plate (for standard hardwire mount) –

1. Warning: All electrical installation, including wiring should be performed by a qualified licensed technician.
2. Turn off main power to circuit.
3. Screw mounting plate to standard outlet box using the screws provided. Do not warp mounting plate by over tightening screws.
4. Strip wire ends approximately 5/16". Using wire nuts provided, attach wires from the unit to the 120V AC power source (18 AWG minimum): white to white, black to black.
5. Feed excess wires back into outlet box.
6. Hook the unit on the 2 mounting studs in keyholes on back of unit.
7. Turn on the main power current.

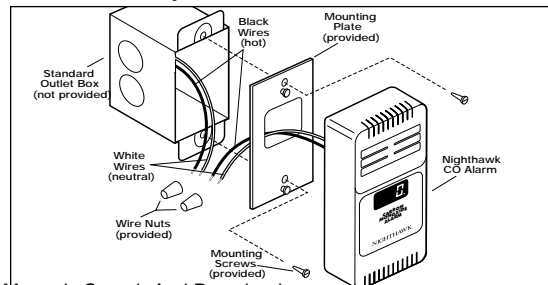

Part One – Your Nighthawk CO Alarm

Normal Operating Characteristics

When you first power up the CO alarm, the alarm will sound briefly to let you know the CO alarm is receiving power and that the alarm circuit is functioning.

You should see three eights **888** on the digital display, indicating the CO alarm is in the start-up mode. The three eights will remain for approximately 20 seconds. You should see a blinking red dot to the lower right of the digital display. The blinking dot shows that the CO alarm is operating. See illustration below.

Within 20 seconds, your CO alarm will start monitoring for CO, then the first reading will appear on the digital display. The number indicates a measurement of carbon monoxide in parts per million (ppm). **Note:** The number will probably be zero (0). This is a normal condition for most households and shows that no measurable amount of CO has been detected.

The CO alarm has begun monitoring the air for carbon monoxide and will continue to do so as long as it receives power.

For more information about CO readings and the effects of CO exposure at different levels over time, refer to the chart on 3-2 as well as the information on pages 4-1,2,3.

When the CO alarm is unplugged or loses power, a fading alarm will sound briefly to alert you that it has been disconnected from its power source. For example, this fading alarm will sound in the event of a power outage. A brief alarm will also sound to alert you when the power is restored.

For directions on how to test your alarm, see next column.

For information about how the unit alarms, turn to page 5-2.

For information about alarm's malfunction alert, turn to page 1-12.

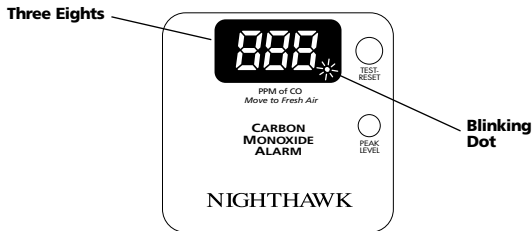

Part One – Your Nighthawk CO Alarm

How to Test Your Alarm

There are two aspects of the CO alarm's operation that can be tested: the electronics and the sensor response. Instructions on testing each are outlined below and on the next page.

Testing the Electronics

You should test the alarm once a week, following the directions listed below. If at any time you test the alarm and it does not perform as described below, have it replaced immediately. Turn to page 1-12 "How to know if your CO alarm is malfunctioning" for a description of the characteristics of a malfunctioning alarm and what you should do if a malfunction occurs.

Observe the CO alarm weekly to make sure the red dot is blinking, indicating normal operation.



If the dot is not blinking, unplug the alarm for three minutes, then plug in again. This will clear the CO alarm for restart. If the dot does not resume blinking, your CO alarm may be malfunctioning.

To test the CO alarm, press the Test/Reset button. If the alarm is operating properly, you should notice the following:

- The display shows three eights **888**, and then shows a number (usually around 200). You should then hear 4 quick beeps – followed by 5 seconds of silence – followed by 4 quick beeps. The unit will then show the three eights for several seconds. It will then return to monitoring for carbon monoxide.

Familiarize yourself and household members with the alarm pattern described above. In the event of a CO incident, this pattern will continue to repeat as long as CO is present.

Part One – Your Nighthawk CO Alarm

How to Test Your Alarm (continued)

NOTE: Pressing the Test/Reset button tests the functions of the alarm's internal components, circuitry and micro-computer. **YOU DO NOT NEED TO PRESS THE TEST BUTTON TO TAKE A CO READING.** CO readings are automatically shown on the CO alarm's digital display. If the alarm shows zero (0), then no measurable amount of CO has been sensed by the CO alarm within the past 15 seconds.

Testing the Sensor Response

While it is not required, on occasion you may wish to observe and become familiar with your alarm's response in the actual presence of carbon monoxide. The best and safest way to do this is with either a cigarette or an incense stick. To perform this test you will need: your CO alarm (that has been powered up for at least two hours), matches or a butane lighter, an ashtray, and either a cigarette or an incense stick.

CAUTION: Please refer to the "Frequently Asked Questions" section for warnings on how NOT to test the sensor response.

WARNING: This test should be done by adults only. Children should be warned never to light matches or butane lighters. Please use caution when performing the test described below. Avoid burns from flame or hot materials. Avoid inhaling excessive smoke from the cigarette or incense stick. Extinguish all flames and properly discard all hot materials.

Step 1. With a match or a lighter, light a single cigarette or incense stick. Extinguish the match or lighter. Make sure an ashtray is available to discard ashes, matches and the burned cigarette or incense stick.

Step 2. Hold the smoldering cigarette or incense stick 12 - 15 inches directly *below* the bottom air vents of the CO alarm, making sure the stream of smoke rises into the vents.

Step 3. Continue holding the cigarette or incense stick directly below the CO alarm for 3 - 5 minutes, or until you notice a reading on the display. This time is needed as the CO alarm samples the air every 15 seconds. Note: Do not hold the cigarette or incense stick closer than 12 inches to the CO alarm as smoke *will* cause a yellow stain to develop on the CO alarm's outer case.

Step 4. If your unit alarms, you can silence it by pressing the Test/Reset button and removing the source of CO.

Step 5. Extinguish the cigarette or incense stick by pressing the smoldering tip into the ashtray.

Part One – Your Nighthawk CO Alarm

How to Know If Your Alarm is Malfunctioning

Your CO alarm performs an internal self-diagnosis every 15 seconds to make sure that it is functioning properly. The CO alarm is designed to alert you in the unusual event of a malfunction.

If the CO alarm malfunctions.

In the rare event that your CO alarm malfunctions, it will alert you with one of these signal groups (depending upon the type of malfunction that occurs):

Malfunction Signal Group 1 - Component Failure

- An intermittent "chirping" alarm will sound every 30 seconds, and
- An "Err" message will appear on the digital display

OR,

Malfunction Signal Group 2 - Microprocessor Failure

- The alarm will sound continuously, and
- The digital display will be blank, and
- The alarm cannot be shut off by pushing the "Test/Reset" button

Unplug the CO alarm immediately and return for warranty exchange (see "Limited Warranty" on back two pages).

What to do if you're not sure...

PLEASE familiarize yourself with the malfunction alert, and do not confuse these signals with an alarm. After reading the information above, if you are still unsure whether your CO alarm is operating properly, call the KIDDE Safety toll-free consumer hotline at 800-880-6788 to do a quick diagnostic check of the CO alarm over the phone. The customer service representative will be able to assist you and answer your questions.

If your alarm sounder is beeping, and you are not sure if it is a CO alarm or a malfunction alert, reset the alarm, open windows for ventilation, turn off fuel-burning appliances (like kerosene or oil heaters, furnaces, gas ranges, wood-burning stoves, water heaters, or other fossil-fuel burning appliances). For furnaces, you can simply turn down the thermostat to its lowest setting. Open windows and doors for ventilation. Then call the KIDDE Safety toll-free consumer hotline at 800-880-6788 for assistance.

Before you call a qualified technician (such as a licensed heating contractor, utility service technician, chimney sweep or fuel provider) to check your residence for CO, remember that you will probably be charged for a service call. KIDDE Safety customer service operators are available to answer your questions and assist you in non-emergency situations at no charge.

Part One – Your Nighthawk CO Alarm

How to Know If Your Alarm is Malfunctioning (cont.)

Never ignore a CO alarm. A true alarm is an indication of potentially dangerous levels of carbon monoxide. CO alarms are designed to alert you to the presence of carbon monoxide before an emergency, before most people would experience symptoms of carbon monoxide poisoning, giving you time to resolve the problem calmly.

How to Care for Your Alarm

To keep your CO alarm in good working order, you must follow these simple steps:

WHAT YOU SHOULD DO:

- Test the alarm once a week by pressing the Test/Reset button
- Vacuum the alarm cover once a month to remove accumulated dust. Use the soft brush attachment of your vacuum cleaner, and unplug the alarm from the electrical outlet before vacuuming.
- Instruct children never to touch, unplug or otherwise interfere with the unit. Warn children of the dangers of CO poisoning.

WHAT YOU SHOULD NOT DO:

- Never use detergents or solvents to clean the alarm. Chemicals can permanently damage or temporarily contaminate the sensor.
- Avoid spraying air fresheners, hair spray, paint or other aerosols near the CO alarm.
- Do not paint the CO alarm. Paint will seal the vents and interfere with proper sensor operation.
- Do not mount the CO alarm directly above or near a diaper pail, as high amounts of methane gas can cause temporary readings on the digital display.

Note: If you will be staining or stripping wood floors or furniture, painting, wall-papering, or using aerosols or adhesives for a do-it-yourself project or hobby, **before you begin: Remove the CO alarm to a remote location to prevent possible damage to or contamination of the sensor.** You may wish to unplug the CO alarm and store in a plastic bag during the project.

The following is a list of substances that at high levels can affect the sensor and cause temporary readings on the digital display that are not carbon monoxide readings:

Methane, propane, iso-butane, ethylene, ethanol, alcohol, iso-propanol, benzene, toluene, ethyl acetate, hydrogen, hydrogen sulfide, sulfur dioxides.

Also most **aerosol sprays, alcohol based products, paints, thinners, solvents, adhesives, hair sprays, after shaves, perfumes, auto exhaust** (cold start) and some cleaning agents.

Part One – Your Nighthawk CO Alarm

The Peak Level Memory Button

Although the peak level feature will display levels below 30 PPM, these levels will not result in an alarm no matter how long the device is exposed to these levels.

The peak level feature is helpful in identifying low level CO occurrences below 30 PPM. Although the unit will not automatically display levels below 30 PPM, it will detect and store these readings in memory. By pressing the peak level button, concentration levels as low as 11 and up to 999 PPM will be displayed.

Concentrations of CO between 0 and 30 PPM can often occur in normal, everyday conditions. Concentrations of CO below 30 PPM may be an indication of a transient condition that may appear today and never reappear. Just a few examples of conditions and/or sources that may cause low level readings are heavy automobile traffic, a running vehicle in an attached garage, an appliance that emits CO when starting up, a fire in a fireplace or charcoal in a nearby barbecue. A temperature inversion can trap CO generated by traffic and other fuel burning appliances causing low level readings of CO.

Normally, the digital display will read "0" and under certain conditions you may notice levels of 30 or more for short periods of time, by using the peak level memory feature on the Nighthawk CO alarm you can view concentrations of CO between 11 and 30 PPM. Use the low-level concentrations shown in memory as a tool in identifying the source of the CO. It may be helpful to purchase additional Nighthawk CO Alarms to place in different locations throughout your house to isolate the CO source. Monitor the CO concentrations shown in the peak level memory to see if readings occur in certain areas at certain times of the day, or near a particular appliance.

Once the source is located, correcting the problem may be as easy as opening a window, venting an appliance, backing a car out of the garage a safe distance from living quarters, closing the garage door, and letting the car warm up outside. It could be possible that a weather condition caused the low-level reading and the condition may or may not happen again.

Some CO conditions may start out as low level leaks but could develop into CO concentrations that could become harmful. If this happens, the CO alarm will detect the dangerous level and alarm, notifying you and others of the conditions. DO NOT ignore high concentration readings above 30 PPM or a CO alarming device that is in alarm. Refer to page 4-2 for more details.

CO concentrations displayed below 30 PPM in memory are for reference only and the accuracy of the concentration shown may not be as accurate as noted on page 5-2.

To Reset the Peak Level Memory...

Step 1. Press the peak level button.

Step 2. With the peak level button still pressed, press the test/reset button as well.

The number on the display will turn to "0". The memory has now been cleared and the alarm will begin monitoring for CO within 20 seconds.

Part Two – Carbon Monoxide - The Silent Killer

What is Carbon Monoxide?

Carbon monoxide (CO) is an odorless, colorless, poisonous gas created when any fuel is burned – gasoline, propane, natural gas, oil, wood, coal, and even tobacco. When combustion air is limited, more CO is produced. Serious problems can develop when combustion by-products are not properly vented outside the house.

You've probably heard about carbon monoxide poisoning in the news recently. It's a problem receiving more attention because groups like the American Lung Association and the Consumer Product Safety Commission have made it a priority to warn the public about the dangers of this deadly household poison.

What are the Effects of CO Exposure?

When you breathe carbon monoxide, it enters your bloodstream through your lungs and attaches to red blood cells. These red blood cells, called hemoglobin, carry oxygen throughout your body. Carbon monoxide molecules attach to the red blood cells 200 times faster than oxygen, preventing the flow of oxygen to your heart, brain and vital organs. As carbon monoxide accumulates in your bloodstream, your body becomes starved for oxygen. The amount of carbon monoxide in a person's body can be measured by a simple blood test, called a "carboxyhemoglobin level" test.

The early symptoms of carbon monoxide poisoning are often mistaken for the flu – headache, dizziness, weakness, nausea, vomiting, sleepiness, and confusion.

Breathing very high concentrations of carbon monoxide can be lethal in minutes. Breathing low concentrations over time is dangerous, too. Long term exposure to low levels could cause permanent heart and brain damage.

Could Your Family be at Risk for CO Poisoning?

Carbon monoxide is the number one cause of poisoning deaths in the United States. According to the Mayo Clinic, at least 10,000 Americans are affected by CO poisoning each year.

While anyone is susceptible, experts agree that unborn babies, small children, senior citizens and people with heart or respiratory problems are especially vulnerable to CO and are at the greatest risk for death or serious injury.

Where Does CO Come From?

Inside your home, appliances used for heating and cooking are the most likely sources of carbon monoxide. Vehicles running in attached garages can also produce dangerous levels of carbon monoxide.

Part Two – Carbon Monoxide - The Silent Killer

A by-product of combustion, carbon monoxide can be a potential problem from a number of common sources – automobiles, furnaces, water heaters, fireplaces, wood stoves, charcoal grills, gas ranges, space heaters and portable generators.

When these appliances are in good working condition with proper ventilation, lethal carbon monoxide gas is vented outdoors where it quickly disperses. But even the slightest malfunction or misuse of any of these sources can lead to a build-up of carbon monoxide in your home that can become deadly before you'd even know it's there.

And you don't have to have ancient appliances to have a problem. Today's more energy-efficient, airtight home designs can trap CO-polluted air inside where it can quickly build to lethal levels.

What Can You do to Protect Your Family?

To be safe, know the possible sources of CO in your home. Keep fuel-burning appliances and their chimneys and vents in good working condition. Learn the early symptoms of exposure, and if you suspect carbon monoxide poisoning, move outside to fresh air and get emergency help. A blood test can confirm that CO caused the problem.

Your first line of defense is an annual inspection and regular maintenance of your appliances. Contact a licensed contractor or call your local utility company for assistance.

But remember, problems can begin after an inspection is over, like a crack in a furnace heat exchanger, or a leak in a water heater vent or a bird's nest blocking a flue. Other sources are nearly impossible to detect: even a change in the air pressure outside can turn a normally safe situation deadly. That's why you need the 24-hour protection provided by a CO alarm.

Part Two – Carbon Monoxide - The Silent Killer

Home Safety Tips

What You Can Do...

- Buy only appliances approved by a nationally recognized testing laboratory.
- Choose fuel-burning appliances that can be vented to the outdoors, whenever possible.
- Make sure appliances are installed according to manufacturer's instructions and local building codes. Most appliances should be installed by professionals and should be inspected by the proper authority after installation.
- Have the heating system, vents, chimney and flue inspected and cleaned by a qualified technician every year.
- Follow manufacturer's directions for safe operation of all fuel-burning appliances.
- Examine vents and chimneys regularly for improper connections, visible rust or stains.
- Open a window when a fireplace or wood-burning stove is in use, and provide adequate outdoor air for furnace and water heater.
- Notice problems that could indicate improper appliance operation:
 - Decreasing hot water supply
 - Furnace unable to heat house or runs constantly
 - Sooting, especially on appliances
 - Unfamiliar or burning odor
 - Yellow or orange flame
- Be aware of the symptoms of carbon monoxide poisoning:
 - headaches, dizziness, weakness, sleepiness, nausea, vomiting, confusion and disorientation.
- Recognize that CO poisoning may be the cause when family members suffer from flu-like symptoms that don't disappear but improve when they leave home or extended periods of time.
- Install a UL 2034 Listed CO alarm for added safety.
 - The Consumer Product Safety Commission recommends that every residence with fuel-burning appliances be equipped with a UL Listed CO alarm.

Part Two – Carbon Monoxide - The Silent Killer

What You Should Not Do...

- Never burn charcoal inside a home, garage, cabin, RV or camper.
 - Never install, service, or convert fuel-burning appliances from one type to another without proper knowledge, skills and tools.
 - Never use a gas range, oven, or clothes dryer for heating.
 - Never operate unvented gas-burning appliances, such as kerosene or natural gas space heaters, in a closed room.
 - Never operate gasoline-powered engines (like vehicles, motorcycles, lawn mowers, yard equipment or power tools) in confined areas such as garages or basements, **even if** an outside door or window is open.
 - Never ignore a safety device when it shuts off an appliance.
 - Never ignore a CO alarm.
-

Be Aware of the Warning Signs of Carbon Monoxide: Clues You Can See...

- Streaks of carbon or soot around the service door of your fuel-burning appliances.
- A yellow or orange flame may indicate a problem with natural gas appliances.
- Excessive rusting on flue pipes or appliance jackets.
- Loose or missing furnace panel.
- Moisture collecting on the windows and walls of furnace rooms.
- Loose or disconnected vent/chimney, fireplace or appliance.
- Small amounts of water leaking from the base of the chimney, vent or flue pipe.
- Rust on the portion of the vent pipe visible from outside your home.
- The absence of a draft in your chimney (indicating blockage).
- Fallen soot from the fireplace chimney.
- Loose, damaged or discolored bricks on your chimney.

Clues You Cannot See...

- Internal appliance damage or malfunctioning components
- Improper burner adjustment
- Hidden blockage or damage in chimneys

Part Three – What You Should Know Before the Alarms Sounds

Learn the difference between dangerous levels, high levels, mid levels and low levels:

Dangerous levels, when someone is experiencing symptoms of CO poisoning and CO readings are generally above 100 ppm.

Anytime someone is experiencing the symptoms of carbon monoxide poisoning this should be treated as an EMERGENCY. Follow the instructions on page 4-2.

High levels, generally above 100 ppm, with no one experiencing symptoms. This should be treated as an URGENT situation. Follow the instructions on page 4-2.

Mid levels, generally between 50 ppm to 100 ppm. This should be cause for CONCERN and should not be ignored or dismissed. Follow the instructions on page 4-2.

Low levels, generally below 50 ppm. This indicates a need to watch the situation closely to see if it resolves itself or worsens. Follow the instructions on page 4-3.

Determine if anyone in the household is at high risk for CO poisoning:

Many cases of reported carbon monoxide poisoning indicate that while victims are aware they are not well, they become so disoriented they are unable to save themselves by either exiting the building or calling for assistance.

You should **take extra precautions to protect high risk persons** from CO exposure because they may experience ill effects from carbon monoxide at levels that would not ordinarily affect a healthy adult. Are there any infants or small children in the home? Be sure to check them for signs of possible CO poisoning because they might have trouble explaining their symptoms. Infants and children are more susceptible to CO poisoning than a healthy adult.

Pregnant women should be aware that their unborn fetus could be harmed by exposure to carbon monoxide, even when the mother suffers no ill effect herself. Any pregnant woman who suspects she may have been exposed to carbon monoxide should immediately contact her physician.

Is there anyone in the household who is elderly, or who has anemia, heart disease or respiratory problems, emphysema or chronic bronchitis? These individuals are at higher risk for CO poisoning and for health problems from exposure to low levels of carbon monoxide.

Part Three – What You Should Know Before the Alarms Sounds

If anyone in the household is at high risk for CO poisoning, we urge you to take extra precaution to prevent possible poisoning. If the unit alarms or if CO readings are shown on the digital display, remove the at-risk person from the premises, if possible. Ventilate the area. The high-risk person(s) should not re-enter the residence until the source of the CO problem has been identified and corrected.

Understand the Effects of Carbon Monoxide Exposure

| Concentration of CO in Air (ppm = parts per million) | Approximate Inhalation Time and Symptoms Developed |
|---|--|
| 50 ppm | The maximum allowable concentration for continuous exposure for healthy adults in any 8-hour period, according to OSHA*. |
| 200 ppm | Slight headache, fatigue, dizziness, nausea after 2-3 hours. |
| 400 ppm | Frontal headaches within 1-2 hours, life threatening after 3 hours. |
| 800 ppm | Dizziness, nausea and convulsions within 45 minutes. Unconsciousness within 2 hours. Death within 2-3 hours. |
| 1,600 ppm | Headache, dizziness and nausea within 20 minutes. Death within 1 hour. |
| 3,200 ppm | Headache, dizziness and nausea within 5-10 minutes. Death within 25-30 minutes. |
| 6,400 ppm | Headache, dizziness and nausea within 1-2 minutes. Death within 10-15 minutes. |
| 12,800 ppm | Death within 1-3 minutes. |

* Occupational Safety and Health Administration

Low Levels:

Generally 50 ppm and below.

High Levels:

Generally 100 ppm and above if no one is experiencing symptoms.

Mid Levels:

Generally 50 ppm to 100 ppm.

Dangerous Levels:

Generally 100 ppm and above if someone is experiencing symptoms.

Reminder: The chart above relates to the exposure of healthy adults. Read the info on the previous page for descriptions of those who are at higher risk.

Part Four – What to do When the Alarm Sounds

Determine if anyone in the household is experiencing symptoms of CO poisoning. Many cases of reported CO poisoning indicates that while victims are aware they are not well, they become so disoriented that they are unable to save themselves by either exiting the building or calling for assistance. Also young children and household pets may be the first affected. The following symptoms are related to CARBON MONOXIDE POISONING and should be discussed with ALL members of the household:

Common Mild Exposure Symptoms:

Slight headache, nausea, vomiting, fatigue (“flu-like” symptoms).

Common Medium Exposure Symptoms:

Throbbing headache, drowsiness, confusion, fast heart rate.

Common Extreme Exposure Symptoms:

Convulsions, unconsciousness, heart and lung failure.

It can cause brain damage and death.

Become familiar with these common symptoms from CO poisoning.

If you experience even mild symptoms of CO poisoning, consult your doctor immediately!

Part Four – What to do When the Alarm Sounds



WARNING: Actuation of your CO Alarm indicates the presence of Carbon Monoxide (CO) which can KILL YOU.

When the CO alarm senses a dangerous level of CO, the unit will emit a loud alarm pattern. The alarm pattern is 4 short beeps – followed by 5 seconds of silence – followed by 4 short beeps. Know how to respond to a CO emergency. Periodically review this user’s guide and discuss with all members of your family.



WARNING! - Actuation of this device indicates the presence of dangerous levels of carbon monoxide!

Carbon monoxide can be fatal! If the alarm sounds:

- 1) Operate test/reset button;
- 2) Call your emergency services (fire dept. or 911);
- 3) Immediately move to fresh air - outdoors or by an open door/window. Do a head count to check that all persons are accounted for. Do not reenter the premises nor move away from the open door/window until the emergency services responders have arrived, the premises have been aired out, and your alarm remains in its normal condition.
- 4) After following steps 1-3, if your alarm reactivates within a 24 hour period, repeat steps 1-3 and call a qualified technician to investigate for sources of CO from fuel burning equipment and appliances,

PHONE NUMBER

PHONE NUMBER

LOW LEVEL READING, UNIT WILL NOT ALARM

Unit reads below 50 ppm of carbon monoxide.

Remember to determine if anyone is at high risk for CO poisoning. If so, you should use precaution not to expose the at-risk person to low levels for more than eight hours.

If no one is experiencing symptoms of carbon monoxide poisoning, press the reset button on the CO alarm. Otherwise refer to Dangerous and/or High Level Alarms on page 4-1,2. Under normal operation the CO alarm will not display CO concentrations detected between 11 and 29 ppm. By pressing the peak level button, you can see if any CO concentration from 11 to 999 has been detected including low levels of 11 to 29 ppm.

Then, consider whether the following could be sources of the low CO levels:

- Cigarette smoke? Gas oven or range? Attached garage?
Fuel-burning appliances?
- Has anyone used chemicals that could affect the sensor?
(See page 1-13 or a list of chemicals that can have a temporary or permanent affect on the sensor.)
- Has there been a temperature inversion in the area?
- Do you live in an area with air pollution or heavy traffic?

Test the alarm to verify that it is working properly, following the instructions on page 1-10,11.

If the CO alarm appears to be functioning properly, ventilate your home and turn fuel-burning appliances to the "off" position until the digital display returns to "0." Then, turn appliances back on and take note of any further readings at one hour intervals. Note if the turning on of appliances has caused any change in CO alarm readings.

Sometimes conditions may develop that are not caused by malfunctioning appliances or structural problems that need to be repaired. These conditions can create a temporary build-up of low CO levels that will dissipate and may not return. (For example: weather conditions or backdrafts caused by differences in air pressure between the inside and outside of the home). This is why we suggest you ventilate the home and then monitor to see if any CO levels reappear.

Treatment for CO Poisoning

Any person who is suspected to have carbon monoxide poisoning should leave the potentially dangerous environment, get fresh air immediately and seek care from a physician. CO poisoning can be determined by a simple blood test, called a "carboxyhemoglobin" test. This test measures the amount of carbon monoxide in the bloodstream. For this test to be accurate, it must be done immediately after CO exposure. Acute CO poisoning is usually treated by breathing in oxygen. When CO poisoning is severe, (for example, when there is an altered state of consciousness), high pressure oxygen therapy in a special "hyperbaric chamber" may be used. A physician will make this determination and administer treatment if necessary.

Calling a Qualified Technician to Find and Repair the Problem

If you call a qualified service technician (such as a licensed heating contractor, utility service technician, chimney sweep or fuel provider) to inspect your home for possible sources of CO, tell the technician what the digital readings were and have them press the peak level memory button. This way they can see how big a problem they are dealing with. Do not restart these appliances until the problem is corrected. Request service for as soon as possible, like **TODAY**.

Please be aware that some service technicians may charge a fee to inspect your home, even if the source of CO is not found. You may wish to find out if you will be charged for the service and the amount of the fee before you request service. Some public utilities do not charge for inspection. Some service technicians do not charge if you purchased your appliance from them. To know for sure, you need to ask before the technician comes to your home. Repair work or replacement of appliances may be necessary to fix the problem that is creating the CO in your home. Remember, a CO alarm can only warn you of the presence of CO, it does not prevent CO from occurring, nor can it solve an existing CO problem.

Because you've provided ventilation by leaving your windows and doors open, the CO buildup may have dissipated by the time help responds. Although your problem may appear to be temporarily solved, it's crucial that the source of the CO is determined and appropriate repairs are made.

Sometimes it's Difficult to Find the Source of CO in a Home

It can be difficult for responders to locate the source(s) of CO if:

- The house was ventilated before they arrived and the fresh air caused the CO to dissipate. The peak level function on your Nighthawk CO alarm helps the responders know how severe the problem was before they arrived.
- The CO problem was caused by a source that fluctuates on and off, sometimes creating CO and sometimes not. Such a situation makes it nearly impossible to pinpoint the source of CO in a short period of time.
- The cause of CO problem was backdrafting – when air in a chimney or flue is sucked into the home instead of venting outside. The exact situation that created a negative air pressure inside the home (the cause of backdrafting) is difficult to recreate during an investigation for CO. Sometimes the CO problem disappears when a door or window is opened. Backdrafting may or may not happen again.

Part Five – Technical Information

| | |
|----------------------------------|---|
| Power: | 120V AC units: 60 Hz, Current 60 mA max. |
| Sensor: | Sensor calibrated at 150 ppm (± 25 ppm). |
| Temperature: | Operating range: 40°F (4.4°C) to 100°F (37.8°C). |
| Mounting: | Power Cord: #8 Philips panhead screw with plastic anchor. Hardware: 2, #8 Philips panhead screws with mounting plate. Direct Plug-In: No mounting screws needed. |
| Alarm: | 85+ dB at 10' @ 3.4 \pm 0.5 KHz pulsing alarm. In alarm condition you will hear 4 quick beeps, 5seconds off, 4 quick beeps, repeat. |
| LED Operation: | Blinking dot denotes normal operation. Digital readout 30-999. |
| Unit Malfunction: | "Err" error message will display. Intermittent alarm will sound every 30 seconds and display dot will stop blinking. Refer to page 1-12 for other "Err" conditions. |
| Test/Reset Button: | Test button verifies proper unit operation and resets the unit in the event of a CO alarm. |
| Peak Level Memory Button: | When pressed, LED will display the highest CO ppm level detected since unit was powered up or since unit was reset with test button. Reading will be stored in memory as long as unit is not reset or unplugged. Any concentration detected from 0-999 will be displayed. |
| Size: | 5.6"L x 3.2"W x 2.0"H. Wt. 1.1 lbs. |
| Housing: | Rigid plastic case meets UL94-5V rating. |
| Warranty: | Five-year warranty from date of purchase against defects in material and workmanship. |

Part Five – Technical Information

How the Unit Determines When to Alarm

Your Nighthawk CO alarm uses advanced technology to monitor the environment in your home and warn you of unacceptable levels of carbon monoxide. An internal microcomputer works together with the carbon monoxide sensor inside the CO alarm to determine the levels of carbon monoxide in the air and to calculate the rate that CO would be absorbed into the human body.

The microcomputer is calibrated to trigger the unit's alarm before most people would experience any symptoms of carbon monoxide poisoning. Because carbon monoxide is a cumulative poison, long-term exposures to low levels can cause symptoms, as well as short-term exposures to high levels. Your Nighthawk CO alarm has a **time weighted alarm**, so the higher the level of carbon monoxide present, the sooner the alarm will be triggered.

This Nighthawk CO alarm meets the alarm response time requirements of UL Standard 2034 which are as follows:

| |
|---|
| At 70 ppm, the unit must alarm within 60-240 minutes. |
| At 150 ppm, the unit must alarm within 10-50 minutes. |
| At 400 ppm, the unit must alarm within 4-15 minutes. |

WARNING: This device may not alarm at low carbon monoxide levels (see chart above for alarm points). This product is intended for use in ordinary indoor locations of family living units. It is not designed to measure compliance with Occupational Safety and Health Administration (OSHA) commercial or industrial standards. Individuals with medical problems may consider using warning devices which provide audible and visual signals for carbon monoxide concentrations under 30 ppm.

Accuracy of the Digital Display

Each Nighthawk CO Alarm is calibrated at a CO concentration of 150 ppm (+/- 25 ppm) in air, at 80° F (+/- 10° F) and 40% (+/- 3%) relative humidity. Depending on the ambient condition (temperature, humidity) and the condition of the sensor, the alarm readings may vary.

The digital reading tolerances are:

Ambient: 80° F (+/- 10° F), atmospheric pressure +/- 10%, 40% +/- 3% relative humidity.

| | |
|-----------|------------------------|
| | Tolerance |
| Reading | (of displayed reading) |
| 0-999 ppm | $\pm 20\% + 15$ ppm |

Part Six – Frequently Asked Questions

Q. How many alarms do I need in my house? How much square footage will one CO alarm cover?

A. We recommend you place alarms near the sleeping area(s). If you have a multi-level home, you should place an alarm on each level of the home. A good rule of thumb for the number and placement of CO alarms for your particular home is to place CO alarms near smoke alarms that have been installed to meet current building code requirements.

Generally, one CO alarm can be adequate for 1,200 to 1,500 square feet of living space. The most important determination for the number of alarms needed is whether an alarm can be heard in all sleeping areas.

Q. Can you explain what “time-weighted alarm” means?

A. Because carbon monoxide is a cumulative poison, two factors determine how the body is affected by CO: the level of exposure and the length of exposure. For example, being continuously exposed to low levels of carbon monoxide for many hours can be as dangerous as being exposed to higher levels of CO for a short period of time.

The microchip inside your Nighthawk CO alarm monitors the air for the presence of carbon monoxide and computes the levels and length of exposure, alarming when you should be concerned about CO exposure.

For more information about the alarm, see page 5-2.

Q. Do I have to press the test button to get a CO reading?

A. No. Your Nighthawk CO alarm continuously monitors the air for carbon monoxide. An updated reading is shown on the digital display every 15 seconds. If there is no CO present, the digital display will show a zero. The CO alarm will alert you to the presence of CO automatically. To test the internal components and circuitry of your CO alarm, press the Test/Reset button. For complete instructions on testing your CO alarm, see pages 1-10,11.

Q. What happens if the power goes out?

A. If the power goes out, your CO alarm will sound a fading alarm to alert you that power has been disconnected. When the power is restored, the alarm will automatically reset and will sound a brief alarm to indicate it is receiving power.

In the event of a power outage, it is important to remember never to use alternative sources of heat indoors such as charcoal, a gas oven or unvented space heaters. These heat sources can cause extremely dangerous amounts of carbon monoxide.

Part Six – Frequently Asked Questions

Q. How do I get the CO alarm to show something besides “0.” OR, How can I determine if the sensor is operating correctly?

A. Please refer to “Testing Sensor Response” on page 1-10,11 for complete instructions on how to test your CO alarm’s electronics and sensor functions.

Q. You warranty the alarm for five years. How will I know when it doesn’t work anymore and I need to buy a new one?

A. In any event of malfunction, your CO alarm should alert you with malfunction signals. These signals are described in detail on page 1-12.

Q. What do the numbers mean on the digital display when I press the “Test/Reset” button?

A. The numbers you see when you press the Test/Reset button are NOT a CO reading. This is a *simulated* reading the alarm displays as it tests its electronics. The numbers displayed when the Test/Reset button is pushed should be between 100 to 350.

Q. I called in someone to inspect my home for CO after my unit alarmed, and he couldn’t find anything wrong. Why? Does that mean this CO alarm “false alarmed”?

A. No. Please read the information explaining why a CO problem can be difficult to diagnose on page 4-4. Also, please read the information on page 1-12 to make sure you experienced an alarm and not a malfunction alert.

Q. I tried to test the CO alarm (see below) and it still reads “0.” Why?

- by running the car in the garage
- by holding it to the tailpipe of the car
- by putting it next to the furnace vent

A. DO NOT try to test your alarm by doing any of the above! Testing the alarm using any of the methods listed above usually does not yield satisfactory results and *could in fact be dangerous*. To accurately test the CO alarm, please follow the guidelines given on pages 1-10,11.

Never operate a vehicle in a closed garage, as high levels of CO can be built up in a short time. With an attached garage, dangerous CO levels develop inside the home as well as within the garage.

Attempting to test the sensor function by holding the CO alarm next to a tailpipe or furnace vent may not cause a reading on the display because today’s vehicles emit very little CO once the engine reaches operating temperature. Likewise, many of today’s high efficiency furnaces emit very low levels of CO.

Part Six – Frequently Asked Questions

Q. When I tried to test the alarm I got a high number on the digital display, but the alarm didn't sound immediately. Why?

A. Please refer to "How the unit determines when to alarm" on page 5-2 for an explanation of the "time weighted alarm."

Q. How much electricity does it take to run the CO alarm?

A. The CO alarm uses less than one watt of electricity.

A typical night light uses approximately four watts.

Q. Will the CO alarm last longer if I unplug it during the summer months and only use it during the winter?

A. No. Some components of the CO alarm can deteriorate over time if not used regularly. We recommend the CO alarm be plugged in continuously for maximum alarm life.

Q. I use the CO alarm in a vacation home that isn't always occupied and can have temperature extremes when no one is there (no heat or no air conditioning). Will that hurt the CO alarm? Should I leave it plugged in all the time?

A. We recommend that your CO alarm not be installed in areas where temperatures fall below 40°F (4.4°C) or rise above 100°F (37.8°C). Your CO alarm was designed to be constantly plugged in for maximum performance.

Q. I plugged in the CO alarm at my house (my parents', my neighbors', etc.) and it read "0." Does that mean everything is OK? (I'm thinking I can return the CO alarm since everything checks out OK.)

A. This CO alarm is designed to act as a continuous monitor, it is not designed for use as a short-term testing device to perform a quick check for the presence of CO.

Remember, a carbon monoxide problem can occur at any time, even after a professional inspection has determined that everything is in proper working order. Examples of problems that can develop are a crack in a furnace heat exchanger, a leak in a water heater vent, or a bird's nest blocking a flue.

Other sources are nearly impossible to detect: even a change in the air pressure outside can turn a normally safe situation deadly. That's why you need the 24-hour protection provided by a CO alarm.

Part Six – Frequently Asked Questions

Q. My CO alarm shows a reading of 30 ppm. and then drops immediately to "0" ppm., what causes this?

A. Per UL2034, (section 3.19) which states "Warning signal: except for alarm and trouble signals, no other audible and visual signals shall be used. (ie: warning signals that indicate the presence of CO less than 30 ppm.)". Nighthawk CO alarms cannot display CO concentrations detected below 30 ppm. Under normal conditions, however by pressing the peak level button, concentrations of CO detected below 30 ppm will be displayed.

Notes

Limited Warranty

WARRANTY COVERAGE: THE MANUFACTURER WARRANTS TO THE ORIGINAL CONSUMER PURCHASER, THAT THIS PRODUCT WILL BE FREE OF DEFECTS IN MATERIAL AND WORKMANSHIP FOR A PERIOD OF FIVE (5) YEARS FROM DATE OF PURCHASE. THE MANUFACTURER'S LIABILITY HEREUNDER IS LIMITED TO REPLACEMENT OF THE PRODUCT. REPAIR OF THE PRODUCT OR REPLACEMENT OF THE PRODUCT WITH REPAIRED PRODUCT AT THE DISCRETION OF THE MANUFACTURE. THIS WARRANTY IS VOID IF THE PRODUCT HAS BEEN DAMAGED BY ACCIDENT, UNREASONABLE USE, NEGLIGENCE, TAMPERING OR OTHER CAUSES NOT ARISING FROM DEFECTS IN MATERIAL OR WORKMANSHIP. THIS WARRANTY EXTENDS TO THE ORIGINAL CONSUMER PURCHASER OF THE PRODUCT ONLY.

Warranty Disclaimers: Any implied warranties arising out of this sale, including but not limited to the implied warranties of description, merchantability and fitness for a particular purpose, are limited in duration to the above warranty period. In no event shall the Manufacturer be liable for loss of use of this product or for any indirect, special, incidental or consequential damages, or costs, or expenses incurred by the consumer or any other user of this product, whether due to a breach of contract, negligence, strict liability in tort or otherwise. The Manufacturer shall have no liability for any personal injury, property damage or any special, incidental, contingent or consequential damage of any kind resulting from gas leakage, fire or explosion.

Some states do not allow limitations on how long an implied warranty lasts, so the above limitation may not apply to you.

Some states do not allow the exclusion or limitation of consequential or incidental damages, so the above limitations or exclusions may not apply to you.

Legal Remedies: This warranty gives you specific legal rights and you may also have other rights that vary from state to state.

Warranty Performance: During the above warranty period, your product will be replaced with a comparable product if the defective product is returned, postage prepaid, to KIDDE Safety, Customer Service Department, 1-800-880-6788, together with proof of purchase date. Please include a note describing the problem when you return the unit. The replacement product will be in warranty for the remainder of the original warranty period or for six months, whichever is longer. Other than the cost of postage, no charge will be made for replacement of the defective product.

Important: Do not remove back cover. Back cover removal will void warranty.

Your *Nighthawk Carbon Monoxide Alarm* is not a substitute for property, disability, life or other insurance of any kind. Appropriate insurance coverage is your responsibility. Consult your insurance agent.

Free Manuals Download Website

<http://myh66.com>

<http://usermanuals.us>

<http://www.somanuals.com>

<http://www.4manuals.cc>

<http://www.manual-lib.com>

<http://www.404manual.com>

<http://www.luxmanual.com>

<http://aubethermostatmanual.com>

Golf course search by state

<http://golfingnear.com>

Email search by domain

<http://emailbydomain.com>

Auto manuals search

<http://auto.somanuals.com>

TV manuals search

<http://tv.somanuals.com>