

MODEL
HDL-6



HDL-6

HIGH DEFINITION SPEAKER SELECTION SYSTEM



INSTALLATION & OPERATION GUIDE

HDL-6

High Definition Speaker Selection System

TABLE OF CONTENTS

Introduction	1
Features and Benefits	2
Installation Considerations	4
Installation	9
Operation	11
Specifications	14



Introduction

The HDL-6 allows you to connect up to six pairs of speakers to your stereo receiver or amplifier and play any one pair, any combination of pairs, or all pairs at once. You don't have to worry about overloading your amplifier. The HDL-6 has a protection circuit that keeps your amplifier running safely, even if you have all six pairs of speakers playing at the same time.

Features and Benefits

The HDL-6 offers a number of improvements over other speaker selectors:

- High power handling capability of 250 watt/channel continuous music power.
- Pre-printed Room Labels are included for easy identification of speaker ON/OFF buttons.
- Rear-panel switch for constant or selectable impedance protection.
- Self-cleaning, silver-plated switch contacts assure many years of trouble-free use.
- Isolated left and right channel ground returns make the HDL-6 compatible with all types of amplifiers.
- Massive copper traces on printed circuit board handle large amounts of amplifier current, ensuring high dynamic range and clarity.
- Two-piece removable connectors greatly simplify installation and hookup. All wiring can be attached directly to the connectors before installing them in the HDL-6.

TECH SUPPORT HOTLINE

If you have questions regarding the operation of the Niles HDL-6, contact your local Niles dealer or Niles Customer Service at 1-800-289-4434.

- Removable connectors accommodate up to 14 gauge wire or "pins", making the HDL-6 compatible with most "high-definition" speaker cables.
- 100% tested, electronically and acoustically, for frequency response, distortion and power handling.
- Standard 17" width allows the HDL-6 to stack neatly with other standard size components.
- May be used with 4, 6, or 8-ohm speaker systems.
- Ideal for both home and commercial sound installations.
- Only an 1/8" standard screwdriver and wire stripper are required for installation.
- Frequency response: Flat (+0 dB, -0 dB) from 20 Hz to 20 kHz.
- Ten year parts and labor warranty.
- Proudly made in the USA.

Installation Considerations

HDL-6 Power Handling

The HDL-6 is designed for use with a receiver or amplifier having a maximum power output of 250 watts per channel at 8 ohms. Damage caused by the use of a higher-power receiver or amplifier will void the warranty. Consult your Niles dealer, or receiver/amplifier manufacturer, if you are uncertain about the power rating of your receiver or amplifier.

Amplifier Impedance Load

As more pairs of speakers are parallel connected to a receiver or amplifier, the overall system impedance becomes lower. For example, if two pairs of 8-ohm speakers are connected in parallel, the impedance will be 4 ohms; two pairs of 4-ohm speakers in parallel become 2 ohms, and so on.

Most receivers or amplifiers are not rated for use below a 4 ohm load. Most manufacturers do not recommend connecting more than two pairs of speakers without using some form of impedance correction.

The HDL-6 includes impedance correction circuitry which protects your receiver or amplifier from low impedance loads. The circuitry assures that your receiver or amplifier will see a safe operating load, even when all six speaker pairs are playing at the same time.

TOOLS REQUIRED

- 1/8" Standard Slotted Screwdriver
- Wire Stripper

The actual impedance load the HDL-6 presents to your receiver or amplifier will vary, depending on how many speaker pairs are playing, and the impedance rating of each speaker. If you have six pairs of 8-ohm speakers playing, the HDL-6 will present a 4.3 ohm impedance load to your receiver/amplifier. With six pairs of 4-ohm speakers playing, the load drops to slightly under 4 ohms.

"TECH TIP"

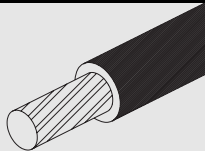

Wire size is expressed by its AWG (American Wire Gauge) number. The lower the AWG number, the larger the wire, i.e., 12 AWG wire is physically larger

If you intend to use the HDL-6 with more than two pairs of 4-ohm speakers, it is recommended that you verify that the receiver or amplifier is capable of driving a 4-ohm load. Consult your Niles dealer, or receiver/amplifier manufacturer, if you are uncertain about the capabilities of the receiver/amplifier.

Type of Speaker Wire

For most applications, we recommend you use 16 or 18 gauge, stranded copper speaker wire for the HDL-6 connections. For wiring runs longer than 80 feet, 14 gauge wire is recommended. Using speaker wire larger than 14 gauge for the HDL-6 connections is not recommended—the wire may not fit into the connectors. Never use solid-core, aluminum, or "Romex" type wire with the HDL-6. When running speaker wires inside walls, most states and municipalities in the U.S. specify that you must use a special type of speaker wire. Usually, the requirement is that the wire has a specific "CL" fire rating, such as "CL-2" or "CL-3". Consult your Niles dealer, building contractor, or local building and inspection department if unsure about which type of wire is best for your application.

Avoiding Interference

Speaker wires can act as an "antenna" for electrical noise. Locating speaker wires too close to a light dimmer or switch may cause a "buzzing" or "popping" sound to be heard through the speakers. If you must locate the HDL-6 wiring near electrical devices, route the speaker wires several feet away from the electrical wiring.

Using the HDL-6 with Tube-Type Amplifiers

Virtually all tube amplifiers must have a load connected at all times. If the amplifier to be connected to the HDL-6 is a tube amplifier, be sure to always have at least one pair of speakers switched on at all times. An alternative is to permanently connect a 150 ohm, 5 watt resistor across the tube amplifier's output in parallel with the HDL-6. See **(Figure 1)** on next page for hookup diagram.

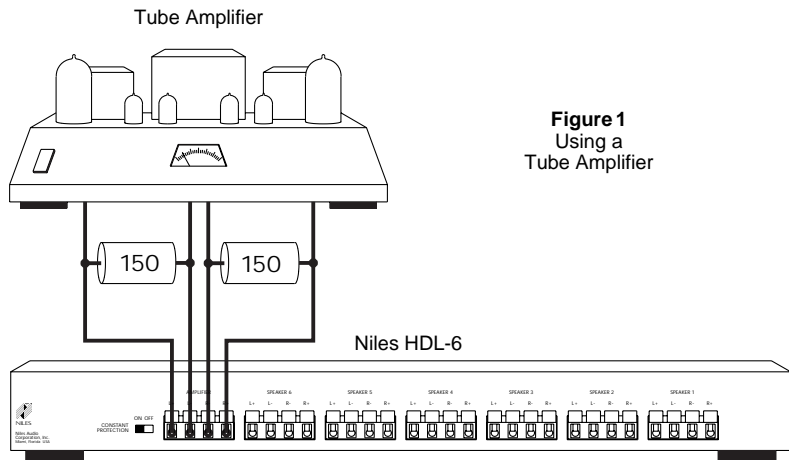
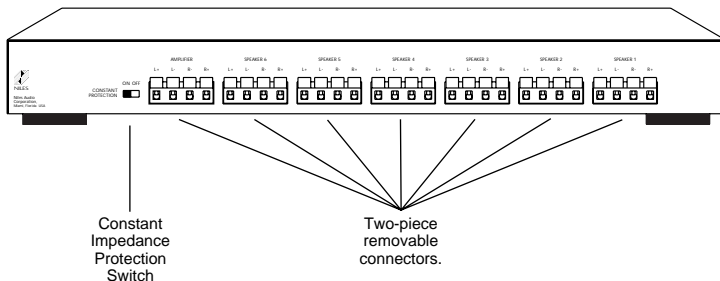
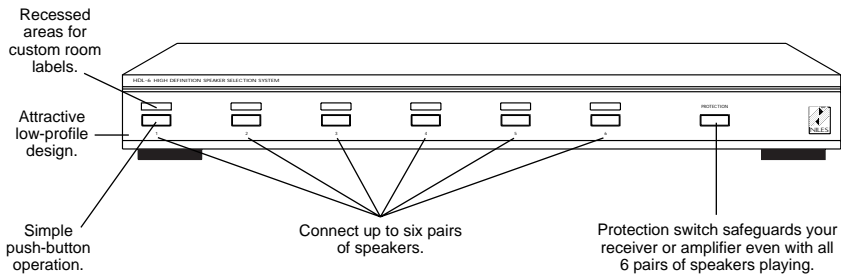

Figure 1
Using a
Tube Amplifier

HIGH DEFINITION SPEAKER SELECTION SYSTEM



Installation

1. Select a convenient mounting location for the HDL-6.
2. Run all the necessary wiring to the HDL-6. Label the wires for future reference. See (Figure 2).

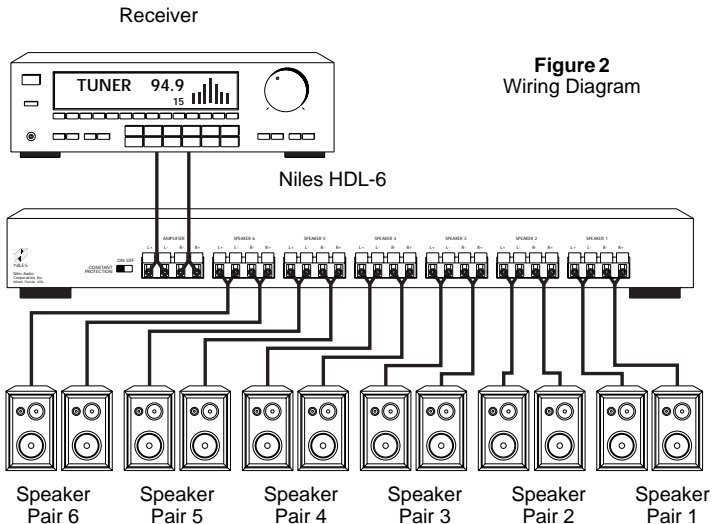

3. Make the connections to the HDL-6. The amplifier/speaker connectors on the HDL-6 are removable. If you wish, you may remove the HDL-6's connectors to facilitate installation see **(Figure 3)**. Strip 3/8" of insulation from the end of each wire. Tightly twist the end of each wire until there are no frayed ends. Insert each wire into the appropriate hole on the spring-loaded connector terminals. Be certain that proper phasing is observed—connect the positive terminals on the HDL-6 to the positive terminals on the amplifier and speakers and the negative terminals on the HDL-6 to the negative terminals on the amplifier and speakers. Re-install the connectors if they were removed. See **(Figure 4)**.

4. Locate the pre-printed Room Labels. Affix the appropriate label to the recessed area over each ON/OFF selector button.

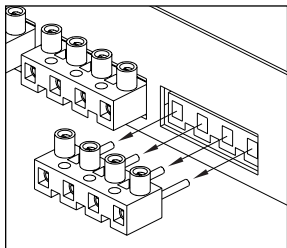

Figure 3
Removing the Connectors

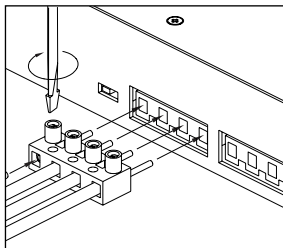

Figure 4
Installing the Connectors

Operation

There are two ways to use the HDL-6. You may play one pair of speakers at a time, or play multiple pairs simultaneously.

If you intend to play more than one pair of speakers at the same time, you will need to become familiar with the operation of the HDL-6's PROTECTION button.

Playing One Pair of Speakers At a Time

1. Make sure the amplifier or receiver power is OFF and set the volume to minimum.
2. Locate the ON/OFF button on the HDL-6 which corresponds to the speaker pair you wish to play. Set it to the ON position.
3. Turn on the amplifier or receiver and select a source, such as the tuner or CD player.
4. Slowly turn up the amplifier or receiver volume and set it to a comfortable (not maximum) listening level. Be careful not to overdrive or "clip" your amplifier. If the sound becomes muddy or distorted, you have reached the limit of your amplifier's volume capability and should quickly reduce the volume to avoid damaging your speakers.
5. To turn off the speaker pair, simply press the corresponding ON/OFF button on the HDL-6.

"TECH TIP"

If your amplifier or receiver has "A" and "B" speaker-pair outputs, connect the HDL-6 to the "A" outputs.

Do not connect anything to "B". This will prevent the amplifier or receiver from driving an unusually low impedance load.

Playing Two or More Speaker Pairs Simultaneously

1. Make sure the amplifier or receiver power is OFF and set the volume to minimum.
2. On the right side of the HDL-6's front panel is a button labeled PROTECTION. This button activates the HDL-6's impedance correction circuitry. The circuitry assures that your receiver or amplifier will see a safe operating load when playing multiple speaker pairs simultaneously. Since most receivers and amplifiers are not rated for use below a 4 ohm load, you will need to activate the PROTECTION button whenever the overall system impedance might fall below 4 ohms. Use the following chart as a guide for setting the PROTECTION button.

"TECH TIP"

You will need to activate the HDL-6's PROTECTION button whenever the overall system impedance might fall below 4 ohms.

When playing the following speakers:	The Protection button should be:
1 or 2 pair of 8-ohm speakers	OFF
3 or more pairs of 8-ohm speakers	ON
1 pair of 4-ohm speakers	OFF
2 or more pairs of 4-ohm speakers	ON
Any combination of 4 and 8 ohm speakers	ON

Set the PROTECTION button to the correct position using the chart shown above.

3. Locate the ON/OFF buttons on the HDL-6 which correspond to the speaker pairs you wish to play. Set them to the ON position.

4. Turn on the amplifier or receiver and select a source, such as the tuner or CD player.
5. Slowly turn up the amplifier or receiver volume and set it to a comfortable (not maximum) listening level. Be careful not to overdrive or "clip" your amplifier. If the sound becomes muddy or distorted, you have reached the limit of your amplifier's volume capability and should quickly reduce the volume to avoid damaging your speakers.
6. To turn off one or more speaker pairs, simply press the corresponding ON/OFF button(s) on the HDL-6. Refer to the Protection chart for the correct setting of the PROTECTION button.

Constant Protection Switch

The HDL-6 is equipped with a manual override for the protection circuit that enables you to defeat the front panel protection switch and maintain constant impedance protection. This will safeguard your amplifier from being overdriven due to accidental or improper use by anyone unfamiliar with the equipment.

To engage this override, move the rear panel "CONSTANT PROTECTION" switch to the "ON" position. Constant impedance protection will be maintained until the switch is turned to "OFF".

Balancing Speaker Volume

The volume control on your receiver or amplifier serves as the "master" volume for all speaker pairs connected.

The volume level of the speakers may vary from room to room. This is caused by several factors. Two lesser factors are the size of the speaker and its efficiency. The largest factor is the physical size of the room.

The best way to balance speaker volume is to equip each of the speaker pairs in your system with a Niles volume control. The controls allow you to adjust the volume of each speaker pair individually. If all the speaker pairs in your system are equipped with Niles volume controls, you can leave the amplifier or receiver volume set at one position and use the Niles controls exclusively.

SPECIFICATIONS

Audio Power Handling

250 watts/channel
continuous music
power

Frequency Response

+0 dB, -0 dB (flat) from
20 Hz to 20 kHz

Mounting

Table-Top component

Wiring Requirements

Individual runs of
2-conductor speaker
wire. Connectors
accommodate wire
sizes 14-22 gauge (16
gauge recommended)

Overall Dimensions

17" wide x 2" high x
8-3/4" deep

Weight

4 3/4 lb.



Niles Audio
Corporation

www.nilesaudio.com

12331 S.W. 130 Street
Miami, Florida 33186
Tel: (305) 238-4373
Fax: (305) 238-0185

© 1999 Niles Audio Corporation. All rights reserved. Because Niles constantly strives to improve the quality of its products, Niles reserves the right to change product specifications without notice. Niles and the Niles logo are registered trademarks of Niles Audio Corporation. Printed in USA 4/96 DS00100A

www.Somanuals.com. All Manuals Search And Download.

Free Manuals Download Website

<http://myh66.com>

<http://usermanuals.us>

<http://www.somanuals.com>

<http://www.4manuals.cc>

<http://www.manual-lib.com>

<http://www.404manual.com>

<http://www.luxmanual.com>

<http://aubethermostatmanual.com>

Golf course search by state

<http://golfingnear.com>

Email search by domain

<http://emailbydomain.com>

Auto manuals search

<http://auto.somanuals.com>

TV manuals search

<http://tv.somanuals.com>