

IntelliControl[®]ICS
INTEGRATED CONTROL SOLUTIONS

QUICK INSTALL GUIDE

TM-XM

XM[®] SATELLITE RADIO MODULE

ENGINEERED BY



NILES[®]

IntelliControl[®] ICS

INTEGRATED CONTROL SOLUTIONS

The TM-XM is an XM[®] Satellite Radio module that slides into the card cage on an IntelliControl[®] ICS Modular MultiZone Receiver. The card outputs metadata (channel name, channel number, category, artist and track) on IntelliControl ICS user interfaces with LCD displays. It has all the functionality of a normal tuner: seek through stations: access to 20 favorite channels and direct access to a station by entering the channel number. In addition, the TM-XM provides navigation of content by category and channel guide. Multiple TM-XM modules can be used in a single chassis to allow different XM channels to be played simultaneously in different zones.

Table of Contents

Product Overview	2
Installation	4
Operating the TM-XM Module	12
Troubleshooting	35
Accessories and Specifications	37
Contact Information	38
Warranty	39

PRODUCT OVERVIEW

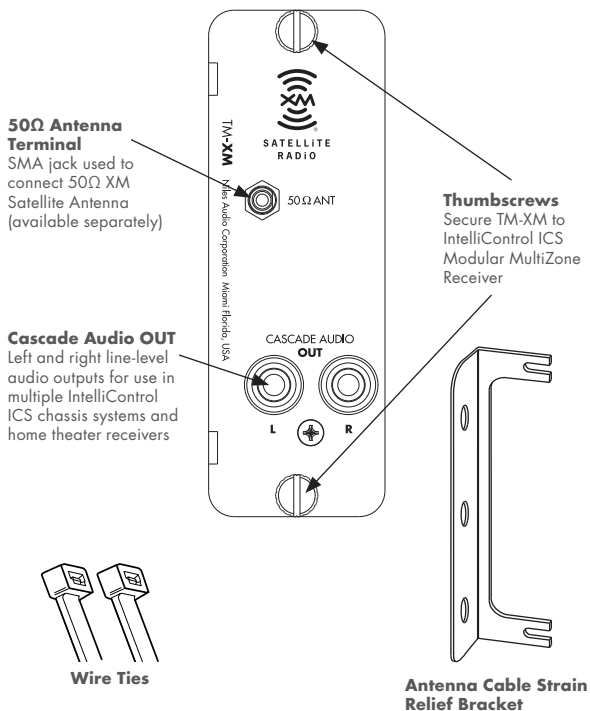

Figure 1. IntelliControl ICS TM-XM Module

FEATURES AND BENEFITS

Plug and Play Integration

The TM-XM module will automatically identify itself to the IntelliFile® 3 Configuration Software during system configuration and map all appropriate control functions to all user interfaces.

Metadata

Category, channel name, channel number, artist and song information is displayed on IntelliControl ICS user interfaces with displays.

20 Favorite Channel Presets

User-defined favorites allow easy access to the most listened to stations. Favorites are displayed on user interfaces with displays and are configurable in either IntelliFile® 3 or from the user interfaces with displays.

Add to Favorites

Allows user changes to favorites from user interfaces with displays.

Direct Access Tuning

Provides direct entry of station channel from user interfaces with numeric keys.

Program Search by Category

Displays channel lists when searched by program type (i.e. rock, jazz, classical, traffic & weather, etc).

Channel Guide

Channel Guide lists all available XM Channels.

FEATURES AND BENEFITS (CONT'D)

Channel Skip/Add

Omit channels from the channel list by designating them as "skipped." Channels can be added back into the list later.

Signal Strength Indicator

Shows strength of station broadcast signal on user interfaces with displays.

INSTALLATION

WARNING: Always turn power OFF on the IntelliControl ICS Modular MultiZone Receiver and be sure the AC line cord is disconnected to avoid damage and electrical shock before making any connections to the TM-XM Module.

CAUTION: The TM-XM Module is susceptible to static discharge. Be sure to use a grounding strap or touch an earth ground prior to picking up the TM-XM. Handle the card by its edges.

1. Carefully slide the TM-XM Module into the appropriate card slot. (Refer to the GXR2 Installation Worksheet to assure proper card slot number.)
2. Concentrate on the GXR2 card cage guides as you insert the module card.

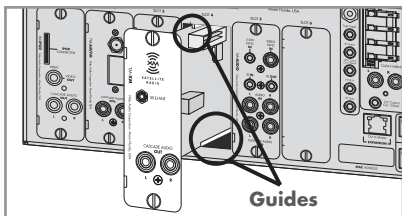

Figure 2. Inserting the module card into the GXR2 card cage.

INSTALLATION (CONT'D)

3. Make sure the TM-XM is fully engaged and sits flush against the GXR2.
4. Before tightening the thumbscrews, insert the cable strain relief bracket onto the two thumbscrews.

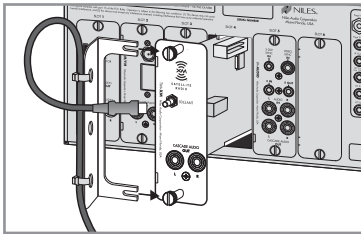

Figure 3. Insert the relief bracket onto the two thumbscrews.

5. Tighten thumbscrews. (Do not over tighten.)
6. Attach the antenna to the connector of the TM-XM card, making a short loop of the antenna cable and attaching the cable to the strain relief bracket using the supplied wire ties.

INSTALLATION (CONT'D)

Connecting an Antenna to the TM-XM Module Card

When all modules are in place, and the system components have been installed, connect a satellite radio antenna **A** to the 50Ω ANT jack on the TM-XM Module Card **C**.

Note: A Satellite Radio Antenna is not included with the TM-XM

Aiming the Antenna

Choose a mounting location for the Satellite Radio Antenna that has a clear and unobstructed view of the sky. Position the antenna for optimum signal strength in your area of the country.

Multiple TM-XM Module Cards

When using more than one TM-XM Module Card in an installation, each tuner must be connected to a satellite radio antenna. The Niles SRK-2W or SRK-4W **B** allows for one antenna to provide proper signal strength to multiple TM-XM tuner modules. (See **Figure 5**.)

Niles manufactures a line of satellite radio accessories that include a satellite radio antenna (ANT-SAT) and an Installation Kit for One Satellite Radio Tuner (SRK-1W) **B**. (See **Figure 4**)

See: www.nilesaudio.com for the complete line of Satellite Radio Accessories.

Figure 4: Installation diagram for one satellite tuner using the SRK-1W Installation Kit.

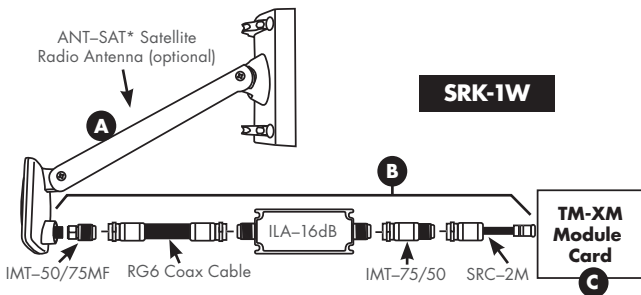
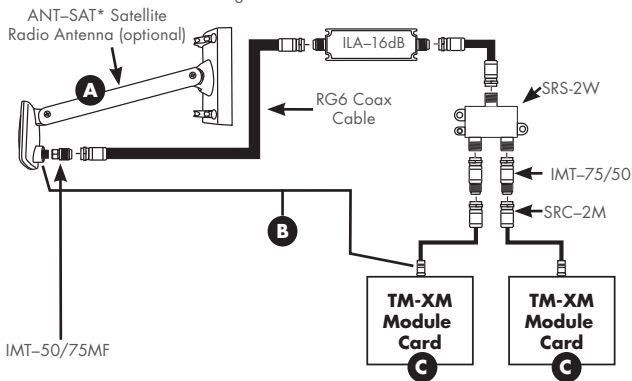

Figure 5: Installation diagram for two satellite tuners using the SRK-2W Installation Kit.



* ANT-SAT sold separately

INSTALLATION (CONT'D)

Antenna Adjustment

1. Adjust the XM antenna for signal strength. For best results, the antenna should be mounted outdoors with an unobstructed southeast facing. Some directional adjustment will be needed to attain optimum signal strength. When the antenna is in the optimum position, the signal strength indicator, located on the User Interface LCD in the upper left corner, will show three bars.
2. To test the TM-XM prior to activation, tune to Channel 1. (XM Preview) If the "Preview Channel" plays, the tuner is ready for activation.

NOTE: See "Troubleshooting" for additional information regarding on-screen messages.

INSTALLATION (CONT'D)

Activation

It is recommended that the homeowner activate the XM Subscription Service, to make service package choices and to assure proper subscription and billing information. If providing this service for the homeowner:

1. Have IntelliControl ICS System powered up and active with TM-XM selected.
2. Tune to Channel 0 to get the XM ID Number.
3. Find the 8-character XM Radio ID of the XM card. Write the number down for future reference.
4. You can now activate XM by calling 1-800-XM-RADIO (1-800-967-2346) or on the internet visit <http://activate.xmradio.com> and have the homeowner's credit card and XM Radio ID ready and follow the prompts to activate your subscription.

INSTALLATION (CONT'D)

Expanding the System

When using multiple chassis, connect the Left and Right Cascade Audio OUT of the TM-XM to the Left and Right Audio IN on the IM-AUDIO Module in the same number card slot on the Slave chassis. Up to four Slave chassis may be used in a system.

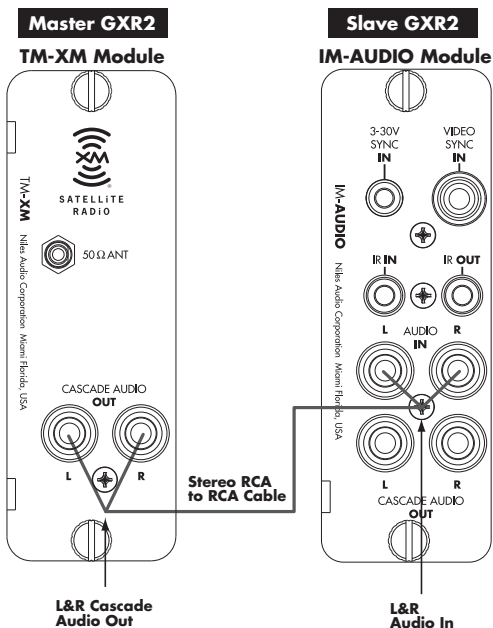
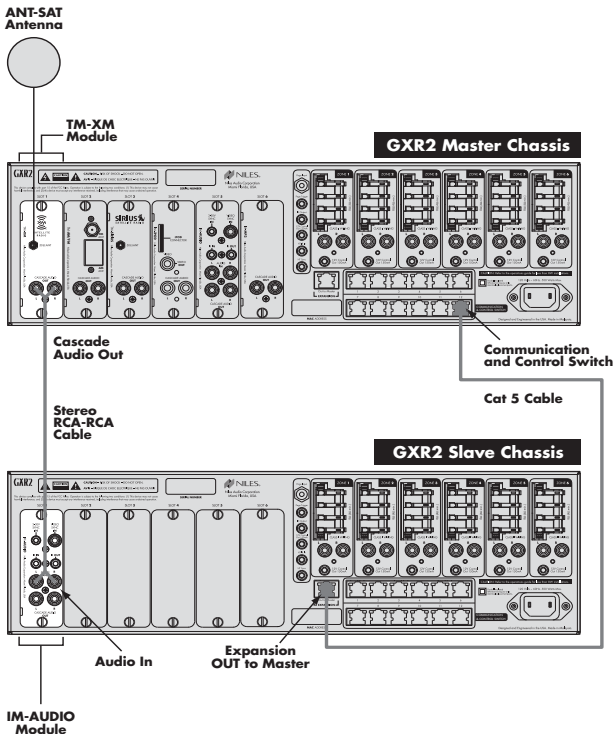

Figure 6. Cascade Audio Connections

INSTALLATION (CONT'D)

Expanded Systems Diagram



OPERATING THE TM-XM MODULE

There are various user interfaces that operate with the TM-XM Module. The following pages contain explanations for controlling XM Satellite Radio with the Display, iRemote and Contact user interfaces.

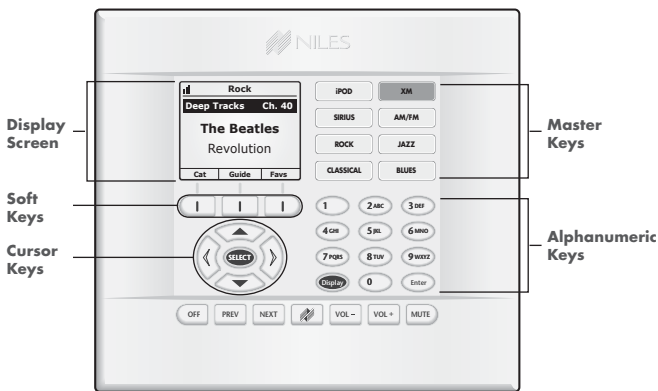

DISPLAY

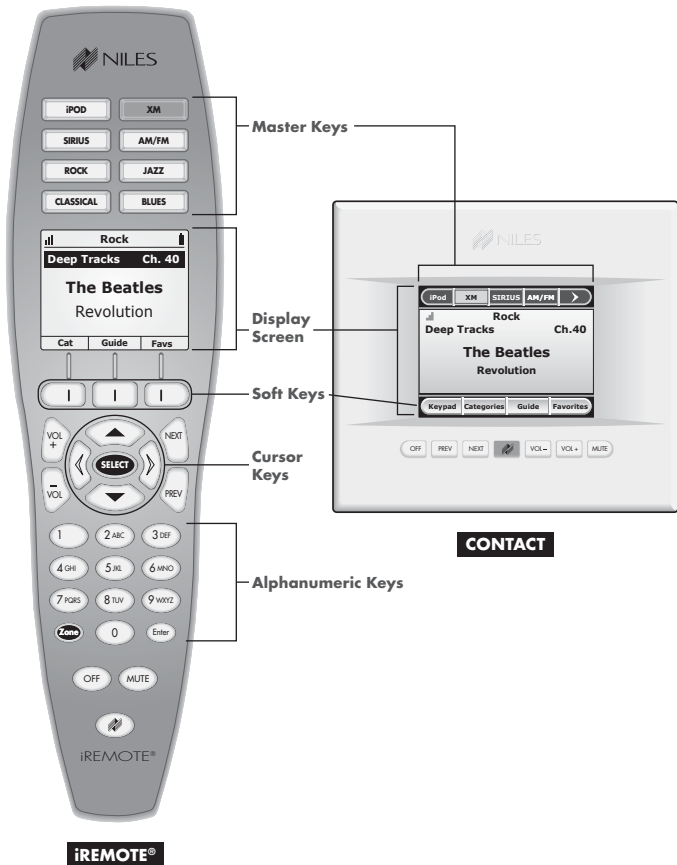

OPERATING THE iREMOTE AND DISPLAY

PLAYING XM SATELLITE RADIO

To start the XM Module playing, press the **XM Master Key**.
(i.e., )



CHANGING CHANNELS

To tune to the next available channel, press the **NEXT**  **Key** for the next available channel.

Press the **PREV**  **Key** for the previous available channel.

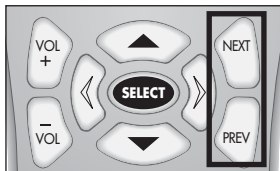

OPERATING THE iREMOTE AND DISPLAY (CONT'D)

ADJUSTING VOLUME

Press the **VOL+**  **Key**
to raise volume.

Press the **VOL-**  **Key**
to lower volume.

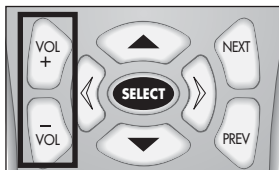

TUNE TO A CHANNEL USING THE NUMERIC KEYS

To tune to a channel using the numeric keys, press the numeric keys for the XM channel to be played (i.e. "4", "0"), then press the **Enter**  **Key**.



OPERATING THE iREMOTE AND DISPLAY (CONT'D)

SELECT A CHANNEL BY CATEGORY

To select a channel by Category, press the **[Cat] Soft Key**, a list of Categories appears.



To go to the next page of Categories, press the **[^ Page]** or **[Page v] Soft Keys**.

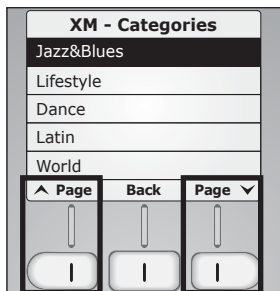

OPERATING THE iREMOTE AND DISPLAY (CONT'D)

SELECT A CHANNEL BY CATEGORY (CONT'D)

To scroll through categories within a page, press the **Cursor**

 or  **Keys.**

The highlight moves to the next line.

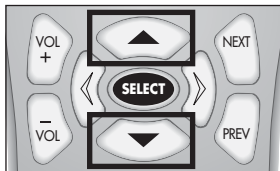

To make a selection, press the **Select**  **Key.**

A list of XM channels in the selected category appears.

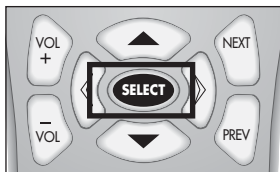

Select the desired channel by pressing the **Select**  **Key.**

The selected channel begins playing.

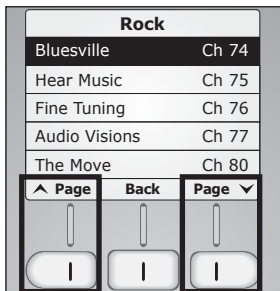

OPERATING THE iREMOTE AND DISPLAY (CONT'D)

SELECT A CHANNEL BY CHANNEL GUIDE

To select a channel by "Channel Guide", press the **[Guide] Soft Key**. A list of available channels appears.



To go to the next page of available channels, press the **[^ Page] or [Page v] Soft Keys**.

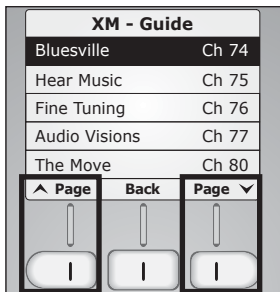

To scroll through channels within a page, press the **Cursor**  or  **Keys**.

The highlight moves to the next line.

To make a selection, press the **Select**  **Key**.

The selected channel begins playing.

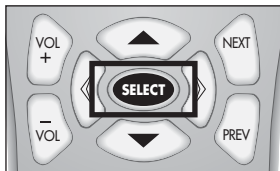

OPERATING THE iREMOTE AND DISPLAY (CONT'D)

SELECT A FAVORITE CHANNEL

To select a Favorite channel, press the **[Favs] Soft Key**, the list of preset Favorites appears.



To go to the next page of available Favorites, press the **[^ Page] or [Page v] Soft Keys**.



To scroll through Favorites within a page, press the **Cursor**  or  **Keys**.

The highlight moves to the next line.

To make a selection, press the **Select**  **Key**.

The selected Favorite begins playing.

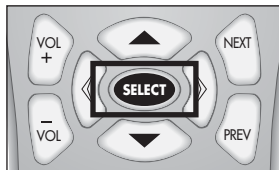

OPERATING THE iREMOTE AND DISPLAY (CONT'D)

ADD A FAVORITE CHANNEL

To add a channel to the Favorite channel list, tune to the channel to be added, then press the **[Favs] Soft Key**.

The "XM-Favorites" menu appears.

Use the **Cursor**  **Key** to highlight **[Add to Favorites]** in the menu.

To add the channel to your Favorite list, press the **Select**  **Key**.

The added channel appears in the next available position in the Favorites list.

You can enter up to 20 favorite channels to the list.

Press the **[Back] Soft Key** to return to the "Now Playing" screen.

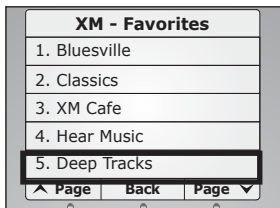
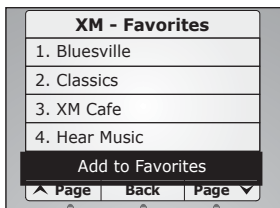



OPERATING THE iREMOTE AND DISPLAY (CONT'D)

DELETE/REPLACE A FAVORITE CHANNEL

To delete a Favorite, press the **[Favs] Soft Key**.

The "XM-Favorites" menu appears.

Use the **Cursor**  or  **Key** to select the Favorite to be deleted.



Press and hold the **Select**  **Key** for two seconds.

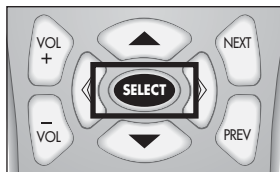

The "Replace/Delete" menu appears.

Highlight **[Delete]** and press the **Select**  **Key**.

To replace, simply tune to the new station you wish to replace with, then follow the previous steps and select **[Replace]** instead of Delete.

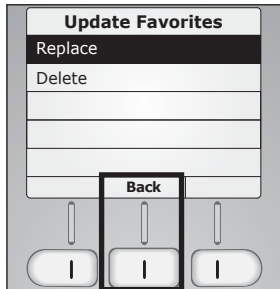

OPERATING THE iREMOTE AND DISPLAY (CONT'D)

ADD/SKIP CHANNELS IN THE CHANNEL GUIDE



To add or skip channels in the Channel Guide, press and hold the **[Guide] Soft Key** for two seconds.

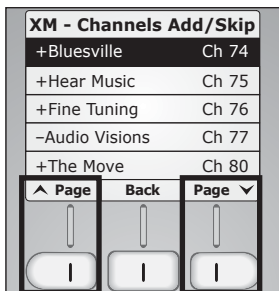

The "Add/Skip Channel" menu appears.

To go to the next page of available channels, press the **[^ Page]** or **[Page v]** Soft Keys.



To scroll through channels within a page, press the **Cursor**  or  Keys.

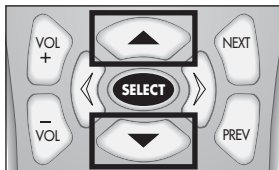

OPERATING THE iREMOTE AND DISPLAY (CONT'D)

ADD/SKIP CHANNELS IN THE CHANNEL GUIDE (CONT'D)

To add or skip the highlighted channel, press the **Select**  **Key**. The selected channel displays **[+]** when it is included in the guide and **[-]** when it will be skipped.

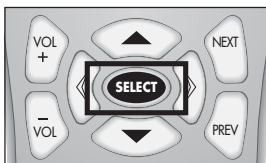

Press the **[Back] Soft Key** to return to the "Now Playing" screen.

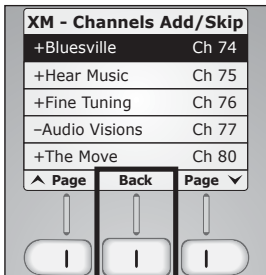

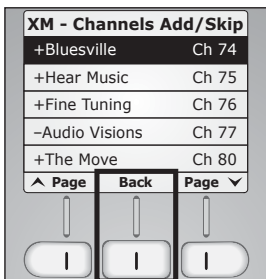

EXIT TO XM NOW PLAYING SCREEN

To exit from a menu and return to the "Now Playing" screen, press the **[Back] Soft Key** repeatedly or press and hold the **[Back] Soft Key** for two seconds.



OPERATING THE iREMOTE AND DISPLAY (CONT'D)

MUTING

Press the **MUTE**  **Key** to mute the zone. Press the **MUTE**  **Key** again to un-mute the zone.

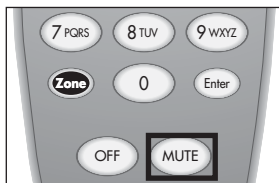

TURNING THE ZONE OFF

Press the **OFF**  **Key** to turn the zone off.



TURNING OFF ALL ZONES

Press and hold the **OFF**  **Key** for 2 seconds to turn Off all zones.



OPERATING CONTACT TOUCHSCREEN

PLAYING XM SATELLITE RADIO

Touch the **Master Key** labeled XM and music begins playing (i.e., ).



CHANGING CHANNELS



Press the **NEXT**  **Key** for the next available channel.

Press the **PREV**  **Key** for the previous available channel.



OPERATING CONTACT TOUCH SCREEN (CONT'D)

ADJUSTING VOLUME

Press the **VOL-**  **Key** to lower volume. Press the **VOL+**  **Key** to raise volume.



TUNE TO A CHANNEL USING THE NUMERIC KEYS

To tune to a channel using the numeric keys, touch the numeric keys for the XM channel to be played (i.e. [4], [0]), then touch the  **Soft Key**.

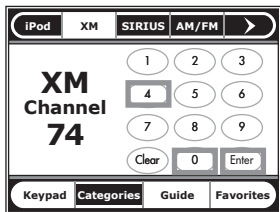

OPERATING CONTACT TOUCH SCREEN (CONT'D)

SELECT A CHANNEL BY CATEGORY

To select a channel by category, touch the **Categories** Soft Key. A list of categories appears.



To go to the next page of categories, touch the **Page** Soft Key or **Page** Soft Key.

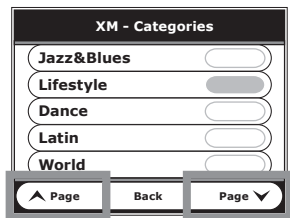

OPERATING CONTACT TOUCH SCREEN (CONT'D)

SELECT A CHANNEL BY CATEGORY (CONT'D)

To make a selection, touch a category (i.e., [Lifestyle]).

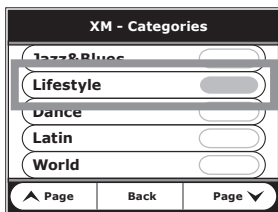

A list of XM channels in the selected category appears. Select the desired channel (i.e., [Fine Tuning - Ch 76]).

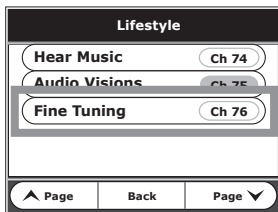

The selected channel begins playing. The "Now Playing" screen will show.

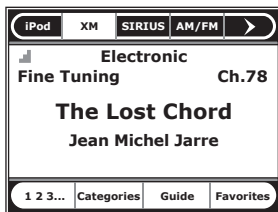

OPERATING CONTACT TOUCH SCREEN (CONT'D)

SELECT A CHANNEL BY CHANNEL GUIDE

To select a channel by Channel Guide, touch the **Guide** **Soft Key**. A list of available channels appears.



To go to the next page of Channels, touch the **Page** **Soft Key** or **Page** **Soft Key**.

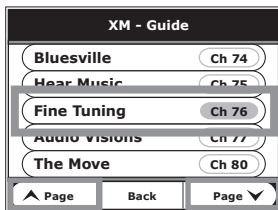

Select the desired channel (i.e., [Fine Tuning - Ch 76]).



The selected channel begins playing. The "Now Playing" screen will show.

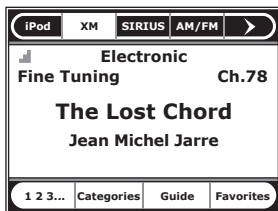

OPERATING CONTACT TOUCH SCREEN (CONT'D)

SELECT A FAVORITE CHANNEL

To select a Favorite channel, touch the **Favorites** Soft Key. The list of preset Favorites appears.

To go to the next page of available Favorites, touch the **Page** or **Page** Soft Key.

Select the desired channel (i.e., [3. XM Cafe]).



The selected channel begins playing. The "Now Playing" screen will show.

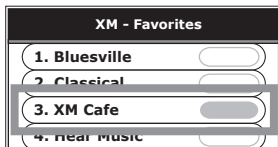
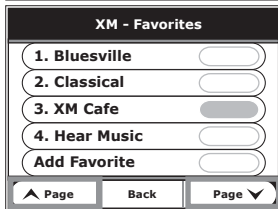

OPERATING CONTACT TOUCH SCREEN (CONT'D)

ADD A FAVORITE CHANNEL

To add a channel to the Favorite channel list, tune to the channel to be added, then touch the

Favorites **Soft Key**.



The "XM-Favorites" menu appears.

To add the station to your Favorite list, touch the **[Add to Favorites]** **Soft Key**.

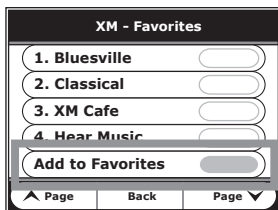

The added station appears in the next available position in the Favorites list. You can enter up to 20 favorite stations to the list.

Touch the **Back** **Soft Key** to return to the "Now Playing" screen.

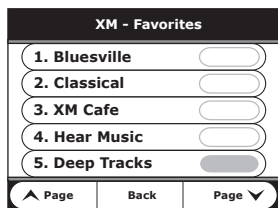

OPERATING CONTACT TOUCH SCREEN (CONT'D)

DELETE/REPLACE A FAVORITE CHANNEL

To delete a Favorite channel, touch, the **Favorites** Soft Key.



The "XM-Favorites" menu appears.

Touch and hold the Favorite channel to be deleted for two seconds.

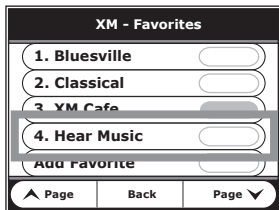

The "Replace/Delete Menu" appears.

Touch the **[Delete]** Soft Key to remove the Favorite.

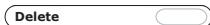

To replace, simply tune to the new station you wish to replace, then follow the previous steps and touch the **[Replace]** Soft Key instead of the delete key.

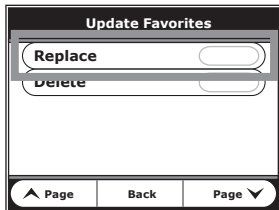

OPERATING CONTACT TOUCH SCREEN (CONT'D)

ADD/SKIP CHANNELS IN THE CHANNEL GUIDE

To Add or Skip channels in the Channel Guide, touch and hold the **Guide** **Soft Key** for two seconds.



The "Add/Skip Channel" menu appears.

To go to the next page of available channels, touch the **Page** **Soft Key**.

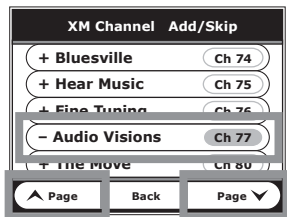



To add or skip the highlighted channel, touch the selected channel key. The selected channel displays [+] when it is included in the guide and [-] when it will be skipped.

Touch the **Back** **Soft Key** to return to the "Now Playing" screen.





OPERATING CONTACT TOUCH SCREEN (CONT'D)

EXIT TO "NOW PLAYING" SCREEN

To exit from a menu and return to the "Now Playing" screen, touch the  **Back Soft Key** repeatedly or touch and hold the  **Back Soft Key** for two seconds.



MUTING

Press the **MUTE**  **Key** to mute the zone. Press the **MUTE**  **Key** again to unmute the zone.



TURNING THE ZONE OFF

Press the **OFF**  **Key** to turn the zone off.



TURNING OFF ALL ZONES

Press and hold the **OFF**  **Key** for 2 seconds to turn all the zones off.



TROUBLESHOOTING

PROBLEM	SOLUTION
CONTROL	
iRemote/Keypad does not control TM-XM	<ul style="list-style-type: none"> a) Confirm TM-XM is in proper card slot in MultiZone Receiver card cage. b) Check Module connection to header in card cage. c) Confirm XM Radio Subscription activation.
SIGNAL STRENGTH/RECEPTION	
Weak or no signal	<ul style="list-style-type: none"> a) Check 50 ohm antenna connection. b) Reposition antenna to improve reception c) Install Niles SRS-2W or SRS-4W when using more than one TM-XM.
PRESETS	
No channels in Favorites	Program Favorite channels using IntelliFile® 3 or User Interface.
AUDIO	
No Audio in expansion zones	Check connection of L&R Cascade Audio OUT from TM-XM to L&R Audio IN on IM-AUDIO Module.

TROUBLESHOOTING (CONT'D)

ERROR MESSAGE	SOLUTION
ANTENNA	
Problem with antenna connection	a) Check antenna connection b) Check antenna cable for shorts
UPDATING	
User encryption code has changed and is being updated	Wait for encryption code to finish updating
NO SIGNAL	
Signal is too weak to tune in	Confirm that antenna has not moved or is being obstructed from "line of sight" to satellite
OFF AIR	
Selected channel is not currently broadcasting	Tune to another channel
OR CHANNEL	
Channel SID is no longer available	Tuner will switch automatically to Channel 1
Metadata not available for Artist Name/Feature, or Song/Program Title	No action required

ACCESSORIES

Niles Audio manufactures the following accessories for use with the TM-XM Module. For more Satellite Radio Accessories visit nilesaudio.com:

ANT-SAT	XM/SIRIUS Satellite Radio Antenna	FG01254
SRK-1W	Installation Kit for One (1) Satellite Radio Tuner	FG01258
SRK-2W	Installation Kit for Two (2) Satellite Radio Tuners	FG01260
SRK-4W	Installation Kit for Four (4) Satellite Radio Tuners	FG01262

SPECIFICATIONS

Power:	Provided when installed into GXR2 chassis
XM tuning range:	2332.5 to 2345 MHz
Channels:	Up to 180 channels based on user's subscription package
XM antenna connection:	50Ω SMB
Requires:	XM Subscription for content

DIMENSIONS

XM Module Card:	1-1/4" W x 3-3/4" H x 7-1/4" D
Warranty:	Two-year limited
Shipping Weight:	1 lb.

COMPLIANCE & CERTIFICATIONS

Safety:	Evaluated to UL/EN 60065
EMC:	FCC Part 15 (GXR2)

CUSTOMER SERVICE TECHNICAL SUPPORT

BY PHONE (IN USA)

1-800-BUY-HIFI (289-4434)

BY PHONE (OUTSIDE USA)

1-305-238-4373

CUSTOMER SERVICE HOURS

8:00 AM to 5:30 PM ET

TECHNICAL SUPPORT HOURS

8:00 AM to 7:00 PM ET

ON THE WEB

www.nilesaudio.com

EMAIL TECHNICAL SUPPORT

techsupport@nilesaudio.com

EMAIL FOR PRODUCT SUGGESTIONS

productsuggestions@nilesaudio.com

LIMITED WARRANTY

Niles Audio Corporation ("NILES") warrants to the original retail purchaser only that this product will be free of manufacturing defects in material and workmanship for the following periods and subject to the limitations and exclusions set forth below:

Lifetime Warranty

All Passive Loudspeaker Products (those not requiring AC or battery power).

Ten years from the date of purchase

All Other Passive Products (those not requiring AC or battery power).

Two years from the date of purchase

All Active Products (those requiring AC or battery power).

This warranty is not transferable to subsequent purchasers of the product. To obtain warranty service, contact the authorized dealer where you purchased your product or take the unit to the nearest authorized NILES dealer (with proof of purchase – claims made without proof of purchase will be denied) who will test the product and if necessary, forward it to NILES for service. If there are no authorized NILES dealers in your area, you must contact NILES to receive a factory Return Authorization Number. DO NOT RETURN ANY UNIT WITHOUT FIRST RECEIVING WRITTEN AUTHORIZATION AND SHIPPING INSTRUCTIONS FROM NILES.

Upon examination, NILES will, at its sole option and expense, repair or replace any product found to be defective. NILES will return the repaired or replaced unit to you via its usual shipping method from the factory to your address in the United States of America or Canada only. Any shipping costs for addresses outside of the United States or Canada shall be the responsibility of the purchaser. In the event that this model is no longer available and cannot be repaired effectively, NILES, at its sole option, may replace it with a different model of equal or greater value, or refund the original purchase price paid. **THE FOREGOING ARE YOUR EXCLUSIVE REMEDIES FOR BREACH OF WARRANTY.**

This Warranty does not include service or parts to repair damage caused by improper use or handling, including but not limited to damage caused by accident, mishandling, improper installation, commercial use, abuse, negligence, or normal wear and tear, or any defect caused by repair to the product by anyone other than NILES.

This warranty does not cover reimbursement for your costs of removing and transporting the product for warranty service evaluation, or installation of any replacement product provided under this warranty.

This Warranty will be void if:

- the Serial Number on the product has been removed, tampered with or defaced.
- the product was not purchased from an authorized dealer or reseller.

THE FOREGOING WARRANTIES ARE EXCLUSIVE AND IN LIEU OF ALL OTHER EXPRESSED AND IMPLIED WARRANTIES. NILES EXPRESSLY DISCLAIMS ALL SUCH OTHER WARRANTIES, INCLUDING BUT NOT LIMITED TO IMPLIED WARRANTIES OF MERCHANTABILITY, FITNESS FOR A PARTICULAR PURPOSE AND NON-INFRINGEMENT, WITH RESPECT TO THE PRODUCT. TO THE MAXIMUM EXTENT PERMITTED BY LAW, NILES SHALL NOT BE RESPONSIBLE FOR ANY INCIDENTAL OR CONSEQUENTIAL DAMAGES EXCEPT TO THE EXTENT PROVIDED (OR PROHIBITED) BY APPLICABLE LAW, EVEN IF NILES HAS BEEN ADVISED OF THE POSSIBILITY OF SUCH DAMAGES.

Notwithstanding the above, if you qualify as a "consumer" under the Magnuson-Moss Warranty Act, or applicable state laws, then you may be entitled to any implied warranties allowed by law for the Warranty Period. Further, some states do not allow limitations on how long an implied warranty lasts or allow the exclusion or limitation of consequential damages, so such limitations may not apply to you. This warranty gives you specific legal rights, and you may also have other rights which vary from state to state.

For the name of your nearest authorized NILES dealer, contact: NILES AUDIO CORPORATION, P.O. BOX 160818, Miami, Florida 33116-0818, or call 1-800-289-4434, 1-305-238-4373. Please be advised that NILES only sells its products via the Internet through a select group of authorized Internet dealers. These are listed on our website at www.nilesaudio.com. Products offered on the Internet through unauthorized Internet dealers are not covered by the NILES warranty and may be either:

- 1) goods acquired on a secondary or grey market
- 2) counterfeit or stolen goods
- 3) damaged, or defective goods

Please fill in your product information and retain for your records.

Model TM-XM Serial No. _____ Purchase Date _____

ATTENTION: TO OUR VALUED CONSUMERS:

To insure that consumers obtain quality pre-sale and after-sale support and service, NILES products are sold exclusively through authorized dealers. This warranty is VOID if the products have been purchased from an unauthorized dealer.

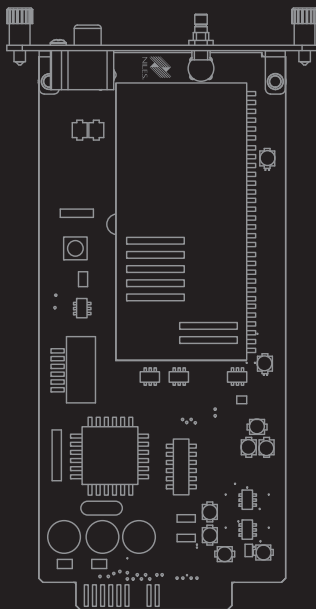

E N G I N E E R E D B Y



1 - 8 0 0 - B U Y - H I F I - www.nilesaudio.com

©2009 Niles Audio Corporation 12331 S.W. 130 Street, Miami, FL 33186. All rights reserved. Niles, the Niles logos, IntelliControl, IntelliFile, and iRemote are registered trademarks of Niles Audio Corporation. All other trademarks are the property of their respective owners. Niles reserves the right to change specifications, descriptions and prices without notice. The technical and other information contained herein is not intended to set forth all technical and other specifications. Designed and engineered in the USA. DS00437C

Download from www.Somanuals.com. All Manuals Search And Download.

Free Manuals Download Website

<http://myh66.com>

<http://usermanuals.us>

<http://www.somanuals.com>

<http://www.4manuals.cc>

<http://www.manual-lib.com>

<http://www.404manual.com>

<http://www.luxmanual.com>

<http://aubethermostatmanual.com>

Golf course search by state

<http://golfingnear.com>

Email search by domain

<http://emailbydomain.com>

Auto manuals search

<http://auto.somanuals.com>

TV manuals search

<http://tv.somanuals.com>