

ALTO HEADQUARTERS

ALTO U.S. Inc.
390 South Woods Mill Road
Suite 300
Chesterfield
USA-Missouri 63017-3433
Tel.: (+1) 31 42 05 12 20
Fax: (+1) 31 42 05 15 44

SUBSIDIARIES/DIVISIONS

AUSTRALIA

ALTO Overseas Inc.
1B/8 Resolution Drive
P.O.Box 797
AUS-Caringbah, N.S.W. 2229
Tel: (+61) 295 24 61 22
Fax: (+61) 295 24 52 56

AUSTRIA

Wap Reinigungssysteme GmbH
Metzgerstr. 68
A-5101 Bergheim/Salzburg
Phone: (+43) 662 45 64 00-14
Fax: (+43) 662 45 64 00-55
Mobil: (+43) 664 12 49 55 0

BRASIL

Wap do Brasil Ltda.
Rua 25 de Agosto, 608
Jardim Pinhais
CEP 83323-260 Pinhais/Paraná
BR-Brasil
Tel./Fax (+55) 41 86 74 02 6

CANADA

ALTO Canada
24 Constellation Road
Rexdale
C-Ontario M9W 1K1
Tel: 1 41 66 75 58 30
Fax: 1 41 66 75 69 89

CZECHIA

Wap čistící systémy s.r.o.
Zateckých 9
CZ-140 00 Praha 4
Tel. (+420) 02 / 42 78 38
Fax (+420) 02 / 42 19 25

Wap čistící systémy s.r.o.

Mucednicka 3
CZ-61600 Brno
Tel. (+420) 05 / 41 21 48 85
Fax (+420) 05 / 41 21 48 87

DENMARK

ALTO Danmark A/S
Industrivarteret
DK-9560 Hadsund
Tel: (+45) 72 18 21 00
Fax: (+45) 72 18 21 05

ALTO Danmark A/S

(food division)
Blytækervej 2,
DK-9000 Aalborg 10
Tel: (+45) 72 18 21 00
Fax: (+45) 72 18 20 99

FRANCE

ALTO France S.A.
B.P. 44, 4 Place d'Ostwald
F-67036 Strasbourg Cedex 2
Tel: (+33) 3 88 28 84 00
Fax: (+33) 3 88 30 05 00

GERMANY

Wap KundenCenter
Tel. (+49) 0180 / 5 37 37 37
Fax (+49) 0180 / 5 37 37 38
e-mail: center@wap-online.de
Besuchen Sie uns im Internet:
http://www.wap-online.com

Wap-Zentrale Bellenberg
Hauptverwaltung
Wap Reinigungssysteme GmbH & Co
D-89287 Bellenberg
Guido-Oberdorfer-Straße 2-8
Tel. (+49) 07306 / 72-0
Fax (+49) 07306 / 7 22 00

RegionalCenter Frankfurt
D-63452 Hanau
Moselstraße 2b
Tel. (+49) 06181 / 18 72-0
Fax (+49) 06181 / 18 72-11
e-mail: rcfm@wap-online.de

RegionalCenter Hannover
D-29227 Celle
Wernerstraße 25
Tel. (+49) 05141 / 95 55-0
Fax (+49) 05141 / 95 55-95
e-mail: rchann@wap-online.de

RegionalCenter Köln
D-51145 Köln-Porz
Kaiserstraße 127
Tel. (+49) 02203 / 9 22 99-0
Fax (+49) 02203 / 9 22 99-25
e-mail: rckoeln@wap-online.de

RegionalCenter Leipzig
D-04416 Markkleeberg
Wachau/Gewerbegebiet
Südring 16
Tel. (+49) 034297 / 4 87 25
Fax (+49) 034297 / 4 93 57
e-mail: rcleip@wap-online.de

RegionalCenter München
D-85716 Unterschleißheim
Furtweg 11
Tel. (+49) 089 / 32 15 02-0
Fax (+49) 089 / 32 15 02-40
e-mail: rcmuen@wap-online.de

RegionalCenter Stuttgart
D-71069 Sindelfingen
OT Darmsheim
Dornierstraße 7
Tel. (+49) 07031 / 76 70-0
Fax (+49) 07031 / 76 70-20
e-mail: rcstut@wap-online.de

RegionalCenter Ulm
D-89287 Bellenberg
Guido-Oberdorfer-Straße 2-8
Tel. (+49) 07306 / 72-195
Fax (+49) 07306 / 3 41 29
e-mail: rculm@wap-online.de

GREAT BRITAIN

ALTO Cleaning Systems(UK)Ltd.
Gilwilly Industrial Estate
GB-Penrith, Cumbria CA11 9BN
Tel: (+44) 1 7 68 86 89 95
Fax: (+44) 1 7 68 86 47 13
Telex: 64309 kewg

ASIA

Alto Hong Kong
Representative Office
RM 602, Tower B, Regent Ctr.
70, Ta Chuen Ping Street
Kwai chung
HK-Hong Kong
Tel. (+852) 26 10 10 42
Fax (+852) 26 10 10 47

JAPAN

ALTO Danmark A/S Japan
Representative Office
Naruse-build 4F
7-2 Shinbashi 1-Chome, Minato-Ku
J-Tokyo 105-004
Tel: (+81) 3 35 69 38 07
Fax: (+81) 3 35 69 38 08

Wap Representative Office Japan
25-6, Honode Cho
Adachi-Ku
J-Tokyo - 120-0021
Tel. (+81) 3 / 52 44 07 82
Fax (+81) 3 / 52 44 07 83

KROATIA

Wap sistemi za čišćenje, d.o.o.
HR-10000 Zagreb
Florijana Andrašeca 14
Tel. (+385) 01 / 3 09 49 07
(+385) 01 / 3 09 49 09
Fax (+385) 01 / 3 09 49 06

NETHERLANDS

WAP/ALTO Nederland B.V.
Stuartweg 4C,
NL-4131 NJ Vianen
Tel: (+31) (0) 3 47 32 40 00
Fax: (+31) (0) 3 47 32 40 01

Wap (NL) B.V.
NL-3371 MA Hardinxveld-
Giessendam
Transportweg 53-57
Postbus 65
Tel. (+31) 01846 / 1 81 44
Fax (+31) 01846 / 1 41 13
e-mail: wap.nl@wxs.nl

NORWAY

ALTO Norge AS
Bjørnerudveien 24
Postboks 64, Bjørndal,
N-1266 Oslo
Tel: (+47) 22 75 17 70
Fax: (+47) 22 75 17 71

SINGAPORE

ALTO Danmark A/S
Representative Office
271 Bukit Timah Road
#04-11 Balmoral Plaza
SG-Singapore 259708
Tel: (+65) 8 36 64 55
Fax: (+65) 8 36 64 56

SLOWAKIA

Wap čistiace systémy spol. s.r.o.
SK-83237 Bratislava
Vajnorská 135
Tel. (+421) 7 44 25 96 64
Fax (+421) 7 44 25 79 44

SLOWENIA

Wap čistilni sistemi, d.o.o.
SLO-1110 Ljubljana
Letališka 33
Tel. (+0368) 61 44 23 42
Fax (+0368) 61 1 40 42 94

SOUTH AFRICA

Wap South Africa (Pty) Ltd.
ZA-Kempton Park (T) 1620
P.O. Box 2122
Tel. (+27) 11 97 57 06 0
Fax (+27) 11 39 43 08 1

SPAIN

Hidrolimpia, S.L.
E-28760 Tres Cantos - Madrid
Ronda de Valdecarrizo 9
- Modulo 5 -
Tel. (+34) 091 / 804 62 56
Fax (+34) 091 / 804 64 63

SWEDEN

ALTO Sverige AB
Aminogatan 18, Box 40 29
S-431 04 Mölndal
Tel: (+46) 31 27 16 00
Fax: (+46) 31 87 24 19

SWITZERLAND

Wap Reinigungssysteme
(Schweiz) AG
CH-5042 Hirschthal / AG
Holzikerstraße 488
Tel. (+041) 062 / 7 39 32 50
Fax (+041) 062 / 7 39 32 51

Wap Reinigungssysteme
(Schweiz) AG
CH-1029 Villars-Ste-Croix
Zone industrielle
Croix du Péage
Tel. (+041) 021 / 6 35 32 74
Fax (+041) 021 / 6 35 32 75

USA

ALTO U.S.Inc
2100 Highway 265
Springdale
USA-Arkansas 72764
Tel: (+1) 50 17 50 10 00
Fax: (+1) 50 17 56 07 19

ALTO U.S.Inc
1100 Haskins Road
Bowling Green
USA-Ohio 43402
Tel: (+1) 41 93 52 75 11
Fax: (+1) 41 93 53 71 87

ALTO U.S.Inc
P.O.Box 4369
1500 North Belcher Road
Clearwater
USA-Florida 33765
Tel: (+1) 72 74 61 45 55
Fax: (+1) 72 74 61 51 93

718 90 18 b (99.08)

Printed in Germany
Copyright © 2000
ALTO/Wap Bellenberg

30CA COMPACT I



IMPORTANT: For your own safety and that of others, please make certain that everyone who uses the 30CA COMPACT I high pressure washer reads and understands these instructions thoroughly prior to operation.

 **Owner's manual**

Download from www.Sofmanuals.com. All Manuals Search And Download.



**Total Cleaning
Confidence™**

**KEW
TECHNOLOGY**

We congratulate you on your choice of the new ALTO 30CA!

We are convinced that this high pressure washer will meet your requirements. It's easy to operate and versatile.

It's important that you read this Owner's Manual thoroughly before you start up your ALTO pressure washer for the first time. Follow the instructions in this manual carefully, and you'll obtain full and lasting benefit from your high pressure washer.

Contents

1.0 Technical data	3
2.0 Instructions for use	3
Safety precautions and warnings	
2.1 Unpacking	4
2.2 Startup	4
2.3 Operation	5
2.4 Safety devices on the machine	5
3.0 Operating instructions	6
3.1 Connections	6
1. High pressure hose	6
2. Water connection	6
3. Power connection	6
4. Spray handle - accessories	7
5. Detergents - dosing unit	7
3.2 Starting procedure	7
3.3 Operation	8
3.4 Spray lance, regulating pressure	8
3.5 End of operation	8
3.6 Storing the lance, hose and power cord	9
3.7 Transport instructions	9
3.8 Storage - frost protection	9
4.0 Fields of application and working methods	10
4.1 Fields of application	10
4.2 Working pressure	10
4.3 Detergents	10
4.4 Operating suggestions	10
5.0 Self-priming	11
6.0 Maintenance	11
6.1 Clearing the high pressure nozzle	11
6.2 Cleaning inlet water screen	11
6.3 Cleaning the cabinet air vents	11
7.0 Trouble shooting and correction	12
8.0 Warranty	13

Description

(see illustrations inside back cover)

1. Start/stop knob
2. Pressure gauge
3. High pressure hose connection
4. High pressure hose
5. Inlet hose/quick-connect nipple
6. Inlet water connection (w/ inlet screen)
7. Power cord
8. Detergent metering adjustment
9. Detergent pickup hose storage
10. Carrying handle
11. Transport handle w/hose & cord storage
12. Wheel
13. Spray lance storage
14. Footpad
15. I.D. plate
16. Transport handle release
17. Motor air vents
18. Detergent container support
19. Spray handle
20. Spray lance

ALTO's environmental policy

A concern for the environment is a natural part of our philosophy at ALTO. In every area of the company we work diligently to reduce or eliminate harmful effects on our environment. This concern is also reflected in the design of individual ALTO high pressure washers, including the 30CA.

Years from now, when it's time to retire this machine, you'll find that nearly every plastic component is recyclable and marked with the appropriate material recycling symbol.

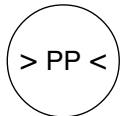

Have a good time with your new ALTO pressure washer!

Sincerely,
The employees and management,
ALTO Danmark A/S

1.0 Technical data

Type/Model	P478/	30CA Compact I (240V)	30CA Compact I (115V)
Pump pressure	Psi	2175	1230
Water volume, at min-max pressure	Gpm	2.4 / 2.3	19.5/1.8
Self-priming lift	Ft	3	3
Motor	Hp	3.0	1.6
Double Spray Lance:			
Spray angle h.p./l.p.	degrees	15/65	15/65
Nozzle size		03	03
Sound level (ISO 3746)	dB(A)	83	83

Specifications at 45 psi inlet pressure and 54°F inlet water.

Specifications subject to change without notice.

2.0 Instructions for use Safety precautions and warnings

Before starting your high pressure washer, read through sections:

2.0 Instructions for use, and **3.0 Operating instructions**.

Follow the instructions carefully to ensure the protection of the user, the surroundings and the machine.

- WARNING -
Risk of Injection or Injury -
Do Not Direct Discharge Stream At Persons.

The high water pressure from a high pressure washer may cause personal injury or property damage if the following „IMPORTANT SAFETY INSTRUCTIONS“ are not strictly observed.

IMPORTANT SAFETY INSTRUCTIONS

- WARNING -

When using this product, basic precautions should always be followed, including the following:

1. Read all of the instructions before using the product.
2. To reduce the risk of injury, close supervision is necessary when the pressure washer is used near children.
3. Know how to stop the product. Be thoroughly familiar with all controls.
4. Stay alert - watch what you are doing.
5. Do not operate the product when fatigued or under the influence of alcohol or drugs.
6. Keep the operating area clear of all persons.
7. Do not over-reach or stand on unstable support. Keep good footing and balance at all times.
8. Follow the maintenance instructions specified in the manual.
9. Read this manual carefully - know your equipment. Consider the applications, limitations, and the potential hazards specific to this unit.
10. Do not touch the cord, plug or outlet with wet hands.
11. Avoid accidental starts. Always connect to electric outlets with the motor „off“.
12. Water stream must never be directed towards any electric wiring or fatal electric shock may occur.
13. Never direct water stream towards people or pets.
14. Never carry your pressure washer by the power cord, or yank on the cord to disconnect from outlet.
15. To prevent damage, the power cord should not be crushed, placed next to sharp edges nor near hot objects.



Safety precautions and warnings

16. Check all electric cords prior to use. Damaged cords should not be used.
17. Never let children operate your pressure washer.
18. Hold the spray lance with both hands to maintain complete control.
19. Don't touch the nozzle while spraying, or the water stream at any time.
20. Wear eye protection while operating. The operator and others in the vicinity of the cleaning site should take action to protect themselves from being struck by dislodged debris during cleaning operations.
21. Disconnect power plug from the outlet when not in use and prior to detaching the nozzle/spray lance.
22. Only ALTO spare parts, ALTO accessories and ALTO nozzles should be used.
23. Never start the machine if ice has formed in any part of the equipment. Thaw out any ice before starting.
24. The machine is designed to use „consumer“ strength detergents, degreasers and waxes. The use of „Industrial“ solutions may affect its operation and safety. Carefully observe all detergent instructions before using.
25. Never use the pressure washer in environments where risk of explosion is present (ie. gas vapors).
26. All electrical connections should be kept dry and off the ground.
27. Do not use the machine to clean surfaces containing asbestos.
28. If it is necessary to replace the power cord, it must be done by a ALTO service technician.
29. Faulty electrical connection of the pressure washer can cause fatalities. Never modify or alter the plug on the power cord of your pressure washer. If it doesn't fit the outlet and adjustments are required, call a qualified electrician.
30. Some models are provided with a Ground Fault Circuit Interrupter (GFCI) built into the power cord plug. If replacement of the plug or cord is needed, use only identical replacement parts.
31. Don't use the machine if the power cord or other important parts of the equipment are damaged - i.e. safety devices, high pressure hoses, spray handles, cabinet.
32. The most efficient cleaning is obtained if you adjust the distance to the surface which is to be cleaned. Thus you will also avoid damaging the surface.



SAVE THESE INSTRUCTIONS

2.1 Unpacking

Once the pressure washer has been taken out of the packaging, check that it is complete and without any defects; if in doubt, the pressure washer should not be put into use and you should contact the nearest ALTO service organization.

2.2 Startup

- Check power cord

Power cord insulation must be perfect. (No cracks, cuts or other defect).

Contact a qualified electrician or a ALTO distributor if there is any doubt.

- Check voltage

Connect the pressure washer to a grounded outlet of the correct voltage (see Data Plate).

- Fuse/Breaker

Be certain that your electrical outlet is adequately fused for the machine's requirements (see Data Plate).

- Reset the Ground Fault Circuit Interrupter (GFCI) (if equipped)

AFTER the power cord is plugged in, press the RESET button on the GFCI.

If it will not reset, contact a ALTO service center for assistance.

- WARNING -

If these instructions aren't followed, it may be dangerous to use your pressure washer.

Safety precautions and warnings



GROUNDING INSTRUCTIONS



This product must be grounded. If it should malfunction or break down, grounding provides a path of least resistance for electrical current to reduce the risk of electric shock. This product is equipped with a cord having an equipment-grounding conductor and a grounding plug. The plug must be plugged into an appropriate outlet that is properly installed and grounded in accordance with all local codes and ordinances.

DANGER - - Improper connection of the equipment-grounding conductor can result in a risk of electrocution. Check with a qualified electrician or service personnel if you are in doubt as to whether the outlet is properly grounded. Do not modify the plug provided with the product - - if it will not fit the outlet, have a proper outlet installed by a qualified electrician. Do not use any type of adapter with this product.

Ground Fault Circuit Interrupter Protection



This pressure washer may be equipped with a Ground Fault Circuit Interrupter (GFCI) on the power cord. This device provides additional protection from the risk of electrical shock. Should replacement of the plug or cord become necessary, use only identical replacement parts that include GFCI protection.



EXTENSION CORDS



Use only 3-wire extension cords that have 3-prong, grounding type plugs and 3-pole cord connectors that accept the plug from the product. Use only extension cords that are intended for outdoor use. These extension cords are identified by a marking „Acceptable for use with outdoor appliances; store indoors while not in use“. Use only extension cords having an electrical rating (volts AND amps) not less than the rating of the product. Examine extension cord before using, and replace if damaged. Do not abuse the extension cord and do not yank on any cord to disconnect. Keep cord away from heat and sharp edges. Always disconnect the extension cord from the receptacle before disconnecting the product from the extension cord.



WARNING - - To reduce the risk of electrocution, keep all connections dry and off the ground. Do not touch the plug with wet hands.

2.3 Operation

(also see Sec. 3.0, Operating instructions)

High or low pressure (Sec. 4.2)

Generally speaking, high pressure loosens soil, and low pressure moves it.

Attack the „dirtiest“ areas first, with high pressure. Then complete the task with a combination of high and low pressure as appropriate.

Technique (also see Sec. 4.4)

Generally, it's best not to allow areas still being cleaned to dry before you've finished. This is especially true if you're using detergent. To remove something like chewing gum, use high pressure and „undercut“ it. To gain „reach“ (ie. for the eaves of the house), use high pressure. Experimentation will produce the ideal setting for your cleaning task.

2.4 Safety devices on the machine

Bypass/Overpressure relief

The high pressure side of the pump is equipped with a combination bypass and safety valve. This valve recirculates water back to the low pressure side of the pump when the spray handle is closed or the nozzle is blocked. The bypass/safety valve also ensures that the pump pressure will never exceed the working pressure by more than 300 psi (well within the design strength of the pump). At this pressure, the pump automatically switches from high pressure to bypass mode. The bypass/safety valve also relieves pump pressure when the machine is stopped.

Motor overload protection

The electric motor features overload protection. If an overload occurs (caused by excessive pressure, improper extension cord, or defect), the motor will stop.

3.0 Operating instructions

3.1 Connections

1. High pressure hose

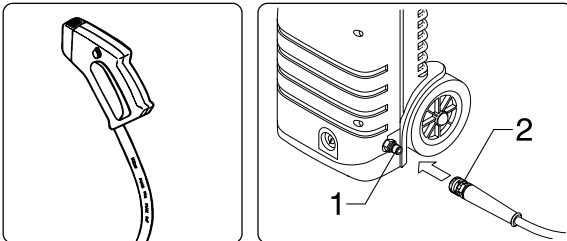

Max. length of extension hose: 33 ft
Only use ALTO high pressure hose

The high pressure hose marked with max. working pressure and temperature should be attached to the outlet nipple (1) using the quick coupler (2).

2. Water connection

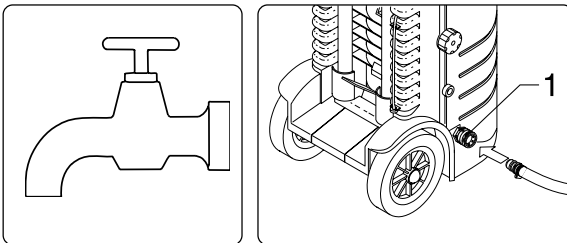

IMPORTANT! Water must not contain dirt, sand or other impurities. Using dirty water may void your warranty coverage!

Minimum size and length of the inlet hose: ½" diam. / 20 ft.

Maximum water supply pressure: 145 Psi
Minimum water flow from the tap: 3 gpm
Clean the inlet water screen monthly (or more frequently if required).

Run water through your garden hose before connecting, to flush it. Mount the MALE quick-connect nipple on the garden hose and snap it into the quick-coupler on the machine.

Note: Connection to municipal water supplies may require mounting a back-flow preventer. If in doubt, check local codes.

3. Power connection

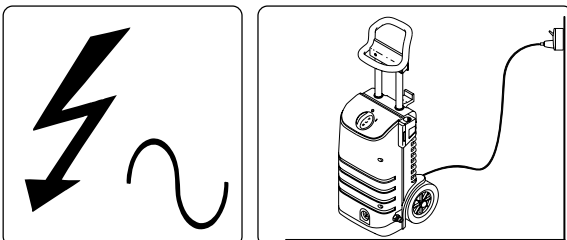

This product must be grounded.

Be certain that the voltage, fuse or breaker, power and/or extension cords are as specified in Sec. 2.2.

WARNING - - To reduce the risk of electrocution, keep all connections dry and off the ground. Do not touch the plug with wet hands.

4. Spray handle - accessories

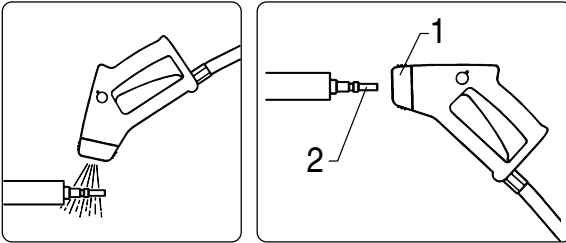

Rinse the nipple before attaching the spray lance.

Pull the gray part of the spray handle (1) forward.

Insert the nipple (2) of the spray lance or accessory in the quick coupling and release #1.

Tug on the spray lance or accessory to ensure it's tight before starting the machine.

5. Detergent metering unit

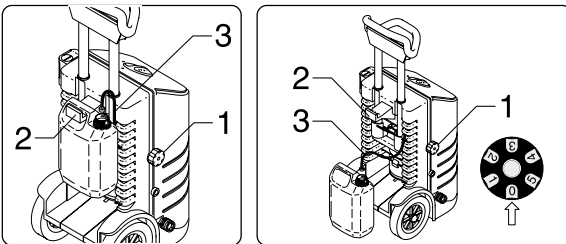

Only use suitable detergents.

Use of aggressive detergents may damage the equipment and affect the environment.

Flush with water after use.

IMPORTANT: Always set the injector to „0“ when not using detergents.

Detergents are added under low pressure through the built-in metering unit (1). The pickup hose and screen (3) of the metering unit is stored near the container support (2). Some containers can be hung on the support by the handle. Insert the pickup hose with filter into the bottle or the container. Metering is infinitely adjustable from 0-5%. Select the required concentration by turning the knob (3) counter-clockwise, until the desired setting is aligned with the arrow. When finished with the detergent system, flush it with water (in place of detergent), at setting '5' for approximately 1 minute. Return the knob to position 0.

3.2 Starting procedure

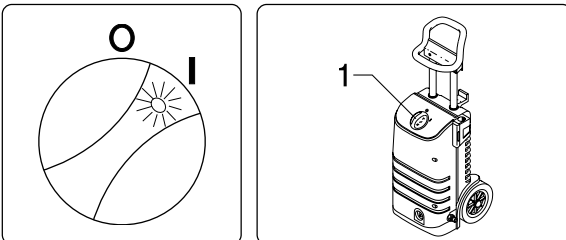

Turn on the water.

Vent the machine.

Turn the start/stop knob (1) to position I.

Turn on the water supply and squeeze the trigger on the spray handle with the spray lance set at low pressure (or without a spray lance attached). Let the water run until all air has escaped from the supply hose, pump, and high pressure hose (a hissing sound will be heard until the air is gone).

During start-up, pump pressure may be irregular if air is left in the system. After a short time in operation the air will escape from the system, and the pressure will normalize.

3.3 Operation

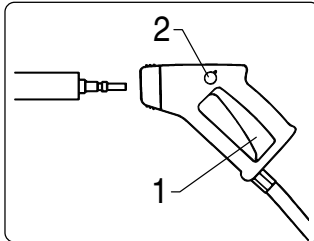
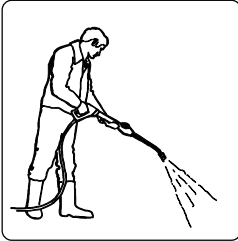

Always hold the spray lance with both hands!
Always lock the spray handle when the machine isn't being used.

Release the safety lock (2) on the spray handle by turning to position I, and squeeze the trigger (1) to wash. When the trigger is released with the start/stop switch in the 1 position, the machine will stop automatically. It will re-start when the trigger is pulled, again. When the machine is not being used, lock the spray handle trigger by turning the safety lock (2) into pos. O.

3.4 Spray lance; regulating pressure

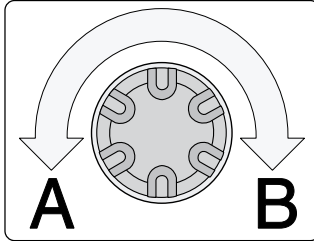
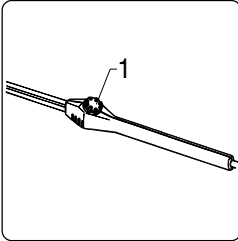

Turn pressure adjustment knob
Clockwise (B) for high pressure or
Counter-clockwise (A) for low pressure
(or apply detergents).

The spray lance incorporates two nozzles for high and low pressure operation. In the High Pressure mode, the adjustment knob (1) is closed (B) and only the high pressure nozzle is used. As the adjustment knob is opened (A) the machine enters the Low Pressure mode, and both nozzles are used. Pressure may be regulated between these positions.

3.5 End of operation

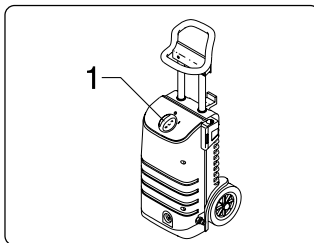
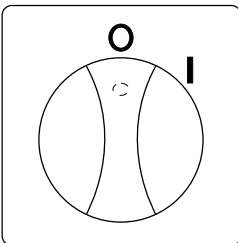

Turn the start/stop knob (1) to position O

Stop the machine by turning the start/stop knob (1) to position O.
Unplug the machine.
Turn off the water supply and squeeze the spray handle trigger.
Disconnect the high pressure hose and the water supply hose.

3.6 Storing the lance, hose and power cord

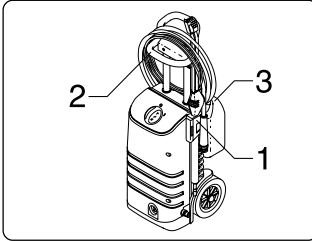
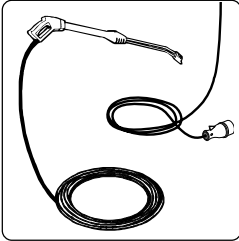

Power cord and high pressure hose can be stored on the transport handle (2)

Store the lance in the lance holder (1)

Detergent container storage (3).

The power cord should be coiled and stored on the handle (2). The high pressure hose should be coiled and can be hung in the same place, on top of the cord. The lance should be stored in the lance holder (1).

3.7 Transport instructions

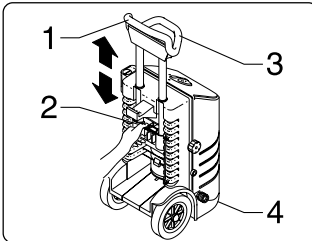
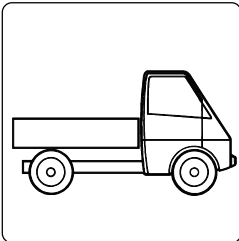

Lifting points: Lifting handle (3) and under the cabinet, at the front (4).

The machine has a transport handle (1/3) and wheels so that it is easy to transport.

The transport handle can be raised or lowered as required. To raise or lower the handle, release the lock (2), position the handle, and secure the lock (2). Never lift the machine by the transport handle (1/3) alone! Use the lifting handle (1/3) and the bottom of the cabinet (4).

3.8 Storage - frost protection

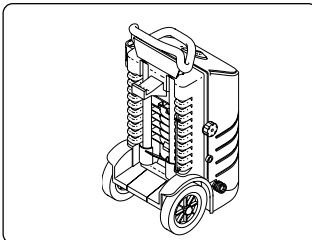
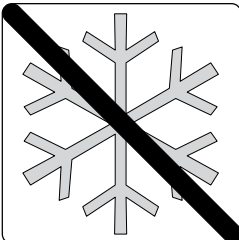

NOTE: The machine should be stored in a frost-free area!

In order to prevent freezing damage to the machine, hoses and spray lance, they should always be emptied prior to storing, as follows:

1. Stop the machine, shut off the water supply and detach inlet hose and spray lance or accessory.
2. Restart the machine and squeeze the trigger.
Let the machine run until no more water comes through the spray handle.
3. Turn the machine off, detach the high pressure hose and squeeze the trigger until no more water runs out of the high pressure hose.

FROST PROTECTION. If a frost-free storage area is not available, the machine must be protected by allowing it to suck in a 50% anti-freeze solution. Hoses and accessories should be emptied of water.

4.0 Using your 30CA

Applications and some suggestions

4.1 Typical applications

Among the most common applications for the ALTO 30CA are:

Agriculture	Cleaning and/or sanitizing machinery, implements and livestock areas
Transportation	Cleaning trucks, buses, cars, shop areas and equipment spaces
Light industries	Cleaning/degreasing equipment and shop areas.
Services	Building and kitchen cleaning. Walks, drives and awnings.
Domestic use	Autos, motorcycles, campers, boats, trailers, concrete/brick/stone, woodwork, roof/gutters, windows, greenhouses, barbecues, garden furniture, and many others.

4.2 Working pressure

Your ALTO 30CA can be adjusted for virtually any pressure up to its rated working pressure, with a simple twist of the knob atop the spray lance.

Low pressure	Provides lower pressures and/or activates the internal detergent injector. Useful in tight spaces or around sensitive equipment.
High pressure	Provides maximum mechanical cleaning action resulting from water jet impact. Loosens soil and assists detergent action. Stops detergent injection.
In-between	Allows matching the output to specific task requirements.

4.3 Detergents

A vast number of detergents and other chemicals (such as degreasers and disinfectants) are available for use with pressure washers. Selection will depend primarily upon the task at hand, though environmental considerations must enter into a responsible decision, as well.

Your ALTO Distributor or a local chemical company will be able to provide you with guidance.

It is important to follow the chemical manufacturer's instructions regarding use of their chemical! Use only as strong a solution as is necessary to accomplish the job. Using more than is necessary is costly. A rule of thumb is that, »If it looks like you're getting enough soap, you're using too much«»

4.4 Operating suggestions

In cleaning operations using detergents or other solutions, it is generally best to use the following method:

- Step 1 Low pressure application of solution to a dry surface
- Step 2 Wait while the solution works (an important step)
- Step 3 High pressure agitation, and rinse

Some general advice:

- 1) Cleaning solutions generally work best when applied to dry surfaces. Make sure solution is being sprayed before pointing the machine at the surface being cleaned.
- 2) Do not allow the solution to "dry back"
- 3) When working on vertical surfaces, apply solution from the bottom up to help prevent streaking which can result from high concentrations of solution running down a narrow, dry path to the ground.
- 4) Manipulate the spray lance so that water from the high pressure cleaning operation does not „rinse“ areas still uncleared, prematurely. Wash from the bottom up.

5.0 Self-priming

The ALTO Professional Series high pressure washers are self-priming from as much as 3 feet above a water supply source which is not pressurized (such as a tank). Water temperatures above 50°F. will limit lift).

NOTE: Self-priming accelerates wear and tear on the pump and should only be used if necessary. It is important to provide adequate filtration when operating from alternative water supplies such as streams, tanks, etc. Your Distributor can assist you in providing this protection.

6.0 Maintenance

This ALTO high pressure washer is Maintenance-Free! You can, however, contribute to the machine's reliability and help prevent problems by following this advice:

The water supply hose should be flushed before connecting it to the machine.

Before attaching the spray lance or any other accessory on the spray handle, the machine should be started and the coupling rinsed.

When detergents will not be used for an extended period, flush the detergent injection system by „injecting“ clean water to prevent clogging of injection system.

The water inlet screen should be cleaned once a month, or more frequently according to use.

The machine should be stored in a frost-free area. If the machine freezes, it must not be started in that condition. Let the machine, hoses and accessories thaw out before starting.
NEVER START A FROZEN MACHINE!

6.1 Clearing the high pressure nozzle

An obstructed nozzle causes excessive pump pressure and/or pulsation, Should this occur, clearing is required immediately.

1. Stop the machine and disconnect the spray lance.
 2. Using a thin wire or paper clip, clear the nozzle.
- IMPORTANT:** This must only be done with the spray lance detached!
3. Backflush the spray lance with water.
 4. If the pressure remains too high, repeat items 1-3.

6.2 Cleaning inlet water screen

Clean the inlet water screen (1) regularly (once a month or more frequently depending on water quality).

Remove the inlet quick-connector. Carefully remove the retaining ring (2) with a screwdriver and remove the screen. Clean the screen thoroughly and reinstall in the reverse order before using the machine again.

6.3 Cleaning the cabinet air vents

The machine should be kept clean so cooling air can pass freely through the cabinet air vents (3). Do not spray water through these vents!

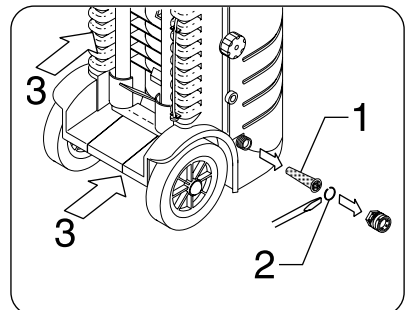

7.0 Troubleshooting and correction

You have chosen the best quality and therefore deserve the best service. To avoid unnecessary disappointments, you should check the following before contacting the nearest ALTO service organisation.

Fault	Possible Cause	Remedies
Motor won't start	Plug not connected GFCI not set (if equipped) Defective outlet Fuse/breaker blown	Connect plug. Reset GFCI. Try another outlet. Change or reset the fuse/breaker. Switch off any other devices. Try without extension cord.
Motor stops	Defective extension cord Fuse/breaker blown Overload release activated.	Remove cord, reset breaker and try again. Switch off any other devices. Check that the voltage is correct. Turn start/stop knob off and on, again.
Fuse blows repeatedly	Wrong voltage and/or breaker Overload release activated	Change to a circuit with correct ampere and voltage ratings. Check supply voltage and cord(s).
Pump pressure fluctuating (in suction mode)	Air in the water hose and/or pump Inadequate water supply machine. Avoid long, thin hoses Inlet water screen clogged Hoses kinked High pressure hoses too long Suction height too high, water too hot, or air leak in supply hose	Allow the machine to run with open spray lance adjusted to low pressure until the flow is steady. Check that the water supply is adequate for the (min. i.d. ½"). Clean the screen (see sec. 6.2) Straighten the hoses. Detach high pressure extension hoses and retry (extension hoses max. 33 ft). Read section 5.0. Use cooler water, reduce suction distance and check for poor hose connections.
Pressure low but steady Note: Some accessories normally operate at a lower pressure	High pressure nozzle worn Dirt in by-pass valve	Replace the nozzle. Activate and release the spray handle 5 times, quickly.
Motor runs but no working pressure	Pump/hoses or accessories frozen No water supply Inlet water screen clogged Nozzle clogged	Let pump/hoses or accessories thaw. Connect or turn on the water. Clean the screen (see Sec. 6.2) Clear the nozzle (see Sec. 6.1)
*) Overload release activated	Wrong voltage Extension cord too long Nozzle partly obstructed	See section 2.2 Remove the cord or use larger cord. Clear the nozzle (see Sec. 6.1)
Wait until the motor has cooled. (The machine can be restarted by turning the start/stop knob to 0 and back to I).		

Should you experience malfunctions other than those mentioned above, please contact ALTO Service for assistance.

See the Warranty Registration Card for a description of the warranty.

Free Manuals Download Website

<http://myh66.com>

<http://usermanuals.us>

<http://www.somanuals.com>

<http://www.4manuals.cc>

<http://www.manual-lib.com>

<http://www.404manual.com>

<http://www.luxmanual.com>

<http://aubethermostatmanual.com>

Golf course search by state

<http://golfingnear.com>

Email search by domain

<http://emailbydomain.com>

Auto manuals search

<http://auto.somanuals.com>

TV manuals search

<http://tv.somanuals.com>