



ATTIX 360-2M
ATTIX 550-2M
ATTIX 560-2MXC
ATTIX 751-2M
ATTIX 761-2MXC



Nilfisk
ALTO
Why Compromise

english	Operating Instructions.....	1-15
deutsch	Betriebsanleitung.....	16-30
français	Notice d'utilisation.....	31-45
nederlands	Gebruiksaanwijzing.....	46-60
italiano	Istruzioni sull'uso.....	61-75
norsk	Driftsinstruks.....	76-90
svensk	Bruksanvisning.....	91-105
dansk	Driftsvejledning.....	106-120
suomi	Käyttöohje.....	121-135
slovensčí	Navodilo za uporabo.....	136-150
hrvatski	Uputstvo za rad.....	151-165
slovenský	Prevádzkový návod.....	166-180
český	Provozní návod.....	181-195
polski	Instrukcja obsługi.....	196-210
magyar	Kezelési utasítás.....	211-225
русский	Руководство по эксплуатации.....	226-240
español	Instrucciones de manejo.....	241-255
português	Instruções de operação.....	256-270
ελληνικά	Οδηγίες λειτουργίας.....	271-285
türkçe	İşletme kılavuzu.....	286-300

ATTIX 3

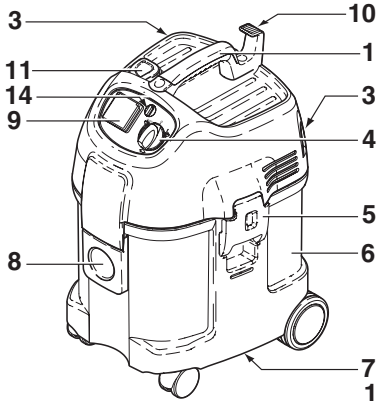

ATTIX 5

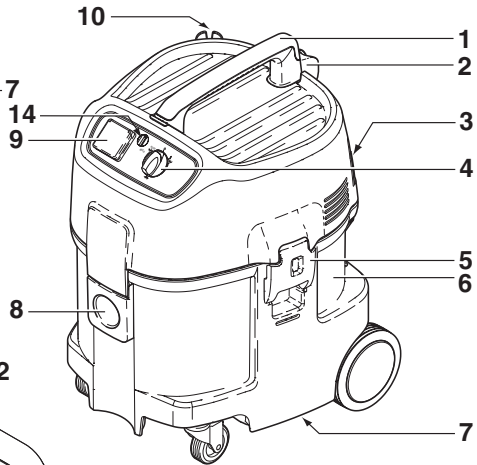

ATTIX 7

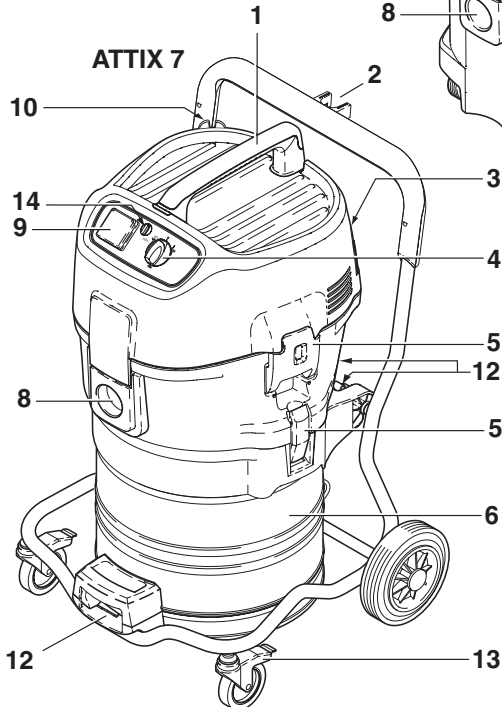

Contents

1 Important safety instructions	2
2 Description	2.1 Purpose.....	4
	2.2 Operating elements	5
3 Before start-up	3.1 Assembling the cleaner	5
4 Operation	4.1 Connections	5
	4.1.1 Connecting the suction hose	5
	4.1.2 Electrical connection	5
	4.1.3 Connecting electrical appliances.....	6
	4.2 Switching on the vacuum cleaner.....	6
	4.2.1 Switch position "I"	6
	4.2.2 Switch position „auto“	6
	4.2.3 Suction power control	6
	4.3 Check volume flow monitor	6
	4.4 Acoustic warning	7
	4.5 Cleaning the filter element (ATTIX 360-2M)	7
	4.6 Cleaning the filter element (ATTIX 560-2MXC/761-2MXC) ..	7
5 Applications and techniques	5.1 Techniques	8
	5.1.1 Picking up dry substances	8
	5.1.2 Picking up liquids.....	9
6 After finishing work	6.1 Switching the vacuum cleaner off and storage.....	9
7 Maintenance	7.1 Maintenance plan	10
	7.2 Maintenance work	10
	7.2.1 Replacing the waste bag	10
	7.2.2 Replacing the filter bag.....	11
	7.2.3 Emptying dirt tank (ATTIX 3+5)	11
	7.2.4 Emptying the dirt tank (ATTIX 7).....	11
	7.2.5 Replacing filter element (ATTIX 360-2M/550-2M/751-2M) ..	12
	7.2.6 Replacing filter element (ATTIX 560-2MXC/761-2MXC)	12
8 Troubleshooting	13
9 Further information	9.1 Recycling the vacuum cleaner	14
	9.2 Guarantee	14
	9.3 Tests and approvals	14
	9.4 Technical data	15
	9.5 Accessories	15
	9.6 EC declaration of conformity	15

¹⁾ Option depending on model

1 Important safety instructions

Symbols used to mark instructions



ily available.

Before using the vacuum cleaner, always read the operating instructions and keep them read-



to the vacuum cleaner and its performance.

This symbol is used to mark safety instructions that must be observed to prevent damage



prevent damage to persons.

This symbol is used to mark safety instructions that must be observed to



simplify work and to ensure safe operation.

This symbol indicates tips and instructions to

For your own safety

Only allow the vacuum cleaner to be used by persons who have been trained in its use and who have been explicitly authorized to use it.

Despite its simple handling the vacuum cleaner is not suitable for children.

The use of the vacuum cleaner is subject to valid national regulations. Besides the operating instructions and the binding accident prevention regulations valid in the country of use, observe recognized regulations for safety and proper use.

Do not use any unsafe work techniques.

Transport

Before transporting the dirt tank, close all the locks.

Do not tilt the cleaner if there is liquid in the dirt tank.

Do use a crane hook to lift the cleaner.

Purpose and intended use

The vacuum cleaners described in this operating manual are suitable for

- commercial use, e.g. in hotels, schools, hospitals, factories, shops, offices and rental businesses.
- for separation of dust with an exposure limit of greater than $0,1 \text{ mg/m}^3$, (dust class M).

The following materials should not be picked up by the vacuum cleaner:

- hot materials (burning cigarettes, hot ash, etc.)
- flammable, explosive, aggressive liquids (e.g. petrol,

solvents, acids, alkalis, etc.)
– flammable, explosive dust (e.g. magnesium or aluminium dust, etc.)

When dust removers are used, the rate at which air is exchanged in the room must be adequate if the exhaust air from the vacuum cleaner is blown into the room (please observe regulations valid in your country).

Before starting work, the operating staff must be informed on

- use of the vacuum cleaner
- risks associated with the material to be picked up
- safe disposal of the picked up material.

Precautions and safety regulations when using the vacuum cleaner

Before start-up

Inspect power cord regularly to detect signs of damage, e.g. cracks or ageing.

If the power cord is damaged, it must be replaced by Nilfisk-Alto-Service or an electrician to avoid danger before use of the vacuum cleaner is continued.

Use only the type of power cord specified in the operating manual.

Do not damage the power cord (e.g. by moving over it or pulling or crushing it).

Disconnect the power cord by pulling the plug only (do not pull or tug the power cord).

Inspect the vacuum cleaners to ensure that they are in proper condition. Plugs and couplings in power cords must at least have splash protection.

Never use the vacuum cleaner if the filter element is damaged.

Picking up liquids

If foam develops or liquid emerges, stop work immediately and empty the dirt tank.

Regularly clean the built in float (ATTIX 360-2M/550-2M/751-2M) and level indicator hose (ATTIX 560-2MXC/761-2MXC) to limit the water level and check that they are not damaged.

See section 5 for information on handling liquids and (hazardous) dust.

Electrical components

Check the rated voltage of the vacuum cleaner before connecting it to the mains supply system. Ensure that the voltage shown on the rating plate corresponds to the voltage of the local mains power supply.

If you are using an extension cord, use only those specified by the manufacturer or higher quality ones (see section 9.4 „Technical data“).

It is recommended that the vacuum cleaner should be connected via a residual current circuit breaker. This stops the supply of electricity if the leakage current to earth exceeds 30 mA for 30 ms or it has an earth tester circuit.

When using an extension lead, check the minimum cross-sections of the cable:

Cable length m	Cross section	
	<16 A	<25 A
up to 20 m	ø1.5mm ²	ø2.5mm ²
20 to 50 m	ø2.5mm ²	ø4.0mm ²

Arrange the electrical parts (sockets, plugs and couplings) and lay down the extension lead so that the protection class is maintained.

Never spray water on to the upper section of the vacuum cleaner. Danger for persons, risk or short-circuiting.

Observe the latest edition of the IEC regulations.

¹⁾ Option depending on model

Tool socket

Use the socket on the vacuum cleaner for the purpose defined in the operating instructions only.

Before plugging an appliance into the appliance socket:

1. Switch off the vacuum cleaner

2. Switch off the appliance to be connected.

CAUTION!

Follow the operating instructions and safety instructions for appliances connected to the power tool socket.

Maintenance, cleaning and repair

Only carry out maintenance work described in the operating instructions.

Always pull out the mains plug before cleaning and maintenance of the vacuum cleaner.

During maintenance and cleaning, handle the vacuum cleaner in such a manner that there is no danger for maintenance staff or other persons.

In the maintenance area

- use filtered compulsory ventilation
- wear protective clothing
- clean the maintenance area so that no harmful substances get into the surroundings.

Before removing the vacuum cleaner from the area contaminated with harmful substances:

- clean the outside of the vacuum cleaner, wipe it clean or pack the vacuum cleaner in well sealed packaging
- and avoid spreading deposited harmful dust.

During maintenance and repair work all contaminated parts that could not be cleaned satisfactorily must be:

- packed in well sealed bags
- disposed of in a manner that complies with valid regulations for such waste removal.

A dust test must be performed at least once every year by Nilfisk-Alto service or a trained person. This test includes, for example, whether there is damage to the filter, the vacuum cleaner is sealed to the air and the control equipment works properly.

Accessories and spare parts

Use only the brushes supplied with the vacuum cleaner or specified in the operating manual. The use of other brushes can

adversely affect safety.

Use only original Nilfisk-Alto accessories and spare parts (see section 9.5). The use of other parts can adversely affect safety.

2 Description

2.1 Purpose

This cleaner is suitable to pick up dry, nonflammable dust, liquids, sawdust and hazardous dusts with maximum room concentration values $\geq 0.1 \text{ mg/m}^3$ (dust class M).

Depending on how hazardous the dust is, the cleaner must be fitted with appropriate filters. See table in section 5.1.1.

2.2 Operating elements

See fold-out page at the front of these operating instructions.

- | | |
|--|---|
| <ol style="list-style-type: none"> 1 Handle 2 Suction pipe support 3 Accessory holder 4 Appliance switch with suction power control 5 Retaining clamp | <ol style="list-style-type: none"> 6 Dirt tank 7 Grip to empty tank¹⁾ 8 Inlet fitting 9 Appliance socket¹⁾ 10 Cable hook 11 Operating knob for filter cleaning¹⁾ 12 Tank locks¹⁾ 13 Castor with brake 14 Hose diameter setting |
|--|---|

3 Before start-up

3.1 Assembling the cleaner



On delivery some of the accessories are lying in the tank and must be removed before the vacuum cleaner is used for the first time. Remove the upper section of the vacuum cleaner; The mains plug should not be inserted into a socket.

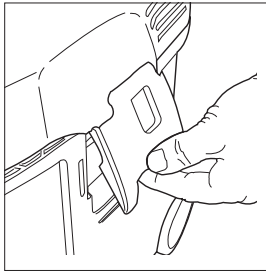

1. Open the retaining clamps and lift off the upper section of the cleaner.
2. Take the accessories out of the dirt tank and the packaging.

3. To pick up dust with maximum room concentration values:

Insert the filter bag into the dirt tank according to the instructions (instructions included).

To pick up harmless dust: Insert the disposal bag (instructions included) into the tank.

IMPORTANT: Press the filter bag connection firmly on to the inlet fitting.

4. Fit the upper section of the vacuum cleaner and close the retaining clamps.

NOTE: Ensure that the retaining clamps fit properly.

4 Operation

4.1 Connections

4.1.1 Connecting the suction hose



The suction hose diameter must suit the position of the switch in order to pick up dry, nonflammable dust with maximum room concentration values.

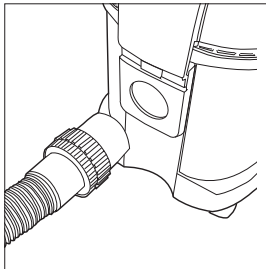

1. Connect the suction hose.

4.1.2 Electrical connection

The operating voltage shown on the rating plate must correspond to the voltage of the mains power supply.

1. **Ensure that the vacuum cleaner is switched off.**
2. Insert the power cord into a properly installed and fused socket with an earthing contact.

¹⁾ Option depending on model

4.1.3 Connecting electrical appliances

To comply with regulations, only approved dust producing tools should be connected.

The maximum power consumption of the connected power tool is stated in section 9.4 "Technical data".

1. Ensure that the electrical appliance is switched off.
2. Connect the electrical appliance to the appliance socket on the control panel.

4.2 Switching on the vacuum cleaner

4.2.1 Switch position "I"

The hose diameter and the setting for the suction hose diameter must be the same.

Hose \varnothing	Hose diameter setting
$\varnothing 27$	$\varnothing 27$
$\varnothing 32$	$\varnothing 32$
$\varnothing 36$	$\varnothing 36$
$\varnothing 50$	$\varnothing 50$

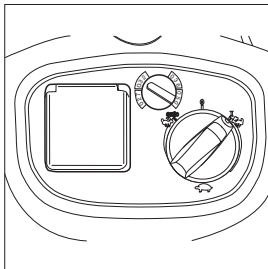

1. Turn the switch to position "I".
The vacuum cleaner motor starts.

4.2.2 Switch position „auto“

The hose diameter and the setting for the suction hose diameter must be the same.

Hose \varnothing	Hose diameter setting
$\varnothing 27$	$\varnothing 27$
$\varnothing 32$	$\varnothing 32$
$\varnothing 36$	$\varnothing 36$
$\varnothing 50$	$\varnothing 50$

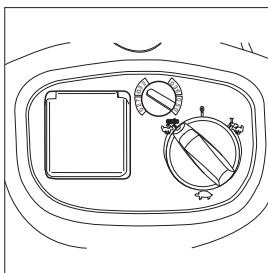

Before switching the switch to position „auto“, ensure that the tool connected to the appliance socket is switched off.

1. Turn the switch to position „auto“. The vacuum cleaner motor starts when the connected appliance is switched on.
2. When the power tool is switched off the vacuum cleaner continues to run for a short moment so that any dust in the suction hose is conveyed to the safety filter bag.

4.2.3 Suction power control

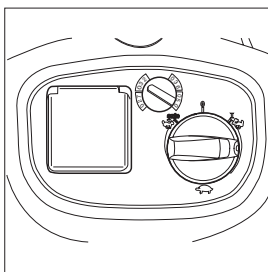

The motor speed and the suction power can be varied with the suction power control. This allows precise adaptation of the suction power for different cleaning tasks.

4.3 Check volume flow monitor

Before picking up dust with maximum room concentration values:

1. Check that all the filters are present and properly fitted.
2. When the motor is running, hold the suction hose shut. An acoustic warning sounds after approx. 1 second.

4.4 Acoustic warning

For safety reasons, an acoustic warning sounds if the air speed in the suction hose drops to below 20 m/s. See section "Troubleshooting".

4.5 Cleaning the filter element (ATTIX 360-2M)



If the acoustic signal sounds again after repeated cleaning, replace the filter element (see section 7.2.5).

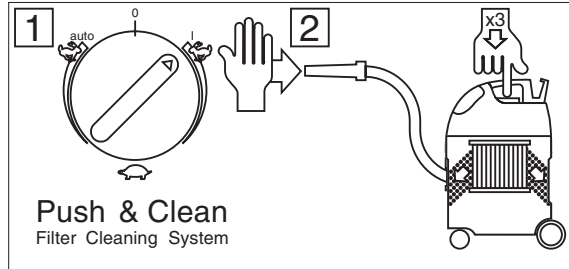

Only after picking up harmless dust using the waste bag.

If suction performance drops:

1. Set the suction power to maximum.
2. Close the nozzles or suction hose opening with the palm of your hand.

3. Press the button to start filter cleaning three times. The resulting stream of air removes attached dust from the slats of the filter elements.

4.6 Cleaning the filter element (ATTIX 560-2MXC/761-2MXC)



To ensure that suction performance is always at its best, the filter element is automatically cleaned during operation. We recommend complete cleaning if the filter element becomes extremely dirty.

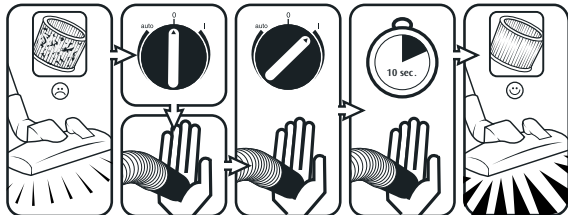

After picking up harmless dust using the waste bag.

1. Switch off the vacuum cleaner
2. Close the nozzles or suction hose opening with the palm of your hand.
3. Turn the switch to position „I“ and let the cleaner operate for approx. 10 seconds with the suction hose opening closed.

¹⁾ Option depending on model

5 Applications and techniques

5.1 Techniques

If used correctly, additional accessories, suction nozzles and suction hoses can enhance the cleaning action and reduce the cleaning effort.

Effective cleaning is achieved if you follow just a few guidelines in combination with your own practical experience in special fields.

Here are some basic tips.

5.1.1 Picking up dry substances



Do not pick up flammable substances.

The suction hose diameter must suit the position of the switch in order to pick up dry, nonflammable dust with maximum room concentration values.



There must always be a safety filter bag in the tank before dry substances with maximum room concentration values are picked up. See section 9.5 "Accessories" for ordering number.



To pick up harmless dust we recommend the use of a waste bag. See section 9.5 "Accessories" for ordering number. Dis-



posal of the picked up material is then simple and hygienic.

After picking up liquids, the filter element is wet. A damp filter element clogs more quickly when dry substances are picked up. For this reason the filter element should be washed and dried or replaced by a dry element before dry substances are picked up.

Always use a filter bag/waste bag that is suitable for the type of dust (see table):

ATTIX 360-2M			
Type of dust		Filter bag/waste bag	Handling/waste disposal
• Nonhazardous dust		Waste bag No. 302000804	1. Thorough cleaning - see section 4.5. 2. Waste disposal - see section 7.2.1 Waste disposal - see section 7.2.2
• Dust with MAC values $\geq 0.1 \text{ mg/m}^3$ • wood dust		Filter bag No. 302000449	Waste disposal - see section 7.2.2

ATTIX 550-2M			
Type of dust		Filter bag/waste bag	Handling/waste disposal
• Nonhazardous dust		Waste bag ATTIX 550-2M: No. 302000728 ATTIX 751-2M: No. 302001480	Waste disposal - see section 7.2.1
• Dust with MAC values $\geq 0.1 \text{ mg/m}^3$ • wood dust		Filter bag ATTIX 550-2M: No. 302000527 ATTIX 751-2M: No. 302001484	Waste disposal - see section 7.2.2

ATTIX 560-2MXC			
Type of dust		Filter bag/waste bag	Handling/waste disposal
• Nonhazardous dust • Dust with MAC values $\geq 0.1 \text{ mg/m}^3$ • Observe any additional national regulations		Waste bag ATTIX 560-2MXC: No. 302000728 ATTIX 761-2MXC: No. 302001480	Waste disposal: 1. Remove hose with tool sleeve from tool 2. Thorough cleaning - see section 4.6 3. Waste disposal - see section 7.2.1
• Dust with MAC values $\geq 0.1 \text{ mg/m}^3$ • wood dust		Filter bag ATTIX 560-2MXC: No. 302001138 ATTIX 761-2MXC: No. 302001484	Waste disposal - see section 7.2.2

5.1.2 Picking up liquids



Do not pick up flammable substances.

Before liquids are picked up, always remove the filter bag/waste bag and check that the float (ATTIX 360-2M/550-2M/751-2M) or the water level limit (ATTIX 560-2MXC/761-2MXC) works properly. (See section 7.2.5 and 7.2.6 "Replacing the filter element".)

The use of a separate filter element or filter screen is recommended.

If foam appears, stop work immediately and empty the tank.

To reduce the amount of foam, use foam killer Nilfisk-Alto Foam Stop (see section 9.5 „Accessories“ for order number).

6 After finishing work

6.1 Switching the vacuum cleaner off and storage

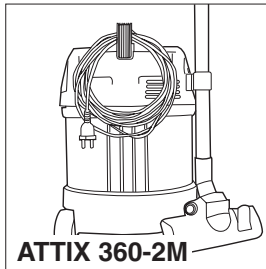

1. After picking up hazardous dust, vacuum clean the outside of the cleaner.
2. Switch off the vacuum cleaner and pull the mains plug out of the socket.
3. Wind up the power cord and hang it on the handle.
4. Empty the tank and clean the vacuum cleaner.
5. After picking up liquids: Store the upper section of the cleaner separately so that the filter element can dry.
6. Store the vacuum cleaner in a dry room where it is protected from unauthorized use.

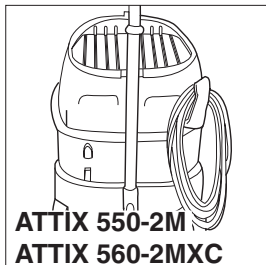
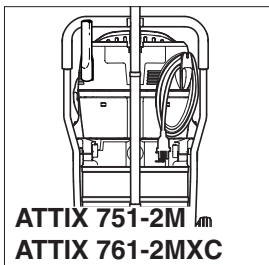

¹⁾ Option depending on model

7 Maintenance

7.1 Maintenance plan

		After finishing work	As required
7.2.1	Replacing the waste bag		●
7.2.2	Replacing the filter bag		●
7.2.3	Emptying dirt tank (ATTIX 3+5)	●	
7.2.4	Emptying the dirt tank (ATTIX 7)	●	
7.2.5	Replacing filter element (ATTIX 360-2M/550-2M/751-2M)		●
7.2.6	Replacing filter element (ATTIX 560-2MXC/761-2MXC)		●

7.2 Maintenance work

7.2.1 Replacing the waste bag



When using ATTIX 360-2M/560-2MXC/761-2MXC clean them thoroughly before replacing the waste bag - see sections 4.5 bzw.4.6.



During the following work, ensure that dust is not unnecessarily spread around. Wear a P2 breathing mask.

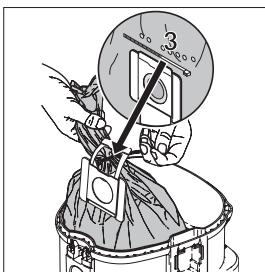
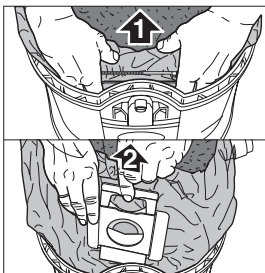

ATTIX 360-2M/550-2M/560-2MXC:

1. Open the retaining clamps and remove the upper section of the cleaner from the dirt tank.
2. Carefully remove the waste bag connection (1) from the inlet fitting.
3. Close the waste bag connection with the slide (2).
4. Close the waste bag using the cable binder (3).
5. Dispose of the dirt in accordance with legal regulations.
6. Insert a new filter bag into the cleaned tank as described in the instructions enclosed.

IMPORTANT: Press the filter bag connection firmly on to the inlet fitting.

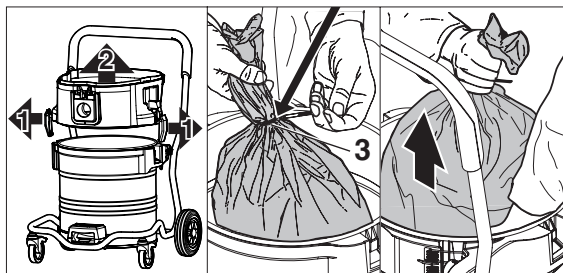

ATTIX 751-2M/761-2MXC:

1. Remove the upper section of cleaner from the dirt tank.
2. Open the retaining clamps (1) and remove the intermediate ring (2) from the tank.
3. Carefully remove the waste bag connection from the inlet fitting.
4. Close the waste bag using the cable binder (3).
5. Dispose of the dirt in accordance with legal regulations.
6. Insert a new filter bag into the cleaned tank as described in the instructions enclosed.

IMPORTANT: Press the filter bag connection firmly on to the inlet fitting.

7.2.2 Replacing the filter bag



During the following work, ensure that dust is not unnecessarily spread around. Wear a P2 breathing mask.

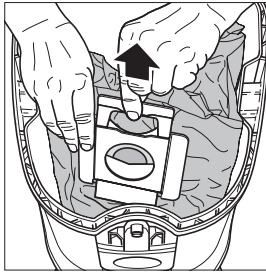

1. Open the retaining clamps and remove the upper section of the cleaner from the dirt tank.
2. Carefully remove the filter bag connection from the inlet fitting.
3. Close the filter bag connection with the slide.
4. Dispose of the filter bag in accordance with legal regulations.
5. Place a new filter bag into the cleaned tank as described in the instructions (printed on the filter bag)

IMPORTANT: Press the filter bag connection on the inlet fitting as far as possible.

7.2.3 Emptying dirt tank (ATTIX 3+5)



Only after picking up harmless dust without a filter bag.

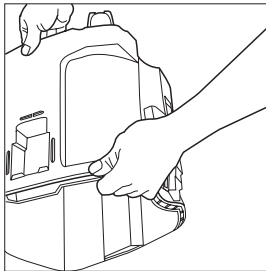

1. Remove the upper section of cleaner from the dirt tank.
 2. Using one hand, take hold of the dirt tank underneath and tip out the dirt.
 3. Dispose of the dirt in accordance with legal regulations.
 4. Clean the rim of the tank before fitting the upper section of cleaner.
- Before reinserting the suction hose:
5. Clean the inlet fitting and hose collar.

7.2.4 Emptying the dirt tank (ATTIX 7)

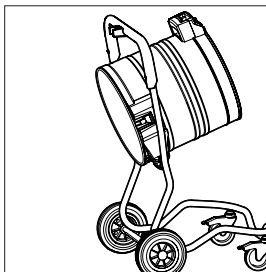
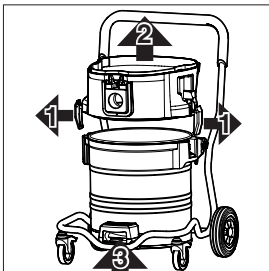

1. Remove the upper section of cleaner from the dirt tank.
2. Open the retaining clamps (1) and remove the intermediate ring (2) from the tank.
3. Pull the lever in the handle (3) upwards and tilt the tank.
4. Tip out the collected dirt.
5. Dispose of the dirt in accordance with legal regulations.

or:

3. Open the tank locks (4).
4. Use the handles (5) to lift the tank out of the frame.
5. Tip out the collected dirt.
6. Place the empty tank in the frame and close the locks (4).
7. Dispose of the dirt in accordance with legal regulations.



Only after picking up harmless dust without a filter bag.



To empty the dirt tank after picking up liquids: remove the intermediate ring as a proper seal is only ensured during suction. After emptying the tank: clean the rim of the tank and the seals in the intermediate ring and the upper section of cleaner before refitting them.

If the seal or groove is dirty or damaged, the suction performance will

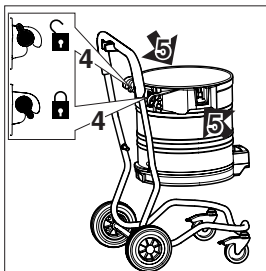

be reduced.

Before reinserting the suction hose: clean the inlet fitting and hose collar.

¹⁾ Option depending on model

7.2.5 Replacing filter element (ATTIX 360-2M/550-2M/ 751-2M)



During the following work, ensure that dust is not unnecessarily spread around. Wear a P2 breathing mask.

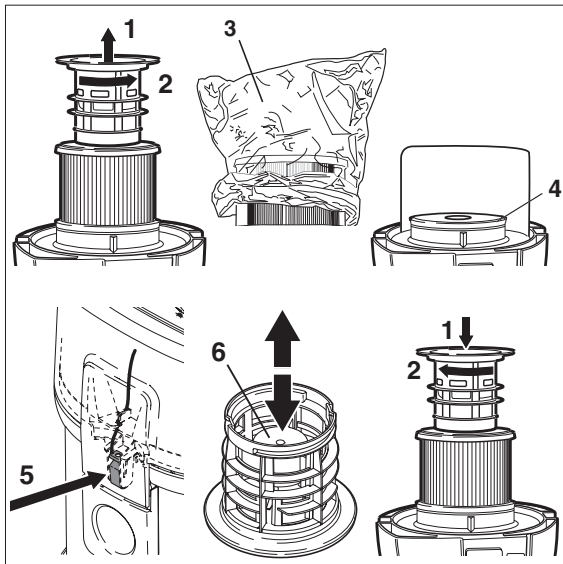

1. Open the retaining clamps and remove the upper section of the cleaner from the dirt tank. Lay the upper section of the cleaner down with the filter element facing upwards.
2. Turn the filter holder anticlockwise (1) and remove it (2).
3. Place the protective filter bag¹⁾ over the filter element (3).
4. Carefully remove the filter element and close the protective filter bag with a knot.
5. Clean the filter seal (4). Check it for damage and replace it if necessary.
6. Check the antistatic clamp (5) for damage and have it replaced by Nilfisk-Alto Service if necessary.
7. Fit a new filter element.
8. Check that the float (6) works properly. When the filter holder is turned, the float inside must move about easily.
9. Fit the filter holder and turn it clockwise to secure it firmly.
10. Dispose of the used filter element in accordance with legal regulations.



Never use the vacuum cleaner without a filter.

7.2.6 Replacing filter element (ATTIX 560-2MXC/ 761-2MXC)



During the following work, ensure that dust is not unnecessarily spread around. Wear a P2 breathing mask.

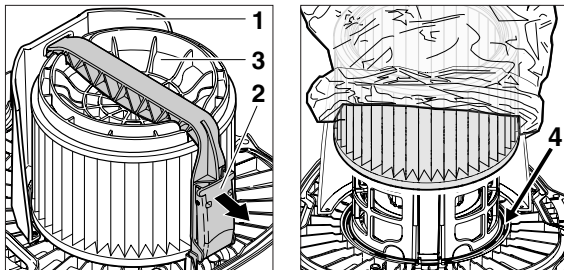

1. Open the retaining clamps and remove the upper section of the cleaner from the dirt tank. Lay the upper section of the cleaner down with the filter element facing upwards. Do not place the upper section of the cleaner on the guard (1) and do not damage the filter element.
2. Open the bar handle (2) and remove it.
3. Remove the filter holder (3).
4. Place the protective filter bag¹⁾ over the filter element.
5. Carefully remove the filter element and close the protective filter bag with a knot.
6. Clean the filter seal (4). Check it for damage and replace it if necessary.

¹⁾ Accessory. Order No. shown in section 9.5.

¹⁾ Option depending on model

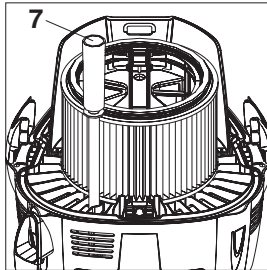
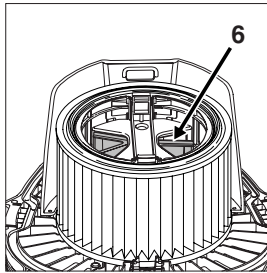
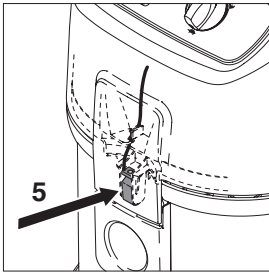

7. Check the antistatic clamp (5) for damage and have it replaced by Nilfisk-Alto Service if necessary.
8. Check that the control flap (6) for filter cleaning works properly. The control flap should move back and forwards easily.
9. Clean the level hose (7).
10. Fit a new filter element.
11. Fit the filter holder. Ensure that it is in the correct position.
12. Fit bar and close bar handle.
13. Dispose of the used filter element in accordance with legal regulations.



Never use the vacuum cleaner without a filter.

8 Troubleshooting

Fault	Cause	Remedy
‡ Motor does not start	<ul style="list-style-type: none"> > Fuse of the mains socket has blown. > Overload protection switch has tripped. > Self-acting carbon brush is worn. 	<ul style="list-style-type: none"> • Connect mains fuse. • Switch off the vacuum cleaner and allow it to cool for approx. 5 minutes. If the cleaner cannot be started again, contact the Nilfisk-Alto service department. • Have carbon brushes changed by Nilfisk-Alto Service.
‡ Motor does not run in automatic mode	<ul style="list-style-type: none"> > Power tool is defective or not connected properly. > The power rating of the electrical tool is too low. 	<ul style="list-style-type: none"> • Check that the power tool works or that the plug is inserted correctly. • Note that minimum power rating is P>40W
‡ The acoustic warning sounds. (Reduced suction power)	<ul style="list-style-type: none"> > Suction power selected with suction power control is too low. > Hose diameter and switch position do not correspond. > Clogged suction hose/nozzle. > Filter bag is full. 	<ul style="list-style-type: none"> • Set suction power in accordance with section 4.2.3. „Setting suction power“. • Set correct switch position for hose diameter. • Clean suction hose/nozzle • See section 7.2.2 „Replacing filter bag“.

¹⁾ Option depending on model

¹⁾ Accessory. Order No. shown in section 9.5.

Fault	Cause	Remedy
‡ The acoustic warning sounds. (Reduced suction power)	<ul style="list-style-type: none"> > Filter element is clogged. > ATTIX 560-2MXC/761-2MXC only: Defective cleaning mechanism 	<ul style="list-style-type: none"> • See section 4.5/4.6 „Cleaning filter element“ and 7.2.5/7.2.6 „Replacing filter element“. • Contact Nilfisk-Alto Service
‡ No suction power during wet cleaning	<ul style="list-style-type: none"> > Tank is full. (Float does not close the suction opening). 	<ul style="list-style-type: none"> • Switch off the cleaner. Empty the tank.
‡ The vacuum cleaner switches off during wet cleaning	<ul style="list-style-type: none"> > Tank is full. 	<ul style="list-style-type: none"> • Switch off the cleaner. Empty the tank.
‡ Voltage fluctuations	<ul style="list-style-type: none"> > Impedance of power supply is too high. 	<ul style="list-style-type: none"> • Connect the cleaner to another socket closer to the fuse box. Voltage fluctuations over 7% should not occur if the impedance at the transfer point is $\leq 0.15 \Omega$.

9 Further information

9.1 Recycling the vacuum cleaner

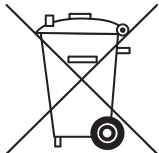

Make the old cleaner unusable immediately.

1. Unplug the cleaner and cut the power cord.

Do not discard of electrical appliances with household waste.

As specified in European Directive 2002/96/EC on old electrical

and electronic appliances, used electrical goods must be collected separately and recycled ecologically.

Contact your local authorities or your nearest dealer for further information.

9.2 Guarantee

Our general conditions of business are applicable with regard to the guarantee. Subject to change as a result of technical advances.

9.3 Tests and approvals

The vacuum cleaners have been tested as specified in IEC/EN 60335-2-69 including appendix AA. All the requirements were fulfilled for equipment in dust class M.

The vacuum cleaners must be inspected regularly in accordance with national accident prevention regulations (in Germany as specified in BGV A2 and DIN VDE 0701 Part 1 and Part 3, at regular intervals and after repairs or modifications).

A dust test must be performed at least once every year by the manufacturer or a trained person. This test covers, for example, whether there is damage to the filter, the vacuum cleaner is sealed to the air and the control equipment works properly.

9.4 Technical data

ATTIX									
		360-2M		550-2M			560-2MXX	751-2M	761-2MXX
		EU	GB 230/240V	EU	GB 230/240V	GB 110V	EU	EU	EU
Voltage	V	230	230/240	230	230/240	110	230	230	230
Mains frequency	Hz	50/60							
Fuse	A	16	13	16	13	16	16	16	16
Power consumption	W	1200							
Connected load for appliance socket	W	2400	1800	2400	1800	560	2400	2400	2400
Total connected load	W	3600	3000	3600	3000	1760	3600	3600	3600
Volume flow (air)	l/min	3600							
Negative pressure	Pa	23000							
Measurement area sound pressure level at a distance of 1 m, EN 60704-1	dB(A)	62			60				
Operating noise	dB(A)	59			57				
Power cord: Length	m	7,5	10,0	7,5	10,0	7,5	7,5	7,5	7,5
Power cord: Length		H05RR- F3G1,5				H07BQ- F3G1,5	H05RR- F3G1,5	H05RR- F3G1,5	
Protection class		I							
Type of protection (splash water protected)		IP X4							
Radio interference level		EN 55014-1							
Tank volume	l	27			45			70	
Width	mm	380			476			580	
Depth	mm	390			506			605	
Height	mm	570			655			970	
Weight	kg	10			14			25	27

Suction hose diameter mm	Minimum air flow volume l/min	Associated negative pressure between suction hose/tool Pa
27	690	16300
32	970	15700
36	1220	14200
50	2360	7800

9.5 Accessories

Description	Order No.		
	360-2M	550-2M	560-2MXX
Filter bag (5 pcs.)	302000449	302000527	302001138
Waste bag (5 pcs.)	302000804	302000728	
Filter element	302000461	302000726	
Cloth insert filter	302000606	302000525	

	751-2M	761-2MXX
	Filter bag (5 pcs.)	302001484
Waste bag (5 pcs.)	302001480	
Filter element	302000461	302000726
Cloth insert filter	302000525	

	360-2M / 550-2M / 560-2MXX 751-2M / 761-2MXX
Protective filter bag (10 pcs.)	30082
Filter screen	15475
Niifisk-Alto-Foam-Stop (6 x 1 l)	8469

9.6 EC declaration of conformity

 EC declaration of conformity	
Alfo Deutschland GmbH Guido-Cheerfurter-Strasse 2-8 D-89287 Bellenberg	
Product:	Vacuum cleaner for wet and dry operation
Model:	ATTIX 360-2M/550-2M/560-2MXX ATTIX 751-2M/761-2MXX
Description:	110/230-240 V~, 50/60 Hz, 1200 W, Dust class M
The design of the appliance corresponds to the following pertinent regulations:	EC Machine Directive 98/37/EC EC Low Voltage Directive 73/23/EC EC EMC Directive 89/336/EC
Applied harmonized standards:	EN 12100-1, EN 12100-2 EN 60335-1 EN 60335-2-69 EN 55014-1, EN 55014-2, EN 61000-3-2
Applied national standards and technical specifications:	DIN EN 60335-1 DIN EN 60335-2-69
 Dipl.-Ing. Wolfgang Nieuwkamp Tests and approvals	
Bellenberg, 22.10.2004	

1) Option depending on model

**INTERNET**

<http://www.nilfisk-alto.com>

HEADQUARTER

Nilfisk-Advance Group
Sognevej 25
2605 Brøndby
Denmark
Tel.: +45 4323 8100

AUSTRALIA

Nilfisk-ALTO
48 Egerton St.
Silverwater NSW 2128
Tel.: +61 2 8748 5966
Fax: +61 2 8748 5960

AUSTRIA

ALTO Österreich GmbH
Metzgerstr. 68
5101 Bergheim/Salzburg
Tel.: +43 6624 5 64 00-11
Fax: +43 6624 5 64 00-34
E-mail: info@nilfisk-alto.at
Web: www.nilfisk-alto.at

BRAZIL

Wap do Brasil Ltda.
Rua 25 de Agosto, 608
83323-260 Pinhais/Paraná
Tel.: +55 4 12 10 67 40 0
Fax: +55 4 12 10 67 40 3
E-mail: export@wapdobrasil.com.br

CANADA

ALTO Canada
24 Constellation Road
Rexdale
Ontario M9W 1K1
Tel.: +1 416 6 75 58 30
Fax: +1 416 6 75 69 89

CROATIA

Wap ALTO Strojevi za čišćenje, d.o.o.
Siget 18a
10020 Zagreb
Tel.: +385 1 65 54 144
Fax: +385 1 65 54 112
E-mail: admin.wap@wap-sistemi.hr

CZECH REPUBLIC

ALTO Česká Republika s.r.o.
Zateckých 9
14000 Praha 4
Tel.: +420 2 41 40 84 19
Fax: +420 2 41 40 84 39
E-mail: wap_p@mbox.vol.cz
Web: www.wap-alto.cz

DENMARK

ALTO Danmark A/S
Industrivej 1
9560 Hadsund
Tel.: +45 7218 21 00
Fax: +45 7218 21 11
E-mail: salg@nilfisk-alto.dk
service@nilfisk-alto.dk
Web: www.nilfisk-alto.dk

FRANCE

ALTO France S.A.
Aéroparc 1
19 Rue Icare
F- 67960 Entzheim
Tel.: +33 3 88 28 84 00
Fax: +33 3 88 30 05 00
E-mail: info@nilfisk-alto.fr
Web: www.nilfisk-alto.com

GERMANY

Nilfisk-Advance AG
Geschäftsbereich Nilfisk-ALTO
Guido-Oberdorter-Strasse 10
89287 Bellenberg
Tel.: +49 0180 5 37 37 37
Fax: +49 0180 5 37 37 38
E-mail: info@nilfisk-alto.de
Web: www.nilfisk-alto.de

GREAT BRITAIN

Nilfisk-ALTO
Division of Nilfisk-Advance Ltd.
Bowerbank Way
Gilwilly Industrial Estate
UK-Penrith, Cumbria CA 11 9BQ
Tel.: +44 1768 86 89 95
Fax: +44 1768 86 47 13
E-mail: sales@nilfisk-alto.co.uk
Web: www.nilfisk-alto.co.uk

MALAYSIA

ALTO DEN-SIN Malaysia Sdn Bhd
SD 14, Jalan KIP 11, Taman
Perindustrian KIP, SRI Damansara
52200 Kuala Lumpur
Malaysia
Tel.: +603 627 4 6 913
Fax: +603 627 4 6 318
E-mail: densin@tm.net.my

NETHERLANDS

ALTO Nederland BV
Houtschelf 7
NL-3371 KB Hardinxveld-Giessendam
Tel.: +31 184 677 200
Fax: +31 184 677 201
E-mail: info@nilfisk-alto.nl
Web: www.nilfisk-alto.nl

NEW ZEALAND

ALTO Overseas Inc.
5A Tarndale Grove
Albany Auckland
Tel.: +64 9 414 4520
Fax: +64 9 414 4521
E-mail: altonz@ihug.co.nz

NORWAY

ALTO Norge A/S
Bjørnerudveien 24
1266 Oslo
Tel.: +47 22 75 17 70
Fax: +47 22 75 17 71
E-mail: info@nilfisk-alto.no

SINGAPORE

ALTO DEN-SIN Singapore Pte Ltd.
No. 17 Link Road
Singapore 619034
Tel.: +65 62 68 10 06
Fax: +65 62 68 49 16
E-mail: densin@singnet.com.sg
Web: www.densin.com

SLOVENIA

Wap ALTO čistilni sistemi, d.o.o.
Letališka 33
SLO-1110 Ljubljana
Tel.: +368 15 20 62 00
Fax: +368 15 20 62 10
E-mail: wap.prodaja@siol.net

SLOWAKIA

Wap ALTO čistiace systémy s.r.o.
Remeselnícka 42
83106 Bratislava-Rača
Tel.: +421 2 44 881 402/405
Fax: +421 2 44 881 395
E-mail: wap@ginet.sk
Web: www.wap-alto.sk

SPAIN

Nilfisk-ALTO
Division of Nilfisk-ALTO S.A.
Torre D'Ara
Paseo del Rengle, 5 Pl. 10
E-08302 Mataró Barcelona
Tel.: +34 93 741 24 00
Fax: +34 93 757 80 20
E-mail: info@nilfisk-alto.es
Web: www.nilfisk-alto.com

SWEDEN

ALTO Sverige AB
Aminogatan 18, BOX 4029
431 04 Mölndal
Tel.: +46 3 17 06 73 00
Fax: +46 3 17 06 73 41
E-mail: info@nilfisk-alto.se
Web: www.nilfisk-alto.se

USA

ALTO Cleaning Systems, Inc.
Part of the Nilfisk-Advance Group
12249 Nations Ford Road
28134 Pineville
Tel.: +1 704 971 1240
Fax: +1 704 971 1241
E-mail: info@altocsi.com
Web: www.nilfisk-alto.com

Free Manuals Download Website

<http://myh66.com>

<http://usermanuals.us>

<http://www.somanuals.com>

<http://www.4manuals.cc>

<http://www.manual-lib.com>

<http://www.404manual.com>

<http://www.luxmanual.com>

<http://aubethermostatmanual.com>

Golf course search by state

<http://golfingnear.com>

Email search by domain

<http://emailbydomain.com>

Auto manuals search

<http://auto.somanuals.com>

TV manuals search

<http://tv.somanuals.com>