

MinIT6000

User's Manual



MiniIT6000 Windows Based Terminal Limited Warranty

Software Warranty:

NLynx warrants that for a period of ninety (90) days from the date of purchase by the End User, its Software Products shall conform to its published specifications under normal usage. NLYNX DOES NOT WARRANT THAT THE OPERATION OF THE SOFTWARE WILL BE UNINTERRUPTED OR ERROR-FREE, OR THAT ALL SOFTWARE DEFECTS WILL BE CORRECTED. In the event a Software Product fails to comply with the warranty set forth above, NLynx will replace the product. End User must, however, return all copies of the Software, along with proof of purchase, to NLynx within 90 days from the Software purchase date.

Hardware Warranty:

NLynx Technologies warrants that for one year the MiniIT6000 Hardware Product shall be free from defects in materials and workmanship which arise under proper and normal use and service. In the event the MiniIT6000 Hardware Product fails to comply with the warranty set forth above, NLynx will replace or repair the Product. End User must, however, return the Hardware Product, along with proof of purchase, to NLynx.

Warranty Limitations:

End User's sole remedy under any Warranty provided by NLynx shall be limited to the replacement or repair of the Product, or at NLynx's sole discretion, a refund of the purchase price. Transportation costs in connection with the return of any Product to and from NLynx's plant shall be paid by the End User. NLYNX GRANTS NO WARRANTY, EXPRESS OR IMPLIED OTHER THAN THE WARRANTIES STATED ABOVE. EXPRESSLY EXCLUDED ARE THE IMPLIED WARRANTIES OF MERCHANTABILITY AND FITNESS FOR A PARTICULAR PURPOSE. IN NO EVENT SHALL NYLNX BE LIABLE FOR SPECIAL, INCIDENTAL, OR CONSEQUENTIAL DAMAGES, INSTALLATION COSTS, LOST REVENUE OR PROFITS, OR ANY OTHER COSTS INCURRED AS A RESULT OF THE USE OF ANY NLYNX PRODUCT, WHETHER OR NOT USED IN ACCORDANCE WITH INSTRUCTIONS.

Printed in USA – Document 400–xxxx-01 Rev 2.11, November 2003

Table of Contents

<u>MINIIT6000 WINDOWS BASED TERMINAL LIMITED WARRANTY</u>	2
SOFTWARE WARRANTY:	2
HARDWARE WARRANTY:.....	2
WARRANTY LIMITATIONS:	2
<u>COPYRIGHT AND TRADEMARKS</u>	6
COPYRIGHT NOTICE.....	6
TRADEMARKS NOTICE	6
<u>END USER LICENSE AGREEMENT</u>	7
END USER LICENSE AGREEMENT (EULA)	7
<u>MINIT6000 GENERAL SPECIFICATIONS</u>	12
<u>TERMINAL INSTALLATION</u>	13
MINIT 6000 THIN CLIENT TERMINAL	13
BASIC HARDWARE INSTALLATION	14
MOUNTING THE TERMINAL	14
USING THE TERMINAL.....	14
<u>SETUP WIZARD</u>	15
ABOUT.....	15
WELCOME WINDOW	15
<u>CONNECTION MANAGEMENT</u>	22
CONNECTIONS MANAGEMENT	22
<u>CREATING A NEW CONNECTION</u>	26
CREATING A NEW CONNECTION.....	26
CREATE A RDP CONNECTION	27
CREATE AN ICA CONNECTION.....	29
<u>EDITING A CONNECTION</u>	36
EDITING A CONNECTION	36
EDITING AN ICA CONNECTION	38
<u>GENERAL SETTINGS AND INFORMATION</u>	42
STARTING PROGRAMS.....	42
STARTING MULTIPLE SESSIONS.....	42
ARRANGE DESKTOP ICONS	42
MOVE DESKTOP ICONS	42
TOGGLE OR SWITCH BETWEEN SESSIONS AND / OR WINDOWS	42
JUMP TO DESKTOP FROM SESSION OR APPLICATION WINDOW	43
CHANGE TASKBAR SETTINGS	43
MULTIPLE TASKBARS	44

<u>CONFIGURE TERMINAL PROPERTIES</u>	<u>45</u>
CONTROL PANEL	45
DATE / TIME	46
DESKTOP STYLE	46
DISPLAY	47
EDGEPORT	48
FTP UPDATE WINDOW	49
ICA SETTING.....	50
INPUT & VOLUME	55
INTERNET SETTINGS.....	56
LPD SETTING	58
NETWORK.....	59
OPTIONS.....	62
PRINTERS	63
RDP SETTING.....	67
SECURITY.....	69
SNMP	70
SYSTEM.....	71
THINPRINT	72
<u>NLYNX TN5250 TERMINAL EMULATION.....</u>	<u>74</u>
5250 TERMINAL SESSION SETUP	74
5250 PRINTER SESSION SETUP.....	76
STARTING A SESSION.....	78
USING THE TOOLBAR BUTTONS.....	80
OTHER MENU FUNCTIONS	81
EDITING SESSION PROPERTIES	82
<u>TEXT TERMINAL EMULATOR.....</u>	<u>87</u>
<u>CITRIX ICA CLIENT</u>	<u>87</u>
<u>EMAIL USER'S GUIDE.....</u>	<u>88</u>
ABOUT.....	88
STARTING EMAIL	88
SETUP MAIL SERVICE	89
DOWNLOAD MESSAGES FROM SERVER	93
REPLY TO OR FORWARD A MESSAGE.....	94
CREATE A NEW MESSAGE	94
ADDRESS BOOK	95
EDIT EMAIL OPTIONS	95
VIEWING ATTACHMENTS.....	97
SAVING EMAIL ATTACHMENTS	98
TOOLBAR BUTTONS.....	99

GENERAL INFORMATION.....	100
<u>USING INTERNET EXPLORER.....</u>	101
ABOUT.....	101
CONNECT TO THE INTERNET VIA AN ETHERNET LAN	101
INTERNET OPTIONS	101
PRINTING	103
FAVORITES.....	104
ADDITIONAL MENU BAR ITEMS.....	106
NAVIGATING USING THE TOOLBAR	108
ADDRESS BAR	108
<u>SHARED NETWORK DRIVES</u>	109
ABOUT.....	109
SHARING A NETWORK DRIVE / FOLDER ON A WINDOWS 95/98 PC.....	109
CREATING DESKTOP SHORTCUT TO A SHARED NETWORK DRIVE / FOLDER.....	109
ACCESSING A SHARED DRIVE	111
<u>UPGRADE UTILITIES</u>	114
FTP FIRMWARE UPGRADE	114
<u>TROUBLESHOOTING</u>	117
ABOUT.....	117
1. MINIT6000 CONFIGURATION PROBLEMS.....	117
2. NETWORK PROBLEMS	119
3. PERCEIVED 5250 HOST PROBLEMS	121
4. 5250 HOST PROBLEMS	122
5. PRINTER PROBLEMS.....	126

Copyright and Trademarks

Copyright Notice

This manual, as well as the software described in it, is furnished under license. No part of this publication may be reproduced, transmitted, stored in a retrieval system, or translated into any human or computer language, in any form or by any means, electronic, mechanical, magnetic, optical, chemical, manual or otherwise, without the prior written permission of NLynx Technologies.

© 2003 NLynx Technologies, Inc. All rights reserved.

Note: Information in this document is subject to change without notice.

Trademarks Notice

Microsoft® is registered trademarks of Microsoft® Corporation.

- Windows® is registered trademarks of Microsoft® Corporation.
- ICA® is a registered trademark of Citrix® Systems Inc.
- MetaFrame® is a trademark of Citrix® Systems Inc.
- Micro Touch® is a trademark of Micro Touch® Inc.
- Ericom® and PowerTerm® are registered trademarks of Ericom® Software Ltd.
- Other company and brand, product and service names are trademarks or registered trademarks of their respective holders.

End User License Agreement

End User License Agreement (EULA)

EULA for Microsoft Windows CE Operating System for Windows-based Terminal Devices

IMPORTANT—READ CAREFULLY

This End User License Agreement (EULA) is a legal agreement between you (either an individual or a single entity) and the manufacturer (MANUFACTURER) of the special purpose computing device (SYSTEM) you acquired which includes certain Microsoft software product(s) installed on the SYSTEM and/or included in the SYSTEM package (SOFTWARE). The SOFTWARE includes computer software, the associated media, any printed materials, and any online or electronic documentation. By installing, copying or otherwise using the SOFTWARE, you agree to be bound by the terms of this EULA. If you do not agree to the terms of this EULA, MANUFACTURER and Microsoft Licensing, Inc. (MS) are unwilling to license the SOFTWARE to you. In such event, you may not use or copy the SOFTWARE, and you should promptly contact MANUFACTURER for instructions on return of the unused product(s) for a refund.

SOFTWARE LICENSE

The SOFTWARE is protected by copyright laws and international copyright treaties, as well as other intellectual property laws and treaties. The SOFTWARE is licensed, not sold.

1. GRANT OF LICENSE

SOFTWARE includes software already installed on the SYSTEM (SYSTEM SOFTWARE) and, if included in the SYSTEM package, software contained on the CD-ROM disk and/or floppy disk(s) labeled "Desktop Software for Microsoft Windows CE" (DESKTOP SOFTWARE). This EULA grants you the following rights to the SOFTWARE:

- **System Software.**

You may use the SYSTEM SOFTWARE only as installed in the SYSTEM.

- **Desktop Software.**

DESKTOP SOFTWARE might not be included with your SYSTEM. If DESKTOP SOFTWARE is included with your SYSTEM, you may install and use the component(s) of the DESKTOP SOFTWARE in accordance with the terms of the end user license agreement provided with such component(s). In the absence of a separate end user license agreement for particular component(s) of the DESKTOP SOFTWARE, you may install and use only one (1) copy of such component(s) on a single computer with which you use the SYSTEM.

- **Use of Windows CE Operating System for Windows-Based Terminal Devices with Microsoft Windows NT Server, Terminal Server Edition.**

If the SOFTWARE is Windows CE operating system for Windows-Based Terminal devices, the following special provisions apply. In order to use the SYSTEM in connection with Windows NT Server, Terminal Server Edition, you must possess (1) a Client Access License for Windows NT Server, Terminal Server Edition and (2) an end user license for Windows NT Workstation or an end user license agreement for Windows NT Workstation for Windows-Based Terminal Devices (please refer to the end user license agreement for Windows NT Server, Terminal Server Edition for additional information).

MANUFACTURER may have included a Certificate of Authenticity for Windows NT Workstation for Windows-Based Terminal Devices with the SYSTEM. In that case, this EULA constitutes an end user license for the version of Windows NT Workstation for Windows-Based Terminal Devices indicated on such Certificate of Authenticity.

- **Back-up Copy.**

If MANUFACTURER has not included a back-up copy of the SYSTEM SOFTWARE with the SYSTEM, you may make a single back-up copy of the SYSTEM SOFTWARE. You may use the back-up copy solely for archival purposes.

2. Description of Other Rights and Limitations.

- **Speech/Handwriting Recognition**

If the SYSTEM SOFTWARE includes speech and/or handwriting recognition component(s), you should understand that speech and handwriting recognition are inherently statistical processes; that recognition errors are inherent in the processes; that it is your responsibility to provide for handling such errors and to monitor the recognition processes and correct any errors. Neither MANUFACTURER nor its suppliers shall be liable for any damages arising out of errors in the speech and handwriting recognition processes.

- **Limitations on Reverse Engineering, Recompilation and Disassembly**

You may not reverse engineer, decompile, or disassemble the SYSTEM SOFTWARE, except and only to the extent that such activity is expressly permitted by applicable law notwithstanding this limitation.

- **Single SYSTEM**

The SYSTEM SOFTWARE is licensed with the SYSTEM as a single integrated product. The SYSTEM SOFTWARE installed in Read Only Memory (ROM) of the SYSTEM may only be used as part of the SYSTEM.

- **Single EULA**

The package for the SYSTEM SOFTWARE may contain multiple versions of this EULA, such as multiple translations and/or multiple media versions (e.g., in the user documentation and in the software). Even if you receive multiple versions of the EULA, you are licensed to use only one (1) copy of the SYSTEM SOFTWARE.

- **Rental**

You may not rent or lease the SOFTWARE.

- **Software Transfer**

You may permanently transfer all of your rights under this EULA only as part of a sale or transfer of the SYSTEM, provided you retain no copies, you transfer all of the SOFTWARE (including all component parts, the media, any upgrades or backup copies, this EULA and, if applicable, the Certificate(s) of Authenticity), and the recipient agrees to the terms of this EULA. If the SOFTWARE is an upgrade, any transfer must include all prior versions of the SOFTWARE.

- **Termination**

Without prejudice to any other rights, MANUFACTURER or MS may terminate this EULA if you fail to comply with the terms and conditions of this EULA. In such event, you must destroy all copies of the SOFTWARE and all of its component parts.

3. Upgrades.

If the SYSTEM SOFTWARE and this EULA are provided separate from the SYSTEM by MANUFACTURER and the SYSTEM SOFTWARE is on a ROM chip, CD ROM disk(s) or floppy disk(s), and labeled "For ROM Upgrade Purposes Only" ("ROM Upgrade"), you may install one copy of the ROM Upgrade onto the SYSTEM as a replacement copy for the SYSTEM SOFTWARE originally installed on the SYSTEM and use it in accordance with Section 1 of this EULA.

4. Copyright.

All title and copyrights in and to the SOFTWARE (including but not limited to any images, photographs, animations, video, audio, music, text and "applets," incorporated into the SOFTWARE), the accompanying printed materials, and any copies of the SOFTWARE, are owned by MS or its suppliers (including Microsoft Corporation). You may not copy the printed materials accompanying the SOFTWARE. All rights not specifically granted under this EULA are reserved by MS and its suppliers (including Microsoft Corporation).

5. Product Support.

Product support for the SOFTWARE is not provided by MS, its parent corporation, Microsoft Corporation, or their affiliates or subsidiaries. For product support, please refer to MANUFACTURER's support number provided in the documentation for the SYSTEM. Should you have any questions concerning this EULA, or

if you desire to contact MANUFACTURER for any other reason, please refer to the address provided in the documentation for the SYSTEM.

6. Export Restrictions.

You agree that you will not export or re-export the SOFTWARE to any country, person, or entity subject to U.S. export restrictions. You specifically agree not to export or re-export the SOFTWARE: (i) to any country to which the U.S. has embargoed or restricted the export of goods or services, which as of March 1998 include, but are not necessarily limited to Cuba, Iran, Iraq, Libya, North Korea, Sudan and Syria, or to any national of any such country, wherever located, who intends to transmit or transport the products back to such country; (ii) to any person or entity who you know or have reason to know will utilize the SOFTWARE or portion thereof in the design, development or production of nuclear, chemical or biological weapons; or (iii) to any person or entity who has been prohibited from participating in U.S. export transactions by any federal agency of the U.S. government.

If the SOFTWARE is labeled "North America Only Version" above, on the Product Identification Card, or on the SOFTWARE packaging or other written materials, then the following applies: The SOFTWARE is intended for distribution only in the United States, its territories and possessions (including Puerto Rico, Guam, and U.S. Virgin Islands) and Canada. Export of the SOFTWARE from the United States is regulated under "EI controls" of the Export Administration Regulations (EAR, 15 CFR 730-744) of the U.S. Commerce Department, Bureau of Export Administration (BXA). A license is required to export the SOFTWARE outside the United States or Canada. You agree that you will not directly or indirectly, export or re-export the SOFTWARE (or portions thereof) to any country, other than Canada, or to any person or entity subject to U.S. export restrictions without first obtaining a Commerce Department export license. You warrant and represent that neither the BXA nor any other U.S. federal agency has suspended, revoked or denied your export privileges.

7. Note on Java Support.

The SYSTEM SOFTWARE may contain support for programs written in Java. Java technology is not fault tolerant and is not designed, manufactured, or intended for use or resale as on-line control equipment in hazardous environments requiring fail-safe performance, such as in the operation of nuclear facilities, aircraft navigation or communication systems, air traffic control, direct life support machines, or weapons systems, in which the failure of Java technology could lead directly to death, personal injury, or severe physical or environmental damage.

8. Limited Warranty.

• Limited Warranty

MANUFACTURER warrants that the SOFTWARE will perform substantially in accordance with the accompanying written materials for a period of ninety (90) days from the date of receipt. Any implied warranties on the SOFTWARE are limited to ninety (90) days. Some states/jurisdictions do not allow limitations on duration of an implied warranty, so the above limitation may not apply to you.

• Customer Remedies

MANUFACTURER'S and its suppliers' entire liability and your exclusive remedy shall be, at MANUFACTURER'S option, either (a) return of the price paid, or (b) repair or replacement of the SOFTWARE that does not meet the above Limited Warranty and which is returned to MANUFACTURER with a copy of your receipt. This Limited Warranty is void if failure of the SOFTWARE has resulted from accident, abuse, or misapplication. Any replacement SOFTWARE will be warranted for the remainder of the original warranty period or thirty (30) days, whichever is longer.

• No Other Warranties

EXCEPT AS EXPRESSLY PROVIDED IN THE LIMITED WARRANTY SECTION ABOVE, THE SOFTWARE IS PROVIDED TO THE END USER "AS IS" WITHOUT WARRANTY OF ANY KIND, EITHER EXPRESSED OR IMPLIED, INCLUDING, BUT NOT LIMITED TO, WARRANTIES OF NON- INFRINGEMENT, MERCHANTABILITY, AND/OR FITNESS FOR A PARTICULAR PURPOSE. THE ENTIRE RISK OF THE QUALITY AND PERFORMANCE OF THE SOFTWARE IS WITH YOU.

- **No Liability for Consequential Damages**

MANUFACTURER OR MANUFACTURER'S SUPPLIERS, INCLUDING MS AND ITS SUPPLIERS, SHALL NOT BE HELD TO ANY LIABILITY FOR ANY DAMAGES SUFFERED OR INCURRED BY THE END USER (INCLUDING, BUT NOT LIMITED TO, GENERAL, SPECIAL, CONSEQUENTIAL OR INCIDENTAL DAMAGES INCLUDING DAMAGES FOR LOSS OF BUSINESS PROFITS, BUSINESS INTERRUPTION, LOSS OF BUSINESS INFORMATION AND THE LIKE), ARISING FROM OR IN CONNECTION WITH THE DELIVERY, USE OR PERFORMANCE OF THE SOFTWARE.

If you acquired this EULA in the United States, this EULA is governed by the laws of the State of Washington.

If you acquired this EULA in Canada, this EULA is governed by the laws of the Province of Ontario, Canada. Each of the parties hereto irrevocably attorneys to the jurisdiction of the courts of the Province of Ontario and further agrees to commence any litigation which may arise hereunder in the courts located in the Judicial District of York, Province of Ontario.

If this EULA was acquired outside the United States, then local law may apply.

Should you have any questions concerning this EULA, please contact the MANUFACTURER of your SYSTEM.

U.S. GOVERNMENT RESTRICTED RIGHTS

The SOFTWARE and documentation are provided with RESTRICTED RIGHTS. Use, duplication, or disclosure by the Government is subject to restrictions as set forth in subparagraph (c)(1)(ii) of the Rights in Technical Data and Computer Software clause at DFARS 252.227-7013 or subparagraphs (c)(1) and (2) of the Commercial Computer Software—Restricted Rights at 48 CFR 52.227- 19, as applicable. MANUFACTURER is Microsoft Corporation/One Microsoft Way/Redmond, WA 98052-6399.

EULA for Microsoft Windows CE Operating System

IMPORTANT—READ CAREFULLY

IF YOU DO NOT AGREE TO THIS END USER LICENSE AGREEMENT (“EULA”), DO NOT USE THE DEVICE OR COPY THE SOFTWARE

INSTEAD, PROMPTLY CONTACT [COMPANY] FOR INSTRUCTIONS ON RETURN OF THE UNUSED DEVICE (S) FOR A REFUND. ANY USE OF THE SOFTWARE, INCLUDING BUT NOT LIMITED TO USE ON THE DEVICE, WILL CONSTITUTE YOUR AGREEMENT TO THIS EULA (OR RATIFICATION OF ANY PREVIOUS CONSENT).

GRANT OF SOFTWARE LICENSE. This EULA grants you the following license:

- You may use the SOFTWARE only on the DEVICE.
- **NOT FAULT TOLERANT.** THE SOFTWARE IS NOT FAULT TOLERANT. [COMPANY] HAS INDEPENDENTLY DETERMINED HOW TO USE THE SOFTWARE IN THE DEVICE, AND MS HAS RELIED UPON [COMPANY] TO CONDUCT SUFFICIENT TESTING TO DETERMINE THAT THE SOFTWARE IS SUIT ABLE FOR SUCH USE.
- **NO WARRANTIES FOR THE SOFTWARE. THE SOFTWARE is provided “AS IS” and with all faults. THE ENTIRE RISK AS TO SATISFACTORY QUALITY, PERFORMANCE, ACCURACY, AND EFFORT (INCLUDING LACK OF NEGLIGENCE) IS WITH YOU. ALSO, THERE IS NO WARRANTY AGAINST INTERFERENCE WITH YOUR ENJOYMENT OF THE SOFTWARE OR AGAINST INFRINGEMENT. IF YOU HAVE RECEIVED ANY WARRANTIES REGARDING THE DEVICE OF THE SOFTWARE, THOSE WARRANTIES DO NOT ORIGINATE FROM, AND ARE NOT BINDING ON, MS.**

- **Note on Java Support.** The SOFTWARE may contain support for programs written in Java technology is not fault tolerant and is not designed, manufactured, or intended for use or resale as online control equipment in hazardous environments requiring fail-safe performance, such as in the operation of nuclear facilities, aircraft navigation or communication systems, air traffic control, direct life support machines, or weapons systems, in which the failure of Java technology could lead directly to death, personal injury, or severe physical or environmental damage. Sun Microsystems, Inc. has contractually obligated MS to make this disclaimer.
- **No Liability for Certain Damages. EXCEPT AS PROHIBITED BY LAW, MS SHALL HAVE NO LIABILITY FOR ANY INDIRECT, SPECIAL, CONSEQUENTIAL OR INCIDENTAL DAMAGES ARISING FROM OR IN CONNECTION WITH THE USE OR PERFORMANCE OF THE SOFTWARE. THIS LIMITATION SHALL APPLY EVEN IF ANY REMEDY FAILS OF ITS ESSENTIAL PURPOSE. IN NO EVENT SHALL MS BE LIABLE FOR ANY AMOUNT IN EXCESS OF U.S. TWO HUNDRED FIFTY DOLLARS (U.S.\$250.00).**
- **Limitation on Reverse Engineering, Decompilation, and Disassembly.** You may not reverse engineer, decompile, or disassemble the SOFTWARE, except and only to the extent that such activity is expressly permitted by applicable law notwithstanding this limitation.
- **SOFTWARE TRANSFER ALLOWED BUT WITH RESTRICTIONS.** You may permanently transfer rights under this EULA only as part of a permanent sale or transfer of the Device, and only if the recipient agrees to this EULA. If the SOFTWARE is an upgrade, any transfer must also include all prior versions of the SOFTWARE.
- **EXPORT RESTRICTIONS.** You acknowledge that SOFTWARE is of US-origin. You agree to comply with all applicable and national law that apply to the SOFTWARE, including the U.S. Export Administration Regulations, as well as end-user, and country destination restriction issued by U.S. and other governments. For additional information on exporting the SOFTWARE, see <http://www.microsoft.com/exporting/>.

MiniT6000 General Specifications

Items		Specifications
Processor		<ul style="list-style-type: none"> SIS 550 200 MHz processor
Communication		<ul style="list-style-type: none"> Microsoft RDP and Citrix ICA protocol compliant 10/100 dual speed Ethernet, Twisted Pair (RJ45) One parallel port (DB-25 Female connector) Enhanced ps/2 keyboard interface Enhanced ps/2 mouse interface Two USB ports
Embedded O.S.		<ul style="list-style-type: none"> Microsoft Windows CE4.2 Microsoft IE 6.0
Display Resolution		<ul style="list-style-type: none"> Support 640x480, 800x600, 1024x768, 1280x1024 with high color. Flicker free, max. up to 85 Hz
Memory		<ul style="list-style-type: none"> SDRAM -- 64 MB SDRAM standard. (Max. 256MB) Flash -- 16 MB DOC standard. (Max. 64MB)
Server Operating System Support		<ul style="list-style-type: none"> Microsoft Windows 2000 (Server Edition) Microsoft Windows NT 4.0 (TSE) Citrix MetaFrame, Citrix WinFrame
Option Devices		<ul style="list-style-type: none"> USB storage device
Option Software		<ul style="list-style-type: none"> Text Terminal Emulation (PowerTerm) Remote Management (Remote Director)
Environment	Temperature	<ul style="list-style-type: none"> Operating : 5 °C to 40 °C (41 °F to 104 °F) Storage : -40 °C to 60 °C (-4 °F to 140 °F)
	Relative Humidity	<ul style="list-style-type: none"> 90% maximum, non-condensing
	Operating Altitude Range	<ul style="list-style-type: none"> 0 to 10,000 feet (0 to 3050 meters)
	Power	<ul style="list-style-type: none"> Full range auto-sensing 100 ~ 240 VAC at 50 Hz ~ 60 Hz 10 Watts
Regulatory Compliance		<ul style="list-style-type: none"> UL, C-UL, TUV FCC Class B, CE mark
Physical Characteristics	Dimension (WxDxH)	<ul style="list-style-type: none"> 194.5 x 151.5 x 40 (mm)
	Weight	<ul style="list-style-type: none"> 0.65 Kg

Terminal Installation

MinIT 6000 Thin Client Terminal

The following pictures provide a front and rear view of your new MinIT 6000 Thin Client Terminal.

Terminal Rear Panel Connectors

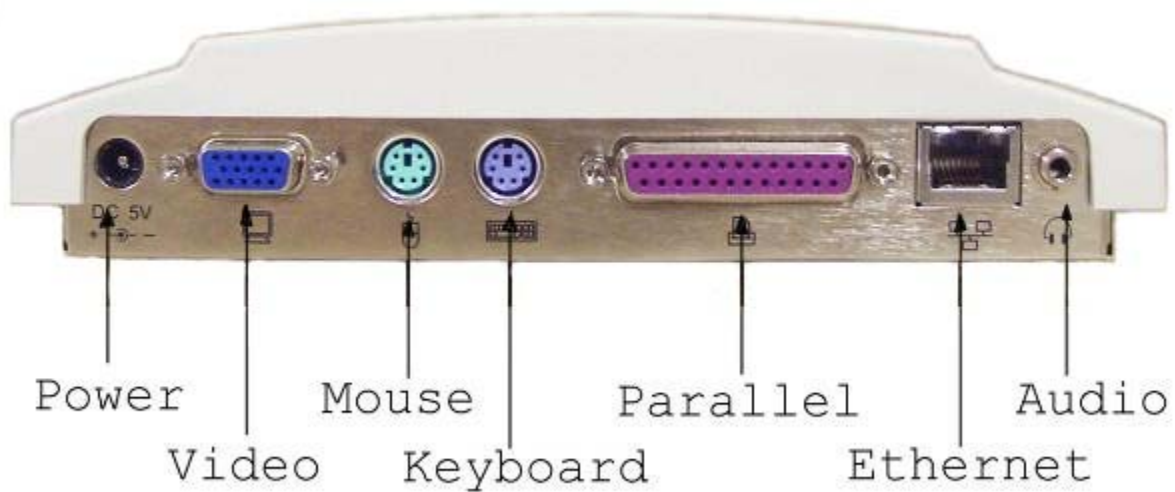

Terminal Front



Basic Hardware Installation

1. Connect the monitor to the VGA connector.
2. Connect the PS/2 keyboard to the Keyboard connector.
3. Connect the PS/2 mouse to the Mouse connector.
4. If you are ready to use a network connection, connect a CAT5 UTP cable to the Ethernet connector.
5. Connect the power adapter cable to the Power connector.
6. Plug the power adapter AC cord into an AC outlet.
7. You are ready to use the Terminal now.

Mounting the Terminal

The terminal can be mounted permanently on a wall. The following figure shows the Terminal mounting procedures.

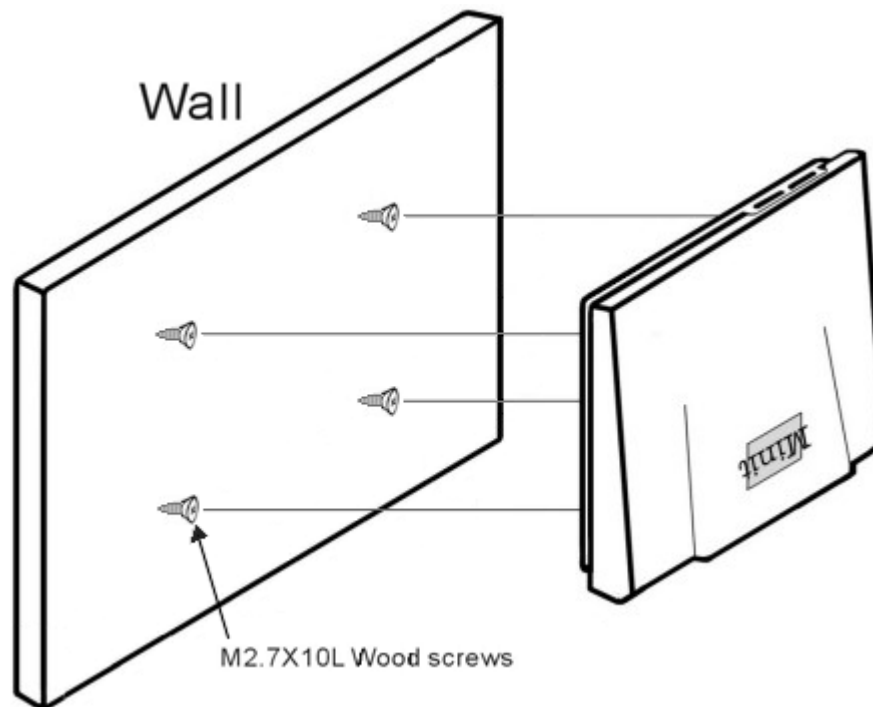

Note: Use a screwdriver to fix this device on the wooden wall with the included four M2.7x10L wood screws.

Using the Terminal

Turn on the terminal when all rear panel connections have been made.

The first dialog box of the Setup Wizard will appear after the terminal's greeting screen. Please refer to the [Setup Wizard](#) to describe the next step of setting up the terminal.

Setup Wizard

About

The Setup Wizard is used for the terminal's initial setup but will also run after resetting the unit back to its factory defaults. To reset the unit back to its defaults, refer to the System section under [Configure Terminal Properties](#).

You can use the Setup Wizard to set the basic terminal network configuration and display parameters however; any of these parameters can be changed later by entering the “Control Panel” and selecting the appropriate icon.

There are several dialog and configuration boxes, as shown below, that you must navigate through to complete the Setup Wizard process.

To display the next dialog box in the sequence:

- Click the Next or Accept buttons

To return to the previous dialog box:

- Click the Back button

To quit and go directly to the Desktop:

- Click the Cancel button

Welcome Window



This dialog box shows product information.

EULA (End User License Agreement)

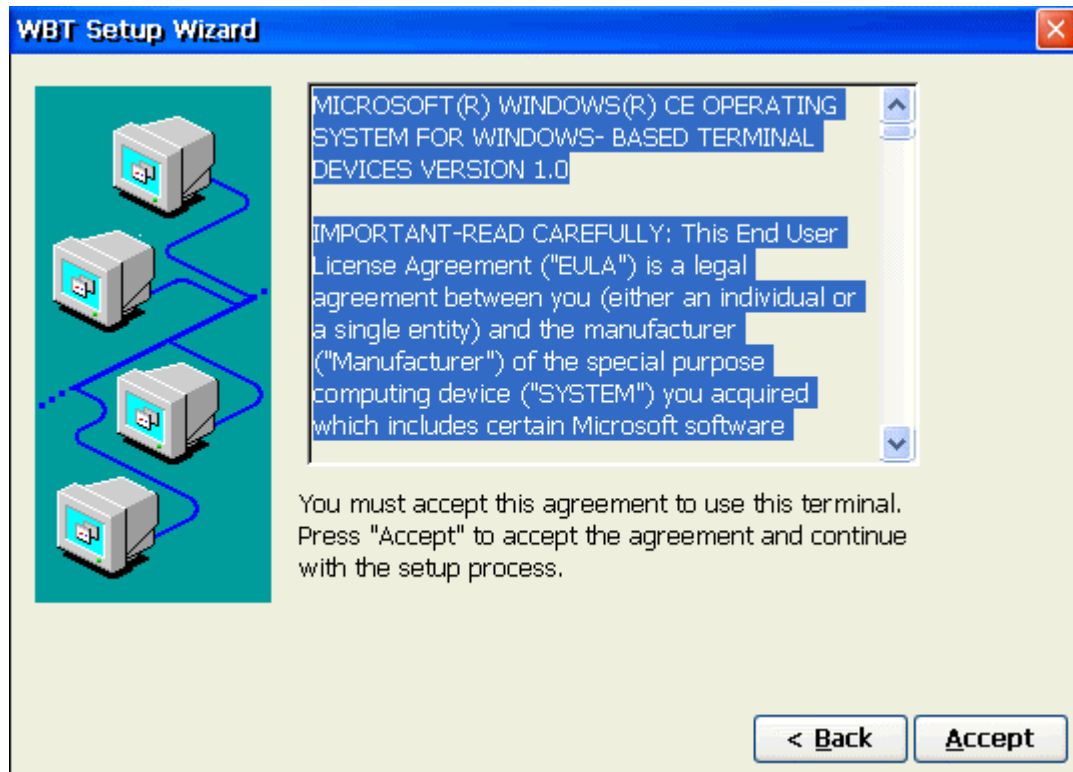

Please read the license agreement carefully.

IP Address

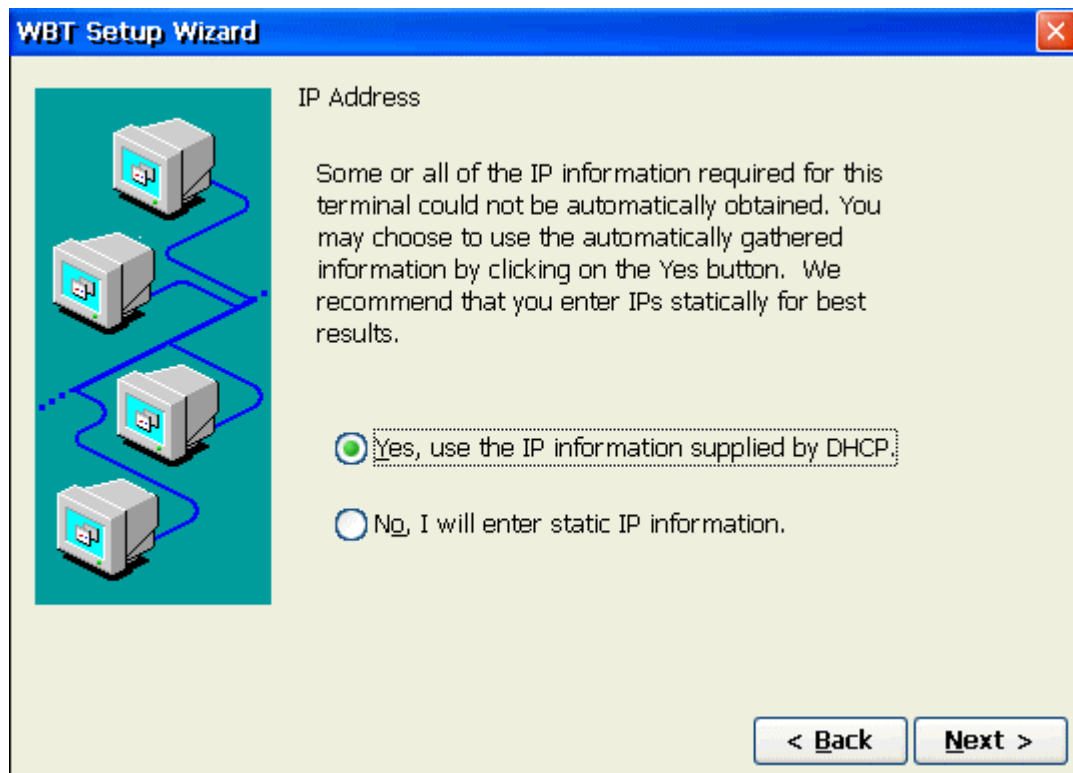

Click Yes, to use the IP information supplied by DHCP server or No (an IP Address and

Optional Information dialog boxes will display in succession) to manually select your static IP information as the default. Selecting Yes will take you directly to the optional Information dialog box will display.

Specify static IP Address

WBT Setup Wizard [X]

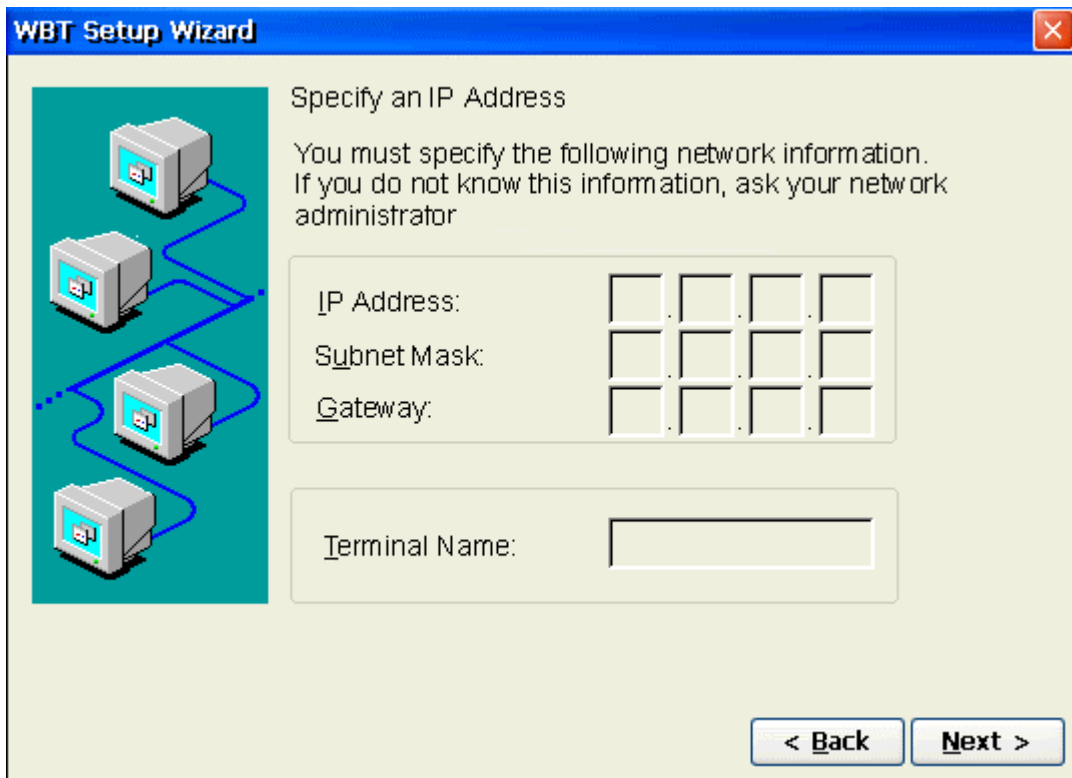

Specify an IP Address

You must specify the following network information. If you do not know this information, ask your network administrator

IP Address: [][][][][]
Subnet Mask: [][][][][]
Gateway: [][][][][]

Terminal Name: []

< Back Next >

Optional Information

WBT Setup Wizard [X]

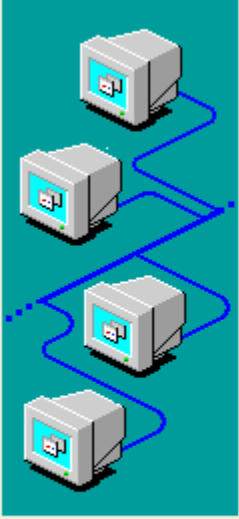

Fill in the following optional information to configure the terminal's name resolution.

Enable DNS
Default Domain Name: []
Primary Server IP: [][][][]
Secondary Server IP: [][][][]

Enable WINS
Primary Server IP: [][][][]
Secondary Server IP: [][][][]

< Back Next >

Display Settings

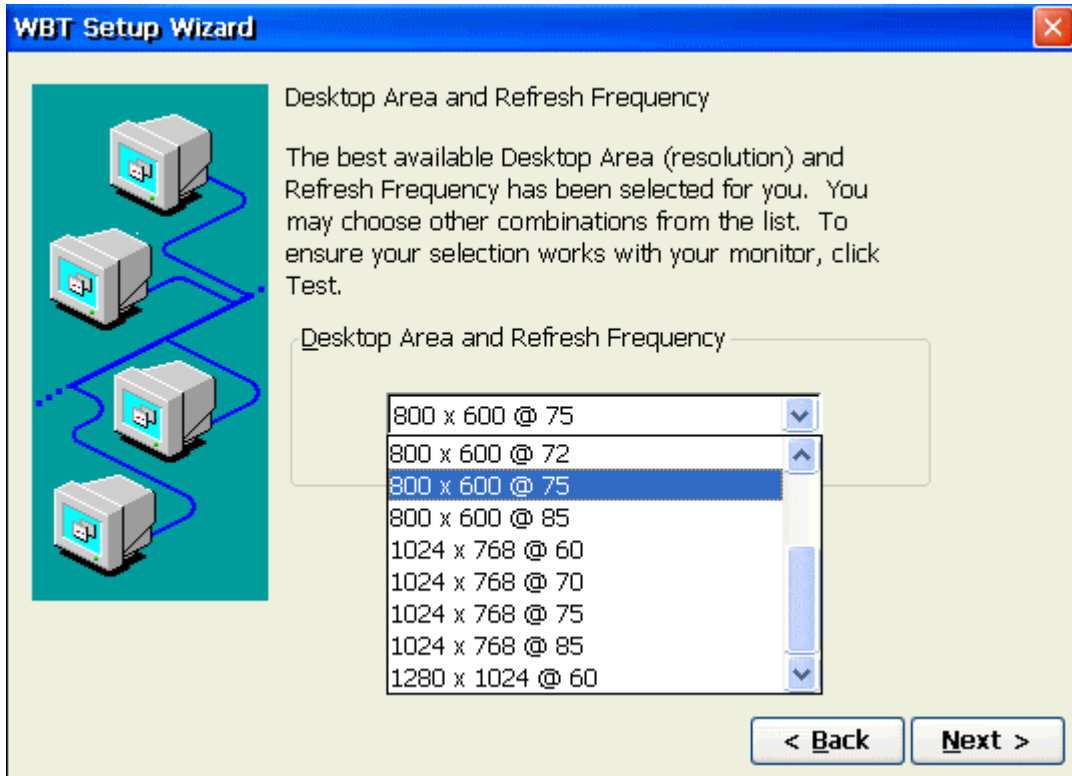

Printer Setup

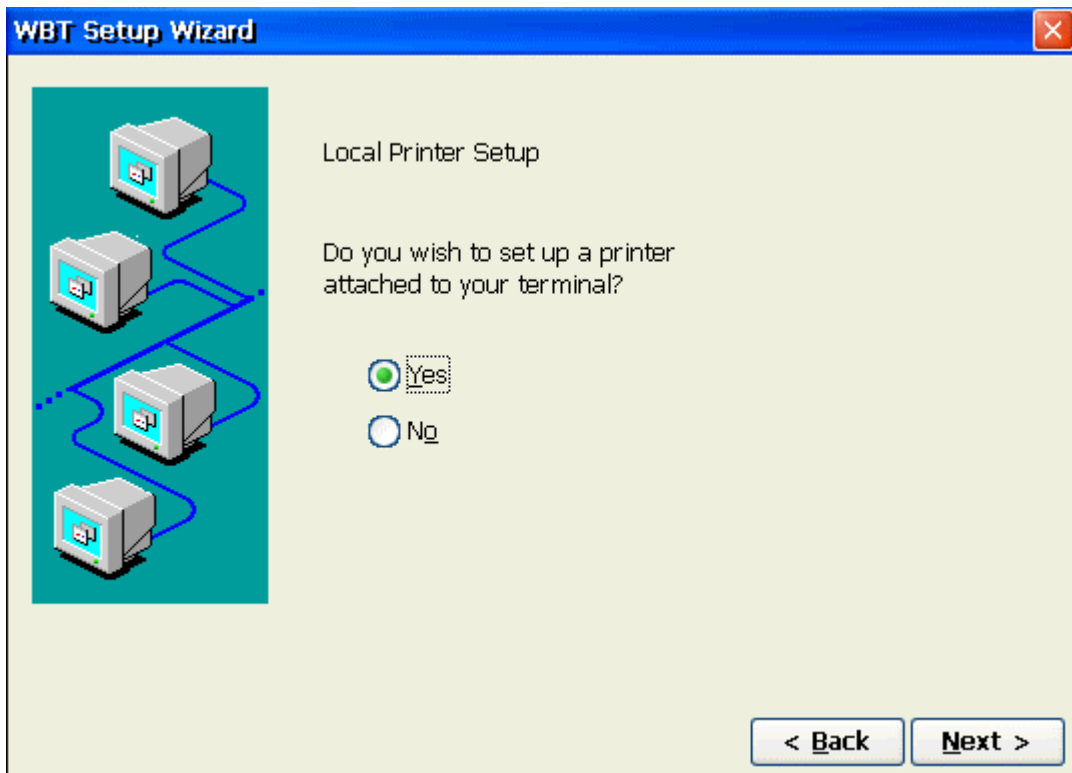

Printer Port

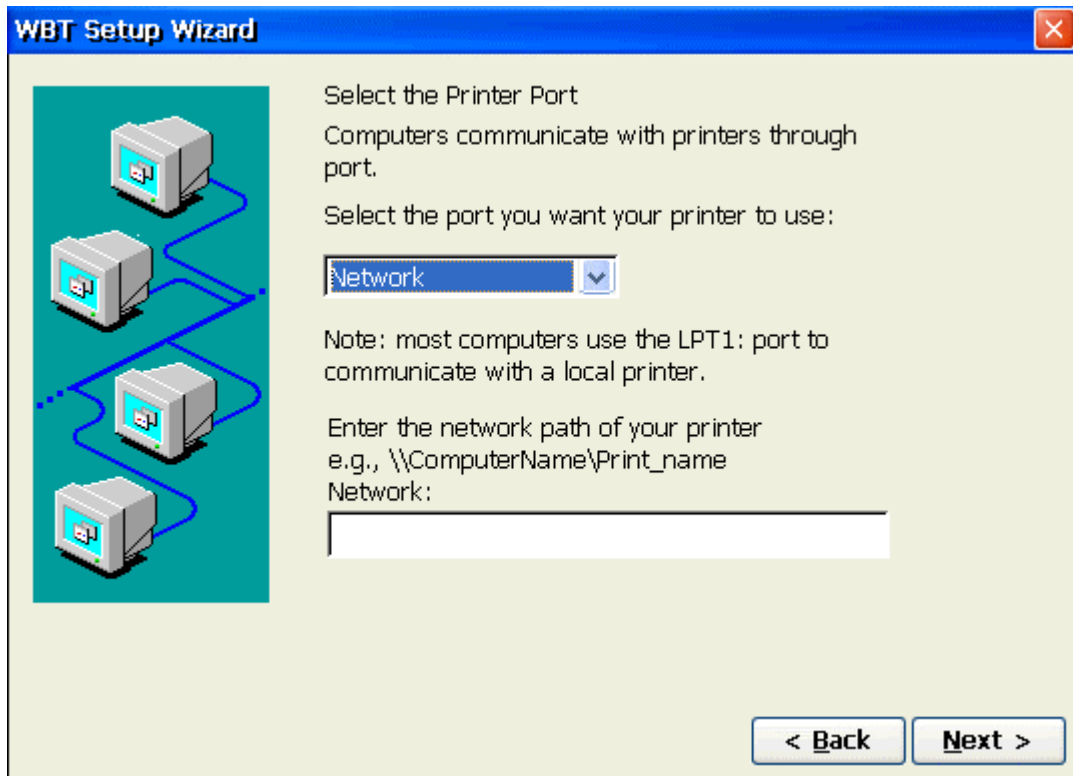

Note: If you select "Network" for your printer port, the "Network" entry box we become available to type in the path information.

Printer Model

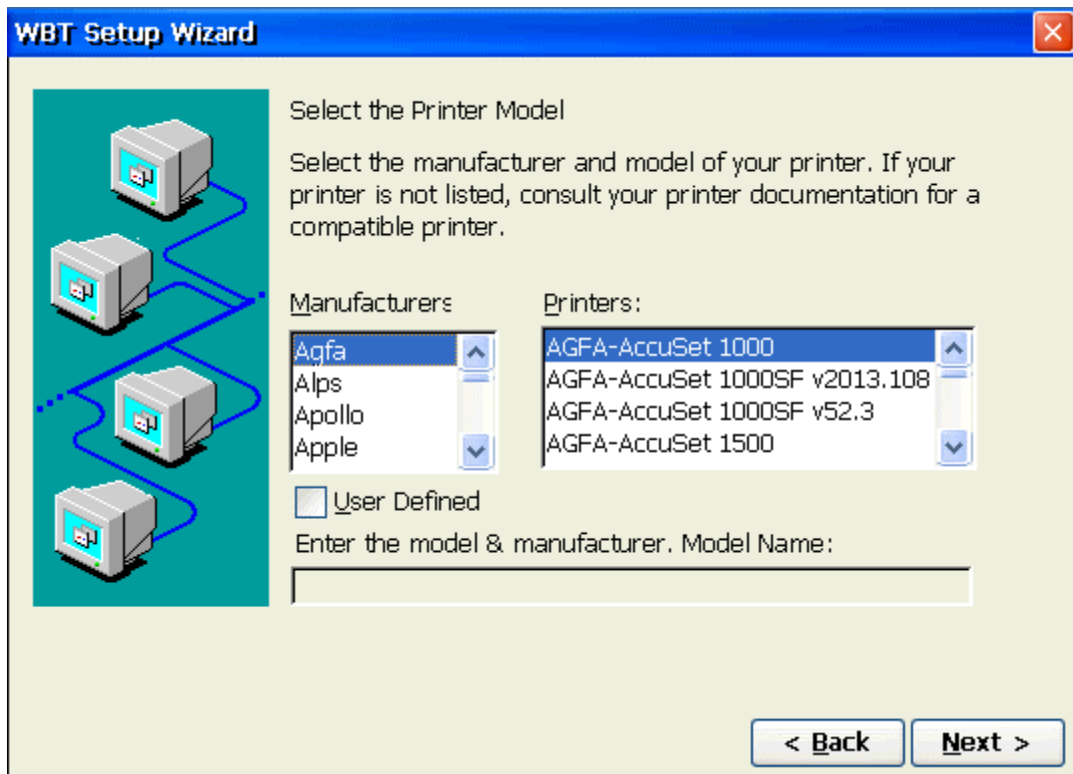

Select the Manufacturer and Model number of your printer.

Printer Name

WBT Setup Wizard [X]

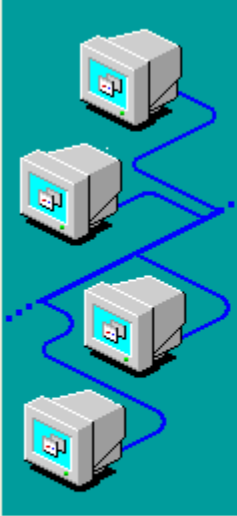

Name Your Printer

You must supply a name for this printer.

Supply a name for this printer. Some programs do not support server and printer name combinations of more than 31 characters.

Printer

HP LaserJet 4V

< Back Next >

Set Printer Default

WBT Setup Wizard [X]

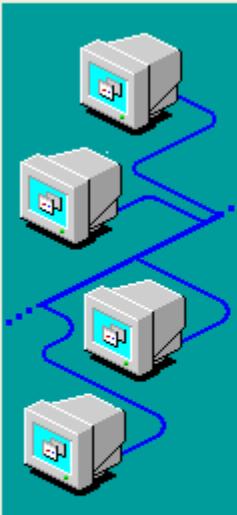

Set Default Printer

Do you want your Windows-based programs to use this printer as the default printer?

Yes

No

< Back Next >

Additional Printers

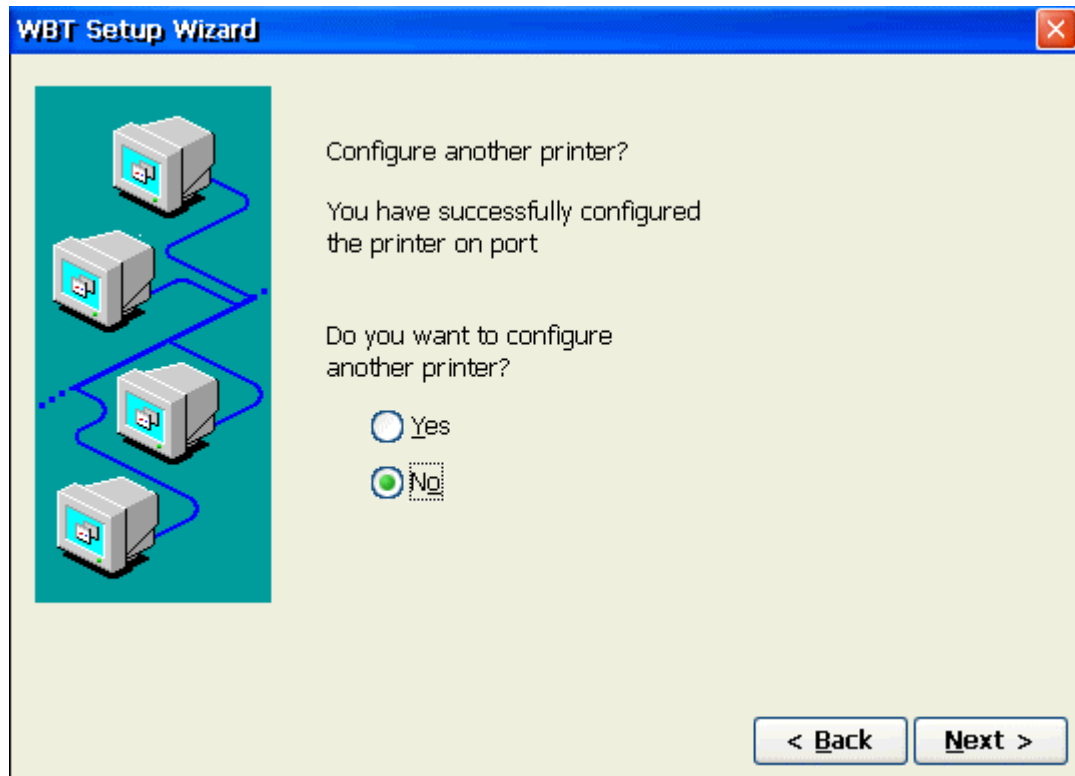

If you select yes, you will be taken back to the “Printer Port” step.

Finish

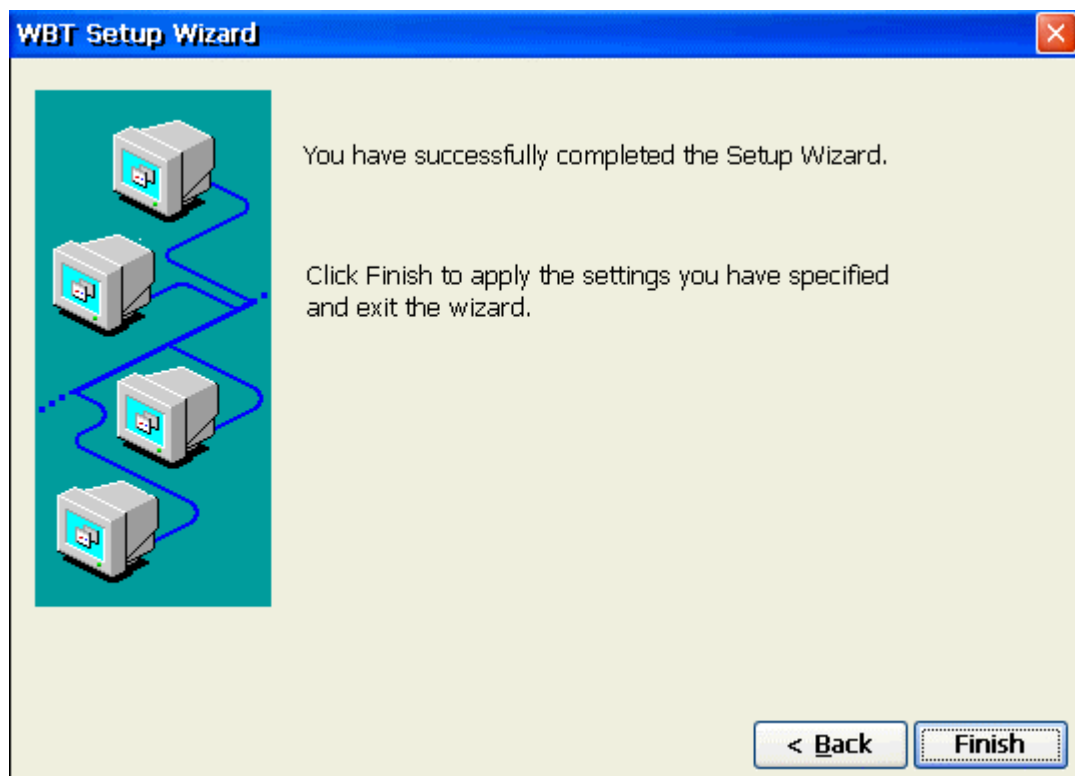

- Click Finish, to apply your selections and quit the Setup Wizard.

Connection Management

Connections Management

From the terminal desktop, click on the **Connection Manager** icon (shown below) to bring up the **Terminal Connection Manager** dialog box.

Connection Manager Desktop Icon



Once the Connection Manager dialog box is open, you can select either Connections or **Configure** dialog box to manage your terminal's network connections.

Connection Manager Desktop Icon

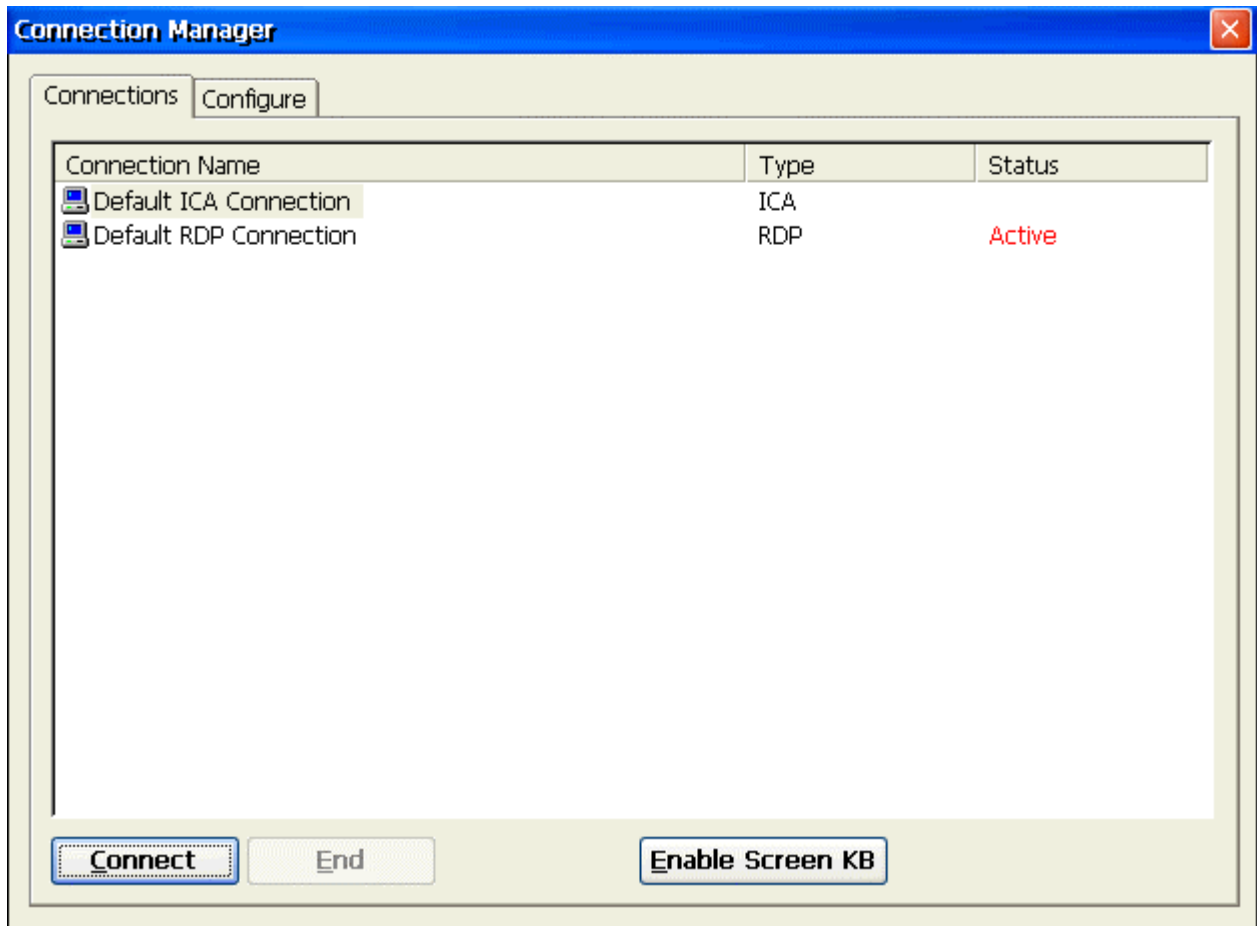

Using the Connections Dialog Box

Use the connection manager to create or edit network connections to a specified server.

Connect

Click on the **Connect** button to make a network connection. You can also double-click on a selected connection in the Connection Name to make a network connection with server.

End

You can click on the End button to end any active connection process listed in status field. The **End** is not available if your session is not active. The **End** button is disabled in the default.

Using the Configure Dialog Box

The functions of the Configure Dialog Box are used to add, modify, delete, and configure connections.

Configure Dialog Box

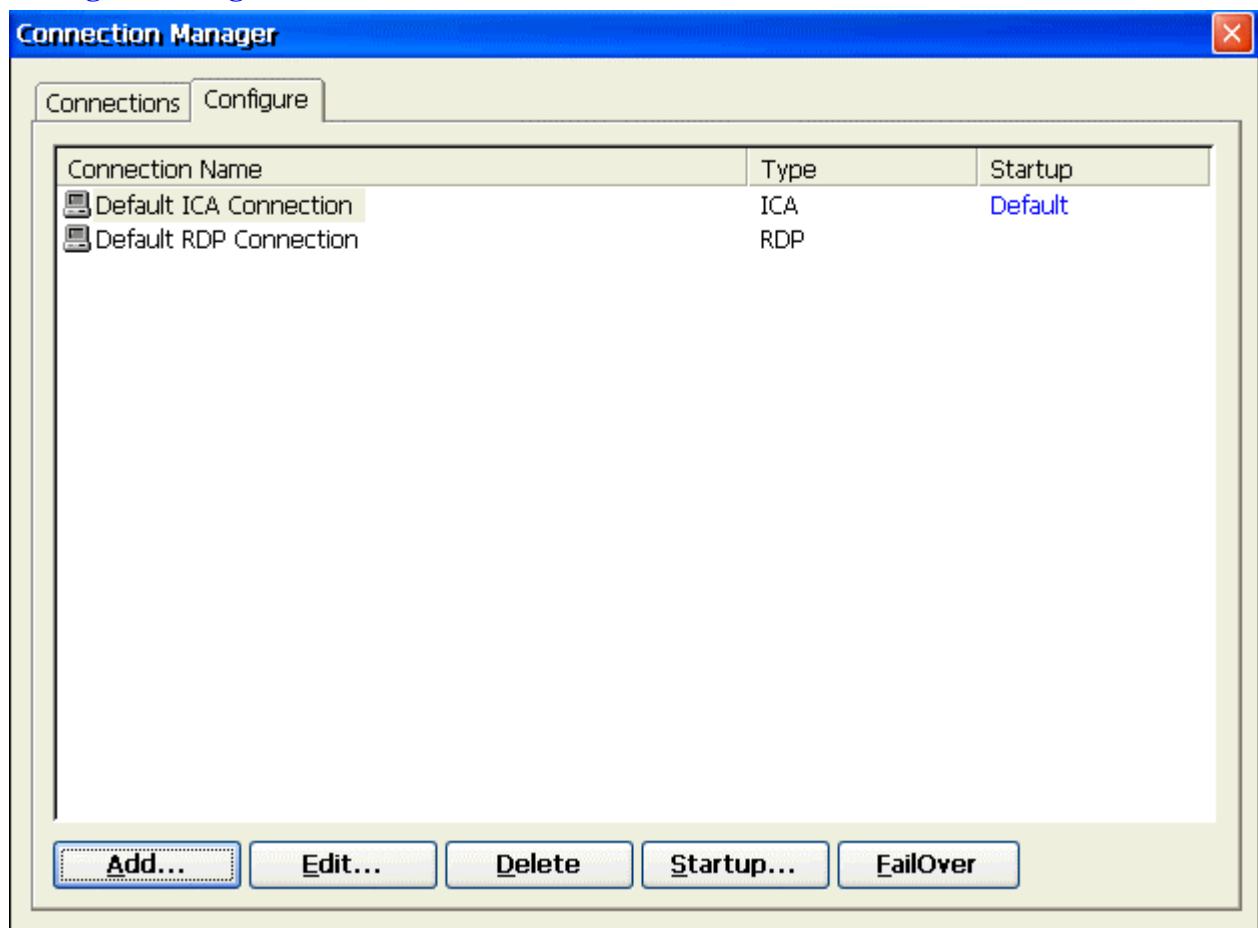

The Configure properties sheet contains four basic functions. The following identifies and describes each of them.

Add

Click on the **Add** button to create a new connection. A new connection dialog box displays, when this button is pressed.

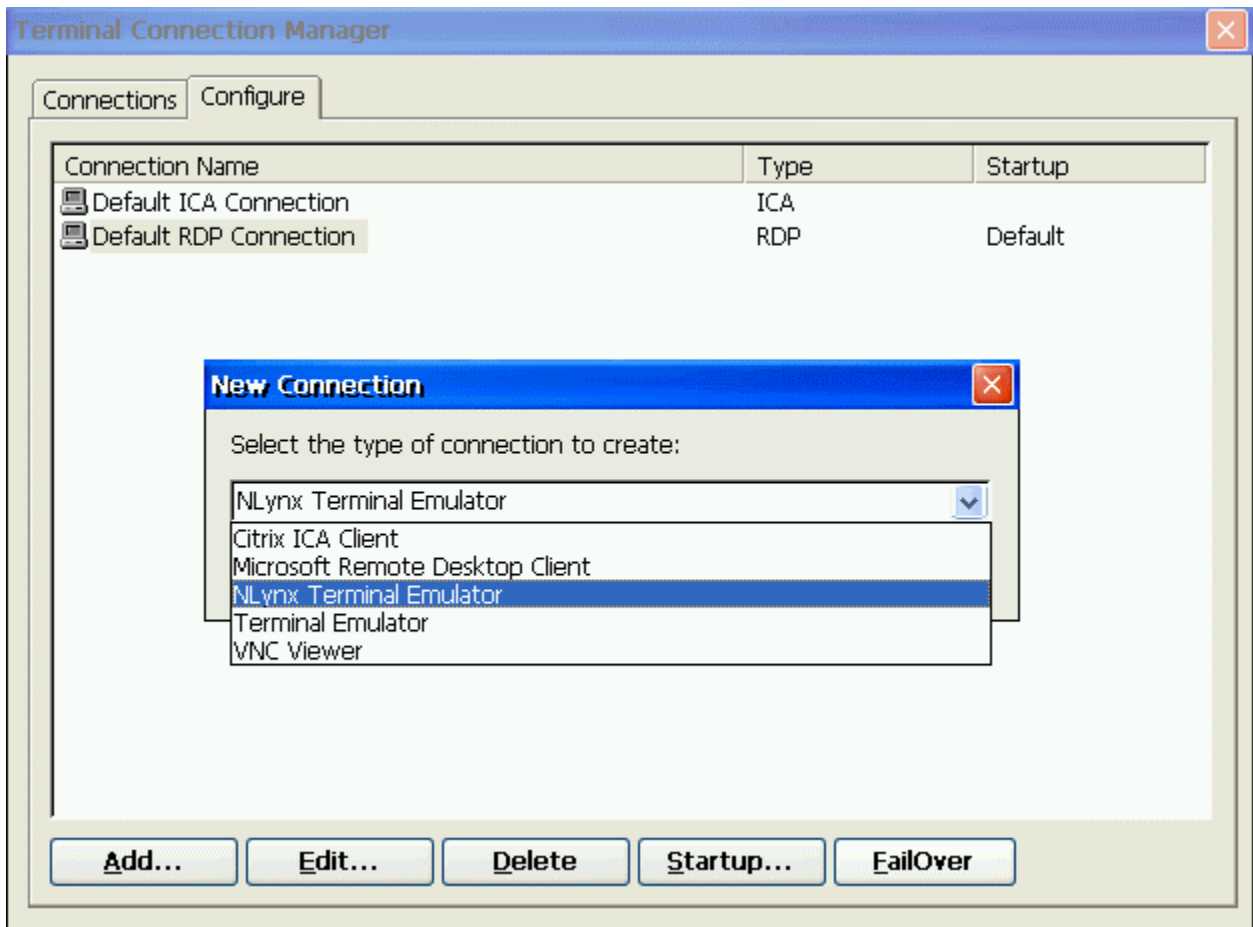

Please refer to the [Creating A New Connection](#) section for more information about adding a different type connection.

Edit

Click on the **Edit** button to edit the properties of a selected connection. Please refer to the [Editing A Connection](#) section for more information about editing a connection.

Delete

Click on the **Delete** button to delete a connection. When you click this button, a “Connection” dialog box displays. Click on the **Yes** button to complete the deletion. Click on the **No** button to cancel the deletion.

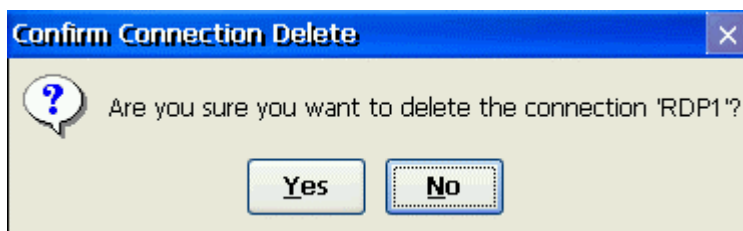

Startup

Click on the **Startup** button to specify which connection option you want to be the default when the terminal first powers up. The **Connection Startup** dialog box displays after the **Startup** button is pressed. Using the **Connection Startup** dialog box, you can pre-set sessions to automatically connect to their servers when terminal is turned on.

Connection Startup Dialog Box

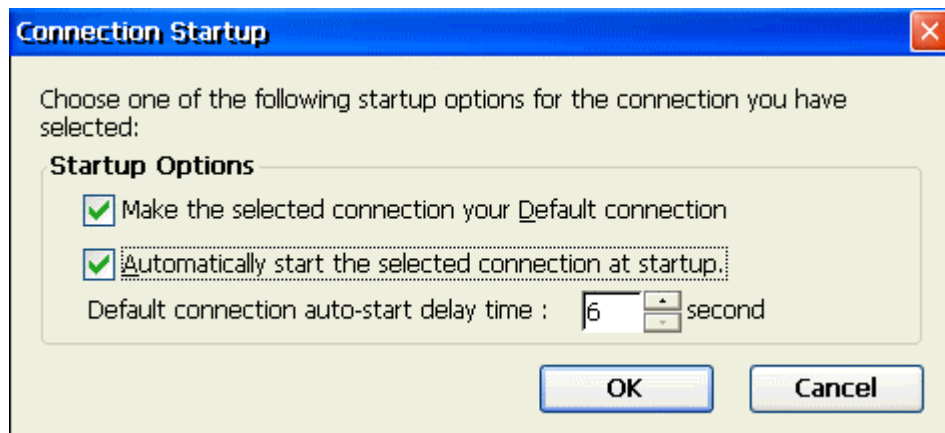

Make the selected connection your default connection.

Enable this function to use the connection you selected in the "Connection Manager" as the default connection.

Automatically start the selected connection at startup.

Enable this function to automatically start the connection you selected in the "Connection Manager" when the terminal is turned on.

Default connection auto-start delay time:

Allows the user to adjust the auto-start delay time by changing the value. This might be important in some networks because it allows the unit enough time to obtain DHCP information from the DHCP server (if set for) before it tries to connect to the host.

OK

Click on **OK** to quit the dialog box and save the changes.

Cancel

Click on **Cancel** to quit the dialog box without any change.

Creating a new Connection

Creating A New Connection

The New Connection dialog box, as follows, allow user to create new network connections.

New Connection Dialog Box

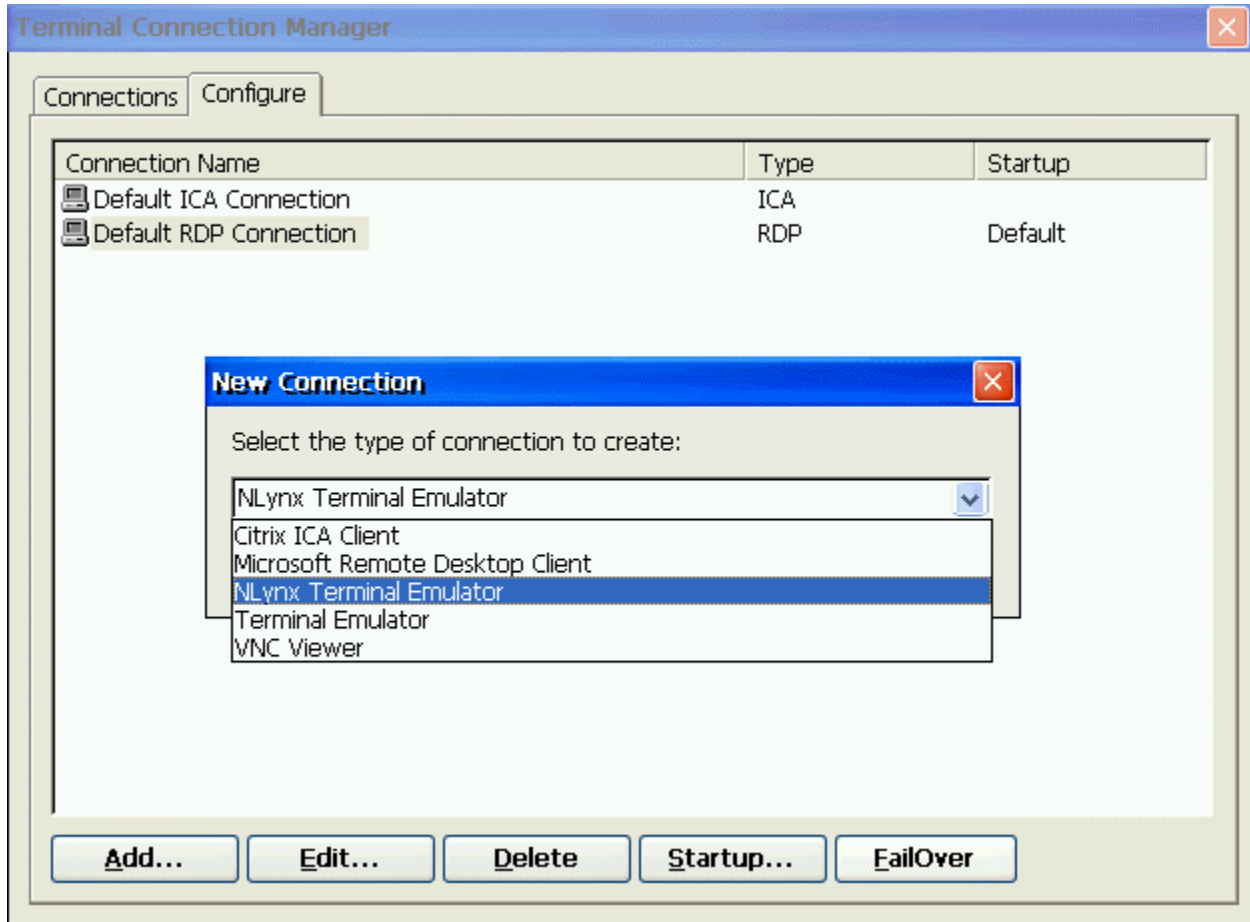

Choosing a Connection Protocol

From the pull-down list bar in the dialog box, you can select the type of connection protocol you want to use to connect to a server. The selections available are found in the pull down list. Click the **OK** button, when you have made your selection.

- Citrix ICA Client for Windows CE

The ICA (Independent Computing Architecture) client is used to connect to a Citrix ICA Winframe or Metaframe server. If you select the Citrix ICA Client for Windows CE, the "Specify Connection Type" dialog box displays. Using the sequence of dialog boxes, you can create an ICA connection. Please refer to "[Create an ICA Connection](#)" for more information.

- Microsoft Remote Desktop Client

The RDP (Remote Desktop Protocol) client is used to connect to a TSE (Windows NT Terminal Server Edition) server. If you select the RDP client, the Connection Wizard displays. Using the wizard, you can create a RDP connection. Please refer to "[Create a RDP Connection](#)" for more information.

- Terminal Emulation

The Terminal Emulation client allows you to connect to a variety of host computers such as an IBM Mainframe or AS/400 using protocols such as 3270, 5250, and Telnet. If you select the Terminal Emulation, the "Connection Properties" dialog box displays. Using the dialog box, you can create a specific terminal emulator. Please refer to the [Text Terminal Emulator User Manual](#) for more information.

- VNC Viewer

The VNC (Virtual Network Computing) viewer client allows you to connect to a VNC server. This allows you to view and interact with the one computer (the "server") located anywhere on the internet (provided your local network has the appropriate internet connection).

Create a RDP Connection

You can use the [WTS Connection Wizard](#) to create a new RDP connection. Click the **Next** button to display the next dialog box in the sequence. Click the **Back** button to return to the previous dialog box. Click the **Cancel** button to quit this dialog box at any time. When you are finished, a new connection will be added to the Connection Name list in the [Terminal Connection Manager](#).

There are four dialog boxes, as below, for the [WTS Connection Wizard](#) process.

WTS Connection Wizard

Type a name for the new connection.
Name:

Type the name of the computer to which you want to connect.
Server:

< Back Next >

Type in the name that you want to refer to this RDP connection by and then type in the name or IP address of the Server that you want to connect to.

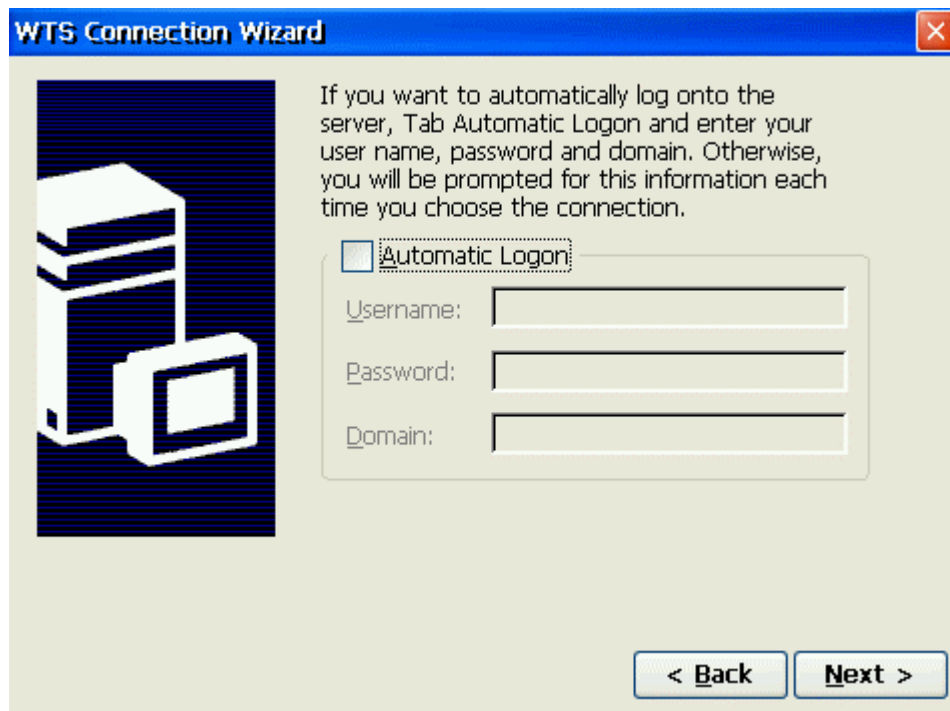

Unless you want to enter them every time you start the RDP connection, click on the **Automatic Logon** check box and specify the logon Information by typing in the **Username**, **Password** and **Domain**.

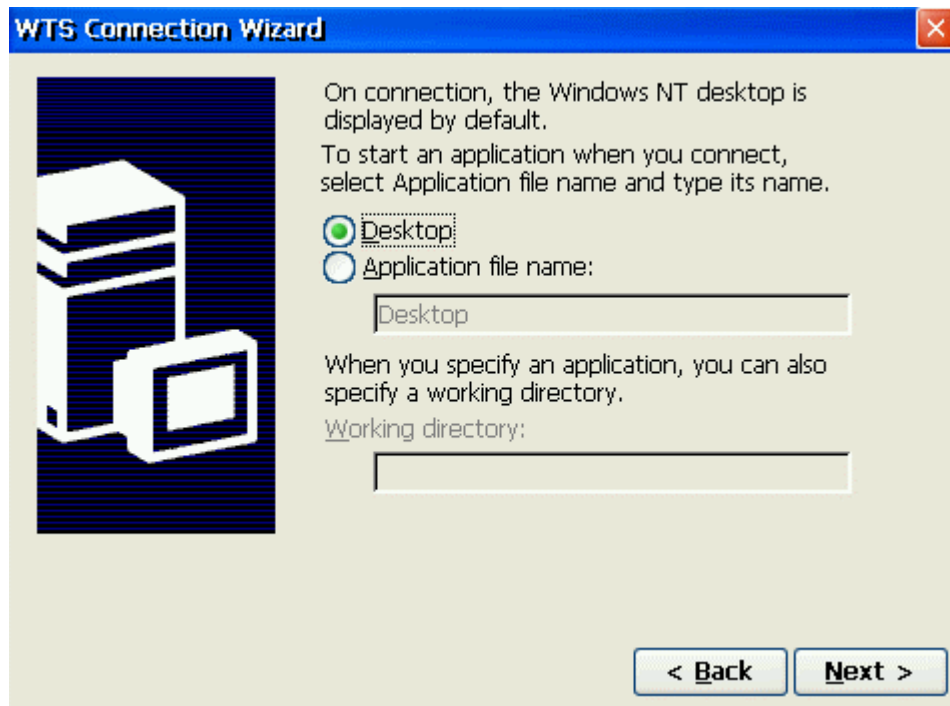

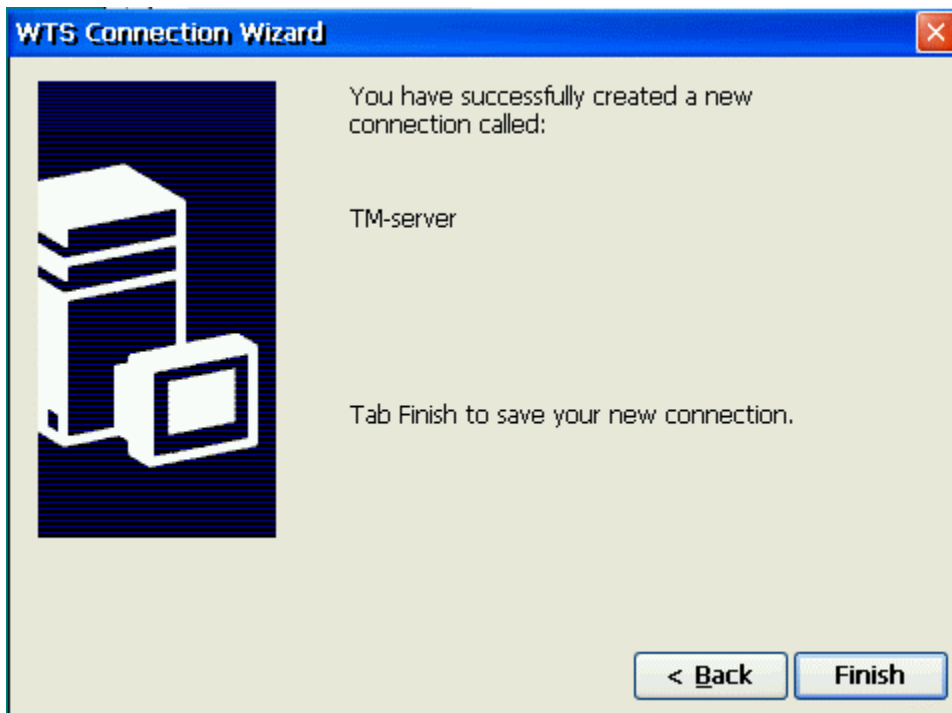

Create an ICA Connection

You can configure and run two types of ICA sessions: Citrix server connections and published applications.

- *Citrix server connections* allow you to connect to the Windows desktop of a specific Citrix server; you can run any applications available on the desktop, in any order.
- *Published applications* are specific applications set up by an administrator for remote users to run. When connected, you are presented with the application itself.

Note This procedure describes the simplest way to create a connection entry. When you follow these steps, you set the essential items you need to connect to a Citrix server from the Windows CE device, See "Changing a Connection Entry" for more information about how to change the other properties for a connection entry.

Note This section provides basic introduction regarding how to create an ICA connection for both network and dial-in. If you want to know more detail information about ICA operation and features, please refer to the ["Citrix ICA Administrator's Guide"](#).

To create a new connection entry

1. In the Connection **Manager** dialog box, click the **Configure** tab.
2. Click the **Add** button.
3. In the **New Connection** dialog box, click **Citrix ICA Client** in the type of connection list. Click **OK**.
4. The **Specify Connection Type** dialog box appears:



Click **Network Connection** to make a network connection. Make sure your client device is connected to the network through the Ethernet connector. Click **Next** to continue. Skip to Step 6.

—or—

Click **Dial-In Connection** to make a dial-in connection. Make sure your modem is installed and properly configured. Click **Next** to continue.

Note :The ICA Windows CE Client does not support modem callback.

5. The **Dial-In Devices** page appears:

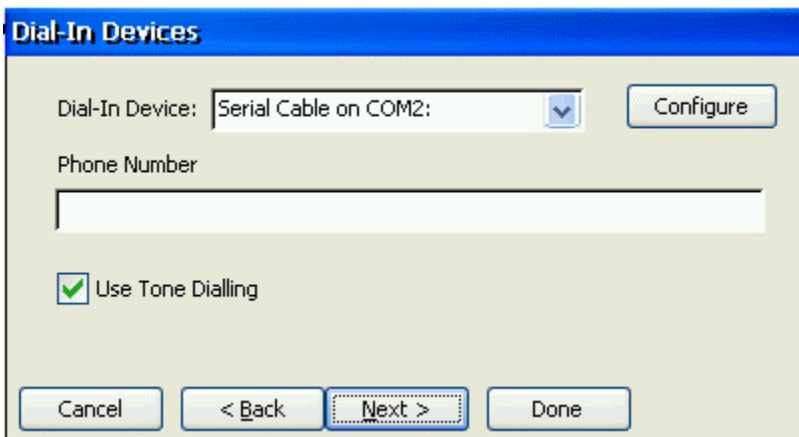

From the pull-down list, select your modem. In the **Phone Number** box, type the phone number of the Citrix server including the area code and country code if required. Click **Next** to continue. Skip to Step 9.

6. The **Select a Metaframe Server or Published Application** page appears:

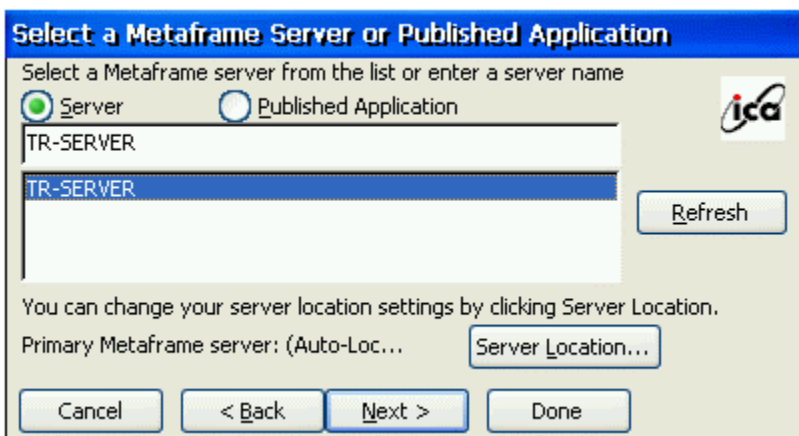

7. Click **Server** to connect to a server or **Published Application** to connect to a published application. You can click **Refresh** button to refresh the Citrix server on the network, then select the server which you want to connect to.

If your CE device is not on the same network as the Citrix server which you would like to connect to, the server name will not appear in the list (this would occur if you are on the other side of a router, across the Internet, or using RAS to connect to a remote network containing Citrix servers). In this case, click **Server Location** and go to the next step. Otherwise, scroll through the list and select the Citrix server or published application or type the name of the Citrix server or published application in the edit field. Click **Next**.

8. The Server **Location** dialog box appears:

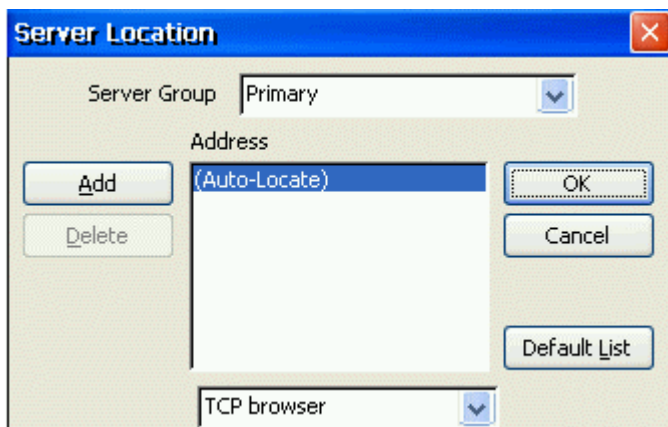

Remote Application Manager uses the information entered in the **Server Location** screen to help locate available Citrix servers and published applications.

If:

- you are on another network (for example, if you are on the other side of a router, across the Internet, or connected by RAS), click **Add** to enter the IP address or DNS name of a Citrix server on the network that contains the Citrix server you would like to connect to. The Windows CE client uses this server to locate the list of available Citrix servers on the network.
- your network configuration cannot propagate UDP traffic (for example, if your firewall restricts UDP broadcasts), please select **TCP + HTTP browser** or **SSL/TLS + HTTPS browser**. Make sure that the list contains the IP address or name of a Citrix server on the network that contains the Citrix server you would like to connect to. The Windows CE client uses this server to locate the list of available Citrix servers on the network.

Note: When you first select **TCP + HTTP browser**, the convention used for the default server name is *ica.domainname* where *domainname* is your TCP/IP domain name. You can change this to a specific server name/IP address or leave the default setting and map the name of a server to *ica.domainname*. Note that TCP/IP+HTTP server location uses a TCP connection so does not support the **(Auto-Locate)** function.

Click **OK** and then click **Next**.

10. The Select a Title for the ICA Connection page appears:

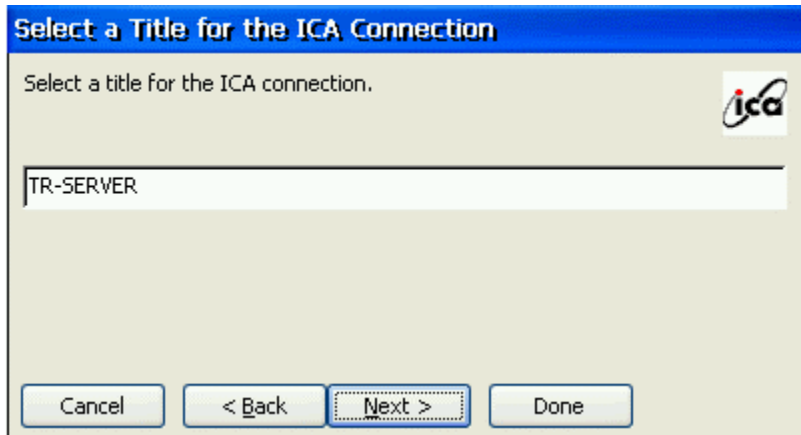

Enter a name for the connection entry. The name you choose is the name of the entry in the list of connections in Connection Manager. Click **Next** to continue.

11. The **Specify an Application** screen appears (this screen does not appear when configuring a published application connection):

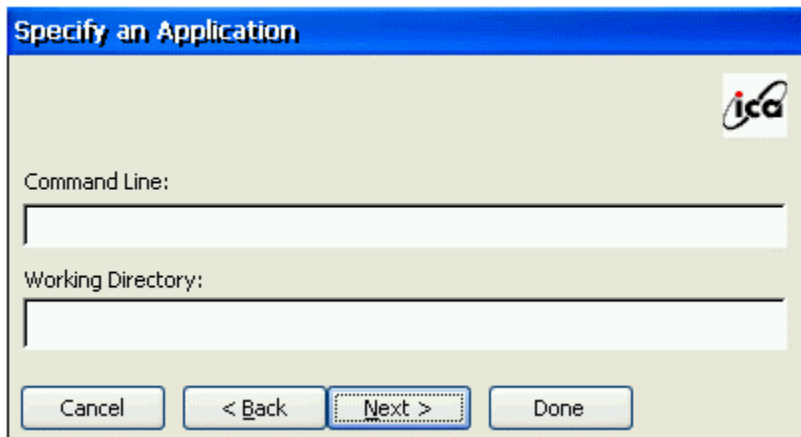

In the Command Line field, enter the path and name of an application to run on the server once the logon to the Citrix server is successful. Leave this field blank to run a Windows NT desktop on the Citrix server. Working Directory lets you associate a directory with the application specified in the Command Line field. Enter the drive and path of the working directory in the Working Directory field.

For example, if the application Notepad.exe is in the C:\WTSRV directory on the Citrix server, type C:\WTSRV\Notepad.exe in the Command Line field. If you use Notepad to work on documents in the C:\My Documents directory, type C:\My Documents in the Working Directory field. When you log on to the Citrix server, Notepad begins. In Notepad, if you click the File menu, the directory C:\My Documents is displayed. Click **Next** to continue.

11. The **Specify Logon Information** screen appears:

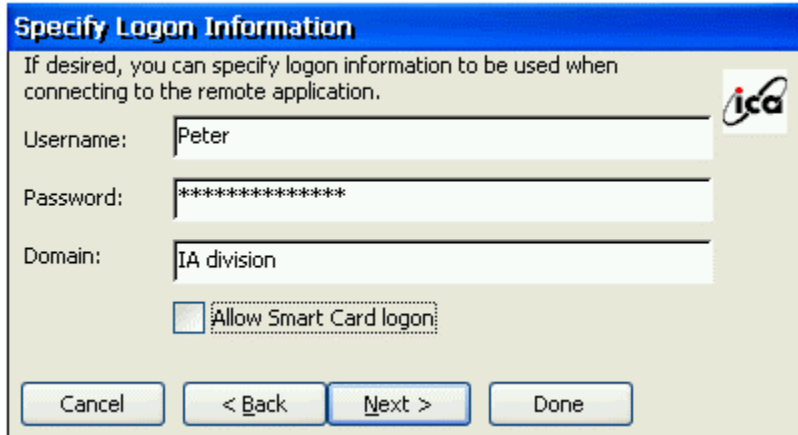

The dialog box titled "Specify Logon Information" has a blue header bar. Below the header, it contains the text: "If desired, you can specify logon information to be used when connecting to the remote application." To the right of this text is the ICA logo. There are three text input fields: "Username:" with the value "Peter", "Password:" with a masked password "*****", and "Domain:" with the value "IA division". Below these fields is a checkbox labeled "Allow Smart Card logon:" which is currently unchecked. At the bottom of the dialog are four buttons: "Cancel", "< Back", "Next >", and "Done".

Type a valid username, domain, and password. If you leave these fields blank, you are prompted for your username, domain, and password when the ICA Windows CE Client connects to the Citrix server. Click **Next** to continue.

12. The Select Window Options screen appears:

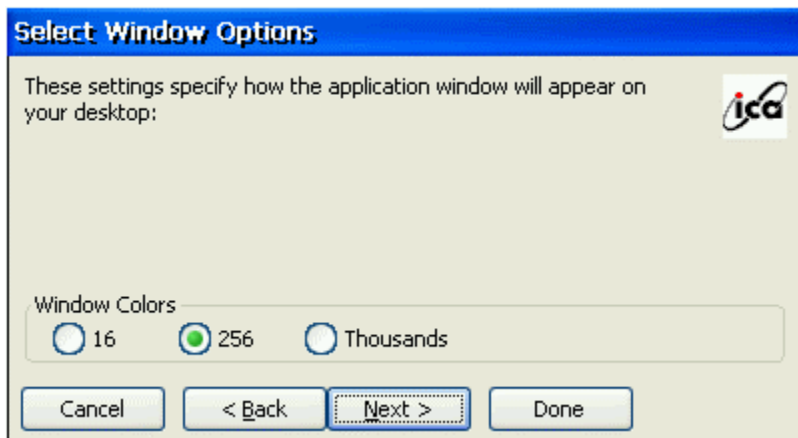

The dialog box titled "Select Window Options" has a blue header bar. Below the header, it contains the text: "These settings specify how the application window will appear on your desktop:" To the right of this text is the ICA logo. Below this text is a section labeled "Window Colors" with three radio button options: "16", "256" (which is selected), and "Thousands". At the bottom of the dialog are four buttons: "Cancel", "< Back", "Next >", and "Done".

In the Window Colors field, you can set the number of colors used for the ICA Client window. There is three ratio buttons, 16, 256 and Thousands. You can select one of them and Click **Next** to continue.

13. The Compression, Encryption, and Sound screen appears:

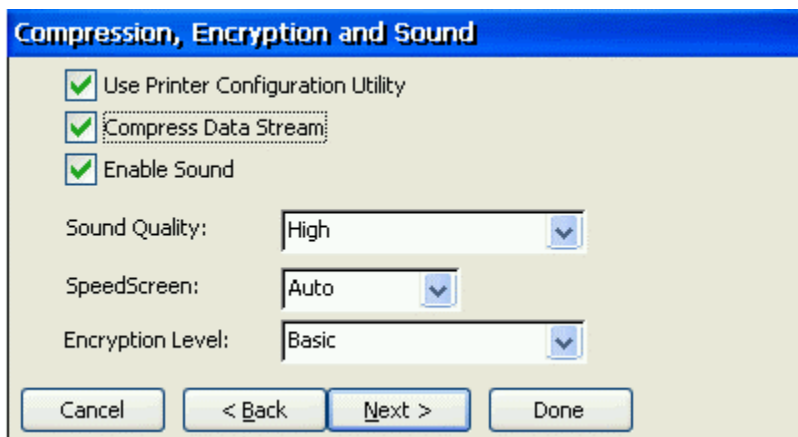

The dialog box titled "Compression, Encryption and Sound" has a blue header bar. Below the header, there are three checked checkboxes: "Use Printer Configuration Utility", "Compress Data Stream", and "Enable Sound". Below these checkboxes are three dropdown menus: "Sound Quality:" set to "High", "SpeedScreen:" set to "Auto", and "Encryption Level:" set to "Basic". At the bottom of the dialog are four buttons: "Cancel", "< Back", "Next >", and "Done".

- Click **Use Printer Configuration Utility** to enable printer auto configuration.
- Click **Compress Data Stream** to reduce the amount of data transferred between the ICA Windows CE Client and the Citrix server hosting the session. (If your connection is bandwidth-limited, enabling compression may increase performance. If your client device is on a high-speed LAN, you may not need compression.)
- Click **Enable Sound** to enable sound support. Remote applications will be able to play sounds on your client. From the pull-down list, select a sound presentation quality level. High provides the greatest audio quality but should only be used when bandwidth consumption is not a concern. Medium results in less bandwidth consumption than when using High. Compression of sound data provides greater bandwidth efficiency but reduces sound quality somewhat. This value is recommended for most LAN-based connections. Low offers the most efficient use of bandwidth but also decreases sound quality severely. This value is recommended for low-bandwidth connections, including most modem connections.

Speed Screen - SpeedScreen latency reduction improves responsiveness over high latency connections by providing feedback to the user in response to typed data or mouse clicks.

Note SpeedScreen will only work if the server-side SpeedScreen feature is available has been enabled on the Citrix server to which you are connecting.

To change SpeedScreen latency reduction settings

1. In **Connection Manager** dialog box, select the connection entry that you want to change.
2. Click the **Options** tab.
3. In the **SpeedScreen** field, select the setting (**On**, **Off** or **Auto**) you need.
 - For slower connections (for example, if you are connecting over a WAN or a dial-in connection), set mode to **On** to decrease the delay between user input and screen display.
 - For faster connections (for example, if you are connecting over a LAN), set mode to **Off**.
 - If you are not certain of the connection speed, set the mode to **Auto** to turn SpeedScreen latency reduction on or off automatically depending on the latency of the connection.

Encryption Level - Encryption increases the security of your ICA connection. By default, basic encryption is enabled on all connections. If the Citrix server you are connecting to supports advanced encryption (e.g., SecureICA services), you can use it to improve security.

To change the encryption settings for an ICA connection

4. In Connection Manager dialog box, select the connection entry you want to configure.
5. In the Properties tab, click Options.

6. Click Encryption and select the level of encryption you want to use. The default level is Basic. Select RC5 128-bit Login Only to use encryption only during authentication.

The Citrix server must be configured to allow the selected encryption level or greater. For example, if the Citrix server is configured to allow RC5 56-bit connections, the ICA client can connect with RC5 56 or 128-bit encryption.

Note To use advanced encryption, you need to install SecureICA on your Citrix server. The Citrix server must also be configured to allow the selected encryption level or greater.

Click **Next** to continue.

14. The **Firewall Settings** screen appears:

The screenshot shows the 'Firewall Settings' dialog box. It has a blue title bar with the text 'Firewall Settings'. The dialog is divided into two main sections: 'Proxy' and 'SSL/TLS Relay'.
In the 'Proxy' section, there is a dropdown menu with 'none (direct)' selected. Below it is a note: 'NOTE: Enable SSL or 128-bit encryption to assure a secure connection'. There are two input fields: 'Proxy address' and 'Port', with '1080' entered in the Port field.
In the 'SSL/TLS Relay' section, there are two input fields: 'Address of relay' and 'Port', with '443' entered in the Port field. Below these is a checkbox labeled 'Use alternate address through firewalls', which is currently unchecked.
At the bottom of the dialog, there are three buttons: 'Cancel', '< Back', and 'Done'.

In the **Firewall Settings** dialog box, you can configure the client to use a SOCKS proxy and alternate address remapping.

15. Click **Finish** to save the entry or Cancel to exit the new connection entry dialog box without saving the entry.

Once you have created a connection entry, the name appears in the list of connections in Connection Manager.

Editing a Connection

Editing a Connection

The **Edit** button on Configure Dialog Box allows the user to edit or modify the properties of selected connection.

Editing a RDP Connection

There are two properties sheets on the Properties dialog box. Depending on your connection configuration, you can use these two properties sheets to edit connection parameters.

Net Connections Tab

The screenshot shows a Windows-style dialog box titled "Edit Connection" with "OK" and "X" buttons in the top right corner. It has two tabs: "General" and "Programs". The "General" tab is selected. The dialog is divided into three sections:

- Connection:** Contains two text input fields. The first is labeled "Name:" and contains the text "RDP1". The second is labeled "Server:" and contains the IP address "192.168.1.55".
- Automatic Logon:** Starts with an unchecked checkbox labeled "Automatic Logon:". Below it are three text input fields labeled "Username:", "Password:", and "Domain:", all of which are currently empty.
- Connection Speed:** Contains a checked checkbox labeled "Low Speed Connection".

Name

This field displays a connection name listed in the Terminal Connection Manager. Enter the name in this field and click **OK** button, you can change and save the connection name of the selected server.

Server

This field displays the IP address or server name of the selected server.

Automatic Logon

Click this toggle button to enable/disable automatic logon. The Username, Password and Domain fields will be enabled when the Automatic Logon is checked.

Username

Enter your user name for Automatic Logon check.

Password

Enter your password for Automatic Logon check.

Domain

Enter your domain for Automatic Logon check.

OK

Click on **OK** button to save your changes and quit the dialog box

Cancel

Click on **Cancel** button to quit the dialog box without any change.

Apply

Click on **Apply** button to use the changes.

Application Tab

Using the Application Properties Sheet, you can designate an application program on the server to run automatically when the connection is made.

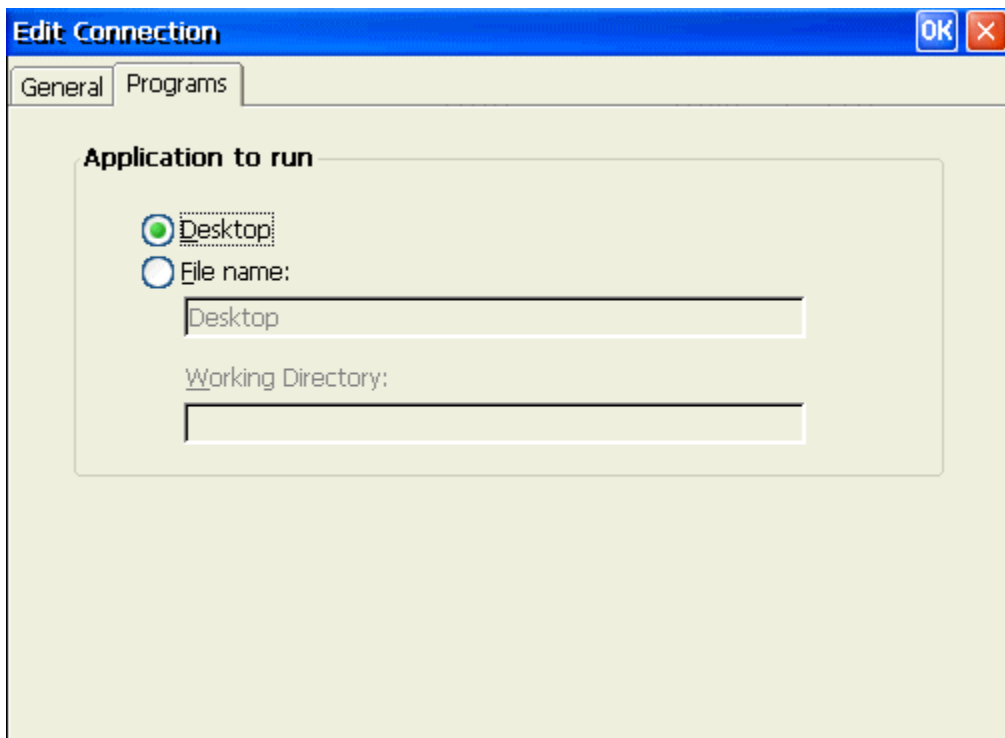

Desktop

Click on **Desktop** button to select a desktop application to run.

File Name

Click on **File name** button to select a file to run. Enter the file name of the application in the field provided.

Working Directory

Enter the directory path of the application file provided in **File Name**.

OK

Click on **OK** button to save your changes and quit the dialog box

Cancel

Click on **Cancel** button to quit the dialog box without any change.

Apply

Click on **Apply** button to use the changes.

Editing an ICA Connection

There are seven dialog boxes that display in succession during the editing process. Please follow the instructions on the screen to complete all fields editing step by step. (Note: For more detail introduction, please refer to the [ICA Administrator's Guide.pdf](#))

To change the properties of a connection entry

1. In the Connection Manager dialog box, click the Configure tab.
2. Click the name of the connection entry that you want to change.
3. Click **Edit** to display the **Edit Connection Details** dialog box.

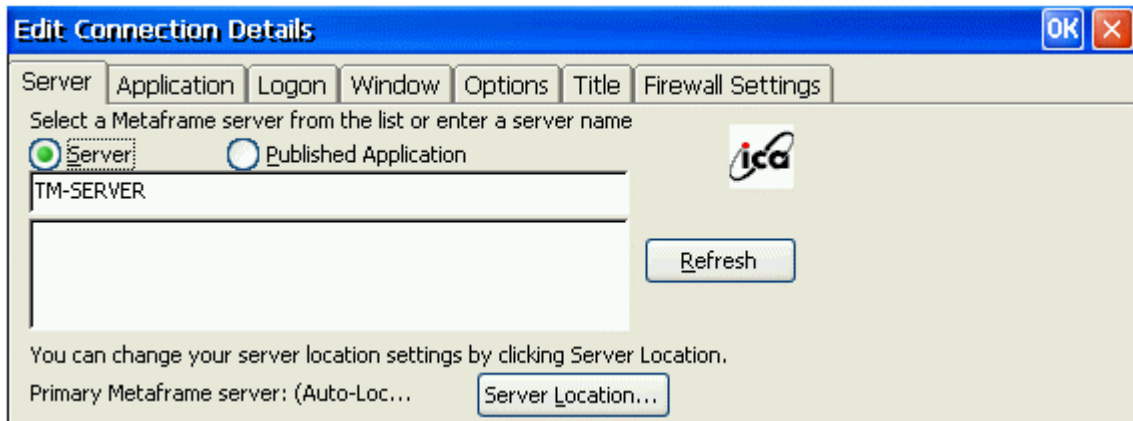

4. Make the desired changes.
5. Click OK to save your changes.

The **Edit Connection Details** dialog box contains the following tabs:

- The **Server** tab (network connection entries only), where you can set the server or published application name to which to connect. There is also a button to display the **Server Location** dialog box where you can set Business Recovery options.

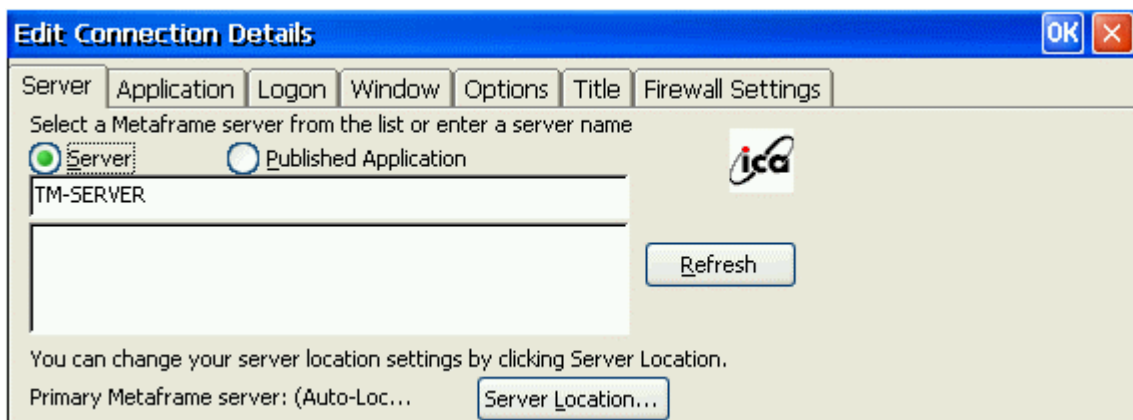

- The **Dial-in** tab (dial-in connection entries only), where you can set the area code, country code, and telephone number to dial. You can use the settings on this page in the same way as when you first set up the connection entry.

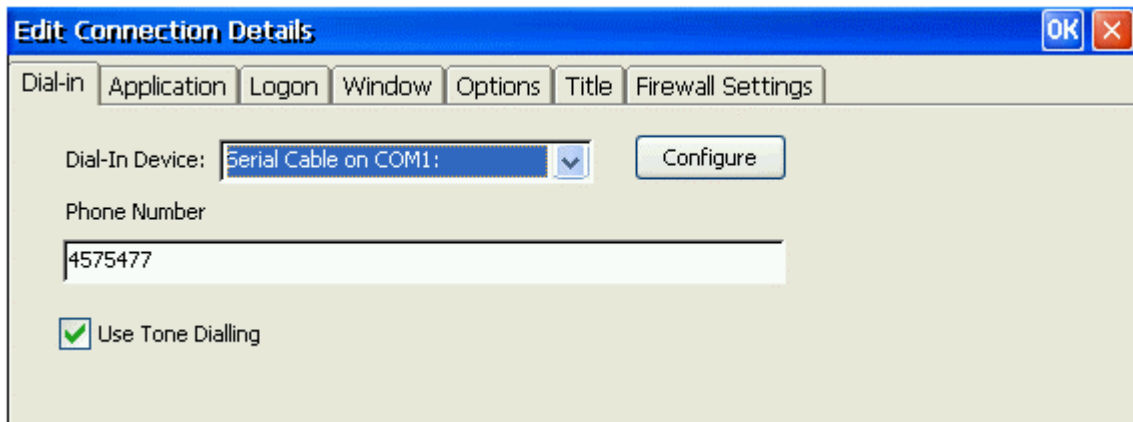

- The **Application** tab, where you can specify an application to run after connecting to a Citrix server.

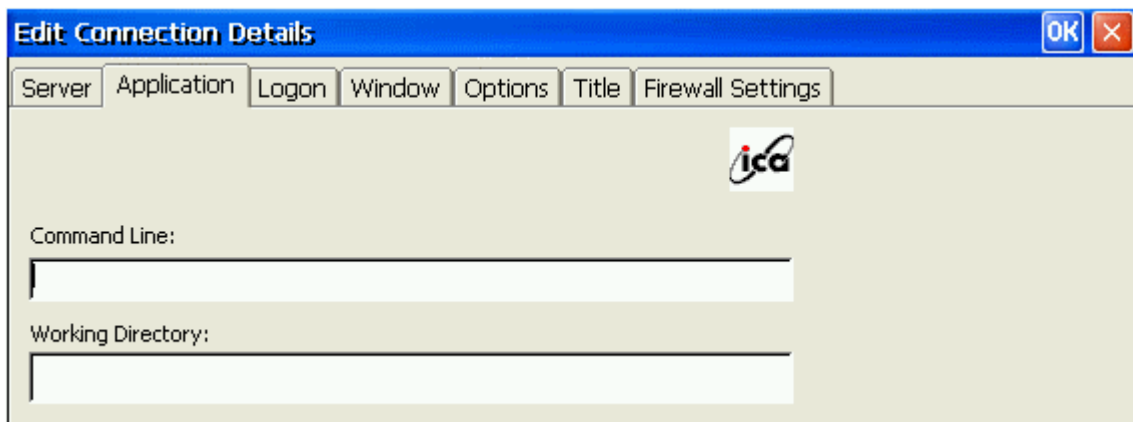

- The **Logon** tab, where you can set the user name, password, and domain to use to log in to the Citrix server automatically.

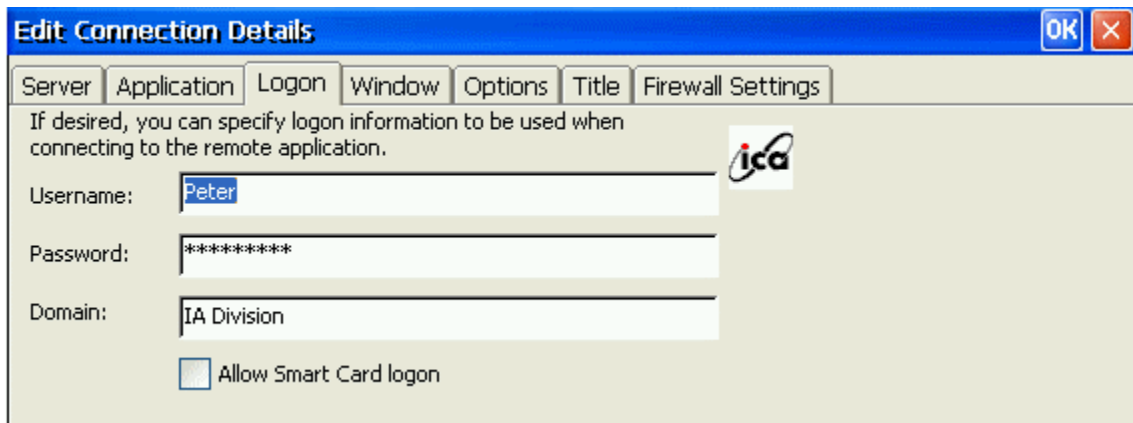

- The **Window** tab, where you can set the number of colors used for the ICA Client window.

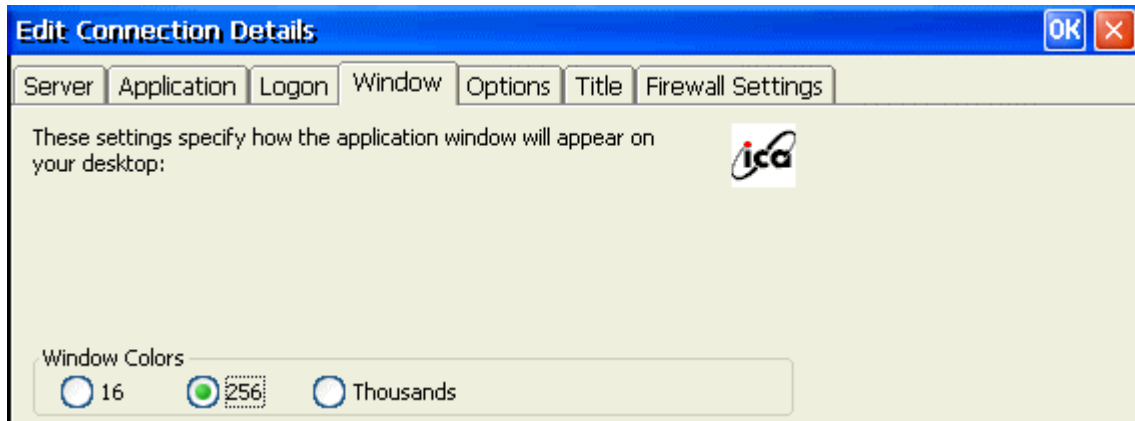

- The **Options** tab, where you can control the connection between the Citrix server and Windows CE device, such as ICA virtual printer, ICA data stream compression option, sound quality, encryption level.

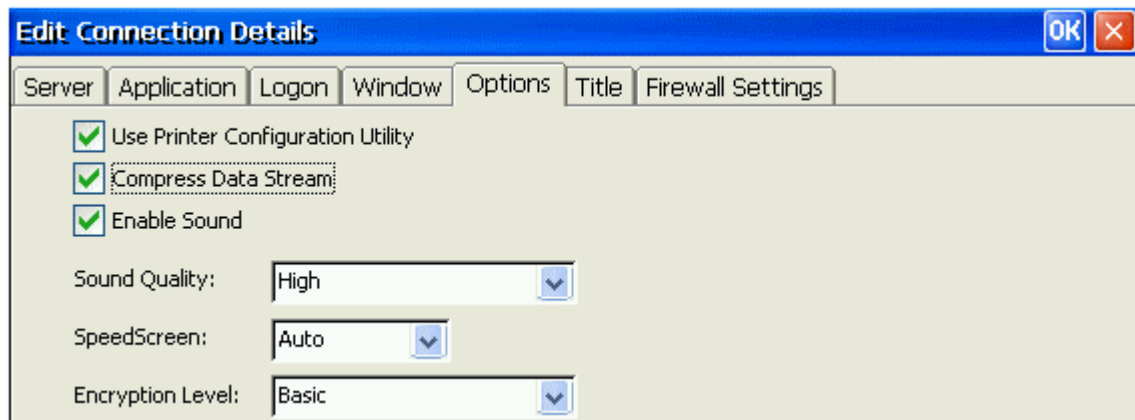

- The **Title** tab, where you can change the name of the connection. The name appears in the list in the **Connection Manager** dialog box.

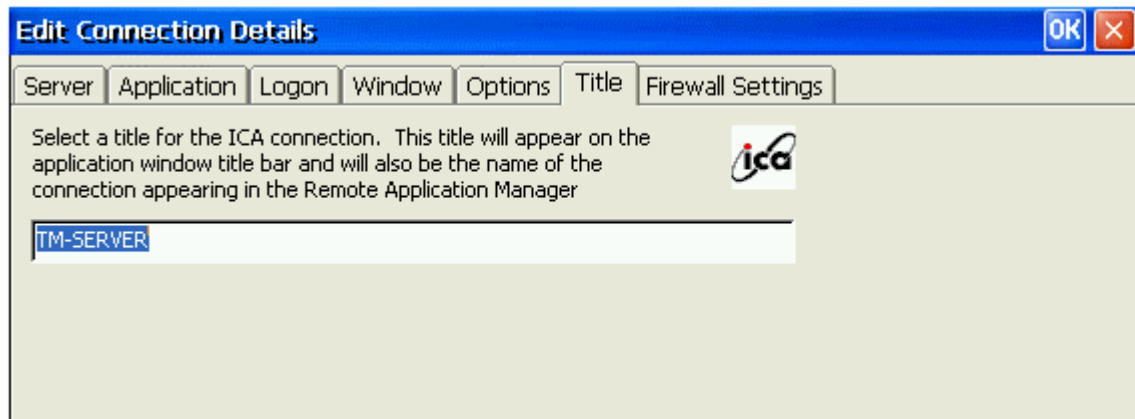

- The **Firewall Settings** tab, where you can configure the client to use a SOCKS proxy and alternate address remapping.

The screenshot shows the 'Edit Connection Details' dialog box with the 'Firewall Settings' tab selected. The dialog has a blue title bar with 'Edit Connection Details' and 'OK' and 'X' buttons. Below the title bar are tabs for 'Server', 'Application', 'Logon', 'Window', 'Options', 'Title', and 'Firewall Settings'. The 'Firewall Settings' tab contains the following elements:

- Proxy:** A dropdown menu set to 'none (direct)'. Below it is a note: 'NOTE: Enable SSL or 128-bit encryption to assure a secure connection'.
- Proxy address:** An empty text box.
- Port:** A text box containing '1080'.
- SSL/TLS Relay:** A section with two text boxes: 'Address of relay' (empty) and 'Port' (containing '443').
- Use alternate address through firewalls:** An unchecked checkbox.

General Settings and Information

Starting Programs

Start Menu Window

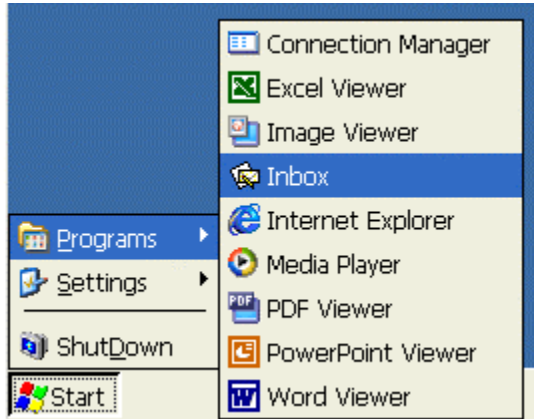

To open a program that isn't on the desktop, select **Start > Programs > *program name*** from the **Start** menu on the desktop.

Starting Multiple Sessions

From a working session or another application (i.e. "Inbox"), invoke the Terminal Connection Manager by clicking on the desktop icon or selecting **Start > Programs > Connection Manager** from the **Start** menu. Then click on another connection to start a new session.

Arrange Desktop Icons

To have the system automatically arrange the desktop icons, place the mouse in an open area of the desktop.

1. Click the right mouse button. This is the same as pressing the ALT key and left click with the mouse.
2. Select and highlight the **Arrange Icons** selection.
3. Select the method for which you want to arrange the icons from the list.

Move Desktop Icons

1. Place mouse over a desktop icon and hold down the left mouse button.
2. Drag the icon to the desired place on the desktop and release the mouse button.

Note: These changes are not saved on reboot.

Toggle or Switch between Sessions and / or Windows

To switch between active sessions or application windows, you have 3 choices:

- Select the appropriate window from the MinIT6000 taskbar.

- Hit the <ALT> and <TAB> keys at the same time to bring up the Task Manager window, select the appropriate Active Task and then select the **Switch To** button.
- Hit the <ALT> and <ESC> keys at the same time to toggle between all of the active windows.

Jump to Desktop from Session or Application Window

From any session or application window, it is possible to jump directly to the CE desktop.

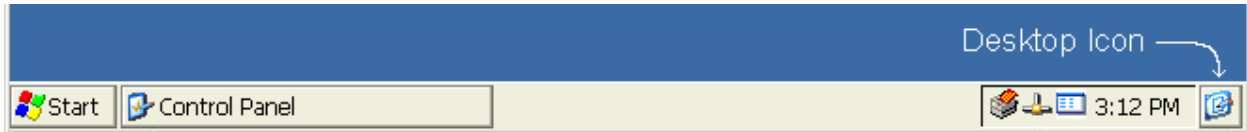

Just select the “Desktop” icon from the far right corner of the taskbar.

Change Taskbar Settings

1. Select **Start > Settings > Taskbar** or move the mouse over the taskbar and click the right mouse button to bring up the “Properties” window.

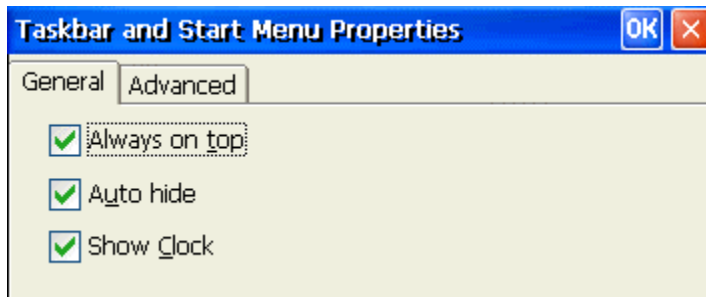

2. Under the taskbar **General** tab, place a check mark in the appropriate check box to enable the following options:

Always on Top

When this function is enabled (default), the taskbar will remain visible with all other windows open except an **RDP** session. See **Multiple Taskbars**.

Auto Hide

When this function is enabled, the taskbar hides away when the mouse is removed from the bottom of the screen.

Show Clock

When this function is enabled (default), the clock appears on the right side of the taskbar.

3. To clear the contents of the **Documents Menu**, select the **Advanced** tab.

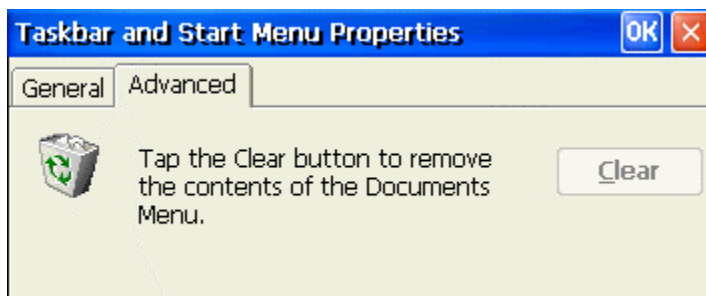

4. Click on the **Clear** button.

- Click on the **OK** button to close the **Taskbar Properties** window.

Multiple Taskbars

When running an ICA or RDP session, you will have access to the server taskbar within the client session as well as the MinIT6000 desktop taskbar.

Depending on how each of them is setup, you may or may not have access to or know how to get to the correct one. The following describes different options that might cause some confusion.

	Always on Top	Auto hide
MinIT6000 Desktop Taskbar	Enabled	Don't care
RDP window Taskbar	Disabled	Enabled

With this configuration, you will be unable to get to the RDP session taskbar because it gets hidden behind the MinIT6000 taskbar. In this case the MinIT6000 taskbar acts as if it is set to **Auto hide** even though it is set with **Always on Top** enabled. The solution is to disable the **Always on Top** option for the MinIT6000 taskbar. To do this, move the mouse down to the bottom of the screen to display the MinIT6000 task. Click the right mouse button and select **Properties** to bring up the Taskbar properties window. Un-select **Always on Top** and click OK. Now you should have access the RDP session taskbar. To get back to the MinIT6000 taskbar, <ALT> and <TAB> keys at the same time to bring up the Task Manager window as well as the desktop taskbar.

	Always on Top	Auto hide
MinIT6000 Desktop Taskbar	Disabled	Disabled
RDP/ICA window Taskbar	Don't care	Don't care

Once the client session window is open, the problem with this configuration is that you will not have direct access to the MinIT6000 desktop taskbar. To gain full access to the MinIT6000 taskbar, the only solution to this is to close down the client session. However, to switch to another active MinIT6000 window, hit the <ALT> and <TAB> keys at the same time to bring up the Task Manager window. If you are in an RDP session window the desktop taskbar will appear as well. To switch windows, select the appropriate active task and click on the **Switch To** button. Note, you can also hit the <ALT> and <ESC> keys at the same time to toggle between windows.

Configure Terminal Properties

Control Panel

Similar to a PC, all of the terminal settings can be done through the control panel.

Bringing up the Control Panel

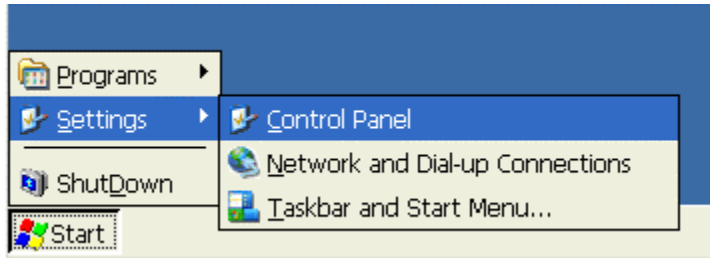

To bring up the Control Panel, select **Start > Settings > Control Panel** from the **Start** menu on the desktop.

Control Panel Window

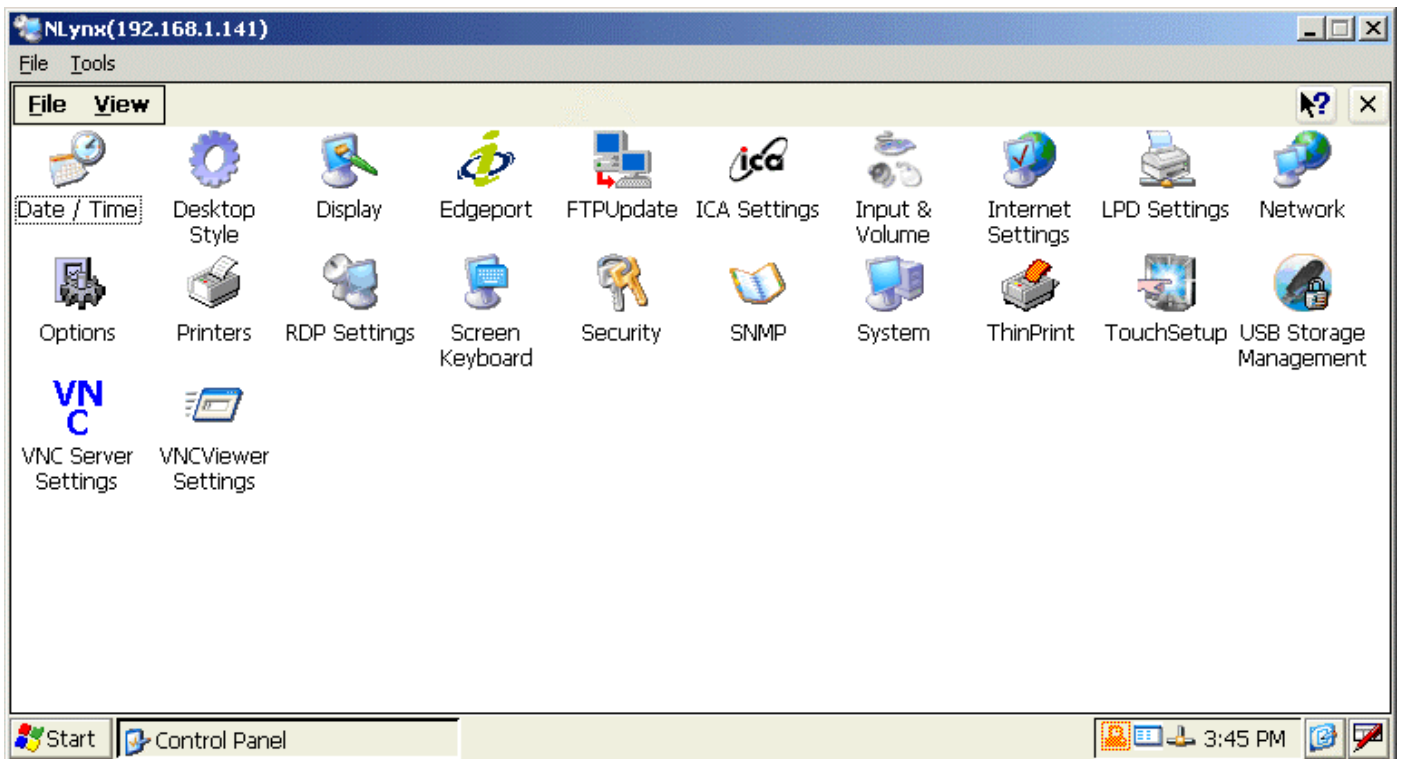

[Date/Time](#)

[Desktop Style](#)

[Display](#)

[Edgeport](#)

[FTPUpdate](#)

[ICA Settings](#)

[Input & Volume](#)

[Internet Settings](#)

[LPD Settings](#)

[Network](#)

[Options](#)

[Printers](#)

[RDP Settings](#)

[Security](#)

[SNMP](#)

[System](#)

[ThinPrint](#)

Date / Time

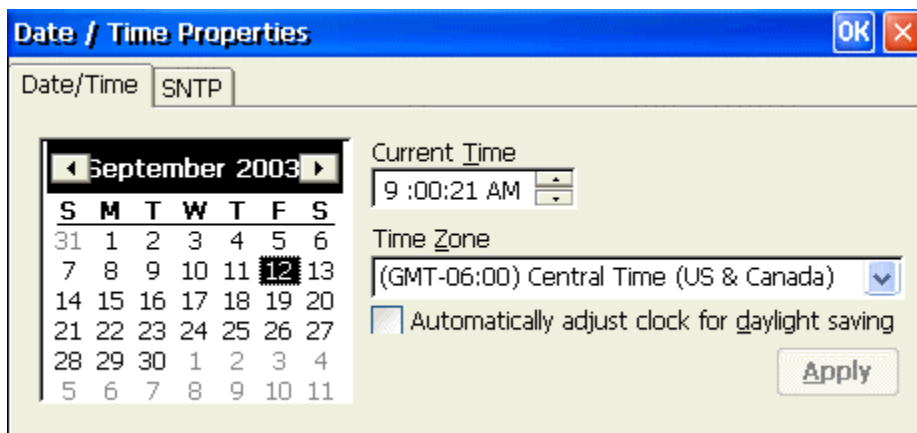

1. Click on the Date / Time icon to bring up the properties window.
2. To set the month, select the arrows on either side of the month shown to step through the months, or select the month label to choose from a list of months.
3. To set the year, click on the year label to open an editing box and type in the correct year.
4. To set the date, select it in the calendar.
5. To change the time, enter it in the **Current Time** box, type in the correct time or click on the up/down tabs to select the correct time. Click in the **Time Zone** box and then use the mouse or the up/down arrow keys to select the appropriate time zone. Place a check in the **Daylight Savings** check box if it applies. Finish by clicking on the **Apply** button or selecting **OK** for your setting to take effect.

Note: You can also enter the Date/Time setup window by clicking on the time indicator on the taskbar (lower right hand corner of the screen).

Desktop Style

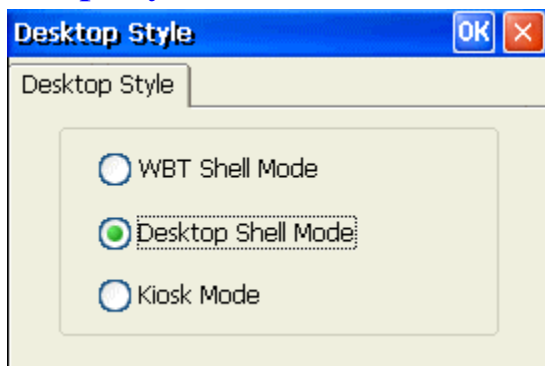

WBT Shell Mode

Selecting this option only allows the user to view the client options through the "Terminal Connection Manager" window only. To launch the email client in this mode, the user must choose the "Configure" tab and select "Add" each time.

Desktop Shell Mode

Selecting this option allows the user to view the client options and additional applications through a standard "Windows" looking interface with the ability to select ones own background wallpaper. This mode is set by default.

Kiosk Mode

Selecting this option only allows the user to view a browser window that has been pointed at a specific web page. The normal Internet browser address window is not displayed. This mode is intended for company "Intranet" applications. Once selected, to get out of **Kiosk** mode, select <CTRL> <ALT> <UP>.

Note: Changing modes forces the unit to be re-booted with all current client configurations being deleted.

Display

Use the Display properties window to configure the terminal's display screen.

Display Tab

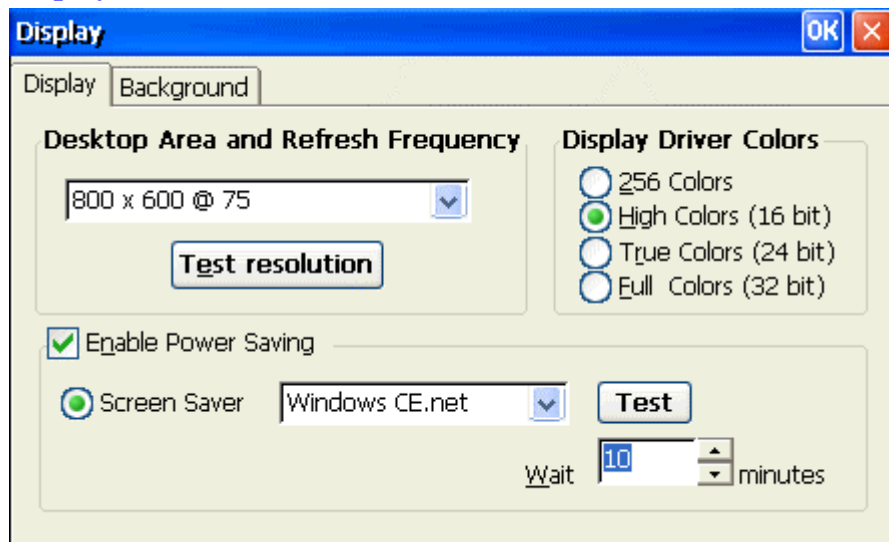

The following table discusses the functions of this properties sheet.

Desktop Area and Refresh Frequency

1. Use the pull-down list to select the terminal display resolution.
2. Use **Test resolution** button to preview the resolution selected to verify that your monitor supports it.

Enable Power Saving

Click on the check box to enable the power saving features. This is set by default.

Screen Saver

1. Click on this radio button to enable the screen saver. This is set by default.
2. Choose from one of two screen saver patterns, Windows CE logo and blank screen.
3. Adjust the amount of time before the screen saver becomes active.
4. Use the **Test** button to preview the **Screen Saver** image for 3 seconds.

Display Driver Colors

Select the hardware display color setting. High Color (16 bit) is set by default. If you encounter any display problem within an application, try choosing the 256 colors setting to see if it resolves the problem. Selecting the True Color or Full color options will give you higher image quality but may slightly reduce system performance (speed).

Background Tab



Wallpaper

You may choose to download and select your own desktop wallpaper. The unit by default is loaded with the "MinIT 6000" background wallpaper. To install and use your own (**must be a BMP image**), click on **Download Wallpaper** to bring up the "FTP Update window". Enter in the appropriate FTP information and then type in the file name (i.e. image.bmp) of your background image. For more information, see the FTP Update section.

Background Color

The Background Color is the color of the screen displayed when no (**None**) wallpaper has been chosen. If a wallpaper has been chosen, depending on the image size, the background color is used to fill up the screen surrounding the wallpaper image.

1. To select the desktop background color, click on the color square. This brings up the color pallet window.
2. Choose from the available colors.
3. Click on **OK**.

Wallpaper pre-view

The pre-view window shows the current wallpaper installed on the MinIT6000 unit.

Note: Only one wallpaper image can be installed at a time.

FTP Update

Use FTP Update to download updated MinIT6000 firmware (i.e. software in ROM) or Desktop Background images. For more information, please refer to the [Upgrade Utilities](#) section.

Edgeport

Edgeport USB-to-Serial Converters offer an easy Plug-and-Play solution for instant COM port expansion. The Edgeport connects directly to the USB port of the MinIT6000. To allow for flexibility, the Edgeport is available with a wide variety of options to meet specific application requirements. Edgeport adapters are available from Inside Out Networks.



FTP Update Window

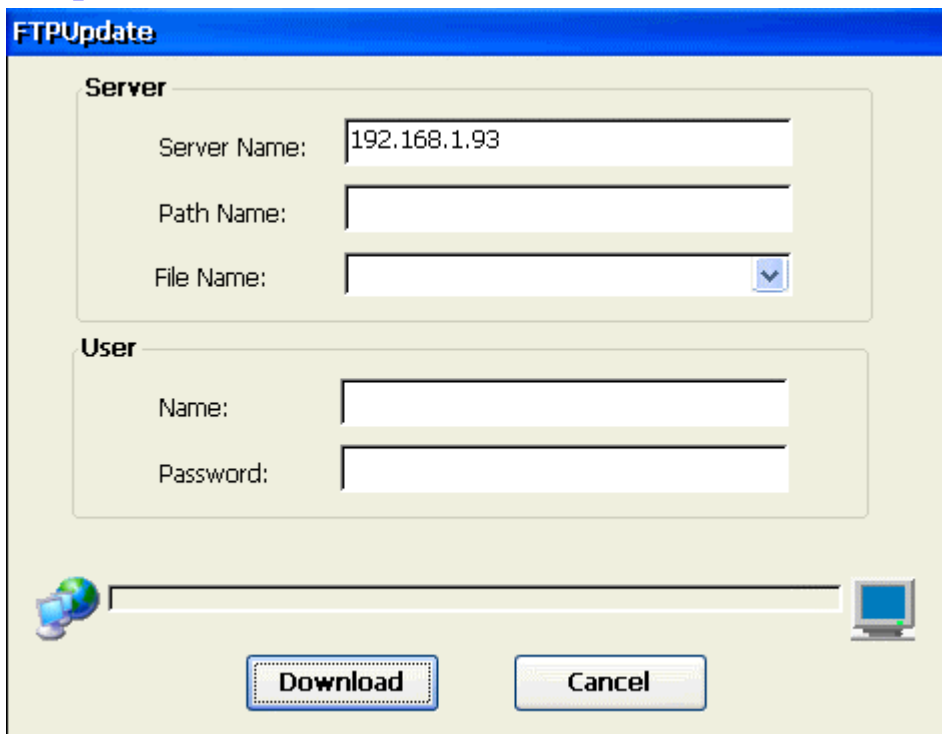

1. Enter in the name or IP address of the FTP server that contains the updated firmware (or bmp image for backgrounds).
2. Type in the directory path where the file is located.
3. Type in the full file name of the updated firmware or click on the pull down menu and select the file from the list.
4. Type in the User **Name** and **Password** required to log into your FTP server.

Note: Most FTP servers are case sensitive in regards to the path and file name information.

5. Click on **Download**.

Download Process Information Box

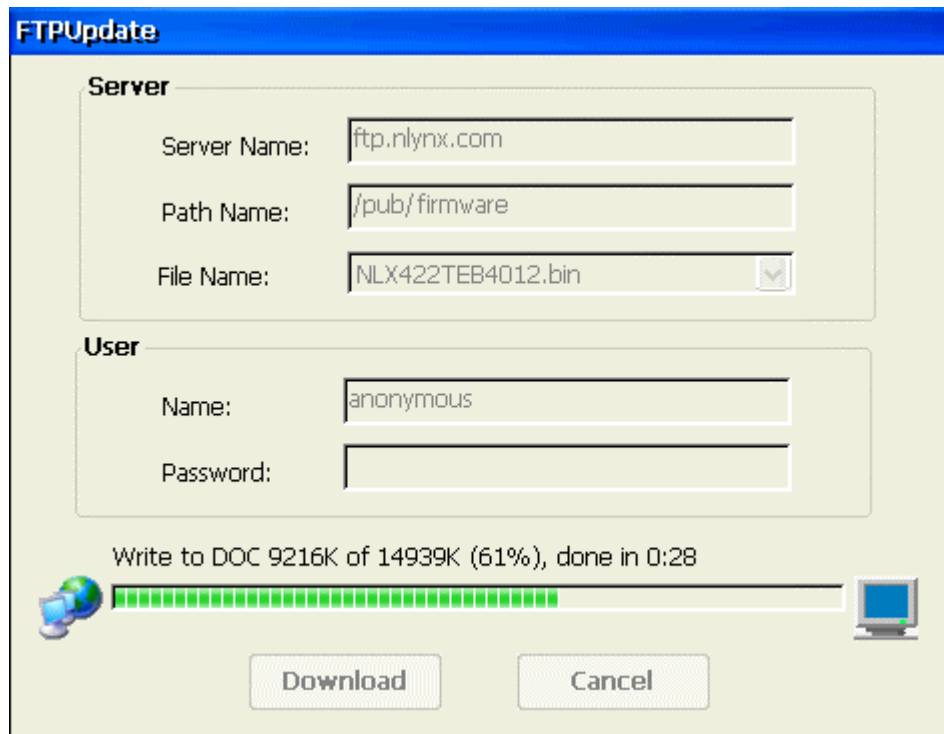

During the download process, the system will show you the progress. The unit downloads the file into memory and verifies it's integrity before it copies it into flash. The download time will vary depending on the speed of the network and FTP server as well as the file size.

ICA Setting

The global settings are accessed from the Global ICA Client Settings properties window. This is usually accessed with other Terminal property settings on your terminal. The key combination used to display the properties will be in the documentation supplied by your Windows CE terminal manufacturer. It is usually a function key such as F2.

Hotkeys Tab

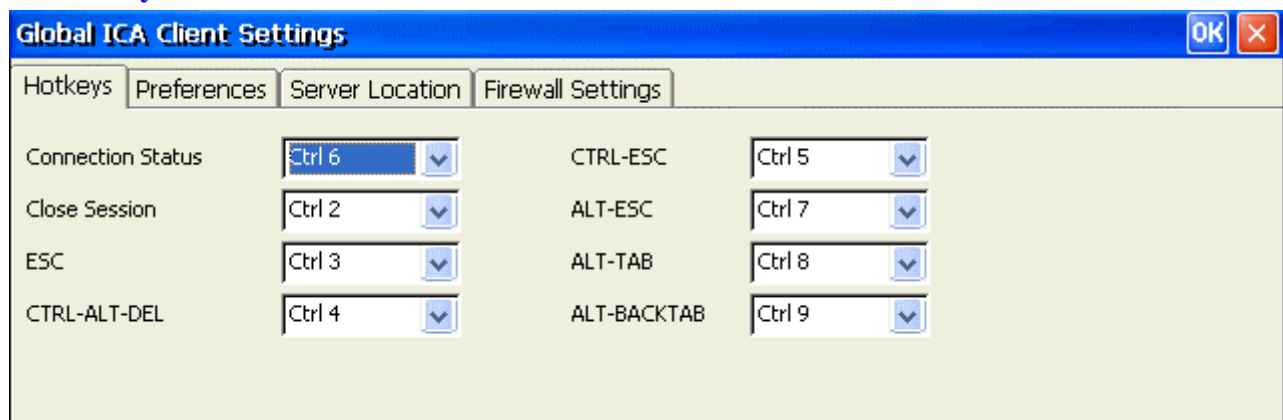

1. Open the Global ICA Client Settings dialog box according to the instructions for your Windows-based terminal device.
2. Make the desired changes.
3. Click OK to save your changes.

Configuring Hotkeys

The ICA Windows CE Client provides users with hotkeys that can be used during ICA sessions to control various functions. Some hotkeys control the behavior of the ICA Windows CE Client itself while others emulate standard Windows hotkeys. When you want to use a Microsoft Windows key combination during a session, use the mapped hotkey instead. The following table lists the default ICA Windows CE Client hotkeys.

Name	Default Value	Description
Status Dialog	CTRL+6	Displays ICA Client connection status.
Close Session	CTRL+2	Disconnects the ICA Windows CE Client from the Citrix server and closes the client window on the local desktop. Using this hotkey leaves the ICA session running in a disconnected state on the Citrix server. If you do not want to leave your session running in a disconnected state, log off instead.
Esc	CTRL+3	Provides the functionality of an ESC key on your terminal.
CTRL-ALT-DEL	CTRL+4	Displays the Windows NT Security dialog box on a MetaFrame for Windows server.
CTRL-ESC	CTRL+5	On MetaFrame for Windows servers, the Windows Start menu is displayed. On <i>WINFRAME</i> servers, this hotkey displays the Task List.
ALT-ESC	CTRL+7	This hotkey cycles the focus through the minimized icons and open windows of applications run in your ICA session
ALT-TAB	CTRL+8	This hotkey cycles through all applications in the ICA session. A pop-up box appears and displays the programs as you cycle through them. The selected application receives keyboard and mouse focus.
ALT-BACKTAB	CTRL+9	Like the ALT+TAB hotkey, this key sequence cycles through applications that have been opened in the ICA session, but in the opposite direction. The chosen application receives keyboard and mouse focus.

To change the default hotkeys:

1. Use the list of keys to customize the default hotkey key sequences.
2. Click **OK** to save the settings.

Preferences Tab

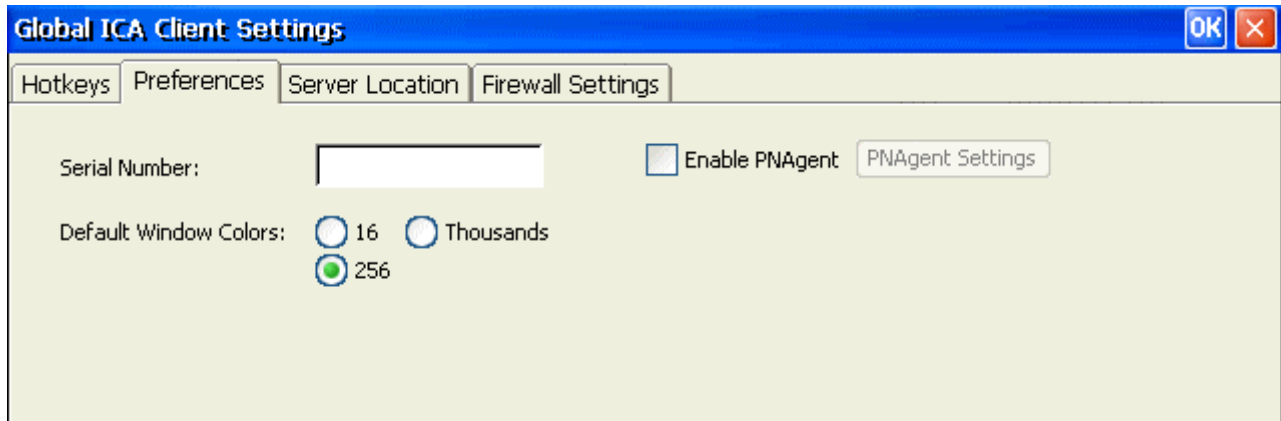

Serial Number

This is the serial number of your ICA Client software. This number is only necessary when you are using the ICA Windows CE Client with a product such as *wiNFRAME* Host/Terminal, which requires each ICA Client to have a Citrix PC Client Pack serial number. If a serial number is required, you must enter it exactly as it appears on the Serial Number card. The serial number is not used when connecting to MetaFrame servers.

Default Window Colors

In the Window Colors box, select the color depth you require. When using a PPP connection, 16 color mode may provide better performance. If the window options specified exceed the capabilities of the client hardware, the maximum color depth supported by the Windows CE device are used instead.

Note: The options to select Thousands or Millions of colors are not available if your device is not capable of high color display.

Enable PNAgent

Click on the check box to enable **PNAgent** mode. In PNLite mode, a list of available published applications on the network is "pushed" to the ICA client and displayed in the **Connection Manager** dialog box.

Server Location Tab

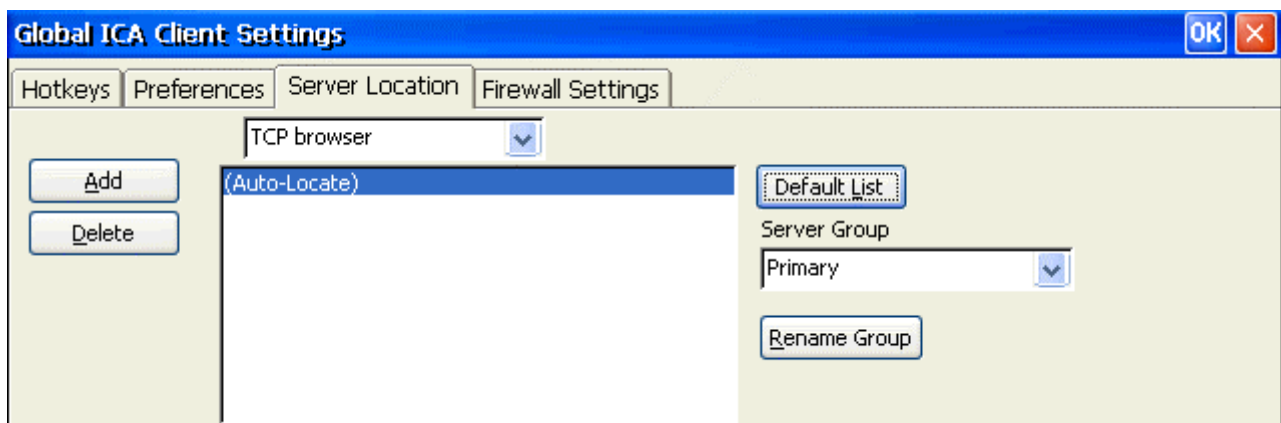

Server location (also called server browsing) provides a method for a user at a network-connected Citrix ICA client to view a list of all Citrix servers on the network, and a list of all published applications.

Tip: Set a specific server address for the Citrix server that functions as the master ICA Browser when your network configuration uses routers or gateways, or to eliminate broadcasts on your network. *Business recovery* provides consistent connections to published applications in the event of a master ICA Browser server disruption. You can define up to three groups of Citrix servers to which you want to connect: a primary and two backups. Each group can contain from one to five servers. When you specify a server group for your client, the client attempts to contact all the servers within that group simultaneously, and the first server to respond is the one to which you connect.

1. Using the pull-down list, select the browser type.
2. In the Server Group field, select the group that you want to configure. The Server Group field lets you create lists of specific servers that you want to designate as primary and backup servers for connecting to published applications. Use this field to designate whether the servers entered in the Address List field belong to your Primary, first backup (Backup 1), or second backup (Backup 2) group.
3. Click the **Add** button to add a server to the selected group. The Add Server Address dialog box appears.
4. Enter the name or address of a Citrix server and click **OK**.
5. Add more servers as necessary and then click **OK** to save the changes.

Firewall Settings Tab

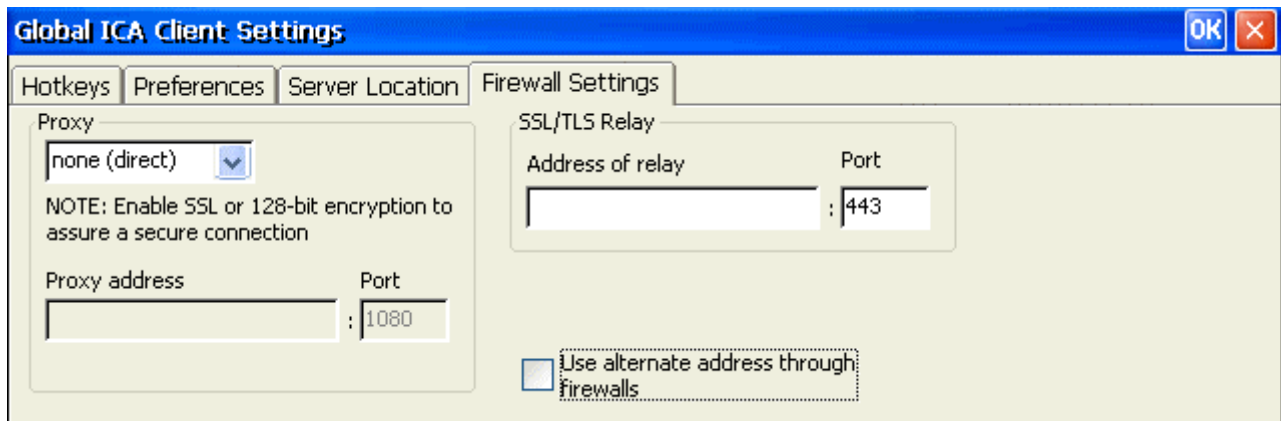

Configuring the ICA Client to Use a SOCKS Proxy

If you are using a SOCKS proxy server to limit access to your Citrix servers, you must configure a SOCKS proxy server to handle connections between clients and the server. You can place the proxy server on either side of the firewall, or in some situations, on both sides of the firewall.

If your network is using a SOCKS proxy server, you must configure the ICA Client to connect to Citrix servers through it. You can configure a default SOCKS proxy for all connections or a SOCKS proxy with a specific connection entry.

To configure a default SOCKS proxy server:

1. Click on the **Proxy** pull-down list and select **SOCKS**.
2. In the **Proxy address** box, type in the proxy server's IP address or DNS name.

3. In the **Port** box, type in the proxy servers port address if it is different than 1080 (default).
4. Click **OK** to save the changes.

Note: If you configure a default SOCKS proxy, you must specify at least one server in the Server Location tab for server and published application browsing to work.

To configure a SOCKS proxy for a specific connection entry:

1. Click on the Proxy pull-down list and select SOCKS.
2. In the Proxy address box, type in the proxy server's IP address or DNS name.
3. In the Port box, type in the proxy servers port address if it is different than 1080 (default).
4. Click OK to save the changes.

To configure a SOCKS proxy for a specific ICA client connection:

1. From the "Connection Manager" window, select the ICA client connection you want to change.
2. Click on the **Edit** button to bring up the "Edit Connections" window.
3. Click on the Firewall Settings tab.
4. Follow the instructions for the procedure above beginning with Step 1.

Configuring Alternate Address Translation:

If the ICA Client is outside a firewall that uses address remapping, you must configure the ICA Client to use the alternate address returned by the master ICA Browser. This is necessary even if you are not using a SOCKS proxy server.

Note: You must also use the ALTADDR utility to manually set the alternate address for each Citrix server. See the Command Reference appendix of either the *MetaFrame Administrator's Guide* or the *WINFRAME System Guide* for more information.

To use alternate address translation for all connection entries:

1. Open the Global ICA Client Settings dialog box.
2. Click the Firewall Settings tab.
3. Click Use alternate address for firewall connection.
4. Click OK to save your changes.

Note: If you set alternate address translation for all connection entries, it cannot be disabled for specific connection entries.

To use alternate address translation for a specific connection entry:

1. From the "Connection Manager" window, select the ICA client connection you want to change.
2. Click on the Edit button to bring up the "Edit Connections" window.
3. Click the Firewall Settings tab.
4. Click Use alternate address for firewall connection. Click OK to save your changes.

Input & Volume

Using the Input & Volume properties window to configure your terminal's keyboard, mouse and audio volume.

Keyboard, Volume Tab

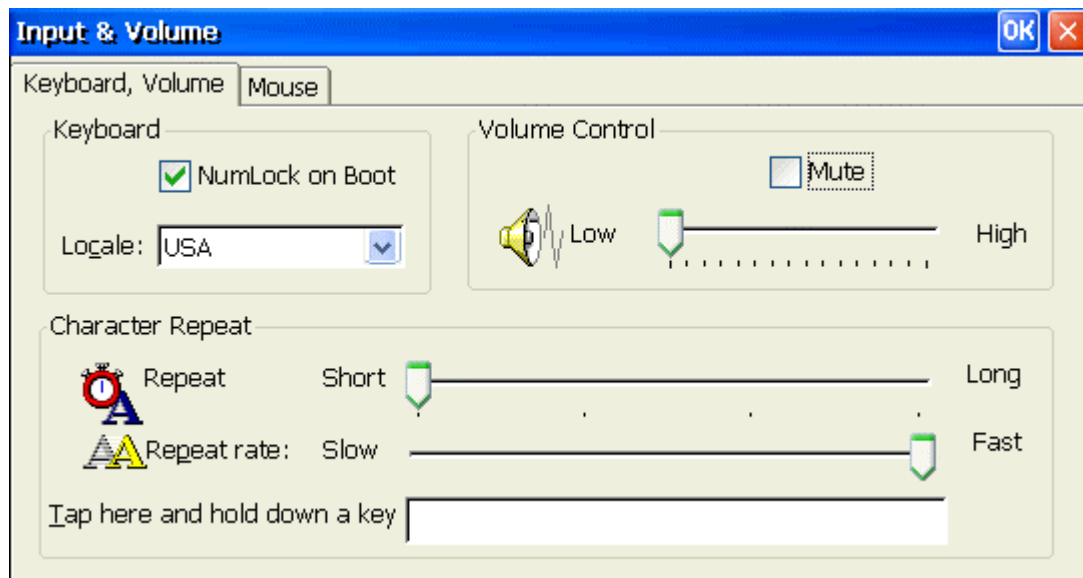

NumLock on Boot

Using the check box, you can enable NumLock while the terminal starts up.

Locale

Using the scroll list, you can select a language for the keyboard.

Volume Control

Using this slider control, you can adjust the volume of the audio and using the **Mute** check box, you can disable the audio of the terminal.

Character Repeat

Using the slider control, you can adjust the repeat delay of keyboard characters. Repeat defines how soon the same character will appear again when typed more than once.

Repeat Rate

Using this slider control, you can adjust the repeat rate of a keyboard character. Repeat Rate defines how quickly the same character will appear again when a key is held down.

Tap here and hold down a key

Use this entry box to test the new settings.

OK

Click on **OK** button to save changes and quit the dialog box. Click on the **X** button to quit the dialog box without saving changes.

Mouse Tab

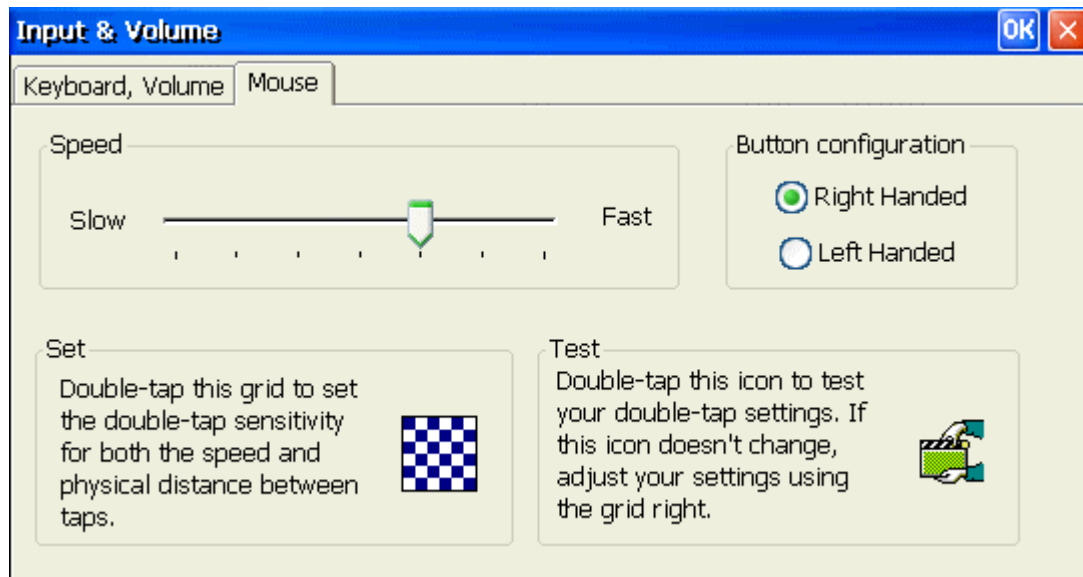

Speed

Using the slider control, you can adjust the mouse speed. Speed defines how much distance will be changed for each mouse event.

Button Configuration

Using the radio button, you can select **Right Handed** and **Left Handed** for your convenience.

OK

Click on **OK** button to save changes and quit the dialog box. Click on the **X** button to quit the dialog box without saving changes.

Internet Settings

Use the Internet Settings **properties** window to configure your Web browser settings

General Tab

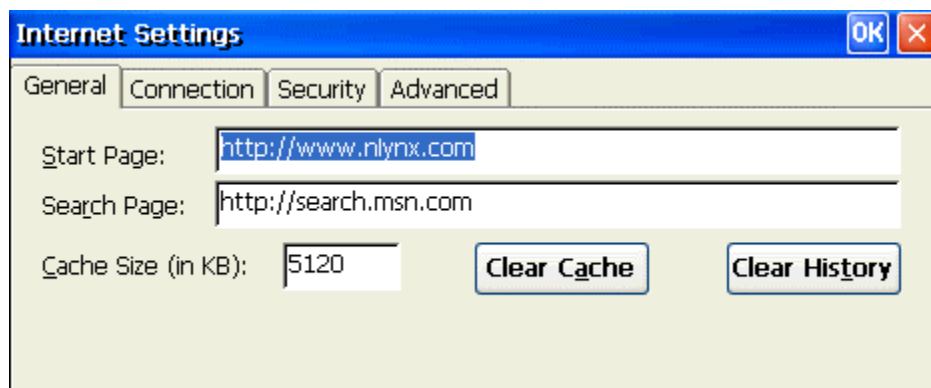

1. Type in the desired URL to change the browser **Start Page**.
2. Type in the desired URL to change the browser **Search Page**.
3. Increase or decrease the memory space devoted to caching by typing in the new larger or smaller value.

4. Click on the **Clear Cache** button to remove previous viewed web pages out of memory.
5. Click on the **Clear History** button to remove any history of previously viewed web pages.

Connection Tab

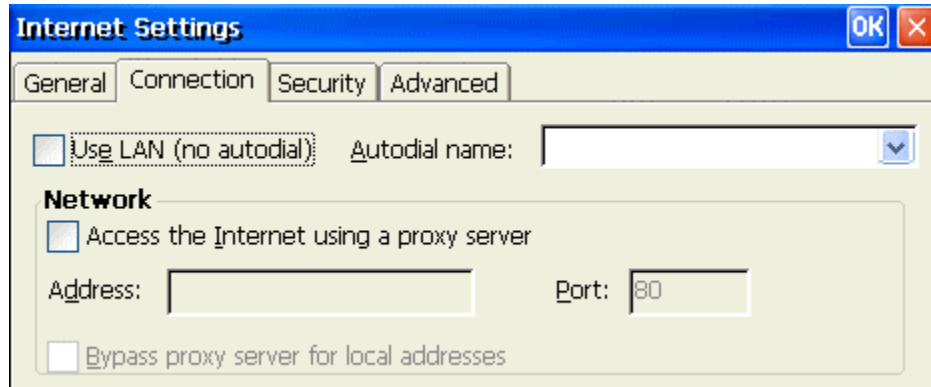

1. Click on the Use **LAN** check box if you plan to connect to the internet via the Ethernet LAN.
2. If you are using a dial-up (serial port modem) connection, from the pull-down list, select an Autodial name of the remote connection that you are planning on using.

Proxy servers are often used when connecting to the Internet through a local network, such as a corporate network, for added security.

3. Click on the **Access the Internet** using a proxy server check box if this is correct.
4. Type in the proxy servers IP **Address** or DNS name.
5. Type in the access **Port** number if it is something other than the default of 80.
6. If you don't need the proxy server to access local IP addresses, click on the **Bypass proxy server for local addresses** check box.

Security Tab

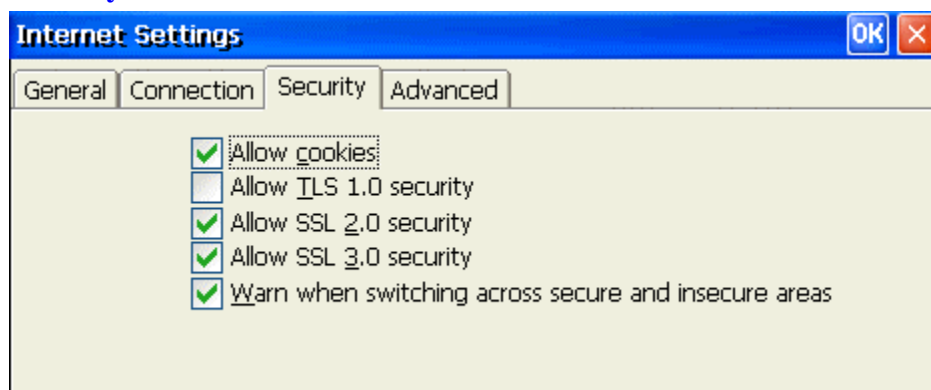

Use these options to select the level security that you want to determine what type of web pages can be viewed. Enabling the **Allow cookies** option will allow cookies to be copied into memory.

Advanced Tab

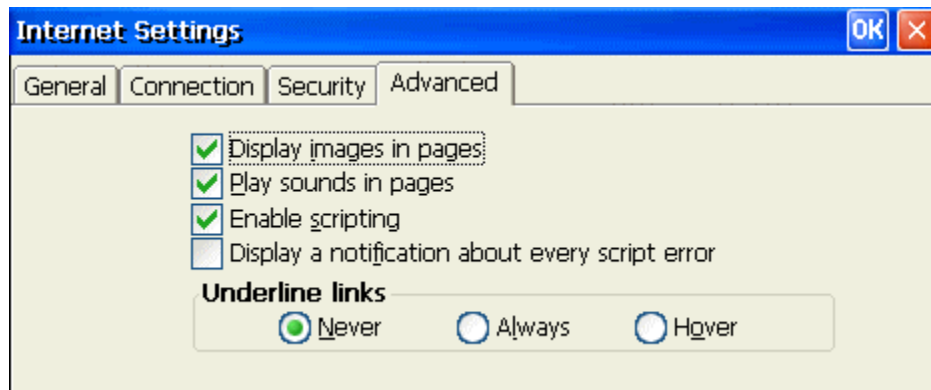

It is possible to speed up how fast the system renders web pages by "NOT" enabling certain options. Choosing not to display images or play sounds could possibly increase the speed at which the standard web page text is displayed.

Underline Links

Select how you want "Links" that are embedded within a given web page are displayed by choosing the appropriate radio button.

LPD Setting

The Berkeley versions of the Unix(tm) operating system provide line printer spooling with a collection of programs: lpr (assign to queue), lpq (display the queue), lprm (remove from queue), and lpc (control the queue). These programs interact with an autonomous process called the line printer daemon.

LPR is a TCP-based protocol. The port on which a line printer daemon listens is 515. The terminal includes a LPD module, which allows an LPR device to print data from the local printer of the terminal.

LPD Properties Window

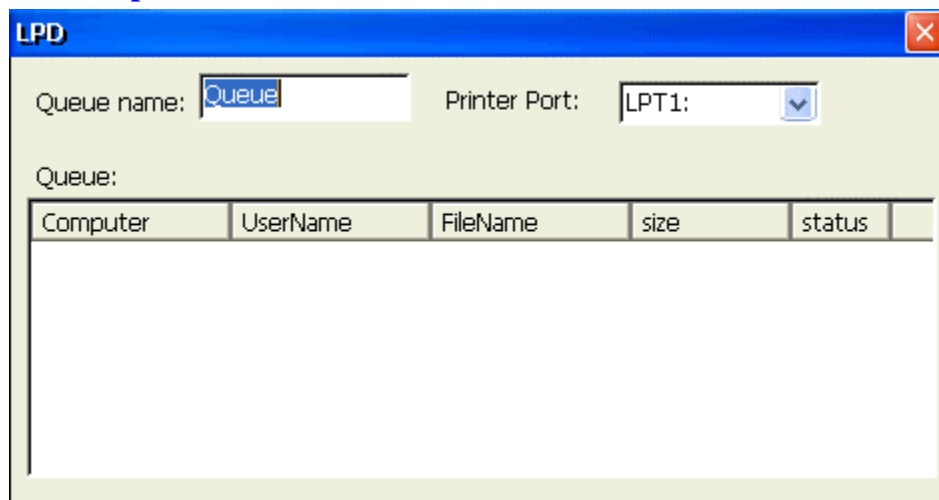

1. Type in the **Queue name** of the LPD printer.
2. Select the **Printer Port** from the drop-down list.

Network

The Network Setting Dialog Box lets you either to enable a DHCP addressing or to specify an IP address.

Network Properties Window

The screenshot shows the 'Network' dialog box with the following settings:

- Obtain an IP address from a DHCP server
- Specify an IP address
 - IP Address: [][] . [][] . [][] . [][]
 - Subnet Mask: [][] . [][] . [][] . [][]
 - Gateway: [][] . [][] . [][] . [][]
- Network speed: Auto Detect
- Network Utilities:
 - Client IP Address
 - Ping IP Address
 - Advanced Network...
- ICA Utility:
 - Global ICA Client Settings
- Keep current IP address, if DHCP fails
- TCP KeepAliveTime: 120 Minutes

Obtain an Address from a DHCP Server

Click on this radio button to enable DHCP so you can obtain an IP address automatically from a DHCP (Dynamic Host Configuration Protocol) server. This allows the network to configure the TCP/IP information for your device.

Specify an IP Address

Click on this radio button to enable the following three fields for manually setting the TCP/IP information for your device.

IP Address

Enter a static IP address in this field. It defines the IP address of the terminal, which uniquely identifies it on a TCP/IP network

Subnet Mask

Enter the subnet mask of the IP address. This determines which part of the address denotes the network.

Gateway

Enter in the IP address of the Gateway. If a host session address is outside of the Subnet of the terminal, the Gateway address defines which gateway is used to reach the host.

Client IP Address

Click on the **Client IP Address** check button to show the Client information, including Client name, IP address, subnet mask, gateway, DHCP server, DNS and WINS.

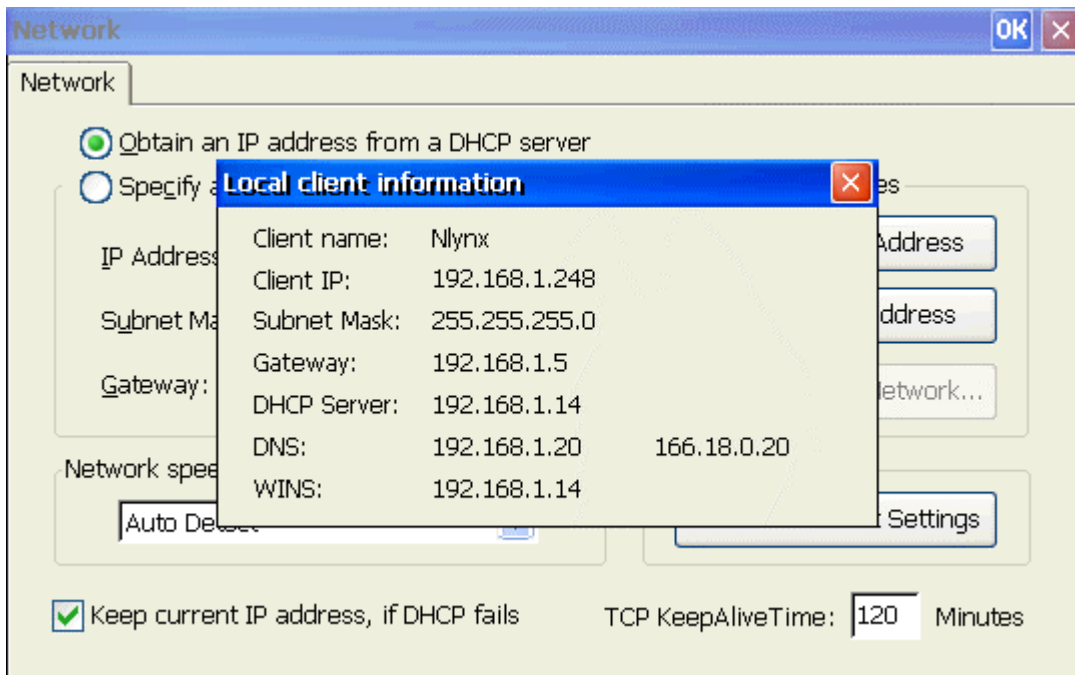

Ping IP Address

Click on the **Ping IP Address** to display the Network State dialog box. You can ping the name or IP of a host connected on the network. You even can ping an web site through the gateway.

You can setup how many times you want to ping for a ping task. Default is 6 times. You can also setup the timeout value of host response for different network configurations. The default is 2 seconds.

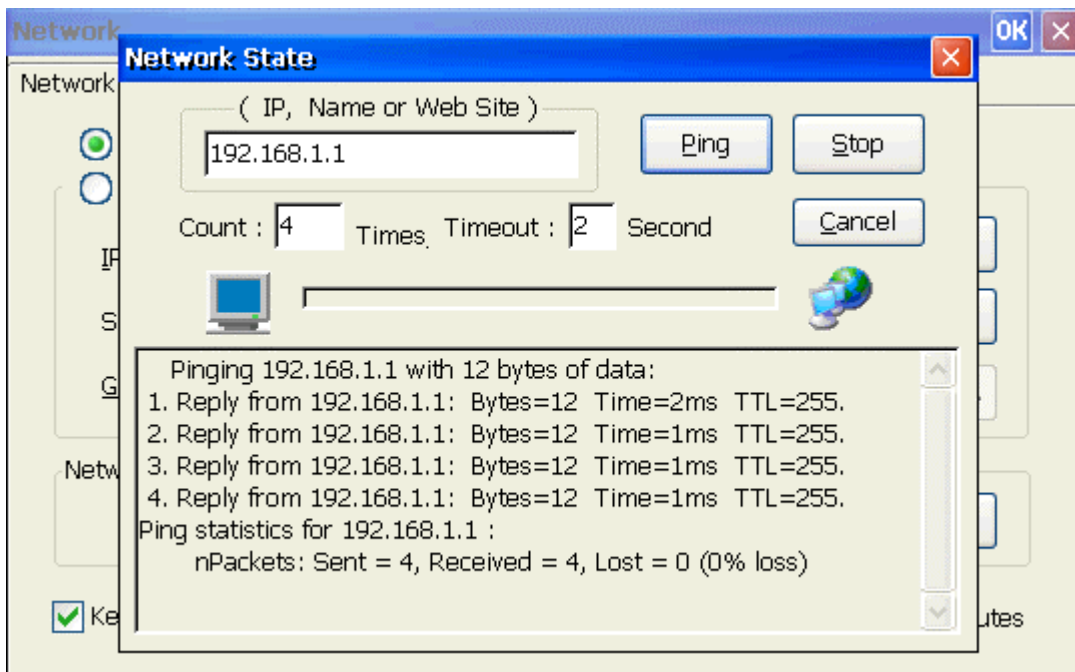

Advanced Network...

The **Advanced Network...** button becomes active if you have selected the **Specify IP Address** setting. Click on this button to manually set the DNS and WINS IP information.

Advanced Network Settings

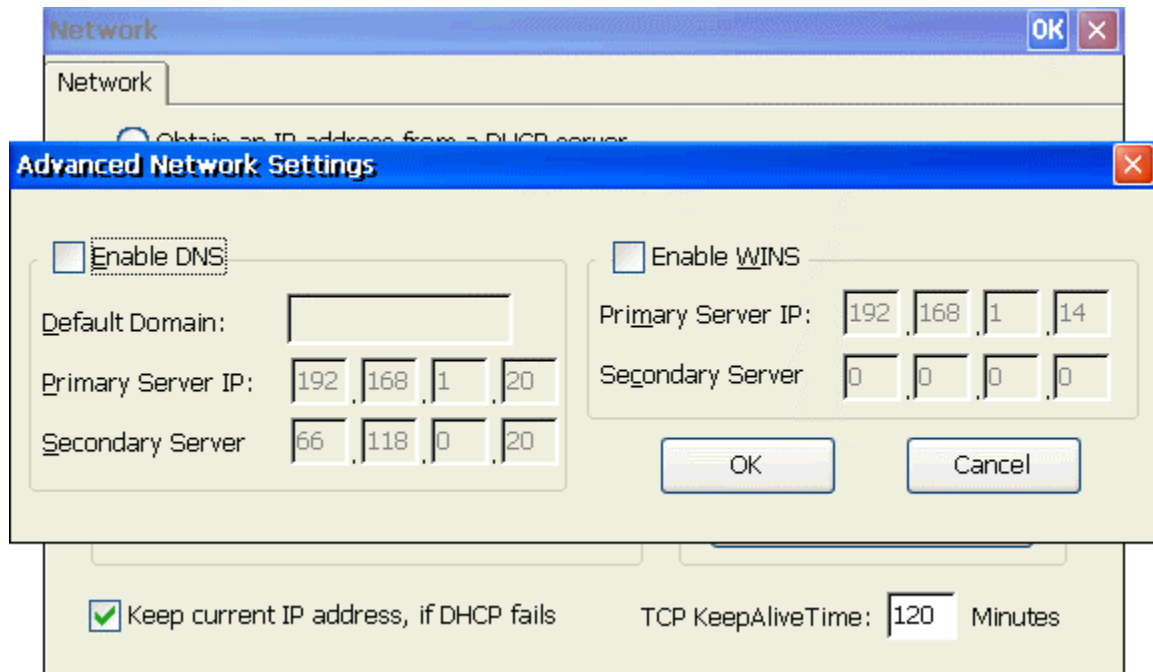

Enable DNS

Click on the check box to enable the following three fields for the DNS setting.

Default Domain

Enter the default domain name in this field.

Primary Server IP Address

Enter the primary DNS server IP address in this field.

Secondary Server IP Address

Enter the secondary DNS server IP address in this field.

Enable WINS

Click on the check box to enable the following two fields for the WINS setting.

Primary Server IP Address

Enter the primary WINS server IP address in this field.

Secondary Server IP Address

Enter the secondary WINS server IP address in this field

OK

Click on **OK** button to save the changes and restart the terminal.

Cancel

Click on **Cancel** button to quit the dialog box without saving changes.

Options

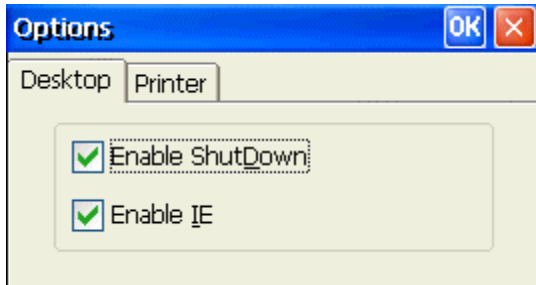

Enable ShutDown

Selecting this option allows a user to power down the unit from the software. The "ShutDown" option then appears in the "Start" menu. Disabling this requires one to use the power button to power down the unit. This is set by default.

Enable IE

Selecting this option enables "Internet Explorer" to be available for the user. This is set by default.

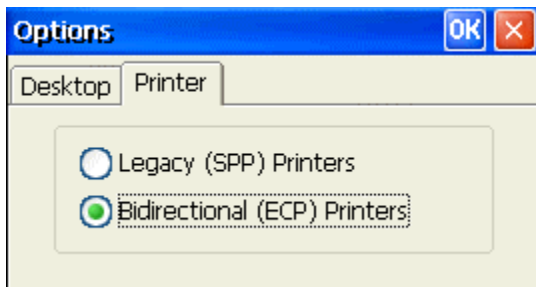

Legacy (SPP) Printers

Selecting this option allows for the use of "older", "slower", **S**tandard **P**arallel **P**orts type printers. **SPP** ports can be called unidirectional, standard, compatible and other names. These ports run at very slow speeds.

Bidirectional (ECP) Printers

Selecting this option allows for **E**nhanced **C**apabilities **P**ort printers. **ECP** ports use a DMA channel, but generally provide only a slight increase in speed. Some printer drivers can cause communication problems. This is set by default.

Printers

From the control panel properties sheet, double click the Printers icon to reach the "Add printer" dialog box.

Add Printer Dialog box

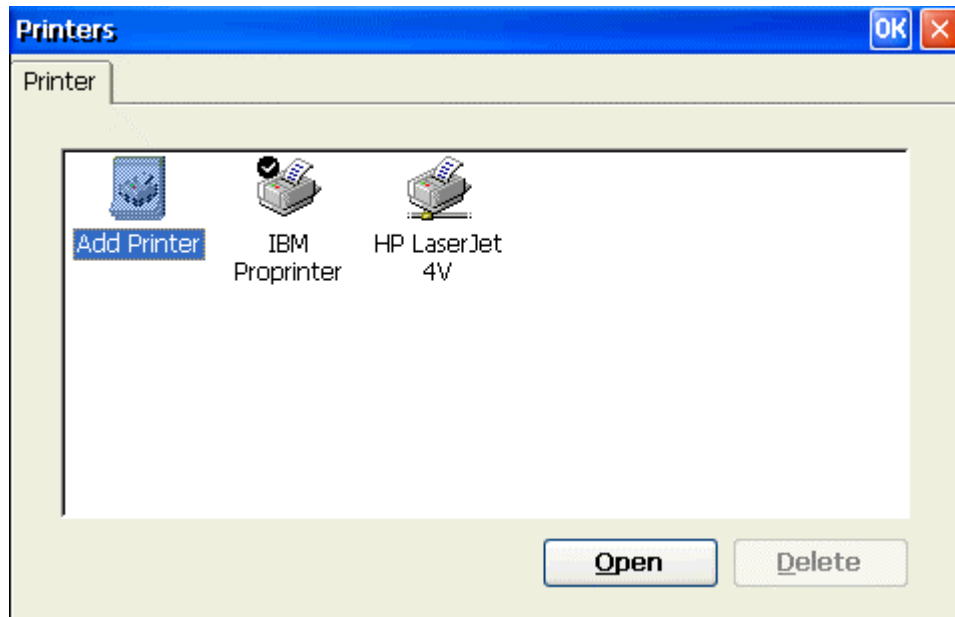

Add Printer

Double click on the "Add Printer" icon to reach the WBT Printer Wizard. This setup wizard provides five major steps to setup the printer.

Step1: Select the Printer Port

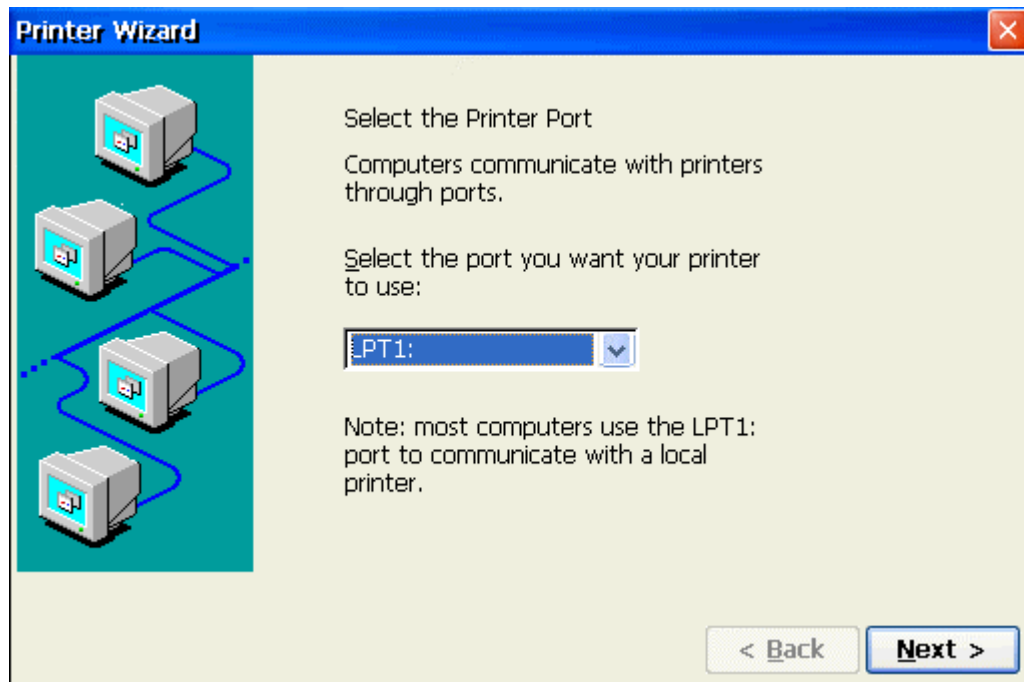

There are five different printing ports, COM1, COM2, LPT1, LPT2(USB) and network, to select from. If you do not have a USB printer attached, it will not appear in the list.

Step2: Select the Printer Model

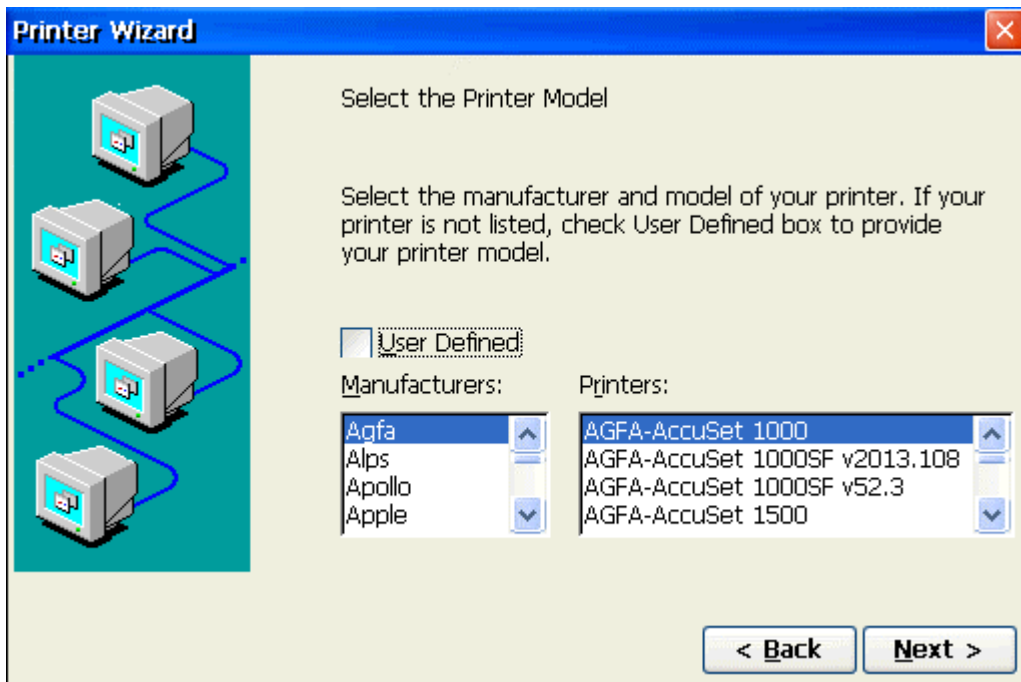

1. Use the first pull-down list to select the Manufacturers name.
2. Use the second pull-down list to select the Printer Model.
3. If your printer is not on the list, select the **User Defined** check box.

Step3: Name Printer or select User Defined Manufacturer and Model

If your printer is on the list:

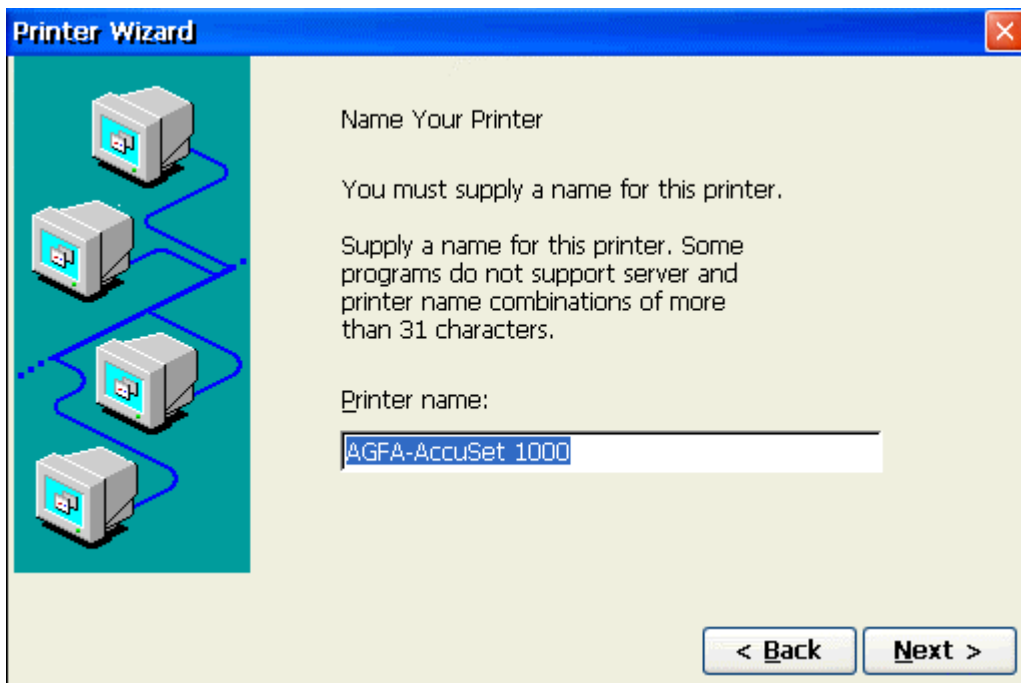

Select a name for your printer and skip to step 4.

User Defined Printer:

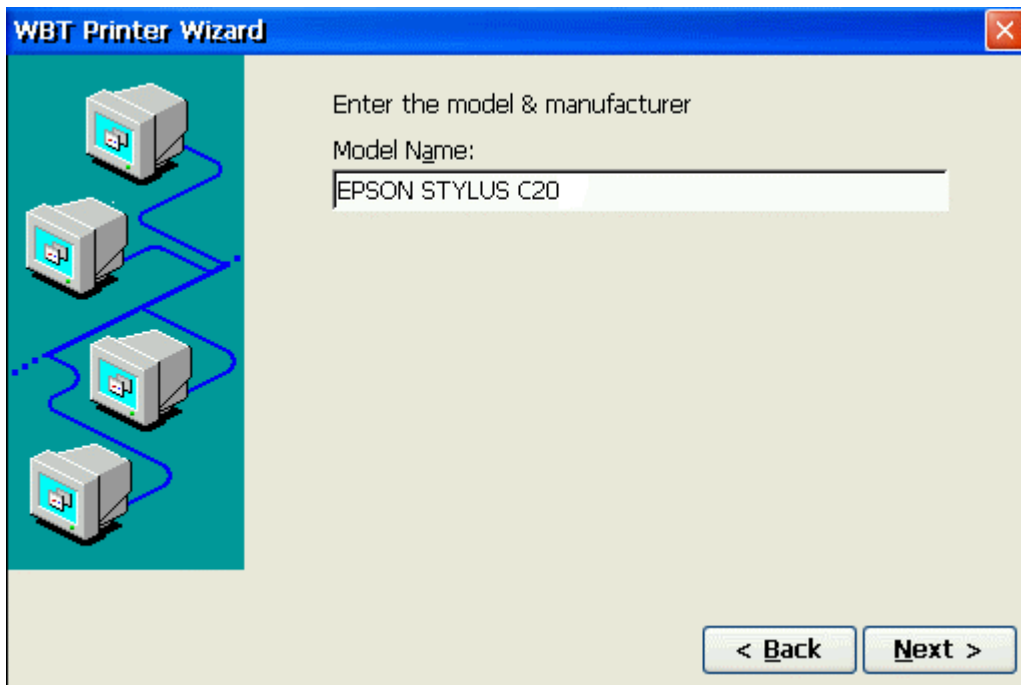

Type in the Manufacturers Name and Model number.

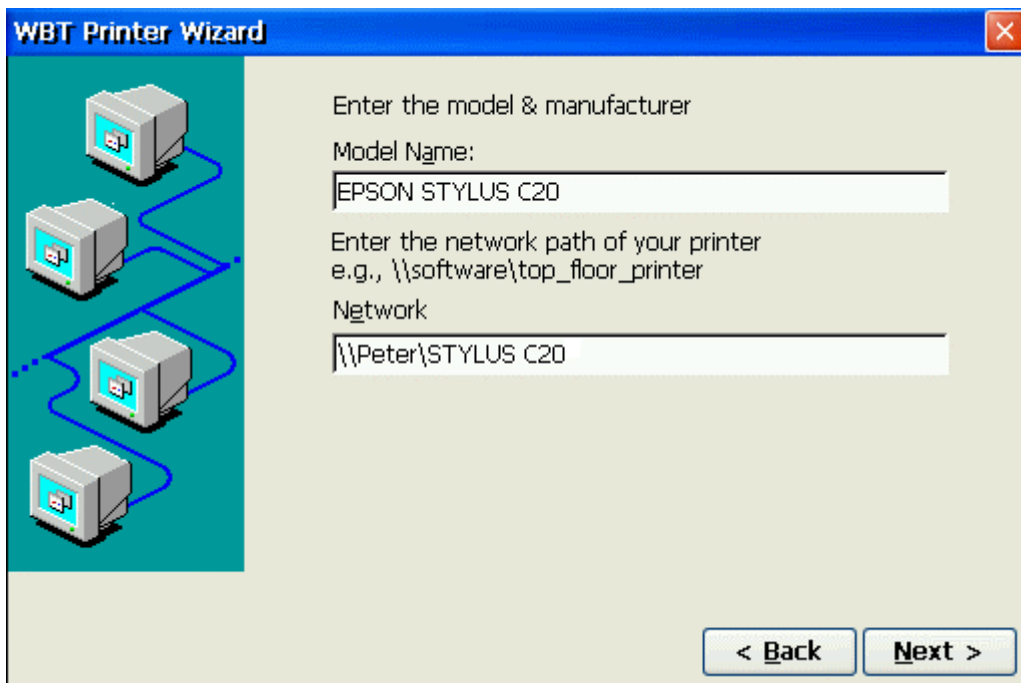

Type in network path and printer name.

Step4: Set Default Printer

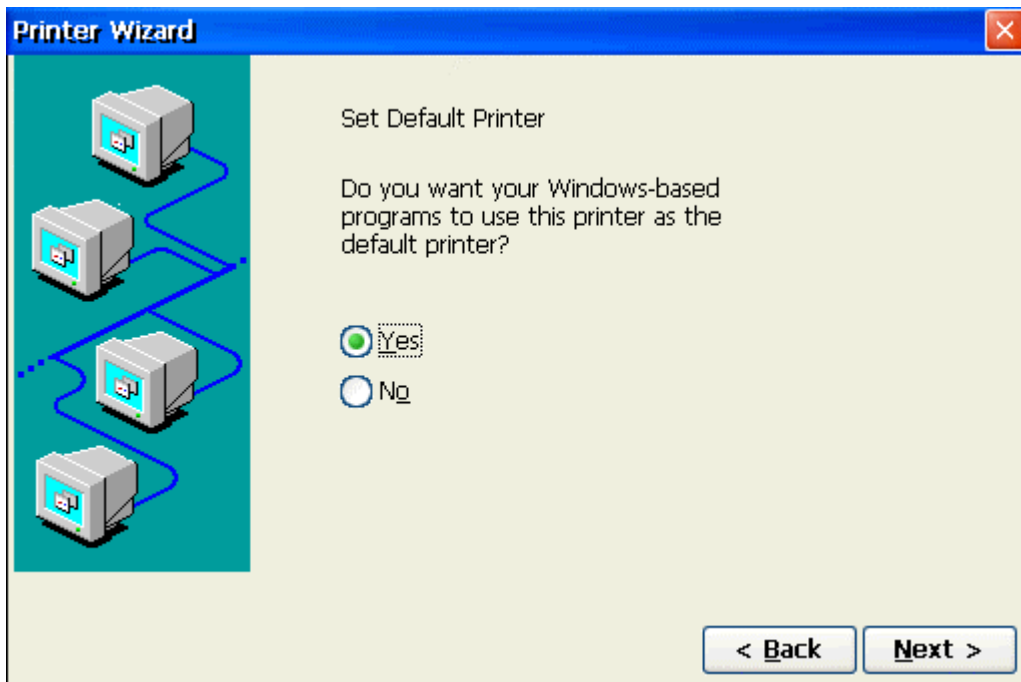

Select the appropriate radio button whether or not you want this to be your default printer.

Step5: Configure another printer

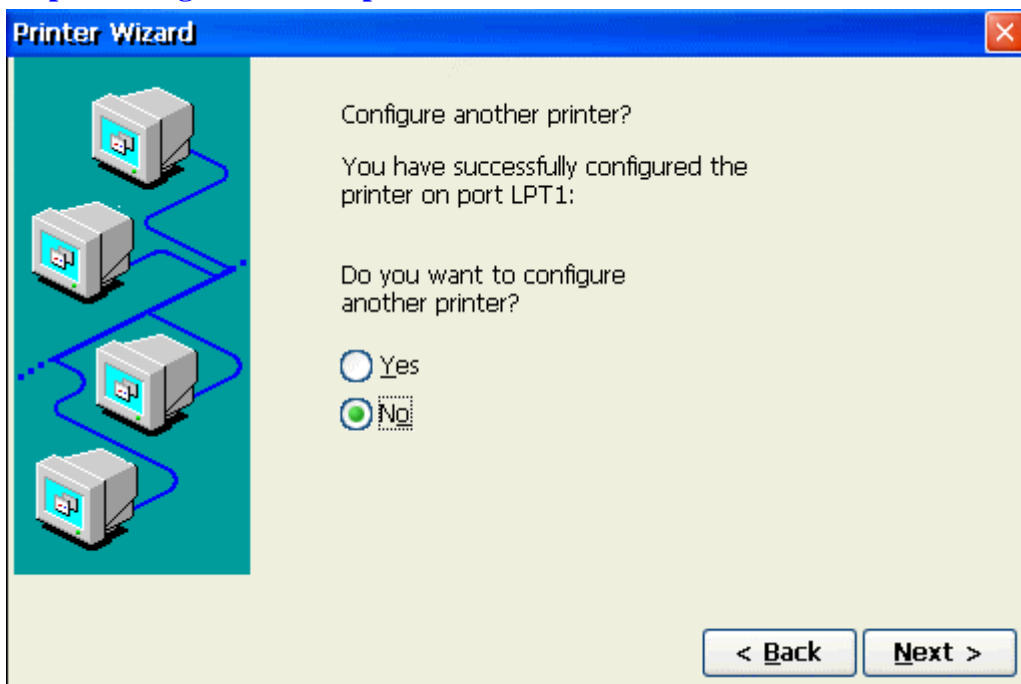

If you are done adding new printers, select **No**. If not, select **Yes** and return to Step 1.

Step6: Completed the Printer Setup

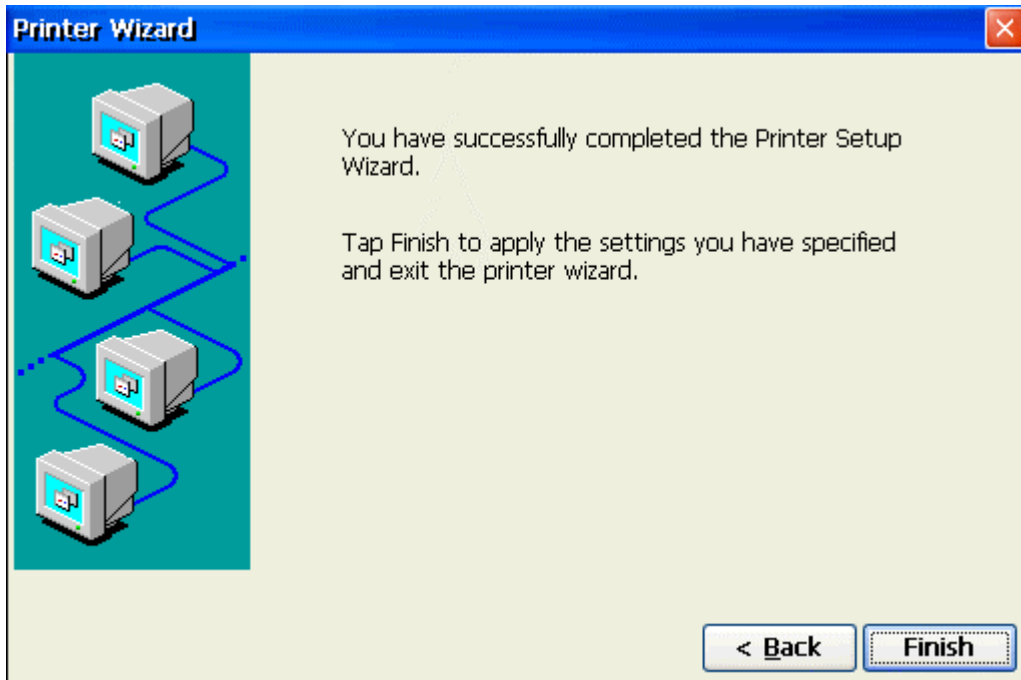

Click on **Finish** to complete the process.

RDP Setting

Use the RDP Local Resources Properties Sheet to configure your terminal's local audio and devices.

Local Resources Tab

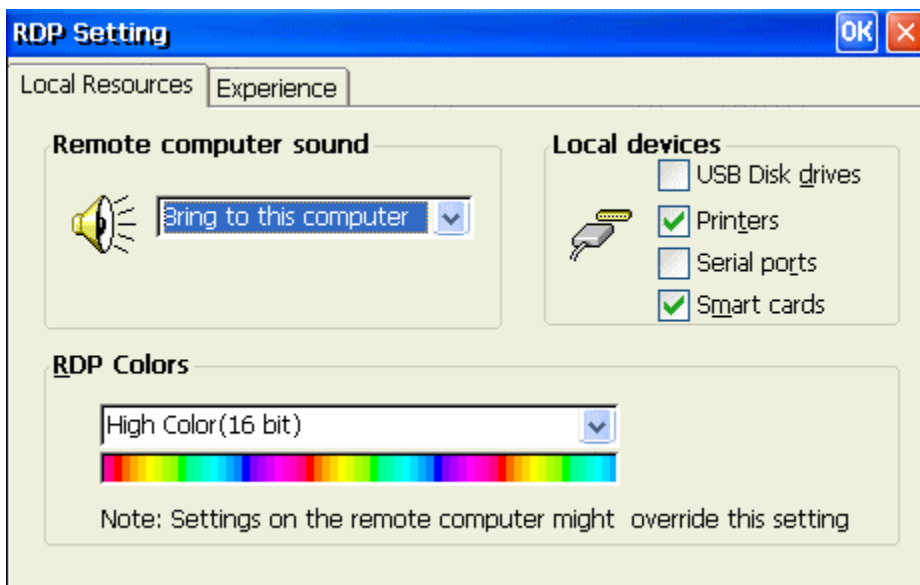

Remote computer sound

Select one of the following options from the pull-down list.

Bring to this computer -- Mapping the audio (sound) from the server to the terminal.

Do not play -- Mapping the audio (sound) from the server to the terminal.

Leave at remote computer -- Leave the audio at remote server, does not map the audio (sound) from the server to the terminal.

Local devices

USB Disk drives -- Enable local USB port mapping for USB Disk drivers such as USB FDD, HDD, Flash Disk and CDROM.

Printers -- Enable local parallel port mapping. It supports both parallel printers from LPT1 and USB printers from USB port.

Serials ports -- Enable local serial ports mapping.

Smart cards -- Enable local smart card mapping.

RDP Colors -- From the pull-down list, select the color resolution for the RDP session.

Experience Tab

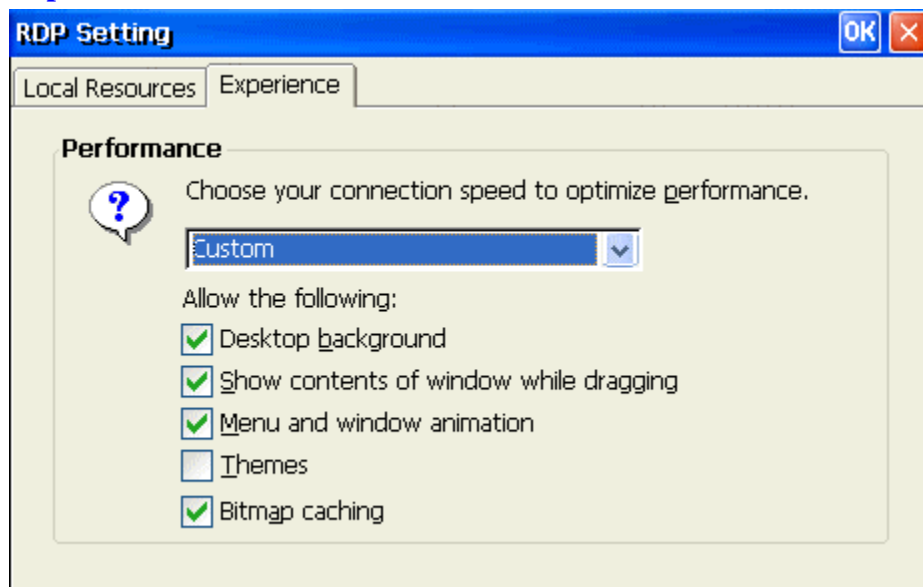

Use the RDP Experience options to choose your connection speed to optimize performance.

From the pull-down list, select your connection speed to automatically adjust the properties listed for optimum performance. If the connection speed is left to the default setting of "Custom", you can manually set the options yourself.

Security

Using the security dialog box, you can prevent someone from changing your terminal's properties.

Settings Window

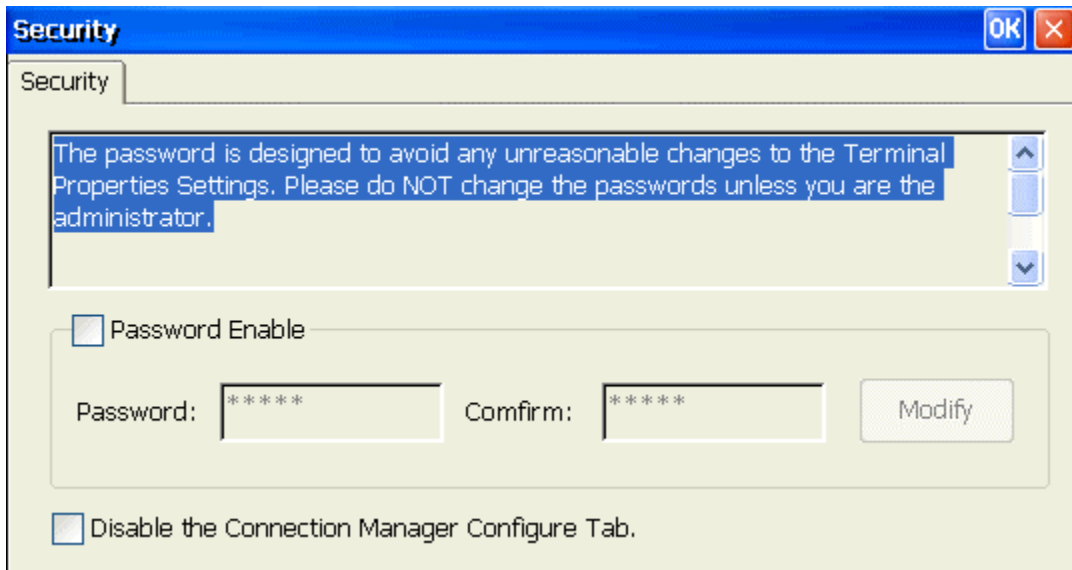

Enable Password

Enable this check box to activate the terminal's security. If enabled, you can set and confirm a new password. The factory default password is "guest".

Note: The password is designed to avoid any unreasonable change to the Terminal Properties Settings. Please do NOT change the password unless you are the administrator. If you forget the password, you will need outside assistance to get back in to configure the terminal. Please save your password carefully.

There are two methods to recover from forgetting the password.

- Contact your vendor for help. (to get a super password.)
- Use the Remote Management software to recall your terminal settings.

Disable Terminal Connection Configure Tab

Select this check box to disable the configure tab of terminal connection manager.

SNMP

Simple Network Management Protocol (SNMP) is the Internet Standard protocol for network management and part of the TCP/IP protocol suite. SNMP was developed by the Internet community to monitor and manage networks. It uses a distributed architecture that consists of managers and agents.

The SNMP agent is an SNMP application that monitors network traffic and responds to queries from SNMP manager applications. The agent also notifies the manager when significant events occur by sending a trap.

An SNMP manager is an SNMP application that generates queries to SNMP-agent applications and receives traps from SNMP-agent applications.

Settings Window

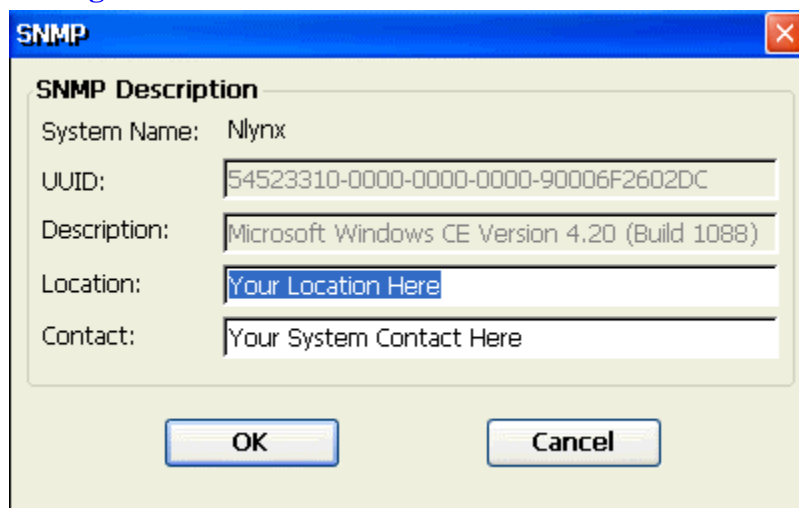

The image shows a screenshot of a Windows-style dialog box titled "SNMP". The dialog box has a blue title bar with a close button (X) in the top right corner. The main content area is titled "SNMP Description" and contains several text input fields:

- System Name: Nlynx
- UUID: 54523310-0000-0000-0000-90006F2602DC
- Description: Microsoft Windows CE Version 4.20 (Build 1088)
- Location: Your Location Here
- Contact: Your System Contact Here

At the bottom of the dialog box, there are two buttons: "OK" and "Cancel".

1. Type in the location of this device to so a network manager can easily find the terminal in case of any problems.
2. Type in the System Contact in case someone needs to be made aware of any problems.

System

The System Information window provides general terminal hardware configuration data such as product ID, memory configuration, Ethernet Mac address and software version numbers.

Information Window

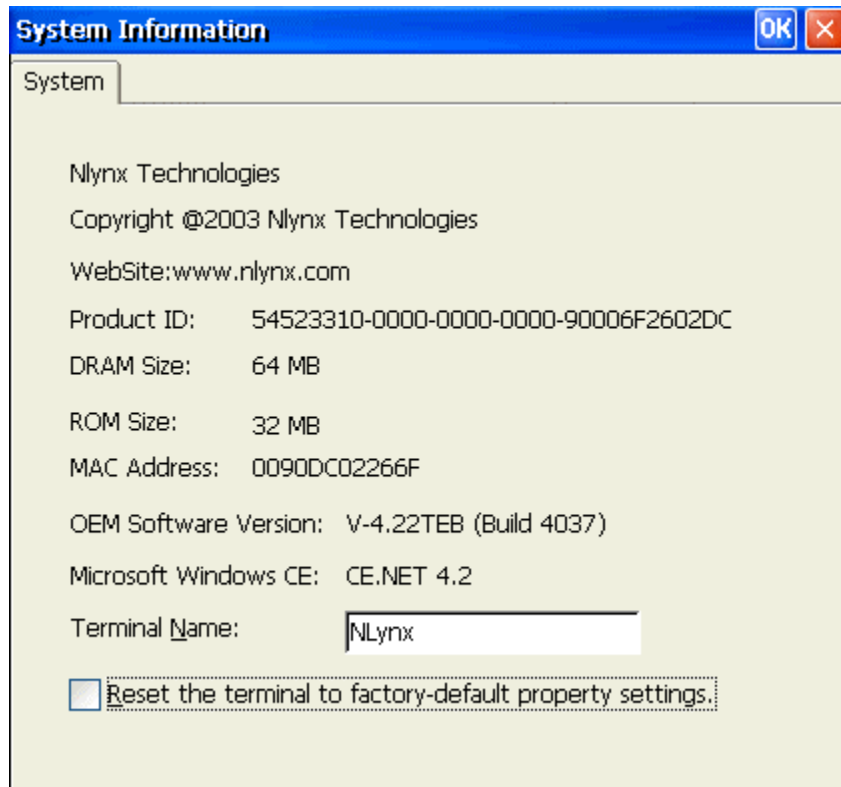

Terminal Name

Type in a unique **Terminal Name** so the device individually recognized by your server. Giving the WBT a unique name will insure access to network drives. For terminal emulation and/or web browsing requirements only, changing the device name is not necessary. The length of the terminal name is limited to a maximum of 15 characters.

Reset the terminal to factory-default property settings

Click on this check box to reset the terminal to its factory default setting. Because this process requires the unit to be re-booted, a confirmation box will appear.

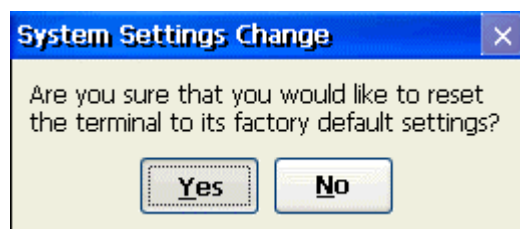

Click **Yes** to confirm the operation or **No** to cancel out.

OK

Click on **OK** button to save changes and quit the dialog box. Click on **X** button to quit the dialog box without saving changes.

ThinPrint

The ThinPrint enables direct printing program from the terminal to network printers. Together with Citrix MetaFrame application server software, this new feature gives a powerful solution for remote offices and wireless LANs. With this new ThinPrint Client, a print job can be delivered over the Citrix ICA protocol to the device and from there direct to the network printer; there is no longer a need for a print server in addition to a network printer.

Enable Window

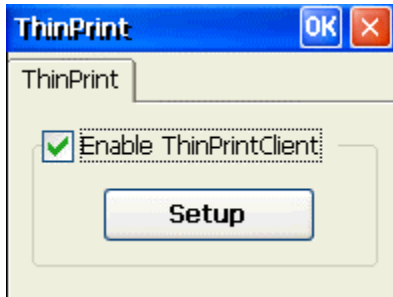

1. If it is blank, click on the **Enable ThinPrintClient** check box to enable the ThinPrinterClient.
2. Click the setup button to open the ThinPrint properties window.

Setup Tab

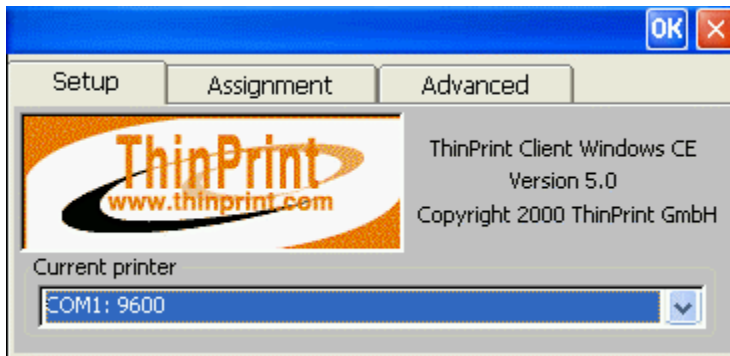

Assignment Tab

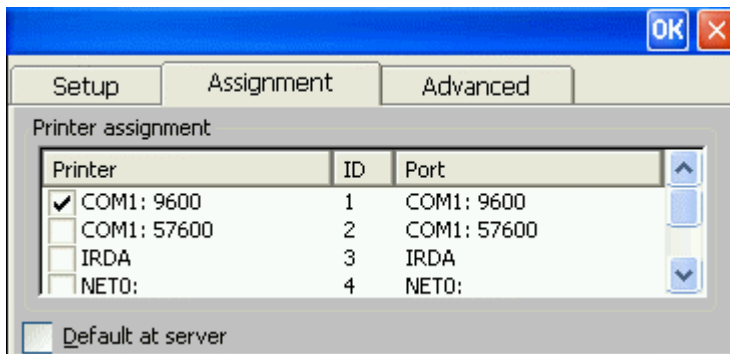

Advanced Tab

OK X

Setup Assignment Advanced

Bandwidth (bits/sec) 0 TP TCP port 4000

Quit Client

NLynx TN5250 Terminal Emulation

5250 Terminal Session Setup

From the terminal desktop, click on the “Connection Manager” icon (shown below) to bring up the “Terminal Connection Manager” setup window. This is the same as selecting **Start > Programs > Connection Manager** from the Taskbar Menu.

Connection Manager Desktop Icon



1. Once the Connection Manager window is open, select the Configure tab.
2. Click on the Add button to bring up the New Connection dialog box.

Connection Manager Window

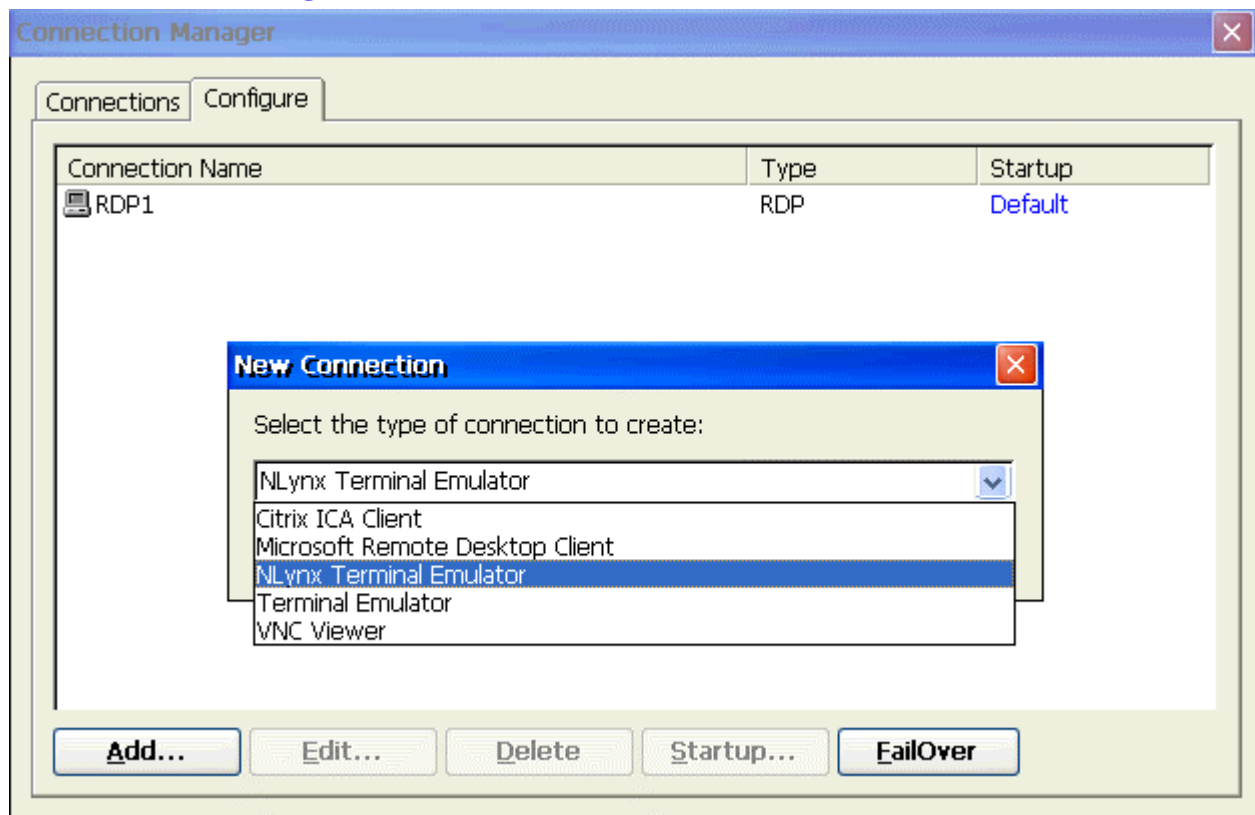

1. Select the NLynx Terminal Emulator option from the pull down list and click on the OK button.

Configure Dialog Box

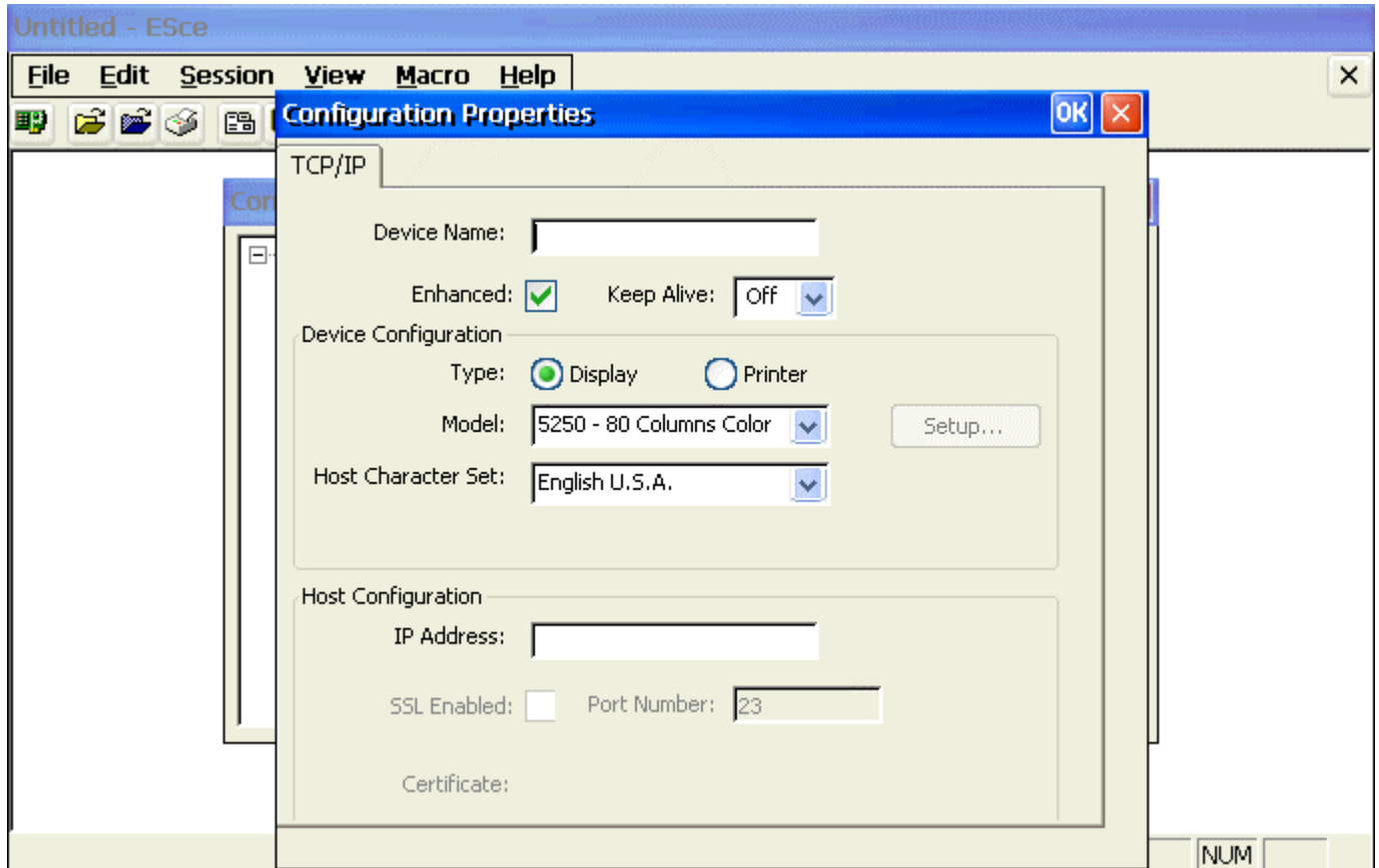

1. Type in a Device Name. The device name is used to identify which devices you are using when running the emulator.

Note: It is recommended that you use a device name that has part of your IP Address or Work Station Address at the end. For TN5250E sessions where the name provided is shown on the AS/400, the initials or name of the user is helpful. It is also useful to reference the application that the session is usually used for.

You can use any number and letter combinations along with the characters @ \$ and _ up to a maximum number of 10 for TN5250E sessions.

- The characters ? < > , . / \ | * and * are not accepted by the input field
 - The characters - (dash) and (space) are accepted by the field but are not allowed by the AS/400.
 - The characters ~ ! % ^ & () - + = { } [] are allowed but should be avoided because the character will be changed to a # at the AS/400.
2. For the Device Configuration Type, select Display.
 3. Select either the 80 or 132 column display options from the Model pull down list.
 4. Select the appropriate option from the Host Character Set pull down list.
 5. Type in the IP Address of the 5250 Host computer. If you have a DNS server on the network, you may type in a host name instead of an IP address.
 6. Click the OK button to complete the setup. The session should now appear in the Connection Manager window.

5250 Printer Session Setup

1. From the terminal desktop, click on the “Connection Manager” icon (shown below) to bring up the “Terminal Connection Manager” setup window. This is the same as selecting **Start > Programs > Connection Manager** from the Taskbar Menu.
2. Once the Connection Manager window is open, select the **Configure** tab.
3. Click on the **Add** button to bring up the New Connection dialog box.
4. Select the N Lynx Terminal Emulator option from the pull down list and click on the **OK** button.

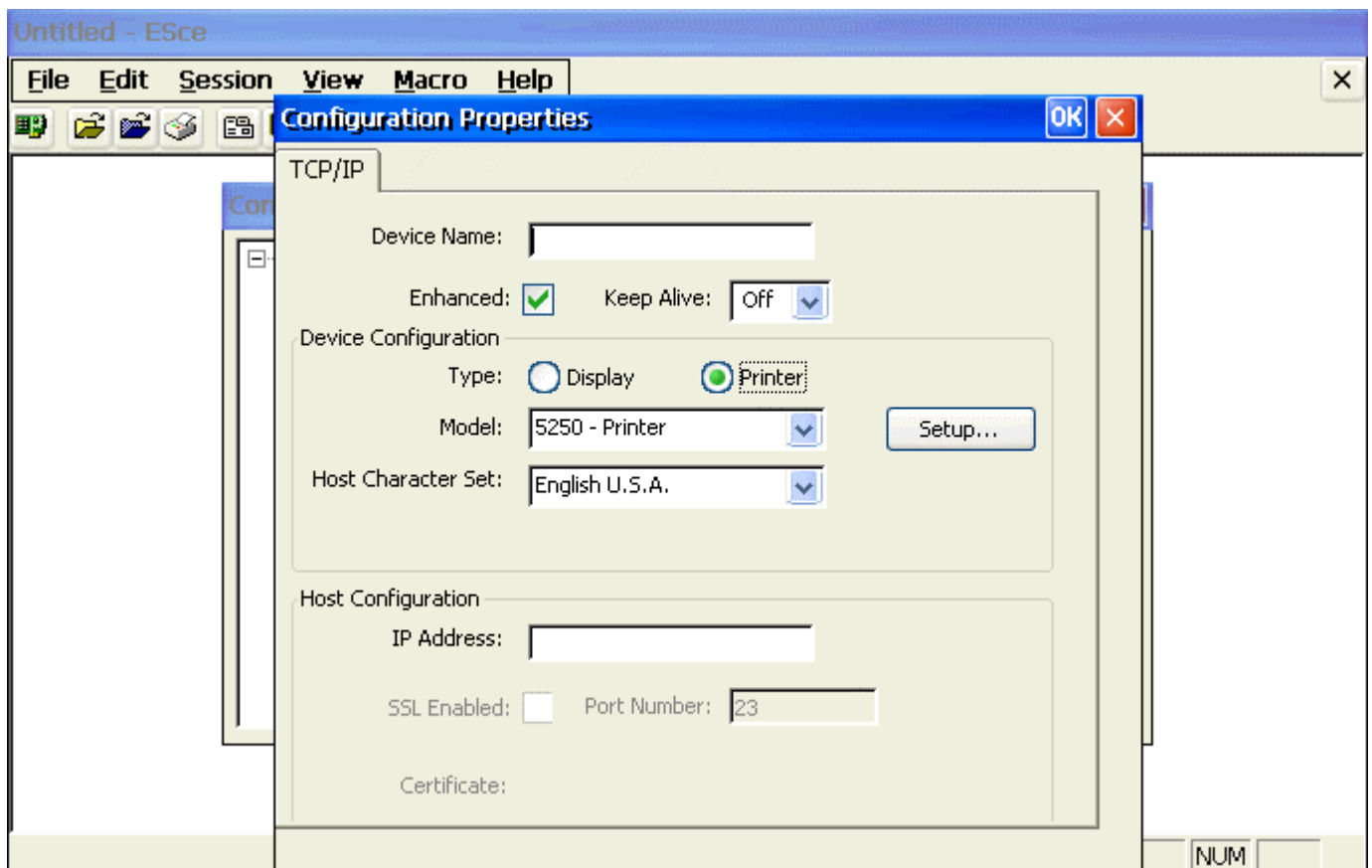

5. Type in a Device Name. The device name is used to identify which devices you are using when running the emulator
6. For the Device Configuration Type, select Printer.
7. Select the Setup button to bring up the Printer Setup window.

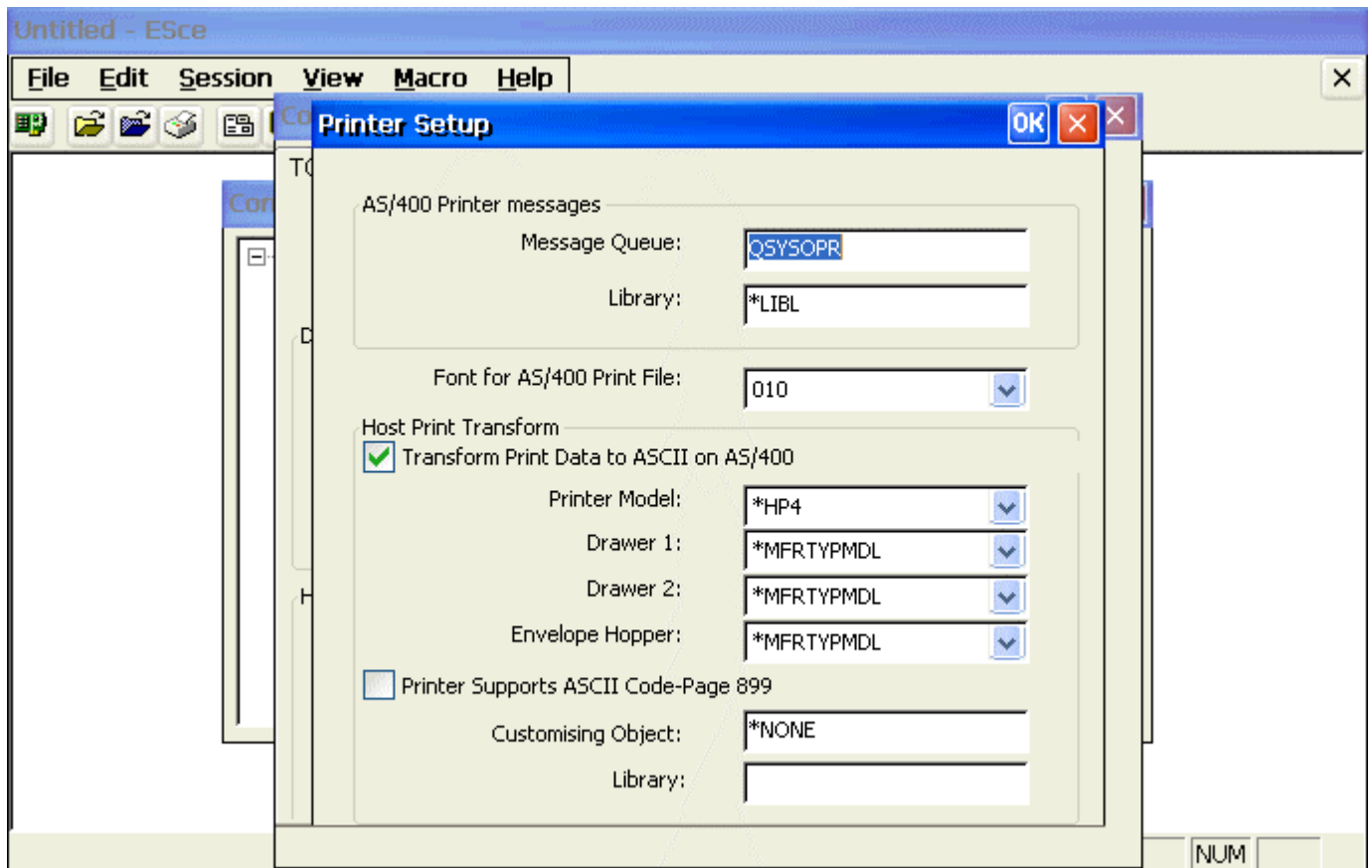

8. Leave the default as is or enter in another name of the AS/400 Message Queue where you want printer messages to be sent.
9. Leave the default as is or enter in another Library name that contains the list of printer messages.
10. Leave the default as is or select another AS/400 printer font file from the drop down list.
11. Place a check in the Transform Print Data to ASCII on AS/400 check box to select Host Print Transform.

Note: See your MIS Administrator for device settings entered here. By selecting Host Print Transform, the “Printer Selection Menu” will change and several new options appear. The printer you are using and OS of the AS/400 determine the settings here. The most important setting here is **Printer Model**.

12. Select the Printer Model from the drop down list or type it in the window directly.
13. Select the paper source from the drop down lists for each of the Drawer1, Drawer2 and Envelope Hopper options. If you leave the default setting *MFRTYPMDL as is, the system uses the suggested setting for this printer type.
14. If the Printer Supports ASCII Code-Page 899, place a check in the check box.
15. Click OK to complete this screen.
16. Type in the IP Address of the 5250 Host computer. If you have a DNS server on the network, you may type in a host name instead of an IP address.
17. Click the OK button to complete the setup. The session should now appear in the Connection Manager window.

Starting a Session

There are three ways to start a NLYnx emulation session.

Method 1. Autostart a Session on Power Up

Using the "Connection Startup Dialog Box", you can pre-set sessions to automatically connect to their servers when terminal is turned on.

1. From the terminal desktop, click on the "Connection Manager" icon (shown below) to bring up the "Terminal Connection Manager" setup window. This is the same as selecting **Start > Programs > Connection Manager** from the Taskbar Menu.
2. Once the Connection Manager window is open, select the **Configure** tab.
3. Select a session that you want to Startup when the MinIT6000 is turned on and click on the "Startup" button.

Connection Startup Dialog Box

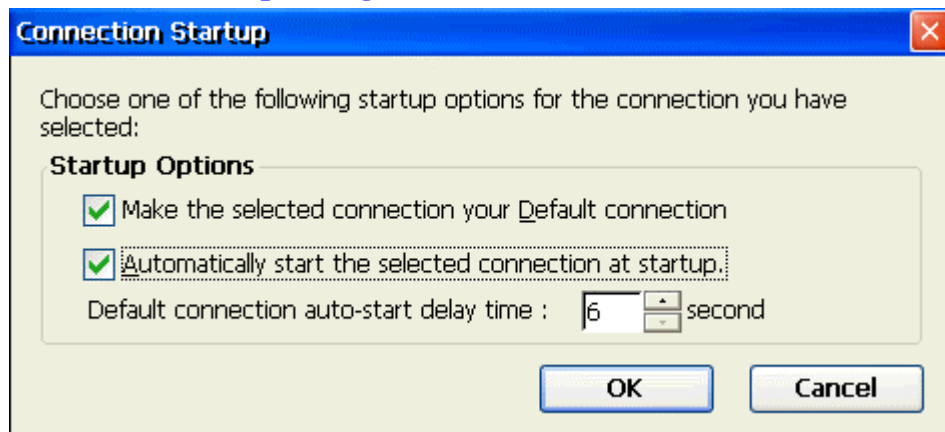

4. Place a check mark by the Make the selected connection your default connection option if you want this session to be your default connection.
5. Place a check mark by the Automatically start the selected connection at startup option to enable the Autostart function.
6. Adjust the auto-start delay time by changing the "seconds" value. This might be important in some networks because it allows the unit enough time to obtain DHCP information from the DHCP server (if set for) before it tries to connect to the host.
7. Click the OK button to complete the setup.
8. Repeat steps 3 - 7 for any additional sessions that you would like to auto-start.
9. Click on the X to close the Connection Manager

Method 2. From the Connection Manager

1. From the terminal desktop, click on the "Connection Manager" icon (shown below) to bring up the "Terminal Connection Manager" setup window. This is the same as selecting **Start > Programs > Connection Manager** from the Taskbar Menu.
2. Once the Connection Manager window is open, select the **Connections** tab.

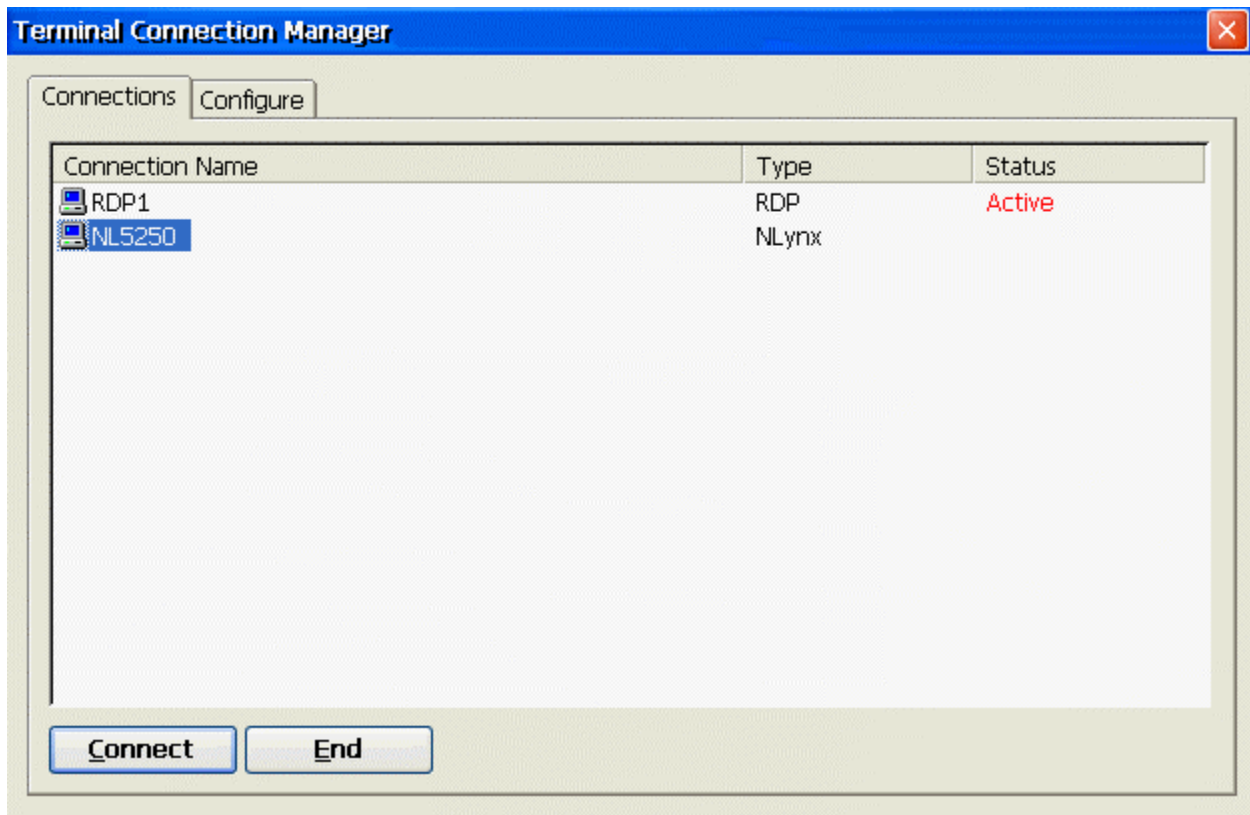

3. Select the Connection that you wish to start.
4. Click on the **Connect** button to start the session.
5. Click on the **X** button to close the Connection Manager window.

Method 3. From the Start menu

1. From the terminal desktop, Select Start > Programs > Connections > session name from the Taskbar Menu.

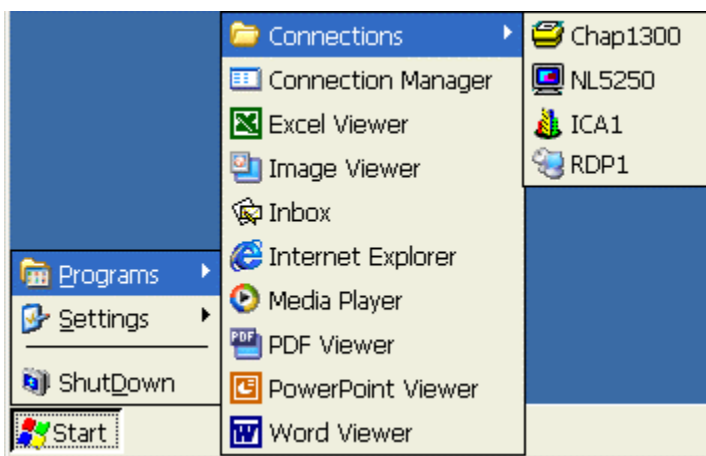

Using the Toolbar Buttons



Configure normally would bring up the **Configure Devices** window however, it is not active in this version of the emulator because devices can be configured through the Connection Manager. This is the same as selecting **File > Configure**.



Open brings up the **Open** window at the root directory. Used to open or find a display or printer session file. This is the same as selecting **File > Open**.



Open Display brings up the **Open** window at the DiskOnChip directory showing the available display session files. This allows you to select a pre-configured session file. This is the same as selecting **File > Open Display**.



Open Printer brings up the Open window at the DiskOnChip directory showing the available printer session files. This allows you to select a pre-configured session file. This is the same as selecting **File > Open Printer**.



Properties brings up the **ESce Display** dialog window. This allows you to edit/change the session properties. This is the same as selecting **Session > Properties**.



Connect starts the connection between the PC and the host computer. This is the same as selecting **Session > Connect**.



Disconnect breaks the connection between the PC and the host computer. Always sign off the host computer before disconnecting. This is the same as selecting **Session > Disconnect**.



Print prints the active host screen. This is the same as selecting **File > Print**.



Record Macro turns on the macro recorder. All keystrokes are recorded in the macro file until you press Stop. This is the same as selecting **Macro > Record > Record**.



Stop Recording turns off the macro recording. You will be prompted to enter a name for the macro file which will be saved to the folder containing the emulator program files. This is the same as selecting **Macro > Record > Stop**.



Pause Recording pauses an in-progress macro. To begin recording again, choose Record. This is the same as selecting **Macro > Record > Pause**.



Play Macro plays a macro that has been recorded and saved. You will be prompted to choose a macro file to play. This is the same as selecting **Macro > Play > Play**.



Stop Macro stops a macro during playback. This is the same as selecting **Macro > Play > Stop**.



Pause Macro pauses the macro during playback. To restart the macro, select play. This is the same as selecting **Macro > Play > Pause**.

Other Menu Functions

- **File > Save As** allows you to enter a different name for an existing session file.
- **File > Exit All** ends all active emulator connections at the same time. To close one emulator connection at a time, use the Exit command.
- **File > Exit** ends the currently selected active emulator connection. To close all active emulator connections at one time, use the Exit All command.
- **Edit > Copy** copies the selected area of the host screen to the Clipboard.
- **Edit > Paste** pastes the contents of the Clipboard to the specified location.
- **Edit > Select All** selects the entire screen so you can copy it to the clipboard.
- **Edit > Clear Selection** clears the selection box from the host screen.
- **View > Main Toolbar**, select to toggle the command key toolbar on and off.
- **View > Function Keys**, select to toggle the function key toolbar on and off.
- **View > Full Screen**, select to toggle full screen mode on and off.

Note: To close or exit an active session window when you are in **Full Screen** mode, select the <ALT> key to bring up the **File** menu window. This will allow you to select either the **Exit All** or **Exit** menu functions.

- **View > Ruler**, select to toggle displaying the ruler.
- **View > Status Bar**, select to toggle the status bar on and off.
- **View > Test Screen** Displays the color attributes. Type an attribute number and select enter to display that attribute in the input field box.
- **Help > About** displays the version information.

Editing Session Properties

There are two ways to edit an N Lynx emulation session.

Method 1. From the Connection Manager

This method allows you to edit all basic session properties except the main TCP/IP settings. To change the "Device Name" or "Host IP Address" information, please refer to [Method 2](#).

1. From the terminal desktop, click on the "Connection Manager" icon (shown below) to bring up the "Terminal Connection Manager" setup window. This is the same as selecting **Start > Programs > Connection Manager** from the Taskbar Menu.
2. Once the Connection Manager window is open, select the **Configure** tab.
3. Click on the **Edit** button to bring up the ESce Display window.

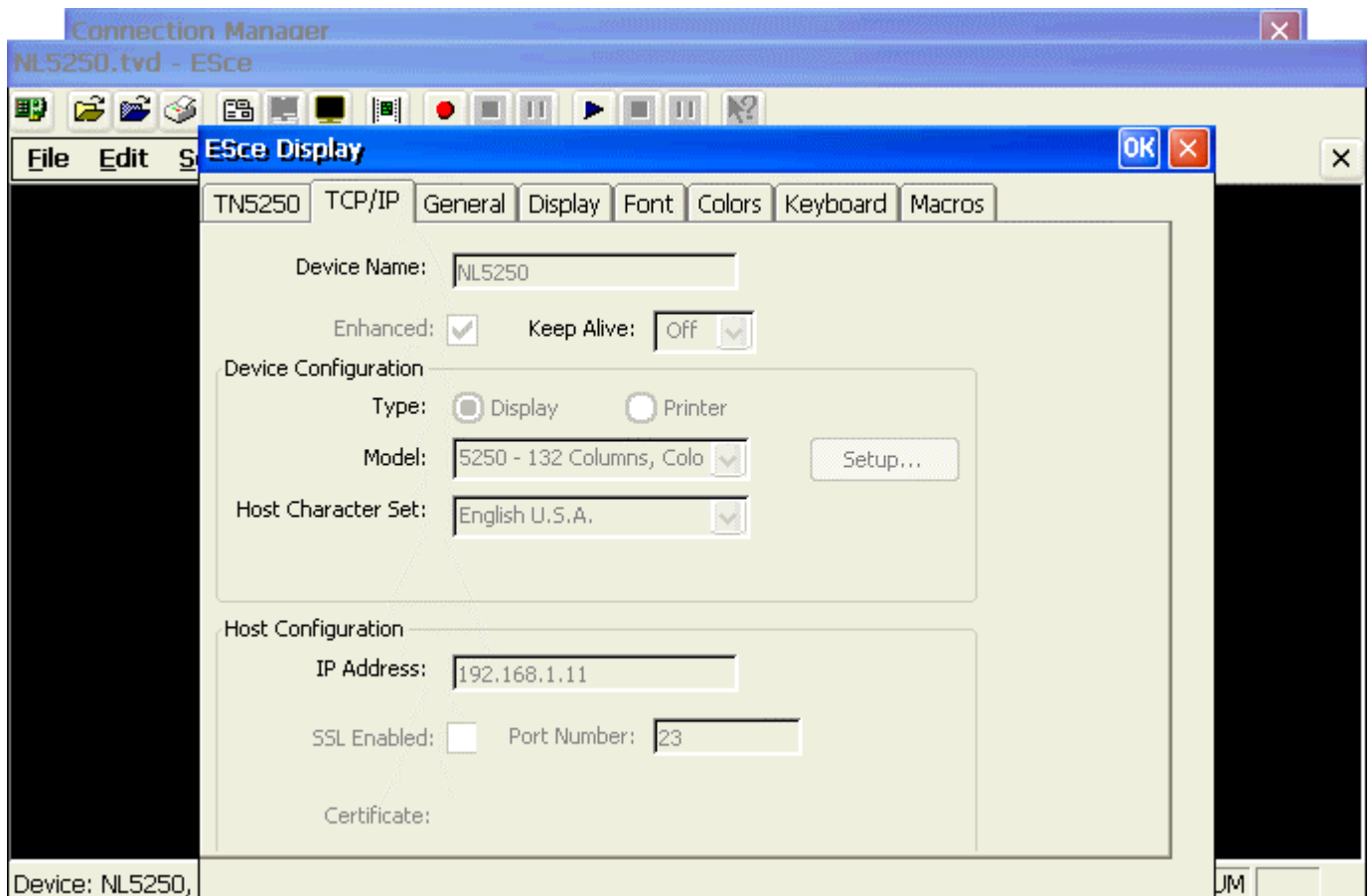

4. Select the appropriate tab to modify the specific entries.

General Tab

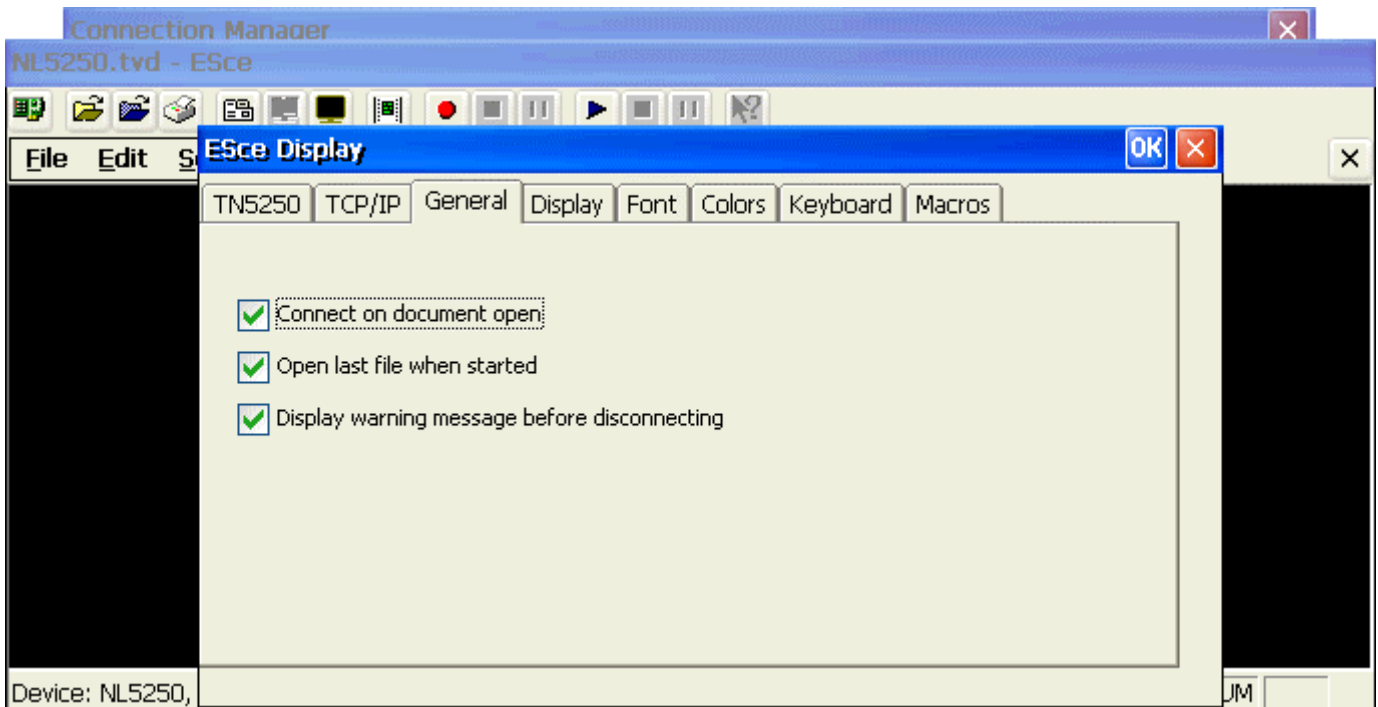

These options are session independent. Place a check mark in the appropriate check boxes to enable the indicated operations.

Display Tab

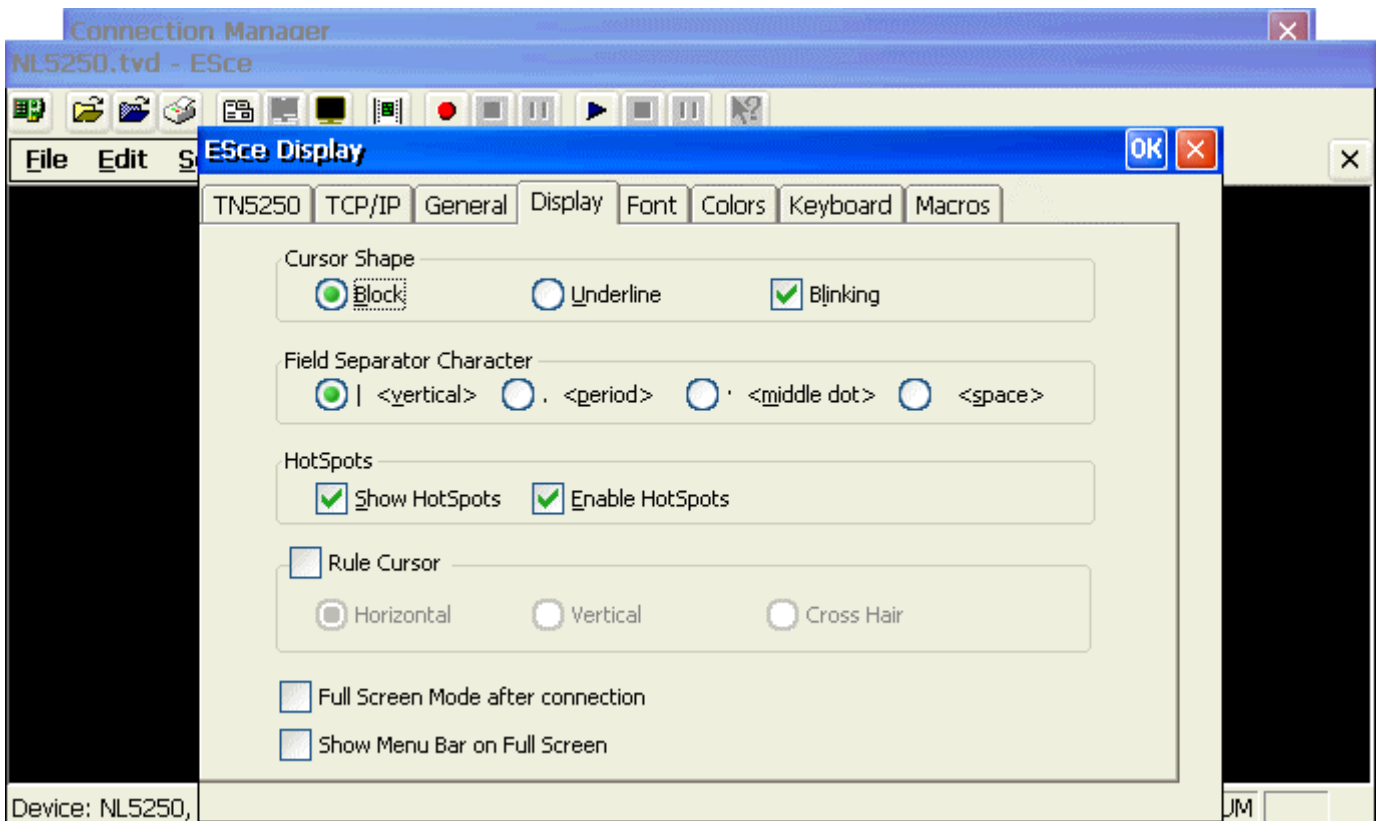

Change the value for **Cursor Shape**, **Field Separator Character**, **Hot Spots**, **Rule Cursor** and **Full Screen Mode** by selecting the appropriate options and/or enabling the appropriate action.

Font Tab

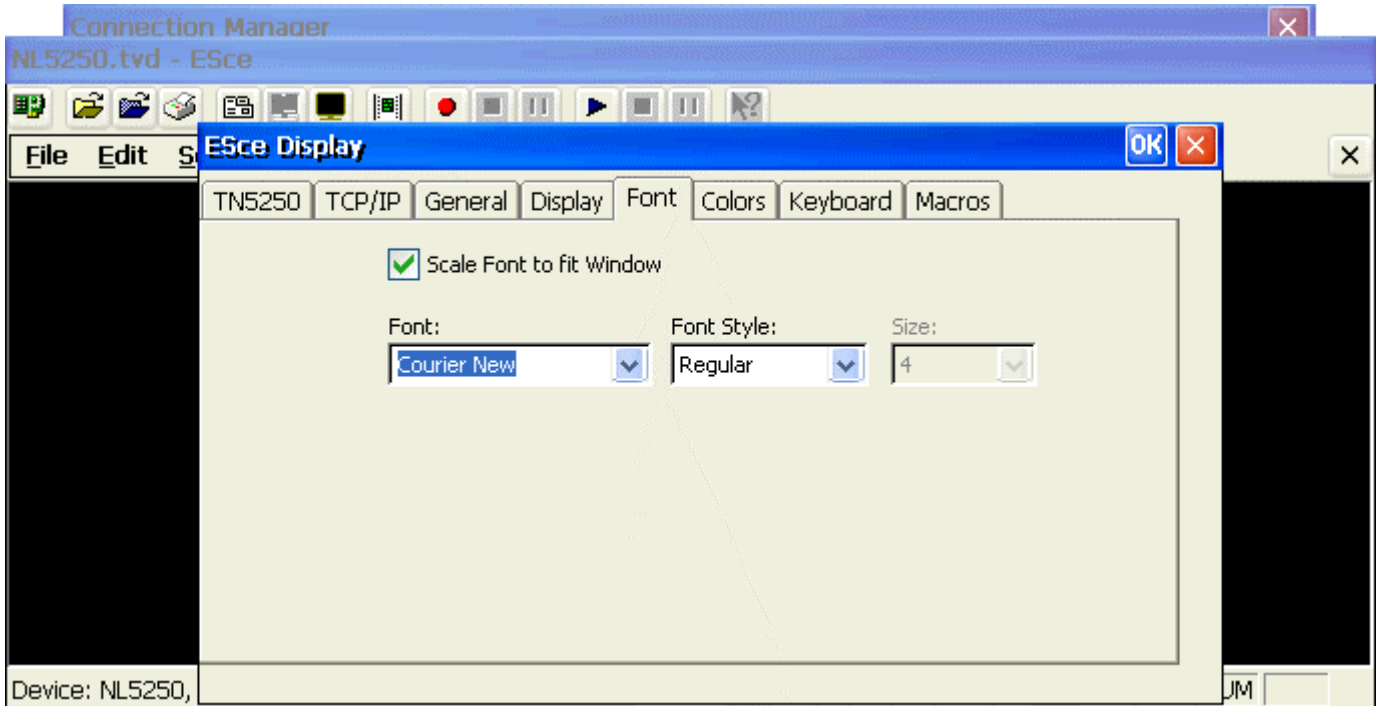

Select the appropriate **Font** and **Font Style** from the available pull down lists. Place a check mark in the check box to **Scale Font to fit Window**.

Colors Tab

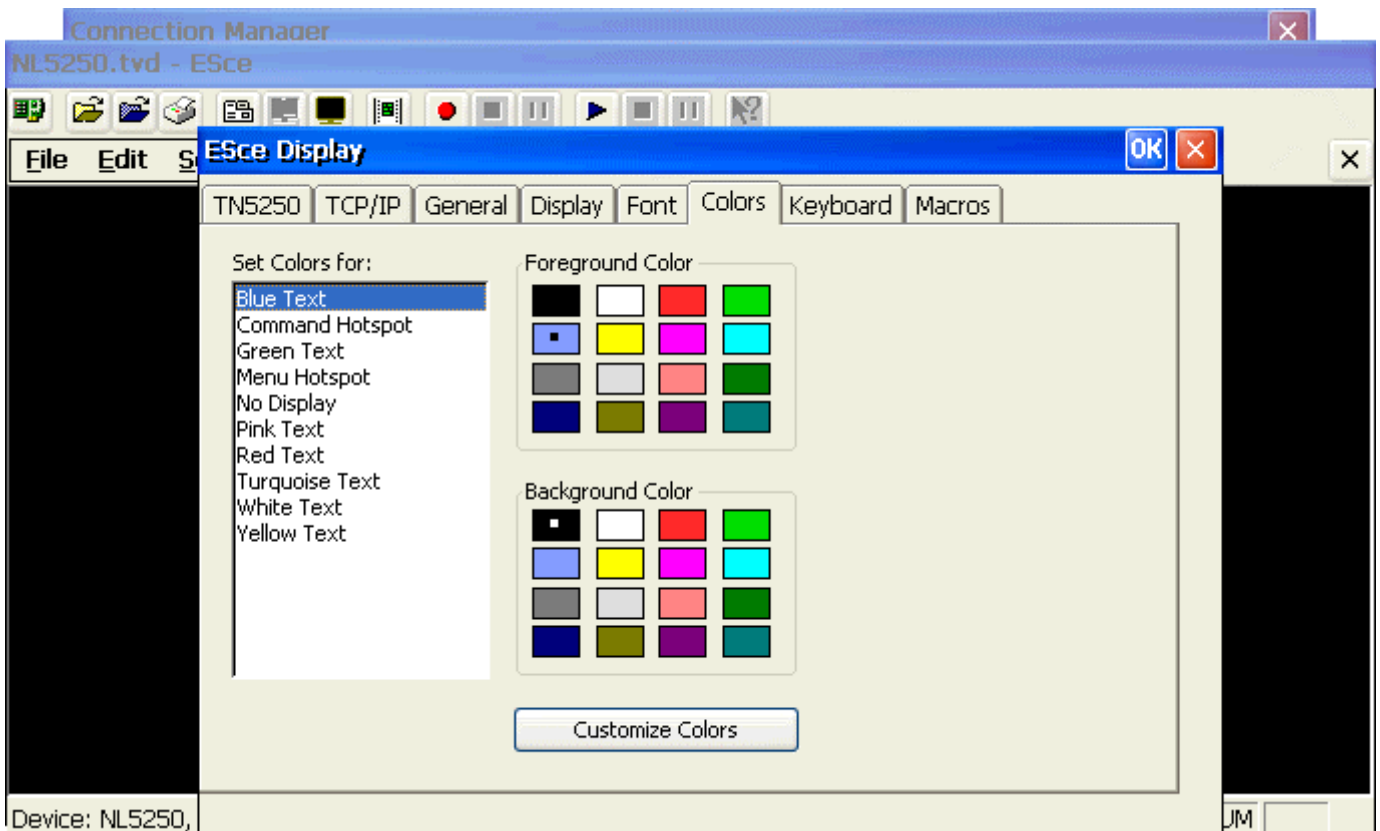

Keyboard Tab

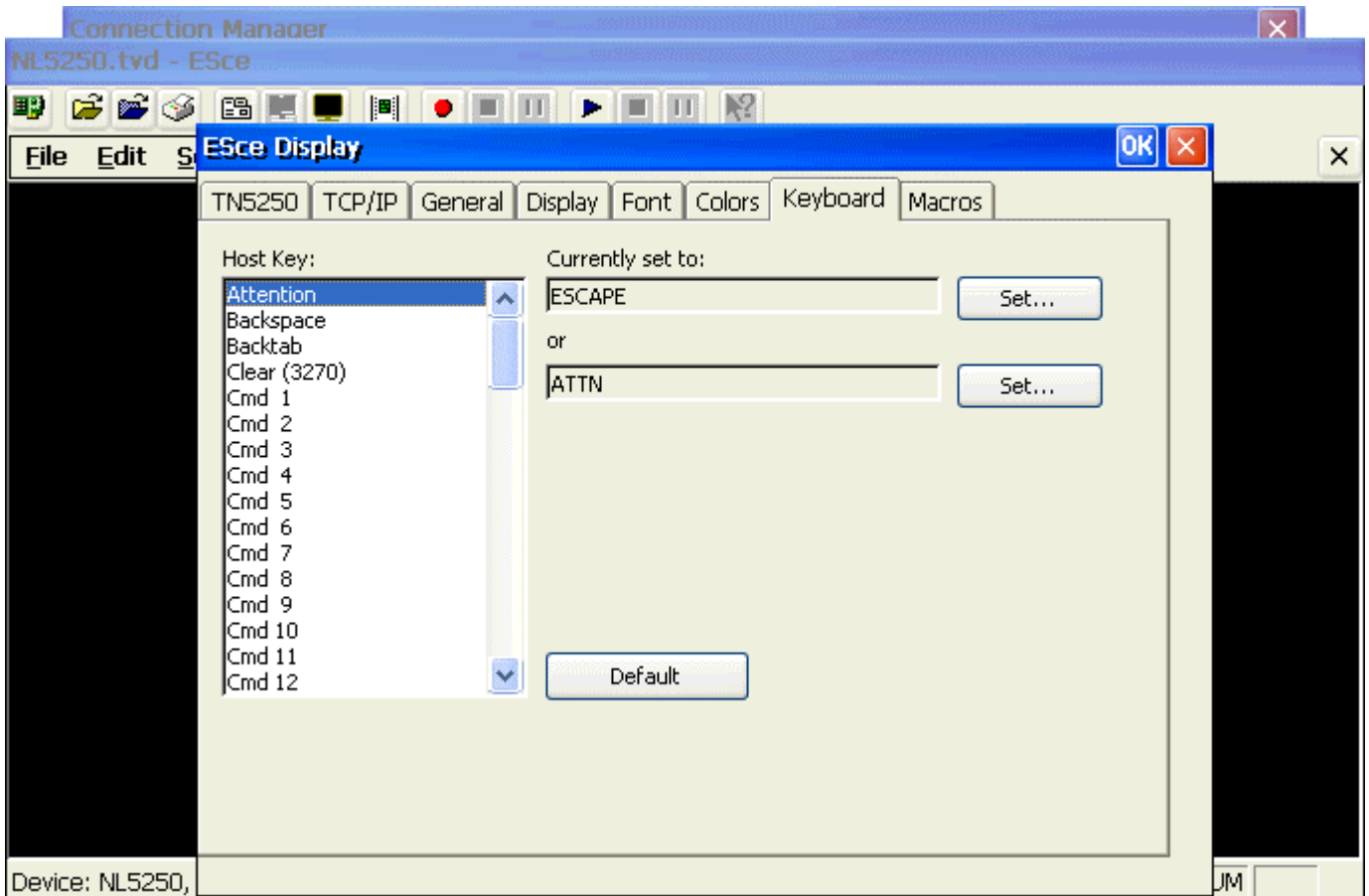

1. Modify the keyboard mapping by selecting a **Host Key** to be remapped.
2. Select the **Set...** button. This will bring up the following dialog box

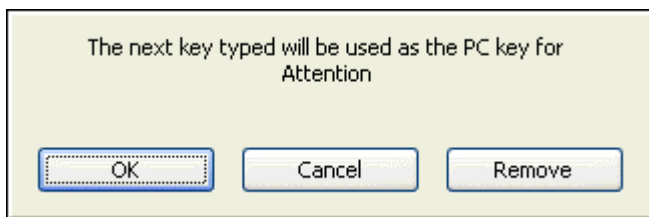

3. The next key you type will become the key you want to use for that **Host Key** function.
4. After the conformation text has appeared, select the OK button to complete the process.

TN5250 Tab

The **Connection Name** is always **TCP/IP** and the tab name is the same even if you have selected a 3270 session. There is no reason to make any changes here.

Method 2. From the Session Window

1. Start the appropriate N Lynx emulation session that you wish to edit from the Connection Manager or by selecting **Start > Programs > Connections > session name** from the Taskbar Menu.

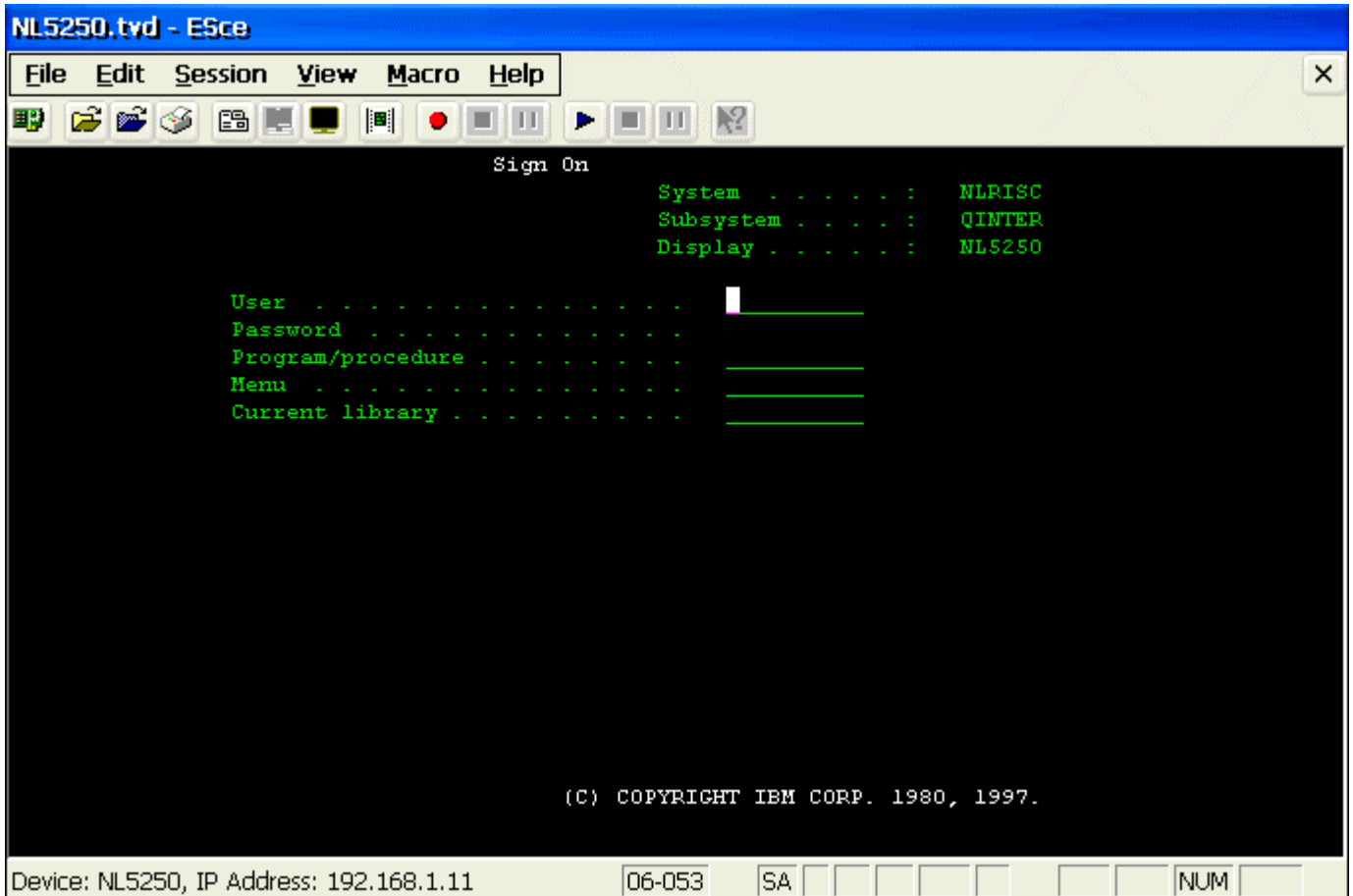

1. Click on the **Disconnect** icon on the toolbar to break the connection between the MinIT6000 and the host computer.
Note: This is very important because it will allow you to modify the TCP/IP information such as the Device Name and Host IP Address.
2. Click on the **Properties** icon on the toolbar to bring up the ESce Display window.
3. Select the appropriate tab to modify the specific entries.

Text Terminal Emulator

Please see the [PT User's Guide.pdf](#)

Citrix ICA Client

Please see the [ICA User's Guide.pdf](#)

Email User's Guide

About

You can send and receive e-mail by connecting to a POP3 or IMAP4 server. Inbox contains an e-mail service for each method you use. For example, if you receive e-mail through a connection to a POP3 server and through a connection to an IMAP4 server, Inbox will contain two services: POP3 Mail and IMAP4 Mail. Each e-mail service has its own folder hierarchy with four default folders: Inbox, Outbox, Deleted (local), and Sent. The messages you receive and send through the mail service are stored in these folders

Starting Email

Similar to a PC, the Email Client is opened through the Start Menu bar.

Bringing up Email

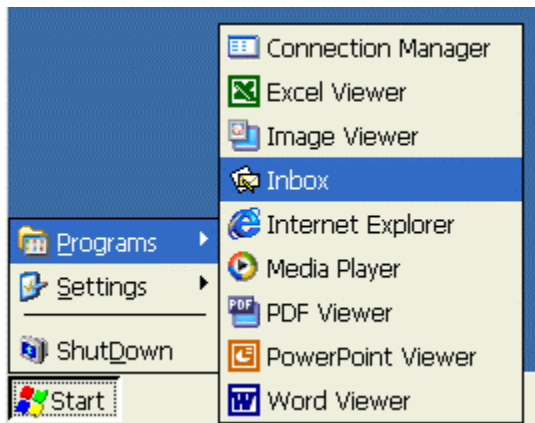

To bring up Email, select **Start > Programs > Inbox** from the “Start” menu on the desktop.

Email Client Window

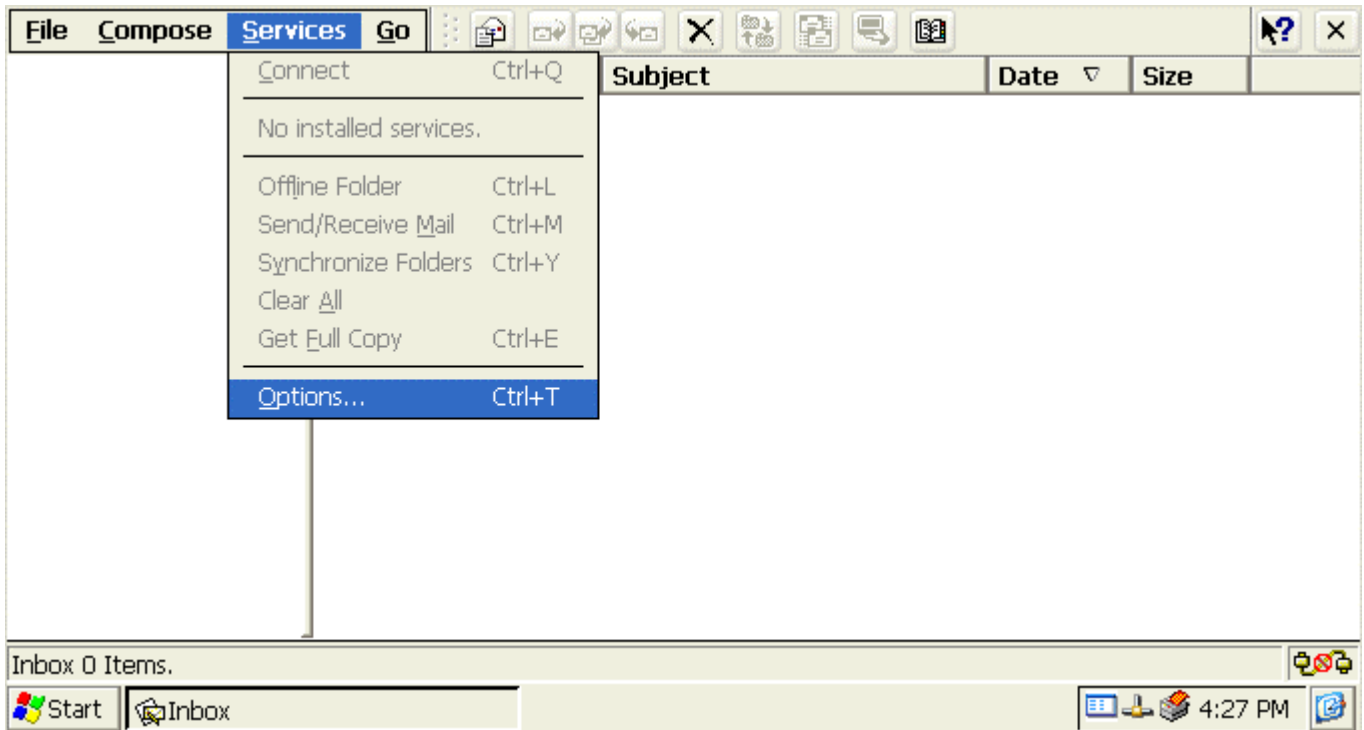

Setup Mail Service

To connect to your POP3 or IMAP4 mail server, you need to set up an Inbox mail service.

1. Begin by clicking on the **Options** selection under the **Services** pull-down menu. This will bring up the **Options** dialog box.

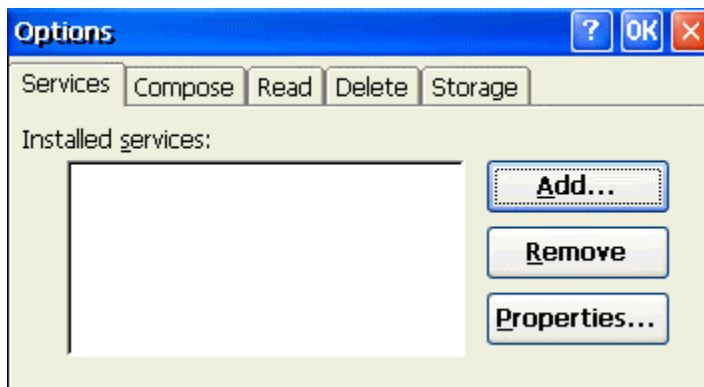

2. Click on the **Add** button to create a new service.

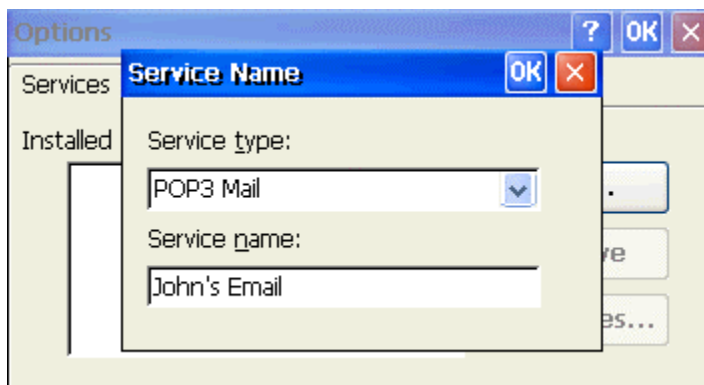

3. From the Service type list, select POP3 Mail or IMAP4 Mail. (POP3 is the most common mail protocol for ISPs).
4. Enter a unique name for the Service name and select OK.
5. Follow the steps in the Setup wizard to setup the Service Definition, General Preferences, and Inbox Preferences.

Set Service Definitions - Setup Wizard Screen 1

The Mail Service Setup wizard appears after you add a service. If you are adjusting the settings of an existing service, select **Services > Options**, select the service you are using, and then **Properties**. In the **Service Definition** dialog box, complete the following entries as needed.

Connection

If you are receiving e-mail through a network (Ethernet) connection, select **Network Connection**. If you want Inbox to use your current (i.e. dial-up) connection, select **(none)**. If you receive your e-mail through a dial-up connection and have not created one yet, select **Create new connection**, double-tap or double-click the Make New Connection icon, and follow the instructions in the wizard. When finished, select Inbox in the Taskbar and continue setting up Inbox.

Pop3 Host

(POP3 only): Enter the name of the mail server you use to receive and send messages.

Server

(IMAP4 only): Enter the name of the mail server you use to receive and send messages.

User ID

Enter the user name or mailbox ID assigned to you.

Password

Enter the password you use to access this mail account. If you do not want to be prompted to enter the password each time you connect, select **Save password**.

Domain (Windows NT)

Enter your Windows NT domain name. This name is required only when connecting to networks, such as a corporate network, that use Windows NT domain security. This is not required for most ISP accounts. If you have trouble connecting, try clearing this box.

SMTP Host

If your mail service uses a separate server for SMTP, enter the name in the box. If you're setting up a POP3 Mail service with an ISP, the ISP must use an SMTP mail gateway.

Return Address

By default, the return address is set to *username@POP3host* or *username@Servername*, depending on the service you are using. If this is not your e-mail address, enter the correct address in the box.

Set Service Preferences - Setup Wizard Screen 2

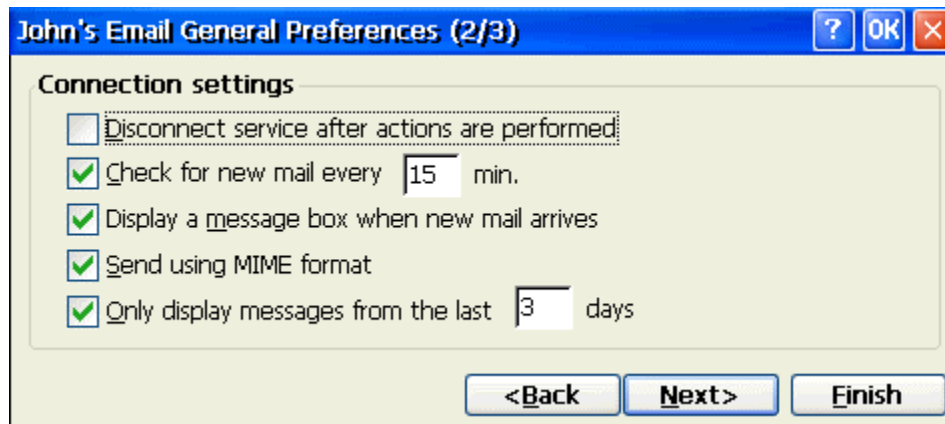

If you are adjusting the settings of an existing service, select **Services > Options**, select the service you are using, select **Properties**, and then select **Next**. In the **General Preferences** dialog box, choose any of the following settings, all of which are optional.

Disconnect service after actions are performed

Select to automatically disconnect from the server upon completion of all pending actions. This option minimizes connect time and cost.

Check for new messages every

Select the time interval at which you want the device to check for new mail. If this option is turned off, you must check for new mail manually by selecting **Services > Send/Receive Mail**.

Display a message box when new mail arrives (POP3 only)

Select to be informed that new mail has arrived.

Send using MIME format (POP3 only)

Select to send messages with extended characters.

Play a sound (IMAP4 only)

Select to be informed that new mail has arrived.

Only display messages from the last 3 days

Select how many day's messages you want downloaded

Set Service Inbox Preferences - Setup Wizard Screen 3

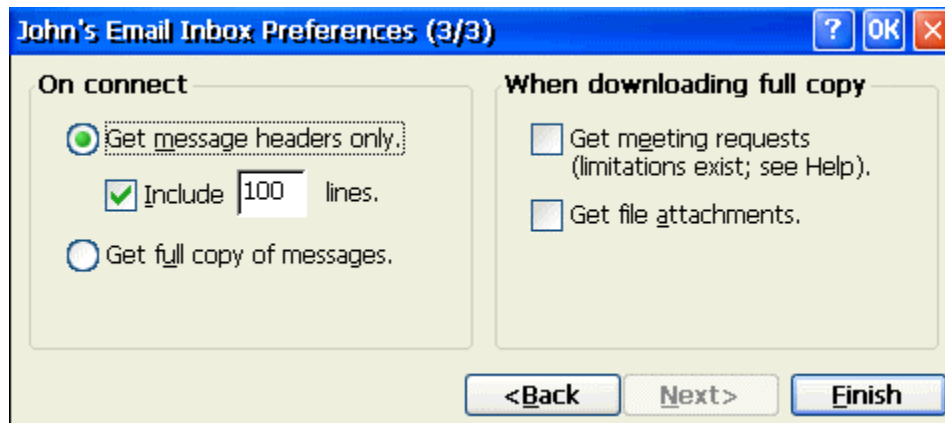

If you are adjusting the settings of an existing service, select **Services > Options**. Select the service, then select **Properties**, and then select **Next** twice. In the **Inbox Preferences** dialog box, choose any of the following options and then click on the **Finish** button to complete the process.

Get message headers only

Select to save storage space and time by downloading only headers. You can download a full copy of the message later by selecting the message and then **Services > Get Full Copy**

Include <number> lines

Select to set the message length (approximate number of lines) that you want to download.

Get full copy of messages

Select to receive a full copy of all messages when connecting to a service. In addition to the entire message body, all options selected under **When downloading full copy** will be downloaded as well. Selecting this option increases the amount of time needed to download messages.

Get meeting requests (POP3 only)

Select to download and store copies of meeting requests when getting full copies of messages. This setting applies whether you have chosen to download full copies of messages by default, or if you selectively download full copies of messages by opening the message and selecting **Services > Get Full Copy**. Limitations apply.

Get file attachments (POP3 only)

Select to download and save message attachments when getting full copies of messages. This option may use significant RAM and slow download time. This setting applies whether you have chosen to download full copies of messages by default, or if you selectively download full copies of messages by opening the message and selecting **Services > Get Full Copy**.

Note: If this option is **NOT** selected, you will **NEVER** be able to receive attachments no matter when you decide to **Get Full Copy**.

Only synchronize folder hierarchy under Inbox (IMAP4 only)

Select to speed download time by preventing the complete download of the folder list every time you connect.

Get file attachments and meeting requests (IMAP4 only)

Select to download and store meeting requests and message attachments when getting full copies of messages. This setting applies whether you have chosen to download full copies of messages by default, or if you selectively download full copies of messages by opening the message and selecting **Services > Get Full Copy**. Limitations apply.

Only if smaller than (IMAP4 only)

Select to restrict the size of the attachments you download. Set to 10K if you want to receive meeting requests only.

Download Messages from Server

When you download messages, you need to create two connections: a remote connection and a mail server connection. The remote connection connects you to your ISP or network. The mail server connection downloads messages from your mail server to Inbox on your device. When you select **Services > Connect** in Inbox, Inbox starts a remote connection using the connection you specified when setting up the current mail service. If you are already connected through a remote connection other than the one you specified in the mail service, you will be asked if you want to use the current connection. If you choose not to, you will need to disconnect from the current connection before you can check for new messages.

Email Services Menu

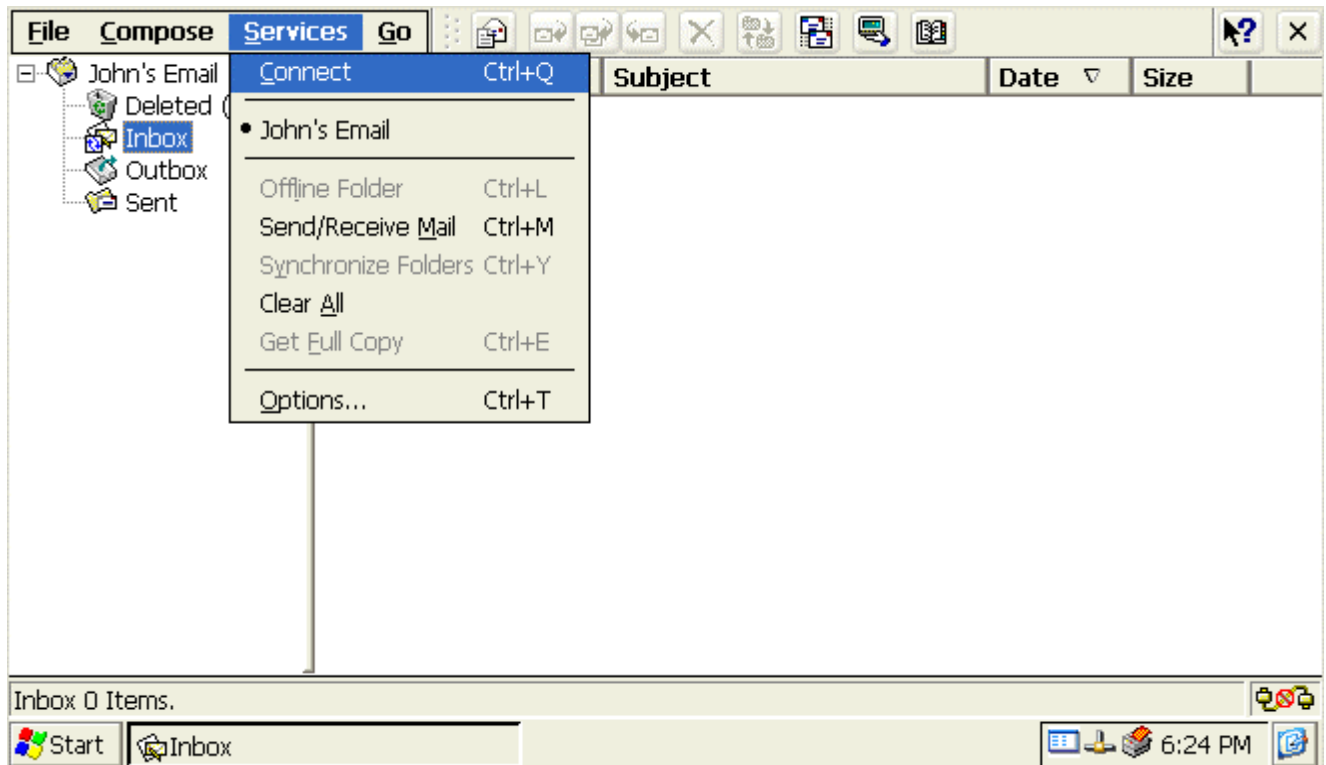

1. Select the Services menu and make sure that the service you want to use is selected (the selected service has a bullet next to it).
2. Select Services > Connect or click on the Connect icon on the toolbar. The messages on your device and mail server are synchronized: new messages are downloaded to the device Inbox folder, messages in the device Outbox folder are sent, and messages that have been deleted on the server are removed from the device Inbox. Double-click a message in the message list to open it.

3. If you read a message and decide that you need the full copy, select **File > Get Full Copy** while in the message window or **Services > Get Full Copy** while in list view. This will also download message attachments and meeting requests if you have those options selected in the **Inbox Preferences** dialog box. You can also choose to download full copies of messages by default.
4. When finished, select **Services > Connect** to disconnect. If your email service is via a dial-up connection, you also need to disconnect it by double-clicking the icon in the status bar and selecting **Disconnect**.

Note: Receiving entire messages consume storage memory. The size column in the **Inbox** list view displays the local size and server size of a message. Even when a message has been downloaded fully, these numbers may differ because the size of a message can vary between the server and the device.

Reply to or Forward a message

1. Open the message, and then select **Compose > Reply to Sender, Reply to All, or Forward**.
2. Enter your response and select **File > Send**.

Tips:

1. Selections in the **Options** dialog box determine whether the original text is included.
2. To see more header information, select the inverted triangle in the lower-right corner of the header area. Select the triangle again to collapse the header area.

Create a new message



1. From the main email window select **Compose > New Message**.
2. In the **TO:** entry box, type in the email address of the intended email recipient.
3. In the **CC:** entry box, type in the email address of those who you would like to also send a copy of the intended email.
4. In the **Subject:** entry box, type in any pertinent information to give the recipients an idea of what the email is about.
5. In the message body, type in the email text.
6. In the **TO** entry box, type in the email address of the intended email recipient.
7. Complete the process by selecting **File > Send**.

Address Book

Add Sender to Address Book

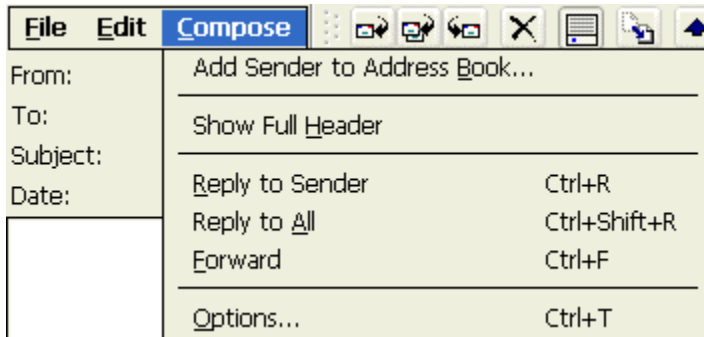

1. Open the message, and then select **Compose > Add Sender to Address Book**. A new contact card will open with the sender's name and e-mail address already entered.
2. Enter other or edit desired information.

Change the Address Book entries

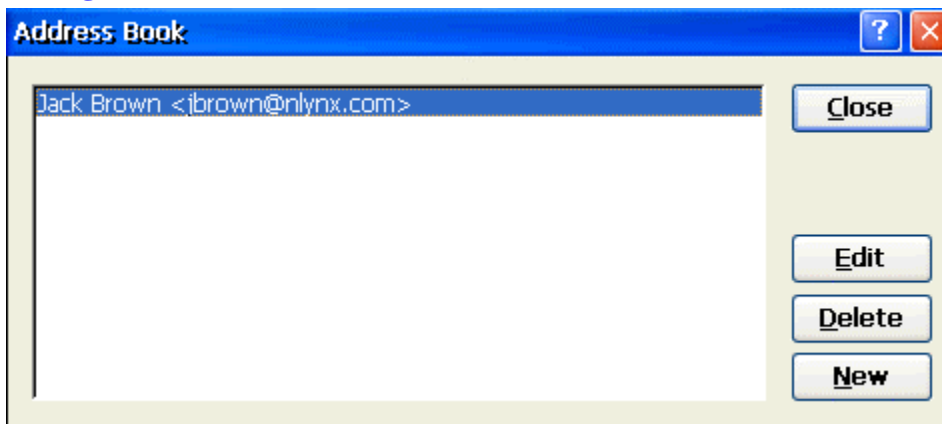

1. Select **Go > Address Book** or click on the Address Book icon.
2. To add a new entry, select **New**.
3. Enter the name you want to type in the **To** and **CC** fields of messages in the **Name** field.
4. To delete an entry, select it, and then select **Delete**.
5. To edit an entry, select it, and then select **Edit**.

Edit Email Options

To edit the global email options or those for a specific service, click on the **Options** selection under the **Services** pull-down menu.

Email Options Window

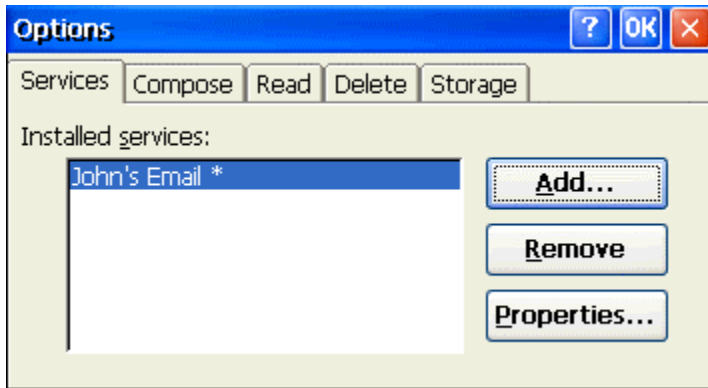

To edit a specific service, highlight the one intended and click on the **Properties** button to open the first window of the Service Setup wizard. Proceed as before editing the desired information. To edit one of the global email options, click on one of the remaining 4 tabs to open the appropriate option window.

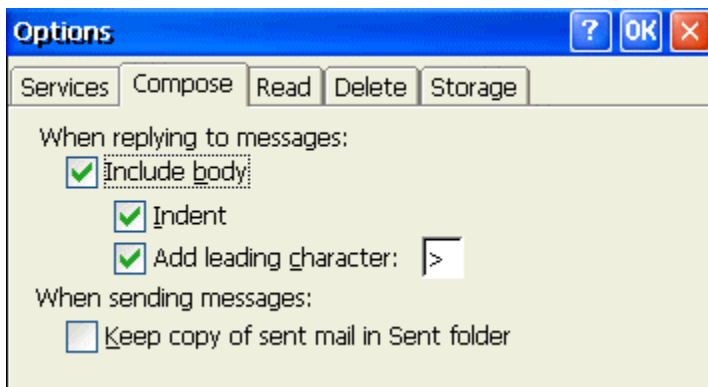

Compose

Place a check in the appropriate check boxes to enable the indicated option. Clear the check box to disable the option.

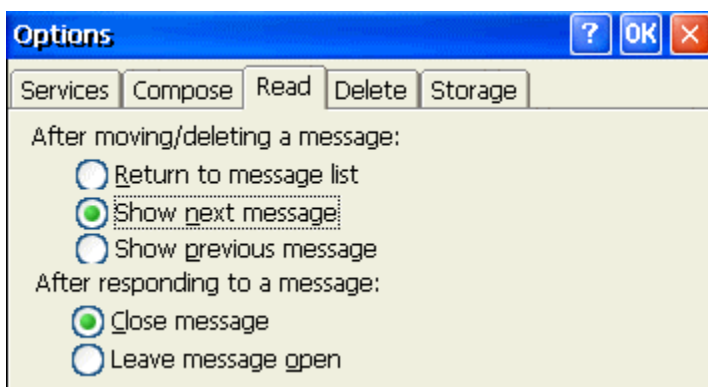

Read

Choose the appropriate radio button to select the desired function for each option.

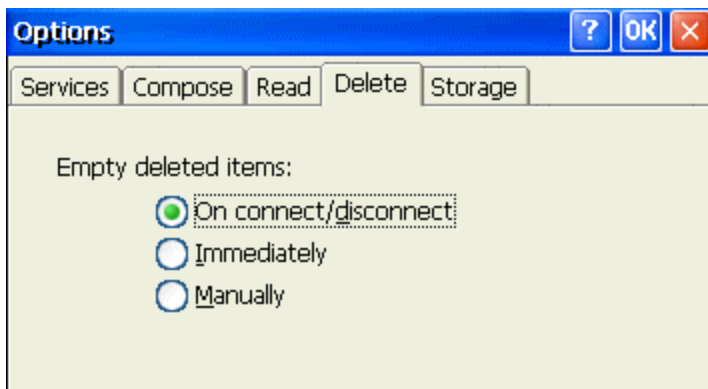

Delete

Choose the appropriate radio button to determine how you want to deal with the **Deleted** items folder.

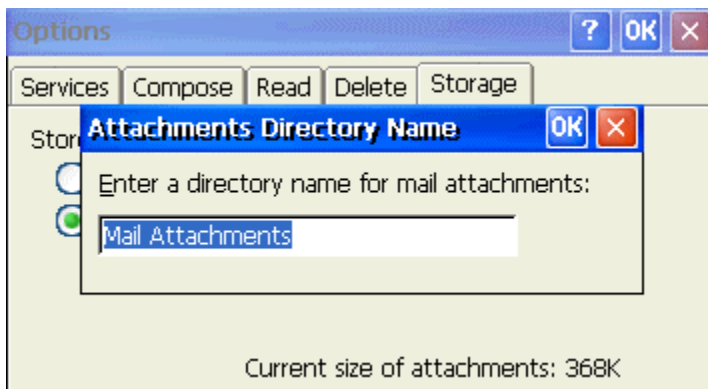

Storage

When downloading messages from the email server, attachments get stored initially by default into **RAM**. If desired, attachments can be directed to additional, External Storage. Currently, the MinIT 6000 supports External Storage via **Disk ON Chip** internal flash. Choose the appropriate radio button to determine how you want attachments to be initially saved.

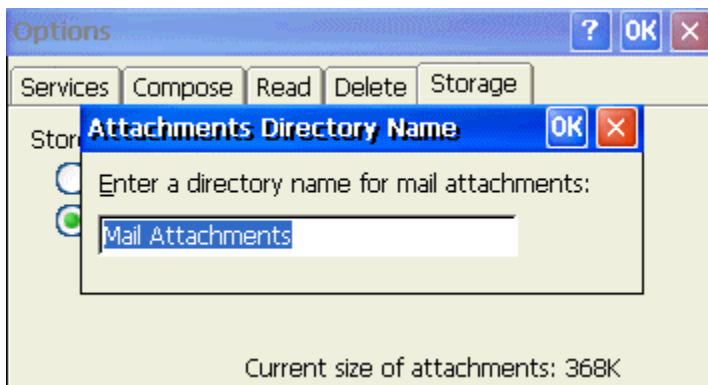

If you choose **External Storage**, you will be prompted to provide a directory name for the email attachments.

Viewing Attachments

The MinIT6000 allows you to view a variety of Microsoft Office file email attachments as well as certain picture images.

Email Message View Window

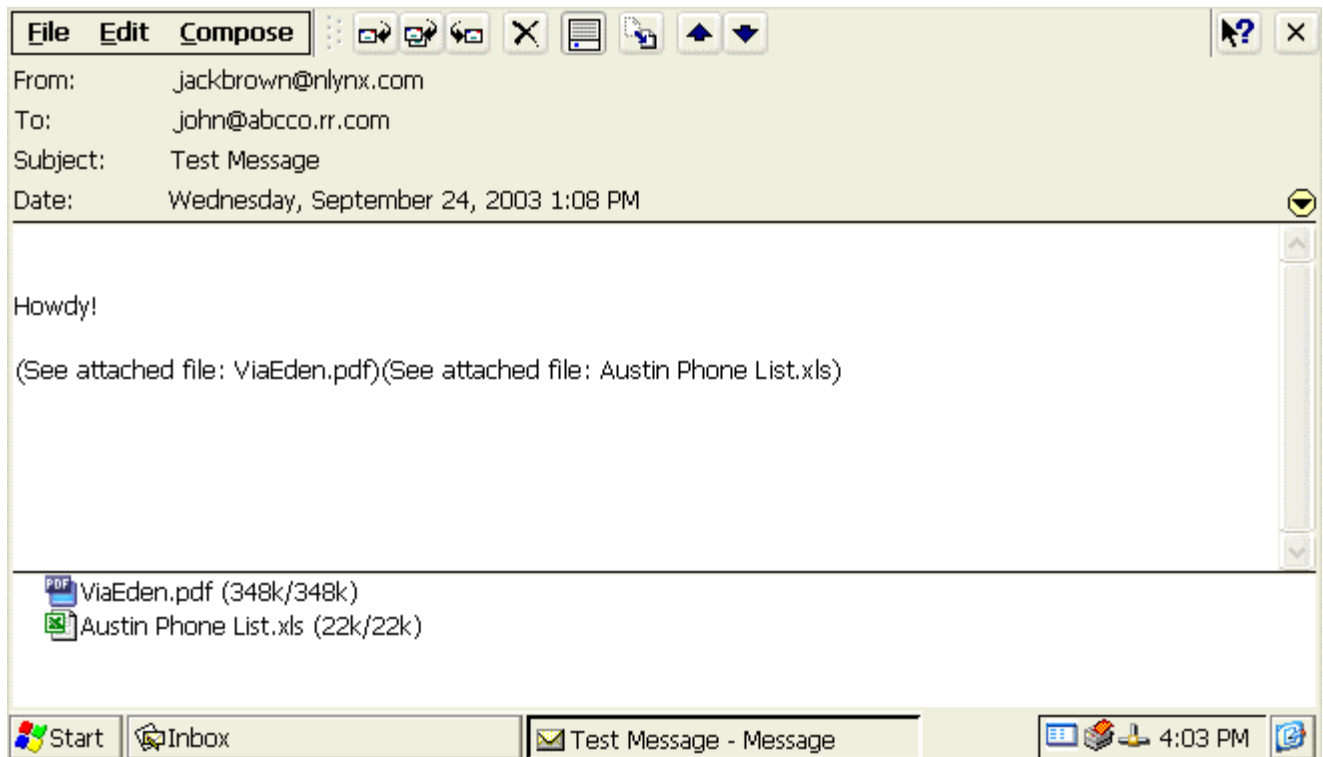

To view the attachments, double click on the attachment icon shown towards the bottom of the screen.

Saving Email Attachments

Email Message View Window

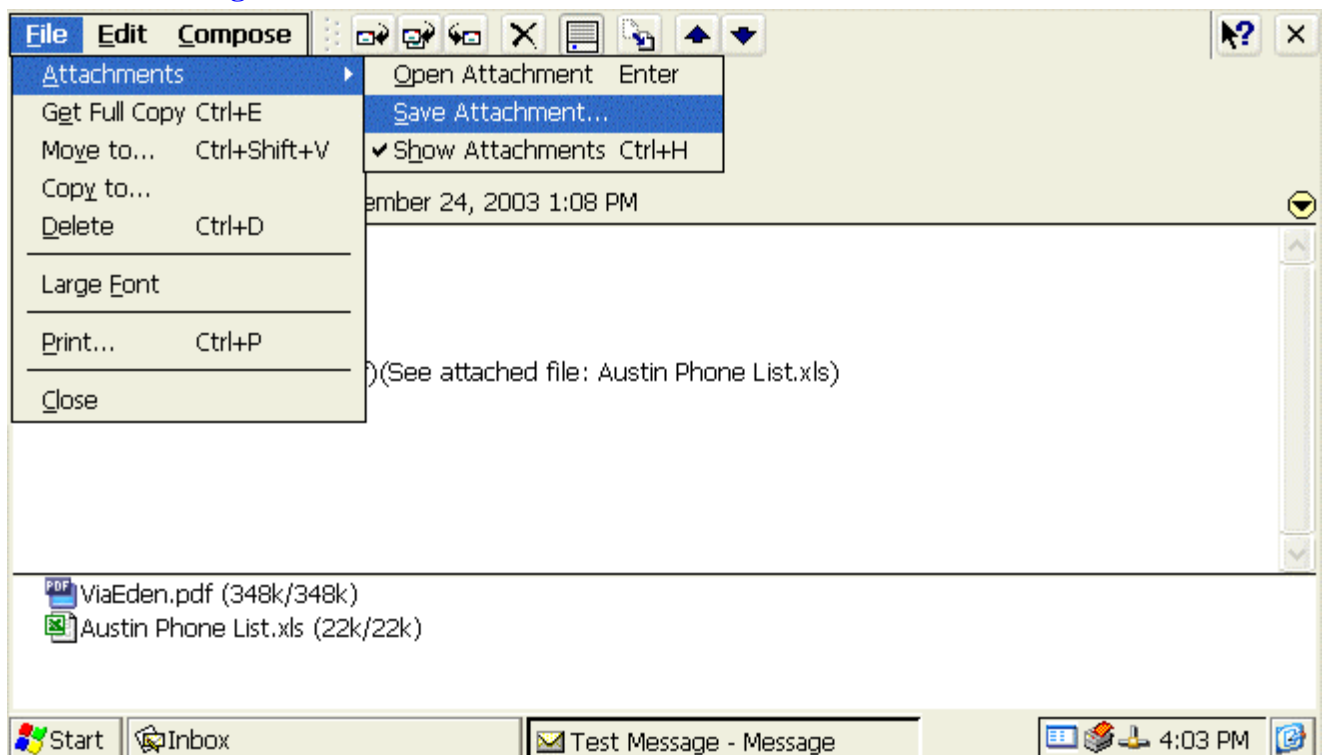

If the **Storage** option for attachments is set to Internal RAM, you can save the attachment in a My Documents folder for quick viewing later after the email client has been closed. To Save the attachment, highlight the attachment and select **File > Attachments > Save Attachment...** to bring up the Save As dialog box.

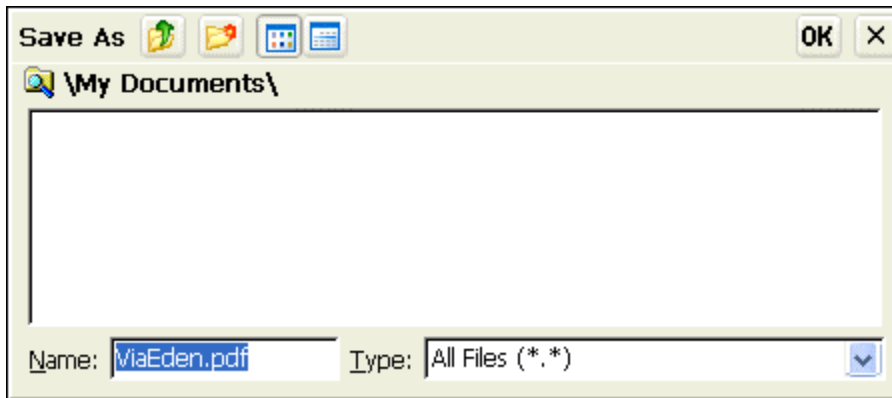

Type in a new name for the attachment if desired and select **OK**. Now the attachment can be opened from the appropriate viewer applications by simply selecting **File > Open**.

Toolbar Buttons

To see the name of a toolbar button, tap or click and hold on the button. Drag the stylus or cursor off the button so that the command is not carried out.

Toolbar

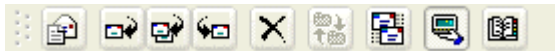

New Message

Select this button to open a New Message window. This is the same as selecting **Compose > New Message**.

Reply

Select this button to Reply to the selected message. This is the same as selecting **Compose > Reply to Sender**.

Reply to All

Select this button to Reply to the selected message including all of the recipients email addresses. This is the same as selecting **Compose > Reply to All**.

Forward

Select this button to Forward the selected message on to another email address. This is the same as selecting **Compose > Forward**.

Delete

Select this button to Delete the selected message. This is the same as selecting **File > Delete**.

Send / Receive Mail

Select this button to Send any emails ready to go out located in the Outbox or to download any new emails from the server. This is the same as selecting **Services > Send/Receive Mail**.

Connect

Select this button to Connect to the selected email service. This is the same as selecting **Services > Connect**.

General Information

After downloading messages into the "inbox" of the email client (with or without attachments), these messages will remain stored in memory (MinIT6000 RAM) even after the client application "Inbox" has been closed. If you have NOT power cycled the unit, the next time the "Inbox" email client is started, these messages can be viewed from the "inbox" prior to connecting to the Host.

If you power cycle the MinIT6000, ALL previously downloaded email messages will no longer show up in email client inbox and must be re-downloaded from the host. This includes ANY additional folders that you might have created from within the client. The next time you connect to the Host, it will synchronize with the email client and re-download all email messages.

Using Internet Explorer

About

With Internet Explorer (version 6.0), you can view Internet or intranet Web pages from your MinIT6000 thin client. You will need to use an Ethernet LAN (or a third party modem) to connect to an Internet service provider (ISP) or network.

Connect to the Internet via an Ethernet LAN

Similar to a PC, you can launch Internet Explorer by double-clicking on the desktop icon.

Using the Start Menu Bar

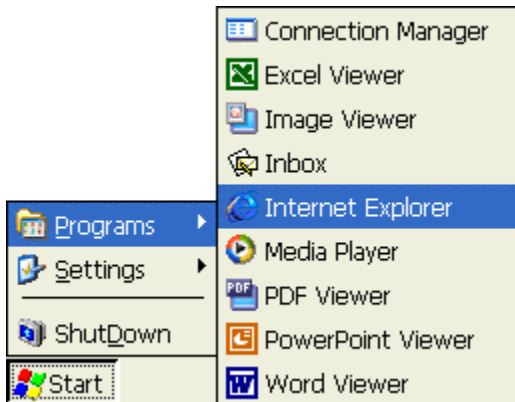

Or you can select **Start > Programs > Internet Explorer** from the “Start” menu on the desktop.

Internet Options

View Menu Tab

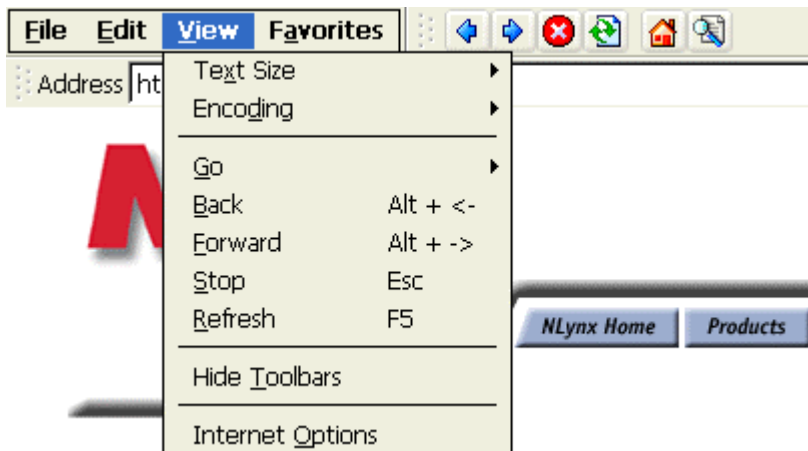

To setup the Internet Explorer properties, select **View > Internet Options**.

General Tab

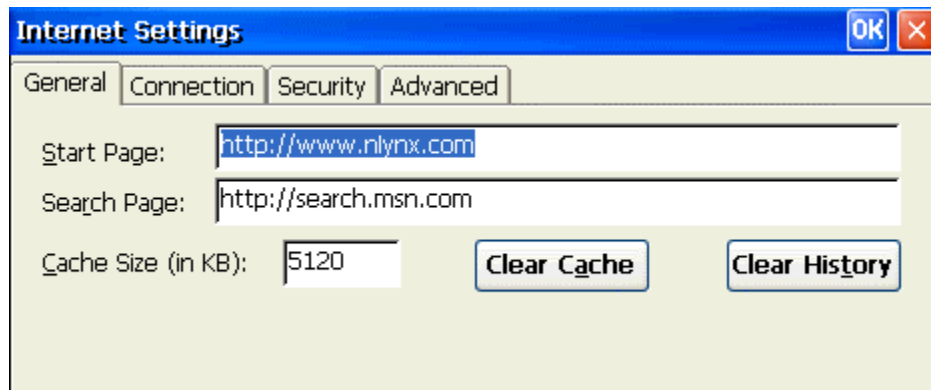

1. Type in the desired URL to change the browser **Start Page**.
2. Type in the desired URL to change the browser **Search Page**.
3. Increase or decrease the memory space devoted to caching by typing in the new larger or smaller value.
4. Click on the **Clear Cache** button to remove previous viewed web pages out of memory.
5. Click on the **Clear History** button to remove any history of previously viewed web pages.

Connection Tab

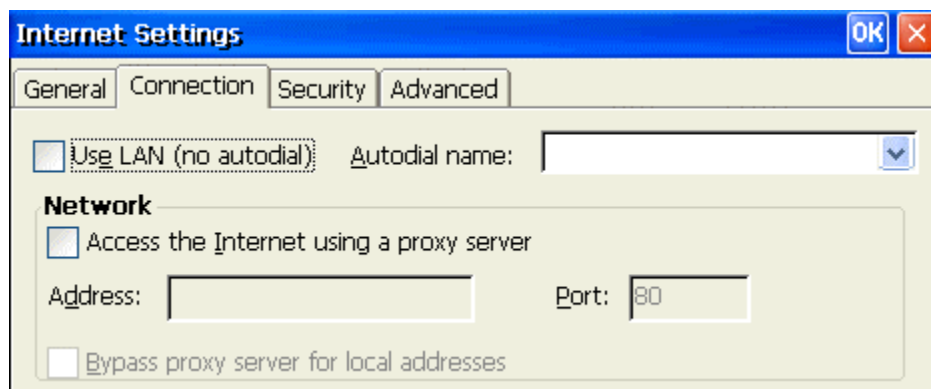

1. Click on the **Use LAN** check box if you plan to connect to the Internet via the Ethernet LAN.
2. If you are using a dial-up (serial port modem) connection, from the pull-down list, select an **Autodial name** of the remote connection that you are planning on using.

Proxy servers are often used when connecting to the Internet through a local network, such as a corporate network, for added security.

3. Click on the **Access the Internet using a proxy server** check box if this is correct.
4. Type in the proxy servers IP address or DNS name.
5. Type in the access Port number if it is something other than the default of 80.
6. If you don't need the proxy server to access local IP addresses, click on the **Bypass proxy ...** check box.

Security Tab

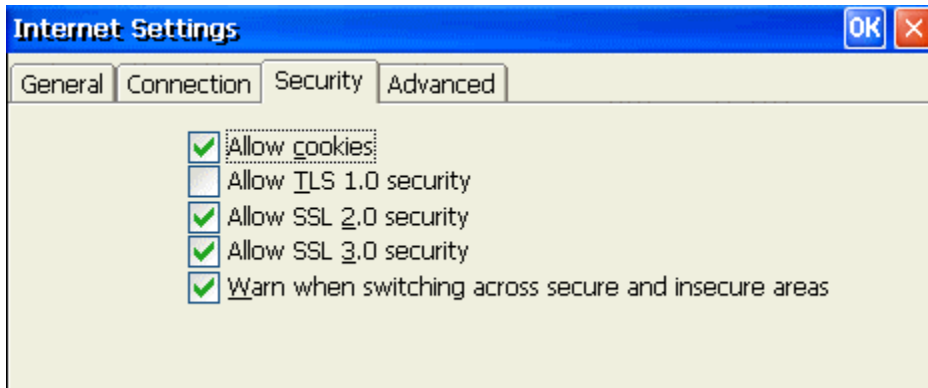

Use these options to select the level security that you want to determine what type of web pages can be viewed. Enabling the **Allow cookies** option will allow cookies to be copied into memory.

Advanced Tab

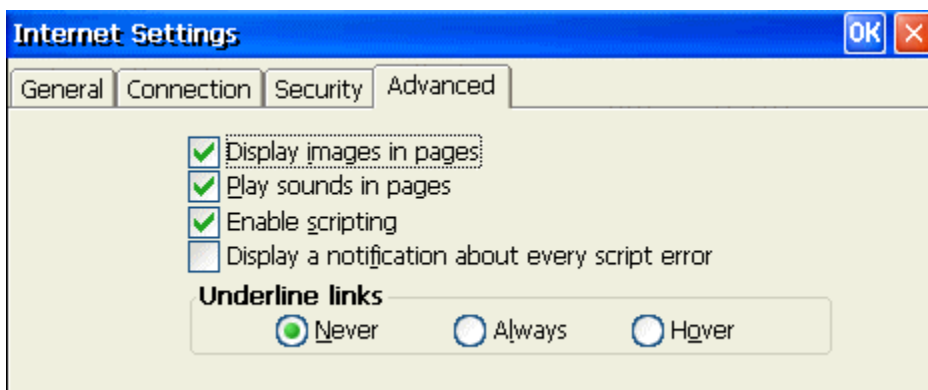

It is possible to speed up how fast the system renders web pages by “NOT” enabling certain options. Choosing not to display images or play sounds could possibly increase the speed at which the standard web page text is displayed.

Underline Links

Select how you want “Links” that are embedded within a given web page are displayed by choosing the appropriate radio button.

Printing

Internet Explorer allows one to print the document or web page currently displayed within the browser window. It is possible, within the correct configuration of the network print, to print on devices connected remotely or to a printer connected locally to the device itself. If a network printer is selected, it's mandatory to specify the network printer address path within the field **Net Path**.

1. Select **File > Print** to bring up the print properties box.

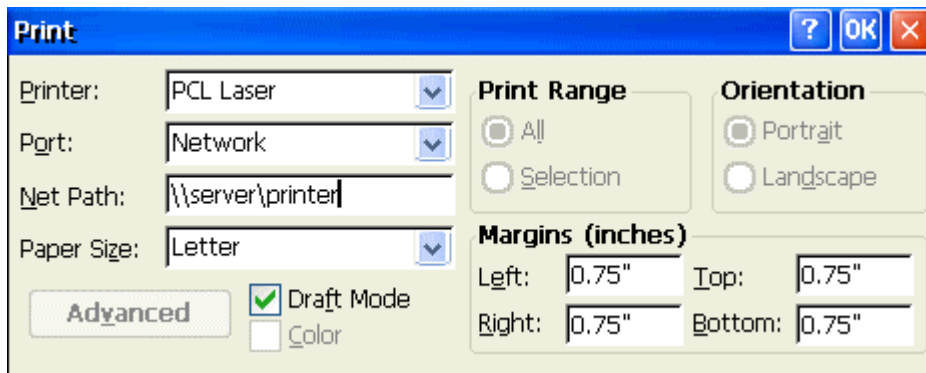

2. Choose your Printer type from the options provided from the drop down list.
3. Select the printer Port from the options provided from the drop down list.
4. If Network printer is chosen, provide the Net Path. i.e: \\computer name\printer name.
5. Select the Paper Size from the options provided from the drop down list.
6. Select whether or not you want the print quality to be normal verses Draft Mode by checking or un-checking the box provided.
7. Select the Print Range, paper Orientation and the Margin requirements.

Tips: **Port** lists the available printer ports. If **Network** is selected from the **Port** list, enter the path to the network printer in the **Net Path** box.

Note: Setting the printer options here sets the default printer options for all applications. To change within another application, follow this same procedure within the specific application.

Favorites

For quick and easily access to some of your favorite web pages, use the **Favorites** menu to create a list for you to click on to open a desired page. As your list of favorite pages grows, you can keep it organized by creating folders. You might want to organize your pages by topic. For example, you could create a folder named Art for storing information about art exhibits and reviews.

Favorites Menu

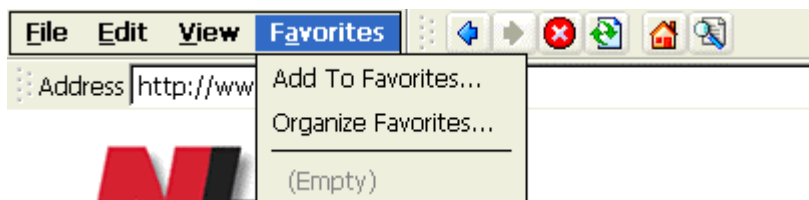

Add To Favorites

1. Go to the page that you want to add to your Favorites list.
2. Select **Favorites > Add to Favorites...** to bring up the dialog window.

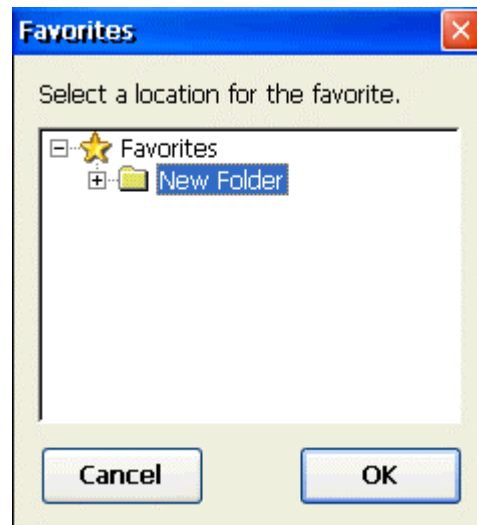
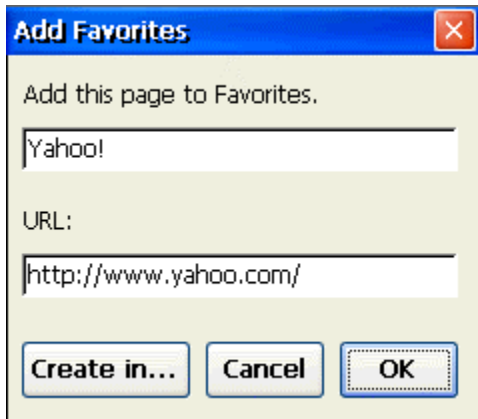

3. Type a new name for the page if you desire.
4. If you have created a sub-folder (see **Organizing Favorites**) that you would like to store this favorite link into, select the **Create in...** button. If not, click on the **OK** button to complete.
5. Highlight the desired sub-folder and click on the **OK** button to complete the process.

Organizing Favorites

1. Select **Favorites > Organize Favorites** to bring up the dialog window.

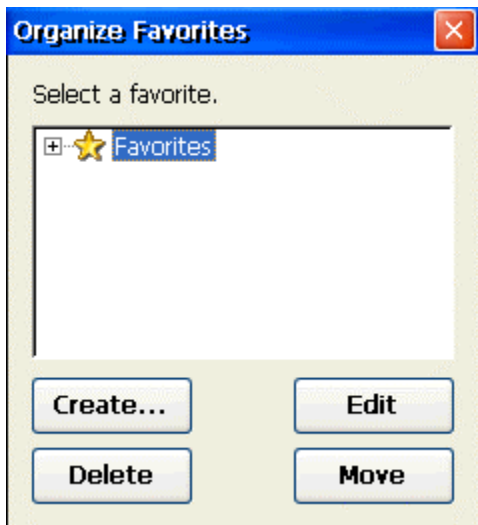

2. Click on **the Create...** button to add a New Folder.
3. Click on the **Edit** button and type in a new name for the folder.
4. Click on the **X** to close the window.

Additional Menu Bar Items

File Menu Options



File Open Window

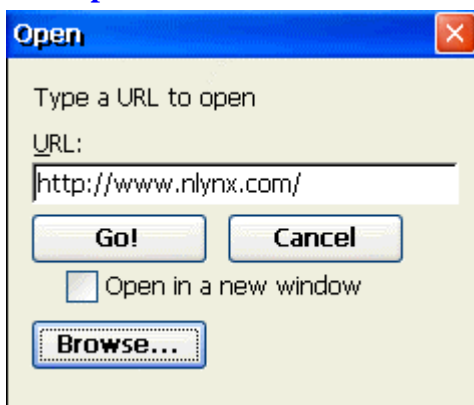

Select **File > Open** and then type in the **URL** of the web page that you would like to visit. Click the **Go!** button to view. If you have saved a web page to local memory, you can re-view it by clicking on the **Browse...** button and selecting the web page. If you would like to open up the new web page in another browser window to keep the current page handy, click on the **Open in a new window check** box.

File Save As Window

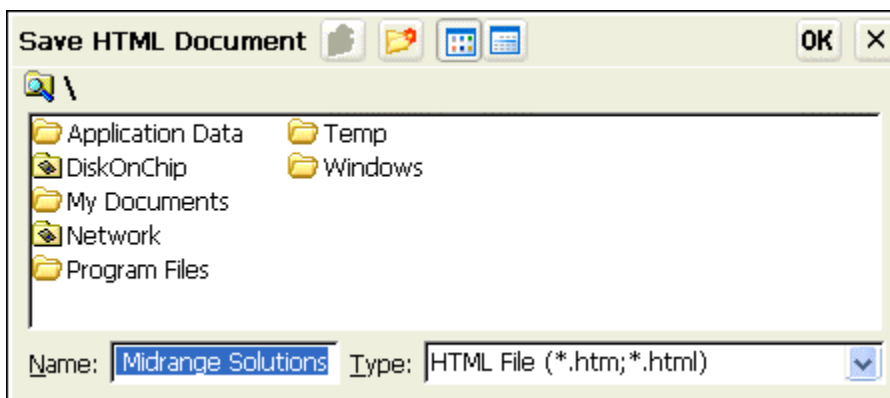

Select **File > Save As...** to save the current web page as an HTML document in local memory for review later.

Edit Menu Options



Edit Copy

1. To copy the text of a web page to another application such as "Email":
2. Select all or part of the Web page you want to copy by holding down the left mouse button and dragging the mouse to highlight the text that you want to copy.
3. Select **Edit > Copy**.
4. Go to the other application (i.e. message create in Email), choose where you want to place the information.
5. Select **Edit > Paste**.

Note: If you want to select the text of the entire page, simply choose **Select All** in step 1 above.

Edit Find Window

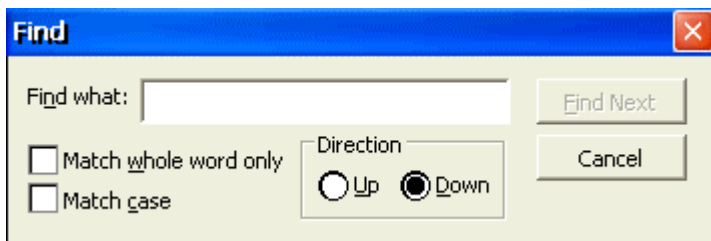

View Menu Options

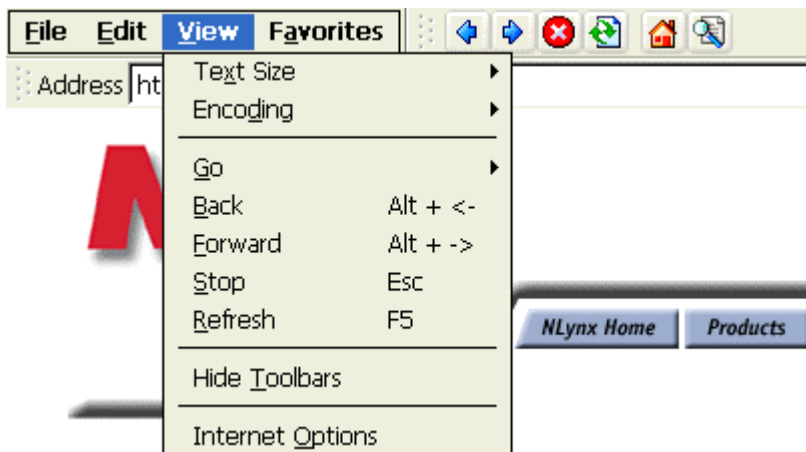

Text Size - Select **View > Text Size** and select the desired size to change the text font size shown on the display.

Encoding - Select **View > Encoding** to change the alphabet Internet Explorer uses for the text shown on the display.

Go - Select **View > Go** and select the desired option to Go directly to that web page..

Back - Select **Back** to move to the page you have previously viewed.

Forward - Select **Forward** to move to the next page (provided you have viewed it previously).

Stop - Select **Stop** to stop loading the current page.

Refresh - Select **Refresh** to Reload the current web page.

Navigating Using The Toolbar



Back - Select **Back** to move to the page you have previously viewed. This is the same as selecting **View > Back**.

Forward - Select **Forward** to move to the next page (provided you have viewed it previously). This is the same as selecting **View > Forward**.

Stop - Select **Stop** to stop loading the current page. This is the same as selecting **View > Stop**.

Refresh - Select **Refresh** to Reload the current web page. This is the same as selecting **View > Refresh**.

Home - Select **Home** to load your default “Home” web page.

Search - Select **Search** to load your default “Search” web page.

Address Bar

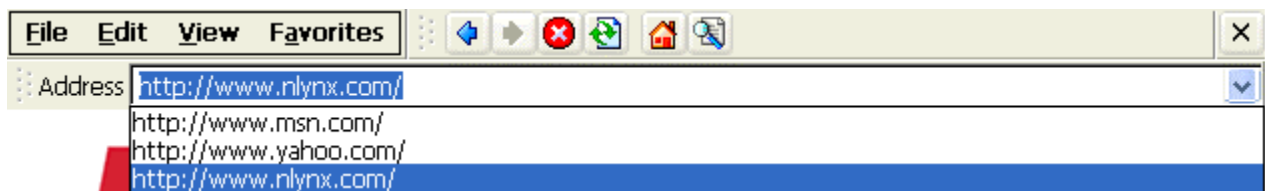

You can type in the “URL” of the web page that you would like to visit directly into the **Address** window. If you have previously typed in other “URLs”, you can go directly to any of those pages by using the **Address** bar pull down list and selecting the desired “URL” from the list.

Shared Network Drives

About

Because the MinIT6000 has limited internal storage, it might be necessary to attach to a shared network drive to save things such as documents and email attachments. However, to do so, the pc/server must be available to the LAN (via local or wide area network connection) and have local drives that are set up for Microsoft network sharing.

Sharing a Network Drive / Folder on a Windows 95/98 PC

1. Open Windows Explorer selecting **Start > Programs > Windows Explorer**.
2. Select/highlight the appropriate drive/folder and click with the right (secondary) mouse button.
3. Select Sharing to bring up the properties window for that specific drive or drive folder.
4. Select the **Shared As** option and select **Share Name** and **Access Type**.
Note: The current name of the drive or folder will appear in the **Share Name** box. Change only if necessary.
5. If desired, type in an appropriate password.
6. Select the Apply button or OK to process the changes.

Creating Desktop Shortcut to a Shared Network Drive / Folder

In the current version of firmware, even though it may be a little complicated, it is possible to add your own desktop "Shortcuts".

Steps 1 - 3

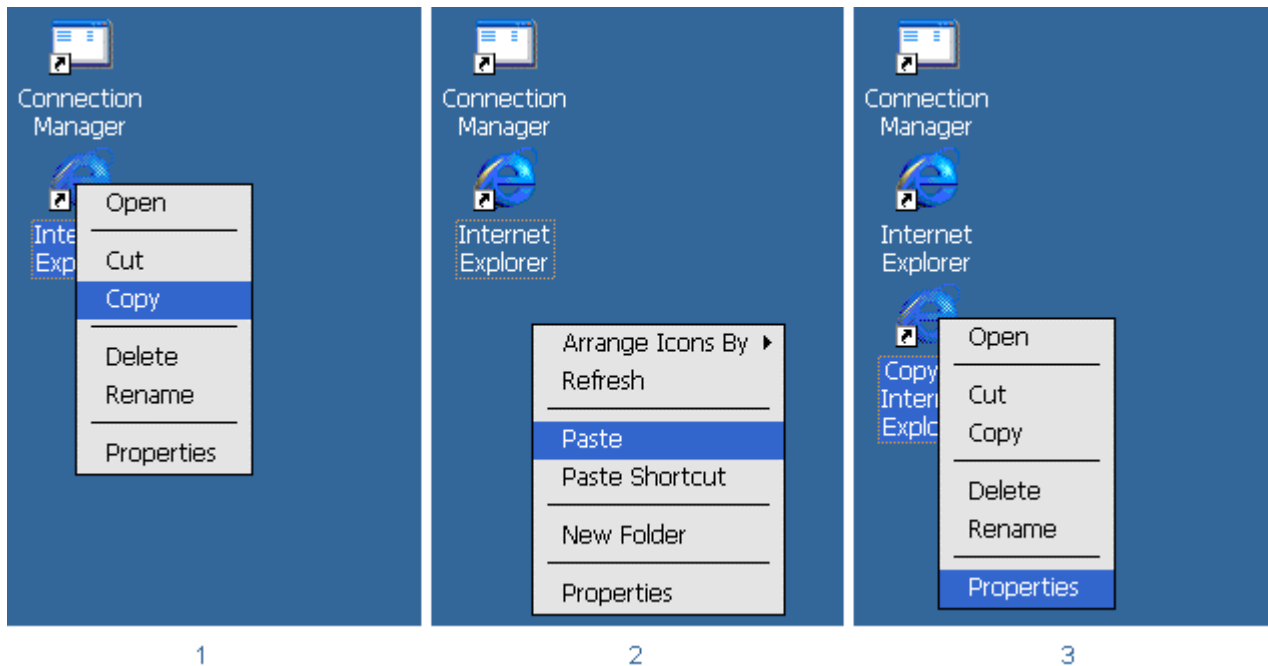

1. Place the mouse cursor over the “Internet Explorer” shortcut icon, click the right mouse button and select Copy.
2. Place the mouse cursor over an empty portion of the desktop, click the right mouse button and select Paste.
3. Place the mouse cursor over the new “Copy of Internet Explorer” shortcut icon, click the right mouse button and select Properties.

Step 4

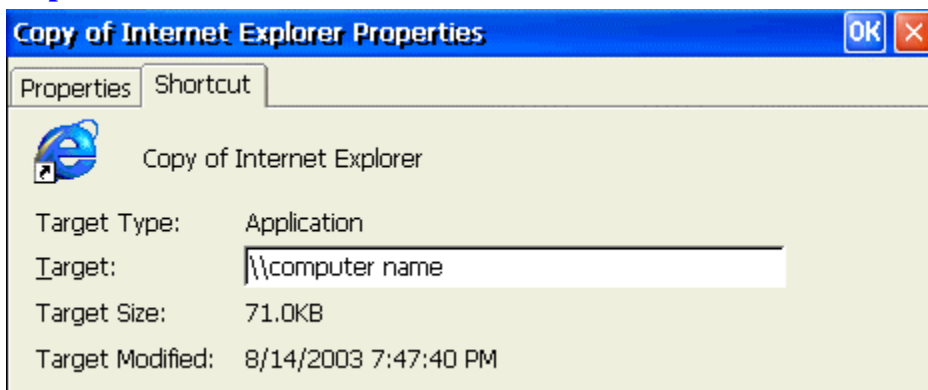

4. Type over the current information in the Target: box with \\computer name followed by the <enter> key. The computer name = name of the network computer with shared drives and folders. If there is a valid network connection to the desired computer, the desktop icon will change to that of a “Disk Drive”.

Steps 5 - 7

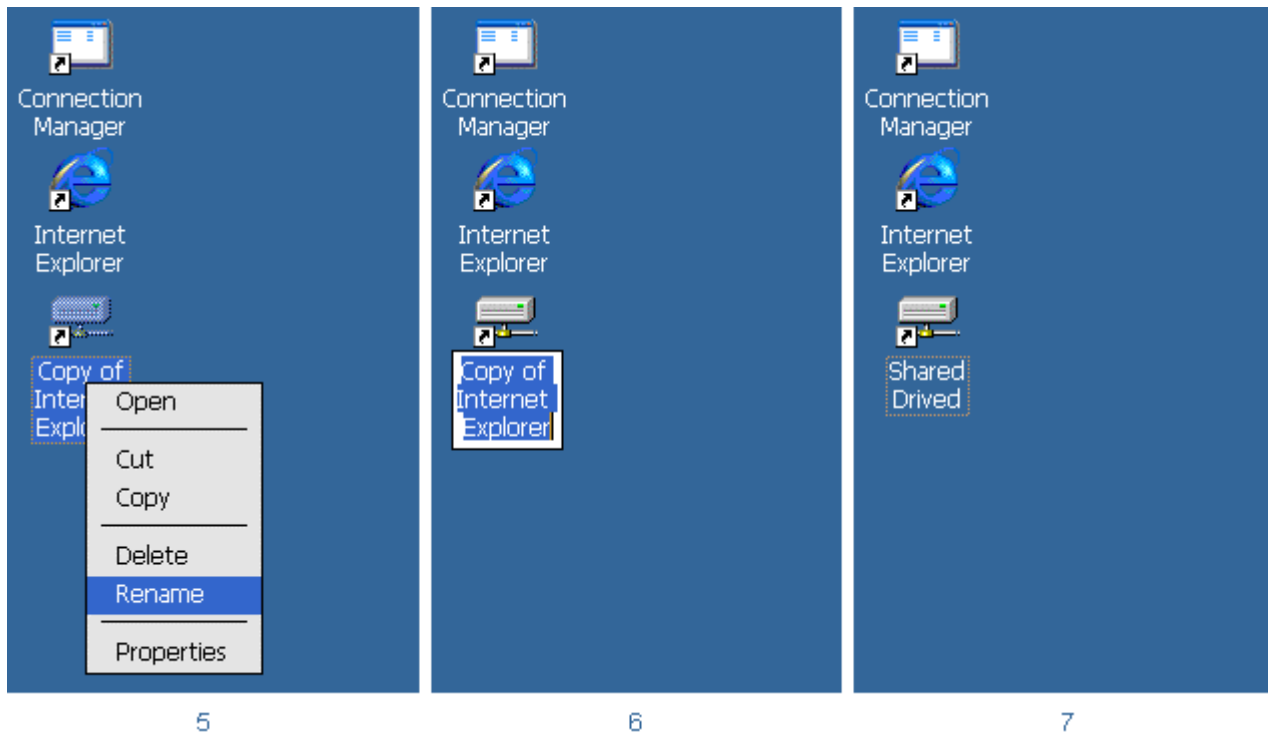

5. Place the mouse cursor over the new shortcut icon, click the right mouse button and select Rename.
6. Type in the new desktop icon name (i.e. Shared Drive) followed by the <enter> key.
7. Now you are ready to double click on the shortcut to the shared network drive.

Accessing a Shared Drive

There are three ways to access a shared drive.

Method 1. From the newly created Desktop Icon

1. After creating a shortcut (as described previously) to a shared network drive, double click on the icon to bring up a browser window listing the contents (shared folders and shared files) of the shared drive.

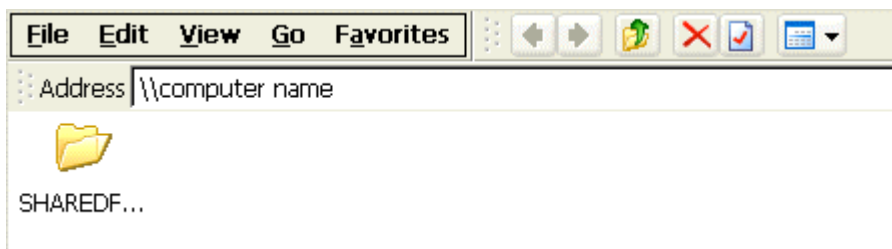

2. Double click on the appropriate shared folder to access the desired information.

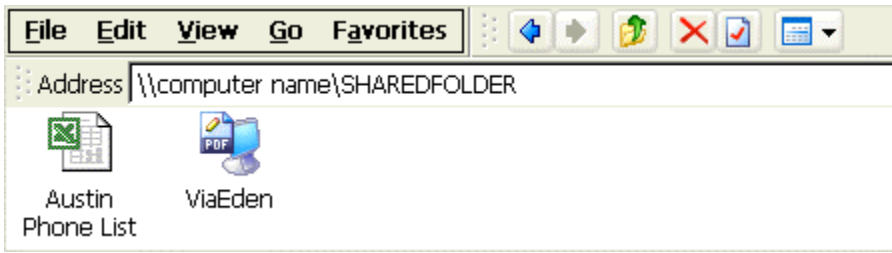

3. Double click on the appropriate files to view pictures (.jpg), PowerPoint presentations (.ppt), Excel spread sheets (.xls), Word documents (.doc) or PDF (.pdf) files.

Method 2. From a Desktop Folder Icon

You first must create a desktop folder icon that by default points to a location in local memory.

Steps 1 - 2

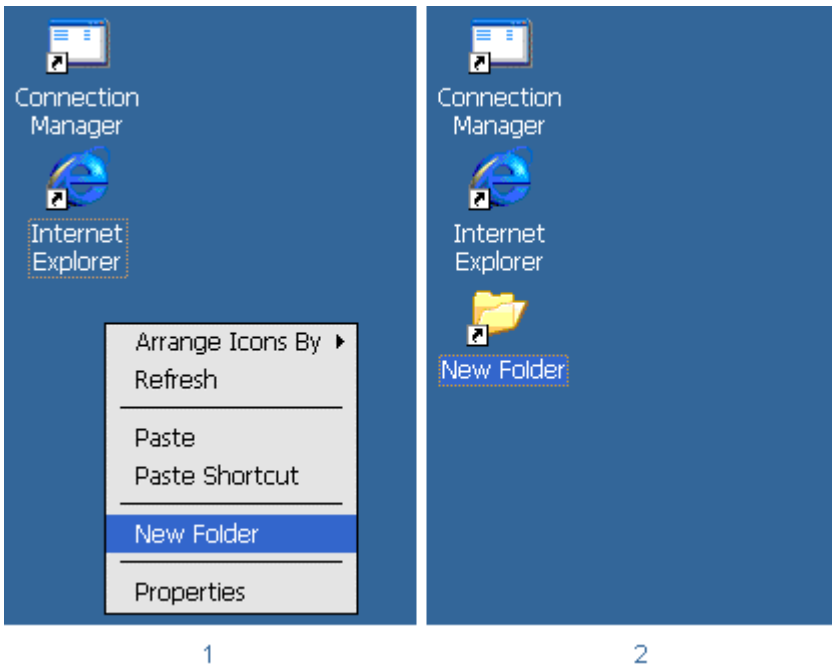

1. Place the mouse cursor over an empty portion of the desktop, click the right mouse button and select **New Folder**.
2. Double click the "New Folder" icon to bring up a browser window.

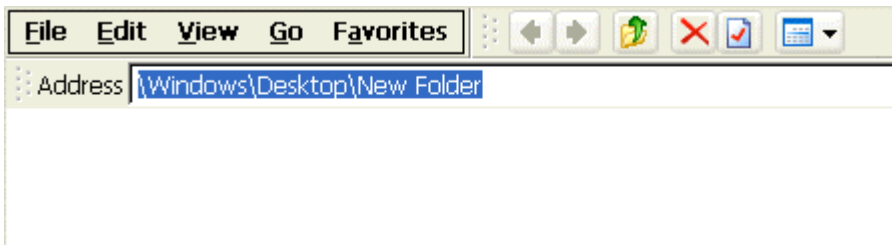

3. Type over the current information in the Address window with \\computer name followed by the <enter> key. The computer name = name of the network computer with shared drives and folders.
4. If prompted, type in the appropriate user name and password.

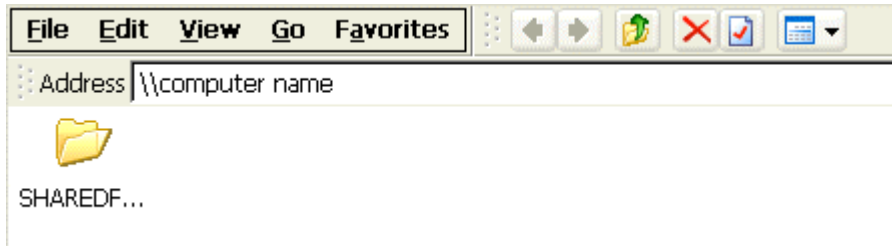

5. Double click on the appropriate shared folder to access the desired information.

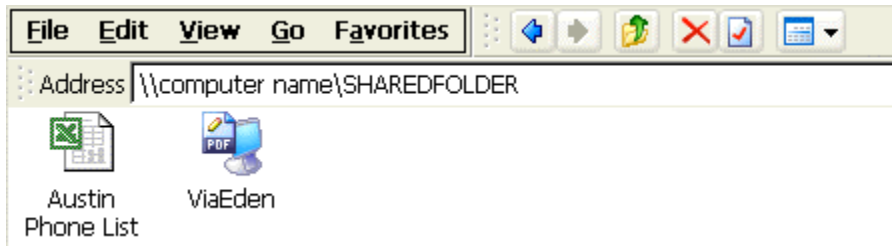

6. Double click on the appropriate files to view pictures (.jpg), PowerPoint presentations (.ppt), Excel spread sheets (.xls), Word documents (.doc) or PDF (.pdf) files.

Method 3. Directly from Internet Explorer

1. Double click the “Internet Explorer” icon or select **Start > Programs > Internet Explorer** to bring up a browser window.
2. As in **Method 2**, type over the current information in the **Address** window with *\\computer name* followed by the <enter> key.
3. Continue with steps 4 – 6 of **Method 2**.

Note: This method causes a second browser window to be opened leaving the previously viewed web page still open in the other window.

Upgrade Utilities

FTP Firmware Upgrade

There are two methods to upgrade your firmware.

Method 1. Upgrade firmware from your local FTP server

This function can only run when the **FTP server is available** on your Local Area Network (LAN).

- **Download latest version firmware to your FTP server**

You can download latest version firmware (i.e., image file named NLX422TEBxxxx.bin) directly from the N Lynx web site or by contacting technical support, and then save it to your local FTP server. Make sure you save it on your local FTP server in a known directory (i.e. you should be able to see this file through your browser such as I.E. 4.0 or Netscape).

- **Download firmware into the unit**

1. Select **Start > Control Panel** from the "Start" Menu on the desktop.
2. Click on the FTPUpdate icon to bring up the "FTPUpdate" window

FTP Update Window

The screenshot shows the FTPUpdate dialog box with the following fields and values:

- Server Section:**
 - Server Name: 192.168.1.93
 - Path Name: (empty)
 - File Name: (empty)
- User Section:**
 - Name: (empty)
 - Password: (empty)

At the bottom of the dialog, there is a progress bar and two buttons: **Download** and **Cancel**.

3. Enter in the name or IP address of the FTP server that contains the updated firmware.

4. Type in the directory path where the file is located.
5. Type in the full file name of the updated firmware or click on the pull down menu and select the file from the list.
6. Type in the User Name and Password required to log into your FTP server.

Note: Most FTP servers are case sensitive in regards to the path and file name information.

7. Click the Download button.

Important Notes:

DO NOT make any change that may interfere with the upgrade process such as **Interrupting the Power** or **Removing the Ethernet** Connection after clicking the **Download** button. This may cause serious damage to your terminal.

Your local FTP server should not use “Proxy Protection”.

FTP Update Progress View

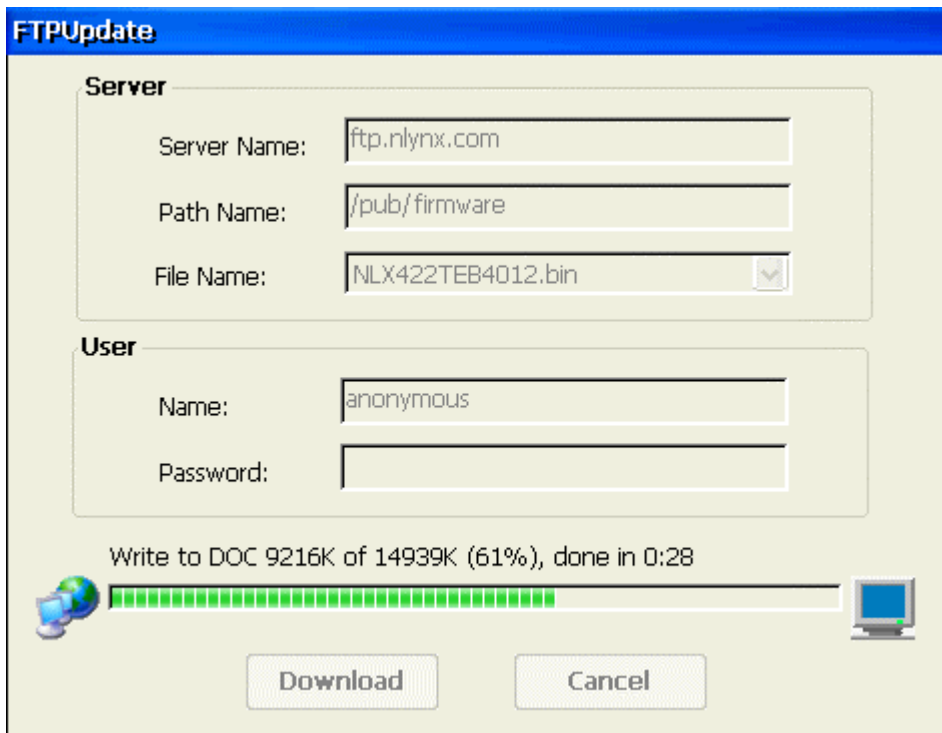

The screenshot shows a dialog box titled "FTPUpdate" with a blue header. It is divided into two main sections: "Server" and "User".

Server Section:

- Server Name: ftp.nlynx.com
- Path Name: /pub/firmware
- File Name: NLX422TEB4012.bin (with a dropdown arrow)

User Section:

- Name: anonymous
- Password: (empty field)

Below the user section, there is a progress bar with the text "Write to DOC 9216K of 14939K (61%), done in 0:28". The progress bar is partially filled with green segments. To the left of the progress bar is a globe icon, and to the right is a computer monitor icon.

At the bottom of the dialog box are two buttons: "Download" and "Cancel".

If everything has been entered properly and you are able to successfully connect to the FTP server, the **Download** button will stay hidden and a progress bar will start to show the status of the process. If not, an Error Message box will pop up. Please note that the update process occurs in two steps. First, the firmware is downloaded completely into RAM and then it is copied onto the “DiskONChip” (internal permanent storage).

Connection Error Message



If this message appears, click on the **OK** button and verify that the Server Name, Directory, User Name and Password information is correct. If it is, the Connection Error might be caused by incorrect **Network** settings or a bad Ethernet connection. Please verify your LAN connection and/or modify your **Network** settings. Refer to the **Network** section in the [Configure Terminal Properties](#).

- **Restart your Terminal**

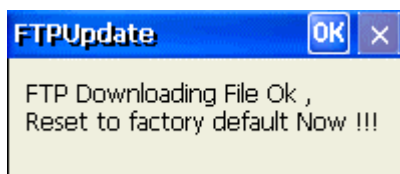

After Upgrade has finished, a confirmation box will pop up to ask you to "Reset to factory default". Click on the **OK** button to reset Terminal to factory default so that the full new firmware can take effect.

Method 2. Upgrade using Remote management

If have installed "ezManager Pro" on your network, you can use this method to upgrade your firmware. Obtain the latest version firmware (i.e., [image file named NLX422TEBxxxx.bin](#)) directly from the NLynx web site or by contacting technical support. For more information on this upgrade method procedure, please refer to the "ezManager Pro User's Manual".

Troubleshooting

About

This document contains solutions to problems that one might encounter when installing or operating the MinIT 6000. To connect to the host, you must know the IP Address of your AS/400 and be on the same network as your AS/400.

1. MinIT6000 Configuration Problems

These are problems that can occur during the initial configuration.

Problem 1.1

The light on the MinIT 6000 is orange.

Solution

Push the light to turn the power on.

Problem 1.2

The MinIT 6000 is stuck in Kiosk mode, how do you get out of it?

Solution

1. Ctl Alt Up takes you back to the Terminal Properties window.
2. Double-click the Desktop Style icon.
3. Select Desktop Shell Mode.
4. Click OK (twice).

Problem 1.3

After restarting it goes to a blank screen. The light on the front is green. In the taskbar on the lower right, there is a red X through the network symbol.

Cause

You do not have a network connection.

Solution

Check the network cables. There should be an orange light at the network connection of the MinIT 6000. Try plugging a known good device on to the same network cable. If it works, then you can be certain that the network cable is good and that the MinIT 6000 hardware is likely bad.

Problem 1.4

The light on the MinIT 6000 is green. The host session is black, with no cursor.

Cause

This could happen if your IP address is wrong. You must be on the same virtual network or have a Gateway to the AS/400.

Solution

1. Click on the Start button in the lower left and select Settings then Control Panel.
2. Double-click on the Network icon.
3. Verify your TCP/IP information by clicking on the Client IP Address button.

- If you manually selecting an IP Address and the information is incorrect, type in the correct IP Address, Subnet Mask, and Default Gateway.
 - If you are using DHCP and have not obtained a valid DHCP address, Make certain that the network DHCP Server is running.
4. If the TCP/IP information is correct, make certain that you can ping the AS/400.
 - Click on the Ping IP Address button.
 - Enter in the IP address of the AS/400 and click on the Ping button.
 5. If you can't ping the AS/400, make certain that it is on the same network as your MinIT6000 and that the AS/400 has TCP/IP running.

Problem 1.5

The display comes up to a gray screen but it never connects, the cursor goes to the upper left and then it reports, "The communications link with the Host has been lost.

Cause

This could happen if you were using a space or another illegal character in the Device Name or if the Device Name is a duplicate of another active device.

Solution

Do not use spaces, dashes, asterisks, question marks, apostrophes, and double quotation marks in the Device Name.

1. Open the connection Manager.
2. Select the configure tab.
3. Double-click on the session that does not come up.
4. Type in a correct Device Name.

Problem 1.6

I cannot select File/Configure in my ESce session.

Cause

In ESce you must use the Connection Manager to configure and start your sessions.

Solution

1. Open the connection Manager.
2. Select the configure tab.
3. Double-click on the session that does not come up.

Problem 1.7

The light on the MinIT 6000 is green. The host session is black, with no cursor.

Cause

This could happen if another device has the same name. If that device is inactive, and you wish for this device to take that device's name, then you must delete the device on the AS/400 using WRKCFGSTS *DEV first.

Solution

Do not use spaces, asterisks, question marks, apostrophes, and double quotation marks in the **Name of Session**.

1. Open the connection Manager.
2. Select the configure tab.
3. Double-click on the session that does not come up.
4. Correct the name that is wrong or duplicated.

Problem 1.8

The light on the MinIT 6000 is green. The host session is black, with no cursor and I have verified that I am using a legal name with less than 9 letters and numbers.

Cause

This could happen if the IP address of the AS400 host is set wrong in the MinIT 6000.

Solution

- Verify that the MinIT 6000's ESce - **Host Configuration – IP Address** setting is correct and matches the AS/400. To find this on the AS/400, you must sign on with QSECOFR privileges and use **CFGTCP**, then choose **1. Work with TCP/IP interfaces**

If you are on the same physical network, verify that the subnet mask is the same as the AS/400's.

- To change the setup in the MinIT 6000, start the Connection Manager, either by double-clicking the desktop icon or using Start/Programs/Connection Manager.
 1. Click on the **Configure** tab.
 2. Double-click on the session that you are working on.
 3. Click on the **TCP/IP** tab.
 4. Make certain that the Host Configuration – IP Address is correct.

2. Network Problems

This category of problems assumes that you have other users already using TN5250E connections to the AS/400. If not, go to the PROBLEMS AT THE HOST section.

You are having a problem connecting to the AS/400. The first thing to do is make certain that you can ping the AS/400 and that the AS/400 can ping your device. If you cannot, then you have a network problem that has nothing to do with our software. We cannot help you to troubleshoot all of your network problems, but this guide may help.

Problem 2.1

Tried to connect the MinIT 6000 and it does not connect.

When you try to ping (see page 3) it fails with a message: "10 packets transmitted, 0 packets received, 100% packet loss – child process exited abnormally".

Cause

You may have a problem with your router(s), bridge(s), or hub(s), due to different subnet masks or the fact that you are on a different physical network.

Action

Verify that the IP Address of the AS/400 is on the same subnet as the MinIT 6000. The Subnet Masks must be the same. Address bits that are not 0, need to be the same. Must be on the same physical network.

First, ping the MinIT 6000 from the AS/400:

1. Go to any command line, where it says:
Selection or command

===>
2. Type PING '###.###.###.###' (where ###.###.###.### is the IP address that you are trying to reach, enclosed in single quotes)
3. You will get a message: "Verifying connection to host system ###.###.###.###". Put your cursor on that message and ROLL UP (which is the Page Down key in some of the better emulation packages).
4. If it says: " PING reply 1 from ###.###.###.### took 59 ms. 256 bytes. TTL 128", then roll up again to check the next five. At the end it should say: "Connection verification statistics: 5 of 5 successful (100 %)."
5. If it says "Unknown Host" or "No response from host within 1 seconds for connection verification 1." you have a network problem that needs to be resolved.

Solution

If you can ping one way, but not the other, this is probably a router problem. If a router table believes that a device is not on the network, it may misroute packets.

If the MinIT 6000 is at a remote site using a VPN connection to the host, make certain that the default gateway for the AS/400 is set that of the router providing the VPN connection.

Restart all routers and bridges.

If the IP address and subnet masks are logically on the same network, but you still cannot ping, then there may be a physical break in the networks. If the subnet for the AS/400 is not the same as the subnet for the MinIT 6000 Workstation, then they are on different supernets and would need a router to connect.

Check your hubs. Try pinging other devices to see what devices you can reach, and what the AS/400 can reach, to get a clue where the problem is. Look at the *lights*.

Problem 2.2

Tried to connect the MinIT 6000 and the host session is black, with no cursor. In the taskbar on the lower right, there is an X through the network symbol.

Cause

The network connection is bad or disconnected.

Action

1. Verify that the network cable is inserted properly. There is an orange light when it is connected properly.
2. Try swapping with a known good cable.
3. Make certain that any Hubs or Switches in the path to the Host are powered up.
4. Try another device in the TCP/IP connection.

3. Perceived 5250 Host Problems

The first problems in this category are for when there are other users who have Telnet sessions working.

Problem 3.1

You do not know the IP Address of the AS/400.

Solution

You will need access to the AS/400's command line from another terminal device or your system administrator to provide you with the correct IP address for the AS/400 that you want to connect to. For those that don't know, or would like to know the AS/400 command is as follows:

1. After signing on to the AS/400 with the appropriate privileges, from the command line type **CFGTCP** followed by the **<enter>** key.
2. On the next screen, select option **Work with TCP/IP Interfaces**, by typing a **1** and then **<enter>**.
3. Locate the interface that you are going to connect to. (If you only see 127.0.0.1 this means TCP/IP has not been properly configured on your AS/400. **DO NOT** use 127.0.0.1.

If you do so you will NEVER get a sign on from the AS/400. If TCP/IP is not configured on your AS/400 we recommend you follow the instructions from IBM. The name of the book is called "**Getting Your AS/400 Working for You**". Publication number is SC41-5161-00. You'll find helpful information on TCP/IP in Chapter 6.) Write down the IP address and enter that in the **MinIT 6000** configuration for this session's **Host Configuration – IP Address**.

Problem 3.2

It was working. The light on the MinIT 6000 is green. The MinIT 6000 host session is black, with no cursor.

Possible Cause 3.2.1

You have lost your IP connection. You could have a cable break, hub, bridge, or router down. This means that you are not accessing a valid IP address, or the Ethernet line is not up or MinIT 6000 or the host configuration was changed.

Action

1. Verify physical connection. Viewing lights is the usually the quickest way to do this.
2. See if others users are working, if not check the AS400 configuration.
3. Swap devices if possible to see if the problem follows the device in question.

Possible Cause 3.2.2

Disconnecting the session when you are not at a signon screen could cause this problem. This could also happen if you had a power outage and MinIT 6000 crashed and you had to re-boot. The AS/400 still has your session active, although in a crashed status.

Solution

If the last device using this station address crashed, the station address may be varied off. Ask the System Administrator to vary your device on. This may require varying off, then

back on. You can do this from the same MinIT 6000 if you create a new session, using the same IP address, but a different name.

To restart the original device, on an AS/400 command line:

1. Type **WRKCFGSTS *DEV *oldname*** followed by the <enter> key.
2. Type **WRKCFGSTS *DEV *yourdevice*** and then <enter>.
3. <Tab> to *oldname*
4. Put the cursor on the line to the left of your device and select option 2 to vary off and then select 1 to vary back on.

Notes:

- If security is not a priority, then Work with System Values (WRKSYSVAL) parameter QDEVRCYACN (Device I/O error action) can be changed to allow auto-recovery.
- The name cannot have any spaces between letters, get rid of the space.
- Using the same name for the session as someone else uses. If the device that had that name is no longer using it, the AS/400 device must be deleted.

4. 5250 Host Problems

In this category of problems, none of the TN5250E sessions are connecting including the MinIT6000.

Problem 4.1

The AS/400 cannot ping the MinIT6000.

Possible Cause

Your AS/400 may not be at the latest PTF level.

Solution

Make certain that the AS/400 is at the latest PTF level by checking the information on the system. You must have security officer privileges to do this.

1. From the command line, type **GO LICPGM** and then <enter>.
2. Select option **10** and then hit the <F11> key to see the information.
3. Contact your IBM person for assistance in verifying that your system is up to date.

Problem 4.2

Tried to connect the MinIT 6000 to the host and the terminal session is black with no cursor.

Possible Cause 4.2.1

The AS/400 may not have the Ethernet connection enabled.

Solution

1. On the AS/400 command line, type **CFGTCP** followed by the <enter> key.
2. Select the option **Work with TCP/IP interfaces**, by typing a **1** and then <enter>.
3. Type a **9** in the option field next to the appropriate Ethernet line and hit <enter> to start it. If it is already started, it will report: **“interface not started. ###.###.###.### interface already active”**.

- Verify the IP address. If it is correct, verify that the AS400 Ethernet line is active. To do so, type **WRKLIND**. The Ethernet line has a "Type" ***ELAN**. Find it and select option **8=Work with status** to verify an **Active** status.

Possible Cause 4.2.2

Telnet is not running because the Telnet or the Virtual Device Server may not be running.

Solution

First Verify that TELNET is set to begin when the AS/400 is powered up.

- On the AS/400 command line, type **CFGTCP** followed by the **<enter>** key.
- Select the option **Work with TCP/IP Interfaces**, by typing a **1** and then **<enter>** to verify the following information.

Opt	Internet Address	Subnet Mask	Line Description	Line Type
	127.0.0.1	255.0.0.0	*LOOPBACK	*NONE
	192.168.xxx.xxx	255.255.255.0	ENETLINE	*ELAN

- Type the **F12=Cancel** key to return to the previous menu.
- Select the option **Configure TCP/IP applications**, by typing a **20** and then **<enter>**.
- Select the option **Configure TELNET** by typing a **11** and then **<enter>**.
- Select the option **Change Telnet Attributes**, by typing a **1** and then **<enter>** to verify that "Autostart server" is set to ***YES**.

Next verify whether or not the TELNET server is currently running.

- On the AS/400 command line, type **NETSTAT** and then **<enter>**.
- Select the option **Work with TCP/IP connection status** by typing a **3** and then **<enter>**.
- Verify "**telnet**" has the "**State**" of "**Listen**" as shown below

Opt	Remote Address	Remote Port	Local Port	Idle Time	State
*	*	*	ftp-con >	0xx:xx:xx	Listen
*	*	*	telnet	0xx:xx:xx	Listen
*	*	*

- If "telnet" does not show up in the list of "Local Ports", type **STRTCPTELN** and then **<enter>** on the command line to start Telnet server.

Possible Cause 4.2.3

Telnet is not running because you don't have the option to configure "Telnet" or the right PTF's are not installed.

Solution

- Make certain that you have all of the PTFs for TN5250E by checking out our web site at <http://www.nlynx.com/html/tb-tm5250e.htm>
- If **Configure TELNET** does not exist, then contact IBM.

Possible Cause 4.2.4

The subsystem that runs your virtual devices is inactive.

Solution

1. Assuming you know the name of the subsystem you can easily check this by typing "**WRKACTJOB**" and then the <Enter> key.
2. Look for the subsystem; page down, if necessary. If you don't see it, type "**STRSBS ZZZ**" (where *ZZZ* equals the name of your subsystem) and then the <Enter> key.

Note: To start a subsystem, the user must have job control (*JOBCTL) special authority.

Possible Cause 4.2.5

The network route is not up.

Solution

Make certain that the route(s) is/are up and running.

1. On the AS/400 command line, type **CFGTCP** followed by the <enter> key.
2. Select the option **Work with TCP/IP Interfaces**, by typing a **1** and then <enter>.
3. Hit the <F11> key to **Display Interface Status**.
4. If it is "Inactive", use option **9** to start it.
5. If it reads "Starting", give it about a minute or so and then hit "**F5**" to refresh the display. If anything else other than "Inactive" or "Starting" appears it's time to get the AS/400 administrator involved and if he or she is already involved then it's time to call IBM, or your AS/400 Consultant.

Possible Cause 4.2.6

The **Ethernet standard** is not set to ***ALL** or the **line speed** setting is not correct.

Solution

If you're connecting the AS/400 via an Ethernet line there is a parameter, which may prevent the MinIT 6000 from 'talking' to the AS/400. This can be checked by:

1. On the AS/400 command line, type **WRKCFGSTS *LIN** followed by the <enter> key.
2. Once you locate the line you are trying to connect to, select the option **Work with Description**, by typing a **8** and then <enter>.
3. Type the **5** and then <enter> to bring up the **Display**.
4. Make sure that **Ethernet standard** is set to ***ALL** and that the correct **line speed** is displayed.
5. The line speed can be changed by hitting the <F12> key to **Cancel** and then selecting option **2**.
6. If you need to change **Ethernet standard** you will have to type **CRTLINETH** and create a new line description. For this help, consult your AS/400 administrator or IBM. You can also try the IBM publication, "Getting Your AS/400 Working for You" (**SC41-5161-00**), chapter 6.

Problem 4.3

Unable to connect the MinIT 6000 to the host and the AS/400 cannot ping the MinIT6000. The AS/400 is at the latest PTF and CUM level and is able to ping other devices. Also, your network administrator made sure the the IP addresses are correct.

Possible Cause 4.3.1

There is a network problem caused by the routing tables in one of the network bridges or routers.

Solution

1. Recreate the Ethernet line. **Do not override** the MAC address.
2. Check the routing tables and/or reset the bridges and routers.

Possible Cause 4.3.2

One of the network devices or networked nodes is improperly configured.

Solution

1. Try to ping the AS/400 by typing on the command line **PING 'x.x.x.x'**, where x = IP address of your MinIT6000.
2. Assuming you that are not successful at "Pinging" the MinIT6000, try "Pinging" the WAN side of the router. If you can PING the WAN side but not the Ethernet side of the router, then there's probably something wrong with the configuration of the router. If you cannot PING the network side of the router then there's probably something wrong with the TCP/IP configuration on the AS/400. Specifically, the route configuration or the subnet mask on the AS/400 could be wrong but it could be something else.
3. It is recommended that you consult your AS/400 Administrator, your AS/400 Consultant or IBM. You can also try the IBM publication, "Getting Your AS/400 Working for You" (SC41-5161-00), chapter 6.

Problem 4.4

The AS/400 can ping the MinIT6000 but the session never starts. The light on the MinIT 6000 is green. The host session is black, with no cursor.

Possible Cause 4.4.1

The MinIT 6000 supports 'Enhanced Telnet 5250' or TN5250E. The main feature that TN5250E provides is Persistent LU naming, which is where the name that you provide when you set each MinIT 6000 session up is the one that the AS/400 sees for your session.

Two Possible problems can occur.

1. Certain names are invalid. If another TCP/IP client uses a name it cannot be used.
2. The AS/400 will either have this enabled or not.

Solution

1. You cannot use a name that someone else is using.
2. Blanks are not allowed within the name.
3. You cannot use spaces or dashes or any other character than letters or numbers.
4. Case is ignored.
5. There is a maximum of nine characters.
6. Because most system-supplied objects on this system begin with Q, your names should not start with a Q.

Possible Cause 4.4.2

Improper configuration of the subsystem used for the virtual devices.

Solution

Our product emulates different IBM terminals depending on the color and width selection. For 132 wide configurations, the MinIT6000 emulates an IBM 3477 terminal. For monochrome 80 wide, it emulates a 5251. For 80 wide color configuration it emulates 3179. This means your subsystem (typically, **QINTER**) must allow a 3179. To verify this:

1. On the AS/400 command line, type **WRKSBSD *ALL** followed by the <enter> key.
2. Locate the subsystem you're using for the virtual devices, select the option **Display**, by typing a **5** and then <enter>.
3. On the next display, select the option **Workstation type entries** by typing a **5** and then <Enter>.
4. On the next display, verify that you see a "Type" of "***all**", or a type of "**3179**".
5. If so, select option **Display workstation type details** by typing a **5** and then <Enter>.
6. On the next display you should see an appropriate value for the "**Maximum active jobs**" parameter. You can make changes in one or both cases by typing **CHGWSE** (or **ADDWSE**), followed by the <Enter> key, and making the appropriate changes.

Problem 4.5

Unable to connect the MinIT 6000 to the host however, the AS/400 can ping the MinIT 6000, the AS/400 is at the latest PTF and CUM level and can ping other devices. Your Network Administrator made certain that the IP addresses are correct and you have recreated the Ethernet line and restarted all routers.

Possible Cause

Your AS/400 is not set up for enough virtual devices.

Solution

1. On the AS/400 command line, type **WRKSYSVAL** followed by the <enter> key.
2. Scroll down to the "System Value" of **QAUTOVRT**.
3. Type a 5 in the option field to display the number of virtual devices allowed.
4. Make certain that you allow for enough.

5. Printer Problems

Common MinIT 6000 printer session errors.

Problem 5.1

When you try to start the printer it says "Device already in use", then "The connection request has been rejected by the host".

Possible Cause

Had a printer already configured with that name at the AS400.

Solution

You must delete the session on the MinIT 6000 and re-create it with a different name or delete the other printer from the AS/400.

Problem 5.2

When you try to start a printer session, it pops up with a message: “**The connection request has been rejected by the host**”.

Possible Cause 5.2.1

Using Host Print Transform but the Host Print Transform Name is not valid.

Solution

The name must have the splat (asterisk) *, in front of it. You must use a manufacturer and Model that is supported by your AS/400.

1. On your AS400, Using the **CHGDEVPRT** command, the printer settings should be:

Host print transform *YES

Manufacturer type and model. . *SAME

2. Place the cursor on the **Manufacturer type and model.. *SAME** line.
3. Press **F4**, which will bring up the **Specify Value for Parameter MFRTYPMDL**. This is where you can see your choices for Manufacturer type and model. For example: *IBM3280, *HP11, *HP5SI, *EPDFX5000, *LEXOPTRA, *EPLQ860, *CANLIPS3, *OKI320IBM, *NECP2200, *PAN2624EP, *XR4235, or *WSCSTLETTER.
4. If you want more information on what one of these choices support, you can use **F1** on this screen. You do not have to find your exact model. For instance, if you have an HP printer it is likely that any of the lower level HP selections will work, like HP11 or HP111, because all HP printers support PCL, and the difference between them is in the options that are supported.
5. Once you have chosen a printer to try, you must type that in on the **Manufacturer type and model** field.

Possible Cause 5.2.2

Using Host Print Transform but the printer name is not valid or you are using *WSCST, but the name or library is not valid.

Solution

- Make certain that you put an * in front of the name.
- Change the IBMWSCSTNAME to QWPDEFAULT
- Change the IBMWSCSTLIB to QGPL

For further help, you can contact Technical Support at <http://www.nlynx.com/html/contacttechnicalsupport.htm>

Free Manuals Download Website

<http://myh66.com>

<http://usermanuals.us>

<http://www.somanuals.com>

<http://www.4manuals.cc>

<http://www.manual-lib.com>

<http://www.404manual.com>

<http://www.luxmanual.com>

<http://aubethermostatmanual.com>

Golf course search by state

<http://golfingnear.com>

Email search by domain

<http://emailbydomain.com>

Auto manuals search

<http://auto.somanuals.com>

TV manuals search

<http://tv.somanuals.com>