

RM-230 User Guide

9255338
Issue 1 9-Feb-07

DECLARATION OF CONFORMITY

Hereby, NOKIA CORPORATION declares that this RM-230 product is in compliance with the essential requirements and other relevant provisions of Directive 1999/5/EC. A copy of the Declaration of Conformity can be found at http://www.nokia.com/phones/declaration_of_conformity/

CE 0434

© 2007 Nokia. All rights reserved.

Nokia, Nokia Connecting People, Nokia Care, Navi, and Visual Radio are trademarks or registered trademarks of Nokia Corporation. Nokia tune and Visual Radio are sound marks of Nokia Corporation. Other product and company names mentioned herein may be trademarks or tradenames of their respective owners.

Reproduction, transfer, distribution, or storage of part or all of the contents in this document in any form without the prior written permission of Nokia is prohibited.

symbian This product includes software licensed from Symbian Software Ltd © 1998-2007. Symbian and Symbian OS are trademarks of Symbian Ltd.

US Patent No 5818437 and other pending patents. T9 text input software Copyright (C) 1997-2007. Tegic Communications, Inc. All rights reserved.



Java™ and all Java-based marks are trademarks or registered trademarks of Sun Microsystems, Inc.

This product is licensed under the MPEG-4 Visual Patent Portfolio License (i) for personal and noncommercial use in connection with information which has been encoded in compliance with the MPEG-4 Visual Standard by a consumer engaged in a personal and noncommercial activity and (ii) for use in connection with MPEG-4 video provided by a licensed video provider. No license is granted or shall be implied for any other use. Additional information, including that related to promotional, internal, and commercial uses, may be obtained from MPEG LA, LLC. See <<http://www.mpegla.com>>.

Nokia operates a policy of ongoing development. Nokia reserves the right to make changes and improvements to any of the products described in this document without prior notice.

TO THE MAXIMUM EXTENT PERMITTED BY APPLICABLE LAW, UNDER NO CIRCUMSTANCES SHALL NOKIA OR ANY OF ITS LICENSORS BE RESPONSIBLE FOR ANY LOSS OF DATA OR INCOME OR ANY SPECIAL, INCIDENTAL, CONSEQUENTIAL OR INDIRECT DAMAGES HOWSOEVER CAUSED.

THE CONTENTS OF THIS DOCUMENT ARE PROVIDED "AS IS". EXCEPT AS REQUIRED BY APPLICABLE LAW, NO WARRANTIES OF ANY KIND, EITHER EXPRESS OR IMPLIED, INCLUDING, BUT NOT LIMITED TO, THE IMPLIED WARRANTIES OF MERCHANTABILITY AND FITNESS FOR A PARTICULAR PURPOSE, ARE MADE IN RELATION TO THE ACCURACY, RELIABILITY OR CONTENTS OF THIS DOCUMENT. NOKIA RESERVES THE RIGHT TO REVISE THIS DOCUMENT OR WITHDRAW IT AT ANY TIME WITHOUT PRIOR NOTICE.

The availability of particular products and applications for these products may vary by region. Please check with your Nokia dealer for details, and availability of language options.

This device complies with Directive 2002/95/EC on the restriction of the use of certain hazardous substances in electrical and electronic equipment.

Export controls

This device may contain commodities, technology or software subject to export laws and regulations from the US and other countries. Diversion contrary to law is prohibited.

NO WARRANTY

The third-party applications provided with your device may have been created and may be owned by persons or entities not affiliated with or related to Nokia. Nokia does not own the copyrights or intellectual property rights to the third-party applications. As such, Nokia does not take any responsibility for end-user support, functionality of the applications, or the information in the applications or these materials. Nokia does not provide any warranty for the third-party applications.

BY USING THE APPLICATIONS YOU ACKNOWLEDGE THAT THE APPLICATIONS ARE PROVIDED AS IS WITHOUT WARRANTY OF ANY KIND, EXPRESS OR IMPLIED, TO THE MAXIMUM EXTENT PERMITTED BY APPLICABLE LAW. YOU FURTHER ACKNOWLEDGE THAT NEITHER NOKIA NOR ITS AFFILIATES MAKE ANY REPRESENTATIONS OR WARRANTIES, EXPRESS OR IMPLIED, INCLUDING BUT NOT LIMITED TO WARRANTIES OF TITLE, MERCHANTABILITY OR FITNESS FOR A PARTICULAR PURPOSE, OR THAT THE APPLICATIONS WILL NOT INFRINGE ANY THIRD-PARTY PATENTS, COPYRIGHTS, TRADEMARKS, OR OTHER RIGHTS.

Model: 5700

9255338 Draft

Contents

For your safety	6	5. Messaging	30
General information	8	Write and send messages	31
Access codes	8	Inbox—receive messages	33
Nokia support and contact information	9	My folders	34
1. Get started	10	Mailbox	34
Insert a (U)SIM card and battery	10	Outbox	35
MicroSD card slot	11	View messages on the SIM card	36
Charge the battery	12	Cell broadcast	36
Switch the phone on and off	13	Service command editor	36
Set time and date	13	Messaging settings	36
Normal operating position	13	Message reader	40
Configuration settings	13	6. Contacts	40
2. Your phone	14	Manage contacts	40
Keys and parts	14	Manage contact groups	41
Modes	15	Add a ringing tone	41
Standby mode	16	Assign speed dialing keys	41
Indicators	17	7. Gallery	42
Menu	19	Gallery functions	42
Welcome application	19	8. Music player	45
Tutorial	19	Listen to music	46
Help	20	Music menu	46
Volume control	20	Playlists	47
Keypad lock (keyguard)	20	Music shop	47
Connect a compatible headset	21	Transfer music	48
Connect a USB data cable	21	9. Media	49
Attach a wrist strap	21	Visual Radio	49
3. Call functions	21	Camera	52
Make a voice call	21	Movie director	54
Answer or reject a call	23	Videos	56
Make a video call	24	Recorder	56
Answer a video call	25	RealPlayer	56
Video sharing	26	Flash Player	57
Log	28	10. Personalization	58
4. Write text	28	Themes	58
Traditional text input	29	Profiles	58
Predictive text input	29	3-D tones	59
Copy and delete text	30		

11.Web.....	60	Connection manager.....	86
Mobile Search.....	60	Push to talk.....	87
Web.....	60	Remote synchronization	91
12.Organizer	65	Infrared	92
Clock.....	65	Modem	92
Calendar	66	USB data cable.....	93
Notes.....	67	Data transfer	93
Calculator.....	68	16.Data manager	94
Converter.....	68	Application manager.....	94
13.Applications	69	File manager.....	96
Download!.....	69	Device manager.....	96
My own.....	69	Memory card	97
14.Settings	70	Activation keys.....	98
Voice commands.....	70	17.Battery information	99
Call mailbox	71	Charging and discharging.....	99
Speed dial	71	Nokia battery authentication	
Phone settings.....	71	guidelines	100
Speech.....	80	18.Enhancements	101
Settings wizard.....	80	Care and maintenance.....	101
Instant messaging	81	Additional safety information	103
15.Connectivity.....	84	Index	107
PC Suite.....	84		
Bluetooth connection.....	84		

For your safety

Read these simple guidelines. Not following them may be dangerous or illegal. Read the complete user guide for further information.



SWITCH ON SAFELY

Do not switch the device on when wireless phone use is prohibited or when it may cause interference or danger.



ROAD SAFETY COMES FIRST

Obey all local laws. Always keep your hands free to operate the vehicle while driving. Your first consideration while driving should be road safety.



INTERFERENCE

All wireless devices may be susceptible to interference, which could affect performance.



SWITCH OFF IN HOSPITALS

Follow any restrictions. Switch the device off near medical equipment.



SWITCH OFF IN AIRCRAFT

Follow any restrictions. Wireless devices can cause interference in aircraft.



SWITCH OFF WHEN REFUELING

Do not use the device at a refueling point. Do not use near fuel or chemicals.



SWITCH OFF NEAR BLASTING

Follow any restrictions. Do not use the device where blasting is in progress.



USE SENSIBLY

Use only in the normal position as explained in the product documentation. Do not touch the antenna unnecessarily.



QUALIFIED SERVICE

Only qualified personnel may install or repair this product.



ENHANCEMENTS AND BATTERIES

Use only approved enhancements and batteries. Do not connect incompatible products.



WATER-RESISTANCE

Your device is not water-resistant. Keep it dry.



BACK-UP COPIES

Remember to make back-up copies or keep a written record of all important information stored in your device.



CONNECTING TO OTHER DEVICES

When connecting to any other device, read its user guide for detailed safety instructions. Do not connect incompatible products.



EMERGENCY CALLS

Ensure the phone function of the device is switched on and in service. Press the end key as many times as needed to clear the display and return to the standby mode. Enter the emergency number, then press the call key. Give your location. Do not end the call until given permission to do so.

■ About your device

The wireless device described in this guide is approved for use on the GSM 850, 900, 1800, and 1900 and UMTS 2100 networks. Contact your service provider for more information about networks.

When using the features in this device, obey all laws and respect local customs, privacy and legitimate rights of others, including copyrights.

Copyright protections may prevent some images, music (including ringing tones), and other content from being copied, modified, transferred, or forwarded.

Your device supports internet connections and other methods of connectivity. Like computers, your device may be exposed to viruses, malicious messages and applications, and other harmful content. Exercise caution and open messages, accept connectivity requests, download content, and accept installations only from trustworthy sources. To increase the security of your device, consider installing antivirus software with a regular update service and using a firewall application.



Warning: To use any features in this device, other than the alarm clock, the device must be switched on. Do not switch the device on when wireless device use may cause interference or danger.

■ Network services

To use the phone you must have service from a wireless service provider. Many of the features require special network features. These features are not available on all networks; other networks may require that you make specific arrangements with your service provider before you can use the network services. Your service provider can give you instructions and explain what charges will apply. Some networks may have limitations that affect how you can use network services. For instance, some networks may not support all language-dependent characters and services.

Your service provider may have requested that certain features be disabled or not activated in your device. If so, these features will not appear on your device menu. Your device may also have a special configuration such as changes in menu names, menu order, and icons. Contact your service provider for more information.

This device supports WAP 2.0 protocols (HTTP and SSL) that run on TCP/IP protocols. Some features of this device, such as web browsing, e-mail, push to talk, instant messaging, and multimedia messaging, require network support for these technologies.

■ Enhancements, batteries, and chargers

Check the model number of any charger before use with this device. This device is intended for use when supplied with power from the AC-3, AC-4, AC-5, DC-4 chargers or CA-44 charger adapter.



Warning: Use only batteries, chargers, and enhancements approved by Nokia for use with this particular model. The use of any other types may invalidate any approval or warranty, and may be dangerous.

For availability of approved enhancements, please check with your dealer. When you disconnect the power cord of any enhancement, grasp and pull the plug, not the cord.

General information

Model: 5700

■ Access codes

Lock code

The lock code (5 to 10 digits) helps to protect your phone against unauthorized use. The preset code is 12345. Change the code, and keep the new code secret and in a safe place separate from your phone. To change the code and to set the phone to request the code, see "Security," p. 73.

If you enter an incorrect lock code five times in succession, the phone ignores further entries of the code. Wait for 5 minutes, and enter the code again.

When the device is locked, calls may be possible to the official emergency number programmed into your device.

PIN codes

The personal identification number (PIN) code and the universal personal identification number (UPIN) code (4 to 8 digits) help to protect your SIM card against unauthorized use. See "Security," p. 73. The PIN code is usually supplied with the SIM card.

The PIN2 code (4 to 8 digits) may be supplied with the SIM card and is required for some functions.

The module PIN is required to access the information in the security module. The module PIN is supplied with the SIM card if the SIM card has a security module in it.

The signing PIN is required for the digital signature. The signing PIN is supplied with the SIM card if the SIM card has a security module in it.

PUK codes

The personal unblocking key (PUK) code and the universal personal unblocking key (UPUK) code (8 digits) are required to change a blocked PIN code and UPIN code, respectively. The PUK2 code is required to change a blocked PIN2 code.

If the codes are not supplied with the SIM card, contact your local service provider for the codes.

Barring password

The barring password (4 digits) is required when using *Call barring*. See "Call barring," p. 77. You can obtain the password from your service provider.

If you enter an incorrect barring password three times in succession, the password is blocked. Contact your service provider.

■ Nokia support and contact information

On the web site, you can get information on the use of Nokia products and services. If you need to contact customer service, check the list of local Nokia contact centers at www.nokia.com/customerservice.

For maintenance services, check your nearest Nokia service center at www.nokia.com/repair.

Software updates

Nokia may produce software updates that may offer new features, enhanced functions, or improved performance. You may be able to request these updates through the Nokia Software Updater PC application. To update the device software, you need the Nokia Software Updater application and a compatible PC with Microsoft Windows 2000 or XP operating system, broadband internet access, and a compatible data cable to connect your device to the PC.

To get more information and to download the Nokia Software Updater application, visit www.nokia.com/softwareupdate or your local Nokia web site.

1. Get started

■ Insert a (U)SIM card and battery

Always switch the device off and disconnect the charger before removing the battery.

This phone uses BP-5M batteries.

For availability and information on using SIM card services, contact your SIM card vendor. This may be the service provider or other vendor.

1. To open the back cover of the phone for the first time, lift it using the plastic strip shown on the back of the phone (1). You can then remove the strip.

To open the back cover later, turn the lower part of the phone 90 degrees left or right when the number keys of the lower part are on the same side as the display, and lift the back cover (2). To remove the battery, lift it as shown (3).

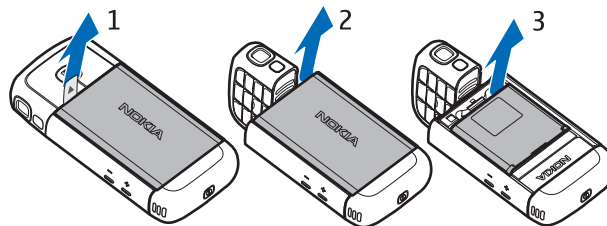

2. To release the SIM card holder, slide it backwards (4), and lift it (5).

Insert the (U)SIM card to the SIM card holder (6). Make sure that the (U)SIM card is properly inserted and that the golden-colored contact area on the card is facing downwards, and the beveled corner faces upwards.

Close the SIM card holder (7), and slide it forward to lock it (8).

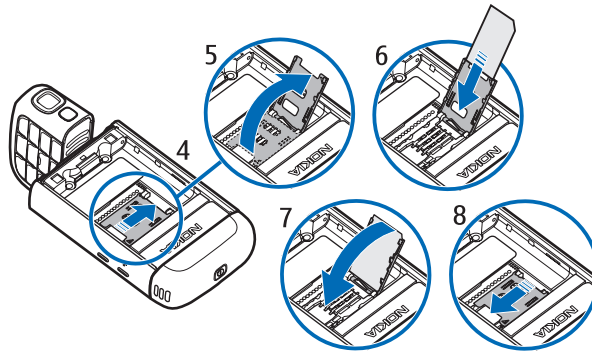

3. Replace the battery (9). Replace the back cover (10) and (11).

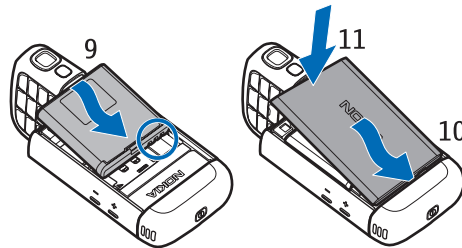

■ MicroSD card slot

Use only compatible microSD cards approved by Nokia for use with this device. Nokia uses approved industry standards for memory cards, but some brands may not be fully compatible with this device. Incompatible cards may damage the card and the device and corrupt data stored on the card.



Keep microSD cards out of the reach of small children.

You can extend the available memory with a microSD memory card. You can insert or remove a microSD card without switching the phone off.



Important: Do not remove the memory card in the middle of an operation when the card is being accessed. Removing the card in the middle of an operation may damage the memory card as well as the device, and data stored on the card may be corrupted.

Insert a microSD card

Note that the memory card may be supplied with the phone, and may already be inserted.

1. Open the side door (1).
2. Place the microSD card in the slot with the golden contact area facing down (2). Push the card gently to lock it into place.
3. Close tight the side door (3).

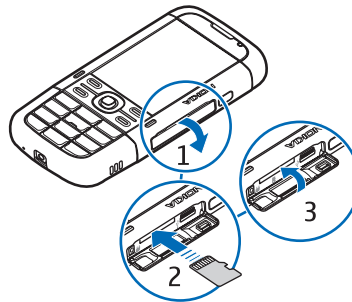

Remove a microSD card

1. Open the side door.
2. Push the card gently to release it. *Remove memory card and press 'OK'* is displayed. Pull the card out, and select **OK**.
3. Close tight the side door.

■ Charge the battery

1. Connect the charger to the wall socket.
2. Open the side door (1), and connect the charger plug to the charger connector in the phone (2).
3. After charging, close tight the side door.

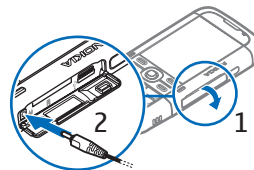

If the battery is completely discharged, it may take a few minutes before the charging indicator appears on the display or before any calls can be made.

The charging time depends on the charger and the battery used. Charging a BP-5M battery with the AC-5 charger takes approximately 80 minutes.

■ Switch the phone on and off

Press and hold the power key.

If the phone asks for a PIN code, enter the PIN code, and select **OK**.

If the phone asks for the lock code, enter the lock code, and select **OK**. The factory setting for the lock code is 12345.

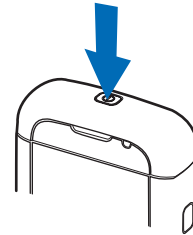

■ Set time and date

To set the correct time zone, time, and date, select the country you are presently in, then enter the local time and date.

■ Normal operating position

Use the phone only in its normal operating position.



Note: As with any radio transmitting device, avoid touching an antenna unnecessarily when the antenna is in use. For example, avoid touching the cellular antenna during a phone call. Contact with a transmitting or receiving antenna affects the quality of the radio communication, may cause the device to operate at a higher power level than otherwise needed, and may reduce the battery life.



Your device has internal antennas.

Cellular antenna (1)

Bluetooth antenna (2)

■ Configuration settings

Before you can use multimedia messaging, instant messaging, push to talk, e-mail, synchronization, streaming, and the browser, you must have the proper configuration settings on your phone. Your phone may automatically configure browser, multimedia messaging, access point, and streaming settings based on the SIM card used. You may also receive the settings directly as a configuration message,

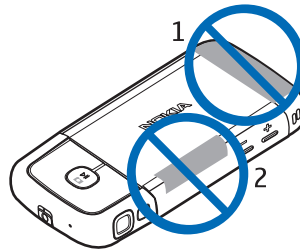

which you save to your phone. For more information on availability, contact your service provider or nearest authorized Nokia dealer.

When you receive a configuration message, and the settings are not automatically saved and activated, *1 new message* is displayed. Select **Show** to open the message. To save the settings, select **Options > Save**. You may need to enter a PIN code provided by the service provider.

2. Your phone

■ Keys and parts

- Power key (1)
- Loudspeaker (2)
- Earpiece (3)
- Volume keys (4)
- Left and right selection keys (5)
- Menu key (6), hereafter described as "select **Menu**"
- Clear key (7)
- Call key (8)
- End key (9)
- Navi™ scroll key (10), hereafter referred to as scroll key
- Number keys (11)
- Microphone (12)
- Nokia AV 2.5-mm connector (13)
- Loudspeaker (14)
- Charger connector (15)
- microSD card slot (16)
- USB connector (17)
- Infrared port (18)

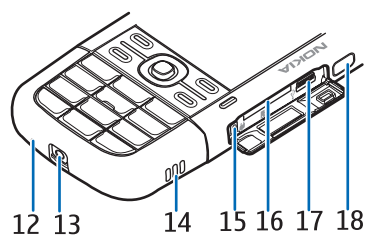
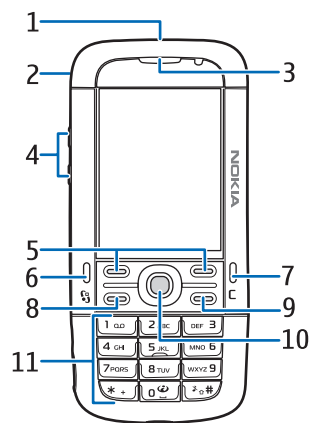

Media keys:

Rewind, zoom out (19)

Play/Pause/Stop, capture key (20)

Fast forward, zoom in (21)

Camera lens (22)

Camera flash (23)

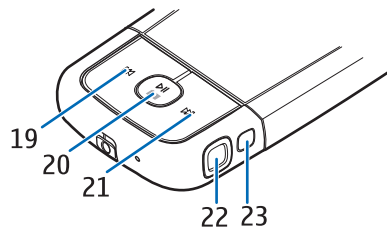

■ Modes

Your phone has five functional modes: phone mode (1), camera mode (2), music mode (3), video call mode (4), and video view mode. To switch between the modes, turn the lower part of the phone. There is a short pause before a mode is activated. In the phone mode, do not try to rotate the lower part of the phone more than 90 degrees to the left or 180 degrees to the right. If you force the lower part of the phone to rotate more, the phone will be damaged.

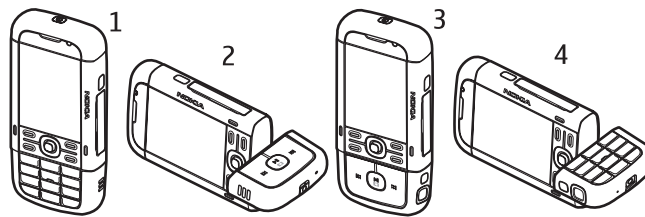

Phone mode

The phone mode is activated when the number keys of the lower part are on the same side as the display.

Camera mode

To activate the camera mode while in the phone mode, turn the lower part of the phone 90 degrees to the left so that the camera lens is pointing away from you when you look at the display.

To take a self portrait, turn the lower part of the phone 90 degrees to the right while in the phone mode so that the camera lens is pointing toward you when you look at the display.

Music mode

To activate the music mode while in the phone mode, turn the lower part of the phone 180 degrees to the right so that the keys used to control music playback are on the same side as the display.

Video call mode

During video calls, you can let the call recipient to see your face. Turn the lower part of the phone so that the camera lens is pointing toward you when you look at the display. You can also turn the camera lens to the opposite direction.

Video view mode

When you are viewing a video or still images in the phone mode, you can activate the video view mode. Turn the lower part of the phone 90 degrees to the left so that the camera lens is pointing away from you. In video view mode the display automatically changes to landscape, and you can put the phone on the table, for example, while viewing.

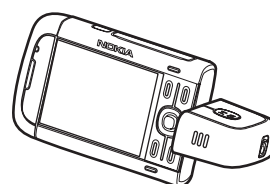

To view the next or previous still images or to fast forward or rewind the video, press the fast forward or rewind media key.

To play or pause the video, press the play/pause/stop media key. To stop the video, press and hold the play/pause/stop media key.

■ Standby mode

When you have switched on the phone, and it is registered to a network, the phone is in the standby mode and ready for use.

To open the list of last dialed numbers, press the call key.

To use the voice commands or voice dialing, press and hold the right selection key.

To change the profile, press the power key, and select a profile.

To start a connection to the web, press and hold 0.

Active standby

When active standby is enabled, you can use the display for fast access to frequently used applications. To select whether the active standby is shown, select

[Menu](#) > [Settings](#) > [Phone sett.](#) > [General](#) > [Personalisation](#) > [Standby mode](#) > [Active standby](#) > [On](#) or [Off](#).

To access active standby applications, scroll to the application, and select it. In active standby the default applications are shown across the top of the active standby area, and calendar, to-do, and player events are listed below. To select an application or event, scroll to it, and select it.

Offline profile









The [Offline](#) profile lets you use the phone without connecting it to a network. When the [Offline](#) profile is active, the connection to the wireless network is turned off, as indicated by  in the signal strength indicator area. All wireless RF signals to or from your phone are prevented, and you can use your device without a (U)SIM card. Use the offline profile in radio sensitive environments—on board aircraft or in hospitals. You can listen to music using the music player when the offline profile is active.





















To leave the Offline profile, press the power key, and select another profile.



Important: In the offline profile you cannot make or receive any calls, or use other features that require cellular network coverage. Calls may still be possible to the official emergency number programmed into your device. To make calls, you must first activate the phone function by changing profiles. If the device has been locked, enter the lock code.

■ Indicators

-  The phone is connected to a UMTS network.
-  The phone is connected to a GSM network.
-  The phone is in offline mode and not connected to a cellular network. See "Offline profile," p. 17.
-  You received one or several messages to the [Inbox](#) folder in [Messaging](#).
-  You received new e-mail in your remote mailbox.
-  There are messages waiting to be sent in [Outbox](#). See "Outbox," p. 35.
-  You have missed calls. See "Recent calls," p. 28.
-  Shown if [Ringing type](#) is set to [Silent](#) and [Message alert tone](#) and [E-mail alert tone](#) are set to [Off](#). See "Profiles," p. 58.

-  The phone keypad is locked. See "Keypad lock (keyguard)," p. 20.
-  The loudspeaker is activated.
-  An alarm is active.
- 2** The second phone line is being used. See *Line in use* in "Call," p. 76.
-  /  All calls to the phone are diverted to your call mailbox or to another number. If you have two phone lines, the divert indicator is **1** for the first line and **2** for the second.
-  A headset is connected to the phone.
-  A loopset is connected to the phone.
-  The connection to a Bluetooth headset has been lost.
- D / D*** A data call is active.
-  A GPRS packet data connection is active.  indicates the connection is on hold and  that a connection is available.
-  A packet data connection is active in a part of the network that supports EGPRS.  indicates the connection is on hold and  that a connection is available. The icons indicate that EGPRS is available in the network, but your device is not necessarily using EGPRS in the data transfer.
-  A UMTS packet data connection is active.  indicates the connection is on hold and  that a connection is available.
-  Bluetooth is switched on.
-  Data is being transmitted using Bluetooth. See "Bluetooth connection," p. 84.
-  An infrared connection is active. When infrared is active, but there is no connection, the indicator blinks.
-  A USB connection is active.

Other indicators may also be shown. For push to talk indicators, see "Push to talk," p. 87.

■ Menu

In the menu you can access the functions in your phone. To access the main menu, press the menu key; hereafter described as "select **Menu**".

To open an application or a folder, scroll to it, and press the scroll key.

To change the menu view, select **Menu** > **Options** > *Change Menu view* and a view type.

If you change the order of the functions in the menu, the order may differ from the default order described in this user guide.

To close an application or a folder, select **Back** and **Exit** as many times as needed to return to the standby mode, or select **Options** > *Exit*.

To display and switch between open applications, select and hold **Menu**. The application switching window opens, showing a list of open applications. Scroll to an application, and select it.

To mark or unmark an item in applications, press **#**. To mark or unmark several consecutive items, press and hold **#**, and scroll up or down.

Leaving applications running in the background increases the demand on battery power and reduces the battery life.

■ Welcome application

Welcome application starts when you switch on your phone for the first time.

With the *Welcome* application, you can access the following applications:

Tutorial—Learn about the features of your phone and how to use them.

Settings wizard—Configure connection settings.

Data transfer—Copy or synchronize data from other compatible phones.

To open Welcome later, select **Menu** > *Applications* > *Welcome*.

■ Tutorial

Tutorial contains an introduction to the phone features and a tutorial to teach how to use the phone. The tutorial starts automatically when you turn on your phone for the first time. To start the tutorial yourself, select **Menu** > *Tutorial* and a tutorial item.

■ Help



Your device has context-sensitive help. You can access the help from an application or from the main menu.

To access help when an application is open, select **Options** > **Help**. To switch between help and the application that is open in the background, select and hold **Menu**. Select **Options** and from the following options:

Topic list—to view a list of available topics in the appropriate category

Help category list—to view a list of help categories

Search by keyword—to search for help topics using keywords

To open help from the main menu, select **Menu** > **Applications** > **Help**. In the list of help categories, select the desired application to view a list of help topics. To switch between the help category list, indicated with , and a keywords list, indicated with  abc, scroll left or right. To display the related help text, select it.

■ Volume control

To adjust the earpiece or loudspeaker volume during a call or when listening to an audio file, press the volume keys.

To activate the loudspeaker during a call, select **Loudspeaker**.

To deactivate the loudspeaker during a call, select **Handset**.



Warning: Do not hold the device near your ear when the loudspeaker is in use, because the volume may be extremely loud.

■ Keypad lock (keyguard)

To prevent accidental keypresses, you can lock the keypad.

To lock the keypad in the phone mode, press the left selection key and * within 1.5 seconds. To set the phone to automatically lock the keypad after a certain time, select **Menu** > **Settings** > **Phone sett.** > **General** > **Security** > **Phone and SIM card** > **Keypad autolock period** > **User defined** and the desired time.

To lock the keypad in music mode, press the power key quickly, and select **Lock keypad**.

To unlock the keypad in the phone mode, select **Unlock**, and press * within 1.5 seconds.

To unlock the keypad in music mode, select **Unlock** > **OK**.

When the keypad lock is on, calls may be possible to the official emergency number programmed into your device.

■ Connect a compatible headset

Do not connect products that create an output signal as this may cause damage to the device. Do not connect any voltage source to the Nokia AV connector.

When connecting any external device or any headset, other than those approved by Nokia for use with this device, to the Nokia AV connector, pay special attention to volume levels.

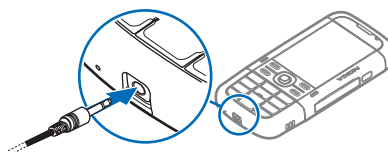

■ Connect a USB data cable

To set the default USB connection mode, select **Menu > Settings > Connectivity > USB > USB mode** and the desired mode. To set whether the default mode is activated automatically, select **Ask on connection > No**.

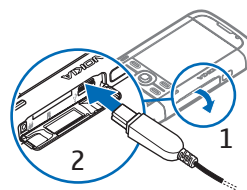

■ Attach a wrist strap

Connect the wrist strap according to the graphic.

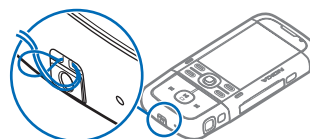

3. Call functions

■ Make a voice call

1. In the standby mode, enter the phone number, including the area code. Press the clear key to remove a number.

For international calls, press * twice for the international prefix (the + character replaces the international access code), and enter the country code, area code (omit the leading zero if necessary), and phone number.

2. To call the number, press the call key.

To adjust the volume during the call, press the volume keys.

3. To end the call, or to cancel the call attempt, press the end key.

To make a call from [Contacts](#), select [Menu](#) > [Contacts](#). Scroll to the desired name; or enter the first letters of the name, and scroll to the desired name. To call the number, press the call key.

To call your call mailbox (network service), press and hold 1 in the standby mode. You must define the mailbox number before you can call your mailbox. See "Call mailbox," p. 71.

To call a recently dialed number, press the call key in the standby mode. The list of the last 20 numbers you called or attempted to call is shown. Scroll to the number you want, and press the call key.

To make a push to talk call, see "Push to talk," p. 87.

Speed dialing

You can assign a phone number to one of the speed dialing keys 2 to 9. See "Assign speed dialing keys," p. 41, or "Speed dial," p. 71.

Call a speed dialing number in either of the following ways:

- Press the speed dialing key, then the call key.
- If [Speed dialing](#) is set to [On](#), press and hold the speed dialing key until the call begins. To set [Speed dialing](#) to [On](#), select [Menu](#) > [Settings](#) > [Phone sett.](#) > [Phone](#) > [Call](#) > [Speed dialing](#) > [On](#).

Voice dialing

A voice tag is added automatically to all entries in [Contacts](#).

Use long names, and avoid similar names for different numbers.

Make a voice dialing call

Voice tags are sensitive to background noise. Use voice tags in a quiet environment.



Note: Using voice tags may be difficult in a noisy environment or during an emergency, so you should not rely solely upon voice dialing in all circumstances.

1. In the standby mode, press and hold the right selection key. A short tone is played, and [Speak now](#) is displayed.

If you are using a compatible headset with the headset key, press and hold the headset key.

2. Speak the voice command clearly. The phone plays the voice command of the best match. After 1.5 seconds, the phone dials the number; if the result is not the correct one, before dialing select **Next** and another entry.

Using voice commands to carry out a phone function is similar to voice dialing. See "Voice commands," p. 70.

Make a conference call (network service)

1. Make a call to the first participant.
2. To make a call to another participant, select **Options** > **New call**. The first call is automatically put on hold.
3. To join the first participant in the conference call when the new call is answered, select **Options** > **Conference**.
To add a new person to the call, repeat step 2, and select **Options** > **Conference** > **Add to conference**. The phone supports conference calls between a maximum of six participants, including yourself.
4. To have a private conversation with one of the participants, select **Options** > **Conference** > **Private**. Select a participant and **Private**. The conference call is put on hold on your phone. The other participants can still continue the conference call. To return to the conference call, select **Options** > **Add to conference**.
5. To drop a participant, select **Options** > **Conference** > **Drop participant**, scroll to the participant, and select **Drop**.
6. To end the conference call, press the end key.

■ Answer or reject a call

To answer a call, press the call key.

To adjust the volume during the call, press the volume keys.

To mute the ringing tone, select **Silence**.



Tip: If a compatible headset is connected to the phone, press the headset key to answer and end a call.

To reject the call, press the end key, or select **Options** > **Reject**. The caller hears a busy tone. If you have activated the **Call divert** option **If busy** to divert calls, rejecting the call diverts the call.

To send a text message to the caller informing why you cannot answer the call, select **Options** > [Send text message](#). You can activate the text message reply and edit the text in the message. See [Reject call with SMS](#) and [Message text](#) in "Call," p. 76.

Call waiting (network service)

During a call, to answer the waiting call, press the call key. The first call is put on hold. To end the active call, press the end key.

To activate the [Call waiting](#) function, select **Menu** > [Settings](#) > [Phone sett.](#) > [Phone](#) > [Call](#) > [Call waiting](#) > [Activate](#).

To switch between the two calls, select **Swap**.

Options during a call

Many of the options that you can use during a call are network services. For availability, contact your service provider.

Select **Options** during a call for some of the following options:

[Transfer](#)—to connect a call on hold to an active call and disconnect yourself

[Replace](#)—to end an active call and replace it by answering the waiting call

[Send DTMF](#)—to send DTMF tone strings (for example, a password). Enter the DTMF string or search for it in [Contacts](#). To enter a wait character (w) or a pause character (p), press * repeatedly. To send the tone, select **OK**.





Tip: You can add DTMF tones to the [Phone number](#) or [DTMF](#) fields in a contact card.

■ Make a video call

When you make a video call, you can see a real-time, two-way video between you and the recipient of the call. The live video image or video image captured by the camera in your device is shown to the video call recipient.

To be able to make a video call, you may need to have a USIM card and be in the coverage of a UMTS network. For availability of and subscription to video call services, contact your service provider. A video call can only be made between two parties. The video call can be made to a compatible mobile phone or an ISDN client. Video calls cannot be made while there is another voice, video, or data call active.

 You are not receiving video (the recipient is not sending video or the network is not transmitting it).

 You have denied video sending from your device.

1. Enter the phone number in the standby mode; or select **Menu** > **Contacts**, and scroll to the desired contact.
2. Select **Options** > **Call** > **Video call**.

Starting a video call may take a while. *Waiting for video image* is shown. If the call is not successful (for example, video calls are not supported by the network, or the receiving device is not compatible), you are asked if you want to try a normal call or send a message instead.

The video call is active when you see two video images, and hear the sound through the loudspeaker. The call recipient may deny video sending () , in which case you hear the sound and may see a still image or a grey background graphic. During video calls while the phone is in phone mode, turn the lower part of the phone so that the camera lens is pointing toward you to let the call recipient to see your face, or turn the lower part to opposite direction to show the view away from you.

To increase or decrease the volume during a call, press the volume keys.

To change between showing video or only hearing sound, select *Enable* or *Disable* > *Sending video*, *Sending audio*, or *Sending aud. & video*.

To zoom your own image, select *Zoom in* or *Zoom out*. The zoom indicator is shown on the top of the display.

To switch the places of the sent and received video images on the display, select *Change image order*.

Even if you have denied video sending during a video call, the call will still be charged as a video call. Check the pricing with your network operator or service provider.

To end the video call, press the end key.

■ Answer a video call

When a video call arrives,  is displayed.

Press the call key to answer the video call. *Allow video image to be sent to caller?* is shown. If you select **Yes**, the image captured by the camera in your device is shown to the caller. If you select **No**, or do nothing, video sending is not activated, and a grey screen is shown in place of the video.

Even if you have denied video sending during a video call, the call is still charged as a video call. Check the pricing with your service provider.

To end the video call, press the end key.

■ Video sharing

Use *Video sharing* to send live video from your mobile device to another compatible mobile device during a voice call.

Video sharing requirements

Because *Video sharing* requires a 3G universal mobile telecommunications system (UMTS) connection, your ability to use *Video sharing* depends on 3G network availability. Contact your service provider for questions about network availability and fees associated with this application. To use *Video sharing* you must do the following:

- Ensure that your device is set up for person-to-person connections.
- Ensure you have an active UMTS connection and are within UMTS network coverage. If you start the sharing session while you are within UMTS network coverage and a handover to GSM occurs, the sharing session is discontinued, but your voice call continues.
- Ensure that both the sender and recipient are registered to the UMTS network. If you invite someone to a sharing session and that person's phone is turned off, or the person is not within UMTS network coverage, they do not know that you are sending an invitation. However, you receive an error message that the recipient cannot accept the invitation.

Settings

A person-to-person connection is also known as a session initiation protocol (SIP) connection. The SIP profile settings must be configured in your device before you can use *Video sharing*.

Ask your service provider for the SIP profile settings, and save them in your device. Your service provider may send you the settings over the air.

If you know a recipient's SIP address, you can enter it on your contact card for that person. Select **Menu** > *Contacts*, a contact, and **Options** > *Edit* > **Options** > *Add detail* > *SIP* or *Share view*. Enter the SIP address in the format

sip:username@domainname (you can use an IP address instead of a domain name).

Share live video

To receive a sharing session, the recipient must install *Video sharing* and configure the required settings on their mobile device. You and the recipient must both be registered to the service before you can start sharing.

To receive share invitations, you must be registered to the service, have an active UMTS connection, and be within the UMTS network coverage.

1. When a voice call is active, select **Options** > *Share video* > *Live video*.
2. The phone sends the invitation to the SIP address you have added to the contact card of the recipient.
If the recipient has several SIP addresses in the contact card, select the SIP address to which you want to send the invitation, and **Select** to send the invitation.
If the SIP address of the recipient is not available, enter a SIP address. Select **OK** to send the invitation.
3. Sharing begins automatically when the recipient accepts the invitation.
The loudspeaker is active. You can also use a headset to continue your voice call while you share live video.
4. Select **Pause** to pause the sharing session. Select **Continue** to resume sharing.
5. To end the sharing session, select **Stop**. To end the voice call, press the end key.

Accept an invitation

When someone sends you a share invitation, an invitation message is displayed showing the sender's name or SIP address. If your device is not set to *Silent*, it rings when you receive an invitation.

If someone sends you a share invitation and you are not within UMTS network coverage, you will not know that you received an invitation.

When you receive an invitation, select from the following:

Accept—to begin the sharing session and activate the view mode.

Reject—to decline the invitation. The sender receives a message that you rejected the invitation. You can also press the end key to decline the sharing session and disconnect the voice call.

To end the sharing session, select [Stop](#).

■ Log

In the log, you can monitor phone calls, text messages, packet data connections, and fax and data calls registered by the phone.

Connections to your remote mailbox, multimedia messaging center, or browser pages are shown as data calls or packet data connections in the general communications log.



Note: The actual invoice for calls and services from your service provider may vary, depending on network features, rounding off for billing, taxes, and so forth.



Note: Some timers, including the life timer, may be reset during service or software upgrades.

Recent calls

The phone registers the phone numbers of missed, received, and dialed calls, and the approximate duration of your calls. The phone registers missed and received calls only if the network supports these functions, and the phone is switched on and within the network service area.

To view recent calls (network service), select [Menu](#) > [Log](#) > [Recent calls](#) and a call type.

To clear all recent call lists in the [Recent calls](#) view, select [Options](#) > [Clear recent calls](#). To clear only one of the call registers, open the register you want to erase, and select [Options](#) > [Clear list](#).



General log

To view the general log, select [Menu](#) > [Log](#), and scroll right.

To filter the log, select [Options](#) > [Filter](#) and the filter type.

To erase all the log contents permanently, select [Options](#) > [Clear log](#) > [Yes](#).

4. Write text

When you write text,  appears on the top right of the display, indicating predictive text input, or  appears, indicating traditional text input. To set the

predictive text input on or off when writing text, press *, and select [Activate predictive text](#) or [Predictive text > Off](#).

Abc. abc, or **ABC** is displayed next to the text input indicator, indicating the character case. To change the character case, press #.

123 indicates the number mode. To change between letter and number mode, press # repeatedly until number mode is active; or press *, and select [Number mode](#) or [Alpha mode](#).

■ Traditional text input

Press a number key, 1 to 9, repeatedly until the desired character appears. Not all characters available under a number key are printed on the key. The availability of characters depends on the selected writing language. See [Writing language](#) in "Language," p. 72.

If the next letter you want is on the same key as the present one, wait until the cursor appears (or scroll forward to end the time-out period), and enter the letter.

To insert a number, press and hold the number key.

The most common punctuation marks and special characters are available under the 1 key. For more characters, press and hold *.

To erase a character, press the clear key. To erase more characters, press and hold the clear key.

To insert a space, press 0. To move the cursor to the next line, press 0 three times.

■ Predictive text input

To enter any letter with a single keypress, use predictive text input. To select the predictive text input, press *, and select [Activate predictive text](#). This activates predictive text input for all editors in the phone.

1. To write the desired word, press the keys 2–9. Press each key only once for one letter. The word changes after every keypress.

For the most common punctuation marks, press 1. For more punctuation marks and special characters, press and hold *.

To erase a character, press the clear key. To erase more characters, press and hold the clear key.

2. When you have finished the word and it is correct, to confirm it, scroll forward or insert a space.

If the word is not correct, to view the matching words the dictionary has found one by one, press * repeatedly.

If the ? character is shown after the word, the word you intended to write is not in the dictionary. To add a word to the dictionary, select **Spell**. Enter the word (up to 32 letters) using traditional text input, and select **OK**. The word is added to the dictionary. When the dictionary becomes full, a new word replaces the oldest added word.

Write compound words

Write the first half of a compound word, and scroll forward to confirm it. Write the last part of the compound word, and to complete the compound word, press **O** to add a space.

■ Copy and delete text

1. To select letters and words, press and hold **#**, and at the same time scroll left or right. As the selection moves, text is highlighted. To select lines of text, press and hold **#**, and at the same time scroll up or down.
2. To copy the text to the clipboard, press and hold **#**, and at the same time select **Copy**.
If you want to delete the selected text from the document, press the clear key.
3. To insert the text, scroll to the insertion point, press and hold **#**, and at the same time select **Paste**.

5. Messaging

You can create, send, receive, view, edit, and organize text messages, multimedia messages, e-mail messages, presentations, and documents. You can also receive messages and data using Bluetooth wireless technology, receive and forward picture messages, receive service messages and cell broadcast messages, and send service commands.

To open the **Messaging** menu, select **Menu > Messaging**. You can see the **New message** function and a list of default folders:

 **Inbox**—contains received messages except e-mail and cell broadcast messages. E-mail messages are saved in the **Mailbox** folder. To read cell broadcast messages, select **Options > Cell broadcast**.

 **My folders**—for organizing your messages into folders

 **Mailbox**—for connecting to your remote mailbox to retrieve your new e-mail messages or viewing your previously retrieved e-mail messages offline. After you define settings for a new mailbox, the name given to that mailbox is displayed instead of **Mailbox**.

 **Drafts**—saves draft messages that have not been sent.

 **Sent**—saves the messages that are sent, excluding messages sent using Bluetooth.

 **Outbox**—temporarily saves the messages waiting to be sent.

 **Reports** (network service)—saves the delivery reports of the text messages, special message types such as business cards, and multimedia messages you have sent. Receiving a delivery report of a multimedia message that has been sent to an e-mail address may not be possible.

■ Write and send messages

Your device supports the sending of text messages beyond the character limit for a single message. Longer messages are sent as a series of two or more messages. Your service provider may charge accordingly. Characters that use accents or other marks, and characters from some language options, take up more space, limiting the number of characters that can be sent in a single message.

The wireless network may limit the size of MMS messages. If the inserted picture exceeds this limit, the device may make it smaller so that it can be sent by MMS.

Only devices that have compatible features can receive and display multimedia messages. The appearance of a message may vary depending on the receiving device.

Before you can send and receive an SMS message, a multimedia message, or an e-mail, or connect to your remote mailbox, you must have the correct connection settings in place. See "Messaging settings," p. 36.

1. To create a message, select **Menu > Messaging > New message** and the message type.

To create an **Audio message**, see "Nokia Xpress audio messaging," p. 32.

2. Press the scroll key to select the recipients or groups from [Contacts](#) or enter the phone number or e-mail address of the recipient in the *To* field. Separate recipients with a semicolon (;).
3. When creating an e-mail or multimedia message, scroll down to the subject field, and write the message subject.
4. Scroll down to the message field, and write the message.

When you write text messages, the message length indicator shows how many characters you can enter in the message. For example, 10 (2) means that you can still add 10 characters for the text to be sent as two separate text messages.

To use a template for the text message, select [Options](#) > [Insert](#) > [Template](#). To create a presentation based on a template to be sent as a multimedia message, select [Options](#) > [Create presentation](#). To use a text template for the multimedia message, select [Options](#) > [Insert object](#) > [Template](#).

To add a media object to a multimedia message, select [Options](#) > [Insert object](#) > [Image](#), [Sound clip](#), or [Video clip](#). To create and add a new media object, select [Options](#) > [Insert new](#) > [Image](#), [Sound clip](#), [Video clip](#) or [Slide](#). When sound is added,  is shown.

To add a media object to an e-mail, select [Options](#) > [Insert](#) > [Image](#), [Sound clip](#), [Video clip](#), [Note](#) or [Template](#).

5. To send the message, select [Options](#) > [Send](#).

Nokia Xpress audio messaging

Audio messages are multimedia messages that consist of a single sound clip. To create and send an audio message:

1. Select [Menu](#) > [Messaging](#) > [New message](#) > [Audio message](#).
2. In the *To* field, press the scroll key to choose the recipients from [Contacts](#), or enter the phone number or e-mail address. Scroll down to the message field.
3. To record a new sound clip, press the scroll key, or select [Options](#) > [Insert sound clip](#) > [New sound clip](#). The recording starts.
To use a previously recorded sound clip, select [Options](#) > [Insert sound clip](#) > [From Gallery](#), scroll to the sound clip, and select it. The sound clip has to be in .amr format.
To play the sound clip on the loudspeaker, select [Options](#) > [Play sound clip](#).

4. To send the message, select **Options** > **Send**.

E-mail settings

Before you use e-mail, you must do the following:

- Configure an internet access point (IAP) correctly. See "Connection," p. 78.
- Define your e-mail settings correctly. See "E-mail settings," p. 33.

Follow the instructions given by your e-mail service provider and internet service provider.

Inbox—receive messages

Select **Menu** > **Messaging** > **Inbox**.

When there are unread messages in the inbox, the icon changes to .

To open a received message, select **Menu** > **Messaging** > **Inbox** and the desired message.



Important: Exercise caution when opening messages. Multimedia message objects may contain malicious software or otherwise be harmful to your device or PC.

View multimedia objects

To view the list of media objects that are included in the multimedia message, open the message, and select **Options** > **Objects**. You can save the file in your phone or send it using Bluetooth technology or as a multimedia message to another compatible device.

Special message types

Your phone can receive many kinds of messages, such as operator logos, business cards, calendar entries, and ringing tones.

To open a received message, select **Menu** > **Messaging** > **Inbox** and the desired message. You can save the special message content to your phone. For example, to save a received calendar entry to the calendar, select **Options** > **Save to Calendar**.



Note: The picture message function can be used only if it is supported by your service provider. Only compatible devices that offer picture message features can receive and display picture messages. The appearance of a message may vary depending on the receiving device.

Service messages

Service messages (network service) are notifications (for example, news headlines) that may contain a text message or the address of a browser service. For availability and subscription, contact your service provider.

■ My folders

You can organize your messages into folders, create new folders, and rename and delete folders.

Select **Menu** > **Messaging** > **My folders**. To create a folder, select **Options** > **New folder**, and enter a name for the folder.

■ Mailbox

Select **Menu** > **Messaging** > **Mailbox**.

When you open **Mailbox**, **Connect to mailbox?** is displayed. Select **Yes** to connect to your mailbox (network service) or **No** to view previously retrieved e-mail messages offline.

To connect to the mailbox afterwards, select **Options** > **Connect**.

When you create a new mailbox, the name you give to the mailbox replaces **Mailbox**. You can have up to six mailboxes.

When you are online, to end the data connection to the remote mailbox, select **Options** > **Disconnect**.

Retrieve e-mail messages from the mailbox



Important: Exercise caution when opening messages. E-mail messages may contain malicious software or otherwise be harmful to your device or PC.

1. Select **Menu** > **Messaging** > **Mailbox** > **Options** > **Connect**.
2. Select **Options** > **Retrieve e-mail** and from the following options:
 - New**—to retrieve all new e-mail messages to your phone
 - Selected**—to retrieve only the e-mail messages that have been marked
 - All**—to retrieve all messages from the mailbox
3. After you retrieve the e-mail messages, you can continue viewing them online. Select **Options** > **Disconnect** to close the connection and to view the retrieved e-mail messages and headings offline.

4. To open an e-mail message, select it. If the e-mail message has not been retrieved and you are offline and select *Open*, you are asked if you want to retrieve this message from the mailbox.

To view e-mail attachments, indicated with , select *Options > Attachments*. You can retrieve, open, or save attachments in supported formats.

Delete e-mail messages

To delete an e-mail message from the phone and retain it in the remote mailbox, select *Menu > Messaging > Mailbox > Options > Delete > Phone only*. The e-mail heading stays in your phone. To remove the heading as well, delete the e-mail message from your remote mailbox first, then connect your phone to the remote mailbox to update the status.

To delete an e-mail from the phone and the remote mailbox, select *Options > Delete > Phone and server*.

To cancel deletion of an e-mail from both the phone and server, scroll to an e-mail that has been marked to be deleted during the next connection, and select *Options > Restore*.

■ Outbox

The outbox folder is a temporary storage place for messages that are waiting to be sent.

To access the outbox folder, select *Menu > Messaging > Outbox*. Message statuses:

Sending—The phone is sending the message.

Waiting or *Queued*—The phone is waiting to send messages or e-mail.

Resend at ... (time)—Sending failed. The phone tries to send the message again after a time-out period. To retry sending the message immediately, select *Options > Send*.

Deferred—To put documents to be on hold while they are in the outbox folder, scroll to a message that is being sent, and select *Options > Defer sending*.

Failed—The maximum number of sending attempts has been reached.

■ View messages on the SIM card

Before you can view SIM messages, you need to copy them to a folder in your phone.

1. Select **Menu** > *Messaging* > **Options** > *SIM messages*.
2. Mark the messages you want to copy.
3. To copy the marked messages, select **Options** > *Copy*, and the folder to which you want to copy the messages.

■ Cell broadcast

You may be able to receive messages, such as weather or traffic conditions from your service provider (network service). To turn on the service, see *Cell broadcast* in "Cell broadcast settings," p. 39.

Select **Menu** > *Messaging* > **Options** > *Cell broadcast*.

A packet data connection may prevent cell broadcast reception.

■ Service command editor

To enter and send service commands (also known as USSD commands) such as activation commands for network services to your service provider, select **Menu** > *Messaging* > **Options** > *Service command*. To send the command, select **Options** > *Send*.

■ Messaging settings

Text message settings

Select **Menu** > *Messaging* > **Options** > *Settings* > *Text message* and from the following options:

Message centres—lists all the defined message centers

Message centre in use—defines which message center is used for delivering text messages and special message types such as business cards

Character encoding > *Full support*—to select all characters in the message to be sent as viewed. If you select *Reduced support*, characters with accents and other marks may be converted to other characters.

Receive report (network service)—When set to *Yes*, the status of the sent message (*Pending*, *Failed*, *Delivered*) is shown in *Reports*.

Message validity—If the recipient of a message cannot be reached within the validity period, the message is removed from the message service center. Note that the network must support this feature.

Message sent as—to define how the message is sent. Default is *Text*.

Preferred connection—You can send text messages using the normal GSM network or, if supported by the network, packet data.

Reply via same centre (network service)—If you select *Yes*, and the recipient replies to your message, the return message is sent using the same message service center number. Some networks do not provide this option.

Multimedia messaging settings

Select **Menu** > **Messaging** > **Options** > **Settings** > **Multimedia message** and from the following options:

Image size—Define the size of the image in a multimedia message. If you select *Original*, the image is not scaled.

MMS creation mode—If you select *Guided*, the phone informs you if you try to send a message that may not be supported by the recipient. To set the phone to prevent you from sending messages that are not supported, select *Restricted*. If you select *Free*, message creation is not restricted, but the recipient may not be able to view your message.

Access point in use—Select which access point is used as the preferred connection for multimedia messaging.

Multimedia retrieval—To receive multimedia messages only when you are in your home network, select *Auto in home netw.*. To always receive multimedia messages, select *Always automatic*. To retrieve messages manually, select *Manual*. To not receive any multimedia messages or advertisements, select *Off*.

Allow anon. msgs.—To reject messages coming from an anonymous sender, select *No*.

Receive adverts—Define whether you want to allow reception of multimedia message advertisements.

Receive report—If you want the status of the sent message (*Pending*, *Failed*, or *Delivered*) to be shown in *Reports*, select *Yes*. Receiving a delivery report of a multimedia message that has been sent to an e-mail address may not be possible.

Deny report sending > *Yes*—to deny sending delivery reports

Message validity (network service)—If the recipient of a message cannot be reached within the validity period, the message is removed from the multimedia message center.

E-mail settings

Settings for mailboxes

Select [Menu](#) > [Messaging](#) > [Options](#) > [Settings](#) > [E-mail](#) > [Mailboxes](#) and a mailbox.

If no mailbox settings have been defined before, you are asked if you want to define the settings.

[Connection settings](#) > [Incoming e-mail](#) and [Outgoing e-mail](#)—To define the correct settings, contact your e-mail service provider.

User settings

Select [User settings](#) and from the following settings:

My name—Enter the name to be displayed in outgoing e-mail.

Send message (network service)—To set when your e-mail messages are sent, select *Immediately* or *During next conn.*

Send copy to self—Select *Yes* to send a copy of the e-mail to the address defined in *My e-mail address*.

Include signature—Select *Yes* to attach a signature to your e-mail messages and to create or edit a signature text.

New e-mail alerts—To not receive alerts about new e-mail, select *Off*.

Retrieval settings

Select [Retrieval settings](#) and from the following settings:

E-mail to retrieve—To only retrieve headers, select *Headers only*. To limit how much data is retrieved, select *Size limit*, and enter the maximum amount of data per message in kilobytes. To retrieve messages and attachments, select *Msgs. & attaches.* The *Size limit* and *Msgs. & attaches.* options are only available with POP3 mailboxes.

Retrieval amount—To limit the number of messages to retrieve from the inbox of the remote mailbox, select [From Inbox](#) > *No. of e-mails* and enter the maximum number of messages to retrieve. You can also limit the number of messages to retrieve from other subscribed folders in [From folders](#) (only IMAP4 mailboxes).

IMAP4 folder path (only IMAP4 mailboxes)—Define the folder path for IMAP4 mailboxes.

Folder subscriptions (only IMAP4 mailboxes)—Select the mailbox folders you want to subscribe to. To subscribe to or unsubscribe from a folder, scroll to it, and select **Options** > *Subscribe* or *Cancel subscription*.

Automatic retrieval

Select *Automatic retrieval* and from the following settings:

E-mail notifications—To automatically retrieve the headers to your device when you receive a notification of new e-mail in your remote mailbox, select *Auto-update* or *Only in home netw.*

E-mail retrieval—To have e-mail headers automatically retrieved at set intervals, select *Enabled*, or if you only want headers to be retrieved in your home network, select *Only in home netw.* Headers can be automatically retrieved for two mailboxes at most. You can set on which days, at what times, and how frequently the headers are retrieved in *Retrieval days*, *Retrieval hours*, and *Retrieval interval*.

E-mail notifications and *E-mail retrieval* cannot be active at the same time.

Service message settings

Select **Menu** > *Messaging* > **Options** > *Settings* > *Service message* and from the following settings:

Service messages—Allow or deny the reception of service messages.

Download messages—Download messages automatically or manually.

Cell broadcast settings

Check with your service provider whether cell broadcast (network service) is available and what the available topics and related topic numbers are.

Select **Menu** > *Messaging* > **Options** > *Settings* > *Cell broadcast* and from the following settings:

Reception—Select *On* or *Off*.

Language—Select in which languages cell broadcast messages are received.

Topic detection—To automatically save previously unknown topic numbers in received cell broadcast messages, select *On*.

Other settings

Select **Menu** > **Messaging** > **Options** > **Settings** > **Other** and from the following settings:

Save sent messages—Select to save a copy of every sent text message, multimedia message, or e-mail to the **Sent** folder.

Number of saved msgs.—Define how many sent messages are saved to the sent items folder at a time. When the limit is reached, the oldest message is deleted.

Memory in use—Select whether to save messages to the phone memory or memory card.

■ **Message reader**

With **Msg. reader**, you can listen to received text, multimedia, and e-mail messages.

To listen to a message in **Inbox** or **Mailbox**, scroll to the message or mark the messages, and select **Options** > **Listen**. To skip to the next message, scroll down.



Tip: When **1 new message** or **New e-mail** is displayed in the standby mode, to listen to the received messages, press and hold the left selection key until **Msg. reader** starts.

6. **Contacts**

You can save and manage contact information, such as names, phone numbers, and addresses.

■ **Manage contacts**

Select **Menu** > **Contacts**.

To add a new contact, select **Options** > **New contact**. Fill in the fields you want, and select **Done**.

To edit a contact, scroll to it, and select **Options** > **Edit**.

To assign default numbers and addresses to a contact, select it, and select **Options** > **Defaults**. Scroll to the desired default option, and select **Assign**.

To copy names and numbers from a SIM card to your phone, select **Options** > **SIM contacts** > **SIM directory**. Scroll to the name you want to copy or mark the desired names, and select **Options** > **Copy to Contacts**.

To copy a phone, fax, or pager number from contacts to your SIM card, scroll to the contact you want to copy, and select **Options** > **Copy** > **To SIM directory**.

To view the list of fixed dialing numbers, select **Options** > **SIM contacts** > **Fixed dialling**. This setting is only shown if supported by your SIM card.

■ Manage contact groups

Create a contact group so that you can send text or e-mail messages to several recipients at the same time.

1. Select **Menu** > **Contacts**.
2. Scroll to the right, and select **Options** > **New group**.
3. Enter a name for the group, and select the group.
4. Select **Options** > **Add members**.
5. Mark the contacts you want to add to the group, and select **OK**.

■ Add a ringing tone

You can set a ringing tone (also a video ringing tone) for each contact and group.

1. Select **Menu** > **Contacts**.
2. To add a ringing tone to a contact, select the contact, **Options** > **Ringling tone**, and the desired ringing tone.

To add a ringing tone to a group, scroll right to the groups list, and scroll to a contact group. Select **Options** > **Ringling tone** and the ringing tone for the group.

To remove the personal or group ringing tone, select **Default tone** as a ringing tone.

■ Assign speed dialing keys

- Speed dialing is a quick way to call frequently used numbers. You can assign a phone number to the speed dialing keys, 2 to 9. The 1 key is reserved for the call mailbox. Speed dialing has to be activated before using speed dialing. To activate the speed dialing, select **Menu** > **Settings** > **Phone sett.** > **Phone** > **Call** > **Speed dialling** > **On**.

1. Select **Menu** > **Contacts** and a contact.
 2. Scroll to a number, and select **Options** > **Assign speed dial**. Scroll to the desired speed dialing key, and select **Assign**. When you return to the contact information view,  next to the number indicates the assigned speed dial.
- To call the contact by speed dialing, in the standby mode, press the speed dialing key and the call key, or press and hold the speed dialing key.

7. Gallery

Use **Gallery** to save and organize your images, videos, music tracks, sound clips, playlists, streaming links, .ram files, and presentations.

Select **Menu** > **Gallery**. To open a folder (such as **Images**), select it.

To open a file, select it. The file opens in its corresponding application.

The videos you download or transfer to your phone are saved in **Videos**. To access **Videos** in the standby mode, select **Videos**, or select **Menu** > **Gallery** > **Videos**, or select **Menu** > **Media** > **Videos**.

You can transfer videos to your phone from a compatible PC, and download video clips from compatible internet video services to your phone using packet data.

■ Gallery functions

To set an image as a wallpaper, select **Images**, and scroll to the image. Select **Options** > **Use image** > **Set as wallpaper**. To assign the image to a contact, select **Assign to contact**.

To set a video as a video ringing tone, select **Videos**, and scroll to the video. Select **Options** > **Use video** > **Set as ringing tone**. To assign the video for a contact, select **Assign to contact**.

To copy files to phone memory or to the memory card, scroll to the file or mark the files, and select **Options** > **Organise** > **Copy to phone mem.** or **Copy to memory card**.

To create image or video folders and move files to them, select **Images** or **Videos**, and scroll to a file. Select **Options** > **Organise** > **New folder** and the memory, and enter a name for the folder. Mark the files you want to move to the folder, and select **Options** > **Organise** > **Move to folder** and the folder.

View videos and images

When you are viewing videos or still images in the phone mode, you can activate the video view mode. Turn the lower part of the phone 90 degrees to the left so that the camera lens is pointing away from you. In video view mode the display automatically changes to landscape, and you can put the phone on the table, for example, while viewing.

To view the next or previous still images, press the fast forward or rewind media key.

To fast forward or rewind the video, press the fast forward or rewind media key. To play or pause the video, press the play/pause/stop media key. To stop the video, press and hold the play/pause/stop media key.

Edit images

To edit images in **Gallery**, scroll to the image, and select **Options > Edit**.

To crop an image, select **Options > Apply effect > Crop**. To crop the image size manually, select **Manual** or a predefined aspect ratio from the list. If you select **Manual**, a cross appears in the upper left corner of the image. Scroll to select the area to crop, and select **Set**. Another cross appears in the lower right corner. Again select the area to be cropped. To adjust the first selected area, select **Back**. The selected areas form a rectangle, which forms the cropped image.

If you selected a predefined aspect ratio, select the upper left corner of the area to be cropped. To resize the highlighted area, use the scroll key. To freeze the selected area, press the scroll key. To move the area within the picture, use the scroll key. To select the area to be cropped, press the scroll key.

To reduce redness of the eyes in an image, select **Options > Apply effect > Red eye reduction**. Move the cross onto the eye, and press the scroll key. A loop appears on the display. To resize the loop to fit the size of the eye, scroll up, down, left, or right. To reduce the redness, press the scroll key.

Shortcuts in the image editor:

- To view an image in the full screen, press *. To return to the normal view, press * again.
- To rotate an image clockwise or counterclockwise, press 3 or 1.
- To zoom in or out, press 5 or 0.
- To move on a zoomed image, scroll up, down, left, or right.

Edit videos

To edit videos in *Gallery* and create custom video clips, scroll to a video clip, and select **Options** > *Video editor* > **Options** > *Edit video clip*.

In the video editor you can see two timelines: video clip timeline and sound clip timeline. The images, text, and transitions added to a video are shown on the video clip timeline. To switch between the timelines, scroll up or down.

Modify video

To modify the video, select from the following *Edit video clip* options:

Cut—Trims the video clip in the cut video clip view.

Add colour effect—Inserts a color effect on the video clip.

Use slow motion—Slows the speed of the video clip.

Mute sound or *Unmute sound*—Mutes or unmutes the original video clip sound.

Move—Moves the video clip to the selected location.

Adjust volume—Adjusts the volume level.

Remove—Removes the video clip from the video.

Duplicate—Makes a copy of the selected video clip.

Edit text (shown only if you added text)—To move, remove, or duplicate text; change the color and style of the text; define how long it stays on the screen; and add effects to the text.

Edit image (shown only if you added an image)—To move, remove, or duplicate an image; define how long it stays on the screen; and set a background or a color effect to the image.

Edit sound clip (shown only if you have added a sound clip)—To cut or move the sound clip, to adjust its length, or to remove or duplicate the clip.

Edit transition—There are three types of transitions: at the start of a video, at the end of a video, and transitions between video clips. You can select start transition when the first transition of the video is active.

Insert—Select *Video clip*, *Image*, *Text*, *Sound clip*, or *New sound clip*.

Movie—Preview the movie in the full screen or as a thumbnail, save or send the movie, or cut the movie to a proper size for sending it in a multimedia message.

To take a snapshot of a video clip, in the cut video view, select **Options** > *Take snapshot*. In the thumbnail preview view, press the scroll key, and select *Take snapshot*.

To save your video, select [Options](#) > [Movie](#) > [Save](#). To define the [Memory in use](#), select [Options](#) > [Settings](#).

To send the video, select [Send](#) > [Via multimedia](#), [Via e-mail](#), [Via Bluetooth](#), or [Via infrared](#). Contact your service provider for details of the maximum multimedia message size that you can send. If your video is too large to send in a multimedia message,  appears.

Transfer videos from PC

To transfer videos from a compatible PC, use a compatible USB cable or Bluetooth connectivity.

The requirements of the PC for video transfer:

- Microsoft Windows XP operating system (or later)
- Nokia PC Suite 6.82 or later
- Nokia Video Manager application (a add-on application to PC Suite)

To transfer videos use Nokia Video Manager, connect the compatible USB cable or activate Bluetooth connection, and select [PC Suite](#) as the connection mode.

To change the default USB connection mode, select [Menu](#) > [Settings](#) > [Connectivity](#) > [USB](#) > [USB mode](#).

Nokia Video Manager is optimized for transcoding and transferring video files. For information about transferring video with Nokia Video Manager, see the Nokia Video Manager help.

Download files

Select [Menu](#) > [Gallery](#), the folder for the file type you want to download, and the download function (for example, [Images](#) > [Downl. graphics](#)). The browser opens. Choose a bookmark for the site to download from.

8. Music player



Warning: Listen to music at a moderate level. Continuous exposure to high volume may damage your hearing. Do not hold the device near your ear when the loudspeaker is in use, because the volume may be extremely loud.

To activate music mode and start [Music player](#), turn the lower part of the phone to the right so that the playback control keys are on the same side as the display.

You can listen to music also when the [Offline](#) profile is activated. See "Offline profile," p. 17.

To add songs to your device, see "Transfer music," p. 48.

For more information about copyright protection, see "Activation keys," p. 98.

■ Listen to music

1. Activate the music mode.
2. In [Music menu](#), select the category, such as [All songs](#) or [Albums](#).
3. Select the music you want to play.



Use the media keys to control playback.

- Press the play/pause/stop key to play or pause a song. Press and hold the key to stop the playback.
- Press the rewind key to rewind the song or to skip backwards.
- Press the fast forward key to fast forward the song or to skip forward.

You can also use the scroll key to control the player.

To adjust the volume, use the volume key.

To switch random play () on or off, select [Options](#) > [Shuffle](#).

To repeat the current song () , all songs () , or to switch repeat off, select [Options](#) > [Repeat](#).

To modify the tone of the music playback, select [Options](#) > [Equaliser](#).

To modify the balance loudness or stereo widening, select [Options](#) > [Audio settings](#).

To view a visualization during playback, select [Options](#) > [Start visualisation](#).

To return to the standby mode and leave the player in the background, press the end key. If [Active standby](#) is [On](#), the currently playing song is displayed in the standby mode. To access the music player from the standby mode, select the currently playing song. To switch to another open application, press and hold [Menu](#).

■ Music menu

To select more music to play in [Now playing](#) view, select [Options](#) > [Go to Music menu](#). To return to the [Now playing](#) view, select [Options](#) > [Go to Now playing](#).

The music menu shows the music available in the phone and compatible memory card (if inserted). *All songs* lists all music. To view sorted songs, select *Albums*, *Artists*, *Genres*, or *Composers*. To view playlists, select *Playlists*.

To refresh the library after you have updated the song selection in your phone, select *Options* > *Refresh Music library*.

■ Playlists

To view and manage playlists, in the music menu, select *Playlists*. The following playlists appear automatically: *Most played tracks*, *Recently played songs*, and *Recent additions*.

To view details of the playlist, select *Options* > *Playlist details*.

Create a playlist

1. Select *Options* > *Create playlist*.
2. Enter a name for the playlist, and select **OK**.
3. Select artists to find the songs you want to include in the playlist. Press the scroll key to add items. To show the song list under an artist title, scroll right. To hide the song list, scroll left.
4. When you have made your selections, select **Done**. If a compatible memory card is inserted, the playlist is saved to the memory card.

To add more songs later, when viewing the playlist, select *Options* > *Add songs*.

To add songs, albums, artists, genres, and composers to a playlist from the different views of the music menu, select an item and *Options* > *Add to a playlist* > *Saved playlist* or *New playlist*.

To remove a song from a playlist, select *Options* > *Remove from playlist*. This deletion does not delete the song from the phone ; it only removes it from the playlist.

To reorder songs in a playlist, scroll to the song you want to move, and select *Options* > *Reorder list* > **Grab**, scroll to a new position, and select **Drop**.

■ Music shop

In the music shop (network service) you can search, browse, and purchase music for downloading to your phone. The variety and appearance of music shop services may vary. For more information and availability of music shop, contact your service provider.

You must have music shop settings and valid internet connections in order to use this service. For more details, see "Music shop settings," p. 48, and "Access points," p. 78.

To go to music shop, in the *Music player*, select **Options** > *Go to Music shop*

Music shop settings

The availability and appearance of the music shop settings may vary. The settings may also be predefined, and you cannot edit them.

In the music shop, you may be able to edit the settings by selecting **Options** > *Settings*.

If the settings are not predefined, you may be asked to enter the following settings:

Address—You must define the web address of the music shop service.

Default acc. pt.—Select the access point to use when connecting to the music shop.

User name—Enter your user name for the music shop.

Password—Enter your password for the music shop.

If *User name* and *Password* fields are left empty, you may have to enter them at login.

■ Transfer music

You can buy music protected with WMDRM from online music shops, and transfer the music to your phone.

To transfer music from a compatible PC or other compatible devices, use a compatible USB cable or Bluetooth connectivity. You can also IR connection. For details, see "Bluetooth connection," p. 84, or "Infrared," p. 92. You cannot transfer WMDRM protected music files using Bluetooth or IR connection.

To refresh the library after you have updated the song selection in your phone, in the *Music menu*, select **Options** > *Refresh Music library*

The requirements of the PC for music purchase and transfer:

- Microsoft Windows XP operating system (or later)
- Compatible version of Windows Media Player application
- Nokia PC Suite 6.82 or later

Transfer music from PC

You can use three different methods to transfer music:

- To view your phone on a PC as an external hard drive where you can transfer any data files, make the connection with a compatible USB cable or Bluetooth connectivity.

If you are using the USB cable, select *Data transfer* as the connection mode. A compatible memory card needs to be inserted in the phone. You cannot transfer WMDRM protected music files using *Data transfer*.

- To synchronize music with Windows Media Player, connect the compatible USB cable and select *Media player* as the connection mode. A compatible memory card needs to be inserted in the phone.

To use Nokia Music Manager in Nokia PC Suite, connect the compatible USB cable or activate Bluetooth connection, and select *PC Suite* as the connection mode. You cannot transfer WMDRM protected music files using *PC Suite*.

To change the default USB connection mode, select *Menu > Settings > Connectivity > USB > USB mode*.

Both Windows Media Player and Nokia Music Manager in Nokia PC Suite have been optimized for transferring music files. For information about transferring music with Nokia Music Manager, see the Nokia PC Suite user guide.

Music transfer with Windows Media Player

The functionality of the music synchronization may vary between different versions of the Windows Media Player application. For more information, see the corresponding Windows Media Player guides and helps.

9. Media

■ Visual Radio

You can use the Visual Radio application as an FM radio with automatic tuning and preset stations or with parallel visual information related to the radio program if you tune in to stations that offer Visual Radio service. The Visual Radio service uses packet data (network service).

To use the Visual Radio service, the following requirements must be met:

- The radio station and your service provider must support this service.
- Your internet access point must be defined for access to the network operator's Visual Radio server.
- The radio station must have the correct Visual Radio service ID defined and have Visual Radio service enabled.

Visual Radio cannot be started when the phone is in the offline mode.

The FM radio depends on an antenna other than the wireless device antenna. A compatible headset or enhancement needs to be attached to the device for the FM radio to function properly.





Warning: Listen to music at a moderate level. Continuous exposure to high volume may damage your hearing. Do not hold the device near your ear when the loudspeaker is in use, because the volume may be extremely loud.

You can make a call or answer an incoming call while listening to the radio. The radio is turned off when there is an active call.

To open Visual Radio, select [Menu](#) > [Media](#) > [Radio](#).



To turn the radio off, select [Exit](#).

Tune and save a radio station

To start the station search when the radio is on, select  or . Searching stops when a station is found. To save the station, select [Options](#) > [Save station](#). Select a location for the station. Enter the name of the station, and select [OK](#).

Radio functions

To adjust the volume, press the volume keys.

Select  or  to scroll to the next or previous saved station. The buttons are inactive if there are no saved stations.

When using a compatible headset, press the headset key to scroll to the next saved radio station.

To save the current station, select [Options](#) > [Save station](#), a preset position, and enter the station name.

To set the station frequency manually, select [Options](#) > [Manual tuning](#).

To listen to the radio in the background and go to the standby mode, select [Options](#) > [Play in background](#).

Station list

When the radio is on, select **Options** > **Stations**. The station list is used for managing the saved radio stations.

Station setup

Scroll to a station in the station list, press the scroll key, and select **Edit** to change the station parameters.

View visual content

To check availability and costs, and to subscribe to the service, contact your service provider.

To view visual content of the current station, select .

If the visual service ID was not saved in the station list, you are asked for the visual service ID. Enter the visual service ID, and select **OK**. If you do not have the visual service ID, select **Retrieve** to access the station directory (network service).

To end the visual content feed but not the FM radio, select **Close**.

To set light settings and the power saver time-out, select **Options** > **Display settings**.

Visual Radio settings

When the radio is on, select **Options** > **Settings** and the following:

Start-up tone—to enable or disable the start-up tone

Auto-start service—to enable or disable the automatic display of visual content

Access point—to select the access point

Station directory

With the station directory (network service) you can select Visual Radio enabled or traditional radio stations from a list, grouped in folders.

To check availability and costs, and to subscribe to the service, contact your service provider.

Access from the visual content view

To retrieve the visual service ID and to start visual content for the currently tuned radio station, select  and **Retrieve**. After the connection to the station

directory is established, select the nearest location to your current position from a list of folders, and press the scroll key.

The device compares the frequencies of the listed radio stations with the currently tuned in frequency. If a matching frequency is found, the visual service ID of the tuned radio station is displayed. Select **OK** to start viewing the visual content.

If there is more than one radio station with matching frequencies, the radio stations and their visual service ID are displayed in a list.

Select the desired radio station. The tuned radio station and the visual service ID are displayed. Select **OK** to start viewing the visual content.

Access from options

To access the station directory (network service) from the station list, select **Options** > *Station directory*.

After the connection to the station directory, select the nearest location to your current position from a list of locations.

Radio stations that provide visual content are indicated with .

Select the desired radio station and from the following options:

Listen—to tune to the highlighted radio station. To confirm the frequency setting, select **Yes**.

Start visual service—to open the visual content of the selected radio station (if available)

Save—to save the details of the selected radio station to the station list

Details—to view channel information

■ Camera

To activate the camera mode while in the phone mode, turn the lower part of the phone 90 degrees to the left so that the camera lens is pointing away from you when you look at the display. To take a self portrait, turn the lower part of the phone 90 degrees to the right so that the camera lens is pointing toward you when you look at the display.  ► on the upper left of the display indicates the still image mode.

To capture an image, press the capture key. You can also capture an image by pressing the scroll key. The image is saved to *Images* in *Gallery*, and the image is displayed. To return to the viewfinder, select **Back**. To delete the image, press the clear key.

To zoom in or out, press the fast forward or rewind media key.

To capture images sequentially, select **Options** > *Sequence mode* > *On*, or press 4. When you press the scroll key, the camera captures six images in short intervals and displays the images in a grid.

To turn the flash on, select **Options** > *Flash* > *On*. If you select *Automatic*, flash is used automatically when necessary.

Keep a safe distance when using the flash. Do not use the flash on people or animals at close range. Do not cover the flash while taking a picture.

In dim lighting, to use night mode, select **Options** > *Night mode* > *On*, or press 1.

To use the self-timer, select **Options** > *Self-timer* and the time you want the camera to wait before capturing the image. Press the scroll key, and the timer starts.

To adjust the white balance or color tone, select **Options** > *Adjust* > *White balance* or *Colour tone*.

To record a video, select **Options** > *Video mode*, or scroll right. ◀  on the upper left of the display indicates the video mode. To start the recording, press the capture key or the scroll key. To pause the recording, press the capture key. To stop the recording, press and hold the capture key.

To use the panorama mode, select **Options** > *Panorama mode*, or scroll right.

◀  on the upper left of the display indicates the panorama mode. Press the capture key to start capturing a panorama image. The panorama preview is shown on the display. Turn slowly to the right or left. You cannot change the direction. You turn too fast if the arrow on the display is red. To stop the panorama, press the capture key again.

Camera settings

Your device supports an image capture resolution of 1600 x 1200 pixels.

You can change camera settings for still images. In the camera mode, select **Options** > *Settings* > *Image* and from the following settings:

Image quality and *Image resolution*—The better the image quality and the higher the resolution, the more memory the image consumes.

Show captured image—To not display the image after capturing, select *No*.

Default image name—Change how the captured images are named.

Memory in use—Select whether you want to save your images in the phone memory or on the memory card.

You can change camera settings for videos. In the camera mode, select [Options](#) > [Settings](#) > [Video](#) and from the following settings:

Length—If set to *Maximum*, the length of the recorded video is only restricted by the available memory. If set to *Short*, the recording time is optimized for MMS sending.

Video resolution—Select between two video resolutions.

Default video name—Select how the video clips are named.

Memory in use—Select whether you want to save your video clips in the phone memory or on the memory card.

■ **Movie director**

A muvee is a short, edited video clip that can contain video, images, music, and text. Quick muvee is created automatically by *Movie director* after you select the style for the muvee. *Movie director* uses the default music and text associated with the chosen style. In a custom muvee you can select your own video and music clips, images and style, and add an opening and closing message. You can send muvees with MMS.

A muvee can be saved in *Gallery* in .3gp file format.

To create muvees, select [Menu](#) > [Media](#) > [Movie](#). Mark images and videos, and select [Options](#) > [Create muvee](#).

Create a quick muvee

1. To create a quick muvee, select [Menu](#) > [Media](#) > [Movie](#). Select the videos for the muvee, and scroll right to select the images, and select [Options](#) > [Create muvee](#).
2. Select a style for the muvee from the style list.

Create a custom muvee

1. To create a custom muvee, select [Menu](#) > [Media](#) > [Movie](#). Select the videos for the muvee, and scroll right to select the images, and select [Options](#) > [Create muvee](#). The style selection view opens.
2. Scroll to the desired style, and select [Options](#) > [Customise](#).
3. In [Videos & images](#), reorder and edit the selected items, or add or remove items from your muvee. You can define the order in which the files are played in the

muvee. Select the file you want to move. Scroll to the file below which you want to place the marked file, and press the scroll key. To add or remove images and videos from the muvee, select **Options** > **Add/Remove**.

In **Music**, select the music for the muvee.

To add albums and their content to the muvee, in the image or video clip list view, select **Options** > **Albums**.

In **Message** you can add an opening and closing text to a muvee.

In **Length**, you can define the length of the muvee. Select from the following:

Multimedia message—to optimize the length of the muvee for MMS sending

Auto-select—to include all the selected images and video clips in the muvee

Same as music—to set the muvee duration to be the same as the chosen music clip

User defined—to define the length of the muvee

4. Select **Options** > **Create muvee**. The preview view opens.
5. To preview the custom muvee before saving it, select **Options** > **Play**.
6. To save the muvee, select **Options** > **Save**.

To create a new custom muvee by using the same style settings, select **Options** > **Recreate**.

Select content

To edit the selected video clips, in the **Videos & images** folder, select **Options** > **Select contents**. You can select which parts of the video clip you want to include or exclude in the muvee. In the slide, green indicates included, red indicates excluded, and grey indicates neutral parts.

To include a part of the video clip in the muvee, scroll to the part, and select **Options** > **Include**. To exclude a part, select **Options** > **Exclude**. To exclude a shot, select **Options** > **Exclude shot**.

To let **Movie director** randomly include or exclude a certain part of the video clip, scroll to the part, and select **Options** > **Mark as neutral**. To randomly include or exclude parts of the clip, select **Options** > **Mark all as neutral**.

Settings

In the style selection view, select **Options** > **Customise** > **Settings** to edit the following options:

Memory in use—Select where to save your muvees.

Resolution—Select the resolution of your muvees. Select *Automatic* to use the optimal resolution based on the number and length of the video clips you have selected.

Default muvee name—Set a default name for the muvees.

■ Videos

To access the videos folder in *Gallery*, select *Menu > Media > Videos*.

■ Recorder

The voice recorder allows you to record phone conversations and voice memos. If you record a phone conversation, all parties hear a beeping sound during recording.

Recorded files are stored in *Gallery*. See "Gallery," p. 42.

Select *Menu > Media > Recorder*. To record a sound clip, select *Options > Record sound clip*, or select . To listen to the recording, select .

■ RealPlayer

With RealPlayer, you can play media files such as video clips saved in the phone memory or memory card, or stream media files over the air by opening a streaming link. RealPlayer does not support all file formats or all the variations of file formats.

To open RealPlayer, select *Menu > Media > RealPlayer*. To play a media file, select *Options > Open > Most recent clips* or *Saved clip*.

To stream content over the air:

- Select a streaming link saved in the gallery.
- Open a streaming link while browsing the web.

To stream live content, you must first configure your default access point. See "Access points," p. 78. Contact your service provider for more information.

In RealPlayer, you can only open an *rtsp://* URL address. You cannot open an *http://* URL address; however, RealPlayer recognizes an *http* link to a *.ram* file since a *.ram* file is a text file containing an *rtsp* link.



Warning: Do not hold the device near your ear when the loudspeaker is in use, because the volume may be extremely loud.

With RealPlayer, you can play media files such as video clips saved in the phone memory or memory card, or stream media files over the air by opening a streaming link. To open RealPlayer, select **Menu > Media > RealPlayer**.

RealPlayer does not support all file formats or all the variations of file formats.

Play media files

To play a media file in RealPlayer, select **Options > Open** and from the following:

Most recent clips—to play media files that you have recently played

Saved clip—to play media files saved in the phone or memory card

To stream content over the air:

- Select a streaming link saved in the gallery. A connection to the streaming server is established.
- Open a streaming link while browsing the web.

To stream live content, you must first configure your default access point. See "Access points," p. 78.

Many service providers require you to use an internet access point (IAP) for your default access point. Other service providers allow you to use a WAP access point. Contact your service provider for more information.

In RealPlayer, you can only open an `rtsp://` URL address. You cannot open an `http://` URL address; however, RealPlayer recognizes an `http` link to a `.ram` file since a `.ram` file is a text file containing an `rtsp` link.



Warning: Do not hold the device near your ear when the loudspeaker is in use, because the volume may be extremely loud.

Shortcuts during play

Scroll up to seek forward or down to seek back in the media file.

Press the volume keys to increase or decrease the sound volume.

■ Flash Player

With **Flash Player**, you can view, play, and interact with flash files made for mobile devices.

Select **Menu > Media > Flash Player**.

To open a folder or play a flash file, select it.

10. Personalization

■ Themes

To change the look of your phone display, activate a theme. A theme can include the standby mode wallpaper and power saver. You can edit a theme to personalize your phone further.

Select [Menu](#) > [Personalis.](#) > [Themes](#). To see a list of the available themes, select [General](#). The active theme is indicated by a check mark.

To preview a theme, scroll to the theme, and select [Options](#) > [Preview](#). To activate the previewed theme, select [Set](#).

In [Themes](#), you can also set the menu view type, set a custom wallpaper, and personalize the look of the power saver.

Audio theme

To apply or edit an audio theme, select [Menu](#) > [Personalis.](#) > [Themes](#) > [Audio themes](#).

To apply an audio theme, select [Active audio theme](#) and the desired theme.

You can personalize the sounds associated with an event or function.

To save the personalized theme, in the [Audio themes](#) main view, select [Options](#) > [Save theme](#) and enter a name for the theme.

■ Profiles

In [Profiles](#), you can adjust and personalize the phone tones for different events, environments, or caller groups. You can see the currently selected profile at the top of the display in the standby mode. If the [General](#) profile is in use, only the current date is shown.

Select [Menu](#) > [Personalis.](#) > [Profiles](#).

To activate the profile, select the profile and [Activate](#).



Tip: To quickly change to [Silent](#) profile from any other profile, in the standby mode, press and hold <#>.

To personalize a profile, select the profile, [Personalise](#) and from the following options:

Ringtone—To set the ringing tone for voice calls, choose a ringing tone from the list. Press any key to stop the sound. You can also change ringing tones in contacts. See "Add a ringing tone," p. 41.

Video call tone—Select the ringing tone for video calls.

Say caller's name—Select *On* to have the phone say the caller's name when the phone is ringing.

Ringtone type—When *Ascending* is selected, the ringing volume starts from level one and increases level by level to the set volume level.

Ringtone volume—Set the volume level for the ringing and message alert tones.

Message alert tone—Set the alert tone for text and multimedia messages.

E-mail alert tone—Set the alert tone for e-mail messages.

Vibrating alert—Set the phone to vibrate to alert for incoming calls and messages.

Keypad tones—Set the volume level for keypad tones.

Warning tones—Activate or deactivate warning tones.

Alert for—Set the phone to ring only upon calls from phone numbers that belong to a selected contact group. Phone calls coming from people outside the selected group have a silent alert.

Profile name—Name the profile. This setting is not shown for the *General* and *Offline* profiles.

When using the *Offline* profile, the phone is not connected to the GSM network. If no SIM card is installed, to use some functions of the phone, start the phone in *Offline*.



Important: In the offline profile you cannot make or receive any calls, or use other features that require cellular network coverage. Calls may still be possible to the official emergency number programmed into your device. To make calls, you must first activate the phone function by changing profiles. If the device has been locked, enter the lock code.

■ 3-D tones

With *3-D tones* you can apply three-dimensional sound effects to ringing tones. Not all ringing tones support 3-D effects. To edit 3-D tone settings, select *Menu* > *Personalis* > *3-D tones*.

To enable the 3-D effects, select *3-D tones* > *On*. To change the ringing tone, select *Ringtone* and the desired ringing tone.

To change the 3-D effect that is applied to the ringing tone, select *Sound trajectory* and the desired effect. To modify the effect, select *Trajectory speed*, *Doppler effect*, or *Reverberation*. *Doppler effect* may not be available for all effects.

To listen to the ringing tone with the 3-D effect, select **Options** > *Play tone*.

If you enable the 3-D tones but do not select any 3-D effect, stereo widening is applied to the ringing tone.

11. Web

■ Mobile Search

Use Mobile Search to get access to search engines, and find and connect to local services, websites, images, and mobile content. You can use the application to find and call local restaurants and shops, and use the advanced mapping technology to assist you in finding their location.

Select **Menu** > *Web* > *Search*.

When you open Mobile Search, a list of categories is displayed. Select a category (for example, images), and enter your text into the search field. Select *Search*. The search results are displayed on the screen.

For additional help and instructions on the application, select **Options** > *Help*.

For more information on the application, visit also www.mobilesearch.nokia.com/.

■ Web

To browse web pages written in XHTML, WML, or HTML, select **Menu** > *Web* > *Browser*, or press and hold 0 in the standby mode.

Check the availability of services, pricing, and tariffs with your service provider. Service providers also give you instructions on how to use their services.

Set up the phone for the browser service

Your device may configure the WAP or internet access point automatically based on your SIM card.

You can use *Settings wizard* to configure WAP or internet access point settings. See "Settings wizard," p. 80.

You may receive service settings in a configuration message from the service provider.

To define an access point manually, see [Access points](#) in "Connection," p. 78.

Make a connection

To access web pages, do the following:



- Select the home page () of your service provider.
- Select a bookmark from the bookmarks view.
- In the bookmarks view, enter the address of the web page, and select [Go to](#).

Bookmarks



Your device may have preinstalled bookmarks and links for third-party internet sites. You may also access other third-party sites through your device. Third-party sites are not affiliated with Nokia, and Nokia does not endorse or assume liability for them. If you choose to access such sites, you should take precautions for security or content.

Bookmarks are indicated by the following icons:

 The starting page defined for the default access point.

 The automatic bookmarks folder contains bookmarks () that are collected automatically when you browse pages.

 Any bookmark showing the title or internet address of the bookmark.

 and  may be replaced with the website's icon.

Add bookmarks manually

1. In the bookmarks view, select [Options](#) > [Bookmark manager](#) > [Add bookmark](#).
2. Fill in the fields.
3. Select [Options](#) > [Save](#).

Send bookmarks

Scroll to a bookmark or mark several bookmarks, select [Options](#) > [Tools](#) > [Send](#) and an option.

Connection security

If the security indicator  is displayed during a connection, the data transmission between the device and the internet gateway or server is encrypted.

The security icon does not indicate that the data transmission between the gateway and the content server (or place where the requested resource is stored) is secure. The service provider secures the data transmission between the gateway and the content server.

To view details about the connection, encryption status, and information about server authentication, select **Options** > **Tools** > **Page info**.

Security features may be required for some services, such as banking services. For such connections you need security certificates. For more information, contact your service provider. See also "Certificate management," p. 74.

Browse web pages

Keys and commands for browsing

To open a link, make selections, or check boxes, press the scroll key.

To go to the previous page while browsing, select **Back**. If **Back** is not available, select **Options** > **Navigation options** > **History** to view a chronological list of the pages visited during a browsing session. To choose the desired page, scroll left or right, and select it. The history list is cleared each time a session is closed.

To save a bookmark while browsing, select **Options** > **Save as bookmark**.

To retrieve the latest content from the server, select **Options** > **Navigation options** > **Reload**.

To open the browser toolbar, scroll to an empty part of the page, and press the scroll key.

Keypad shortcuts while browsing

1—Open your bookmarks.

2—Search for keywords in the current page.

3—Return to the previous page.

5—List all open windows.

8—Show the page overview of the current page. Press **8** again to zoom in and view the desired section of the page.

9—Enter a new web address.

0—Go to the start page.

* or #—Zoom the page in or out.

Mini map

[Mini map](#) helps you navigate web pages that contain large amount of information. Set [Mini map](#) on in browser settings. See "Browser settings," p. 64. Scroll through a large web page, and [Mini map](#) opens and displays an overview of the web page you are browsing. To move in [Mini map](#), scroll. When you stop scrolling, [Mini map](#) disappears and the area outlined in [Mini map](#) is displayed.

Page overview

With [Page overview](#), you can move more quickly to the desired part of a web page. Page overview may not be available on all pages.

To show the page overview of the current page, press 8. To find the desired spot on the page, scroll up or down. Press 8 again to zoom in and view the desired section of the page.

Web feeds and blogs

Web feeds are .xml files on web pages that are widely used to share the latest entry headlines or full text, for example, recent news in the form of news feeds. Blogs or weblogs are web diaries. Most of the web feeds use RSS and ATOM technologies.

The browser automatically detects if a web page contains web feeds. To subscribe to a web feed, select [Options](#) > [Subscribe](#) and a feed, or click on the link. To view the web feeds you have subscribed to, in the bookmarks view, select [Web feeds](#).

To update a web feed, select it, and [Options](#) > [Refresh](#).

To define how the web feeds are updated, select [Options](#) > [Settings](#) > [Web feeds](#).

Saved pages

You can save pages and view them later offline.

To save a page while browsing, select [Options](#) > [Tools](#) > [Save page](#).

To open the [Saved pages](#) view, in the bookmarks view, select [Saved pages](#). To open a page, select it.

To start a connection to the browser service and retrieve the page again, select [Options](#) > [Navigation options](#) > [Reload](#). The phone stays online after you reload the page.

Download

You can download items such as ringing tones, images, operator logos, software, and video clips using the mobile browser.

Once downloaded, items are handled by the respective applications on your phone, for example, a downloaded photo is saved in [Gallery](#).



Important: Only install and use applications and other software from trusted sources, such as applications that are Symbian Signed or have passed the Java Verified™ testing.

End a connection

To end the connection and view the browser page offline, select [Options](#) > [Tools](#) > [Disconnect](#). To quit browsing and to return to the standby mode, select [Options](#) > [Exit](#).

Empty the cache

A cache is a memory location that is used to store data temporarily. If you have tried to access or have accessed confidential information requiring passwords, empty the cache after each use. The information or services you have accessed are stored in the cache. To empty the cache, select [Menu](#) > [Web](#) > [Browser](#) > [Options](#) > [Clear privacy data](#) > [Clear cache](#).

To clear all privacy data, including the cache, cookies, form data passwords, and browsing history, select [Menu](#) > [Web](#) > [Browser](#) > [Options](#) > [Clear privacy data](#) > [All](#).

Browser settings

Select [Options](#) > [Settings](#) > [General](#), [Page](#), [Privacy](#) or [Web feeds](#), and from the following:

General

[Access point](#)—Select the default access point.

[Homepage](#)—Define the address of the desired homepage.

[Mini map](#)—Set on or off.

[History list](#)—Select whether a list of the pages you have visited during the current browsing session are displayed when you select [Back](#).

[Security warnings](#)—Hide or show security notifications.

[Java/Ecma Script](#)—Enable or disable the use of scripts.

Page

Load images and sounds—Select whether to view pictures and hear sounds when you are browsing. If you select *No*, to later load images and sounds during browsing, select **Options > Tools > Load images**.

Screen size—Choose how to use the display area for viewing pages.

Default encoding—When you select *Automatic*, the browser automatically tries to choose the correct character encoding.

Block pop-ups—Allow or block automatic opening of different pop-ups while browsing.

Automatic reload—Enable or disable automatic refresh of browser pages.

Font size—Select the font size.

Privacy

Auto. bookmarks—Select *On* if you want the bookmarks to be automatically saved in the *Auto. bookmarks* folder when you visit a page. When you select *Hide folder*, the bookmarks are still automatically added to the folder.

Form data saving—If you do not want the data you enter to different forms on a web page to be saved and used next time the page is entered, select *Off*.

Cookies—Enable or disable the receiving and sending of cookies (a means for content providers to identify users and their preferences for frequently used content).

Web feeds

Automatic updates—Define whether you want the web feeds to be updated automatically or not, and how often you want to update them. Setting the application to retrieve web feeds automatically may involve the transmission of large amounts of data through your service provider's network. Contact your service provider for information about data transmission charges.

Acc. point for auto-update—Select the desired access point for updating (only available when *Automatic updates* is on).

12. Organizer

■ Clock

Select **Menu > Organiser > Clock**.

Clock settings

To change the time or date, select [Options](#) > [Settings](#). For more information about the settings, see "Date and time," p. 73.

Set an alarm

1. To set a new alarm, scroll right to [Alarm](#), and select [Options](#) > [New alarm](#).
2. Enter the alarm time, select whether and when the alarm is repeated, and select [Done](#). When an alarm is active,  is shown.

To cancel an alarm, scroll to the alarm, and select [Options](#) > [Remove alarm](#). To deactivate a repeated alarm, select [Options](#) > [Deactivate alarm](#).

Turn off the alarm

Select [Stop](#) to turn off the alarm.

Select [Snooze](#) to stop the alarm for 5 minutes, after which it resumes.

If the alarm time is reached while the device is switched off, the device switches itself on and starts sounding the alarm tone. If you select [Stop](#), the device asks whether you want to activate the device for calls. Select [No](#) to switch off the device or [Yes](#) to make and receive calls. Do not select [Yes](#) when wireless phone use may cause interference or danger.

World clock

To open the world clock view, scroll right to [World](#). To add cities to the list, select [Options](#) > [Add city](#).

To set your current city, scroll to a city, and select [Options](#) > [Set as current city](#). The city is displayed in the clock main view, and the time in your device is changed according to the city selected. Check that the time is correct and matches your time zone.

■ **Calendar**

Select [Menu](#) > [Organiser](#) > [Calendar](#).

In the calendar, you can keep track of your appointments, meetings, birthdays, anniversaries, and other events. You can also set a calendar alarm to remind you of upcoming events.

Create calendar entries

1. Select **Options** > *New entry* and an entry type.

Anniversary entries are repeated every year.

2. Fill in the fields.

Repeat—Press the scroll key to change the entry to be repeated. A repeating entry is indicated by  in the day view.

Repeat until—Set an ending date for the repeated entry, for example, the last date of a weekly course you are taking. This option is shown only if you have selected to repeat the event.

Synchronisation > *Private*—After synchronization the calendar entry can be seen only by you, and it is not shown to others even if they have online access to view the calendar. *Public*—The calendar entry is shown to others who have access to view your calendar online. *None*—The calendar entry is not copied when you synchronize your calendar.

3. To save the entry, select **Done**.

Calendar views

Press # in the month, week, or day views to automatically highlight the current date.

To create a meeting entry, press any number key (0–9) in any calendar view.

To go to a certain date, select **Options** > *Go to date*. Write the date, and select **OK**.

To-do

Select **Options** > *To-do view*.

In the *To-do view*, you can keep a list of tasks that you need to do.

Create a to-do note

1. To start to write a to-do note, press any number key (0–9).
2. Write the task in the *Subject* field. Set a due date and a priority for the task.
3. To save the to-do note, select **Done**.

■ Notes

Select **Menu** > *Organiser* > *Notes*.

To write a new note, start writing. To save the note, select **Done**.

You can save plain text files (.txt format) you receive to [Notes](#).

■ Calculator

Select [Menu](#) > [Organiser](#) > [Calculator](#).

1. Enter the first number of your calculation.
2. Scroll to an arithmetic function, and select it.
3. Enter the second number.
4. To execute the calculation, select .

To add a decimal, press #.



Note: This calculator has limited accuracy and is designed for simple calculations.

■ Converter

Select [Menu](#) > [Organiser](#) > [Converter](#).

In the converter, you can convert measurement parameters such as [Length](#) from one unit to another, for example, [Yards](#) to [Metres](#).

The converter has limited accuracy and rounding errors may occur.

Set a base currency and exchange rates

Before you can convert currency, you need to choose a base currency (usually your domestic currency) and add exchange rates.

The rate of the base currency is always 1. The base currency determines the conversion rates of the other currencies.

1. Select [Currency](#) as the measurement type, and select [Options](#) > [Currency rates](#).
2. To change the base currency, scroll to the currency (usually your domestic currency), and select [Options](#) > [Set as base currency](#).
3. Add exchange rates, scroll to the currency, and enter a new rate, that is, how many units of the currency equal one unit of the base currency you selected.
4. After you insert all the required exchange rates, you can convert currency.



Note: When you change base currency, you must enter new exchange rates because all previously set exchange rates are cleared.

Convert units

To convert currency, you must first set the exchange rate. See "Set a base currency and exchange rates," p. 68.

1. Select *Type* and the type of measurement to convert, and select **OK**.
2. Select the first *Unit* field, the unit from which you want to convert, and **OK**.
3. Select the next *Unit* field and the unit to which you want to convert.
4. In the first *Amount* field, enter the value to be converted. The other *Amount* field changes automatically to show the converted value.

Press # to add a decimal and press * for the +, - (for temperature), and E (exponent) symbols.

The conversion order changes if you write a value in the second *Amount* field. The result is shown in the first *Amount* field.

13. Applications

■ Download!

Download! (network service) is a mobile content shop available on your device. You may be able to download some content free of charge.

With *Download!* you can discover, preview, buy, download, and upgrade content, services, and applications. The items are categorized under catalogs and folders provided by different service providers. The available content depends on your service provider.

Select **Menu** > *Applications* > *Download!*.

Download! uses your network services to access the most up-to-date content. For information on additional items available through *Download!*, contact your service provider, or the supplier or manufacturer of the item.

■ My own

To access the applications you have downloaded in your phone, select **Menu** > *Applications* > *My own*.

GPS data

This feature is not designed to support positioning requests for related calls. Contact your service provider for more information about how your phone complies with government regulations on location-based emergency calling services.

GPS data is a GPS application that enables you to view your current location, find your way to a desired location, and track distance. The application requires a Bluetooth GPS enhancement to operate. You must also have Bluetooth GPS positioning method enabled in [Menu > Settings > Phone sett. > General > Positioning > Positioning methods](#).

Select [Menu > Applications > My own > GPS data](#).

In *GPS data* and *Landmarks*, coordinates are expressed in degrees and decimal degrees format using WGS-84 coordinate system.

Landmarks

Landmarks are coordinates to geographic locations that you can save to your device for later use in different location-based services. You can create landmarks using a Bluetooth GPS enhancement or network (network service).

Select [Menu > Applications > My own > Landmarks](#).

14. Settings

■ Voice commands

To select the functions to use by voice command, select [Menu > Settings > Voice comm.](#) The voice commands for changing profiles are in the *Profiles* folder.

To activate a new voice command for an application, select [Options > New application](#) and the application.

To manage the voice commands, scroll to a function, select [Options](#) and from the following options:

[Change command](#) or [Remove application](#)—to change or deactivate the voice command of the selected function

[Playback](#)—to play the activated voice command

To use voice commands, see "Voice dialing," p. 22.

To change voice command settings, select [Options](#) > [Settings](#) and from the following options:

[Synthesiser](#)—to activate or deactivate the text-to-speech synthesiser that says out loud the recognized voice command

[Remove voice adapts](#)—to reset the voice adaptations. The phone adapts to the user's voice to better recognize the voice commands.

■ Call mailbox

Call mailbox is a network service. Contact your service provider for the call mailbox number.

To define the call mailbox number if no number is set, select [Menu](#) > [Settings](#) > [Call mailbox](#), and when [Voice mailbox number](#) is displayed, enter the voice mailbox number.

To change the call mailbox number, select [Menu](#) > [Settings](#) > [Call mailbox](#) > [Options](#) > [Change number](#), and enter the number.

■ Speed dial

To assign phone numbers to the speed dialing keys, select [Menu](#) > [Settings](#) > [Speed dial](#), scroll to a key icon, and select [Options](#) > [Assign](#). Select the contact and the number for the speed dial.

To view the number assigned to a speed-dialing key, scroll to the key icon, and select [Options](#) > [View number](#). To change or remove the number, select [Change](#) or [Remove](#).

■ Phone settings

General

Select [Menu](#) > [Settings](#) > [Phone sett.](#) > [General](#) > [Personalisation](#), [Date and time](#), [Enhancement](#), [Security](#), [Factory settings](#), or [Positioning](#).

Personalisation

Select [Display](#), [Standby mode](#), [Tones](#), [Language](#), [Themes](#), or [Voice comms.](#)

Display

[Light sensor](#)—to adjust the light sensor that observes the lighting conditions and adjusts the brightness of the display

Font size—to select the font size used in lists and editors

Power saver time-out—to set the time-out period after which the power saver is activated

Welcome note/logo—to set the welcome note or logo which is displayed briefly each time you switch on the phone.

Light time-out—to set the time-out for the display light

Standby mode

Active standby—to enable or disable active standby. See "Active standby," p. 16.

Shortcuts—to assign shortcuts for the right and left selection keys, scrolling in different directions or pressing the scroll key in the standby mode. The scroll key shortcuts are not available if *Active standby* is *On*.

Active standby apps—to select the application shortcuts to appear in the active standby. This setting is available only if *Active standby* is set to *On*.

Operator logo—this setting is visible only if you have received and saved an operator logo. You can select whether the operator logo is shown.

Tones

Change the tones of the clock, calendar and currently active profile. See "Profiles," p. 58.

Language

Phone language—to change the language for the display texts in your phone. This change may also affect the format used for date and time and the separators used, for example, in calculations. If you select *Automatic*, the phone selects the language according to the information on your SIM card. After you have changed the display text language, the phone restarts.

Writing language—to change the writing language of your phone. Changing the language affects the characters and special characters available when writing text and the predictive text dictionary used.

Predictive text—to set predictive text input *On* or *Off* for all editors in the phone. Select a language for entering predictive text from the list.

Themes

Apply themes. See "Themes," p. 58.

Voice commands

Edit voice command and voice dialing settings. See "Voice commands," p. 70.

Date and time

Time and *Date*—to set the time and date

Time zone—to set the time zone of your location. If you set *Network operator time* > *Auto-update*, the local time is shown.

Date format—to select the format to display dates

Date separator—to select the date separator

Time format—to select between 24-hour and 12-hour time format

Time separator—to select the time separator

Clock type—to select whether the analog or digital clock is shown in the standby mode. See "Clock," p. 65.

Clock alarm tone—to select the alarm clock tone

Workdays—to specify days for alarms repeated only on workdays

Network operator time (network service) — to allow the network to update time, date, and time zone information to your phone. If you select *Auto-update*, all active connections are disconnected. Check any alarms as these may be affected.

Enhancement

To change settings of an enhancement, in the *Enhancement sett.* view, scroll to an enhancement, such as *Headset*, select *Options* > *Open* and from the following options:

Default profile—to select the profile you want to activate each time you connect the enhancement to your phone

Automatic answer—to set the phone to answer an incoming call automatically after 5 seconds when this enhancement is connected to your phone. If the *Ringling type* is set to *Beep once* or *Silent*, automatic answer cannot be used, and you must answer the phone manually.

Lights—To set the phone lights continuously on while using the enhancement, select *On*.

Security

Select *Phone and SIM card*, *Certificate management*, or *Security module*.

Phone and SIM card

You can change the following codes: lock code, (U)PIN code, and PIN2 code. These codes can only include the numbers from 0 to 9.

Avoid using access codes similar to emergency numbers to prevent accidental dialing of the emergency number.

Code in use—to select the active code, *PIN* or *UPIN*, for the active USIM. This is shown only if the active USIM supports UPIN, and the UPIN is not rejected.

PIN code request or *UPIN code request*—to set the phone to request the code each time the phone is switched on. Some SIM cards may not allow the PIN code request to be turned *Off*. If you select *Code in use* > *UPIN*, *UPIN code request* is shown instead.

PIN code or *UPIN code*, *PIN2 code*, and *Lock code*—to change the codes

Keypad autolock period > *User defined*—to automatically lock the keypad after a defined period of inactivity

Phone autolock period—to set a time-out after which the phone is automatically locked. To use the phone again, you need to enter the correct lock code. To turn off the autolock period, select *None*.

Lock if SIM card changed—to set the phone to prompt for the lock code when an unknown, new SIM card is inserted into your phone. The phone keeps a list of SIM cards that are recognized as the owner cards.

Closed user group (network service)—to specify a group of people whom you can call and who can call you. For more information, contact your service provider. To activate the default group agreed on with the service provider, select *Default*. If you want to use another group (you need to know the group index number), select *On*.

When calls are limited to closed user groups, calls may be possible to the official emergency number programmed into your device.

Confirm SIM services (network service)—to set the phone to display confirmation messages when you use a SIM card service

Certificate management

A list of authority certificates that have been stored in your phone is displayed in *Certificate management*. To see a list of personal certificates if available, scroll right.

Digital certificates should be used if you want to connect to an online bank or another site or remote server for actions that involve transferring confidential information. They should also be used if you want to reduce the risk of viruses or other malicious software and be sure of the authenticity of software when downloading and installing software.



Important: Even if the use of certificates makes the risks involved in remote connections and software installation considerably smaller, they must be used correctly in order to benefit from increased security. The existence of a certificate does not offer any protection by itself; the certificate manager must contain correct, authentic, or trusted certificates for increased security to be available. Certificates have a restricted lifetime. If "Expired certificate" or "Certificate not valid yet" is shown even if the certificate should be valid, check that the current date and time in your device are correct.

Before changing any certificate settings, you must make sure that you really trust the owner of the certificate and that the certificate really belongs to the listed owner.

View certificate details and check authenticity

You can only be sure of the correct identity of a server when the signature and the period of validity of a server certificate have been checked.

The phone notifies you if the identity of the server is not authentic or if you do not have the correct security certificate in your phone.

To check certificate details, scroll to a certificate, and select **Options** > **Certificate details**. While opening the certificate details, the phone checks the validity of the certificate and one of the following notes may appear:

Expired certificate—The validity period has ended for the selected certificate.

Certificate not valid yet—The validity period has not yet begun for the selected certificate.

Certificate corrupted—The certificate cannot be used. Contact the certificate issuer.

Certificate not trusted—You have not set any application to use the certificate.

Change the trust settings

Before changing any certificate settings, you must make sure that you really trust the owner of the certificate and that the certificate really belongs to the listed owner.

Scroll to an authority certificate, and select **Options** > **Trust settings**. Depending on the certificate, a list of the applications that can use the selected certificate is shown.

Security module

View or edit security modules.

Factory settings

Reset some of the settings to their original values. You need the lock code. See "Lock code," p. 8.

Positioning

With the positioning service you can receive information from service providers about local issues such as weather and traffic conditions, based on the location of your device (network service).

To enable a positioning method, select [Positioning methods](#), scroll to the positioning method, and select [Options](#) > [Enable](#). To stop using it, select [Options](#) > [Disable](#).

To define the positioning server access point, select [Positioning server](#) > [Access point](#) and the desired access point. Then select [Server address](#), and enter the domain name or URL address of the server.

Phone

Select [Menu](#) > [Settings](#) > [Phone sett.](#) > [Phone](#) and [Call](#), [Call divert](#), [Call barring](#), or [Network](#).

Call

[Send my caller ID](#) (network service)—to set your phone number to be displayed ([Yes](#)) or hidden ([No](#)) from the person whom you are calling. The value may be set by your service provider when you subscribe to the service ([Set by network](#)).

[Call waiting](#) (network service)—to set the network to notify you of a new incoming call while you have a call in progress. To request the network to activate call waiting, select [Activate](#). To request the network to deactivate call waiting, select [Cancel](#). To check whether the function is active, select [Check status](#).

[Reject call with SMS](#)—to enable rejecting phone calls with a text message. See "Answer or reject a call," p. 23.

[Message text](#)—to enter a text to be sent when you reject a call with a text message

[Image in video call](#)—to select a still image to be shown instead of the video when you deny video sending in a video call

[Automatic redial](#)—to set the phone to make a maximum of 10 attempts to connect the call after an unsuccessful call attempt. Press the end key to stop automatic redialing.

Show call duration—to set the phone to display the call duration during a call

Summary after call—to set the phone to briefly display the approximate duration of the last call

Speed dialling > *On*—to set the phone to dial the numbers assigned to the speed dialing keys, 2 to 9, by pressing and holding the corresponding number key

Anykey answer > *On*—to answer an incoming call by briefly pressing any key, except the right selection key, volume keys, and the end key

Line in use (network service)—shown only if the SIM card supports two subscriber numbers, that is, two phone lines. Select which phone line (*Line 1* or *Line 2*) you want to use for making calls and sending short messages.

Calls on both lines can be answered irrespective of the selected line. You cannot make calls if you select *Line 2* and have not subscribed to this network service. To prevent line selection, select *Line change* > *Disable* if supported by your SIM card. To change this setting, you need the PIN2 code.

Call divert

Call divert is a network service.

1. Select which calls you want to divert: *Voice calls*, *Data and video calls*, or *Fax calls*.
2. Select the desired option. For example, to divert voice calls when your number is busy or when you reject an incoming call, select *If busy*.
3. To set the divert option on or off, select *Options* > *Activate* or *Cancel*. To check whether the option is activated, select *Check status*. Several divert options can be active at the same time.

Call barring and call diverting cannot be active at the same time.

Call barring

Call barring (network service) allows you to restrict the calls that you make and receive with your phone. To change the settings, you need the barring password from your service provider.

Scroll to the desired barring option, and to request the network to set call restriction on, select *Options* > *Activate*. To set the selected call restriction off, select *Cancel*. To check whether the calls are barred, select *Check status*. To change the barring password, select *Edit barring password*. To cancel all active call barrings, select *Cancel all barrings*.

Call barring and call diverting cannot be active at the same time.

When calls are barred, calls may be possible to certain official emergency numbers.

Network

Network mode—To select which network to use (shown only if supported by the service provider). If you select *Dual mode*, the device uses the GSM or UMTS network automatically, according to the network parameters and the roaming agreements between the network operators.

Operator selection—To set the phone to search for and select automatically one of the available networks, select *Automatic*. To select the desired network manually from a list of networks, select *Manual*. If the connection to the manually selected network is lost, the phone sounds an error tone and asks you to select a network again. The selected network must have a roaming agreement with your home network, that is, the operator whose SIM card is in your phone.

Cell info display (network service)—To set the phone to indicate when it is used in a cellular network based on microcellular network (MCN) technology and to activate cell info reception, select *On*.

Connection

Select **Menu** > *Settings* > *Phone sett.* > *Connection* > *Bluetooth, USB, Access points, Packet data, Data call, SIP settings, Configurations, or APN control*.

Bluetooth

Switch Bluetooth on or off, and edit Bluetooth settings. See "Bluetooth connection," p. 84.

USB

Edit USB settings. See "USB data cable," p. 93.

Access points

To establish a data connection, an access point is required. You can define different kinds of access points:

- MMS access point to send and receive multimedia messages
- WAP access point to view web pages
- Internet access point (IAP) (for example, to send and receive e-mail)

Check which kind of access point you need with your service provider for the service you wish to access. For availability and subscription to data connection services, contact your service provider.

You may receive access point settings in a message from your service provider, or you may have preset access point settings in your phone.

To create a new access point or edit an existing access point, select **Options** > [New access point](#) or [Edit](#). To create a new access point using the settings of an existing access point, scroll to an access point, and select **Options** > [Duplicate access point](#).

Depending on the connection type selected in [Data bearer](#), only certain settings are available. Fill in all fields marked with [Must be defined](#) or with an asterisk.

Contact your service provider for the following settings: [Data bearer](#), [Access point name](#) (for packet data only), [Dial-up number](#) (for data call only), [User name](#), [Password](#), [Authentication](#), [Homepage](#), [Data call type](#) (for data call only), and [Maximum data speed](#) (for data call only).

[Connection name](#)—Enter a descriptive name for the connection.

[Prompt password](#)—If you must enter a new password every time you log onto a server, or if you do not want to save your password to the phone, select [Yes](#).

If necessary, to define the internet protocol (IP) version, phone IP address, domain name system (DNS) servers, proxy server, and advanced data call settings, such as callback, PPP compression, login script, and modem initialization string, select **Options** > [Advanced settings](#). Contact your service provider for the correct settings.

Packet data

The packet data settings affect all access points using a packet data connection.

[Packet data connection](#)—If you select [When available](#) and you are in a network that supports packet data, the phone registers to the packet data network and short messages are sent using a packet data connection. If you select [When needed](#), the phone uses a packet data connection only if you start an application or function that needs it. The packet data connection can be closed when it is not needed by any application.

If there are no packet data services available and you have chosen [When available](#), the phone periodically tries to establish a packet data connection.

[Access point](#)—The access point name is needed when you want to use your phone as a modem with your computer.

Data call

The data call settings affect all access points that use a GSM data call.

Online time—to set the data call to disconnect automatically after a time-out if there is no activity. To enter a time-out, select *User defined*, and enter the time in minutes. If you select *Unlimited*, the data call is not disconnected automatically.

SIP settings

View and edit session initiation protocol (SIP) profiles.

Configurations

Certain functions, such as web browsing and multimedia messaging, may require configuration settings. You may receive the settings from your service provider. See "Configuration settings," p. 13.

To delete a configuration, scroll to the configuration, and select **Options** > *Delete*.

Access point name control

With the access point name control service, you can restrict the use of packet data access points. This setting is only available if your SIM card supports the service. To change the settings, you need the PIN2 code.

Applications

To view and edit settings of applications installed to your phone, select **Menu** > *Settings* > *Phone sett.* > *Applications*.

■ Speech

In *Speech*, you can select the default language and voice used for reading messages and adjust the voice properties, such as rate and volume. Select **Menu** > *Settings* > *Speech*.

To automatically detect the language of a message and read the message using that language, select *Language detection* > *On*. When reading a message, if there is no voice available for the language or if *Language detection* is set to *Off*, the default language is used.

To view details of a voice, scroll right, scroll to the voice, and select **Options** > *Voice details*. To test a voice, scroll to the voice, and select **Options** > *Play voice*.

■ Settings wizard

Sett. wizard configures your device for operator (MMS, GPRS, and internet) and e-mail settings based on your service provider. Configuring other settings may also be possible.

To use these services, you may have to contact your service provider to activate a data connection or other services.

Select [Menu](#) > [Settings](#) > [Sett. wizard](#).

■ Instant messaging

Instant messaging (IM) allows you to converse with others and join discussion forums (IM groups) with specific topics (network service).

Check the availability of IM services, pricing, and tariffs with your service provider. Service providers also provide instructions on how to use their services.

Connect to an IM server

Select [Menu](#) > [Settings](#) > [IM](#).

1. To log in, select [Options](#) > [Log in](#).
2. Enter your user ID and password.

To log out, select [Options](#) > [Log out](#).

IM settings

Select [Menu](#) > [Settings](#) > [IM](#) > [Options](#) > [Settings](#).

To edit the IM application settings, select [IM settings](#). To set who is allowed to see when you are online, select [Show my availability](#). To set who is allowed to send you messages or invitations, select [Allow messages from](#) or [Allow invitations from](#).

To edit IM server connection settings, select [Servers](#), scroll to the server, and select [Options](#) > [Edit](#). Contact your service provider for the settings. To define new server settings, select [Options](#) > [New server](#).

To choose the default server, select [Default server](#) and the server.

To be automatically connected to the IM server during the days and times you define, select [IM login type](#) > [Automatic](#). To only be automatically connected while in your home network, select [Auto in home netw.](#). To be automatically connected when you start the IM application, select [On app. start-up](#). To connect manually, select [Manual](#).

To set days and times when to establish a connection automatically, select [Automatic login days](#) and [Automatic login hrs.](#)

Join and leave an IM group

Select [Menu](#) > [Settings](#) > [IM](#) > [IM groups](#).

IM groups are only available if supported by the service provider.

To join an IM group, select it. To join an IM group not on the list, but whose group ID you know, select [Options](#) > [Join new group](#), and enter the group ID.

To leave the IM group, select [Options](#) > [Leave IM group](#).

Search for IM groups and users

To search for groups, select [Menu](#) > [Settings](#) > [IM](#) > [IM groups](#) > [Options](#) > [Search](#). You can search IM groups by [Group name](#), [Topic](#), or [Members](#) (user ID). To join or save a group that is found in the search, scroll to it, and select [Options](#) > [Join](#) or [Save](#).

To search for new contacts, select [IM contacts](#) > [Options](#) > [New IM contact](#) > [Search from server](#). To start a conversation with a new user, scroll to the user, and select [Options](#) > [Open conversation](#). To save the new contact, select [Add to IM contacts](#).

Chat in an IM group

Select [Menu](#) > [Settings](#) > [IM](#) > [IM groups](#).

After you join an IM group, you can view the messages that are exchanged in the group, and send your own messages.

To send a message, write the message, and press the scroll key.

To send a private message to a member (if allowed in the group), select [Options](#) > [Send private message](#), select the recipient, write the message, and press the scroll key.

To reply to a private message sent to you, scroll to the message, and select [Options](#) > [Reply](#).

To invite IM contacts who are online to join the IM group (if allowed in the group), select [Options](#) > [Send invitation](#), select the contacts you want to invite, write the invitation message, and select [Done](#).

Start and view individual conversations

Select [Menu](#) > [Settings](#) > [IM](#) > [Conversations](#).

This shows a list of the IM users with whom you have an ongoing conversation.

 next to a user indicates that you have received a new message from that user.

To view an ongoing conversation, select the user. To send a message, write your message, and press the scroll key. To return to the conversations list without closing the conversation, select [Back](#).

To start a new conversation, select [Options](#) > [New conversation](#) > [Select recipient](#) and from a list of your saved IM contacts that are currently online; or select [Enter user ID](#) to enter the user ID.



To close the conversation, select [Options](#) > [End conversation](#).

To save a user to your IM contacts, scroll to the user, and select [Options](#) > [Add to IM contacts](#).

To block messages from a user, scroll to the user, and select [Options](#) > [Blocking options](#) > [Add to blocked list](#).

IM contacts

Select [Menu](#) > [Settings](#) > [IM](#) > [IM contacts](#).

You can see a list of your saved IM contacts.  indicates contacts that are currently online, and  indicates contacts that are offline.

To create a new contact, select [Options](#) > [New IM contact](#). Fill in the [Nickname](#) and [User ID](#) fields, and select [Done](#).

To start or continue a conversation with a contact, scroll to the contact, and select [Options](#) > [Open conversation](#).

Create a new IM group

Select [Menu](#) > [Settings](#) > [IM](#) > [IM groups](#) > [Options](#) > [Create new group](#). Enter the settings for the group.

Restrict access to an IM group

To create a closed IM group, create a group members list. Only the users on the list are allowed to join the group. Select the [IM groups](#) view, scroll to the group, and select [Options](#) > [Group](#) > [Settings](#) > [Group members](#) > [Selected only](#).

15. Connectivity

■ PC Suite

You can use your phone with a variety of PC connectivity and data communication applications. With PC Suite you can synchronize contacts, calendar and to-do notes and notes between your phone and a compatible PC.

You may find more information about PC Suite and the download link in the support area on the Nokia website, www.nokia.com/pcsuite.

■ Bluetooth connection

Bluetooth technology enables wireless connections between electronic devices within a maximum range of 10 meters (33 feet). A Bluetooth connection can be used to send images, videos, text, business cards, calendar notes, or to connect wirelessly to compatible devices using Bluetooth technology, such as computers.

This device is compliant with Bluetooth Specification 2.0 supporting the following profiles: Dial Up Networking, Serial Port, File Transfer, Handsfree, Headset, Basic Imaging, SIM Access, Generic Access, and Advanced Audio Distribution. To ensure interoperability between other devices supporting Bluetooth technology, use Nokia approved enhancements for this model. Check with the manufacturers of other devices to determine their compatibility with this device.

There may be restrictions on using Bluetooth technology in some locations. Check with your local authorities or service provider.

Features using Bluetooth technology, or allowing such features to run in the background while using other features, increase the demand on battery power and reduce the battery life.

Bluetooth connection settings

Select [Menu](#) > [Settings](#) > [Connectivity](#) > [Bluetooth](#).

When you activate Bluetooth technology for the first time, you are asked to give a name to your phone.

[Bluetooth](#)—to switch Bluetooth on or off.

[My phone's visibility](#) > [Shown to all](#)—to allow your phone to be found by other Bluetooth devices at all times. To allow your phone to be found for a defined time period, select [Define period](#). For security reasons it is advisable to use the [Hidden](#) setting whenever possible.

My phone's name—to define a name for your phone.

Remote SIM mode > *On*—to enable the usage of the SIM card of the phone by another device (for example, a car kit) by Bluetooth technology (SIM access profile)

When the wireless device is in the remote SIM mode, you can only use a compatible connected enhancement, such as a car kit, to make or receive calls. Your wireless device will not make any calls, except to the emergency numbers programmed into your device, while in this mode. To make calls from your device, you must first leave the remote SIM mode. If the device has been locked, enter the lock code to unlock it first.

Send data

There can be only one active Bluetooth connection at a time.

1. Open an application where the item you wish to send is saved.
2. Scroll to the item you want to send, and select **Options** > *Send* > *Via Bluetooth*.
3. The phone starts to search for devices within range. Paired devices are shown with .

When searching for devices, some devices may show only the unique device addresses. To find out the unique address of your phone, enter the code ***#2820#** in the standby mode.

If you have searched for devices earlier, a list of the devices that were found previously is shown first. To start a new search, select *More devices*. If you switch off the phone, the list of devices is cleared, and the device search needs to be started again before sending data.

4. Select the device with which you want to connect.
5. Pair the devices
 - If the other device requires pairing before data can be transmitted, a tone sounds and you are asked to enter a passcode.
 - Create your own passcode (1–16 digits) and agree with the owner of the other device to use the same code. You do not have to memorize the passcode.
 - After pairing, the device is saved to the *Paired devices* view.
6. When the connection has been successfully established, the note *Sending data* is displayed.

Data received using Bluetooth connection can be found in *Inbox* in *Messaging*.

Paired devices view

Paired devices are indicated by  in the search result list. In the Bluetooth main view, scroll right to open a list of paired devices.

Do not accept Bluetooth connections from sources you do not trust.

To pair with a device, select **Options** > *New paired device*. Select the device with which to pair. Exchange passcodes.

To cancel pairing, scroll to the device whose pairing you want to cancel, and press the clear key. If you want to cancel all pairings, select **Options** > *Delete all*.

To set a device to be authorized, scroll to the device, and select **Options** > *Set as authorised*. Connections between your phone and the authorized device can be made without your knowledge. No separate acceptance or authorization is needed. Use this status only for your own devices to which others do not have access, for example, your PC or devices that belong to someone you trust.  is added next to authorized devices in the *Paired devices* view. If you select *Set as unauthorised*, each connection request from the device must be accepted separately.

Receive data

When you receive data using Bluetooth technology, a tone sounds, and you are asked if you want to accept the message. If you accept, the item is placed in *Inbox* in *Messaging*.

Disconnect Bluetooth connection

A Bluetooth connection is disconnected automatically after sending or receiving data.

■ Connection manager

In the connection manager, you can identify the status of multiple data connections, view details on the amount of data sent and received, and end unused connections.

Select **Menu** > *Settings* > *Connectivity* > *Conn. mgr.*



Note: The actual invoice for calls and services from your service provider may vary, depending on network features, rounding off for billing, taxes, and so forth.

To view connection details, scroll to a connection, and select **Options** > *Details*.

To end a connection, scroll to the connection, and select [Options](#) > [Disconnect](#). To end all connections, select [Options](#) > [Disconnect all](#).

■ Push to talk

Push to talk (PTT) (network service) is a real-time voice over IP service (network service) available over a GSM/GPRS network. PTT provides direct voice communication connected with a single keypress.

Before you can use the PTT service, you must define the PTT access point and PTT settings.

In PTT communication, one person talks while the others listen. Speakers take turns responding to each other. Only one group member can talk at a time. The length of time of each turn is limited.

Phone calls always take priority over PTT calls.

Besides the packet data counters, the phone registers only one-to-one calls in the recent calls lists in [Log](#). The participants should confirm the reception of any communications where appropriate as there is no other confirmation of whether the recipients have heard the call.

To check availability and costs, and to subscribe to the service, contact your service provider. Note that roaming services may be more limited than home network services.

Many of the services available for traditional voice calls (for example, call mailbox) are not available for PTT communications.

Define a PTT access point

Many service providers require you to use an internet access point for your default access point. Other service providers allow you to use a WAP access point.

Settings for PTT

For PTT service settings, contact your service provider.

To view and change PTT settings, select [Menu](#) > [Settings](#) > [Connectivity](#) > [PTT](#) > [Options](#) > [Settings](#) > [User settings](#) or [Connection settings](#).

User settings

Accepted list calls—To see a notification of incoming calls, select *Notify*. To answer PTT calls automatically, select *Auto-accept*. If you do not want to receive PTT calls, select *Not allowed*.

PTT call alert tone—Select the tone for incoming PTT calls. If you want the incoming call alert setting for PTT to follow your profile settings, select *Set by profile*. For example, if your profile is silent, PTT is set to do not disturb (DND) and, except for callback requests, you are not available to others using PTT.

Callback request tone—Select a tone for callback requests.

Application start-up—To start PTT automatically, select *Always automatic*. To start PTT automatically only while in your home network, select *Auto. in home netw.*

Default nickname—Enter your nickname shown to other users. Your service provider may have disabled the editing of this option.

Show my PTT address—Select *Never* if you want to hide your PTT address from others.

Show my login status—Select whether your status is shown to others.

Connection settings

Contact your PTT service provider for the connection settings.

Log in to PTT

Select **Menu** > **Settings** > **Connectivity** > **PTT**. PTT automatically logs in to the service when started.

When log in is successful, PTT automatically connects to channels that were active when the application was last closed. If the connection is lost, the device automatically tries to log back in until you exit PTT.

 indicates a PTT connection.

 indicates that PTT is set to do not disturb (DND).

Exit PTT

Select **Menu** > **Settings** > **Connectivity** > **PTT** > **Options** > **Exit**. *Log out from PTT after exiting application?* is displayed. Select *Yes* to log out and close the service. If you want to keep the application active in the background, select *No*.

Make a one-to-one call



Warning: Do not hold the device near your ear when the loudspeaker is in use, because the volume may be extremely loud.

1. Select **Menu** > **Settings** > **Connectivity** > **PTT** > **Options** > **Contacts**, scroll to the contact you want to talk to, and press the call key.
2. When the connection has been established, to talk to the other participant, press and hold the call key while you talk.
3. To end the PTT call, select **Disconnect**, or if there are several PTT calls, select **Options** > **Disconnect**.

Answer a PTT call

If **Accepted list calls** is set to **Notify** in **User settings**, a short tone notifies you of an incoming call. To accept the call, select **Accept**. To silence the tone, select **Silence**. To reject the call, press the end key.

Make a PTT group call

To call a group, select **Options** > **Contacts**, select **Options** > **Talk to many**, mark the contacts you want to call, and press the call key.

Callback requests

Send a callback request

If you make a one-to-one call and do not get a response, you can send a request for the person to call you back.

To send a callback request from **Contacts**, scroll to a contact, and select **Options** > **Send callback request**.

Respond to a callback request

When someone sends you a callback request, **1 new callback request** is displayed in the standby mode. Select **Show** to open **Callback inbox**. Scroll to a contact, and press the call key.

Channels

When you are connected to a channel, all members joined to the channel hear you talking. Up to five channels can be active at the same time. When more than one channel is active, select **Swap** to change the channel you want to talk to.

Channels are registered with a URL address. One user registers the channel URL in the network by joining the channel the first time.

Create your own channel

1. Select **Options** > *PTT channels*.
2. Select **Options** > *New channel* > *Create new*.
3. Enter a *Channel name*.
4. Select a *Channel privacy* level.
5. Enter your own nickname in *Nickname*.
6. If you want to add a thumbnail image to the group, select *Thumbnail* and an image.
7. Select **Done**. When you have created a channel, you are asked if you want to send channel invitations. Channel invitations are text messages.

Join a preconfigured channel

A preconfigured channel is a talk group that is set up by your service provider. Only preconfigured users are allowed to join and use the channel.

1. Select **Options** > *PTT channels*.
2. Select **Options** > *New channel* > *Add existing*.
3. Enter the *Channel name*, *Channel address*, and *Nickname*. You can also add a *Thumbnail*.
4. Select **Done**.

Respond to a channel invitation

To save a received channel invitation, select **Options** > *Save channel*. The channel is added to your PTT contacts, channels view.

PTT sessions

PTT sessions are displayed as call bubbles in the PTT display, giving information about the status of the PTT sessions:

Wait—shown when you press and hold the call key and somebody else is still speaking in the PTT session

Talk—shown when you press and hold the call key and get the permission to speak

To switch the loudspeaker on or off, select **Options** > *Activate loudspeaker* or *Deactivate loudspeaker*.

To disconnect the selected PTT session, select **Options** > **Disconnect**.

■ Remote synchronization

Sync enables you to synchronize your calendar, contacts, or notes with various calendar and address book applications on a compatible computer or on the internet. The synchronization application uses SyncML technology for synchronization.

Select **Menu** > **Settings** > **Connectivity** > **Sync**.

Create a new synchronization profile

1. If no profiles have been defined, the phone asks you if you want to create a new profile. Select **Yes**.

To create a new profile in addition to existing ones, select **Options** > **New sync profile**. Choose whether you want to use the default setting values or copy the values from an existing profile to be used as the basis for the new profile.

2. Define the **Applications** to be synchronized.

Select an application, and edit the synchronization settings:

Include in sync—to enable or disable the synchronization

Remote database—the name of the used remote database

Synchronisation type—Select **Both ways** for synchronization of the data on your phone and the remote database, **To phone only** for the synchronization of the data on your phone only, or **To server only** for the synchronization of the data on the remote database only.

3. Define the **Connection settings** :

Server version, **Server ID**, **Data bearer**, **Host address**, **Port**, **User name**, and **Password**—Contact your service provider or system administrator for the correct settings.

Access point—Only visible if **Internet** is selected as **Data bearer**. Select an access point you want to use for the data connection.

Allow sync requests > **Yes**—to allow that the server starts the synchronization

Accept all sync requests > **No**—to require a confirmation before the server starts the synchronization

Network authentication—Only visible if *Internet* is selected as *Data bearer*. To use HTTPS authentication, select *Yes*, and enter user name and password in *Network user name* and *Network password*.

Synchronize data

In the main view, scroll to a profile, and select **Options** > *Synchronise*. The status of the synchronization is shown.

After synchronization is complete, select **Options** > *View log* to open a log file showing the synchronization status (*Complete* or *Incomplete*) and how many calendar or contact entries have been added, updated, deleted, or discarded (not synchronized) in the phone or on the server.

■ Infrared

Use infrared to connect two devices and transfer data between them. With infrared, you can transfer data such as business cards, calendar notes, and media files with a compatible device.

Do not point the infrared (IR) beam at anyone's eye or allow it to interfere with other IR devices. This device is a Class 1 Laser product.

Send and receive data

1. Ensure that the infrared ports of the devices face each other. The positioning of the devices is more important than angle or distance.
2. To turn on infrared on your device, select **Menu** > *Settings* > *Connectivity* > *Infrared*. Turn on infrared on the other device. Wait a few seconds until an infrared connection is established.
3. To send, locate the desired file in an application or the file manager, and select **Options** > *Send* > *Via infrared*.

If data transfer is not started soon after the activation of the infrared port, the connection is cancelled and must be started again.

All items received through infrared are placed in the *Inbox* folder in *Messaging*.

■ Modem

Before you can use your phone as a modem:

- Acquire the appropriate data communications software for your computer.

- Subscribe to the appropriate network services from your service provider or internet service provider.
- Install the appropriate drivers on your computer.

Select [Menu](#) > [Settings](#) > [Connectivity](#) > [Modem](#).

To connect the phone to a compatible computer using infrared, press the scroll key. Make sure the infrared ports of the phone and computer are directly facing each other with no obstacles between them.

To connect your phone to a computer using Bluetooth wireless technology, initiate the connection from the computer. To activate Bluetooth in your phone, select [Menu](#) > [Connectivity](#) > [Bluetooth](#) > [Bluetooth](#) > [On](#).

If you use a cable to connect your phone to a computer, initiate the connection from the computer.

Note that you may not be able to use some of the other communication features when the phone is used as a modem.

■ USB data cable

You can use the USB data cable to transfer data between the phone and a compatible PC. You can also use the USB data cable with Nokia PC Suite.

Select [Menu](#) > [Settings](#) > [Connectivity](#) > [USB](#). To select the default USB connection mode, select [USB mode](#) and the desired mode. To have the device ask the purpose of the connection each time the cable is connected, select [Ask on connection](#) > [Yes](#).

To use the phone with Nokia PC Suite, select [PC Suite](#). To synchronize media files, such as music, with a compatible version of Windows Media Player, select [Media player](#). To access files on the inserted memory card as a removable drive, select [Data transfer](#).

After transferring data, ensure that it is safe to unplug the USB data cable from the PC.

■ Data transfer

With data transfer you can copy or synchronize contacts, calendar entries, and possibly other data, such as video clips and images, from a compatible phone using a Bluetooth or infrared connection. When both Bluetooth and infrared are available on both devices, it is preferable to use Bluetooth.

Depending on the other phone, synchronization may not be possible and data can be copied only once.

To transfer or synchronize data, do the following:

1. When using infrared, place the devices so that the infrared ports face each other, and activate infrared on both devices.

Select **Menu** > **Settings** > **Connectivity** > **Transfer**. If you have not used **Transfer** before, information about the application is displayed. Select **Continue** to start transferring data.

If you have used **Transfer**, select **Transfer data**.

2. Select whether to use Bluetooth or infrared for transferring the data. When using Bluetooth, the phones need to be paired in order to transfer data.

Depending on the type of the other phone, an application may be sent and installed on the other phone to enable the data transfer. Follow the instructions.

3. Select what content you want to be transferred to your phone.
4. Content is transferred to your phone. The transfer time depends on the amount of data. You can stop the transfer and continue later.

16. Data manager

■ Application manager

You can install two types of applications and software to your phone:



J2ME™ applications based on Java™ technology with the extension .jad or .jar. PersonalJava™ applications cannot be installed on your phone.



Other applications and software suitable for the Symbian operating system. The installation files have the .sis extension. Only install software specifically designed for your phone.

Installation files may be transferred to your phone from a compatible computer, downloaded during browsing, or sent to you in a multimedia message, as an e-mail attachment or by using Bluetooth. You can use Nokia Application Installer in Nokia PC Suite to install an application to your phone or a memory card.

To open **App. manager**, select **Menu** > **Settings** > **Data mgr.** > **App. mgr.**

Install an application



Important: Only install and use applications and other software from trusted sources, such as applications that are Symbian Signed or have passed the Java Verified™ testing.

Before installation, in *App. manager*, scroll to the installation file, and select **Options** > *View details* to view information such as the application type, version number, and the supplier or manufacturer of the application.

The .jar file is required for installing Java applications. If it is missing, the phone may ask you to download it.

To install an application or software package:

1. Scroll to an installation file. Applications on the memory card are indicated with .
2. Select **Options** > *Install*.

Alternatively, search the phone memory or the memory card, select the application, and press the scroll key to start the installation.

During the installation, the phone shows information about the progress of the installation. If you are installing an application without a digital signature or certification, the phone displays a warning. Continue installation only if you are sure of the origins and contents of the application.

To view extra information about the application, scroll to it, and select **Options** > *Go to web address*. This option may not be available with all applications.

To see what software packages have been installed or removed and when, select **Options** > *View log*.

Remove an application

In the *App. manager* main view, scroll to the software package, and select **Options** > *Remove*.

Application manager settings

In *App. manager*, select **Options** > *Settings* and from the following settings:

Software installation—to select if you want to allow installation of all Symbian applications (*All*) or only signed applications (*Signed only*)

Online certificate check—to select if you want *App. manager* to check the online certificates for an application before installing it

Default web address—default address used when checking online certificates

Java applications may attempt to, for example, establish a data connection or send a message. To edit the permissions of an installed Java application and define which access point the application will use, in the main view, scroll to the application, and select **Options** > *Open*.

■ File manager

In the file manager, you can browse, open, and manage files and folders in the phone memory or on the memory card.

To see a list of the folders in the phone memory, select **Menu** > *Settings* > *Data mgr.* > *File mgr.* Scroll right to see the folders on the memory card.

View memory consumption

Scroll either right or left to view the phone memory or the memory card contents. To check memory consumption of the current memory, select **Options** > *Memory details*. The phone calculates the approximate amount of free memory for storing data and installing new applications.

In the memory views, you can view the memory consumption of the different applications or file types. If the phone memory is getting low, remove some files, or move them to the memory card.

■ Device manager

You may receive server profiles and configuration settings from your service provider or company information management department.

To open the device manager, select **Menu** > *Settings* > *Data mgr.* > *Device mgr.* If you have no server profiles defined, the phone asks whether you want to define one.

To connect to a server and receive configuration settings for your phone, scroll to the server profile, and select **Options** > *Start configuration*.

To edit a server profile, select **Options** > *Edit profile* and from the following settings:

Allow configuration—To receive configuration settings from the server, select *Yes*.

Auto-accept all requests—If you want the phone to ask for confirmation before accepting a configuration from the server, select *No*.

Contact your service provider, or company information management department for the other server profile settings.

■ Memory card

Keep all memory cards out of the reach of small children.

Select [Menu](#) > [Settings](#) > [Data mgr.](#) > [Memory](#).

For details on inserting a memory card into the phone, see "Get started," p. 10. You can use it to store your multimedia files such as video clips, music tracks, and sound files, photos, and messaging data, and to back up information from phone memory.

Format the memory card

When a memory card is formatted, all data on the card is permanently lost. Some memory cards are supplied preformatted and others require formatting.

1. Select [Options](#) > [Format memory card](#).
2. Select [Yes](#) to confirm.
3. When formatting is complete, enter a name for the memory card.

Back up and restore information

To back up information from phone memory to the memory card, select [Options](#) > [Back up phone memory](#).

To restore information from the memory card to the phone memory, select [Options](#) > [Restore from card](#).

You can only back up the phone memory and restore it to the same phone.

Lock the memory card

To set a password to help prevent unauthorized use, select [Options](#) > [Set password](#). You are asked to enter and confirm your password. The password can be up to eight characters long.

Unlock a memory card

If you insert another password-protected memory card into your phone, you are prompted to enter the password of the card. To unlock the card, select [Options](#) > [Unlock memory card](#).

Check memory consumption

To check the memory consumption and the amount of memory available on your memory card, select [Options](#) > [Memory details](#).

■ Activation keys

Digital rights management

Content owners may use different types of digital rights management (DRM) technologies to protect their intellectual property, including copyrights. This device uses various types of DRM software to access DRM-protected content. With this device you can access content protected with WMDRM 10, OMA DRM 2.0 and OMA DRM 1.0. If certain DRM software fails to protect the content, content owners may ask that such DRM software's ability to access new DRM-protected content be revoked. Revocation may also prevent renewal of such DRM-protected content already in your device. Revocation of such DRM software does not affect the use of content protected with other types of DRM or the use of non-DRM-protected content.

Digital rights management (DRM) protected content comes with an associated activation key that defines your rights to use the content.

If your device has OMA DRM protected content, to back up both the activation keys and the content, use the backup feature of Nokia PC Suite. Other transfer methods may not transfer the activation keys which need to be restored with the content for you to be able to continue the use of OMA DRM protected content after the device memory is formatted. You may also need to restore the activation keys in case the files on your device get corrupted.

If your device has WMDRM protected content, both the activation keys and the content will be lost if the device memory is formatted. You may also lose the activation keys and the content in case the files on your device get corrupted. Losing the activation keys or the content may limit your ability to use the same content on your device again. For more information, contact your service provider.

Some activation keys may be connected to a specific SIM card, and the protected content can be accessed only if the SIM card is inserted in the device.

Select [Menu](#) > [Settings](#) > [Data mgr.](#) > [Actv. keys](#) to view the digital rights activation keys saved in your phone.

To view valid keys (🔑) that are connected to one or more media files, select [Valid keys](#). Group keys, which contain several keys, are indicated with . To view the keys contained in the group key, select the group key.

To view invalid keys (🔒) with which the time period for using the file is exceeded, select [Invalid keys](#). To buy more usage time or extend the usage period for a media file, scroll to a key, and select [Options](#) > [Get activation key](#). It may not be possible

to update activation keys if web service message reception is disabled. See "Service message settings," p. 39.

To view activation keys that are not in use, select *Not in use*. Unused activation keys have no media files connected to them.

To view detailed information such as the validity status and the ability to send the file, scroll to an activation key, and select it.

17. Battery information

■ Charging and discharging

Your device is powered by a rechargeable battery. The battery can be charged and discharged hundreds of times, but it will eventually wear out. When the talk and standby times are noticeably shorter than normal, replace the battery. Use only Nokia approved batteries, and recharge your battery only with Nokia approved chargers designated for this device.

The full performance of a new battery is achieved only after two or three complete charge and discharge cycles.

If a replacement battery is being used for the first time or if the battery has not been used for a prolonged period, it may be necessary to connect the charger, then disconnect and reconnect it to begin charging the battery.

Unplug the charger from the electrical plug and the device when not in use. Do not leave a fully charged battery connected to a charger, since overcharging may shorten its lifetime. If left unused, a fully charged battery will lose its charge over time.

If the battery is completely discharged, it may take several minutes before the charging indicator appears on the display or before any calls can be made.

Use the battery only for its intended purpose. Never use any charger or battery that is damaged.

Do not short-circuit the battery. Accidental short-circuiting can occur when a metallic object such as a coin, clip, or pen causes direct connection of the positive (+) and negative (-) terminals of the battery. (These look like metal strips on the battery.) This might happen, for example, when you carry a spare battery in your pocket or purse. Short-circuiting the terminals may damage the battery or the connecting object.

Leaving the battery in hot or cold places, such as in a closed car in summer or winter conditions, will reduce the capacity and lifetime of the battery. Always try to keep the battery between 15°C and 25°C (59°F and 77°F). A device with a hot or cold battery may not

work temporarily, even when the battery is fully charged. Battery performance is particularly limited in temperatures well below freezing.

Do not dispose of batteries in a fire as they may explode. Batteries may also explode if damaged. Dispose of batteries according to local regulations. Please recycle when possible. Do not dispose as household waste.

Do not dismantle or shred cells or batteries. In the event of a battery leak, do not allow the liquid to come in contact with the skin or eyes. In the event of such a leak, flush your skin or eyes immediately with water, or seek medical help.

■ Nokia battery authentication guidelines

Always use original Nokia batteries for your safety. To check that you are getting an original Nokia battery, purchase it from an authorized Nokia dealer, look for the Nokia Original Enhancements logo on the packaging, and inspect the hologram label using the following steps:

Successful completion of the four steps is not a total assurance of the authenticity of the battery. If you have any reason to believe that your battery is not an authentic, original Nokia battery, you should refrain from using it, and take it to the nearest authorized Nokia service point or dealer for assistance. Your authorized Nokia service point or dealer will inspect the battery for authenticity. If authenticity cannot be verified, return the battery to the place of purchase.

Authenticate hologram

1. When looking at the hologram on the label, you should see the Nokia connecting hands symbol from one angle and the Nokia Original Enhancements logo when looking from another angle.
2. When you angle the hologram left, right, down, and up, you should see 1, 2, 3, and 4 dots on each side respectively.



3. Scratch the side of the label to reveal a 20-digit code, for example, 12345678919876543210. Turn the battery so that the numbers are facing upwards. The 20-digit code reads starting from the number at the top row followed by the bottom row.

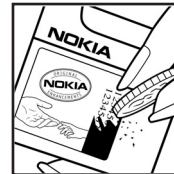

4. Confirm that the 20-digit code is valid by following the instructions at www.nokia.com/batterycheck.

To create a text message, enter the 20-digit code, for example, 12345678919876543210, and send to +44 7786 200276.

National and international operator charges will apply.

You should receive a message indicating whether the code can be authenticated.



What if your battery is not authentic?

If you cannot confirm that your Nokia battery with the hologram on the label is an authentic Nokia battery, please do not use the battery. Take it to the nearest authorized Nokia service point or dealer for assistance. The use of a battery that is not approved by the manufacturer may be dangerous and may result in poor performance and damage to your device and its enhancements. It may also invalidate any approval or warranty applying to the device.

To find out more about original Nokia batteries, visit www.nokia.com/battery.

18. Enhancements

Practical rules about accessories and enhancements

- Keep all accessories and enhancements out of the reach of small children.
- When you disconnect the power cord of any accessory or enhancement, grasp and pull the plug, not the cord.
- Check regularly that enhancements installed in a vehicle are mounted and are operating properly.
- Installation of any complex car enhancements must be made by qualified personnel only.

Care and maintenance

Your device is a product of superior design and craftsmanship and should be treated with care. The following suggestions will help you protect your warranty coverage.

- Keep the device dry. Precipitation, humidity, and all types of liquids or moisture can contain minerals that will corrode electronic circuits. If your device does get wet, remove the battery, and allow the device to dry completely before replacing it.
- Do not use or store the device in dusty, dirty areas. Its moving parts and electronic components can be damaged.
- Do not store the device in hot areas. High temperatures can shorten the life of electronic devices, damage batteries, and warp or melt certain plastics.
- Do not store the device in cold areas. When the device returns to its normal temperature, moisture can form inside the device and damage electronic circuit boards.
- Do not attempt to open the device other than as instructed in this guide.
- Do not drop, knock, or shake the device. Rough handling can break internal circuit boards and fine mechanics.
- Do not use harsh chemicals, cleaning solvents, or strong detergents to clean the device.
- Do not paint the device. Paint can clog the moving parts and prevent proper operation.
- Use a soft, clean, dry cloth to clean any lenses, such as camera, proximity sensor, and light sensor lenses.
- Use only the supplied or an approved replacement antenna. Unauthorized antennas, modifications, or attachments could damage the device and may violate regulations governing radio devices.
- Use chargers indoors.
- Always create a backup of data you want to keep, such as contacts and calendar notes.
- To reset the device from time to time for optimum performance, power off the device and remove the battery.

These suggestions apply equally to your device, battery, charger, or any enhancement. If any device is not working properly, take it to the nearest authorized service facility for service.



Disposal

The crossed-out wheeled-bin symbol on your product, literature, or packaging reminds you that in the European Union all electrical and electronic products, batteries, and accumulators must be taken to separate collection at the end of their working life. Do not dispose of these products as unsorted municipal waste.

Return the products to collection to prevent possible harm to the environment or human health from uncontrolled waste disposal and to promote the sustainable reuse of material resources. Collection information is available from the product retailer, local waste authorities, national producer responsibility organizations, or your local Nokia representative. For more information, see product Eco-Declaration or country-specific information at www.nokia.com.

Additional safety information

■ Small children

Your device and its enhancements may contain small parts. Keep them out of the reach of small children.

■ Operating environment

This device meets RF exposure guidelines when used either in the normal use position against the ear or when positioned at least 2.2 centimeters (7/8 inches) away from the body. When a carry case, belt clip, or holder is used for body-worn operation, it should not contain metal and should position the device the above-stated distance from your body. To transmit data files or messages, this device requires a quality connection to the network. In some cases, transmission of data files or messages may be delayed until such a connection is available. Ensure the above separation distance instructions are followed until the transmission is completed.

Parts of the device are magnetic. Metallic materials may be attracted to the device. Do not place credit cards or other magnetic storage media near the device, because information stored on them may be erased.

■ Medical devices

Operation of any radio transmitting equipment, including wireless phones, may interfere with the functionality of inadequately protected medical devices. Consult a physician or the manufacturer of the medical device to determine if they are adequately shielded from external RF energy or if you have any questions. Switch off your device in health care facilities when any regulations posted in these areas instruct you to do so. Hospitals or health care facilities may be using equipment that could be sensitive to external RF energy.

Implanted medical devices

Manufacturers of medical devices recommend that a minimum separation of 15.3 centimeters (6 inches) should be maintained between a wireless device and an implanted medical device, such as a pacemaker or implanted cardioverter defibrillator, to avoid potential interference with the medical device. Persons who have such devices should:

- Always keep the wireless device more than 15.3 centimeters (6 inches) from the medical device when the wireless device is turned on.
- Not carry the wireless device in a breast pocket.
- Hold the wireless device to the ear opposite the medical device to minimize the potential for interference.
- Turn the wireless device off immediately if there is any reason to suspect that interference is taking place.

- Read and follow the directions from the manufacturer of their implanted medical device.

If you have any questions about using your wireless device with an implanted medical device, consult your health care provider.

Hearing aids

Some digital wireless devices may interfere with some hearing aids. If interference occurs, consult your service provider.

■ Vehicles

RF signals may affect improperly installed or inadequately shielded electronic systems in motor vehicles such as electronic fuel injection systems, electronic antiskid (antilock) braking systems, electronic speed control systems, and air bag systems. For more information, check with the manufacturer, or its representative, of your vehicle or any equipment that has been added.

Only qualified personnel should service the device or install the device in a vehicle. Faulty installation or service may be dangerous and may invalidate any warranty that may apply to the device. Check regularly that all wireless device equipment in your vehicle is mounted and operating properly. Do not store or carry flammable liquids, gases, or explosive materials in the same compartment as the device, its parts, or enhancements. For vehicles equipped with an air bag, remember that air bags inflate with great force. Do not place objects, including installed or portable wireless equipment in the area over the air bag or in the air bag deployment area. If in-vehicle wireless equipment is improperly installed and the air bag inflates, serious injury could result.

Using your device while flying in aircraft is prohibited. Switch off your device before boarding an aircraft. The use of wireless teledevices in an aircraft may be dangerous to the operation of the aircraft, disrupt the wireless telephone network, and may be illegal.

■ Potentially explosive environments

Switch off your device when in any area with a potentially explosive atmosphere, and obey all signs and instructions. Potentially explosive atmospheres include areas where you would normally be advised to turn off your vehicle engine. Sparks in such areas could cause an explosion or fire resulting in bodily injury or even death. Switch off the device at refueling points such as near gas pumps at service stations. Observe restrictions on the use of radio equipment in fuel depots, storage, and distribution areas; chemical plants; or where blasting operations are in progress. Areas with a potentially explosive atmosphere are often, but not always, clearly marked. They include below deck on boats, chemical transfer or storage facilities, vehicles using liquefied petroleum gas (such as propane or butane), and areas where the air contains chemicals or particles such as grain, dust, or metal powders.

■ Emergency calls



Important: Wireless phones, including this device, operate using radio signals, wireless networks, landline networks, and user-programmed functions. Because of this, connections in all conditions cannot be guaranteed. You should never rely solely on any wireless device for essential communications like medical emergencies.

To make an emergency call:

1. If the device is not on, switch it on. Check for adequate signal strength.
Some networks may require that a valid SIM card is properly inserted in the device.
2. Press the end key as many times as needed to clear the display and ready the device for calls.
3. Enter the official emergency number for your present location. Emergency numbers vary by location.
4. Press the call key.

If certain features are in use, you may first need to turn those features off before you can make an emergency call. If the device is in the offline profile mode, you may need to change the profile to activate the phone function before you can make an emergency call. Consult this guide or your service provider for more information.

When making an emergency call, give all the necessary information as accurately as possible. Your wireless device may be the only means of communication at the scene of an accident. Do not end the call until given permission to do so.

■ Certification information (SAR)

THIS MOBILE DEVICE MEETS GUIDELINES FOR EXPOSURE TO RADIO WAVES.

Your mobile device is a radio transmitter and receiver. It is designed not to exceed the limits for exposure to radio waves recommended by international guidelines. These guidelines were developed by the independent scientific organization ICNIRP and include safety margins designed to assure the protection of all persons, regardless of age and health.

The exposure guidelines for mobile devices employ a unit of measurement known as the Specific Absorption Rate or SAR. The SAR limit stated in the ICNIRP guidelines is 2.0 watts/kilogram (W/kg) averaged over 10 grams of tissue. Tests for SAR are conducted using standard operating positions with the device transmitting at its highest certified power level in all tested frequency bands. The actual SAR level of an operating device can be below the maximum value because the device is designed to use only the power required to reach the network. That amount changes depending on a number of factors such as how close you are to a network base station. The highest SAR value under the ICNIRP guidelines for use of the device at the ear is 1.24 W/kg.

Use of device accessories and enhancements may result in different SAR values. SAR values may vary depending on national reporting and testing requirements and the network band. Additional SAR information may be provided under product information at www.nokia.com.

Index

NUMERICS

3-D tones 59

A

access codes

- barring password 9
- change 73
- lock code 8, 13
- module PIN 9
- PIN 8, 13
- PIN2 8
- PUK 9
- PUK2 9
- signing PIN 9
- UPIN 8
- UPUK 9

access points 78

activation keys 98

active standby 16

alarm clock. See clock.

application manager 94

applications 94

B

battery

- charging 12

Bluetooth

- connection settings 84
- disconnecting 86
- paired devices 86
- receiving data 86
- sending data 85

bookmarks 61

browser. See web.

C

cache 64

calculator 68

calendar 66

call register. See log.

callback requests 88, 89

calls

- answering 23
- barring 77

conference call 23

diverting 77

ending 22

international 21

making 21

options during a call 24

rejecting 23

rejecting with SMS 24

speed dial 22, 42

swapping 24

voice dial 22

voice mailbox 22

waiting 24

camera 52

camera mode 15

certificates 74

clock 65

connection manager 86

connectivity 84

contacts 40

converter 68

copyright protection. See activation keys.

D

data cable 93

data connection indicators 17

data transfer 93

device manager 96

digital rights management. See activation keys.

downloading 63

E

editing videos 44

e-mail

mailbox 34

settings 33

e-mail messages

deleting 35

retrieving 34

enhancements 73

F

file manager 96

Flash Player 57

functional modes 15

G

gallery 42
transferring videos 45
GPS data 70

H

help 20

I

IM. See instant messaging.
indicators 17
infrared 92
instant messaging
connecting 81
contacts 83
conversation 82
groups 82, 83
settings 81

K

keyguard. See keypad lock.
keypad lock 20

L

landmarks 70
listening to music 46
log 28

M

media player. See RealPlayer.
memory card 97
memory consumption
phone memory 96
menu 19
message settings
cell broadcast 39
e-mail 38
multimedia settings 37
other settings 40
service messages 39
text messages 36
messages
audio 32
cell broadcast 36
listening to 40
multimedia objects 33

organizing 34
outbox 31, 35
receiving 33
sending 31
service commands 36
service messages 34
SIM messages 36
special message types 33
writing 31

mobile browser. See web.
mobile search 60
modem 92
movies, muvees
custom muvees 54
quick muvees 54
music mode 16
music player
downloading music 47
music shop 47
playlists 47
transferring music 48
music. See music player.

N

network 78
notes 67

Ö

one-touch dial. See speed dial.

P

phone mode 15
phonebook. See contacts.
profiles 58
PTT. See push to talk.
push to talk 87–91

R

RealPlayer 57
recorder 56

S

services. See web.
settings
connection 78
data call 79
date 73
enhancements 73
packet data 79

- phone 71
- phone language 72
- predictive text input 72
- security 73
- Setting wizard 80
- speech 80
- time 73
- writing language 72
- SIM card
 - using phone without a SIM card 17
- songs
 - transferring 48
- speed dial
 - assigning a number 41, 71
 - calling 22
 - changing a number 71
 - deleting a number 71
- standby mode 16
- synchronization 91

T

- text input 72
 - copying text 30
 - deleting text 30
 - predictive 29
- themes 58
- to-do 67
- transferring music 48
- transferring videos 45
- tutorial 19

U

- USB. See data cable.

V

- video call 24, 25
- video call mode 16
- video view mode 16
- videos
 - transferring 45
- Visual Radio 49
- voice commands 70
- voice dialing 22
- voice mailbox 71
- voice recorder. See recorder.
- volume 20

W

- web
 - blogs 63
 - bookmarks 61
 - browser settings 64
 - browsing 62
 - connecting 61
 - connection security 61
 - disconnecting 64
 - feeds 63
 - saving a page 63
 - settings 60
 - viewing a saved page 63
- writing text. See text input.

Free Manuals Download Website

<http://myh66.com>

<http://usermanuals.us>

<http://www.somanuals.com>

<http://www.4manuals.cc>

<http://www.manual-lib.com>

<http://www.404manual.com>

<http://www.luxmanual.com>

<http://aubethermostatmanual.com>

Golf course search by state

<http://golfingnear.com>

Email search by domain

<http://emailbydomain.com>

Auto manuals search

<http://auto.somanuals.com>

TV manuals search

<http://tv.somanuals.com>