

# User's Guide for Nokia Image Frame SU-7

---

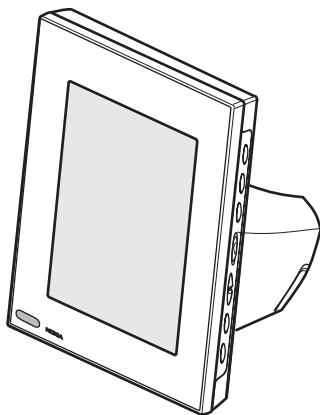

9311006  
Issue 1

## DECLARATION OF CONFORMITY

We, NOKIA CORPORATION, declare under our sole responsibility that the product SU-7 is in conformity with the provisions of the following Council Directive: 1999/5/EC.

A copy of the Declaration of Conformity can be found at [http://www.nokia.com/phones/declaration\\_of\\_conformity/](http://www.nokia.com/phones/declaration_of_conformity/).

# CE 168

Copyright © 2004 Nokia. All rights reserved.

Reproduction, transfer, distribution or storage of part or all of the contents in this document in any form without the prior written permission of Nokia is prohibited.

Nokia and Nokia Connecting People are trademarks or registered trademarks of Nokia Corporation. Other product and company names mentioned herein may be trademarks or tradenames of their respective owners.

Nokia operates a policy of continuous development. Nokia reserves the right to make changes and improvements to any of the products described in this document without prior notice.

Under no circumstances shall Nokia be responsible for any loss of data or income or any special, incidental, consequential or indirect damages howsoever caused.

The contents of this document are provided "as is". Except as required by applicable law, no warranties of any kind, either express or implied, including, but not limited to, the implied warranties of merchantability and fitness for a particular purpose, are made in relation to the accuracy, reliability or contents of this document. Nokia reserves the right to revise this document or withdraw it at any time without prior notice.

The availability of particular products may vary by region. Please check with the Nokia dealer nearest to you.

9311006/Issue 1

# Contents

---

<b>FOR YOUR SAFETY .....</b>	<b>4</b>	<b>3. Using the Nokia</b>	
<b>Introduction .....</b>	<b>6</b>	<b>Image Frame .....</b>	<b>16</b>
<b>Power supply .....</b>	<b>6</b>	<b>Viewing the images .....</b>	<b>16</b>
<b>Technical data.....</b>	<b>6</b>	<b>Editing the images .....</b>	<b>16</b>
<b>Image format .....</b>	<b>7</b>	<b>Switching the screensaver</b>	
<b>1. Overview.....</b>	<b>8</b>	<b>on and off.....</b>	<b>17</b>
<b>2. Getting started .....</b>	<b>11</b>	<b>Modifying the display</b>	
<b>Setting up the Nokia Image</b>		<b>brightness.....</b>	<b>18</b>
<b>Frame.....</b>	<b>11</b>	<b>Sending an image from the</b>	
<b>Switching the power on</b>		<b>Nokia Image Frame.....</b>	<b>18</b>
<b>and off .....</b>	<b>12</b>	<b>Receiving images with the</b>	
<b>Keying in the PIN code.....</b>	<b>13</b>	<b>Nokia Image Frame.....</b>	<b>18</b>
<b>Configuring the MMS</b>		<b>Receiving images over MMS</b>	
<b>settings .....</b>	<b>13</b>	<b>with the Nokia Image Frame....</b>	<b>20</b>
<b>OTA message .....</b>	<b>14</b>	<b>Care and maintenance .....</b>	<b>22</b>
<b>SMS messages.....</b>	<b>14</b>	<b>Important Safety Information</b>	<b>23</b>

## FOR YOUR SAFETY

---

Read these simple guidelines. Breaking the rules may be dangerous or illegal. Further detailed information is given in this manual.



Do not connect the Nokia Image Frame to the mobile network when wireless phone use is prohibited or when it may cause interference or danger.



### INTERFERENCE

All devices may get interference, which could affect performance.



### SWITCH OFF IN HOSPITALS

Follow any regulations or rules. Do not connect the Nokia Image Frame to the mobile network near medical equipment.



### SWITCH OFF WHEN REFUELLING

Do not connect the Nokia Image Frame to the mobile network at a refuelling point. Don't use near fuel or chemicals.



### SWITCH OFF NEAR BLASTING

Do not connect the Nokia Image Frame to the mobile network where blasting is in progress. Observe restrictions, and follow any regulations or rules.



### USE SENSIBLY

Use only in the normal position. Don't touch the antenna unnecessarily.



### QUALIFIED SERVICE

Only qualified personnel may install or repair the Nokia Image Frame equipment.



### CONNECTING TO OTHER DEVICES

When connecting to any other device, read its user's guide for detailed safety instructions. Do not connect incompatible products.



### BACKUP COPIES

Remember to make backup copies of all important data.



### WATER-RESISTANCE

Your Nokia Image Frame is not water-resistant. Keep it dry.

**IMPORTANT:**

Only use chargers in dry conditions. Never supply power to the device with a charger when the device or charger or their parts are damp or wet. If the device has been exposed to salt water, wipe it immediately with a cloth dampened with fresh water to avoid corrosion. The device must then be carefully wiped dry.

Do not point the IR (infrared) beam at anyone's eye or allow it to interfere with other IR devices. This device is a Class 1 Laser product.

## ■ Network Services

The Nokia Image Frame described in this guide is approved for use on the EGSM 900 and GSM1800 network.

A number of features included in this guide are called Network Services. These are special services that you arrange through your wireless service provider. Before you can take advantage of any of these Network Services, you must subscribe to them through your service provider and obtain instructions for their use from your service provider.



Note: Some networks may not support all language-dependent characters and/or services.

## Introduction

---

The Nokia Image Frame SU-7 is an enhancement product, which enables you to view the digital images taken or received by your IrDA-enabled Nokia phone or other compatible devices. You can connect the Nokia Image Frame to the devices using its infrared (IR) port. If you insert a SIM card to the Nokia Image Frame, you can also receive new images as MMS messages.

You can place the Nokia Image Frame on a table and view the images either one-by-one or as a slide show. The Nokia Image Frame comes supplied with three pre-loaded images, and you can conveniently add new images from a compatible device and delete old images.

Read this user's guide carefully before using the Nokia Image Frame.

### ■ Power supply

Check the model number of any charger used to supply power before use with this device. The Nokia Image Frame is intended for use with the ACW-5A charger.



**Warning!** Use only chargers approved by the manufacturer for use with this particular enhancement. The use of any other types will invalidate any approval or warranty applying to the enhancement, and may be dangerous.

For availability of approved chargers, please check with your dealer.

When you disconnect the power cord of any enhancement, grasp and pull the plug, not the cord.

### ■ Technical data

- Weight: 570 g
- Width (max) / height (max) / depth (max):  
170 mm / 129 mm / 123.0 mm
- Display: 5.1" transmissive backlit STN color LCD 320 x 240 horizontal orientation, 4096 colors. The image resolution in these materials may appear different.

- Operating temperature: 0 °C to 40 °C
- Compatibility: The Nokia Image Frame SU-7 is compatible with phones and other devices that support image sending over infrared (IrDA). Note that if image sending cannot be activated from the phone (IrDA Send feature), the Nokia Image Frame can pull the images from the compatible Nokia phone when the phone's IR connection has been activated. The Nokia Image Frame can also receive images over MMS from most MMS-enabled phones.
- IrDA standards: IrOBEX 1.3 receive/send, IrTranP receive
- Supported image format: JPEG and GIF (not animated GIF)
- Supported image size: max 1024 x 768, up to 200 kB. Due to different techniques of image processing, even up to 1 MB.

## ■ Image format

The Nokia Image Frame converts all the received images to JPEG format with the 320 x 240 pixel resolution. If the resolution of the received image differs from this resolution, the Nokia Image Frame scales the image so that it fits optimally on the display.

When you send images from the Nokia Image Frame, they are sent with the JPEG format, since the Nokia Image Frame does not store the original formats of the received images. You should therefore remember to make backup copies of your original images.

# 1. Overview

---

The Nokia Image Frame has the following parts:

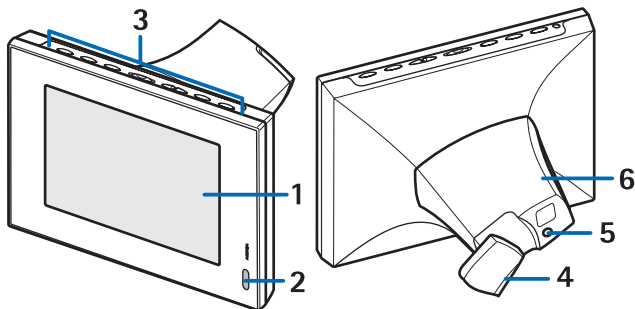

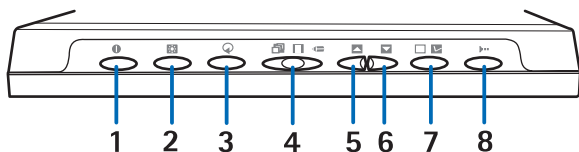

1. Display
2. Infrared (IR) port
3. Control keys
4. Table support
5. Charger connector
6. Back cover

You can use the Nokia Image Frame through the control keys on top of the device. The control keys are:



1. Power on/off key
2. Show/Brightness key
3. Rotation key



4. Three-position switch:
  - Slide show mode 
  - Image view mode 
  - Edit mode 
5. Up key
6. Down key
7. Mark key
8. IrDA key

There are three ways to press the keys. These are as follows:

- **Press briefly** - press a key for less than one second
- **Press** - press a key for at least one second
- **Press and hold** - press and hold down the key for at least three seconds

#### Indicators on the display



This indicator shows that the image has been marked for viewing.



The memory in the Nokia Image Frame is full, 50 images are stored in the Nokia Image Frame. If the memory becomes full in the middle of image transfer, the rest of the images are discarded.



The Nokia Image Frame is rotating the image 90° clockwise.



The Nokia Image Frame is switching to the next image.



The Nokia Image Frame is switching to the previous image.



Confirms that the image has been successfully deleted.



This indicator blinks when the Nokia Image Frame attempts to establish the IrDA connection. When the connection is established and the Nokia Image Frame is sending or receiving an image, the indicator is displayed continuously.



Confirms that the images have been successfully received or sent (the receiving device has confirmed the images as received).



The image is not supported by the Nokia Image Frame. It is, for example, too large or not in the compatible format.



An error occurred during the image transfer.



This indicator blinks when the Nokia Image Frame is downloading an incoming MMS message. When the message has been stored to the Nokia Image Frame, the indicator is displayed continuously until you check the message and either accept it or delete it.



The network connection has been established. When the connection has not been established, there is a / mark across the icon.



GPRS service is available. When the service is not available, there is a / mark across the icon.



This indicator shows how many images have been marked for viewing and how many images in total have been stored. The maximum number of stored images is 50.



The progress bar is shown while the Nokia Image Frame processes the received images.

## 2. Getting started

### ■ Setting up the Nokia Image Frame



**Warning!** To avoid damage to the SIM card, do not install, move or remove the SIM card if the power supply is connected to an AC wall outlet.

1. If you want to be able to receive images over MMS, you have to insert a SIM card into the Nokia Image Frame.

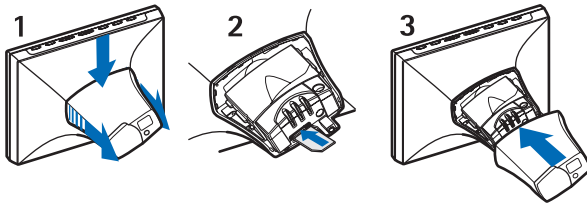

1. With the display of the Nokia Image Frame facing you, detach the cover on the back of the Nokia Image Frame by pushing it down forward.
2. Insert the SIM card to the SIM card holder so that the contact surface of the SIM card is up and the bevelled corner of the card is on the right and facing away from you.
3. Put the cover back on the Nokia Image Frame.

2. Connect the lead from the charger to the socket at the back of the Nokia Image Frame (1).

3. Connect the charger to an AC wall socket.

4. Set the Nokia Image Frame on the table with the control keys on the top. If most of your images are in the upright position, you can turn the Nokia Image Frame upright so that the control keys are on the right side of the display.

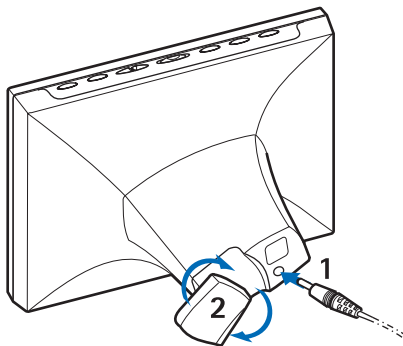

**Note:** All radio transmitting devices send signals that may cause interference in different electronic devices (PC, television, etc.). To avoid interference, place the Image Frame far enough from other electronic devices.

You can turn the table support at the back to change the position angle of the Nokia Image Frame (2).

## ■ Switching the power on and off

Press **1** to switch on the Nokia Image Frame.

Note that if the SIM card is inserted and you switch the Image Frame on, the Image Frame automatically connects to the mobile network. Do not switch the Image Frame on when the SIM card is inserted, if the use of mobile devices (such as mobile phones) is prohibited.

Press **1** to switch off the power.

Note that if the SIM card is full, it can take up to a minute before the Nokia Image Frame turns on and shows the first image.







Unplug the Nokia Image Frame when not in use.

## ■ Keying in the PIN code

If the PIN query is activated on the SIM card, the Nokia Image Frame displays the PIN query when the power is switched on.





**Note:** If you want to deactivate the PIN query, insert the SIM card to your phone and deactivate the PIN query as instructed in your phone's user guide.

1. Press briefly  or  until the correct first number of the PIN code is highlighted.
2. Press briefly   to select the number.  
The \* character appears on the display to indicate that the first number has been selected.
3. Select the rest of the numbers as in steps 1 and 2.
4. If the PIN code is correct, the Nokia Image Frame displays the  icon. If the PIN code is incorrect, the  icon is displayed, and you have to key in the PIN code again.

## ■ Configuring the MMS settings

If the MMS settings are preloaded to the Nokia Image Frame, you can skip this section unless you want to reconfigure the MMS settings. Check with your dealer if the MMS settings have been preloaded. If the settings are not preloaded and you want to receive images over MMS, you can configure the MMS settings by an over-the-air (OTA) message or SMS messages, as explained further below.

Note that many operators also offer a web-based OTA service for MMS settings. Check with your operator if this service is available.

If the configuration succeeds, the Nokia Image Frame displays the  icon. If the configuration fails, the  icon is displayed, and you have to send the configuration messages again.

## OTA message

You can configure the MMS settings by an OTA message if your operator offers that service.



**Note:** Before receiving the settings, set the Nokia Image Frame to the edit mode by sliding the three-position switch to .

Send a text message **91 <service\_number> <operator\_specific\_text>** from your mobile phone to the phone number of the SIM card you inserted to the Nokia Image Frame. For example, **91 12345 mms**. For the exact content of the message, contact your operator.

The Nokia Image Frame uses that message to send another message to the operator's OTA service. When the Nokia Image Frame receives a reply containing the settings, it stores them automatically.

## SMS messages

If your operator does not offer the OTA service, you can send the settings to the Nokia Image Frame yourself using SMS messages.



**Note:** Before sending the settings, set the Nokia Image Frame to the edit mode by sliding the three-position switch to .

You have to send the SMS commands listed below to the phone number of the SIM card you inserted to the Nokia Image Frame. For the exact values needed in the commands, contact your service provider.

- **31 <access\_point\_name>**  
Command for setting the GPRS access point name.
- **32 <URL\_address>**  
Command for setting the MMS Center address.
- **41 <username>**  
Command for setting the user name for the MMS connection.
- **42 <password>**  
Command for setting the password for the MMS connection.
- **33 <IP\_address>**  
Command for setting the gateway IP address.

- **27 <number>**  
Command for setting the SMS Center number.
- **43 <on\_or\_off>**  
Command for setting the password prompting on or off.
- **45 <on\_or\_off>**  
Command for setting the connection security on or off.
- **44 <1\_or\_2>**  
Command for setting the authentication method for the connection. The method is normal (1) or secure (2).
- **46 <1\_or\_2>**  
Command for setting the session mode. The mode is temporary (1) or permanent (2).
- **22 <on\_or\_off>**  
Command for activating or disactivating the PIN query.
- **99**  
Command for restoring the factory settings. The Nokia Image Frame has no MMS settings by default.
- **9**  
Command for checking the current settings. The Nokia Image Frame sends back the settings to the number from where the command was sent.

You can either send the commands one by one, or combine several commands in one message. If you combine the commands, you have to separate each command with a comma (no spaces). For example, **31 APN1,43 on,44 1**.

If you send any erroneous commands, you can send them again with the correct values. If the settings are correct but the Nokia Image Frame is not receiving images over MMS, contact your operator for troubleshooting.





## 3. Using the Nokia Image Frame

---

### ■ Viewing the images

If there is only one image in the Nokia Image Frame, it is displayed when you switch on the power. If there is more than one image in the Nokia Image Frame, you can set the Nokia Image Frame to show just one image, or several images in rotation as a slide show.

#### Setting Nokia Image Frame to show one image:

1. Slide the three position switch to .
2. Press briefly  or  to scroll through the images and select the image you want to view. If you press and hold  or , the images scroll automatically at 3-second intervals.

You can scroll through all the marked images. For more information about marking the images, see "Editing the images" on page 16.

#### Setting Nokia Image Frame to show the slide show:

- Slide the three position switch to .







The Nokia Image Frame displays all the marked images in rotation so that each image is shown for 30 seconds at a time. For more information about marking the images, see "Editing the images" on page 16.

### ■ Editing the images

When the power is switched on and the edit mode activated, you can delete the images and mark the images you want for viewing.









#### Deleting images:

Remember to make backup copies of your images by, for example, sending and saving them to another compatible device.

1. Slide the three position switch to .
2. Press briefly  or  until the Nokia Image Frame displays the image you want to delete.
3. Press and hold  and  until the  icon is displayed.



**Marking the images for viewing:**

1. Slide the three position switch to .
2. Press briefly  or  to scroll the images.
3. If you want to be able to view an image, mark it by pressing briefly   while the image is displayed. The Nokia Image Frame displays the  icon for all marked images. If you want to unmark an image, press briefly   while the marked image is displayed.



When the Nokia Image Frame receives new images, it automatically marks them. If you do not want to view the new images, unmark them as explained above.

**Rotating images:**

You can rotate the images both in the edit mode and when you are viewing the images.

When the image you want to rotate is displayed, press  to rotate the image 90° clockwise. The Nokia Image Frame stores the orientation of the image, and the next time the Nokia Image Frame displays the image, it uses the new orientation.



**■ Switching the screensaver on and off**

You can activate the screensaver, if you want to turn off the display without turning off the device. Press and hold  to activate the screensaver. If there are unchecked MMS images in the Nokia Image Frame, the  icon continues to be displayed even when the screensaver is activated. If a new MMS image is downloaded while the screensaver is on, the  icon appears on the screen.

You can turn the display back on by pressing any control key.





The Nokia Image Frame activates the screensaver automatically if no keys have been pressed for 18 hours.

## ■ Modifying the display brightness

When the power is switched on, you can modify the brightness of the display by pressing briefly . There are five brightness levels, and each time you press , the level is raised by one. When the highest brightness level is used and you press , the Nokia Image Frame returns to the lowest brightness level.

## ■ Sending an image from the Nokia Image Frame

When the power is switched on, select the image you want to send on the display of the Nokia Image Frame.





1. If needed, activate the IR port of the device to which you want to send an image.
2. Direct the IR ports of the Nokia Image Frame and the receiving compatible device toward each other, and ensure that there are no obstructions between the devices. The maximum allowed distance is up to 1.5 m and the transmission angle 15°.
3. Press  and  to send the image. The  icon blinks while the Nokia Image Frame attempts to establish a connection to the receiving device. During the image transfer the  icon stops blinking. When the image is successfully sent, the Nokia Image Frame displays the  icon.

## ■ Receiving images with the Nokia Image Frame

When the power is switched on, the Nokia Image Frame can receive images. Note that the Nokia Image Frame converts the received images to display them. For more information, see "Image format" on page 7.

The image receiving procedure differs depending on the sending device. If the sending device can send images over IR, you can send the selected images from the device while the Nokia Image Frame is in the passive IR reception mode. If image sending cannot be activated from the sending device, the Nokia Image Frame can pull all the images from the sending device's default image folder using the active IR reception mode.



**Receiving images over IR:**



1. If you want the images in the Nokia Image Frame to be in a certain order, press briefly  or  to scroll to the image after which you want to store the new images.
2. Direct the IR ports of the Nokia Image Frame and the compatible sending device toward each other, and ensure that there are no obstructions between the devices. The maximum allowed distance is up to 1.5 m and the transmission angle 15°.
3. When the sending device starts to send the images, the Nokia Image Frame enters the passive IR reception mode and displays the  icon. For more information on how to initiate sending from the other device, refer to the user's guide of that device.
4. During the image transfer, the Nokia Image Frame displays the  icon and the received images one by one.
5. After the images have been received, the Nokia Image Frame returns to the previous mode, and the images are stored as the next images after the currently displayed image.

If you want to edit the new images, see "Editing the images" on page 16.

**Pulling images over IR:**

The Nokia Image Frame pulls all the images from the image source device's default directory. The maximum number of images in the Nokia Image Frame is 50. If this limit is reached during the image transfer, the transfer is disconnected so that only 50 images in total are stored to the Nokia Image Frame.

1. If you want the images in the Nokia Image Frame to be in a certain order, press briefly  or  to scroll to the image after which you want to store the new images.
2. Direct the IR ports of the Nokia Image Frame and the compatible image source device toward each other, and ensure that there are no obstructions between the devices. The maximum allowed distance is up to 1.5 m and the transmission angle 15°.

3. Activate the image source device's IR connection. For more information on how to do this, refer to the user's guide of that device.
4. Press **▶** to enter the active IR reception mode. The Nokia Image Frame displays the  icon.
5. During the image transfer, the Nokia Image Frame displays the  icon and the received images one by one.
6. After all the images have been received, the Nokia Image Frame returns to the previous mode, and the images are stored as the next images after the currently displayed image.



If you want to edit the new images, see "Editing the images" on page 16.

## ■ Receiving images over MMS with the Nokia Image Frame







**Note:** Your Nokia Image Frame must be connected to the mobile network to use this function. Do not connect the Nokia Image Frame to the mobile network when wireless phone use is prohibited or when it may cause interference or danger.



When the power is switched on and the Nokia Image Frame is connected to the mobile network, it can receive images over MMS. Note that the Nokia Image Frame converts the received images to display them. For more information, see "Image format" on page 7. If the incoming MMS message contains sound or text, only the image is stored.

The incoming image makes the Nokia Image Frame enter the MMS reception mode and display the  icon. While the image is downloaded, the  icon blinks and the image on the display does not change even if the Nokia Image Frame is in the slide show mode. When the download is finished, the  icon stops blinking. If you turn the power off from the Nokia Image Frame during the image download, all the incompletely downloaded images are discarded.

The downloaded image is not displayed before you check the image. The  icon is displayed until you have checked and accepted or deleted the image. If more than one image has been downloaded, the number of downloaded images is shown next to the icon.

**Checking the images:**

1. If you want the images in the Nokia Image Frame to be in a certain order, press briefly  or  to scroll to the image after which you want to store the new images.
2. Press briefly  to view the oldest unchecked image in the memory. If the phone number of the sender is known, it is displayed on the screen with the downloaded image.
3. If you want to store the image, press briefly . The image is stored as the next image after the previously displayed image. The phone number is not stored.

If you want to delete the image immediately, press and hold  and  until the  icon is displayed.

## Care and maintenance

---

Your Nokia Image Frame SU-7 is a product of superior design and craftsmanship and should be treated with care. The suggestions below will help you to fulfil any warranty obligations and to enjoy this product for many years.

- Keep all enhancements out of the reach of small children.
- Keep Nokia Image Frame dry. Precipitation, humidity and all types of liquids or moisture can contain minerals that will corrode electronic circuits.
- Do not use or store Nokia Image Frame in dusty, dirty areas. Its moving parts can be damaged.
- Do not store Nokia Image Frame in hot areas. High temperatures can shorten the life of electronic devices, damage batteries, and warp or melt certain plastics.
- Do not store Nokia Image Frame in cold areas. When it warms up (to its normal temperature), moisture can form inside, which may damage electronic circuit boards.
- Do not attempt to open Nokia Image Frame. Non-expert handling may damage it.
- Do not drop, knock or shake Nokia Image Frame. Rough handling can break internal circuit boards.
- Do not use harsh chemicals, cleaning solvents, or strong detergents to clean Nokia Image Frame.
- Do not paint Nokia Image Frame. Paint can clog the moving parts and prevent proper operation.

If Nokia Image Frame is not working properly, take it to your nearest qualified service facility. The personnel there will assist you and, if necessary, arrange for service.

For environmentally sound recycling, contact your local Nokia service point or check local regulations for correct disposal of household electronics.

# Important Safety Information

---

## ■ Power supply

The Image Frame power supply ACW-5A converts mains voltage to low voltage DC.

**Note:** The power supply socket should be easily accessible, and it must not be covered. The power supply is insulation class 2-covered.

**Warning:** Dangerous voltage. Do not attempt to open the casing under the back cover.

**Note:** This power supply is for indoor use only! Do not expose the unit to water, rain or dust.

The power supply should be disconnected from the socket when the device is not in use for a prolonged period of time or when the power supply is not connected to the device.

## ■ Operating environment

Remember to follow any special regulations in force in any area and always disconnect the Nokia Image Frame from the mobile network whenever it is forbidden to use it, or when it may cause interference or danger.

Use the Nokia Image Frame only in its normal operating positions.

Do not place credit cards or other magnetic storage media near the Nokia Image Frame, because information stored on them may be erased.

## ■ Electronic devices

Most modern electronic equipment is shielded from radio frequency (RF) signals. However, certain electronic equipment may not be shielded against the RF signals from your Nokia Image Frame.

Pacemaker manufacturers recommend that a minimum separation of 20 cm (6 inches) be maintained between a handheld wireless phone and a pacemaker to avoid potential interference with the pacemaker. These recommendations are consistent with the independent research by and recommendations of Wireless Technology Research. Persons with pacemakers:

- Should always keep the Nokia Image Frame more than 20 cm (6 inches) from their pacemaker when the Nokia Image Frame is connected to the mobile network;
- If you have any reason to suspect that interference is taking place, switch off your Nokia Image Frame immediately.

### Hearing aids

Some digital wireless phones may interfere with some hearing aids. In the event of such interference, you may want to consult your service provider.

### Other medical devices

Operation of any radio transmitting equipment, including the Nokia Image Frame, may interfere with the functionality of inadequately protected medical devices. Consult a physician or the manufacturer of the medical device to determine if they are adequately shielded from external RF energy or if you have any questions. Disconnect the Nokia Image Frame from the mobile network in health care facilities when any regulations posted in these areas instruct you to do so. Hospitals or health care facilities may be using equipment that could be sensitive to external RF energy.

### Posted facilities

Disconnect the Nokia Image Frame from the mobile network in any facility where posted notices so require.

### ■ Potentially explosive atmospheres

Disconnect the Nokia Image Frame from the mobile network when in any area with a potentially explosive atmosphere and obey all signs and instructions. Sparks in such areas could cause an explosion or fire resulting in bodily injury or even death.

Users are advised to disconnect the Nokia Image Frame from the mobile network when at a refuelling point (service station). Users are reminded of the need to observe restrictions on the use of radio equipment in fuel depots (fuel storage and distribution areas), chemical plants or where blasting operations are in progress.

Areas with a potentially explosive atmosphere are often but not always clearly marked. They include below deck on boats; chemical transfer or storage facilities; vehicles using liquified petroleum gas (such as propane or butane); areas where the air contains chemicals or particles, such as grain, dust or metal powders; and any other area where you would normally be advised to turn off your vehicle engine.



## Free Manuals Download Website

<http://myh66.com>

<http://usermanuals.us>

<http://www.somanuals.com>

<http://www.4manuals.cc>

<http://www.manual-lib.com>

<http://www.404manual.com>

<http://www.luxmanual.com>

<http://aubethermostatmanual.com>

Golf course search by state

<http://golfingnear.com>

Email search by domain

<http://emailbydomain.com>

Auto manuals search

<http://auto.somanuals.com>

TV manuals search

<http://tv.somanuals.com>