

Model No. NTTL24080

Serial No. _____

Find the serial number in the location shown below. Write the serial number in the space above for reference.

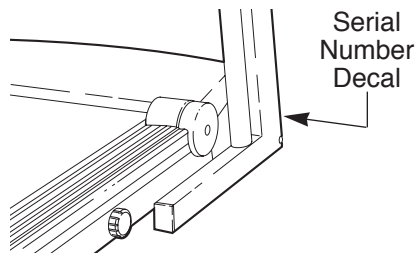

User's Manual

Questions?

As a manufacturer, we are committed to providing complete customer satisfaction. If you have questions, or if there are missing or damaged parts, we will guarantee complete satisfaction through direct assistance from our factory.

TO AVOID UNNECESSARY DELAYS, PLEASE CALL DIRECT TO OUR TOLL-FREE CUSTOMER HOT LINE. The trained technicians on our Customer Hot Line will provide immediate assistance, free of charge to you.

CUSTOMER HOT LINE:

1-800-999-3756

Mon.-Fri., 6 a.m.-6 p.m. MST

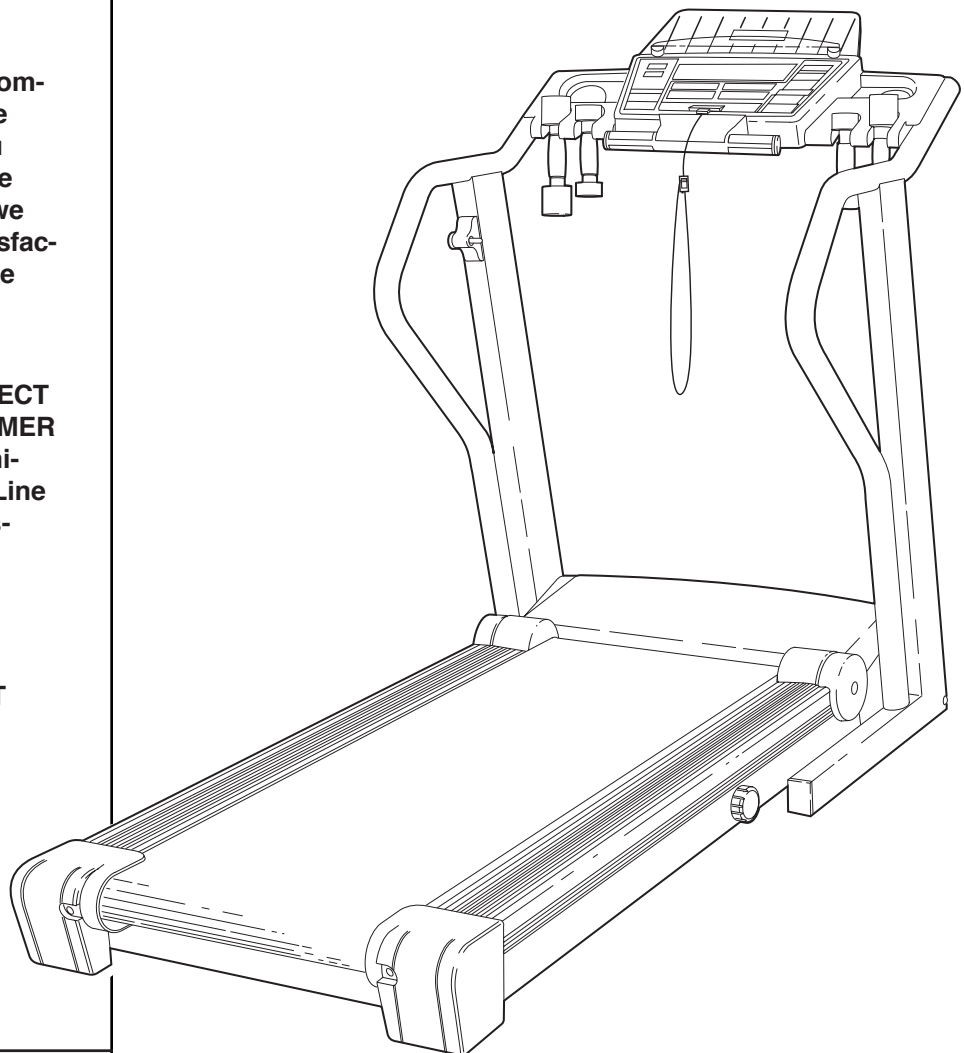

⚠ CAUTION

Read all precautions and instructions in this manual before using this equipment. Save this manual for future reference.



Visit our website at

www.nordictrack.com

new products, prizes,
fitness tips, and much more!



Table of Contents

Important Precautions	3
Before You Begin	5
Assembly	6
How to Use the Hand Pulse Sensor	7
How to Use the Chest Pulse Sensor	7
Treadmill Operation	9
How to Use the Quick Start Mode	11
How to Use a Heart Rate Program	13
How to Use an Incline Program	15
How to Use the Fitness Age Test	17
How to Create a Custom Program	18
How to Use a Custom Program	19
How to Measure your Body Fat	20
How to Fold and Move the Treadmill	22
Maintenance and Trouble-shooting	24
Conditioning Guidelines	26
Part List	30
How to Order Replacement Parts	31
Limited WarrantyBack Cover

Note: An Exploded Drawing is attached in the center of this manual.

Important Precautions

⚠ WARNING: To reduce the risk of burns, fire, electric shock, or injury to persons, read the following important precautions and information before operating the treadmill.

1. It is the responsibility of the owner to ensure that all users of this treadmill are adequately informed of all warnings and precautions.
2. Use the treadmill only as described in this user's manual.
3. Place the treadmill on a level surface, with eight feet of clearance behind it. Do not place the treadmill on any surface that blocks air openings. To protect the floor or carpet from damage, place a mat under the treadmill.
4. Keep the treadmill indoors, away from moisture and dust. Do not put the treadmill in a garage or covered patio, or near water.
5. Do not operate the treadmill where aerosol products are used or where oxygen is being administered.
6. Keep children under the age of 12 and pets away from the treadmill at all times.
7. The treadmill should not be used by persons weighing more than 250 pounds. Never allow more than one person on the treadmill at a time.
8. Wear appropriate clothing when using the treadmill. Do not wear loose clothing that could become caught in the treadmill. Athletic support clothes are recommended for both men and women. Always wear athletic shoes. Never use the treadmill with bare feet, wearing only stockings, or in sandals.
9. When connecting the power cord (see How to Plug in the Power Cord on page 9), plug the power cord into a surge protector (not included) and plug the surge protector into a grounded circuit capable of carrying 15 or more amps. No other appliance should be on the same circuit.
10. Use only a UL-listed surge protector, rated at 15 amps, with a 14-gauge cord of five feet or less in length. Do not use an extension cord.
11. Keep the power cord and the surge protector away from heated surfaces.
12. Never move the walking belt while the power is turned off. Do not operate the treadmill if the power cord or plug is damaged, or if the treadmill is not working properly. (See Before You Begin on page 5 if the treadmill is not working properly.)
13. Never start the treadmill while you are standing on the walking belt.
14. Always hold the handrails while running on the treadmill. When walking, hold the handrails or use the included hand weights.
15. Do not perform exercises with the hand weights at speeds faster than a walk. Using weights and not holding the handrails may compromise your ability to maintain your balance. Exercises using weights should be attempted only by experienced users.
16. The treadmill is capable of high speeds. Adjust the speed in small increments to avoid sudden jumps in speed.
17. The hand pulse sensor and the chest pulse sensor are not medical devices. Various factors, including the user's movement, may affect the accuracy of heart rate readings. The pulse sensors are intended only as exercise aids in determining heart rate trends in general.
18. Never leave the treadmill unattended while it is running. Always remove the key, unplug the power cord and move the on/off switch to the off position when the treadmill is not in use. (See the drawing on page 5 for the location of the on/off switch.)
19. Do not attempt to raise, lower, or move the treadmill until it is properly assembled. (See Assembly on page 6, and How to Move the Treadmill on page 22.) You must be able to safely lift 45 pounds (20 kg) in order to raise, lower, or move the treadmill.

20. When folding or moving the treadmill, make sure that the frame is held securely by the storage latch.

21. Inspect and tighten all parts of the treadmill every three months.

22. Never drop or insert any object into any opening.

23. **DANGER:** Always unplug the power cord immediately after use, before cleaning

the treadmill, and before performing the maintenance and adjustment procedures described in this manual. Never remove the motor hood unless instructed to do so by an authorized service representative. Servicing other than the procedures in this manual should be performed by an authorized service representative only.

24. This treadmill is intended for in-home use only. Do not use this treadmill in any commercial, rental, or institutional setting.

⚠ WARNING: Before beginning this or any exercise program, consult your physician. This is especially important for persons over the age of 35 or persons with pre-existing health problems. Read all instructions before using. ICON assumes no responsibility for personal injury or property damage sustained by or through the use of this product.

Save These Instructions

The decals shown below have been placed on your treadmill. If a decal is missing, or if it is not legible, please call our Customer Service Department toll-free to order a free replacement decal (see the back cover of this manual). Apply the decal in the location shown.

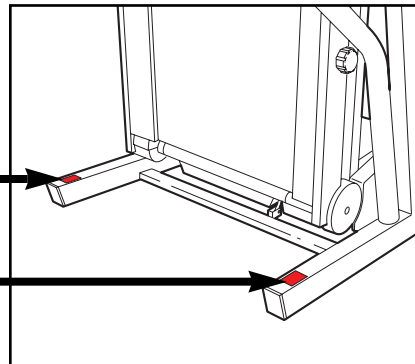
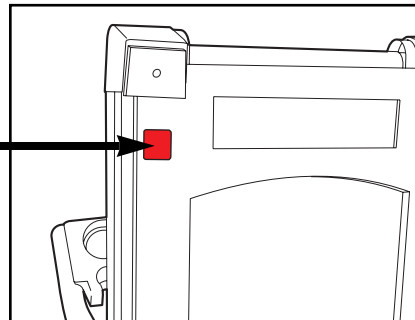

Before You Begin

Thank you for selecting the new NordicTrack PowerTread™ 3000L treadmill. The PowerTread 3000L treadmill combines advanced technology with innovative design to let you enjoy an excellent form of cardiovascular exercise in the convenience and privacy of your home. And when you're not exercising, the unique PowerTread 3000L can be folded up, requiring less than half the floor space of other treadmills.

For your benefit, read this manual carefully before using the treadmill. If you have additional questions, please call our toll-free Customer Service Department

at 1-800-999-3756, Monday through Friday, 6 a.m. until 6 p.m. Mountain Time (excluding holidays). To help us assist you, please note the product model number and serial number before calling. The model number of the treadmill is NTTL24080. The serial number can be found on a decal attached to the treadmill (see the front cover of this manual for the location).

Before reading further, please review the drawing below and familiarize yourself with the parts that are labeled.

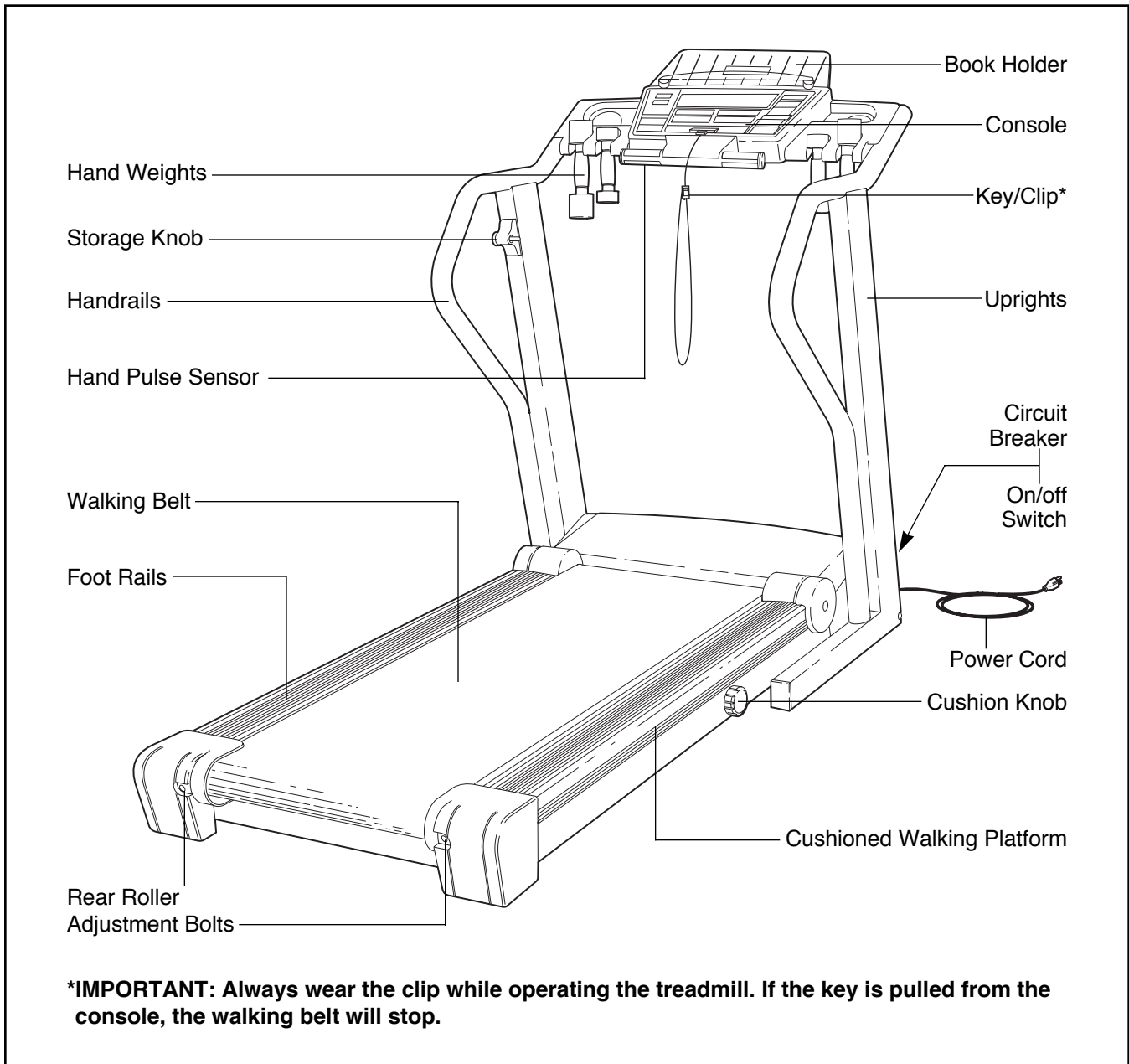

Assembly

Assembly requires two people. Set the treadmill in a cleared area and remove all packing materials. Do not dispose of the packing materials yet. A phillips screwdriver (not included) is needed for assembly.

Note: The underside of the treadmill walking belt is coated with a special high-performance lubricant. During shipping, a small amount of lubricant may be transferred to the top of the walking belt or the shipping carton. This is a normal condition and does not affect treadmill performance. If there is lubricant on top of the walking belt, simply wipe off the lubricant with a soft cloth and a mild, non-abrasive cleaner.

1. With the help of a second person, carefully raise the Uprights (92) until the Wheels (119) are resting flat on the floor.

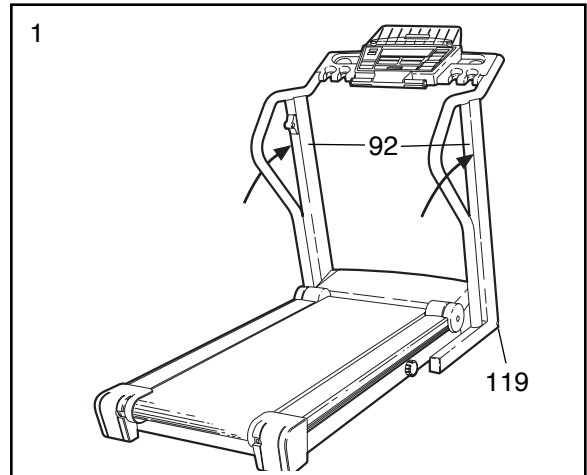

2. Remove the Lock Knob (105) from the Lock Pin (100).

Make sure that the Lock Pin Collar (102) and the Spring (103) are on the Lock Pin. Insert the Lock Pin into the Latch Bracket (104)

Tighten the Lock Knob (105) onto the Lock Pin (100).

Press a Bottle Holder Insert (115) into each side of the Console Base (116).

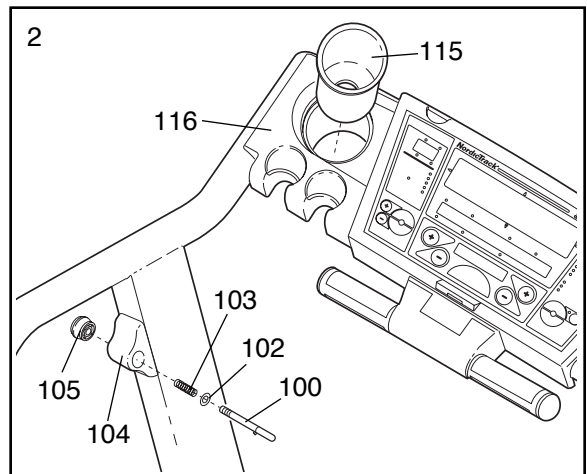

3. Insert the two Book Holder Caps (112) into the Book Holder (110) as shown. Attach the Book Holder to the Console Base (116) with the two Book Holder Screws (111). **Be careful not to overtighten the Screws.**

Note: Do not hold or push on the Book Holder (110) or the Book Holder may be damaged.

4. **Make sure that all parts of the treadmill are properly tightened.** Place a mat beneath the treadmill to protect the floor or carpet. Note: Keep the included allen wrench in a secure location. The allen wrench will be needed to adjust the walking belt (see page 25).

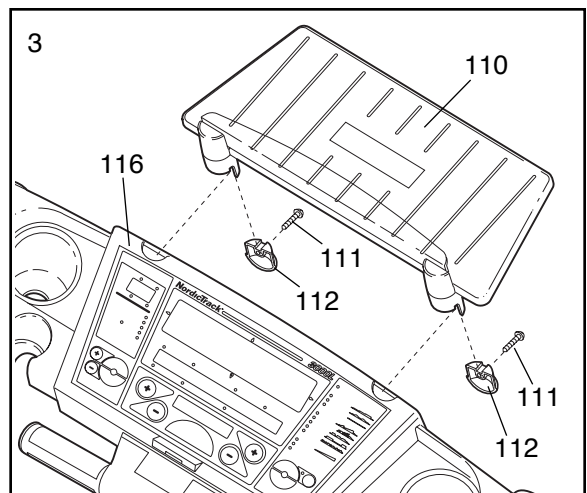

How to Use the Hand Pulse Sensor

The convenient hand pulse sensor allows you to measure your heart rate before you begin exercising, during your workouts, and again when you finish.

To use the hand pulse sensor, the console must be turned on. In addition, the walking belt must be moving or the time must be flashing in the main display.

To measure your heart rate, stand on the foot rails and place your hands on the metal contacts as shown. Your palms must be resting on the upper contacts, and your fingers must be touching the lower contacts. **Avoid moving your hands.** When your pulse is detected, the PULSE indicator will flash each time your heart beats, three dashes (---) will appear

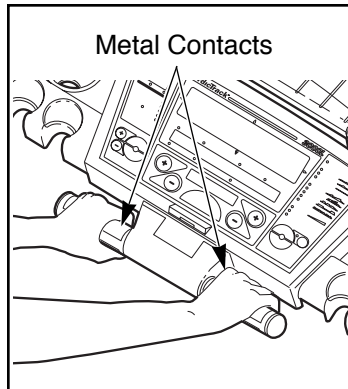

on the left side of the main display and your heart rate will be shown. Continue to hold the contacts for about 15 seconds for the most accurate heart rate reading.

HAND PULSE SENSOR TROUBLE-SHOOTING

- Stand on the foot rails and avoid moving your hands while measuring your heart rate. Excessive movement may interfere with heart rate readings. If the hand pulse sensor is not used correctly, your heart rate will not be shown.
- Do not hold the metal contacts too tightly; doing so may interfere with heart rate readings.
- Continue to hold the contacts for about 15 seconds for the most accurate heart rate reading.
- For optimal performance of the hand pulse sensor, keep the metal contacts clean. The contacts can be cleaned with a soft cloth—never use alcohol, abrasives, or chemicals.

How to Use the Chest Pulse Sensor

The chest pulse sensor consists of two components: the chest strap and the sensor unit. Follow the steps below to put on the chest pulse sensor.

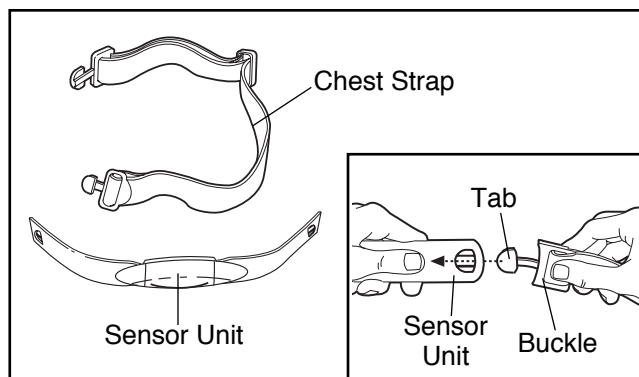

- 1** Refer to the inset drawing above. Insert the tab on one end of the chest strap through one end of the sensor unit as shown. Make sure to press the end of the sensor unit under the buckle on the chest strap.

- 2** Wrap the sensor unit and the chest strap around your chest. Attach the free end of the chest strap to the sensor unit as described above. Adjust the length of the chest strap, if necessary. The chest pulse sensor should be under your clothing, against your skin, and as high under the pectoral muscles or breasts as is comfortable. Make sure that the logo is facing forward and is right-side-up.

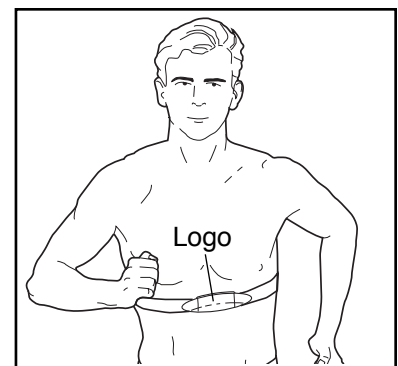

- 3** Pull the sensor unit away from your body a few inches and locate the two electrode areas on the inner side. Using a saline solution such as saliva or contact lens solution, wet both electrode areas. Return the sensor unit to a position against your chest.

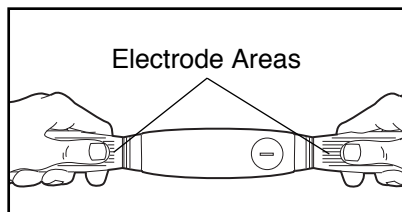

CHEST PULSE SENSOR TROUBLE-SHOOTING

If the chest pulse sensor does not function properly, or if the displayed pulse is excessively high or low, try the trouble-shooting steps below.

- Make sure that the chest pulse sensor is under your clothing, against your skin, and as high under the pectoral muscles or breasts as is comfortable. Note: If the chest pulse sensor does not function when positioned as described, try moving it slightly lower or higher on your chest.
- Make sure that the logo on the sensor unit is facing forward and is right-side-up.
- Each time you use the chest pulse sensor, use saline solution such as saliva or contact lens solution to wet the two electrode areas on the sensor unit (see the drawing at the top of this page). If pulse readings do not appear until you begin perspiring, re-wet the electrode areas.
- As you walk or run on the treadmill, make sure that you are near the center of the walking belt and within arm's length of the console. **For the console to display pulse readings, the user must be within arm's length of the console.**
- The chest pulse sensor is designed to work with people who have normal heart rhythms. Pulse reading problems may be caused by medical conditions such as premature ventricular contractions (pvc's), tachycardia bursts, and arrhythmia.
- The operation of the chest pulse sensor can be affected by magnetic interference caused by high power lines or other sources. If it is suspected that magnetic interference may be causing a problem, try relocating the treadmill.
- If the chest pulse sensor still does not function properly, test the chest pulse sensor in the following way:

Hold the chest pulse sensor and place your thumbs over the electrode areas as shown above.

Next, hold the chest pulse sensor near the console. While holding one thumb stationary, begin tapping the other thumb against the electrode area at a rate of about one tap per second. Check the pulse reading on the console.

- If the chest pulse sensor does not function properly after you have followed all of the above instructions, the battery should be replaced in the following way:

Locate the battery cover on the back of the sensor unit. Insert a coin into the slot in the cover, turn the cover counterclockwise, and remove the cover.

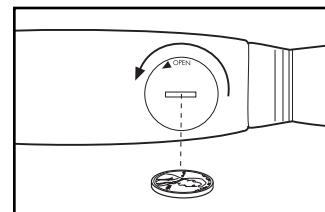

Remove the old battery and insert a new CR 2032 battery.

Make sure that the battery is turned so the writing is on top. Replace the battery cover and turn it clockwise to close it.

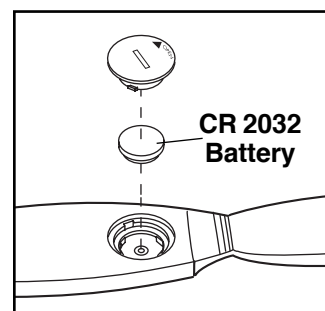

CHEST PULSE SENSOR CARE

- Dry the chest pulse sensor after each use. The chest pulse sensor is activated when the electrode areas are wetted and it is put on; the chest pulse sensor shuts off when it is removed and the electrode areas are dried. If the chest pulse sensor is not dried after each use, it may remain activated longer than necessary, draining the battery prematurely.
- Store the chest pulse sensor in a warm, dry place. Do not store the chest pulse sensor in a plastic bag or other container that may trap moisture.
- Do not expose the chest pulse sensor to direct sunlight for extended periods of time. Do not expose the chest pulse sensor to temperatures above 122°F (50°C) or below 14°F (-10°C).
- Do not excessively bend or stretch the sensor unit when using or storing the chest pulse sensor.
- Clean the sensor unit using a damp cloth—never use alcohol, abrasives, or chemicals.

TREADMILL OPERATION

THE PERFORMANT LUBE™ WALKING BELT

Your treadmill features a walking belt coated with PERFORMANT LUBE™, a high-performance lubricant. **IMPORTANT: Never apply silicone spray or other substances to the walking belt or the walking platform. They will deteriorate the walking belt and cause excessive wear.**

HOW TO PLUG IN THE POWER CORD

⚠ DANGER: Improper connection of the equipment-grounding conductor can result in an increased risk of electric shock. Check with a qualified electrician or service representative if you are in doubt as to whether the product is properly grounded. Do not modify the plug provided with the product—if it will not fit the outlet, have a proper outlet installed by a qualified electrician.

Your treadmill, like any other type of sophisticated electronic equipment, can be seriously damaged by sudden voltage changes in your home's power. Voltage surges, spikes, and noise interference can result from weather conditions or from other appliances being turned on or off. **To decrease the possibility of your treadmill being damaged, always use a surge protector (not included) with your treadmill.**

Surge protectors are sold at most hardware stores and department stores. Use only a UL-listed surge protector, rated at 15 amps, with a 14-gauge cord of five feet or less in length.

This product must be grounded. If it should malfunction or break down, grounding provides a path of least resistance for electric current to reduce the risk of electric shock.

This product is equipped with a cord having an equipment-grounding conductor and a grounding plug. **Plug the power cord into a surge protector, and plug the surge protector into an appropriate outlet that is properly installed and grounded in accordance with all local codes and ordinances.**

This product is for use on a nominal 120-volt circuit, and has a grounding plug that looks like the plug illustrated in drawing 1 below. A temporary adapter that looks like the adapter illustrated in drawing 2 may be used to connect the surge protector to a 2-pole receptacle as shown in drawing 2 if a properly grounded outlet is not available.

The temporary adapter should be used only until a properly grounded outlet (drawing 1) can be installed by a qualified electrician.

The green-colored rigid ear, lug, or the like extending from the adapter must be connected to a permanent ground such as a properly grounded outlet box cover. Whenever the adapter is used it must be held in place by a metal screw. **Some 2-pole receptacle outlet box covers are not grounded. Contact a qualified electrician to determine if the outlet box cover is grounded before using an adapter.**

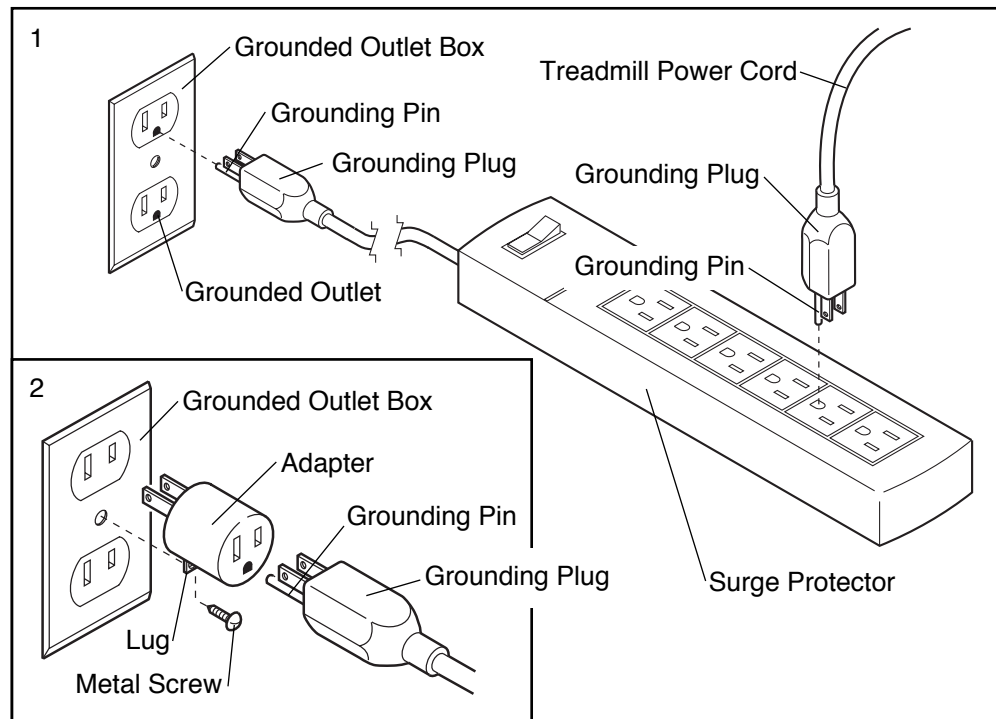

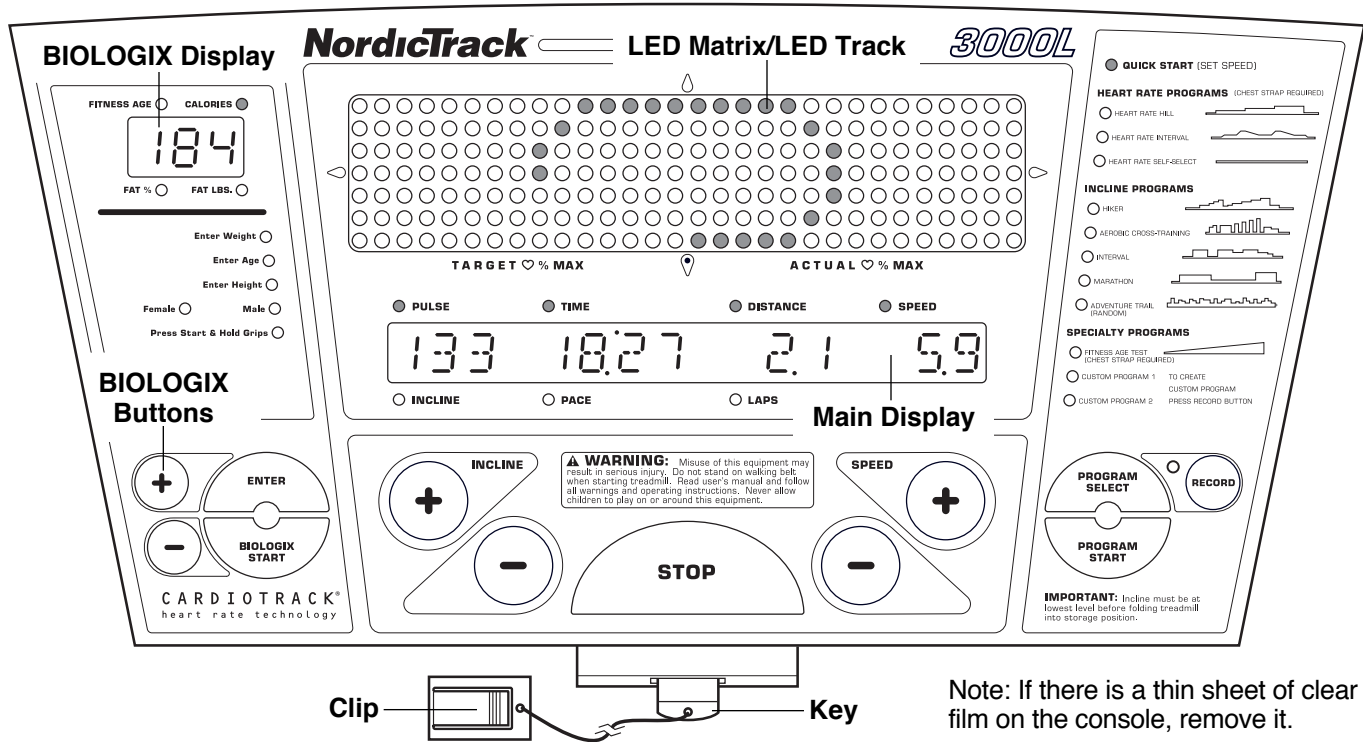

⚠ WARNING: Before operating the console, read the following precautions.

- Do not stand on the walking belt when turning on the power or starting the walking belt.
- Always wear the clip (see the drawing above) while operating the treadmill. If the key is pulled from the console, the walking belt will stop.
- The treadmill is capable of high speeds. Adjust the speed in small increments.
- The hand pulse sensor and the chest pulse sensor are not medical devices. Various factors may affect the accuracy of heart rate readings. The pulse sensors are intended only as exercise aids in determining heart rate trends in general.
- To reduce the risk of electric shock, keep the console dry. Place only sealed water bottles in the water bottle holders.

FEATURES OF THE CONSOLE

The treadmill console offers an impressive array of features to make your workouts more effective.

When the console is in the QUICK START mode, the speed and incline of the treadmill can be changed with a touch of a button. As you exercise, you can watch your progress on the LED matrix while the main display provides continuous exercise feedback.

Eight preset programs are also offered: three HEART RATE programs automatically change the speed and incline of the treadmill to keep your heart rate near pre-set levels, and five INCLINE programs automatically control the incline of the treadmill as they guide you through effective workouts. The console also features a special FITNESS AGE TEST and two CUSTOM programs that you can create and save in memory. The console even measures your body fat.

To use the QUICK START mode, follow the steps beginning on page 11. To use a HEART RATE program, see page 13. To use an INCLINE program, see page 15. To use the FITNESS AGE TEST, see page 17. To create a CUSTOM program, see page 18. To use a CUSTOM program, see page 19. To measure your body fat, see page 20.

Note: The console can display speed and distance in either miles or kilometers (see Speed on page 12). For simplicity, all instructions in this user's manual refer to miles.

HOW TO USE THE QUICK START MODE

1 Plug in the power cord.

Make sure that the on/off switch on the front of the treadmill is in the on position. Next, follow the instructions on page 9 and plug in the power cord. When the power cord is plugged in, all displays and indicators on the console will flash once.

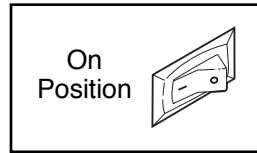

2 Insert the key into the console.

Stand on the foot rails of the treadmill. Find the clip attached to the key and slide the clip onto your waistband. Next, insert the key into the console.

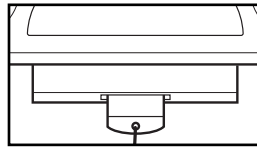

After a moment, the words "ENTER WEIGHT" will appear in the main display, the ENTER WEIGHT indicator will light, and the current weight setting

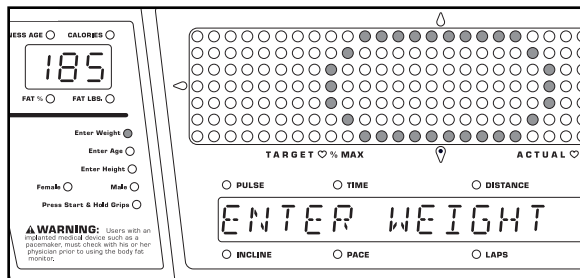

will begin to flash in the BIOLOGIX display. The LED track will also light. Note: When you are familiar with the console, you may go directly to step 5 if desired. The first time you use the console, please follow all steps.

3 Select the QUICK START mode.

When the key is inserted, the QUICK START mode will be selected, as shown by the QUICK START indicator. If a program has been selected, press the PROGRAM SELECT button repeatedly until the QUICK START indicator lights.

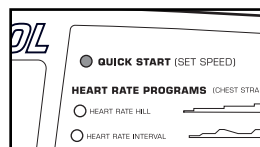

4 Enter your weight if desired.

For the console to measure your calorie expenditure accurately, your weight should be entered into the console.

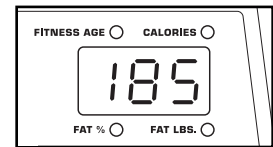

To enter your weight, press the BIOLOGIX + and – buttons. Each time a button is pressed, the weight setting will change by 1 pound. If one of the buttons is held down, the weight setting will change in increments of 5 pounds. Note: Once you have entered your weight, it will be saved in memory.

5 Press the PROGRAM START button or the SPEED + button to start the walking belt.

When the button is pressed, the LED track will disappear in a counterclockwise direction. One flashing indicator will then reappear and the walking belt will begin to move at 1.0 mph. Hold the handrails and begin walking.

6 Adjust the speed and incline of the treadmill.

As you exercise, change the speed of the walking belt as desired by pressing the SPEED buttons.

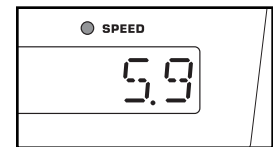

Each time a button is pressed, the speed will change by 0.1 mph. If one of the buttons is held down, the speed will change in increments of 0.5 mph. The speed range is 0.5 mph to 12 mph. Note: When the SPEED buttons are pressed, the main display will show the selected speed setting for six seconds. The display will then show the actual speed of the walking belt.

To stop the walking belt, press the STOP button. The main display will pause and the time will begin to flash. To restart the walking belt, press the PROGRAM START button or the SPEED + button. To stop the walking belt and reset the main display, hold down the STOP button for two seconds.

To change the incline of the treadmill, press the INCLINE buttons. Each time a button is pressed, the incline will change by 0.5%. The incline range is 0% to 12%. Note: The incline setting is shown at the left end of the main display. After the INCLINE buttons are pressed, it may take several seconds for the treadmill to reach the selected incline setting.

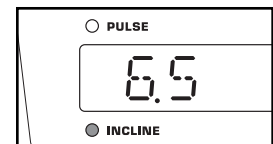

7 Watch your progress with the LED matrix, the main display, and the BIOLOGIX display.

The LED matrix

When the QUICK START mode is selected, the LED track will light.

The track represents a distance of 1/4 mile. As you exercise, the indicators around the track will light one at a time until the entire track is lit. The track will then disappear in a counterclockwise direction and a new lap will begin.

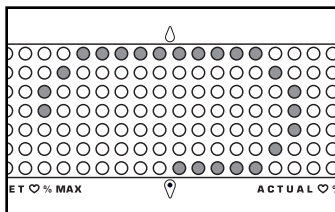

The Main Display

As you exercise, the main display will provide the following exercise feedback:

Pulse

For the main display to show your heart rate, the hand pulse sensor or the chest pulse sensor must be used (see pages 7 and 8). When your pulse is detected, the PULSE indicator will flash each time your heart beats. Three dashes will then appear in the main display and your heart rate will be shown. Note: It may take up to ten seconds for an accurate heart rate to be shown. If your heart rate is not shown, see Hand Pulse Sensor Trouble-shooting on page X or Chest Pulse Sensor Trouble-shooting on page 8. Do not use the hand pulse sensor and the chest pulse sensor at the same time.

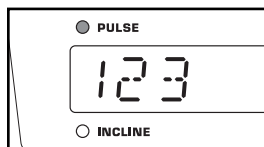

Incline—When the INCLINE indicator is lit, the main display will show the incline level of the treadmill.

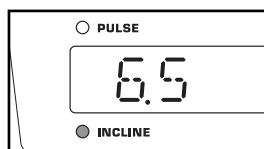

Time—When the TIME indicator is lit, the main display will show the total time that you have been walking or running. Note: When a HEART RATE program, an INCLINE program (except the ADVENTURE TRAIL program), or a CUSTOM program is selected, the display will show the time remaining in the program rather than the elapsed time.



Pace—When the PACE indicator is lit, the main display will show your current pace in minutes per mile. For example, if you are running at 6.0 mph, your pace will be 10:00 (ten minutes per mile) because you will run one mile in ten minutes.



Distance—When the DISTANCE indicator is lit, the main display will show the distance that you have walked or run.

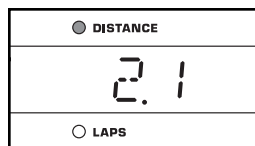

Laps—When the LAPS indicator is lit, the main display will show the number of 1/4-mile laps you have completed.

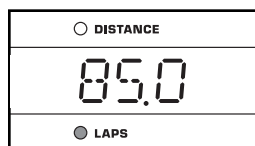

Speed—When the SPEED indicator is lit, the main display will show the current speed of the walking belt. Note: When the SPEED buttons are pressed, the display will show the selected speed setting for six seconds. The display will then show the actual speed of the walking belt.

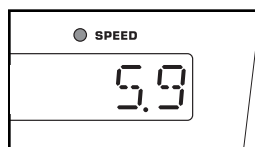

Note: The console can display speed and distance in either miles or kilometers. To see which unit of measurement is selected, hold down the STOP button while inserting the key into the console. An “E” for English miles or an “M” for metric kilometers will appear at the right end of the main display. To change the unit of measurement, press the SPEED + button. When you are finished, remove and then reinsert the key.

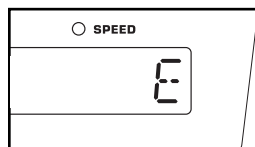

The BIOLOGIX display

As you exercise, the BIOLOGIX display will show the approximate number of calories you have burned.

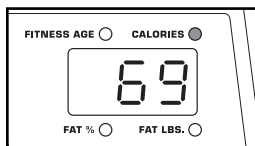

8 When you are finished exercising, stop the walking belt and remove the key.

Step onto the foot rails and press the STOP button. **Next, change the incline of the treadmill to 0%. The incline must be at 0% before the treadmill is folded to the storage position or the treadmill may be damaged.**

Remove the key from the console and store the key in a secure place. In addition, press the on/off switch to the off position. (See the drawing at the top of page 11.)

HOW TO USE A HEART RATE PROGRAM

⚠ WARNING: If you have heart problems, or if you are over 60 years of age and have been inactive, do not use the HEART RATE programs. If you are taking medication regularly, consult your physician to find whether the medication will affect your exercise heart rate.

The three HEART RATE programs automatically control the speed and incline of the treadmill to keep your heart rate near preset levels during your workouts. The three red graphs on the right side of the console show the heart rate settings of the programs.

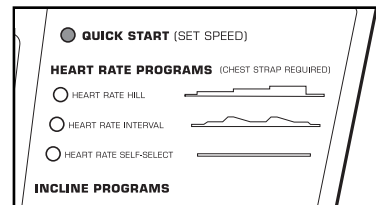

Follow the steps below to use a HEART RATE program.

1 Plug in the power cord.

See step 1 on page 11.

2 Insert the key into the console.

See step 2 on page 11.

3 Put on the chest pulse sensor.

The chest pulse sensor must be worn when a HEART RATE program is used. To put on the chest pulse sensor, see How to Use the Chest Pulse Sensor on page 7.

4 Select one of the HEART RATE programs.

When the key is inserted, the QUICK START mode will be selected. To select one of the HEART RATE programs, press the PROGRAM SELECT button repeatedly until the HEART RATE HILL, HEART RATE INTERVAL, or HEART RATE SELF-SELECT indicator

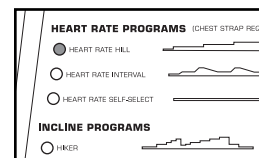

lights. Note: If the incline of the treadmill is higher than 0%, it will automatically decrease to 0%.

Refer to the LED matrix. A heart will appear on the right side of the matrix, indicating that a HEART RATE program has been selected. The left side of the matrix will show a representation of the heart rate settings of the selected program.

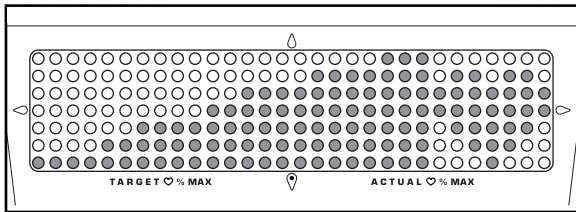

5 Enter your weight.

When a HEART RATE program is selected, the words “ENTER WEIGHT” will appear in the main display, the ENTER WEIGHT indicator will light, and the current weight setting will begin to flash in the BIOLOGIX display. If the weight setting is correct, press the ENTER button. If you have not entered your weight, press the BIOLOGIX + and – buttons to enter your weight and then press the ENTER button.

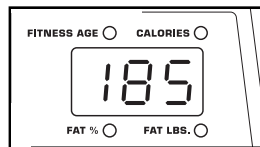

6 Enter your age.

After you have entered your weight, the words “ENTER AGE” will appear in the main display, the ENTER AGE indicator will light, and the current age setting will begin to flash in the BIOLOGIX display. If the age setting is correct, press the ENTER button. If you have not entered your age, press the BIOLOGIX + and – buttons to enter your age and then press the ENTER button.

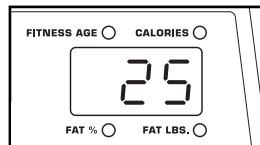

Refer to the LED matrix. The matrix will show the maximum

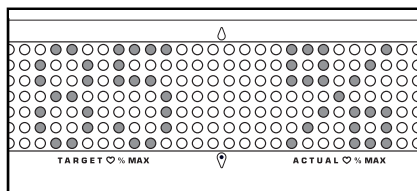

heart rate setting of the selected program, as a percentage of your maximum possible heart rate. (Your maximum possible heart rate is 220 minus your age). **If the HEART RATE HILL or HEART RATE INTERVAL program is selected, go to step 8. If the HEART RATE SELF-SELECT program is selected, go to step 7.**

7 Select a heart rate setting.

The SELF-SELECT program is designed to keep your heart rate near a setting that you choose. The BIOLOGIX display will show the current heart rate setting of the program, in beats per minute. The LED matrix will show the current heart rate setting as a percentage of your maximum possible heart rate. (Your maximum possible heart rate is 220 minus your age). If desired, you can change the percentage shown in the matrix by pressing the BIOLOGIX + and – buttons. Each time one of the buttons is pressed, the percentage will change by 5%. The percentage can be from 50% to 85%. As the percentage is changed, the heart rate setting shown in the BIOLOGIX display will also change.

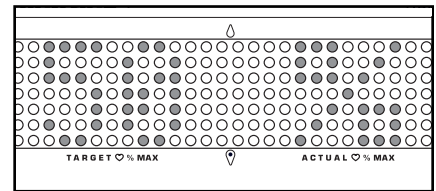

8 Press the PROGRAM START button or the SPEED + button to start the program.

After a moment, the walking belt will begin to move at 1.5 mph. Hold the handrails and begin walking.

As you exercise, the LED matrix will display two numbers.

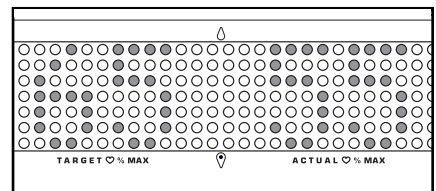

The number on the left is the current target heart rate setting; the number on the right is your actual heart rate. (The numbers are percentages of your maximum possible heart rate). At the end of each one-minute period of the program, a tone will sound and the console will compare your actual heart rate to the target heart rate. If your actual heart rate is higher or lower than the target heart rate by 5% or more, the speed and/or incline of the treadmill will automatically change to bring your heart rate closer to the target heart rate.

When the TIME indicator is lit, the main display will show the time remaining in the program. Near the end of the program, the walking belt will slow to allow you to cool down. During the last ten seconds of the program, the incline will decrease to 0%. When no time remains in the program, the walking belt will slow to a stop.

If your heart rate is not detected during a HEART RATE program, the letters "PLS" will flash in the main display. (See Chest Pulse Sensor Troubleshooting on page 8.) The speed and/or incline of the treadmill may also automatically decrease until your heart rate is detected.

To stop a HEART RATE program momentarily, press the STOP button. The main display will pause and the time will begin to flash. To restart the program, press the PROGRAM START button or the SPEED + button. To end the program and reset the main display, hold down the STOP button for two seconds.

Note: Minor adjustments can be made to the speed or incline of the treadmill during a HEART RATE program with the SPEED or INCLINE buttons. However, if you increase the speed, the incline will automatically decrease; if you decrease the speed, the incline will increase. If you increase the incline, the speed will decrease; if you decrease the incline, the speed will increase. The console will always attempt to keep your heart rate near the target heart rate setting. When the incline reaches the lowest setting, the speed cannot be increased any further. When the incline reaches the highest setting, the speed cannot be decreased any further.

9 Watch your progress with the main display and the BIOLOGIX display.

See step 7 on page 12.

10 When the program is completed, remove the key from the console.

Make sure that the treadmill is at the lowest incline setting. Remove the key from the console and store the key in a secure place. In addition, press the on/off switch to the off position.

HOW TO USE AN INCLINE PROGRAM

The five INCLINE programs automatically control the incline of the treadmill as they guide you through effective workouts. The five gray graphs on the right side of the console show how the incline will change during the INCLINE programs.

(Note: The ADVENTURE TRAIL [RANDOM] program will be different each time it is used.) The HIKER, AEROBIC CROSS-TRAINING, INTERVAL, and MARATHON programs are 30 minutes long; the RANDOM program is 60 minutes long, but can be stopped at any time.

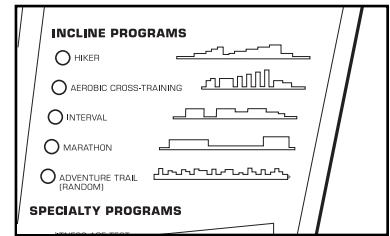

Follow the steps below to use an INCLINE program.

1 Plug in the power cord.

See step 1 on page 11.

2 Insert the key fully into the console.

See step 2 on page 11.

3 Select one of the INCLINE programs.

When the key is inserted, the QUICK START mode will be selected. To select one of the INCLINE programs, press the PROGRAM SELECT button repeatedly until the HIKER, AEROBIC CROSS-TRAINING, INTERVAL, MARATHON, or ADVENTURE TRAIL

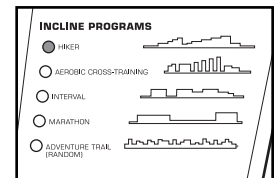

indicator lights. Note: If the incline of the treadmill is higher than 0%, it will automatically decrease to 0%.

Refer to the LED matrix. Each INCLINE program is divided into one-minute periods. One incline setting is programmed for each period. The incline settings of the program you have selected are shown in the LED matrix. The two columns on the left side of the matrix will be dark. The first incline setting of the program will be shown in the third column. The next twenty-seven incline settings are shown in the twenty-seven columns to the right.

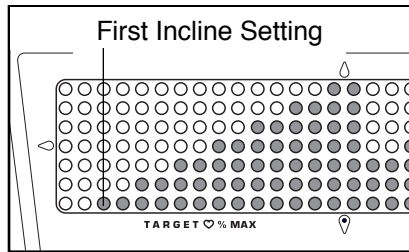

4 Enter your weight if desired.

When an INCLINE program is selected, the words “ENTER WEIGHT” will appear in the main display, the ENTER WEIGHT indicator will light, and the current weight setting will begin to flash in the BIOLOGIX display. For the console to measure your calorie expenditure accurately, your weight should be entered into the console. If the weight setting is not correct, press the BIOLOGIX + and – buttons to enter your weight if desired.

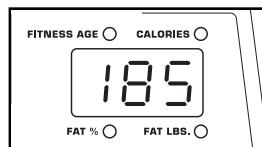

5 Press the PROGRAM START button or the SPEED + button to start the program.

When the button is pressed, the speed setting will flash in the main display. After a moment, the walking belt will begin to move at 1.0 mph. Hold the handrails and begin walking.

Refer to the LED matrix (see the drawing above). During the first one-minute period of the program, the first incline setting shown in the matrix will flash. When only three seconds remain in the first period, both the first and second incline settings in the matrix will flash. When the first period is completed, all incline settings in the matrix will move one column to the left. The second incline setting will then flash and the treadmill will adjust to the second incline setting. At the end of each one-minute period, all incline settings will move one column to the left, the next incline setting will flash, and the treadmill will adjust to the next incline setting.

The speed of the walking belt can be adjusted as desired during the program with the SPEED buttons. When the TIME indicator is lit, the main display will show the time remaining in the program. Near the end of the program, the walking belt will slow to allow you to cool down. During the last ten seconds of the program, the incline will decrease to 0%. When no time remains in the program, the walking belt will slow to a stop. Note: If the RANDOM program is selected, the program will last for 60 minutes. The program can be stopped earlier, if desired, by holding down the STOP button for two seconds.

To stop an INCLINE program momentarily, press the STOP button. The main display will pause and the time will begin to flash. To restart the program, press the PROGRAM START button or the SPEED + button. To end the program and reset the displays, hold down the STOP button for two seconds.

Note: While an INCLINE program is in progress, the difficulty level of the program can be adjusted, if desired, with the INCLINE buttons. Press the INCLINE + button. The letters “MAX” will appear in the LED matrix and a number will flash in the main display for three seconds. This number is the maximum incline level that the treadmill will reach during the program. Press the INCLINE + button again. Each time the button is pressed, the maximum incline setting will increase by 0.5%. As the maximum incline setting increases, the difficulty level of the entire program will increase. The INCLINE – button can be used in the same way to decrease the difficulty level of the program. Note: The incline settings shown in the LED matrix will not change; these are relative incline settings.

6 Watch your progress with the main display and the BIOLOGIX display.

See step 7 on page 12.

7 When the program is completed, remove the key from the console.

Make sure that the treadmill is at the lowest incline setting. Remove the key from the console and store the key in a secure place. In addition, press the on/off switch to the off position.

HOW TO USE THE FITNESS AGE TEST

⚠ WARNING: The **FITNESS AGE TEST** is not intended for medical evaluation. Various factors may affect the accuracy of fitness age readings. The **FITNESS AGE TEST** is intended only as an exercise aid in determining fitness trends in general.

The innovative **FITNESS AGE TEST** is designed to estimate your fitness level. Follow the steps below to use the **FITNESS AGE TEST**.

1 Plug in the power cord.

See step 1 on page 11.

2 Insert the key into the console.

See step 2 on page 11.

3 Put on the chest pulse sensor.

The chest pulse sensor must be worn when the **FITNESS AGE TEST** is used. To put on the chest pulse sensor, see How to Use the Chest Pulse Sensor on page 7.

4 Select the **FITNESS AGE TEST**.

When the key is inserted, the **QUICK START** mode will be selected. To select the **FITNESS AGE TEST**, press the **PROGRAM SELECT** button repeatedly until the **FITNESS AGE TEST** indicator lights. The LED track and the number 4 will then appear in the LED matrix. Note: If the incline of the treadmill is higher than 0%, it will automatically decrease to 0%.

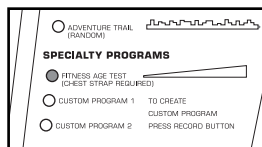

5 Enter your weight.

When the **FITNESS AGE TEST** is selected, the words "ENTER WEIGHT" will appear in the main display, the **ENTER WEIGHT** indicator will light, and the current weight setting will begin to flash in the **BIOLOGIX** display. If the

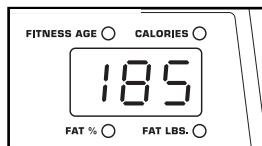

weight setting is correct, press the **ENTER** button. If you have not entered your weight, press the **BIOLOGIX +** and **-** buttons to enter your weight and then press the **ENTER** button.

6 Enter your age.

After you have entered your weight, the words "ENTER AGE" will appear in the main display, the **ENTER AGE** indicator will light, and the current age setting will begin to flash in the **BIOLOGIX** display. If the age setting is correct, press the **ENTER** button. If you have not entered your age, press the **BIOLOGIX +** and **-** buttons to enter your age and then press the **ENTER** button.

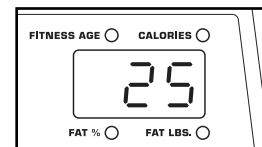

7 Enter your height.

After you have entered your age, the words "ENTER HEIGHT" will appear in the main display, the **ENTER HEIGHT** indicator will light, and the current height setting will begin to flash in the **BIOLOGIX** display. If the height setting is correct, press the **ENTER** button. If you have not entered your height, press the **BIOLOGIX +** and **-** buttons to enter your height and then press the **ENTER** button.

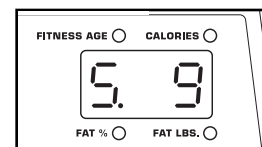

8 Enter your sex.

After you have entered your height, the words "MALE OR FEMALE" will appear in the main display and the **MALE** or **FEMALE** indicator will light. Press the **BIOLOGIX +** or **-** button until the correct indicator is lit and then press the **ENTER** button.

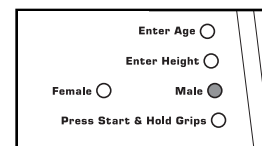

9 Press the **BIOLOGIX START** button.

After you have entered your sex, the words "PRESS BIO START" will appear in the main display and the corresponding indicator will light. When you press the **BIOLOGIX START** button, the words "HOLD GRIPS" will appear.

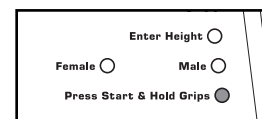

10 Hold the hand pulse sensor.

As soon as the words "HOLD GRIPS" appear, hold the hand pulse sensor. (See HOW TO USE THE HAND PULSE SEN-

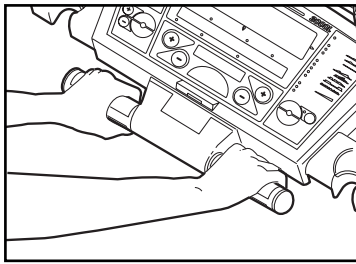

SOR on page 7). After about 5 to 60 seconds (the time varies from user to user), the words "HOLD STILL," "WALK FAST" and "DO NOT RUN" will appear in the main display. The words "PRESS PROGRAM START" will then appear in the main display.

11 Press the PROGRAM START button or the SPEED + button.

When the button is pressed, the LED track will disappear in a counterclockwise direction. One flashing indicator will then reappear, the walking belt will begin to move at 1.0 mph, and a one-mile walking test will begin. Hold the handrails and begin walking.

During the walking test, **use the SPEED buttons to adjust the speed of the walking belt so that you are walking as fast as you can without discomfort.** As you exercise, the LED matrix will count down the laps you have completed. When you have walked one mile, the walking belt will stop and the words "HOLD GRIPS" will appear in the main display.

12 Hold the hand pulse sensor.

As soon as the words "HOLD GRIPS" appear, hold the hand pulse sensor. After about 5 to 60 seconds, your fitness age will be displayed in the BIOLOGIX display. **If your fitness age is equal to your actual age, your fitness level is average for a person of your age. If your fitness age is lower than your actual age, your fitness level is above average for a person of your age. A lower fitness age indicates a greater fitness level.**

13 When the FITNESS AGE TEST is completed, remove the key from the console.

Make sure that the treadmill is at the lowest incline setting. Remove the key from the console and store the key in a secure place. In addition, press the on/off switch to the off position.

HOW TO CREATE A CUSTOM PROGRAM

The two CUSTOM programs are programs that you create. CUSTOM programs control both the speed and the incline of the treadmill, and can be up to 40 minutes long. The programs are saved in memory, and can be changed as many times as desired.

Follow the steps below to create a CUSTOM program.

1 Plug in the power cord.

See step 1 on page 11.

2 Insert the key fully into the console.

See step 2 on page 11.

3 Select one of the CUSTOM programs.

When the key is inserted, the QUICK START mode will be selected. To select one of the CUSTOM programs, press the PROGRAM SELECT button repeatedly until the CUSTOM PROGRAM 1 or CUSTOM PROGRAM 2 indicator lights. Note: If the incline of the treadmill is higher than 0%, it will automatically decrease to 0%.

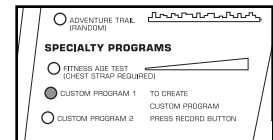

4 Enter your weight if desired.

When a CUSTOM program is selected, the words "ENTER WEIGHT" will appear in the main display, the ENTER WEIGHT indicator will light, and the current weight setting will begin to flash in the BIOLOGIX display. For the console to measure your calorie expenditure accurately, your weight should be entered into the console. Press the BIOLOGIX + and - buttons to enter your weight if desired.

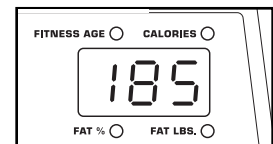

5 Press the PROGRAM START button or the SPEED + button to start the program.

When the button is pressed, the speed setting will flash in the main display. After a moment, the walking belt will begin to move at 1.0 mph. Hold the handrails and begin walking.

6 Press the RECORD button and program the desired speed and incline settings.

When the RECORD button is pressed, the RECORD indicator will light. **Speed and incline settings can be programmed only when the RECORD indicator is lit.**

Refer to the LED matrix. Each CUSTOM program is divided into one-minute periods. One speed setting and one incline setting can be programmed for each period.

The speed setting of the first period will be shown in the flashing column of the matrix.

(The incline settings are not shown in the matrix.) To program speed and incline settings for the first period, simply adjust the speed and incline of the treadmill as desired with the SPEED and INCLINE buttons. Every few times one of the SPEED buttons is pressed, one additional indicator will light or darken in the flashing column of the matrix.

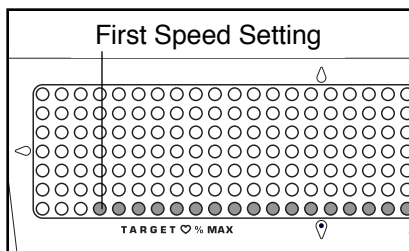

When only three seconds remain in the first one-minute period of the program, both the first and second speed settings in the matrix will flash. When the first period is completed, the current speed and incline settings will be saved in the console's memory. All speed settings in the matrix will then move one column to the left. The second speed setting will then flash. Program speed and incline settings for the second period as described above. Repeat this procedure until you have programmed speed and incline settings for as many periods as desired. When you are finished with your workout, hold down the STOP button for two seconds. Your CUSTOM program will then be saved in the console's memory.

To stop a CUSTOM program momentarily, press the STOP button. The main display will pause and the time will begin to flash. To restart the program, press the PROGRAM START button or the SPEED + button.

7 When the program is completed, remove the key from the console.

Make sure that the treadmill is at the lowest incline setting. Remove the key from the console and store the key in a secure place. In addition, press the on/off switch to the off position.

HOW TO USE A CUSTOM PROGRAM

1 Plug in the power cord.

See step 1 on page 11.

2 Insert the key fully into the console.

See step 2 on page 11.

3 Select one of the CUSTOM programs.

See step 3 on page 18.

4 Enter your weight if desired.

See step 4 on page 18.

5 Press the PROGRAM START button or the SPEED + button to start the program.

When the button is pressed, the speed setting will flash in the main display. After a moment, the walking belt will begin to move at 1.0 mph. Hold the handrails and begin walking.

Refer to the LED matrix. During the first one-minute period of the program, the first speed setting shown in the matrix will flash. When only three seconds remain in the first period, both the first and second speed settings in the matrix will flash. When the first period is completed, all speed settings in the matrix will move one column to the left. The second speed setting will then flash and the treadmill will adjust to the second speed setting. The incline of the treadmill will also change according to the incline setting that you programmed previously. At the end of each one-minute period of the program, all speed settings will move one column to the left, the next speed setting will flash, and the speed and incline of the treadmill will change according to the settings that you programmed previously.

When the TIME indicator is lit, the main display will show the time remaining in the program. When no time remains in the program, the walking belt will slow to a stop.

To stop the program momentarily, press the STOP button. The main display will pause and the time will begin to flash. To restart the program, press the PROGRAM START button or the SPEED + button. To end the program and reset the displays, hold down the STOP button for two seconds.

Note: While a CUSTOM program is in progress, the speed or incline setting of the current period can be adjusted with the SPEED or INCLINE buttons. However, adjustments will not be stored in memory. To **reprogram** the speed or incline setting of the current period, press down the RECORD button. The RECORD indicator will light. **Speed and incline settings can be reprogrammed only when the indicator is lit.** Adjust the speed or incline setting of the current period by pressing the SPEED or INCLINE buttons. After the current period is completed, press the RECORD button. The RECORD indicator will darken. The new settings will then be stored in the console's memory.

6 Watch your progress with the main display and the BIOLOGIX display.

See step 7 on page 12.

7 When the program is completed, remove the key from the console.

Make sure that the treadmill is at the lowest incline setting. Remove the key from the console and store the key in a secure place. In addition, press the on/off switch to the off position.

HOW TO MEASURE YOUR BODY FAT

Follow the steps below to measure your body fat.

1 Plug in the power cord.

See step 1 on page 11.

2 Insert the key into the console.

See step 2 on page 11.

3 Press the BIOLOGIX START button.

When the button is pressed, the word "BIOLOGIX" will appear in the LED matrix. Note: If the incline of the treadmill is higher than 0%, it will automatically decrease to 0%.

4 Enter your weight.

The words "ENTER WEIGHT" will appear in the main display, the ENTER WEIGHT indicator will light, and the current weight setting will



begin to flash in the BIOLOGIX display. If the weight setting is correct, press the ENTER button. If you have not entered your weight, press the BIOLOGIX + and – buttons to enter your weight and then press the ENTER button.

5 Enter your age.

After you have entered your weight, the words "ENTER AGE" will appear in the main display, the ENTER AGE indicator will light, and

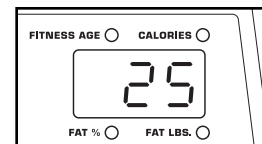

the current age setting will begin to flash in the BIOLOGIX display. If the age setting is correct, press the ENTER button. If you have not entered your age, press the BIOLOGIX + and – buttons to enter your age and then press the ENTER button.

6 Enter your height.

After you have entered your age, the words "ENTER HEIGHT" will appear in the main display, the ENTER HEIGHT indicator will light, and the current height setting will begin to flash in the BIOLOGIX display. If the height setting is correct, press the ENTER button. If you have not entered your height, press the BIOLOGIX + and – buttons to enter your height and then press the ENTER button.

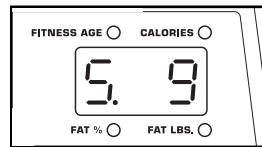

7 Enter your sex.

After you have entered your height, the words "MALE OR FEMALE" will appear in the main display and the MALE or FEMALE indicator will light. Press the BIOLOGIX + or – button until the correct indicator is lit and then press the ENTER button.

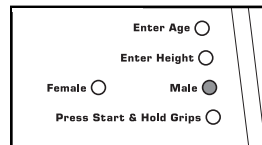

8 Press the BIOLOGIX START button.

After you have entered your sex, the words "PRESS BIO START" will appear in the main display and the corresponding indicator will light. When you press the BIOLOGIX START button, the words "HOLD GRIPS" will appear.

9 Hold the hand pulse sensor.

As soon as the words "HOLD GRIPS" appear, hold the hand pulse sensor. (See HOW TO USE THE HAND PULSE SENSOR on page 7). After about 5 to 60 seconds, the BIOLOGIX display will show your body fat percentage and your body fat in pounds, alternating between one number and the other every seven seconds.

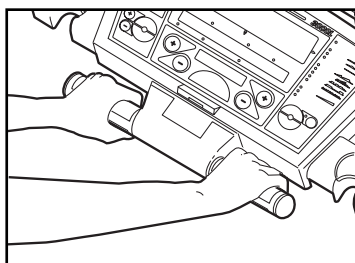

10 When you are finished exercising, remove the key from the console.

Make sure that the treadmill is at the lowest incline setting. Remove the key from the console and store the key in a secure place. In addition, press the on/off switch to the off position.

HOW TO SELECT THE INFORMATION MODE

The console features an information mode that shows the total number of hours that the treadmill has been used and the total distance that the walking belt has moved. To access the information mode, hold down the STOP button while inserting the key into the console.

Two numbers will appear in the main display.

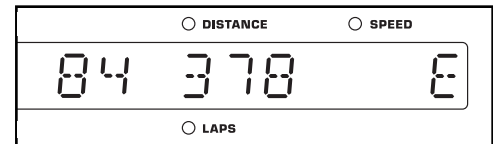

The number on the left is the number of hours that the treadmill has been used. The number on the right is the number of miles that the walking belt has moved.

An "E" for English miles or an "M" for metric kilometers will also appear in the main display. Pressing the SPEED + button will change the unit of measurement.

To exit the information mode, remove the key.

HOW TO ADJUST THE WALKING PLATFORM

The walking platform is designed to cushion the impact as you walk or run on the treadmill. To increase the firmness of the walking platform, turn the adjustment knob clockwise. To

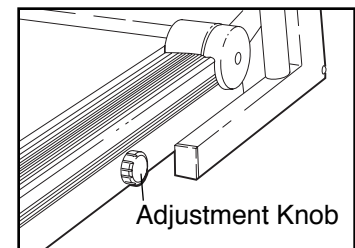

decrease the firmness, turn the knob counterclockwise. Note: The faster you run on the treadmill, the firmer the walking platform should be. If the walking platform is not adjusted correctly, the treadmill may bounce excessively.

HOW TO USE THE HAND WEIGHTS

To exercise your upper body as you walk on the treadmill, hold the 2-pound weights at your sides or press the weights above your head. To increase the intensity of your exercise, use the 4-pound weights. The hand weights can be stored in the console.

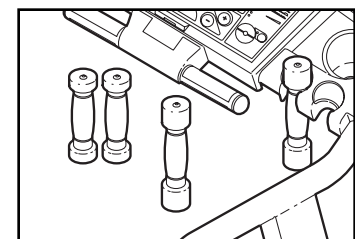

WARNING: Do not use the hand weights at speeds faster than a walk. Using weights and not holding the handrails may compromise your ability to maintain your balance. Exercises using weights should be attempted only by experienced users.

How to Fold and Move the Treadmill

HOW TO FOLD THE TREADMILL FOR STORAGE

Before folding the treadmill, adjust the incline to the lowest position. Next, unplug the power cord. **Caution: You must be able to safely lift 45 pounds (20 kg) in order to raise, lower, or move the treadmill.**

1. Hold the treadmill with your hands in the locations shown at the right. **To decrease the possibility of injury, bend your legs and keep your back straight. As you raise the treadmill, make sure to lift with your legs rather than your back.** Raise the treadmill halfway to the vertical position.

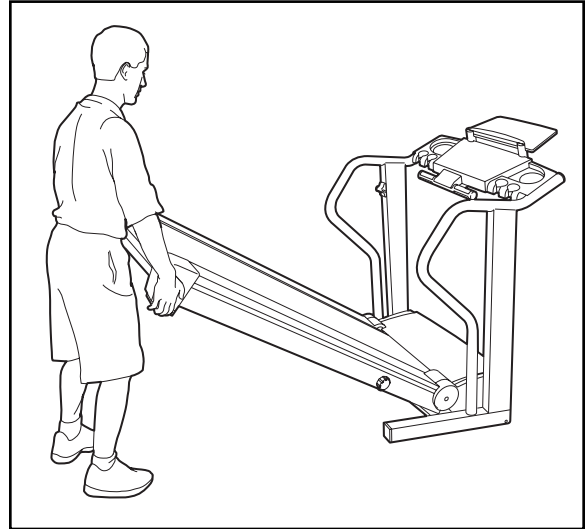

2. Move your right hand to the position shown and hold the treadmill firmly. Hold the lock knob with your left hand and pull it to the side. Raise the treadmill until the lock knob is aligned with the slot in the catch. Slowly release the knob. **Make sure that the pin on the lock knob is inside the slot.**

To protect the floor or carpet from damage, place a mat under the treadmill. Keep the treadmill out of direct sunlight. Do not leave the treadmill in the storage position in temperatures above 85° Fahrenheit.

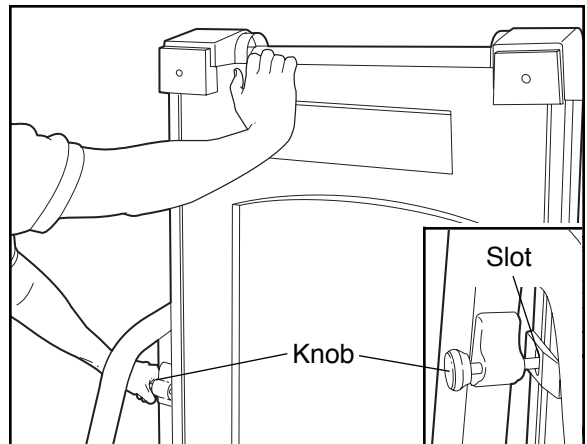

HOW TO MOVE THE TREADMILL

Before moving the treadmill, convert the treadmill to the storage position as described above. **Make sure that the storage latch is inserted into the slot in the side of the frame.**

1. Hold the handrails as shown and place one foot near a wheel. **Do not hold or push on the book holder or the book holder may be damaged.**
2. Tilt the treadmill **in the direction shown** until it rolls freely on the front wheels. Carefully move the treadmill to the desired location. **To reduce the risk of injury, use extreme caution while moving the treadmill and do not attempt to move the treadmill over an uneven surface. Tip the treadmill only onto the front wheels. Tipping the treadmill in the opposite direction could cause the treadmill deck to fall on you.**
3. Place one foot on the base, and carefully lower the treadmill until it is resting in the storage position.

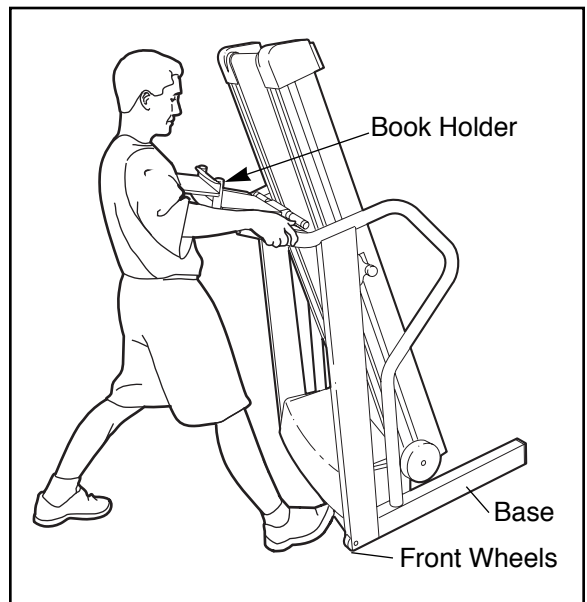

HOW TO LOWER THE TREADMILL FOR USE

1. Hold the upper end of the treadmill with your right hand as shown. Hold the lock knob with your left hand and pull it to the side. Pivot the treadmill down a few inches.

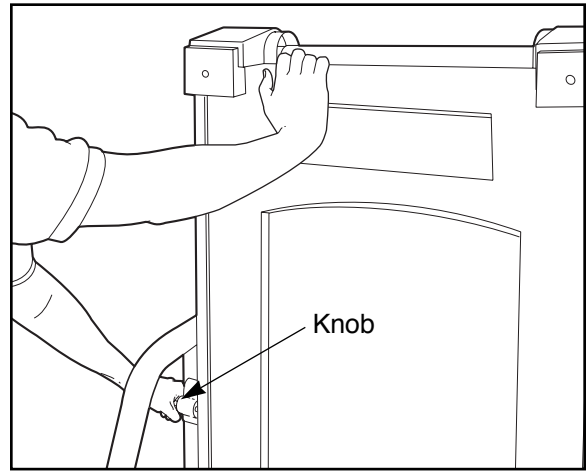

2. Hold the treadmill firmly with both hands, and lower the treadmill to the floor. **To decrease the possibility of injury, bend your legs and keep your back straight.**

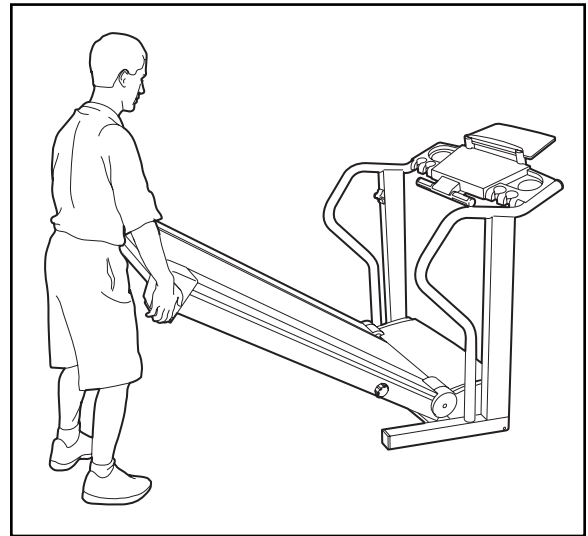

Maintenance and Trouble-shooting

Most treadmill problems can be solved by following the steps below. Find the symptom that applies, and follow the steps listed.

If further assistance is needed, please contact our Customer Service Department.

1. SYMPTOM: THE POWER DOES NOT TURN ON

- Make sure that the power cord is plugged into a surge protector, and that the surge protector is plugged into a properly grounded outlet. (See How to Plug in the Power Cord on page 9.) Use only a UL-listed surge protector, rated at 15 amps, with a 14-gauge cord of five feet or less in length. If using a surge protector with a power switch, make sure that the power switch is in the “on” position.
- After the power cord has been plugged in, make sure that the key is fully inserted into the console. (See step 1 on page 11.)
- Check the circuit breaker located on the treadmill near the power cord. If the switch protrudes as shown, the circuit breaker has tripped. To reset the circuit breaker, wait for five minutes and then press the switch back in.
- Check the on/off switch located at the front of the treadmill near the power cord. The switch must be in the “on” position.

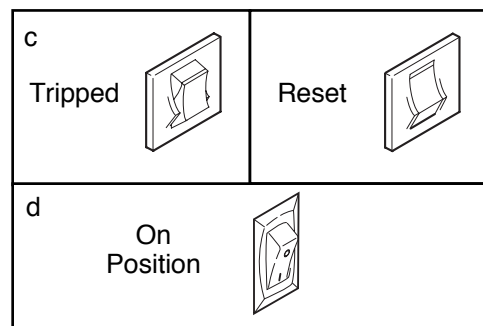

2. SYMPTOM: THE POWER TURNS OFF DURING USE

- Check the circuit breaker located on the treadmill frame near the power cord (see 1. c. above). If the circuit breaker has tripped, wait for five minutes and then press the switch back in.
- Check to make sure that the on/off switch is in the on position. (See 1. d. above.)
- Make sure that the power cord is plugged in.
- Remove the key from the console. Reinsert the key fully into the console. (See step 1 on page 11.)
- If the treadmill still will not run, please call our Customer Service Department.

3. SYMPTOM: AN ERROR CODE (“E1” OR “E6”) APPEARS ON THE CONSOLE

- If the console detects an incline error, an “E6” may appear in the INCLINE/DISTANCE display when the INCLINE buttons are pressed, and when the display shows the current incline level. If this error code appears, remove the key from the console, wait for ten seconds, and then reinsert the key. If the error code appears again, call our Customer Service Department. **Do not operate the treadmill until the problem is corrected.**
- If the console detects a speed error (no speed signal, an erratic speed signal, etc.), an “E1” may appear in the SPEED display. If this error codes appears, remove the key from the console, wait for ten seconds, and then reinsert the key. If the error code appears again, call our Customer Service Department. **Do not operate the treadmill until the problem is corrected.**

4. SYMPTOM: THE WALKING BELT IS OFF-CENTER WHEN WALKED ON

a. If the walking belt has shifted to the left, first remove the key and **UNPLUG THE POWER CORD**. Using the included allen wrench, turn the left rear roller adjustment bolt clockwise, and the right bolt counterclockwise, 1/4 of a turn each. Be careful not to overtighten the walking belt. Plug in the power cord, insert the key and run the treadmill for a few minutes. Repeat until the walking belt is centered.

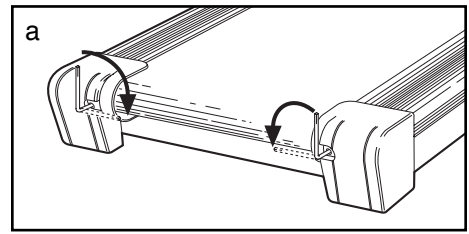

b. If the walking belt has shifted to the right, first remove the key and **UNPLUG THE POWER CORD**. Using the allen wrench, turn the left rear roller adjustment bolt counterclockwise, and the right bolt clockwise, 1/4 of a turn each. Be careful not to overtighten the walking belt. Plug in the power cord, insert the key and run the treadmill for a few minutes. Repeat until the walking belt is centered.

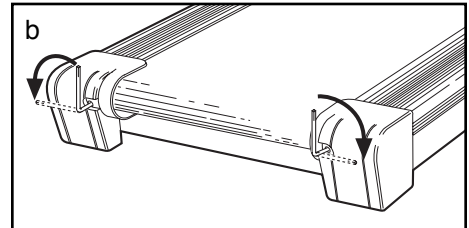

c. If the walking belt slips when walked on, first remove the key and **UNPLUG THE POWER CORD**. Using the allen wrench, turn both rear roller adjustment bolts clockwise, 1/4 of a turn. When the walking belt is correctly tightened, you should be able to lift **the edges** of the walking belt 3 to 4 inches off the walking platform. Be careful to keep the walking belt centered. Plug in the power cord, insert the key and run the treadmill for a few minutes. Repeat until the walking belt is properly tightened.

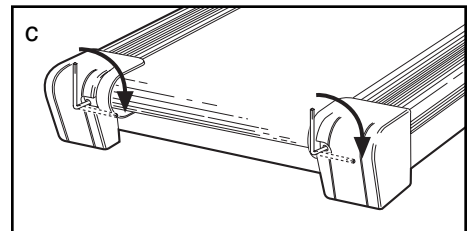

5. SYMPTOM: THE WALKING BELT SLOWS WHEN WALKED ON

a. Use only a UL-listed surge protector, rated at 15 amps, with a 14-gauge cord of five feet or less in length.

b. If the walking belt is overtightened, treadmill performance may decrease and the walking belt may be permanently damaged. Remove the key and **UNPLUG THE POWER CORD**. Using the allen wrench, turn both rear roller adjustment bolts counterclockwise, 1/4 of a turn. When the walking belt is correctly tightened, you should be able to lift **the edges** of the walking belt 3 to 4 inches off the walking platform. Be careful to keep the walking belt centered. Plug in the power cord, insert the key and run the treadmill for a few minutes. Repeat until the walking belt is properly tightened.

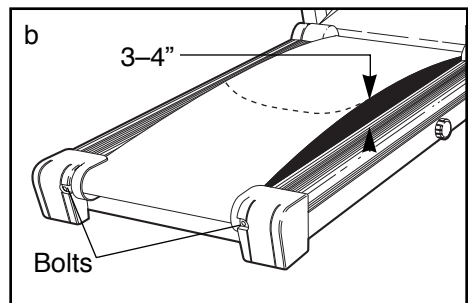

c. If the walking belt still slows when walked on, please contact our Customer Service Department.

6. SYMPTOM: THE DISPLAYS OF THE CONSOLE DO NOT FUNCTION PROPERLY

a. Remove the key from the console and **UNPLUG THE POWER CORD**. Remove the screws from the hood. Carefully remove the hood. Locate the Reed Switch (52) and the Magnet (25) on the left side of the Pulley (24). Turn the Pulley until the Magnet is aligned with the Reed Switch. **Make sure that there is a 1/8" gap between the Magnet and the Reed Switch**. If necessary, loosen the Screw (15) and move the Reed Switch slightly. Retighten the Screw. Re-attach the hood, and run the treadmill for a few minutes to check for a correct speed reading.

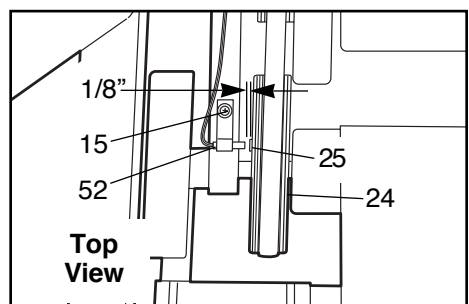

Conditioning Guidelines

FACTORS IN A SENSIBLE DIET

- Choose high-fiber, low-fat, and low-in-sugar foods: fruits, vegetables, and whole grains.
- Eat at least five servings of fruits and vegetables each day.
- Cut back on red meat consumption; eat lean meat, white meat, and fish.
- Choose healthy snacks; bring healthy foods with you to work or in the car.
- Eat regular meals or mini-meals. Control your portion size—don't binge or overeat. Eat slowly.
- Reduce fast food and pre-packaged meals.
- Pay attention to fat content and calories.
- Limit alcoholic beverages and caffeine.
- Drink at least eight to ten glasses of water a day.

EXERCISE STEPS

The following nine steps for designing your exercise program were developed by exercise physiologists at NordicTrack. The actual exercise you perform is only a part of a safe and effective training program. There are many other aspects to developing a life-long commitment to physical fitness.

1 Consult your physician before beginning any exercise program.

A medical examination or consultation with your physician is essential.

2 Establish personal fitness goals.

Set attainable, realistic goals. Reward yourself when you meet those goals. Remember, your goals should act as a guide for your workout program.

3 Determine your target heart rate.

Your target heart rate (THR), is the rate at which you would like your heart to work during aerobic exercise. It is expressed as a percentage of your maximum heart rate (MHR). MHR is the maximum number of times that your heart can pump during one minute. To determine your approximate MHR, subtract your age (in years) from 220. This is only an estimation of your MHR—only clinical stress testing can provide an actual MHR reading.

Once you have determined your MHR, you can establish your target heart rate zone. Beginning exercisers may wish to start at 60 to 70 percent of their MHR. This level is called the Health level. Exercise at 70 to 85 percent of your MHR for the optimal training, aerobic, or cardiovascular level—the Fitness level. Advanced exercisers, or those wishing to do sports, athletic conditioning, or interval training workouts should exercise at 80 to 85 percent of the MHR for short periods of time. The chart below shows Target Heart Rate Zones for Health, Fitness, and Advanced exercisers.

Be sure to check your heart rate at least twice during an aerobic conditioning session. First, check your heart rate five minutes into your workout to be sure that you are at the proper intensity. Then, check it again near the end of your workout to verify that you have maintained your target heart rate for the recommended period of time.

TARGET HEART RATE ZONES

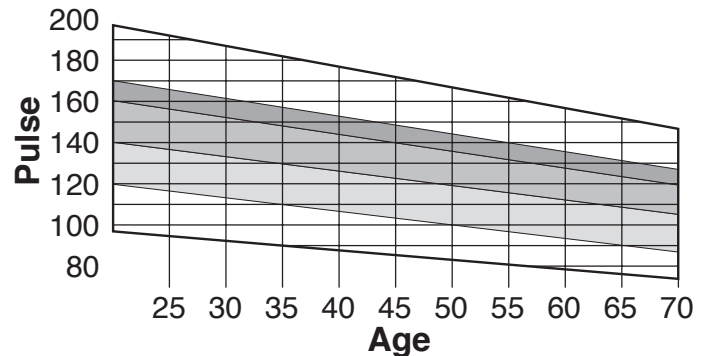

Health	Fitness	Advanced
Beginner, low-intensity + long duration = fat burning	Optimal training, aerobic or cardiovascular	Sports, athletic conditioning, interval training

WEIGHT LOSS TIPS

At least four, 30-minute workouts per week, along with a reduced-calorie diet, are recommended if you are trying to lose weight. However, be sure to stay within your target heart rate zone and exercise a maximum of 5 days per week for 60 minutes per workout.

Good posture is the key to safe, comfortable workouts. Keep your chin up and your head facing forward. Align your head and shoulders with your hips. Avoid leaning forward. Keep your back straight.

4 Warm up before you begin.

A warm-up routine prepares your body and mind for vigorous exercise. It also provides insurance against injury and soreness. Warm up with two to five minutes of slow exercise, at minimal intensity.

5 Stretch after your warm-up.

A pliable, well-stretched muscle is less susceptible to injury. Perform the recommended stretches on a smooth, flat surface.

The correct form for several stretches is described below (refer to the drawings at the right). Be sure to move slowly as you stretch—never bounce.

1. Toe Touch Stretch—Sit with your knees bent slightly and slowly bend forward from your hips. Allow your back and shoulders to relax as you reach toward your toes as far as possible. Hold for 15 to 30 seconds, then relax. Repeat 3 times. Stretches: Hamstrings, back of knees, and back.

2. Calf/Achilles Stretch—With one leg in front of the other, reach forward and place your hands against a wall. Keep your back leg straight and your back foot flat on the floor. Bend your front leg, lean forward, and move your hips toward the wall. Hold for 15 to 30 seconds, then relax. Repeat 3 times for each leg. To cause further stretching of the achilles tendons, bend your back leg as well. Stretches: Calves, achilles tendons, and ankles.

3. Hamstring Stretch—Sit with one leg extended. Bring the sole of the opposite foot toward you and rest it against the inner thigh of your extended leg. Reach toward your toes as far as possible. Hold for 15 to 30 seconds, then relax. Repeat 3 times for both legs. Stretches: Hamstrings, lower back, and groin.

4. Inner Thigh Stretch—Sit with the soles of your feet together and your knees outward. Pull your feet toward your groin area as far as possible. Hold for 15 to 30 seconds, then relax. Repeat 3 times. Stretches: Quadriceps and hip muscles.

5. Quadriceps Stretch—With one hand against a wall for balance, reach back and grasp one foot with your other hand. Bring your heel as close to your buttocks as possible. Hold for 15 to 30 seconds, then relax. Repeat 3 times for each leg. Stretches: Quadriceps and hip muscles.

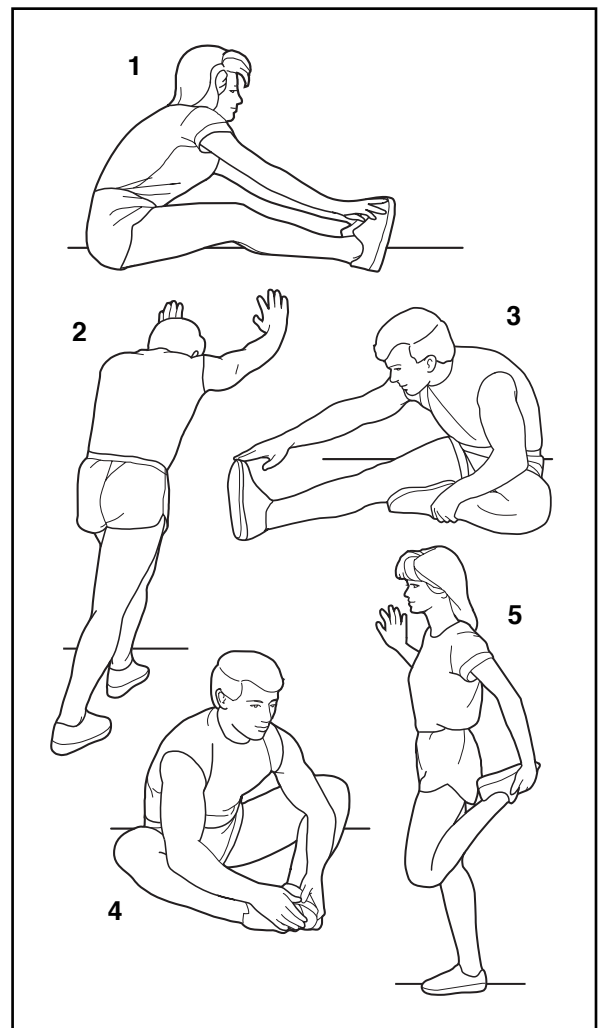

BENEFITS OF AEROBIC EXERCISE

- Effective weight loss and management
- Added protection from heart disease
- Increased strength and health of bones
- Higher levels of energy for greater productivity during the day
- Healthy stress relief from a pressure-packed day
- Greater intellectual capacity and productivity

6 Get FIT with the PowerTread 3000L.

Effective aerobic exercise has three major parts: frequency, intensity, and time. The acronym "FIT" may help you to remember these three parts:

F "F" stands for the frequency of your workouts. Three to five workouts per week are recommended. Exercise at least four times a week for weight loss.

I "I" refers to the intensity of your workout. Check your heart rate at least twice during your aerobic exercise session: once during the session and once again at the end. Maintain a workout intensity level within your Target Heart Rate Zone. You can measure your heart rate using the hand pulse sensor or the chest pulse sensor.

T "T" is for the time or duration of your workout. Beginning exercisers may wish to start with 5 to 10 minutes of aerobic activity. Those in average physical condition should exercise for 20 to 30 minutes. Highly fit people, or people who want to lose weight, should exercise for 30 to 60 minutes. The key to the time factor is that you maintain your target heart rate for the duration of the workout period.

Remember to take it slowly. Fitness is a lifelong commitment. If you can't go the full 20 minutes from the start, which is common, try to exercise for five minutes at a time, a couple of times a day.

Recent research indicates that several short workouts in one day can also provide fitness benefits. Gradually, your stamina will increase and it will become easier to exercise for longer periods of time.

7 Cool down after aerobic exercise.

Keep moving! It is important that you cool down properly to allow your heart rate to decrease slowly after it has been elevated. This helps the blood flow from your extremities back to your heart. Keep your legs moving on the treadmill at a slower pace for at least five minutes following the aerobic phase.

8 Stretch again at the end of your exercise session.

Stretching after exercise reduces muscle soreness. See step 5 on page 27.

9 Participate in strength training.

"Balanced fitness, including both strength training and aerobic exercise, can do more to ensure a happy life than just about anything else known to medical science today."

—Kenneth Cooper, M.D., M.P.H., founder of The Cooper Institute For Aerobic Research, Dallas, Texas.

A strength-training program increases your lean muscle mass. Lean muscle mass aids in burning body fat. With additional muscle mass and strength, you will receive the full benefits of an exercise program. You will also be less prone to injuries during the aerobic phase of your workout.

WORKOUT TIPS

Full-body conditioning helps take care of many of life's aches and pains. However, it takes time for your body to adapt to any new routine. Below are some tips that will help ease you into your new NordicTrack routine.

- Begin and end each exercise session with the stretches on page 19. Stretch in a smooth, controlled manner. Hold each stretch for 15 to 30 seconds. You may experience some initial muscle soreness and discomfort as a result of exercising inactive or poorly stretched muscles. For maximum benefit, a stretching routine must be performed every day.
- Be aware of your body's signals and react to them accordingly. At your correct exercise intensity, you should be able to whistle or maintain a normal conversation. If during exercise you feel tired, light-headed, dizzy, or nauseated, stop exercising immediately and consult your physician. Your heart rate may also be affected by such things as stress, caffeine, nicotine or prescription drugs.

WORKOUT PROGRAMS

The Health level typically lasts four to six weeks. At this level you should be concerned with slowly improving your fitness level and endurance.

Take it slowly. Set mini-goals for yourself. You may want to begin your fitness routine with three or four short, 5- or 10-minute workouts in a day.

Move on to the Fitness Level only when you feel ready and your heart rate has moved below your target heart rate zone.

The Fitness level usually lasts 12 to 20 weeks. (It may last longer, depending on your fitness goals.) At this level you should strive to achieve your fitness goals.

Set realistic short- and long-term goals for yourself. Frequently re-evaluate your fitness goals and reward yourself as you are successful.

Move on to the Advanced Level when you have reached your fitness goals and your heart rate has moved below your target heart rate zone.

Work out at the Advanced level once you have reached your desired fitness goals. It is intended to be a maintenance program and should continue on a regular, long-term basis.

You may wish to add Interval Training to your maintenance program as well. Interval training will add variety to your workout routine and further condition your cardiovascular system. Interval training has been shown to promote higher levels of aerobic conditioning. It consists of spurts of high-intensity activity followed by active rest periods of exercise at a lower intensity.

For example, a one-minute spurt of high-resistance, fast exercise* is followed by a two- to three-minute active rest period of low-resistance, slow exercise. The duration of these periods should be based more on how you feel rather than time. A sequence such as this should be repeated 5 to 20 times during your workout session.

*Estimated maximum heart rate (MHR) = 220 – your age.

Heart Rate Intensity

HEART RATE INTENSITY	Age	20	30	40	50	60	70	80
60% - 70% HEALTH	b.p.m.	120-140	114-133	108-126	102-119	96-112	90-105	84-98
70% - 85% FITNESS	b.p.m.	140-170	133-162	126-153	119-145	112-136	105-128	98-119
80% - 85% ADVANCED	b.p.m.	160-170	152-162	144-153	136-145	128-136	120-128	112-119

Part List—Model No. NTTL24080

R0599A

To find the parts listed below, refer to the Exploded Drawing attached in the center of this user's manual.

Key No.	Qty.	Description	Key No.	Qty.	Description
1	2	Cushion Plate	53	1	Electronics Bracket
2	4	Cushion Plate Screw	54	1	Incline Motor
3	2	Adjustable Deck Cushion	55	1	Controller
4	2	Rod Screw	56	8	Base Pad
5	1	Cushion Rod	57	4	Wheel Spacer
6	1	Cushion Knob Screw	58	4	Plastic Stand-Off
7	1	Cushion Knob	59	1	Power Board w/Clips
8	2	Foot Rail Cover	60	2	Caution Decal
9	1	Left Foot Rail	61	8	Belly Pan Spacer
10	1	Left Foot Rail Endcap	62	8	Belly Pan Screw
11	2	Endcap Screw	63	1	Sensor Unit
12	15	Plastic Fastener	64	1	Right Rear Endcap
13	2	Front Isolator	65	2	Endcap Washer
14	2	Motor Mount Washer	66	2	Endcap Screw
15	32	3/4" Screw	67	2	Frame Endcap
16	2	Cushion Board	68	2	Rear Roller Adj. Bolt
17	2	Platform Screw	69	1	Warning Decal
18	2	Motor Star Washer	70	1	Belly Pan
19	2	Rear Isolator	71	1	Left Rear Endcap
20	1	Catch	72	1	Rear Roller
21	4	Catch Screw	73	2	Frame Pivot Bolt
22	1	Walking Platform	74	2	Frame Pivot Washer
23	1	Walking Belt	75	1	Left Frame Pivot Cap
24	1	Front Roller/Pulley	76	24	Small Screw
25	1	Magnet	77	1	Motor Hood
26	4	Motor Mount Nut	78	2	4-pound Weight
27	1	Motor	79	1	Belly Pan
28*	1	Motor Assembly	80	1	Power Cord
29	1	Front Roller Pulley	81	1	Power Cord Grommet
30	1	Motor Adjustment Bolt	82	1	Circuit Breaker
31	1	Motor Plate	83	1	On/Off Switch
32	1	Motor Pivot Nut	84	2	Upright Endcap
33	1	Motor Mount Plate	85	1	Releasable Tie
34	4	Motor Isolator	86	1	Tie Clamp Screw
35	4	Motor Bolt	87	1	Tie Clamp
36	2	Motor Mount Bolt	88	8	8" Cable Tie
37	5	Frame Pivot Nut	89		4" Cable Tie
38	2	Frame Spacer	90	1	8" Green Ground Wire
39	1	Reed Switch Clip	91	2	Shock
40	1	Frame	92	1	Upright/Base
41	5	Screw	93	2	Lift Frame Bolt
42	2	Side Hood Mount	94	2	Receiver Screw
43	2	Front Hood Mount	95	1	Receiver
44	1	Transformer	96*	1	Hand Pulse Sensor
45	1	Bottom Incline Motor Bolt	97	1	Motor Pivot Bolt
46	4	Incline Motor Nut/Lift Frame Nut	98	2	Latch Bolt
47	1	Lift Frame	99	1	Top Incline Motor Bolt
48	2	Motor Tension Nut	100	1	Lock Pin
49	5	Roller Adj. Washer/Latch Washer	101	1	Lock Pin Clip
50	3	Front Roller Nut/Cushion Nut	102	1	Lock Pin Collar
51	1	Incline Sensor Wire	103	1	Lock Pin Spring
52	1	Motor Belt	104	1	Latch Bracket

Key No.	Qty.	Description	Key No.	Qty.	Description
105	1	Lock Knob	123	1	Right Frame Pivot Cap
106	2	Handrail Endcap	124	1	Right Foot Rail Endcap
107	1	Console	125	2	Belt Guide
108	1	Chest Pulse Sensor	#	1	32" Black/Yellow Wire Harness
109	1	Book Lens	#	1	32" Black/White Wire Harness
110	1	Book Holder	#	1	4" Blue Wire, M/F
111	2	Book Holder Screw	#	1	14" Blue Wire, 2 F
112	2	Book Holder Cap	#	1	8" Green Wire, F/Ring
113	1	Key/Clip	#	1	14" White Wire, 2F
114	1	10" Pulse Wire Harness	#	1	14" White Wire, M/F
115	2	Bottle Holder Insert	#	1	26" Pulse Wire Harness
116	1	Console Base	#	1	User's Manual
117	2	2-pound Weight			
118	1	Upright Wire Harness			
119	2	Front Wheel			
120	2	Front Wheel Bolt			
121	1	Allen Wrench			
122	1	Right Foot Rail			

*Includes all parts shown in the box.

#These parts are not illustrated

Specifications are subject to change without notice.

How to Order Replacement Parts

To order replacement parts, call our Customer Service Department toll-free at 1-800-999-3756, Monday through Friday, 6 a.m. until 6 p.m. Mountain Time (excluding holidays). When ordering parts, please be prepared to give the following information:

- The MODEL NUMBER OF THE PRODUCT (NTTL24080).
- The NAME OF THE PRODUCT (NordicTrack PowerTread™ 3000L).
- The SERIAL NUMBER OF THE PRODUCT (see the front cover of this manual).
- The KEY NUMBER AND DESCRIPTION OF THE PART(S) (see the Exploded Drawing attached to the center of this manual, and the Part List on pages 30 and 31).

Exploded Drawing—Model No. NTTL24080

R0599A

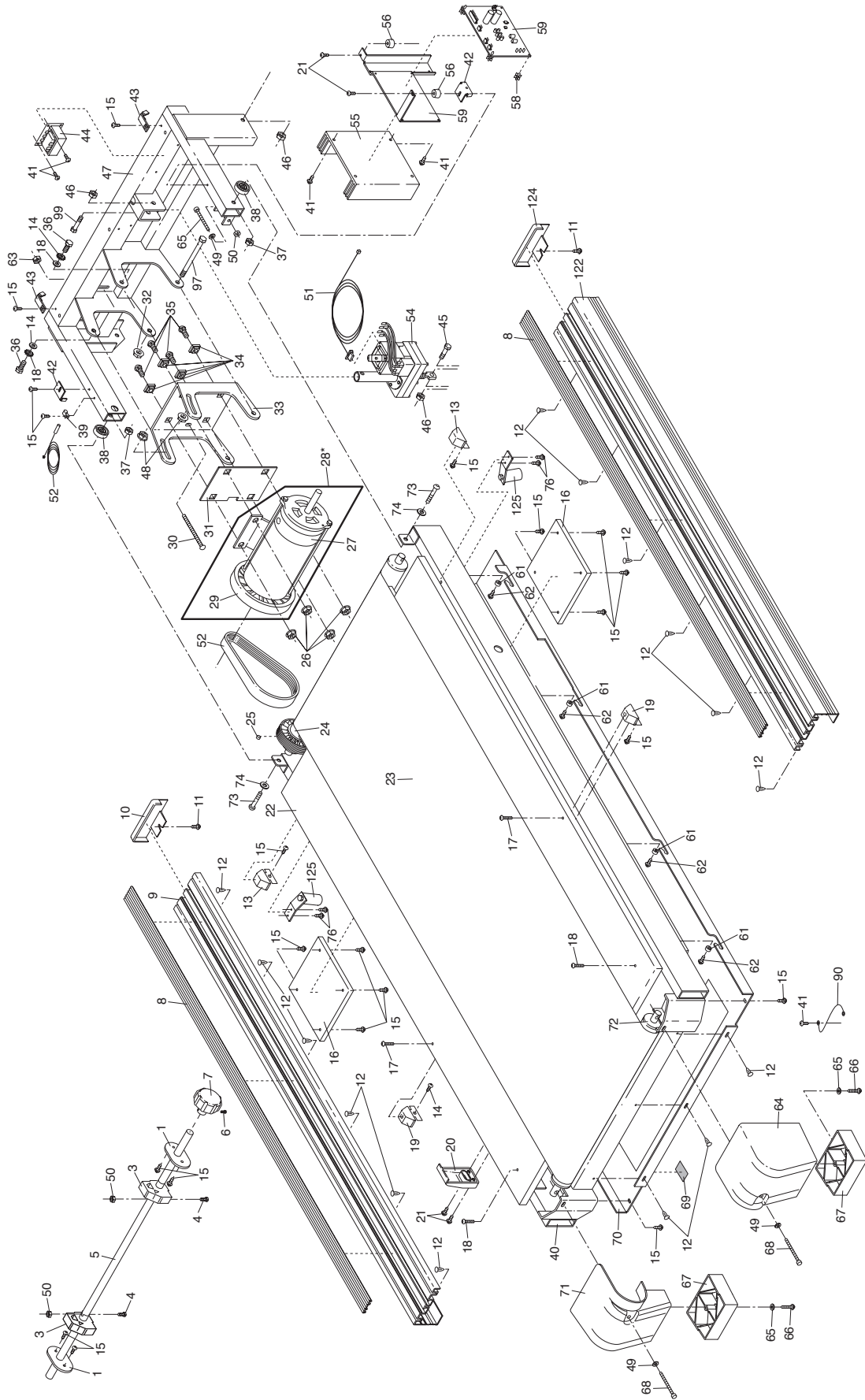

Exploded Drawing—Model No. NTTL24080

R0599A

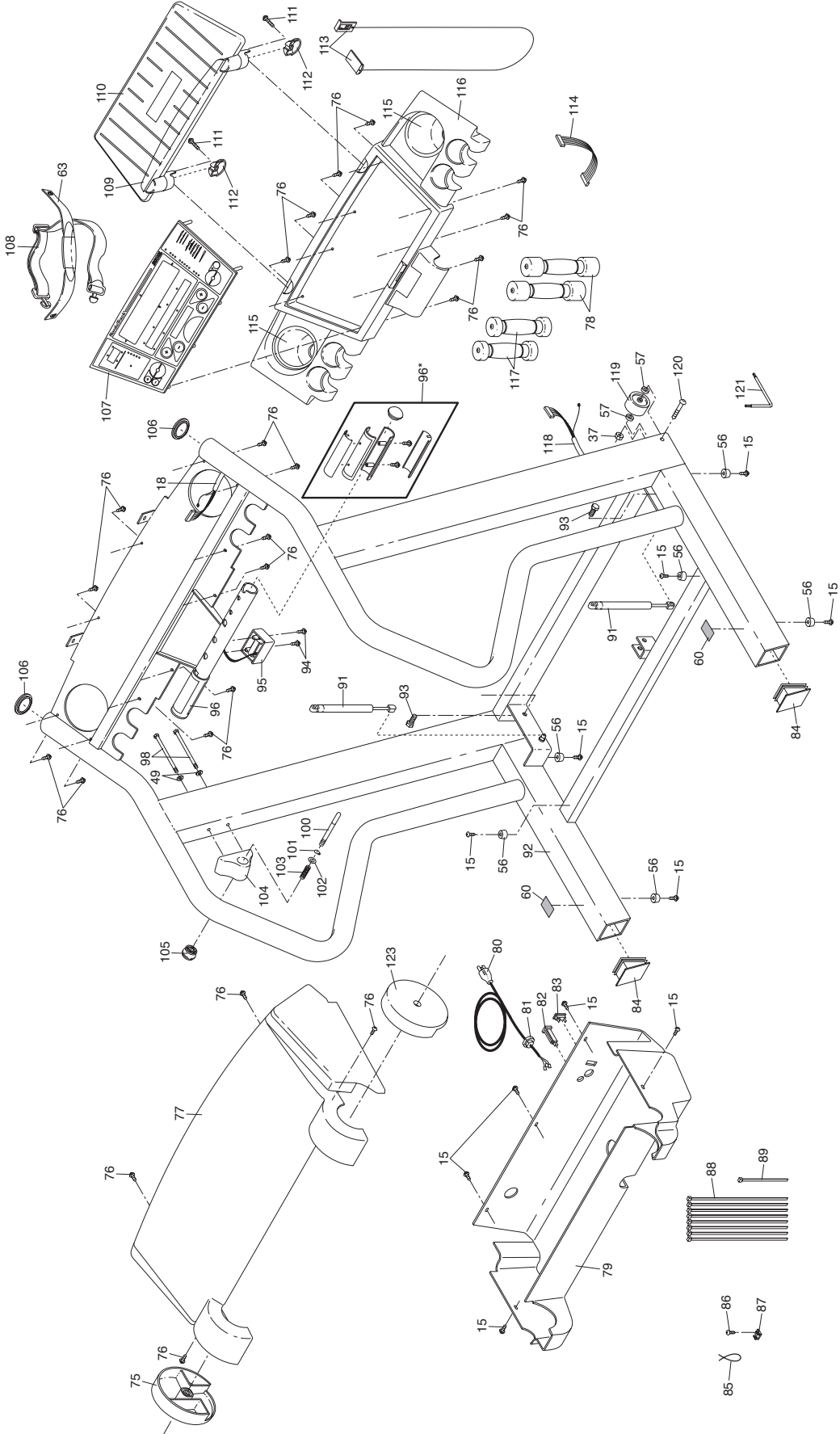

Limited Warranty

WHAT IS COVERED—The entire NordicTrack PowerTread™ 3000L (“Product”) is warranted to be free of all defects in material and workmanship.

WHO IS COVERED—The original purchaser or any person receiving the Product as a gift from the original purchaser.

HOW LONG IS IT COVERED—ICON Health & Fitness, Inc. (“ICON”), warrants the motor for three years after the date of purchase. All other parts are covered for two years after the date of purchase. Labor is covered for one year.

WHAT WE DO TO CORRECT COVERED DEFECTS—We will ship to you, without charge, any replacement part or component, providing the repairs are authorized by ICON first and are performed by an ICON trained and authorized service provider, or, at our option, we will replace the Product.

WHAT IS NOT COVERED—Any failures or damage caused by unauthorized service, misuse, accident, negligence, improper assembly or installation, alterations, modifications without our written authorization or by failure on your part to use, operate, and maintain as set out in your User’s Manual (“Manual”).

WHAT YOU MUST DO—Always retain proof of purchase, such as your bill of sale; store, operate, and maintain the Product as specified in the Manual; notify our Customer Service Department of any defect within 10 days after discovery of the defect; as instructed, return any defected part for replacement or, if necessary, the entire product, for repair.

USER’S MANUAL—It is VERY IMPORTANT THAT YOU READ THE MANUAL before operating the Product. Remember to do the periodic maintenance requirements specified in the Manual to assure proper operation and your continued satisfaction.

HOW TO GET PARTS AND SERVICE—Simply call our Customer Service Department at 1-800-999-3756 and tell them your name and address and the serial number of your Product. They will tell you how to get a part replaced, or if necessary, arrange for service where your Product is located or advise you how to ship the Product for service. Before shipping, always obtain a Return Authorization Number (RA No.) from our Customer Service Department; securely pack your Product (save the original shipping carton if possible); put the RA No. on the outside of the carton and insure the product. Include a letter explaining the product or problem and a copy of your proof of purchase if you believe the service is covered by warranty.

ICON is not responsible or liable for indirect, special or consequential damages arising out of or in connection with the use or performance of the product or damages with respect to any economic loss, loss of property, loss of revenues or profits, loss of enjoyment or use, costs of removal, installation or other consequential damages of whatsoever nature. Some states do not allow the exclusion or limitation of incidental or consequential damages. Accordingly, the above limitation may not apply to you.

The warranty extended hereunder is in lieu of any and all other warranties and any implied warranties of merchantability or fitness for a particular purpose is limited in its scope and duration to the terms set forth herein. Some states do not allow limitations on how long an implied warranty lasts. Accordingly, the above limitation may not apply to you.

No one is authorized to change, modify or extend the terms of this limited warranty.

This warranty gives you specific legal rights and you may have other rights which vary from state to state.

ICON HEALTH & FITNESS, INC., 1500 S. 1000 W., LOGAN, UT 84321-9813

Free Manuals Download Website

<http://myh66.com>

<http://usermanuals.us>

<http://www.somanuals.com>

<http://www.4manuals.cc>

<http://www.manual-lib.com>

<http://www.404manual.com>

<http://www.luxmanual.com>

<http://aubethermostatmanual.com>

Golf course search by state

<http://golfingnear.com>

Email search by domain

<http://emailbydomain.com>

Auto manuals search

<http://auto.somanuals.com>

TV manuals search

<http://tv.somanuals.com>