



**NORTEL**

Nortel Communication Server 1000

# Linux Platform Base and Applications Installation and Commissioning

Release: Release 5.5  
Document Revision: 02.09

[www.nortel.com](http://www.nortel.com)

---

NN43001-315

Nortel Communication Server 1000  
Release: Release 5.5  
Publication: NN43001-315  
Document release date: 29 October 2008

Copyright © 2007–2008 Nortel Networks  
All Rights Reserved.

Sourced in Canada

#### LEGAL NOTICE

While the information in this document is believed to be accurate and reliable, except as otherwise expressly agreed to in writing NORTEL PROVIDES THIS DOCUMENT "AS IS" WITHOUT WARRANTY OR CONDITION OF ANY KIND, EITHER EXPRESS OR IMPLIED. The information and/or products described in this document are subject to change without notice.

Nortel, the Nortel logo, the Globemark, SL-1, Meridian 1, and Succession are trademarks of Nortel Networks. All other trademarks are the property of their respective owners.

---

# Contents

---

<b>New in this Release</b>	<b>5</b>
Security hardening	5
Features	5
Installation times	5
CLI commands	6
Upgrade procedure	6
Alarms	6
Screen captures	6
Firewall ports	6
Task flow diagrams	6
Other changes	6
Revision history	7
<hr/>	
<b>How to get help</b>	<b>9</b>
Getting help from the Nortel Web site	9
Getting help over the telephone from a Nortel Solutions Center	9
Getting help from a specialist by using an Express Routing Code	10
Getting help through a Nortel distributor or reseller	10
<hr/>	
<b>Introduction</b>	<b>11</b>
Subject	11
Linux base overview	12
Key features	12
<hr/>	
<b>Linux base and applications installation and upgrade task flow</b>	<b>13</b>
Task flows for individual servers	13
Task flows for common combinations of servers	21
ECM Upgrade Procedures	28
<hr/>	
<b>Install Nortel Linux base</b>	<b>35</b>
Prerequisites	35
Install the Linux base software on the IBM x306m and HP DL320 G4 servers	37
<hr/>	
<b>Upgrade Nortel Linux base</b>	<b>53</b>
Prerequisites to upgrade Nortel Linux base	53

---

Upgrading Nortel Linux base 54

**Installation and configuration of applications on Linux base 69**

Prerequisites to install and configure applications 70

Install the CS 1000 applications 70

    Installing the NRS applications 71

    Install the Element Manager applications 82

    Configuration for Network Routing Service or Element Manager applications  
    in ECM 99

---

**CS 1000 on Linux base 101**

Linux Operating System and Distribution 101

Network and firewall 102

Software reliability 102

Linux Security Hardening 104

Patching 106

Software exceptions 109

User accounts and access control 109

    Passwords 110

System upgrades 115

Logging 115

SNMP 115

Disaster recovery 116

---

**Passthrough end user license agreement 121**

---

**COTS Servers 123**

HP DL320 G4 server 123

    HP DL320 G4 BIOS settings 126

IBM x306m server 131

    IBM x306m BIOS settings 134

---

**Nortel Linux base CLI commands 139**

---

**Network configuration for Secure File Transfer Protocol (SFTP)  
data backup 143**

Network configuration 143

SFTP logon 143

SFTP network configuration requirements 144

---

## New in this Release

---

**ATTENTION**

Do not contact Red Hat for technical support on your Nortel version of the Linux base operating system. If technical support is required for the Nortel version of the Linux base operating system, contact Nortel technical support through your regular channels.

The following sections detail what's new in *Linux Platform Base and Applications Installation and Commissioning (NN43001-315) ()* for release 5.5.

- [“Features” \(page 5\)](#)
- [“Other changes” \(page 6\)](#)

See the following sections for information about feature changes:

### Security hardening

### Features

See the following sections for information about feature changes:

### Installation times

Installation times are added for the installation of the Nortel Linux base and for the applications. Installation times are also added for the Nortel Linux base upgrade and the applications upgrade. Installation times for these features can be viewed in the following sections:

- [“Install the Linux base software on the IBM x306m and HP DL320 G4 servers” \(page 37\)](#)
- [“Upgrading Nortel Linux base” \(page 54\)](#)
- [“Install the CS 1000 applications” \(page 70\)](#)

### CLI commands

Several new CLI commands are added for Release 5.5. The CLI commands and a brief definition are listed in the following table:

- [Table 11 "Nortel Linux base CLI commands" \(page 141\)](#)

### Upgrade procedure

A procedure is added to upgrade the Linux base and applications from Release 5.0 to 5.5. The procedure is shown in the following section:

- ["Upgrading Nortel Linux base" \(page 54\)](#)

### Alarms

A listing of system alarm thresholds is added for Release 5.5. The thresholds can be viewed in the following table:

- [Table 2 "Warning and Critical thresholds" \(page 103\)](#)

### Screen captures

The installation procedure for the Linux base contains a revised set of screen captures for Release 5.5. The procedure is shown in the following section:

- ["Installing the Linux base on the IBM x306m server or HP DL320 G4" \(page 37\)](#)

### Firewall ports

A list of open firewall ports is included in Release 5.5. The list can be viewed in the following table:

- [Table 1 "Linux base open firewall ports" \(page 102\)](#)

### Task flow diagrams

Task flow diagrams for the installation and upgrade of the Linux base and applications have been added for Release 5.5. The task flow diagrams can be viewed in the chapter ["Linux base and applications installation and upgrade task flow" \(page 13\)](#).

### Other changes

See the following sections for information about changes that are not feature-related.

## Revision history

<b>October 29, 2008</b>	Standard 02.09. This document is up-issued to include a note under Disaster Recovery.
<b>May 01, 2008</b>	Standard 02.08. This document is up-issued to update information in the Upgrading Nortel Linux base procedures.
<b>April 18, 2008</b>	Standard 02.07. This document is up-issued to add information to the procedure Installing the Primary Security Service and Network Routing Service and added ECM Upgrade Procedures 5.00 GA to 5.50.12 to Task Flow chapter.
<b>April 15, 2008</b>	Standard 02.06. This document is up-issued to add lab trial information.
<b>February 22, 2008</b>	Standard 02.05. This document is up-issued to include references to host configuration scripts found in <i>Enterprise Common Manager Fundamentals (NN43001-116)</i> () .
<b>February 4, 2008</b>	Standard 02.04. This document is up-issued to support changes in technical content, including the addition of task flow diagrams for the installation and upgrade of the Linux base and applications.
<b>January 15, 2008</b>	Standard 02.03. This document is up-issued for changes in technical content. New screen captures have been included and an installation and upgrade task flow section has been added.
<b>December 19, 2007</b>	Standard 02.02. This document is up-issued for changes in technical content.

**December 7, 2007**

Standard 02.01. This document is up-issued to support Nortel Communication Server 1000 Release 5.5. This document contains new information on CLI commands, an upgrade procedure, firewall ports, and alarms. Screen captures for the Linux base installation procedure are updated.

**November 27, 2007**

Standard 01.04. This document is up-issued for changes in technical content.

**September 10, 2007**

Standard 01.03. This document is up-issued to address changes in technical content for release 5.0.

**June 20, 2007**

Standard 01.02. This document is up-issued to remove the Nortel Networks Confidential statement.

**May 30, 2007**

Standard 01.01. This document is issued to support Nortel Communication Server 1000 Release 5.0.



---

## How to get help

---

This chapter explains how to get help for Nortel products and services.

### Getting help from the Nortel Web site

The best way to get technical support for Nortel products is from the Nortel Technical Support Web site: [www.nortel.com/support](http://www.nortel.com/support)

This site provides quick access to software, documentation, bulletins, and tools to address issues with Nortel products. From this site, you can:

- download software, documentation, and product bulletins
- search the Technical Support Web site and the Nortel Knowledge Base for answers to technical issues
- sign up for automatic notification of new software and documentation for Nortel equipment
- open and manage technical support cases

### Getting help over the telephone from a Nortel Solutions Center

If you do not find the information you require on the Nortel Technical Support Web site, and you have a Nortel support contract, you can also get help over the telephone from a Nortel Solutions Center.

In North America, call 1-800-4NORTEL (1-800-466-7835).

Outside North America, go to the following Web site to obtain the telephone number for your region:

[www.nortel.com/callus](http://www.nortel.com/callus)

## Getting help from a specialist by using an Express Routing Code

To access some Nortel Technical Solutions Centers, you can use an Express Routing Code (ERC) to quickly route your call to a specialist in your Nortel product or service. To locate the ERC for your product or service, go to:

[www.nortel.com/erc](http://www.nortel.com/erc)

## Getting help through a Nortel distributor or reseller

If you purchased a service contract for your Nortel product from a distributor or authorized reseller, contact the technical support staff for that distributor or reseller.

---

# Introduction

---

**ATTENTION**

Do not contact Red Hat for technical support on your Nortel version of the Linux base operating system. If technical support is required for the Nortel version of the Linux base operating system, contact Nortel technical support through your regular channels.

*Linux Platform Base and Applications Installation and Commissioning (NN43001-315)* () provides a description of the features of Nortel Linux base and details on the installation and configuration of Nortel Linux base on commercial off-the-shelf (COTS) servers. This document also provides installation instructions for Nortel Linux applications.

## Subject

This document describes the installation and configuration of Nortel Linux base on the HP DL320 G4 and IBM x306m COTS servers. The Linux base server platform supports the following Nortel Communication Server 1000 (CS 1000) application configurations:

- Primary Security Service and Network Routing Service
- Backup Security Service and Network Routing Service
- Network Routing Service
- Primary Security Service and CS 1000 Element Manager
- Backup Security Service and CS 1000 Element Manager
- CS 1000 Element Manager
- Primary Security Service, Subscriber Manager, and CS 1000 Element Manager
- Backup Security Service, Subscriber Manager, and CS 1000 Element Manager

This document describes the upgrade and configuration of Nortel Linux base on the HP DL320 G4 and IBM x306m COTS servers.

To view licensing information, see “[Passthrough end user license agreement](#)” (page 121).

## Linux base overview

The Communication Server 1000 (CS 1000) Linux base system provides a Linux server platform for applications on a commercial off-the-shelf (COTS) Pentium server. The platform can support the new Session Initiation Protocol Network Redirect Server (SIP NRS) and Enterprise Common Manager (ECM) framework.

This system is supported on the HP DL320 G4 1u Pentium server and the IBM x306m 1u Pentium server.

## Key features

Linux base provides features and enhancements in the following areas:

- Linux operating system and distribution
- Firewall
- Software reliability
- Linux security hardening
- Patching
- User accounts and access control
- Software installation and delivery
- System upgrades
- Debugging
- Logging
- Disaster recovery
- Network Time Protocol (NTP)

---

# Linux base and applications installation and upgrade task flow

---

*Linux Platform Base and Applications Installation and Commissioning (NN43001-315)* () provides installation and upgrade information for the Linux base and applications. You must follow the proper sequence of events to correctly install or upgrade the Linux base and applications. Use the task flow information in this chapter to determine the proper steps for the installation or upgrade of the Linux base and applications.

The task flows for Linux base and applications installation and upgrades are broken into two sections:

- Task flows to install or upgrade individual servers, as shown in “[Task flows for individual servers](#)” (page 13).
- Task flows to install or upgrade commonly used combinations of servers, as shown in “[Task flows for common combinations of servers](#)” (page 21).

There is also a section for upgrading the ECM. See “[ECM Upgrade Procedures](#)” (page 28).

## Task flows for individual servers

This section provides high-level task flows for the installation and upgrade of the Linux base and applications on commercial off-the-shelf (COTS) servers. Refer to the chapters “[Install Nortel Linux base](#)” (page 35) and “[Installation and configuration of applications on Linux base](#)” (page 69) for specific installation instructions. Refer to the chapter “[Upgrade Nortel Linux base](#)” (page 53) for specific upgrade instructions.

For more information refer to the following NTPs, which are referenced in the task flow diagrams:

- *Linux Platform Base and Applications Installation and Commissioning (NN43001-315)* ()
- *Subscriber Manager Fundamentals (NN43001-120)* ()

- *Common Network Directory 2.2 Administration (NN43050-101) ()*
- *Network Routing Service Installation and Commissioning (NN43001-564) ()*

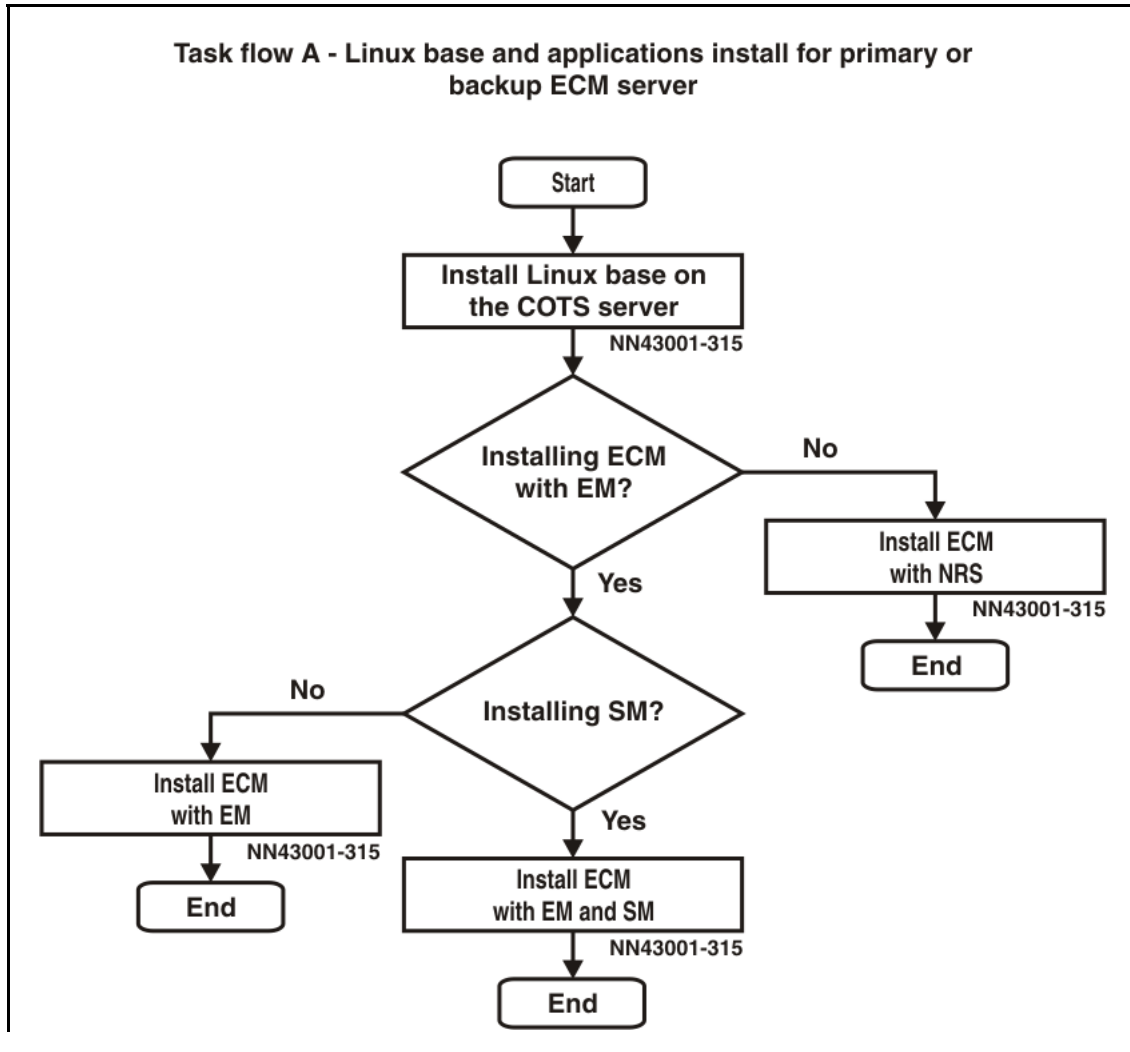
This section contains the following task flows:

- [Figure 1 "Linux base and applications install for primary or backup ECM server " \(page 15\)](#)
- [Figure 2 "Linux base and applications install for member server" \(page 16\)](#)
- [Figure 3 "Linux base and applications upgrade for primary or backup ECM server with NRS" \(page 17\)](#)
- [Figure 4 "Linux base and applications upgrade for primary or backup ECM server with EM " \(page 18\)](#)
- [Figure 5 "Linux base and applications upgrade for primary or backup ECM server with EM and adding SM " \(page 19\)](#)
- [Figure 6 "Linux base and applications upgrade for member server " \(page 20\)](#)

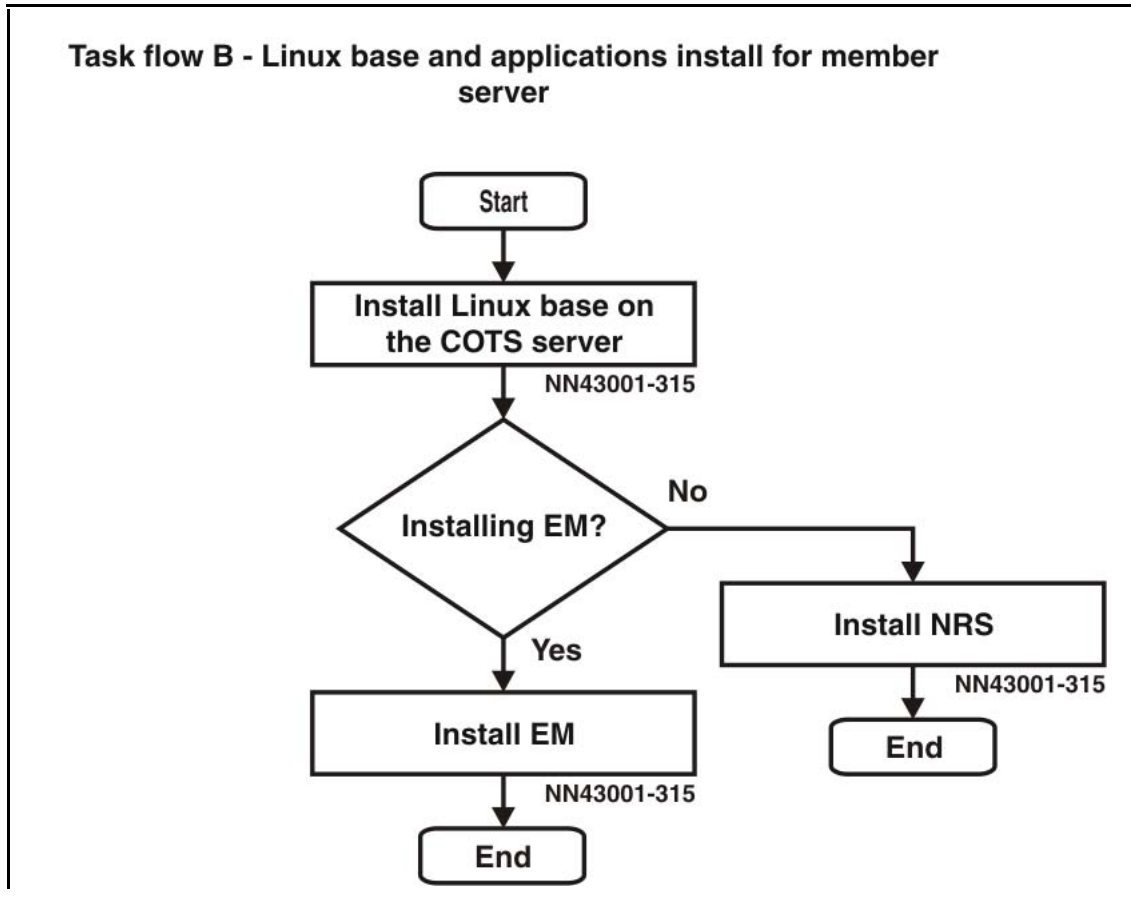
The task flow diagrams contain the following abbreviations:

- SM: Subscriber Manager
- ECM: Enterprise Common Manager
- EM: Element Manager
- CND: Common Network Directory
- NRS: Network Routing Service

**Figure 1**  
**Linux base and applications install for primary or backup ECM server**

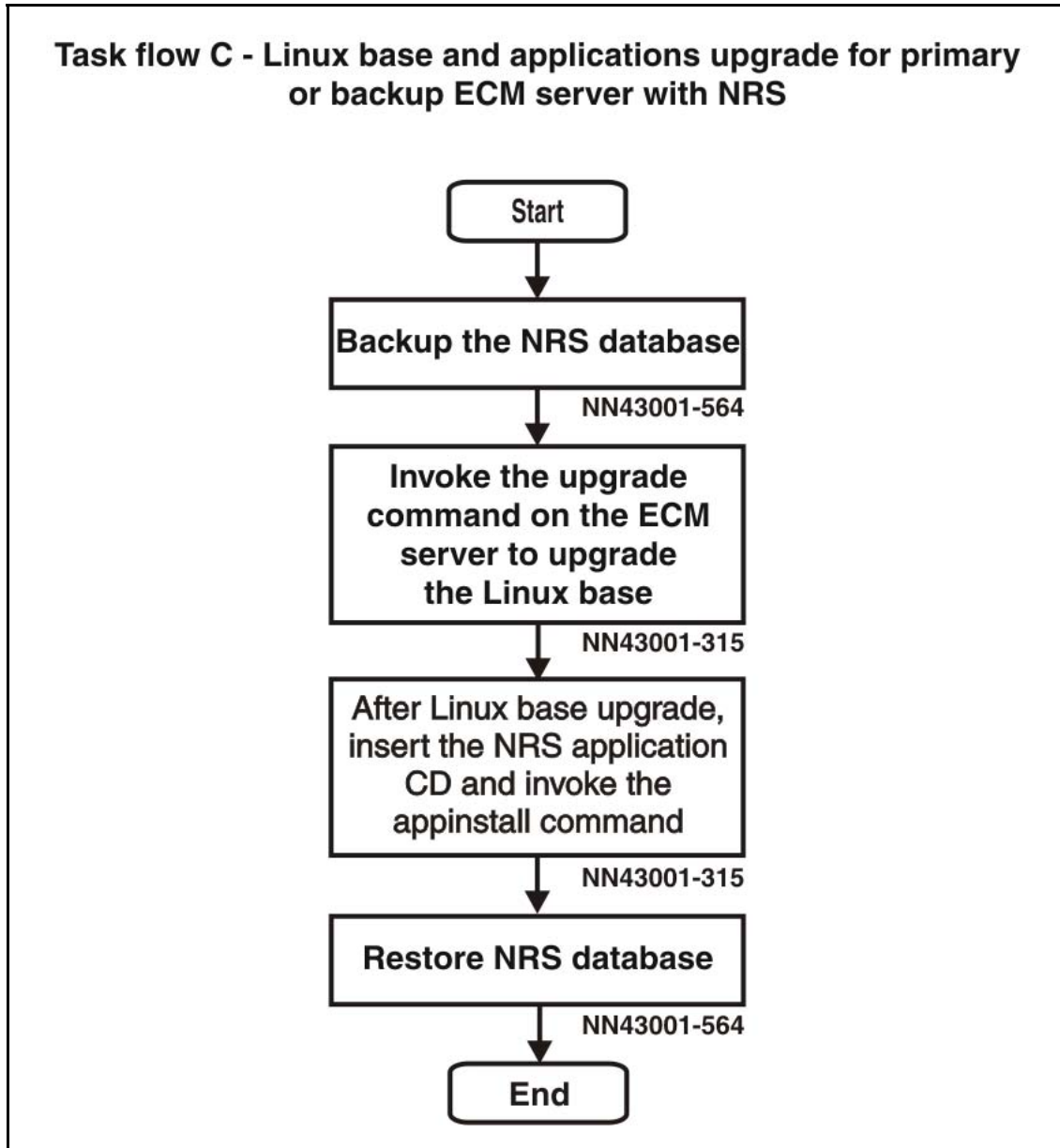


**Figure 2**  
Linux base and applications install for member server

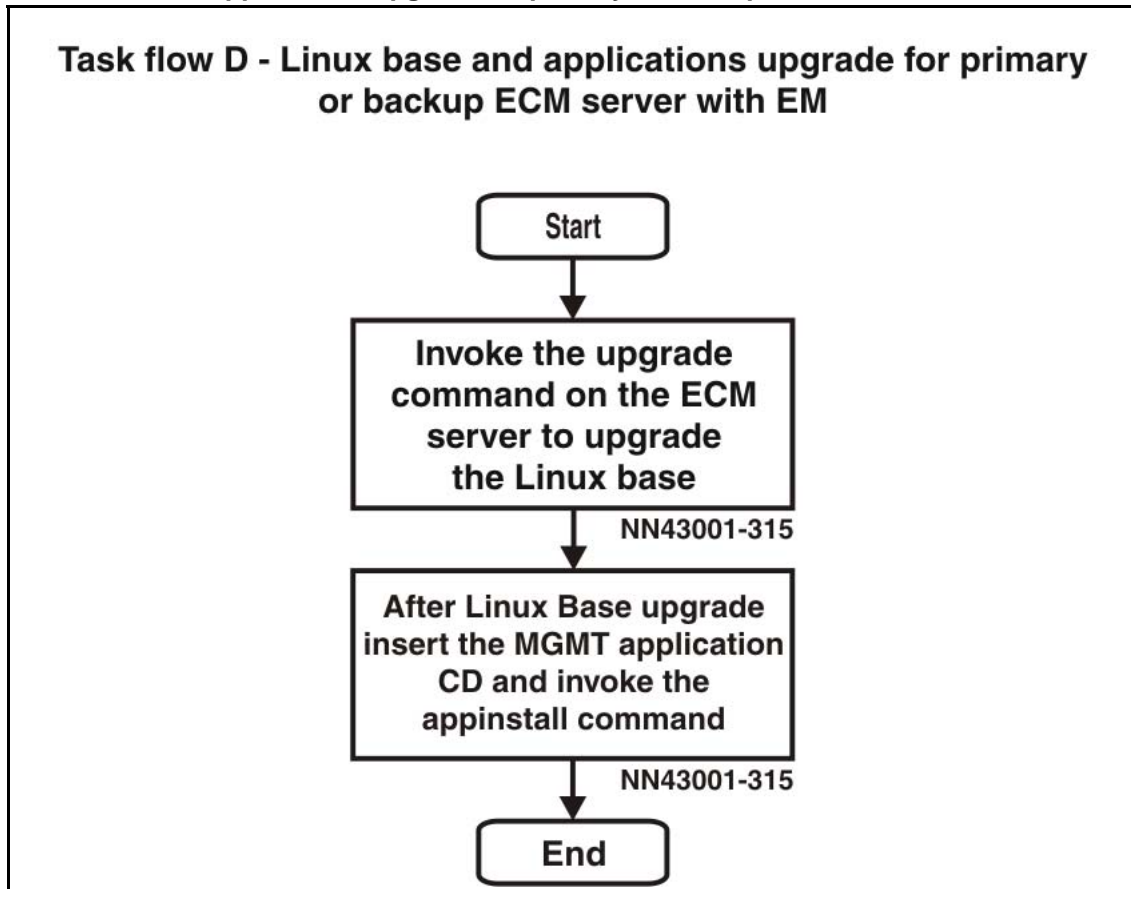




**Figure 3**  
Linux base and applications upgrade for primary or backup ECM server with NRS



**Figure 4**  
**Linux base and applications upgrade for primary or backup ECM server with EM**



**Figure 5**  
Linux base and applications upgrade for primary or backup ECM server with EM and adding SM

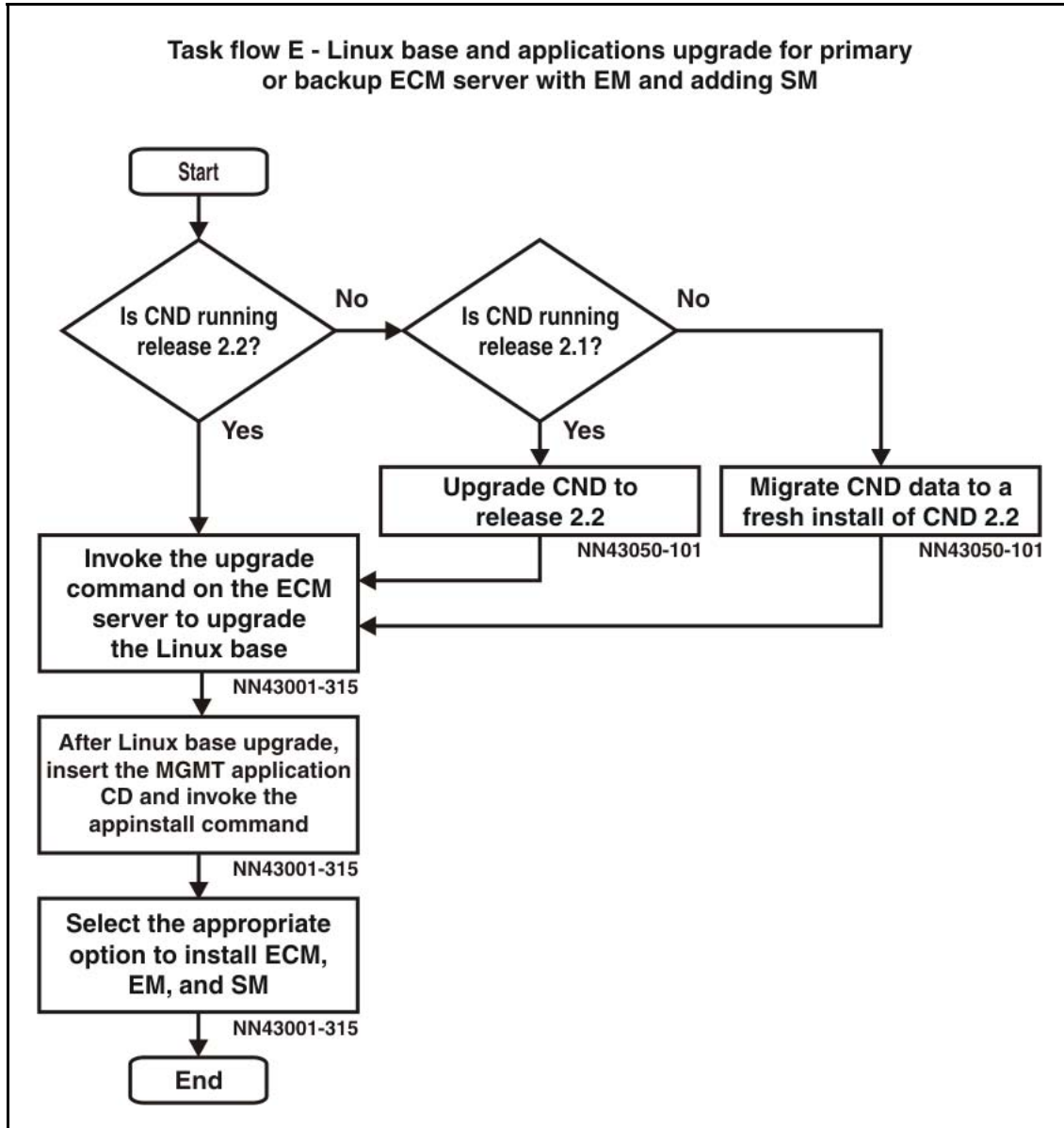
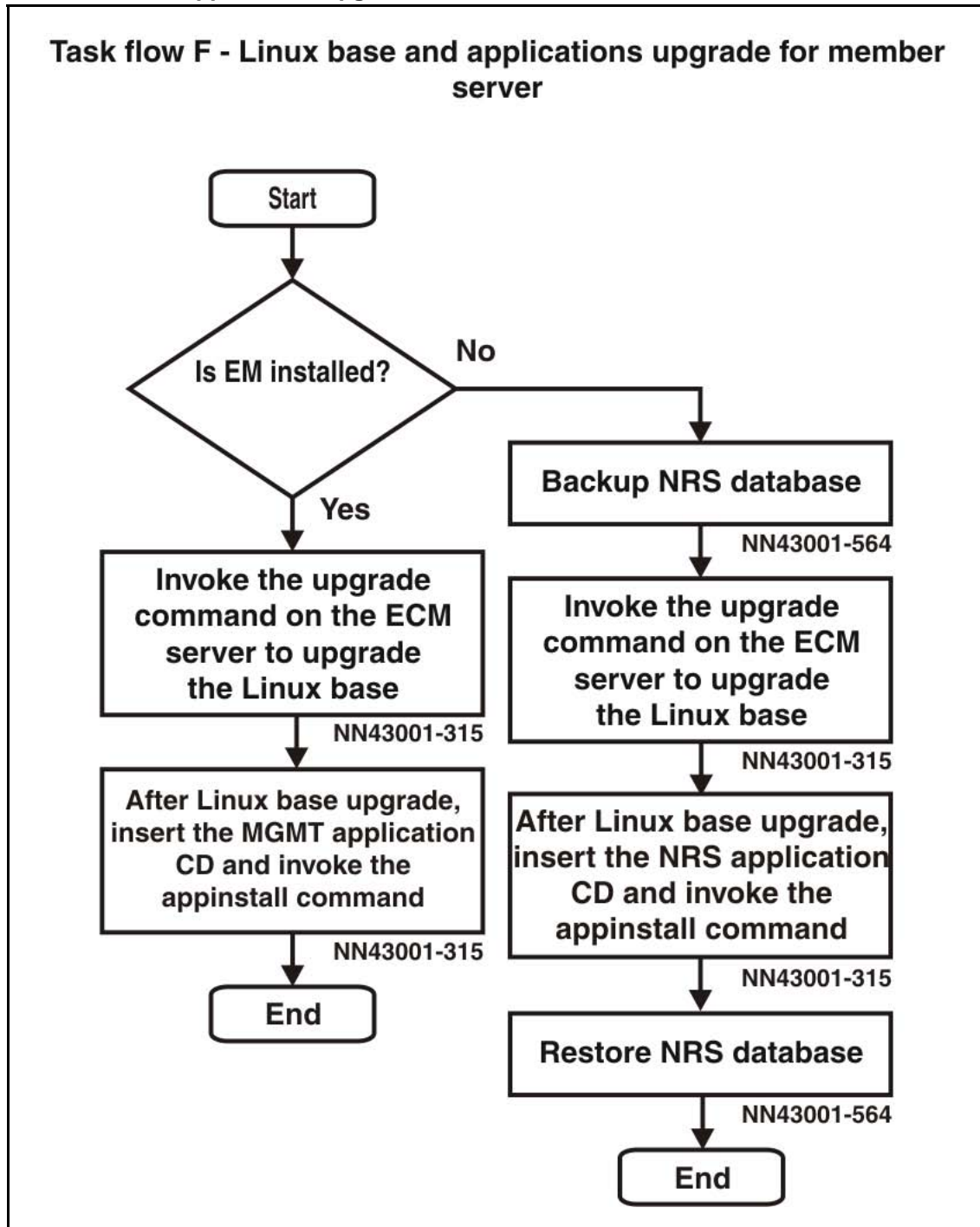


Figure 6  
Linux base and applications upgrade for member server



## Task flows for common combinations of servers

This section provides high-level task flows for the installation and upgrade of common combinations of primary ECM servers, backup ECM servers, single ECM servers, and member servers. Refer to the chapters [“Install Nortel Linux base ” \(page 35\)](#) and [“Installation and configuration of applications on Linux base” \(page 69\)](#) for specific installation instructions. Refer to the chapter [“Upgrade Nortel Linux base ” \(page 53\)](#) for specific upgrade instructions.

For more information refer to the following NTPs, which are referenced in the task flow diagrams:

- *Linux Platform Base and Applications Installation and Commissioning (NN43001-315) ()*
- *Subscriber Manager Fundamentals (NN43001-120) ()*
- *Enterprise Common Manager Fundamentals (NN43001-116) ()*
- *Element Manager System Reference—Administration (NN43001-632) ()*
- *Common Network Directory 2.2 Administration (NN43050-101) ()*

This section contains the following task flows:

- [Figure 7 "Linux base and applications install for primary server with backup ECM server " \(page 22\)](#)
- [Figure 8 "Linux base and applications install for primary server with backup ECM server and member servers " \(page 23\)](#)
- [Figure 9 "Linux base and applications install for primary ECM server with member servers" \(page 24\)](#)
- [Figure 10 "Linux base and applications upgrade for primary with backup ECM server " \(page 25\)](#)
- [Figure 11 "Linux base and applications upgrade for primary server with backup ECM server and member servers " \(page 26\)](#)
- [Figure 12 "Linux base and applications upgrade for primary ECM server with member servers " \(page 27\)](#)
- [Figure 13 "Subscriber Manager installation and configuration" \(page 28\)](#)

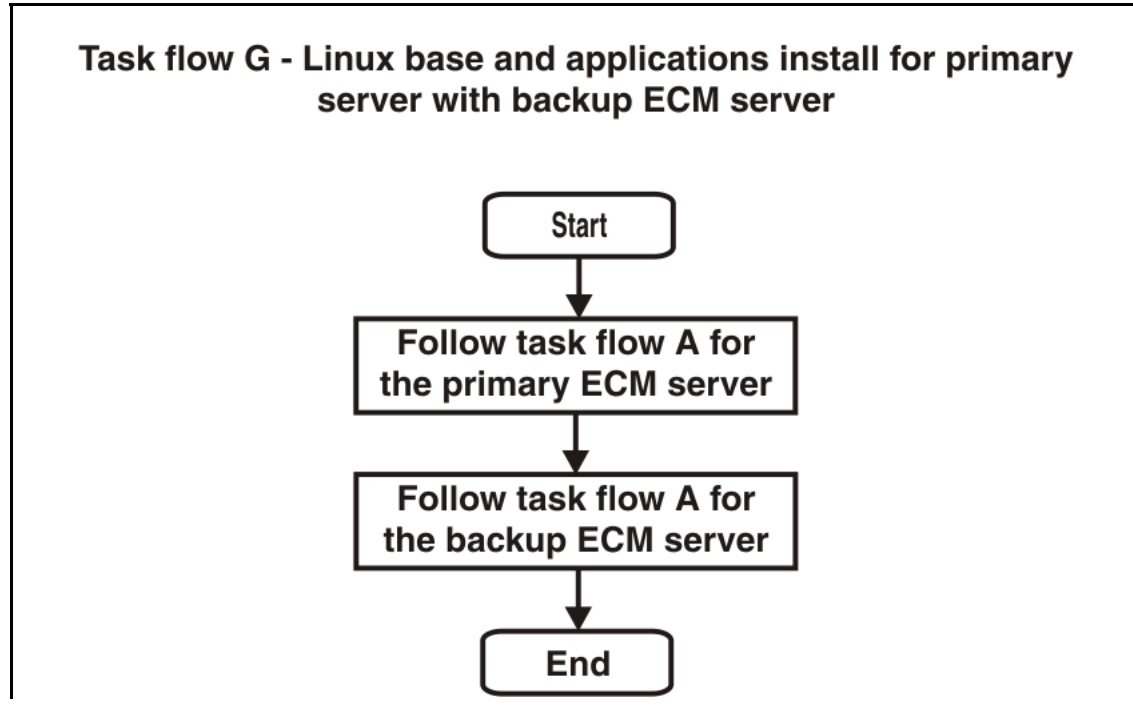
The task flow diagrams contain the following abbreviations:

- SM: Subscriber Manager
- ECM: Enterprise Common Manager
- EM: Element Manager

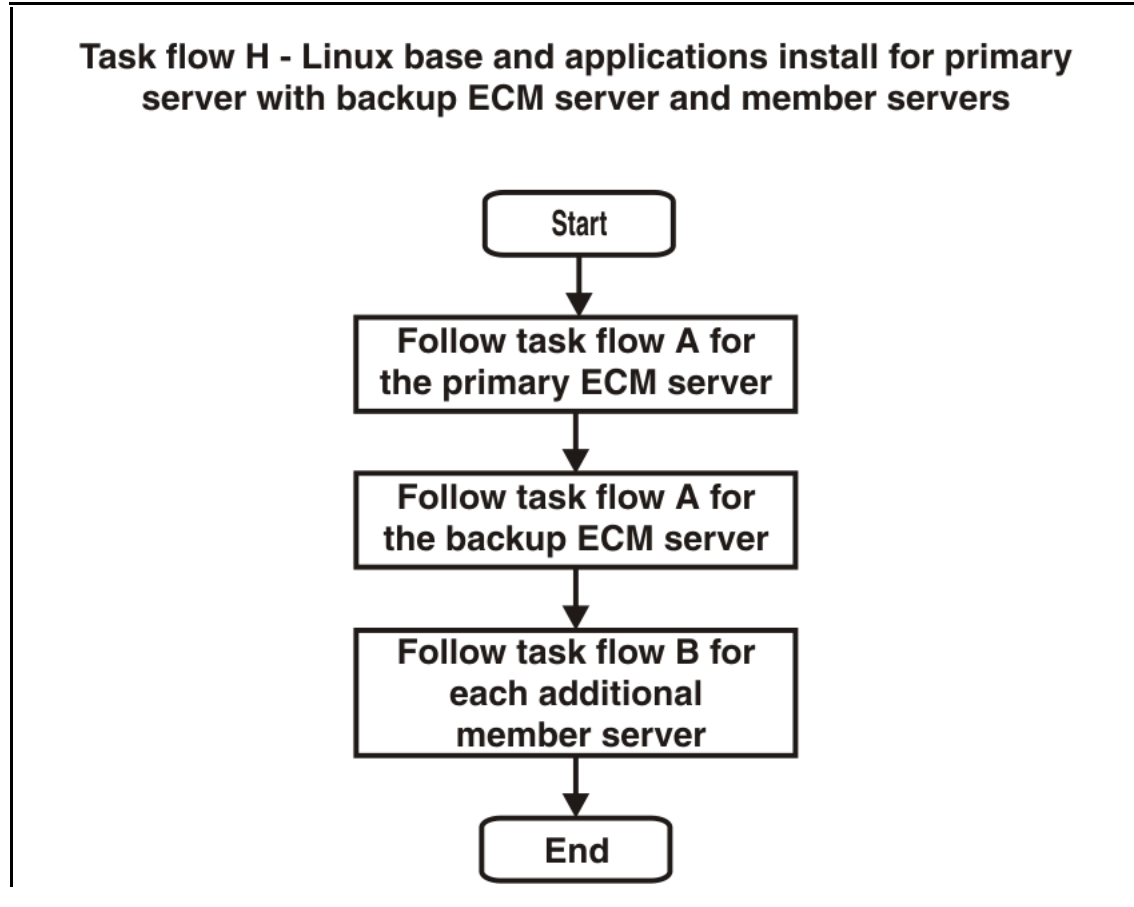
- CND: Common Network Directory
- NRS: Network Routing Service

**Figure 7**

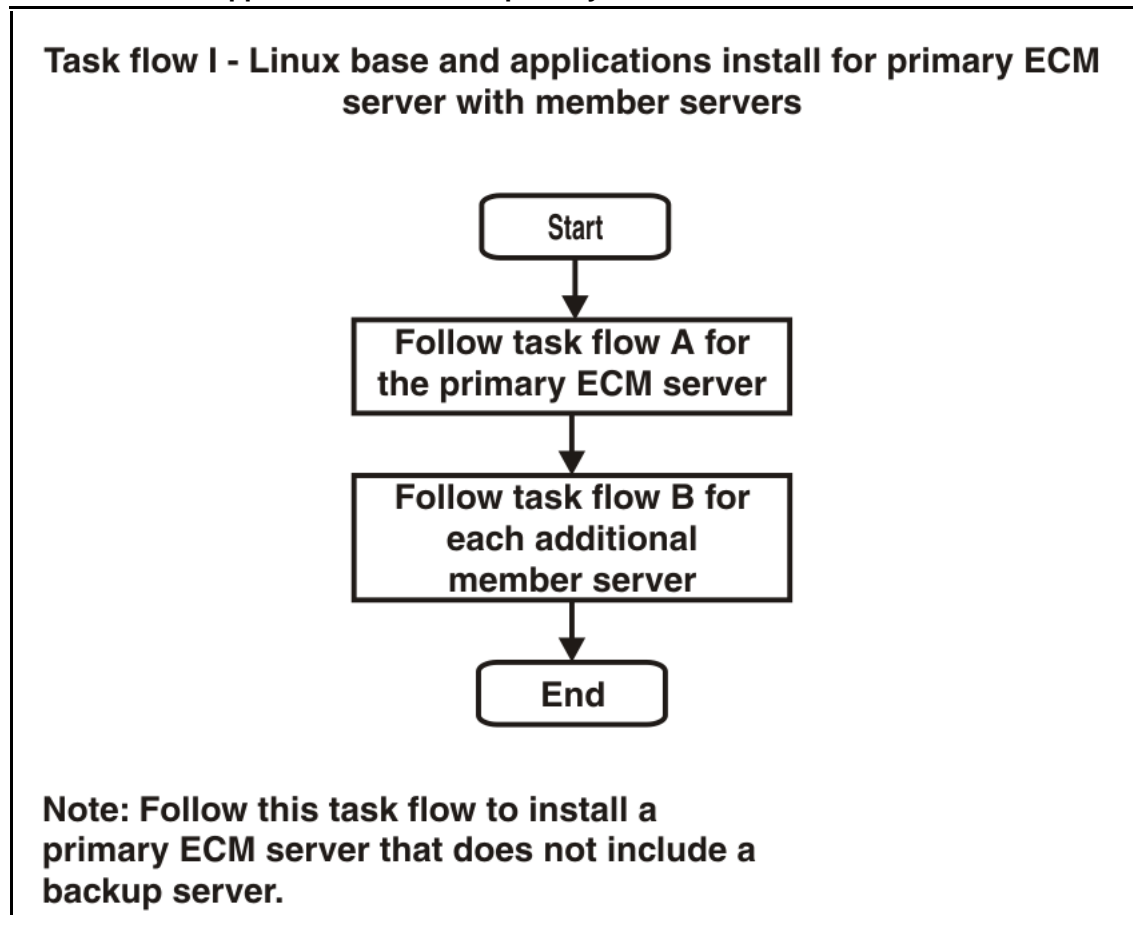
**Linux base and applications install for primary server with backup ECM server**



**Figure 8**  
Linux base and applications install for primary server with backup ECM server and member servers

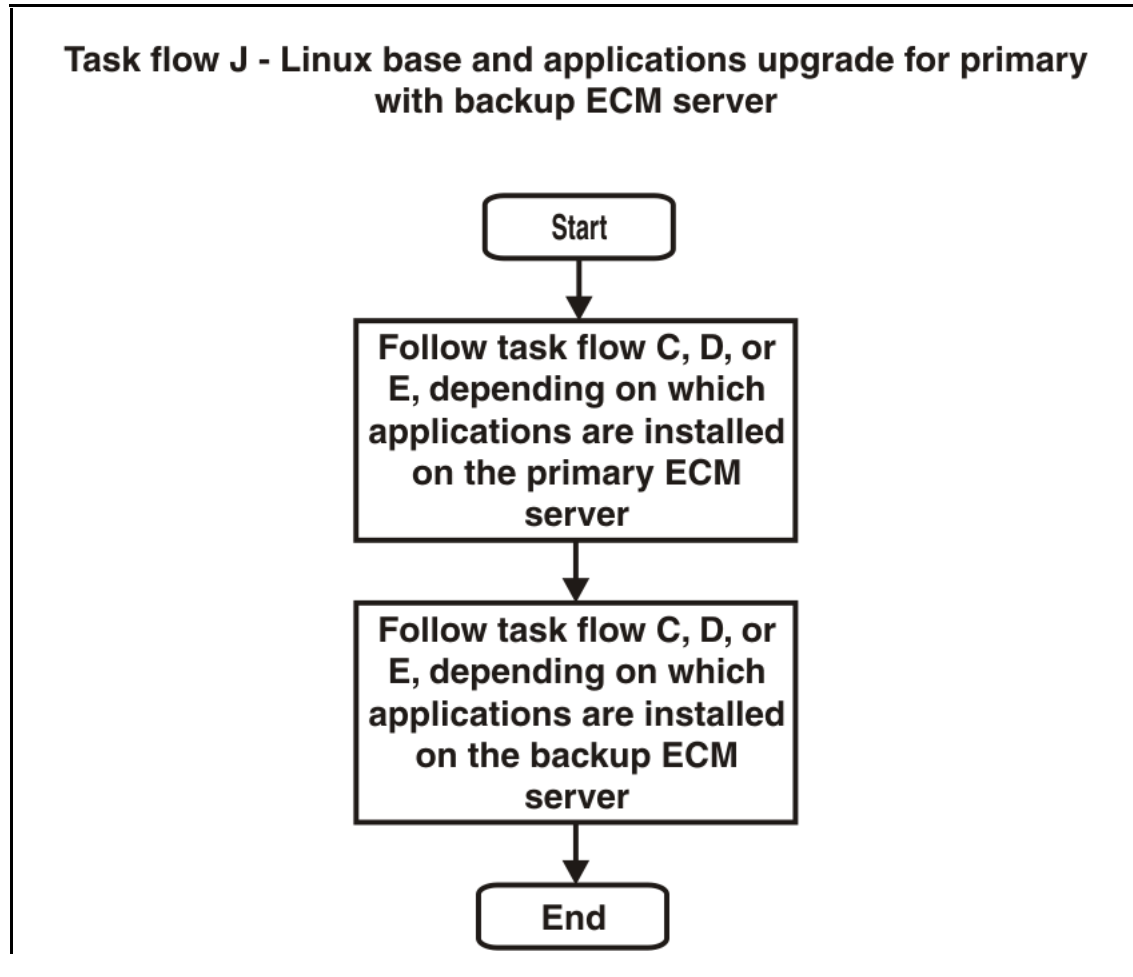


**Figure 9**  
**Linux base and applications install for primary ECM server with member servers**

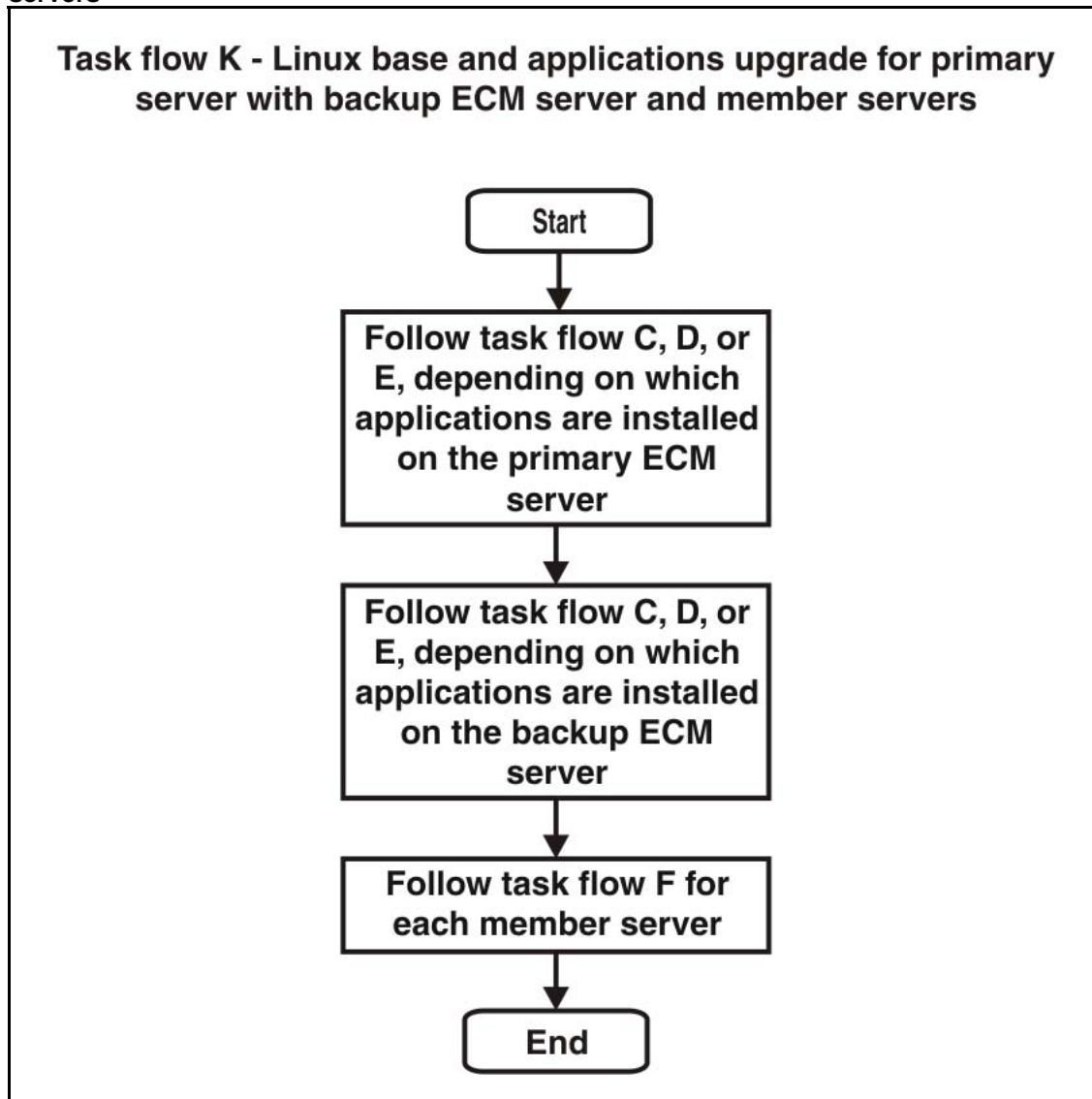




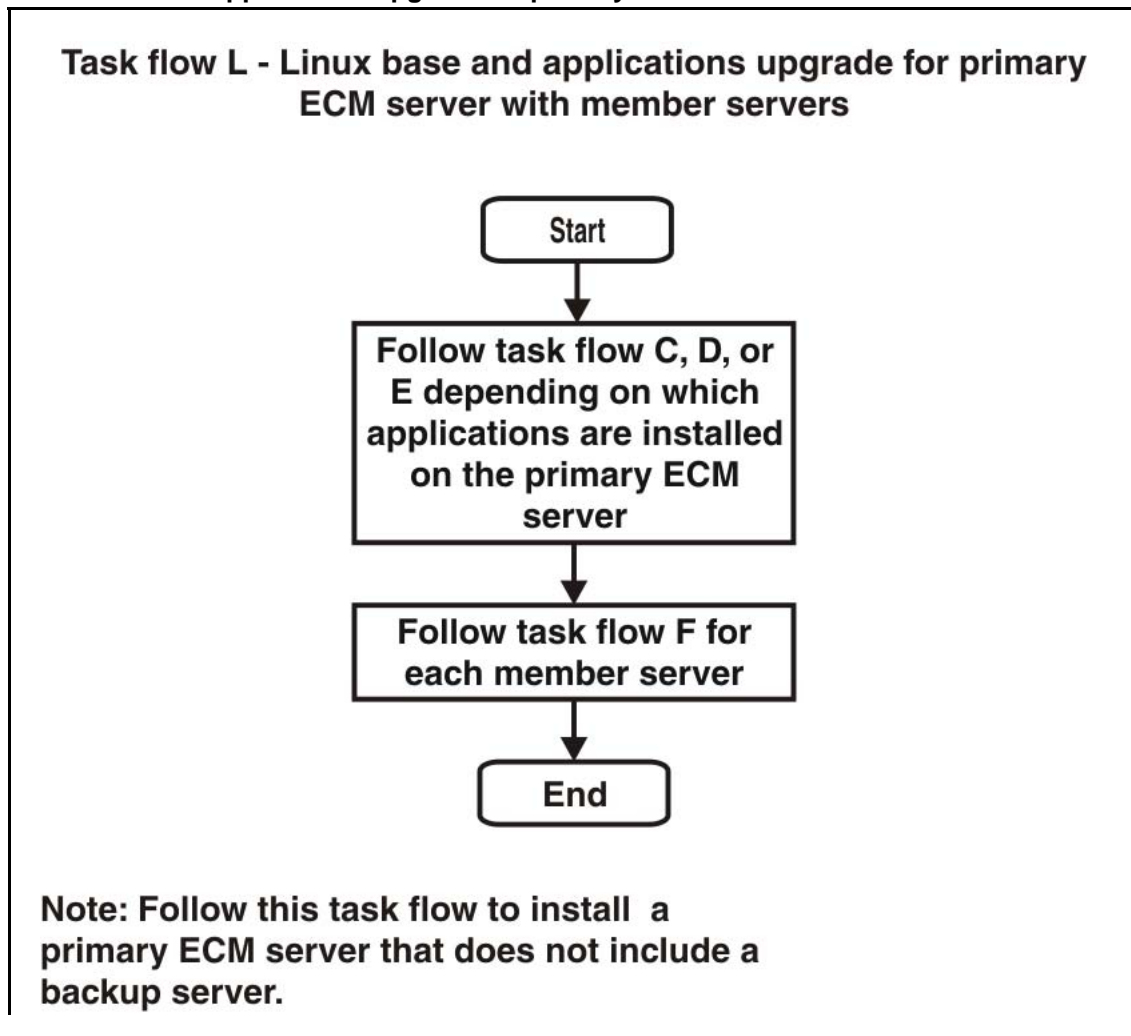
**Figure 10**  
**Linux base and applications upgrade for primary with backup ECM server**



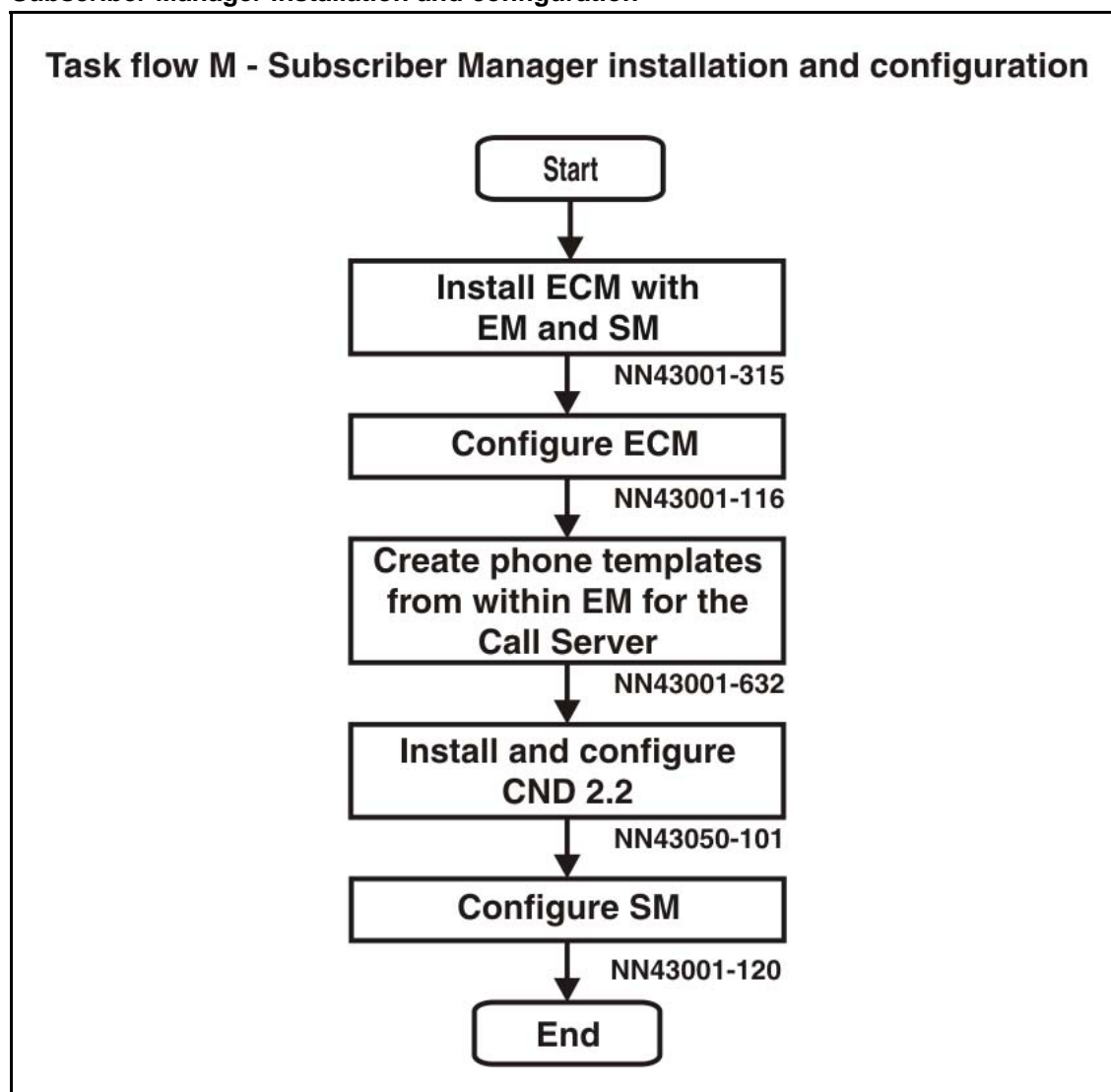
**Figure 11**  
Linux base and applications upgrade for primary server with backup ECM server and member servers



**Figure 12**  
**Linux base and applications upgrade for primary ECM server with member servers**



**Figure 13**  
**Subscriber Manager installation and configuration**



## ECM Upgrade Procedures

The following describes the procedures for upgrading an Enterprise Common Manager (ECM) system from RIs 5.00 to RIs 5.50.

There are several procedures in this section. Perform the first procedure based on your system configuration:

- [“1a: Upgrade Primary server without Backup server and less than three or no Member servers” \(page 29\)](#)
- [“1b: Upgrade Primary server without Backup server and less than three or no Member servers” \(page 29\)](#)
- [“1c: Upgrade Primary server with Backup server and three or more Member servers” \(page 30\)](#)

Then perform one or both of the following procedures as applicable to your system configuration:

- [“Upgrade Backup ECM Security server” \(page 31\)](#)
- [“Upgrade ECM Member server” \(page 33\)](#)

This procedure describes upgrading the Primary ECM Security server from RIs 5.00 to RIs 5.50 in a configuration with no Backup ECM server and less than three or no Member servers associated with it.

#### **1a: Upgrade Primary server without Backup server and less than three or no Member servers**

Step	Action
------	--------

*There are no prerequisites for this procedure.*

- |   |  |
|---|--|
| 1 | Open a command line interface session to the Primary ECM Security Server through the serial port with the <i>nortel</i> account.   |
| 2 | Perform the <a href="#">“Upgrading Nortel Linux base ” (page 54)</a> procedure.  |
| 3 | Open a command line interface session to the Primary ECM Security Server through the serial port with the <i>nortel</i> account.   |
| 4 | Install the following patches onto the Primary ECM Security server using the <a href="#">“Patching Operation” (page 106)</a> procedure. <ul style="list-style-type: none"> <li>• MPLR25520</li> <li>• MPLR25521</li> </ul> |

--End--

This procedure describes upgrading the Primary ECM Security server from RIs 5.00 to RIs 5.50 in a configuration with a Backup ECM server and less than three or no Member servers associated with it.

#### **1b: Upgrade Primary server without Backup server and less than three or no Member servers**

Step	Action
<i>There are no prerequisites for this procedure.</i>	
1	Open a command line interface session to the Primary ECM Security Server through the serial port with the <i>nortel</i> account.
2	Switch user to the root account by typing <code>SU</code> and press <enter>.
3	Enter the root user password when prompted.
4	Execute the following script: <code>/opt/nortel/isclient/setup_ssh.sh deconfig</code>
5	If a Backup ECM Security server is present in the system, switch user to the root account and execute the script <code>/opt/nortel/isclient/failOver.sh &lt;FQDN of Primary ECM Security Server&gt;</code> where <FQDN of Primary ECM Security Server> is set to the FQDN of the Primary ECM Security server.
6	Wait for two minutes after the command completes before proceeding.
7	Switch user back to the <i>nortel</i> account by typing <code>exit</code> .
8	Perform the “ <a href="#">Upgrading Nortel Linux base</a> ” (page 54) procedure.
9	Open a command line interface session to the Primary ECM Security Server through the serial port with the <i>nortel</i> account.
10	Install the following patches onto the Primary ECM Security server using the “ <a href="#">Patching Operation</a> ” (page 106) procedure. <ul style="list-style-type: none"> <li>• MPLR25520</li> <li>• MPLR25521</li> </ul>
--End--	

This procedure describes upgrading the Primary ECM Security server from RIs 5.00 to RIs 5.50 in a configuration with a Backup ECM server and three or more Member servers associated with it.

#### 1c: Upgrade Primary server with Backup server and three or more Member servers

Step	Action
<i>There are no prerequisites for this procedure.</i>	
1	Open a command line interface session to the Primary ECM Security Server through the serial port with the <i>nortel</i> account.
2	Switch user to the root account by typing <code>SU</code> and press <enter>.

- 3 Enter the root user password when prompted.
- 4 Execute the following script:  
`/opt/nortel/isclient/setup_ssh.sh deconfig`
- 5 If a Backup ECM Security server is present in the system, switch user to the root account and execute the script  
`/opt/nortel/isclient/failOver.sh <FQDN of Primary ECM Security Server>`  
where <FQDN of Primary ECM Security Server> is set to the FQDN of the Primary ECM Security server.
- 6 Wait for two minutes after the command completes before proceeding.
- 7 Switch user back to the *nortel* account by typing `exit`.
- 8 Perform the “[Upgrading Nortel Linux base](#)” (page 54) procedure up to and including [Step 14](#).
- 9 Switch user to the root account and disable network connectivity to the TLAN ethernet port with the command:  
`ifconfig eth1 down`

**WARNING**

This shuts down the eth1 port.

- 10 When complete, switch back to the *nortel* account.
- 11 Continue with [Step 15](#) of the “[Upgrading Nortel Linux base](#)” (page 54) procedure.
- 12 Open a command line interface session to the Primary ECM Security Server through the serial port with the *nortel* account.
- 13 Install the following patches onto the Primary ECM Security server using the “[Patching Operation](#)” (page 106) procedure.
  - MPLR25520
  - MPLR25521

---

--End--

---

This procedure describes upgrading the Backup ECM Security server from RIs 5.00 to RIs 5.50.

### Upgrade Backup ECM Security server

Step	Action
<i>Prior to upgrading the Backup ECM Security server, the Primary ECM Security server must be upgraded using one of the previous Upgrade a Primary ECM Security server procedures.</i>	
1	Open a command line interface session to the Primary ECM Security Server through the serial port with the <i>nortel</i> account.
2	Perform a backup of the Backup ECM Security server data using the command <code>sysbackup -b</code>
3	Perform a fresh install of the Nortel Linux base software using the procedures in “ <a href="#">Install Nortel Linux base</a> ” (page 35).
4	Install the CS1000 application software using the procedures described in “ <a href="#">Install the CS 1000 applications</a> ” (page 70).
5	Install the following patches onto the Primary ECM Security server using the “ <a href="#">Patching Operation</a> ” (page 106) procedure: <ul style="list-style-type: none"><li>• MPLR25520</li><li>• MPLR25521</li></ul>
6	Open a command line interface session to the Primary ECM Security Server through the serial port with the <i>nortel</i> account.
7	Switch user to the root account by typing <code>SU</code> and press <enter>.
8	Enter the root user password when prompted.
9	Execute the following script: <code>/opt/nortel/isclient/setup_ssh.sh deconfig</code>
10	Open a command line interface session to the Primary ECM Security Server through the serial port with the <i>nortel</i> account.
11	In the command line interface, perform a restore of the ECM data that was backed up in Step 2, using the command <code>sysrestore</code> .
12	Switch user to the root account by typing <code>SU</code> and press <enter>.
13	Enter the root user password when prompted.
14	Execute the following script: <code>/opt/nortel/linuxTrustMgmt/setupNonCA.sh</code> This script prompts for certificate parameters to create a new certificate for the Backup ECM Security server. This script includes re-enabling of the High Availability mode; therefore, there is no need to perform this separately.
--End--	



This procedure describes upgrading an ECM Member server from RIs 5.00 to RIs 5.50. Perform this procedure for each ECM Member server in the system. Prior to upgrading the Backup ECM Security server, the Primary ECM Security server must be upgraded using one of the *Upgrade a Primary ECM Security server* procedures.

### Upgrade ECM Member server

Step	Action
<i>If there is a Backup ECM Security server, it must be upgrading prior to completing this procedure. Complete the previous procedure.</i>	
1	Open a command line interface session to the Primary ECM Security Server through the serial port with the <i>nortel</i> account.
2	Perform a backup of the ECM Member server data using the command <code>sysbackup -b</code>
3	Perform a fresh install of the Nortel Linux base software using the procedures in <a href="#">“Install Nortel Linux base”</a> (page 35).
4	Install the CS1000 application software using the procedures described in <a href="#">“Install the CS 1000 applications”</a> (page 70).
5	Install the following patches onto the Primary ECM Security server using the <a href="#">“Patching Operation”</a> (page 106) procedure: <ul style="list-style-type: none"> <li>• MPLR25520</li> <li>• MPLR25521</li> </ul>
6	Open a command line interface session to the Primary ECM Security Server through the serial port with the <i>nortel</i> account.
7	Perform a restore of the ECM data using the command <code>sysrestore</code>
8	Switch user to the root account and execute the script <code>/opt/nortel/linuxTrustMgmt/setupNonCA.sh</code> This script prompts for certificate parameters to create a new certificate for the Backup ECM Security server.

--End--



---

## Install Nortel Linux base

---

Nortel Communication Server 1000 (CS 1000) Linux base introduces a two-stage installation procedure. The operating system is installed, and then the applications. You can upgrade the current application configuration using the existing operating system, or you can reinstall an application configuration using the existing operating system.

Each Linux server platform requires an installation of the base-level software. You start the installation from a bootable CD. The process includes the partitioning of hard disk drives, installation of the Linux kernel and the Linux root file system, associated device drivers, and the base system commands and utilities. The process ends with a fully functional Nortel Linux base server.

The Linux server supports two network interfaces, TLAN and ELAN. The choice of network interface is based on network topology and application deployment.

For a definition of the Embedded Local Area Network (ELAN) and the Telephony Local Area Network (TLAN) see [“Network configuration”](#) (page 143).

### Prerequisites

Before you install the Linux base you must complete the following tasks:

- Gather the following necessary customer information:
  - ELAN IP address
  - ELAN gateway IP address
  - ELAN netmask
  - The host name associated with the TLAN

- The domain name

**Note:** A Fully Qualified Domain Name (FQDN) consists of a host name and a domain name, and includes a top-level domain name. Using kwei.ca.nortel.com as an example, kwei is the host name, ca.nortel.com is the domain name, and .com is the top-level domain name. The FQDN must contain at least three fields separated by dots.

- TLAN IP address
- TLAN gateway IP address
- TLAN netmask
- Timezone
- IP address of Network Time Protocol (NTP) Server
- IP address of the Primary Domain Name Service (DNS) server
- Default system gateway associated with the network interface (ELAN or TLAN)

**Note 1:** The choice of ELAN or TLAN as the default gateway NIC can be influenced by the applications that you are going to deploy on the server and by network topology. For a definition of ELAN and TLAN see "[Network configuration](#)" (page 143).

**Note 2:** The CLI command `routeconfig` can be used to add routing entries. The choice of routing entries will depend upon the network topology and application deployment. For a list of Nortel Linux base CLI commands see [Table 11 "Nortel Linux base CLI commands"](#) (page 141).

The base parameters can be changed after the installation is complete using the CLI command `baseparamsconfig`. A change in the base parameters can affect other application components. For example, if the current server is the Primary ECM security server and the FQDN is changed it is necessary to reinstall the applications.

The CLI command `baseparamsconfig` is an umbrella command that you can use to configure parameters for network settings, Network Time Protocol settings, date and time settings, and DNS settings. You can configure these parameters individually by using the CLI commands

`networkconfig`, `ntpconfig`, `datettimeconfig`, and `dnsconfig`. For a list of Nortel Linux base CLI commands see [Table 11 "Nortel Linux base CLI commands" \(page 141\)](#).

**Note:** [Figure 114 "HP DL320 G4 rear view" \(page 125\)](#) shows the ELAN and TLAN network interfaces for the HP DL320 G4 server. [Figure 123 "IBM x306m rear view" \(page 133\)](#) shows the ELAN and TLAN network interfaces for the IBM x306m server. For a definition of ELAN and TLAN see ["Network configuration" \(page 143\)](#).

## Install the Linux base software on the IBM x306m and HP DL320 G4 servers

Use the following procedure to install the Linux base software. The installation time for Nortel Linux base is approximately 20 minutes.

### Installing the Linux base on the IBM x306m server or HP DL320 G4

#### ATTENTION

This procedure documents the installation of Nortel Linux base on a commercial off-the-shelf (COTS) server with no previous Nortel Linux base installation. If a Nortel Linux base installation exists on the server and you are upgrading to a newer Nortel Linux base version, see the chapter ["Upgrade Nortel Linux base" \(page 53\)](#).

Step	Action
1	Connect to the COTS server using a serial console or keyboard, video monitor, and mouse (kvm). <div style="border: 1px solid black; padding: 5px; margin-top: 10px;"> <h4>ATTENTION</h4> <p>Before installing the Linux base, read all of the documentation provided by the manufacturer of the COTS server.</p> </div>
2	Insert the Linux base bootable CD-ROM in the CD-ROM tray.
3	Reboot the server.
4	Choose the method of installation as shown in <a href="#">Figure 14 "CS 1000 Linux base system installer" (page 38)</a> . <ul style="list-style-type: none"> <li>• To install using a serial console on COM1, type <b>com1</b> at the boot prompt and press <b>Enter</b>.</li> <li>• To install using an attached keyboard, video monitor, and mouse, type <b>kvm</b> at the boot prompt and press <b>Enter</b>.</li> </ul> <p><b>Note:</b> It is not required to attach a keyboard, video monitor and mouse (KVM) to view output. A console-based installation will also provide output.</p>

Figure 14  
CS 1000 Linux base system installer

```
System Release:      nortel-cs1000-linuxbase-4.91-30.00
Build Timestamp:    Thu Nov 23 20:26:33 EST 2006

      Welcome to the CS 1000 Linux Base System Installer

- To install via a serial console on COM1, type com1 <ENTER>.
  All input and output will be directed to the COM1 serial port. The system
  console will be permanently installed on COM1.

- To install via an attached keyboard/monitor/mouse, type kvm <ENTER>. All
  input and output will be directed to the attached keyboard/monitor/mouse.
  During installation, you will be given the opportunity to permanently
  install the system console on a user specified serial port. If you choose
  not to, the system console will be permanently installed on the attached
  keyboard/monitor/mouse.

      ***The default is --- com1***.

boot: _
```

- 5 Type **Y** and press **Enter** as shown in [Figure 15 "CS 1000 Linux base system installer"](#) (page 38).

Figure 15  
CS 1000 Linux base system installer

```
#####
#####

      Installation of New Linux base Operating System

New Linux base release:
  System Release:  Nortel-cs1000-linuxbase-5.00-13.00
  Build Timestamp: Wed Mar 7 13:50:08 MSK 2007

#####
#####

Do you wish to proceed with installation (Y/N) [Y]?
```

- 6 The Format all partitions screen appears, as shown in [Figure 16 "Format all partitions"](#) (page 39). Press **Enter** to continue.

**Figure 16**  
Format all partitions

```
#####
#####

ALL PARTITIONS WILL BE ERASED AND FORMATTED.

THIS DATA CANNOT BE RESTORED ONCE FORMATTED
BY THIS INSTALLATION PROGRAM.

PRESS THE ENTER KEY TO CONTINUE...

#####
#####
```

- 7 At the prompt, select the type of configuration data you wish to use. Type **1** for Normal installation and press **Enter**, and then press **Enter** again when prompted, as shown in [Figure 17 "Configuration data selection window" \(page 39\)](#).

**Figure 17**  
Configuration data selection window

```
Configuration Data Selection
-----
1. Normal installation (do not use any configuration files)
2. Load previously backed up data from external USB device.
   (Note: only one USB device can be plugged-in when prompted.)
3. Load previously backed up data from SFTP-server.

Select (1-3):1
```

- 8 The **System Configuration** screen appears as shown in [Figure 18 "System configuration window" \(page 40\)](#). Press **Enter** to continue.

**Figure 18**  
**System configuration window**

```
#####  
#                System Configuration                #  
#####  
  
You will now be prompted to enter configuration data for this  
server.  
  
Once you have completed the configuration, the installation  
will begin.  
  
Throughout the system configuration phase, you will be given  
the chance to verify/modify your input in case any mistakes are made  
during data entry.  
  
Press the Enter Key to begin configuration...
```

- 9 When prompted, in the **Network configuration** screen, enter the customer information for ELAN IP address, ELAN gateway, ELAN netmask, hostname, domain name, Machine TLAN IP address, TLAN gateway, Default gateway, and TLAN netmask , as shown in [Figure 19 "Network configuration window" \(page 40\)](#).

**Figure 19**  
**Network configuration window**

```
Network Configuration  
-----  
Enter ELAN IP Address: 192.167.100.50  
Enter ELAN Gateway IP Address: 192.167.100.1  
Enter ELAN Netmask: 255.255.255.0  
Enter Hostname: cs1000em2  
Do you wish to configure the Domain Name  
Hostname + Domain Name = FQDN (Fully Qualified Domain Name) (Y/N)  
[Y]?  
Enter TLAN port Domain Name: quantum1.com  
Enter TLAN IP Address: 192.167.101.50  
Enter TLAN Gateway IP Address: 192.167.101.1  
Enter TLAN Netmask: 255.255.255.0  
  
Select default gateway NIC (0 - ELAN; 1 - TLAN) [1]:
```

**Note 1:** [Figure 114 "HP DL320 G4 rear view" \(page 125\)](#) shows the ELAN and TLAN network interfaces for the HP



DL320 G4 server. [Figure 123 "IBM x306m rear view"](#) (page 133) shows the ELAN and TLAN network interfaces for the IBM x306m server. For a definition of ELAN and TLAN see ["Network configuration"](#) (page 143).

**Note 2:** You can accept the default gateway values or choose a value that is more appropriate to your needs. The choice of ELAN or TLAN as the default gateway NIC can be influenced by the applications that you are going to deploy on the server and by your network topology. For a definition of ELAN and TLAN see ["Network configuration"](#) (page 143). It is not necessary to make changes to the default gateway during the installation. After the installation, the default gateway NIC can be changed by using the CLI commands `baseparamsconfig` or `networkconfig`. Routing entries can be added or deleted by using the CLI command `routeconfig`. For a list of Nortel Linux base CLI commands see [Table 11 "Nortel Linux base CLI commands"](#) (page 141).

Press **Enter** to continue. The **Configuration Validation 1** screen appears as shown in [Figure 23 "Configuration validation 1 window"](#) (page 44).

- 10 In the System Console Redirection screen appears as shown in [Figure 20 "System Console Redirection window"](#) (page 41). Select the redirection option and press **Enter** to continue.

**Note:** This screen appears only if you chose to install using an attached keyboard, video monitor, and mouse.

**Figure 20**  
**System Console Redirection window**

```
System Console Redirection
-----
An attached keyboard/monitor/mouse is being used for installation.
After installation is complete, the system console can be perma-
nently
redirected to a serial port to allow for remote access to the con-
sole.

Please choose the serial port to be used for system console redi-
rection:

    1) Serial Port 1
    2) Serial Port 2
    3) Do not redirect the system console after installation

Select an option (1-3):
```

- 11 In the **Time zone** selection screen type the appropriate region number at the prompt and then press **Enter** to continue.

**Figure 21**  
**Time zone selection window**

```
Timezone Selection
  1) Africa          2) America          3) Antarctica
  4) Arctic         5) Asia            6) Atlantic
  7) Australia     8) Brazil          9) CET
 10) CST6CDT      11) Canada         12) Chile
 13) Cuba         14) EET            15) EST
 16) EST5EDT     17) Egypt         18) Eire
 19) Etc          20) Europe         21) Factory
 22) GB           23) GB-Eire       24) GMT
 25) GMT+0       26) GMT-0         27) GMT0
 28) Greenwich   29) HST           30) Hongkong
 31) Iceland     32) Indian         33) Iran
 34) Israel       35) Jamaica       36) Japan
 37) Kwajalein   38) Libya         39) MET
 40) MST         41) MST7MDT      42) Mexico
 43) Mideast     44) NZ            45) NZ-CHAT
 46) Navajo      47) PRC           48) PST8PDT
 49) Pacific     50) Poland        51) Portugal
 52) ROC         53) ROK           54) Singapore
 55) SystemV     56) Turkey        57) UCT
 58) US          59) UTC           60) Universal
 61) W-SU        62) WET           63) Zulu
Enter Region (1-63): 20
```

The Time zone selection for region screen appears.

- 12** At the prompt, in the **Timezone Selection for Region** screen, type the appropriate time zone number and then press **Enter** to continue.

**Figure 22**  
Time zone selection for region window

```
Timezone Selection for Region "Europe"
 1) Amsterdam          2) Andorra            3) Athens
 4) Belfast           5) Belgrade          6) Berlin
 7) Bratislava        8) Brussels          9) Bucharest
10) Budapest          11) Chisinau         12) Copenhagen
13) Dublin            14) Gibraltar        15) Helsinki
16) Istanbul          17) Kaliningrad     18) Kiev
19) Lisbon            20) Ljubljana        21) London
22) Luxembourg        23) Madrid           24) Malta
25) Minsk             26) Monaco           27) Moscow
28) Nicosia           29) Oslo             30) Paris
31) Prague            32) Riga             33) Rome
34) Samara            35) San_Marino       36) Sarajevo
37) Simferopol        38) Skopje           39) Sofia
40) Stockholm         41) Tallinn          42) Tirane
43) Tiraspol          44) Uzhgorod         45) Vaduz
46) Vatican           47) Vienna           48) Vilnius
49) Warsaw            50) Zagreb           51) Zaporozhye
52) Zurich
 0) Return to region selection
Enter Timezone (0,1-52): 27
```

- 13** In the **Configuration Validation 1** screen, type **Y** for yes or **N** for no, and then press **Enter** to confirm the customer information for Machine ELAN IP address, ELAN Gateway , ELAN Netmask, Hostname, FQDN, Machine TLAN IP address, Default TLAN Gateway, TLAN Netmask, and Timezone, as shown in [Figure 23 "Configuration validation 1 window" \(page 44\)](#). For a definition of FQDN see ["FQDN requirements, page 30" \(page 36\)](#) .

If you select **N**, edit the information as required and repeat step 10.

**Figure 23**  
Configuration validation 1 window

```
Configuration Validation 1
-----
      ELAN IP Address: 192.168.35.103
      ELAN Gateway IP Address: 192.168.35.1
      ELAN Netmask: 255.255.255.0

      Hostname: hp3-e
      Fully Qualified Domain Name: hp3-e.asa.merann.ru

      TLAN IP Address : 192.168.35.104
      TLAN Gateway IP Address: 192.168.35.1
      TLAN Netmask: 255.255.255.0

      Default Gateway: 192.168.35.1

      Timezone: Europe/Moscow

Is this information correct (Y/N) [Y]?
```

- 14 In the Network Time Protocol (NTP) Configuration screen, type **Y** or **N** to choose the **NTP** transfer mode for the system. Type **1**, **2**, or **3** and then press **Enter** to indicate the clock source function of the Linux system, as shown in [Figure 24 "Network time protocol configuration window"](#) (page 45).

**Note:** NTP uses Message Digest Algorithm 5 (MD5) signatures to authenticate the exchange of timestamps when operating in secure mode.

**Figure 24**  
Network time protocol configuration window

```

Network Time Protocol (NTP) Configuration
-----

Please determine NTP transfer mode within your whole system:

  Do you wish to configure NTP in secure MD5 transfer mode? (Y/N) [Y]?
n

Please indicate the Clock Source function of this Linux system:

  1) Primary Clock Source server (This is the Primary NTP server)
  2) Secondary Clock Source server (another one is the Primary NTP
  server)
  3) This Linux system is NOT a Clock Source server

Select an option (1-3): 1

```

- 15 In the NTP Clock Source Configuration screen type **E** for an external clock source, or **I** for an internal clock source, as shown in [Figure 25 "NTP clock source configuration window"](#) (page 45). Press **Enter** to continue.

**Figure 25**  
NTP clock source configuration window

```

NTP Clock Source Configuration
-----

The Primary Clock Source server requires the use of an external clock.

Select External Clock for time source(s) external to this server.
Select Internal Clock to use the local system clock as the time source.

  E - External Clock Source (IP Addresses)
  I - Internal Clock (Unreliable)

Select an option (E, I): i

```

- 16 At the prompt, type the machine TLAN IP address of the clock source server as shown in [Figure 26 "NTP clock source configuration window"](#) (page 46).

**Figure 26**  
NTP clock source configuration window

```

NTP Clock Source Configuration
-----
The Primary Clock Source server requires the use of an external clock.

Select External Clock for time source(s) external to this server.
Select Internal Clock to use the local system clock as the time source.

    E - External Clock Source (IP Addresses)
    I - Internal Clock (Unreliable)

Select an option (E, I): i

Enter the TLAN IP Address
of the Clock Source server [192.168.35.104]:

```

Press **Enter** to continue.

- 17 At the prompt, configure the primary DNS server IP address as shown in [Figure 27 "DNS server configuration window" \(page 46\)](#).

**Figure 27**  
DNS server configuration window

```

DNS Server Configuration
-----
Do you wish to configure the Primary DNS Server IP Address (Y/N) [N]? y
Enter the Primary DNS Server IP Address: 192.168.50.30
Do you wish to configure the Secondary DNS Server IP Address (Y/N) [N]?

```

Type **Y** to configure and **N** if you do not wish to configure and then press **Enter**. If you selected **Y**, enter the IP address for the Primary DNS server at the prompt. The default for the Primary DNS server is **N**.

- 18 In the **Configuration Validation 2** screen, type **Y** if the information is correct and press **Enter**, as shown in the [Figure 28 "Configuration Validation 2 window" \(page 47\)](#). If the information is incorrect, type **N**, make the required changes, and then press **Enter**.

**Note:** The CLI command `hostconfig` can be used to modify the static lookup table for host names. For a list of Nortel Linux base CLI commands see [Table 11 "Nortel Linux base CLI commands" \(page 141\)](#)

The Configuration Validation 2 screen appears with the correct information. Press **Enter** to continue.

**Figure 28**  
Configuration Validation 2 window

```

Configuration Validation 2
-----
      NTP is not configured in secure MD5 transfer mode
      NTP Clock Source: Internal (Unreliable)
                        192.168.35.104

      Primary DNS Server IP Address: not configured
      Secondary DNS Server IP Address: not configured
      Tertiary DNS Server IP Address: not configured

Is this information correct (Y/N) [Y]?

```

- 19 In the Date and Time Configuration screen, configure the date and time, as shown in [Figure 29 "Date and Time Configuration window"](#) (page 47).

**Figure 29**  
Date and Time Configuration window

```

Date and Time Configuration
-----
Current Date and Time: 15:26:08 9/24/2007

Do you want to keep this date and time (Y/N) [Y]?

```

- Type **Y** to keep the date and time, and then press **Enter**. To change the date and time, press **N**, make the required changes, and press **Enter**. The Date and Time Configuration screen appears with the new date and time. Press **Enter** to continue.
- 20 In the Password Configuration screen, at the prompt, enter the root password, as shown in [Figure 30 "root password configuration window"](#) (page 48).

**Figure 30**  
root password configuration window

```
Password Configuration
-----
For security reasons, password entry keystrokes will not be shown as they
typed. Please ensure you type the correct password and remember it for
future reference. Once the installation is started, you will not be
prompted for the password again.

A valid password should be a mix of upper and lower case letters,
digits, and other characters. You can use an 8 character long
password with characters from at least 3 of these 4 classes.
An upper case letter that begins the password and a digit that
ends it do not count towards the number of character classes used.
Enter the "root" password:
Enter the "root" password again:
```

**Note:** Guidelines for the creation and use of passwords are described at ["Passwords"](#) (page 110).

- 21 Enter the sysadmin password as shown in [Figure 31 "sysadmin password configuration window"](#) (page 48).

**Figure 31**  
sysadmin password configuration window

```
Password Configuration
-----
For security reasons, password entry keystrokes will not be shown as they
typed. Please ensure you type the correct password and remember it for
future reference. Once the installation is started, you will not be
prompted
for the password again.

A valid password should be a mix of upper and lower case letters,
digits, and other characters. You can use an 8 character long
password with characters from at least 3 of these 4 classes.
An upper case letter that begins the password and a digit that
ends it do not count towards the number of character classes used.
Enter the "sysadmin" password:
Enter the "sysadmin" password again:
```

- 22 Enter the nortel password as shown in [Figure 32 "nortel password configuration window"](#) (page 49). Password policies



and creation guidelines are described at "Passwords" (page 110).

**Figure 32**  
**nortel password configuration window**

```
Password Configuration
-----
For security reasons, password entry keystrokes will not be shown as they
typed. Please ensure you type the correct password and remember it for
future reference. Once the installation is started, you will not be
prompted
for the password again.

A valid password should be a mix of upper and lower case letters,
digits, and other characters. You can use an 8 character long
password with characters from at least 3 of these 4 classes.
An upper case letter that begins the password and a digit that
ends it do not count towards the number of character classes used.
Enter the "nortel" password:
Enter the "nortel" password again:
```

Press **Enter** to continue. The Configuration File Backup screen appears as shown in [Figure 33 "Configuration File Backup window" \(page 50\)](#).

- 23** From the Configuration File Backup screen, select an option to back up the configuration data.

**Figure 33**  
**Configuration File Backup window**

```
*****
*   CS 1000 Linux Base System pre-installation is finishing   *
*                   Please wait .....                       *
*****
Configuration File Backup
-----
1. Do not create a backup copy of your configuration file.
2. Create a backup copy of your configuration file to external USB
   device.
3. Create a backup copy of your configuration file to SFTP server.

Select an option (1-3):1
You can make backup later by using command 'sysbackup'
Press the ENTER key to continue.

Installation in progress...
```

The naming convention for the Linux base backup archive is `hostname-install-yyyy.mm.dd.hh.MM.ss.tar.gz`. The name for the backup archive is automatically generated and includes the key word `install` to indicate that the archive is generated as part of the installation or upgrade procedure. For example, `hp3-e-install-2008.09.04.18.54.47.tar.gz` is a backup archive name where `hp3-e` is the host name. The archive name begins with the short host name (not the FQDN) and the key word `install`, and contains the following fields:

- `yyyy` - year
- `mm` - month
- `dd` - day
- `hh` - hour
- `MM` - minutes
- `ss` - seconds

**Note:** Nortel Linux base uses the CLI command `sysbackup` to back up system data to external storage. You can choose to back up the data to a USB device or to an SFTP server. For more information about SFTP data back up, see [“Network configuration for Secure File Transfer Protocol \(SFTP\) data backup” \(page 143\)](#). For a list of Nortel Linux base CLI commands see [Table 11 “Nortel Linux base CLI commands” \(page 141\)](#).

After you back up the configuration data, the Package Installation screen appears, as shown in [Figure 34 "Package Installation window"](#) (page 51).

**Figure 34**  
Package Installation window

```

Red Hat Enterprise Linux (C) 2004 Red Hat, Inc.

+-----+ Package Installation +-----+
|
| Name   : man-pages-1.67-3-noarch
| Size   : 12888k
| Summary: Man (manual) pages from the Linux
|         Documentation Project.
|
|                               58%
|
| Packages      Bytes      Time
| Total       :      273     764M    0:13:27
| Completed:      2         0M    0:00:00
| Remaining:   271     764M    0:13:26
|
|                               0%
|
+-----+

<Tab>/<Alt-Tab> between elements | <Space> selects | <F12> next screen
    
```

The **Post System Configuration** screen appears, as shown in [Figure 35 "Post system configuration window"](#) (page 51). The system automatically reboots as a Linux server.

**Figure 35**  
Post system configuration window

```

#####
#                               #
#           Post System Configuration           #
#####

Post system installation configuration is now being performed.

The CD will be ejected and the machine will reboot once this
process has completed.
    
```

--End--



---

# Upgrade Nortel Linux base

---

This chapter documents the process of upgrading Nortel Linux base.

## Prerequisites to upgrade Nortel Linux base

Before you perform the upgrade you must gather the following information:

- ELAN IP address
- ELAN gateway IP address
- ELAN netmask
- The host name associated with the TLAN
- The domain name

**Note:** A Fully Qualified Domain Name (FQDN) consists of a host name and a domain name, and includes a top-level domain name. Using kwei.ca.nortel.com as an example, kwei is the host name, ca.nortel.com is the domain name, and .com is the top-level domain name. The FQDN must contain at least three fields.

- TLAN IP address
- TLAN gateway IP address
- TLAN netmask
- Time zone
- IP address of Network Time Protocol (NTP) Server
- IP address of the Primary Domain Name Service (DNS) server
- Default system gateway associated with the network interface (ELAN or TLAN)

**Note 1:** The choice of ELAN or TLAN as the default gateway NIC can be influenced by the applications that you are going to deploy on the server and by network topology. [Figure 114 "HP DL320 G4 rear view" \(page 125\)](#) shows the ELAN and TLAN network interfaces for the HP DL320 G4 server. It shows the ELAN and TLAN network

interfaces for the IBM x306m server. For a definition of ELAN and TLAN see [“Network configuration” \(page 143\)](#).

**Note 2:** Use the CLI command `routeconfig` to add routing entries. The choice of routing entries will depend upon the network topology and application deployment. For a list of Nortel Linux base CLI commands see [Table 11 "Nortel Linux base CLI commands" \(page 141\)](#).

You can change the base parameters after the upgrade is complete using the CLI command `baseparamsconfig`. A change in the base parameters can impact other application components. For example, if the current server is the Primary ECM security server and the FQDN changes it is necessary to reinstall the applications.

The CLI command `baseparamsconfig` is an umbrella command that you can use to configure parameters for network settings, Network Time Protocol settings, date and time settings, and DNS settings. These parameters can also be configured individually by using the CLI commands `networkconfig`, `ntpconfig`, `datetimeconfig`, and `dnsconfig`. For a list of Nortel Linux base CLI commands see [Table 11 "Nortel Linux base CLI commands" \(page 141\)](#).

## Upgrading Nortel Linux base

Use the following procedure to upgrade Nortel Linux base.

The time required to upgrade the Linux base is approximately 20 minutes. The time required to upgrade the Nortel Linux base applications is approximately 1 hour. Additionally, 30 minutes is required for Enterprise Common Manager (ECM) configuration.

### Upgrading Nortel Linux base

Step	Action
1	Insert the Linux base installation CD for the latest release and use the CLI command <code>upgrade</code> to begin the upgrade process. You are asked to continue with the upgrade, as shown in <a href="#">Figure 36 "Backup data window" (page 55)</a> . Type <b>Y</b> and press <b>Enter</b> to continue. You are given the option to back up the data to an external source. To back up data to an external source type <b>Y</b> and press <b>Enter</b> . Select a backup media and supply the necessary details. For more information about SFTP data back up, see <a href="#">“Network configuration for Secure File Transfer Protocol (SFTP) data backup” (page 143)</a> Press <b>Enter</b> to continue.

**Figure 36**  
**Backup data window**

```
This tool will perform Linux Base upgrade. Before the upgrade it
will backup all data.

Do you want to continue with the upgrade? (Y/N) [N]?

System data will be saved at /admin partition.
Please use option "Re-use /admin partition" during Linux Base
installation.

Do you want to backup data to external source (USB/SFTP) as well?
(Y/N) [Y]?

1. Backup to USB device.
2. Backup to SFTP server.

Enter your choice (q for exit): 2

Enter the secure FTP server's IP address [192.168.35.105]:
Enter the SFTP login [nortel]:
Enter the SFTP password:
Enter the remote SFTP directory [/admin/nortel]:
```

- 2 Confirm the values for the Local machine IP address, Local machine netmask, Gateway, SFTP server's IP address, SFTP userid, SFTP password, and the SFTP directory as shown in the [Figure 37 "Remote Configuration File Validation window"](#) (page 56).

Type **Y** to confirm the values and press **Enter** to continue.

**Note:** This example uses the choice of data backup to an SFTP server. Data backup to a USB device will produce different screens.

**Figure 37**  
**Remote Configuration File Validation window**

```
Remote Configuration File Validation
-----
Local machine IP: 192.168.35.103
Local machine netmask: 255.255.255.0
Gateway: 192.168.35.1

SFTP server IP: 192.168.35.105

SFTP userid: nortel
SFTP password: *****
SFTP directory: /admin/nortel
Is this information correct (Y/N) [Y]?
```

- 3 The backup archive name generates and you are prompted to continue, as shown in [Figure 38 "Backup data window 2"](#) (page 56). Type **Y** to continue. The backup operation finishes and you are prompted to insert the Linux base upgrade CD. Press **Enter** after you insert the CD to reboot the system.

**Figure 38**  
**Backup data window 2**

```
Backup started. Please wait...
Backup archive with name hp3-e-2007.10.04.10.35.37.tar.gz and size
11853 bytes was generated.
Backup operation may take a long time.
Do you want to continue (Y/N) [Y]?
Operation in progress. Please wait.
Backup complete.

Please insert Linux Base CD for upgrade, then press ENTER key

Broadcast message from root (pts/0) (Thu Oct 4 10:35:58 2007):

The system is going down for reboot NOW!
```

- 4 The CS 1000 Linux base system installer screen appears, as shown in [Figure 39 "CS 1000 Linux base system installer"](#) (page 57). Choose one of the following methods of installation:



- To install using a serial console on COM1, type **com1** at the boot prompt and press **Enter**. to continue.
- To install using an attached keyboard, video monitor, and mouse, type **kvm** at the boot prompt and press **Enter**. to continue.

**Note:** It is not required to attach a keyboard, video monitor and mouse (KVM) to view output. A console-based installation will also provide output.

**Figure 39**  
**CS 1000 Linux base system installer**

```
System Release:      nortel-cs1000-linuxbase-4.91-30.00
Build Timestamp:    Thu Nov 23 20:26:33 EST 2006

Welcome to the CS 1000 Linux Base System Installer

- To install via a serial console on COM1, type com1 <ENTER>.
  All input and output will be directed to the COM1 serial port. The system
  console will be permanently installed on COM1.

- To install via an attached keyboard/monitor/mouse, type kvm <ENTER>. All
  input and output will be directed to the attached keyboard/monitor/mouse.
  During installation, you will be given the opportunity to permanently
  install the system console on a user specified serial port. If you choose
  not to, the system console will be permanently installed on the attached
  keyboard/monitor/mouse.

***The default is --- com1***.

boot: _
```

- 5 The Installation of New Linux Base Operating System screen appears, as shown in [Figure 40 "Installation of New Linux Base Operating System window"](#) (page 58). Type **Y** to accept the new installation. Press **Enter** to continue.

**Figure 40**  
**Installation of New Linux Base Operating System window**

```
#####  
#####  
  
      Installation of New Linux base Operating System  
  
Existing Linux base release:  
  System Release:      nortel-cs1000-linuxbase-5.00-40.00  
  Build Timestamp:    Fri May 18 22:53:48 EDT 2007  
  
New Linux base release:  
  System Release:      nortel-cs1000-linuxbase-5.25.04.00  
  Build Timestamp:    Wed Oct  3 09:59:25 MSD 2007  
  
#####  
#####  
  
Do you wish to proceed with installation (Y/N) [Y]?
```

- 6 The Existing Configuration Partition Usage window appears, as shown in [Figure 41 "Existing Configuration Partition Usage window"](#) (page 59).

If this re-installation is due to a possible disk corruption, Nortel recommends that you format this partition. Type **Y** to format the partition.

If this re-installation is not due to disk corruption, leaving this partition is a safe option. Type **N** to maintain the partition. Press **Enter** to continue.

**Figure 41**  
Existing Configuration Partition Usage window

```
Existing Configuration Partition Usage
-----
A pre-existing administration partition has been found on this system.

If this re-installation is due to a possible disk corruption, it
is recommended that you format this partition to avoid any file
corruption that may be present. In this case, all data will be
removed from this partition and you will be required to manually
enter all installation questions from scratch.

If this re-installation is not due to disk corruption, then leaving
the partition is a safe option, and if valid data from the previous
configuration exists, you will be given the option of reusing that data
during this installation.

Do you wish to format the administration partition (Y/N) [N]?
```

7 The Existing Partitions window appears as shown in [Figure 42](#) "Existing Partitions window" (page 59). Press **Enter** to continue.

**Figure 42**  
Existing Partitions window

```
#####
#####

EXISTING PARTITIONS FOUND THIS SYSTEM

THE /admin PARTITION EXISTS AND WILL NOT BE
FORMATTED. ALL OTHER PARTITIONS WILL BE FORMATTED.
THIS DATA CANNOT BE RESTORED ONCE FORMATTED BY
THIS INSTALLATION PROGRAM.

PRESS THE ENTER KEY TO CONTINUE..

#####
#####
```

8 The Configuration Data Selection window appears, as shown in [Figure 43](#) "Configuration Data Selection window" (page 60).

**Figure 43**  
**Configuration Data Selection window**

```
Configuration Data Selection
-----
A pre-existing system configuration data file has been found
on this computer.

You may choose to do one of the following:

1) Reuse the data from this pre-existing configuration file. The data
   input-validation-screens will be shown for validation.

2) Use backed up data from a USB device.
   (Note: only one USB device should be plugged-in when prompted.)

3) Use remote backed up data from a SFTP-server. This requires the
   provision of SFTP server information.

4) Ignore the data in pre-existing configuration file. The standard
   system-configuration-prompts will be presented.

Select an option (1-4): 3
```

Type the option number corresponding to the data source that you want to use and press **Enter** to continue.

**Note:** In this example the [Figure 44 "Remote Configuration File Operation window" \(page 61\)](#) appears because option 3 is selected in the [Figure 17 "Configuration data selection window" \(page 39\)](#). If you choose a different data configuration option, different screens display.

- 9 For this example, option 3 is shown to illustrate the use of previously backed up data during the Linux Base installation. Enter the values for the ELAN IP address, ELAN gateway IP address, ELAN netmask, secure FTP server's IP address, SFTP logon name, SFTP password, and the remote SFTP directory as shown in the [Figure 44 "Remote Configuration File Operation window" \(page 61\)](#).

**Figure 44**  
Remote Configuration File Operation window

```
Remote Configuration File Operation
-----
Enter ELAN IP Address: 192.168.35.103
Enter ELAN Gateway IP Address: 192.168.35.1
Enter ELAN Netmask: 255.255.255.0
Enter the secure FTP server's IP address: 192.168.35.105
Enter the SFTP login: nortel
Enter the SFTP password:
Enter the remote SFTP directory: /admin/nortel
```

Press **Enter** to continue.

- 10** Confirm the values for the Local machine IP address, Local machine netmask, Gateway, SFTP server's IP address, SFTP userid, SFTP password, and the SFTP directory as shown in the [Figure 45 "Remote Configuration File Validation window"](#) (page 61).

Type **Y** to confirm the values and press **Enter** to continue.

**Figure 45**  
Remote Configuration File Validation window

```
Remote Configuration File Validation
-----
Local machine IP: 192.168.35.103
Local machine netmask: 255.255.255.0
Gateway: 192.168.35.1

SFTP server IP: 192.168.35.105

SFTP userid: nortel
SFTP password: *****
SFTP directory: /admin/nortel
Is this information correct (Y/N) [Y]?
```

- 11** The File Selection window appears as shown in [Figure 46 "File Selection window"](#) (page 62). Type the option number for the file name that corresponds to the backup archive you created in step2, shown in [Figure 38 "Backup data window 2"](#) (page 56).

**Figure 46**  
**File Selection window**

```
Configuring the local network...
Retrieving file listing from 192.168.35.105...
Please select one of files (0 means exit):
1) asa-hp4-e-2007.08.03.11.24.32.tar.gz
2) asa-hp4-e-2007.08.03.16.17.16.tar.gz
3) sems.tar.gz
4) asa-hp4-e-2007.09.06.16.58.29.tar.gz
5) asa-hp4-e-2007_09_11-11_24_23.tar.gz
6) asa-hp4-e-2007_09_11-11_24_49.tar.gz
7) asa-hp4-e-2007_09_21-09_34_27.tar.gz
8) asa-hp4-e-2007_09_21-11_58_56.tar.gz
9) asa-hp4-e-2007_09_21-12_09_01.tar.gz
10) hp3-e-2011.08.27.13.47.43.tar.gz
11) hp3-e-install-2011_08_27-14_12_05.tar.gz
12) hp3-e-2007.10.04.10.30.54.tar.gz
13) hp3-e-2007.10.04.10.35.37.tar.gz
Select (0,1-13): 13
```

- 12** In the Configuration Validation 1 screen, type **Y** for yes or **N** for no, and then press **Enter** to confirm the customer information for Machine ELAN IP, ELAN Gateway, ELAN Netmask, Hostname, FQDN, Machine TLAN IP, Default TLAN Gateway, TLAN Netmask, and Timezone, as shown in [Figure 47 "Configuration validation 1 window"](#) (page 63). For a definition of FQDN see ["FQDN requirements, page 30"](#) (page 36) .

If you select **N**, edit the information as required and repeat step 10.

Figure 47  
Configuration validation 1 window

```
Configuration Validation 1
-----
      ELAN IP Address: 192.168.35.103
      ELAN Gateway IP Address: 192.168.35.1
      ELAN Netmask: 255.255.255.0

      Hostname: hp3-e
      Fully Qualified Domain Name: hp3-e.asa.merann.ru

      TLAN IP Address : 192.168.35.104
      TLAN Gateway IP Address: 192.168.35.1
      TLAN Netmask: 255.255.255.0

      Default Gateway: 192.168.35.1

      Timezone: Europe/Moscow

Is this information correct (Y/N) [Y]?
```

- 13 In the Configuration Validation 2 screen, type **Y** if the information is correct and press **Enter**, as shown in the [Figure 48 "Configuration Validation 2 window" \(page 64\)](#). If the information is incorrect, type **N**, make the required changes, and then press **Enter**.

**Note:** The CLI command `hostconfig` is used to modify the static lookup table for host names. For a list of Nortel Linux base CLI commands see [Table 11 "Nortel Linux base CLI commands" \(page 141\)](#)

The Configuration Validation 2 screen appears with the correct information. Press **Enter** to continue.

**Figure 48**  
Configuration Validation 2 window

```
Configuration Validation 2
-----
      NTP is not configured in secure MD5 transfer mode
      NTP Clock Source: Internal (Unreliable)
                        192.168.35.104

      Primary DNS Server IP Address: not configured
      Secondary DNS Server IP Address: not configured
      Tertiary DNS Server IP Address: not configured

      Is this information correct (Y/N) [Y]?
```

- 14 In the Date and Time Configuration screen, configure the date and time, as shown in [Figure 49 "Date and Time Configuration window"](#) (page 64).

**Figure 49**  
Date and Time Configuration window

```
Date and Time Configuration
-----
Current Date and Time: 15:26:08 9/24/2007

Do you want to keep this date and time (Y/N) [Y]?
```

- Type **Y** to keep the date and time, and then press **Enter**. To change the date and time, press **N**, make the required changes, and press **Enter**. The Date and Time Configuration screen appears with the new date and time. Press **Enter** to continue.
- 15 The Existing Password Data screen appears, as shown in [Figure 50 "Existing Password Data window"](#) (page 65). If you choose to enter new passwords type **Y** and press **Enter**. The root password configuration screen, sysadmin password configuration screen, and nortel password configuration screen appear as shown in [Figure 30 "root password configuration window"](#) (page 48), [Figure 31 "sysadmin password configuration window"](#) (page 48), and [Figure 32 "nortel password configuration window"](#) (page 49). Enter the new passwords and press **Enter** to continue. If you choose to keep the old passwords type **N** and press **Enter** to continue.



**Figure 50**  
Existing Password Data window

```
Existing Password Data

Passwords for default accounts exist.
Do you wish to enter new passwords for these accounts (Y/N) [N]?
```

- 16 The System-wide data recovery screen appears, as show in [Figure 51 "System-Wide Data Recovery window" \(page 65\)](#). If you want to recover the system-wide data, select **Y**. If you do not want to recover the system-wide data, select **N**. Press **Enter** to continue.

**Figure 51**  
System-Wide Data Recovery window

```
System-wide data recovery
-----

Do you want to recover system-wide data (Y/N) [Y]?
```

- 17 The Configuration File Backup screen appears, as shown in [Figure 52 "Configuration File Backup window" \(page 65\)](#). Select an option to back up the configuration data.

**Figure 52**  
Configuration File Backup window

```
Configuration File Backup
-----

1. Do not create backup copy of your configuration file.
2. Create a backup copy of your configuration file to external USB device.
3. Create a backup copy of your configuration file to SFTP server.

Select an option (1-3):
```

The naming convention for the Linux base backup archive is `hostname-install-yyyy.mm.dd.hh.MM.ss.tar.gz`. The name for the backup archive is automatically generated and includes the key word `install` to indicate that the archive is generated as part of the installation or upgrade procedure. For example, `hp3-e-install-2008.09.04.18.54.47.tar.gz` is a backup archive name where `hp3-e` is the host name. The archive name begins with the short host name (not the FQDN) and the key word `install`, and contains the following fields:

- yyyy—year
- mm—month
- dd—day
- hh—hour
- MM—minutes
- ss—seconds

**Note:** Nortel Linux base uses the CLI command `sysbackup` to backup system data to external storage. You can choose to back up the data to a USB device or to an SFTP server. For more information about SFTP data back up, see “[Network configuration for Secure File Transfer Protocol \(SFTP\) data backup](#)” (page 143). For a list of Nortel Linux base CLI commands see [Table 11 "Nortel Linux base CLI commands"](#) (page 141).

After you back up the configuration data, the **Package Installation** screen appears, as shown in [Figure 53 "Package Installation window"](#) (page 66).

**Figure 53**  
Package Installation window

```

Red Hat Enterprise Linux (C) 2004 Red Hat, Inc.

+-----+ Package Installation +-----+
|
| Name   : man-pages-1.67-3-noarch
| Size   : 12888k
| Summary: Man (manual) pages from the Linux
|          Documentation Project.
|
|                               58%
|
| Packages      Bytes      Time
| Total       :      273      764M      0:13:27
| Completed:   :         2         0M      0:00:00
| Remaining:   :      271      764M      0:13:26
|
|                               0%
|
+-----+
<Tab>/<Alt-Tab> between elements | <Space> selects | <F12> next screen

```

The **Post System Configuration** screen appears, as shown in [Figure 54 "Post system configuration window" \(page 67\)](#). The system automatically reboots as a Linux server.

**Figure 54**  
Post system configuration window

```
#####
#           Post System Configuration           #
#####

Post system installation configuration is now being performed.

The CD will be ejected and the machine will reboot once this
process has completed.
```

- 18 Insert the appropriate application CD or DVD and type the CLI command `appinstall`. The Installation Stage window appears as shown in [Figure 55 "Installation stage window" \(page 67\)](#). Type the option number for the configuration that you chose and press **Enter** to continue.

**Figure 55**  
Installation stage window

```
#####
#           Installation stage                 #
#####

Nortel Enterprise Common Manager (ECM)
Network Routing Service (NRS) installation
This server will function as:
1. The Primary ECM Server (install NRS and the primary ECM security service) 5.25.03
2. A Backup ECM Server (install NRS and a backup ECM security service) 5.25.03
3. A Member Server (install NRS with ECM joining an existing secure network) 5.25.03
Please select the supported configuration # to install (q for exit): 1
```

**Note:** If you are installing ECM/EM/SM, the Application Installation window appears instead, as shown in [Figure 56 "Application Installation window" \(page 68\)](#).

**Figure 56**  
**Application Installation window**

```
#####
#                               Installation stage                               #
#####

Nortel Enterprise Common Manager (ECM)
Network Routing Service (NRS) installation
This server will function as:
1. The Primary ECM Server (install NRS and the primary ECM security service)
2. A Backup ECM Server (install NRS and a backup ECM security service)
3. A Member Server (install NRS with ECM joining an existing secure network)
Please select the supported configuration # to install (q for exit):
```

19 In the [Figure 57 "Restore Application Data window"](#) (page 68) you are given a prompt to restore application data. Type **Y** or **N** to restore or reject the data. Press **Enter** to continue.

**Figure 57**  
**Restore Application Data window**

```
Restore data is found for application
Configuration: The Primary ECM Server (install NRS and the primary ECM security service)
Version: 5.25.03
Do you want to restore data from the archive? (Y/N) [Y]?
```

At this point see the chapter ["Installation and configuration of applications on Linux base"](#) (page 69). In the section ["Install the CS 1000 applications"](#) (page 70) choose the installation procedure for the application that you want to install, and follow the instructions to complete the installation.

The system upgrade is complete after the installation of the applications is finished.

---

--End--

---

---

## Installation and configuration of applications on Linux base

---

This section provides information about the following tasks that you must complete to install and configure applications after you install the Linux base.

- Configure the Primary Security Service (PSS) and Backup Security Service (BSS)
- Configure the Network Routing Service (NRS) and the Element Manager (EM) applications
- Configure the system account passwords for the Primary Security Service and member server, and the Backup Security Services and member server

This chapter contains the following installation procedures:

- [“Installing the Primary Security Service and Network Routing Service” \(page 71\)](#)
- [“Installing the Backup Security Service and Network Routing Service” \(page 76\)](#)
- [“Installing the Network Routing Service with ECM joining an existing secure network” \(page 79\)](#)
- [“Installing the Primary Security Service and Element Manager” \(page 82\)](#)
- [“Installing the Backup Security Service and Element Manager” \(page 86\)](#)
- [“Installing the Element Manager joining an existing secure network” \(page 89\)](#)
- [“Installing the Primary Security Service, Subscriber Manager, and Element Manager” \(page 92\)](#)
- [“Installing the Backup Security Service, Subscriber Manager, and Element Manager” \(page 96\)](#)

## Prerequisites to install and configure applications

You must install the Communication Server 1000 (CS 1000) Linux base software on the HP DL320 G4 or the IBM x306m servers before they can install the applications. The Linux base software contains the Linux operating system, the framework software, and the required third-party software such as the Web server and Java runtime environment (JRE).

Before you install the Linux applications you must run host configuration scripts on every server in the Enterprise Common Manager (ECM) domain. For more information on running host configuration scripts see the Host configuration section of *Enterprise Common Manager Fundamentals (NN43001-116)* ().



### WARNING

Nortel Linux applications are supported only on Nortel CS 1000 Linux base. Nortel Linux applications do not function on other versions of Linux.

## Install the CS 1000 applications

Use the following procedures to run the application CD-ROM or DVD and install the applications. There is a CD for NRS applications that contains three application configurations and a DVD for Element Manager applications (MGMT DVD) that contains five application configurations. The installation of Nortel Linux applications takes approximately 1 hour to complete. Additionally, 30 minutes is required for Enterprise Common Manager (ECM) configuration.

The NRS CD contains the following configuration options:

- Primary ECM Server (install NRS and the primary ECM security service)
- Backup ECM Server (install NRS and a backup ECM security service)
- Member Server (install NRS with ECM joining an existing secure network)

The MGMT DVD contains the following configuration options:

- Primary ECM Server (install EM and the primary ECM security service)
- Backup ECM Server (install EM and a backup ECM security service)
- Member Server (install EM with ECM joining an existing secure network)

- Primary ECM Server (install EM, Subscriber Manager, and the primary ECM security service)
- Backup ECM Server (install EM, Subscriber Manager, and a backup ECM security service)

**ATTENTION**

The first Linux server must be installed with the primary security service. Install the second Linux server with the backup security service, and then install any other required Linux servers. After the installation is complete for each installation option, you must log on to ECM and add the element (Network Routing Service or Element Manager) that was installed on each server. For more information about adding elements, see *Enterprise Common Manager Fundamentals (NN43001-116)* ().

**Note:** You can install the Primary and Backup Security Service with either NRS or EM. The load on the NRS server is usually heavier than the EM server. To optimize the servers load balance, Nortel recommends that if both EM on Linux and NRS Manager on Linux are installed, then install the Primary Security Service with EM and install the Backup Security Service with the Primary NRS server. In this case the Secondary NRS becomes a security client of the Primary and Backup Security servers.

If you are not installing EM on Linux, Nortel recommends that you install the Primary Security Service with the Primary NRS server and install the Backup Security Service with the Secondary NRS server.

At first logon to the Enterprise Common Manager (ECM) framework, change the password. For NRS password guidelines see Network Routing Service Installation and Commissioning (NN43001-564); for EM guidelines see *Element Manager System Reference—Administration (NN43001-632)* ().

If a password does not meet the policy requirements, the system rejects it.

For the following procedures, installation initiates configuration of the solid database.

**Installing the NRS applications**

Use this procedure to run the application CD-ROM after the reboot is complete for the Linux base installation.

**Installing the Primary Security Service and Network Routing Service**

Step	Action
1	Log on to the server using the nortel account.
2	Insert the NRS CD-ROM in the CD-ROM tray.

- 3 Enter the `appinstall` CLI command.
- 4 At the prompt, enter the root account password.  
The system then prompts you to check the media.
- 5 Enter **Y** to check the media, or **N** to proceed without checking the media, and press **Enter**.
- 6 The Application installation screen appears, as shown in [Figure 58 "Application Installation window" \(page 72\)](#). From the **Application installation** window select **1** to install the Primary Security Service with NRS. The appropriate packages are installed to the hard drive.

**Figure 58**  
**Application Installation window**

```
#####
#                               Installation stage                               #
#####

Nortel Enterprise Common Manager (ECM)
Network Routing Service (NRS) installation
This server will function as:
1. The Primary ECM Server (install NRS and the primary ECM security service)
2. A Backup ECM Server (install NRS and a backup ECM security service)
3. A Member Server (install NRS with ECM joining an existing secure network)
Please select the supported configuration # to install (q for exit):
```

- 7 The Solid server configuration confirmation screen appears.  
Confirm the server selection by selecting **Yes**, or return to the Solid server configuration window by selecting **No**. Press **Enter** to continue.



**Figure 59**  
**Solid server configuration window**

```
Please select the type of Solid server to run

1 - Stand alone Solid database server
2 - Hotstandby Primary Solid database server
3 - Hotstandby Secondary Solid database server

Enter selection: █
```

- 8 The Solid server configuration confirmation screen appears. Type the option number for the Solid server to install. To determine which option to select, review the *Network Routing Service Installation and Commissioning (NN43001-564)* Database and Database synchronization/operation sections. Press **Enter** to continue.
- 9 The Private Certificate Authority (CA) certificate screen appears as shown [Figure 60 "Private CA certificate window" \(page 74\)](#). Press **Enter** to display the prompts for **Country, State or Province, Location, Organization Name** and **Organization Unit** . Type the response for each of these categories and press **Enter** to continue.

Figure 60  
Private CA certificate window

```
*****
Information for the Private CA Certificate

The following information is required and can not be omitted.

Country (2-letter code)
State or Province (full name)
Locality (usually city)
Organization Name
Organization Unit (division)

Note: The 'Common Name' information will be filled in automatically by
using your server's FQDN.

Press Enter to proceed.
*****
```

- 10 The Private CA Certificate confirmation screen appears as shown in [Figure 61 "Private CA Certificate confirmation window" \(page 74\)](#). Verify that the common name information is correct. Type **yes** if correct or **no** if incorrect, and then press **Enter**. If you entered yes, the installation finishes and the system creates the CA certificate, as shown in [Figure 62 "Making a Private CA certificate window" \(page 75\)](#). If you selected no, edit the information as required and repeat the step.

Figure 61  
Private CA Certificate confirmation window

```
Please confirm the Distinguished Name information:

Country (2-letter code):          CA
Country Full Name:               CANADA
State or Province (full name):   New Brunswick
Locality (usually city):        Saint John
Organization Name:              Innovatia
Organization Unit (division):   T5 Lab
Common Name (your server's FQDN): cs1000em.quantum1.com

Is the information correct (yes/no)?
yes
```

**Figure 62**  
**Making a Private CA certificate window**

```
Making CA certificate ...  
  
Creating a certificate for Web SSL ...  
Done creating a certificate for Web SSL.  
  
The fingerprint of the Certificate-Authority machine is as follows:  
  
2c:77:39:5f:63:90:f9:2c:8f:85:af:fd:f2:2e:d9:b7  
  
You will need to confirm the fingerprint when you install another server that  
does not have a private CA. The fingerprint can also be viewed on the  
Certificates configuration page of the web interface.
```

- 11 The Security services administrator default password screen appears, as shown in [Figure 63 "Security services administrator default password window"](#) (page 76). Enter a new default password for the security services administrator accounts, and then re-enter the new password.

**Figure 63**  
**Security services administrator default password window**

```
Change the default password of security-services administrator
accounts in ECM. The new password must follow current policies. It
must have at least one upper case character, one lower case charac-
ter, one numeric character and one special character. The minimum
number of characters in the new password is twelve. Valid charac-
ters in the password are a-zA-Z0-9{|} | () , / . = [ ] ^ ~ _ @ ! ` ;
```

```
Enter a new password that will be used for all accounts.
```

```
Enter "new" password: *****
```

```
Re-enter the new password
```

```
Enter "the new" password: *****
```

```
Passwords match.
```

```
NOTE: Changing passwords. This may take a few minutes ...
```

```
NOTE: Password changes succeeded.
```

---

--End--

---

The installation takes approximately 30 minutes to complete. After the installation is complete the disk automatically ejects from the drive and a summary of the installation is shown on the screen.

For detailed information about NRS see *Network Routing Service Installation and Commissioning (NN43001-564)* ().

#### Installing the Backup Security Service and Network Routing Service

Step	Action
1	Log on to the server using the nortel account.
2	Insert the NRS CD-ROM in the CD-ROM tray.
3	Enter the <code>appinstall</code> CLI command
4	At the prompt, enter the root account password. The system then prompts you to check the media.
5	Enter <b>Y</b> to check the media, or <b>N</b> to proceed without checking the media, and press <b>Enter</b> .

- 6 The Application installation screen appears, as shown in [Figure 64 "Application Installation window" \(page 77\)](#). From the **Application installation** window select **2** to install the Backup Security Service with NRS. The appropriate packages are installed to the hard drive.

**Figure 64**  
Application Installation window

```
#####
#                               Installation stage                               #
#####

Nortel Enterprise Common Manager (ECM)
Network Routing Service (NRS) installation
This server will function as:
1. The Primary ECM Server (install NRS and the primary ECM security service)
2. A Backup ECM Server (install NRS and a backup ECM security service)
3. A Member Server (install NRS with ECM joining an existing secure network)
Please select the supported configuration # to install (q for exit):
```

- 7 The Solid server window appears, as shown in [Figure 65 "Solid server configuration window" \(page 77\)](#). In the Solid server configuration screen, type the option number of the Solid server to install and press **Enter**.

**Figure 65**  
Solid server configuration window

```
Please select the type of Solid server to run

1 - Stand alone Solid database server
2 - Hotstandby Primary Solid database server
3 - Hotstandby Secondary Solid database server

Enter selection:█
```

Press **Enter** to continue.

- 8 The Solid server configuration confirmation screen appears. Confirm the server selection by selecting **Yes**, or return to the

Solid server configuration window by selecting **No**. Press **Enter** to continue.

- 9 The **Primary Security Service server TLAN IP address** screen appears as shown in [Figure 66 "Primary Security Service server TLAN IP address window" \(page 78\)](#). Enter the IP address of the TLAN network interface Primary Security Service server. Type **yes** to confirm the TLAN IP address is correct.

**Figure 66**  
**Primary Security Service server TLAN IP address window**

```
What is the TLAN IP address of the Primary Security Service server?
192.167.103.10

You entered 192.167.103.10 as the IP address. Is this correct (yes/no)?
Yes
```

- 10 The **Primary Security Service server Fully Qualified Domain Name (FQDN)** appears as shown in [Figure 67 "Primary Security Service server Fully Qualified Domain name window" \(page 78\)](#). Enter the Fully Qualified Domain name of the Primary Security Service server. Type **Yes** to confirm the FQDN is correct. For a definition of FQDN see ["FQDN requirements, page 30" \(page 36\)](#) .

**Figure 67**  
**Primary Security Service server Fully Qualified Domain name window**

```
Please enter the Fully Qualified Domain name of Primary Security Service Server
cs1000em.quantum1.com

You entered cs1000em.quantum1.com as the FQDN. Is this correct (yes/no)?
Yes
```

**Note:**

- ***The Primary Security Service must be up and running at this point.***
- ***You need to know the password for the nortel account on the Primary Security Service server. Installation fails if you do not know this password.***

- 11 The **Primary Security Service fingerprint** screen appears as shown in [Figure 68 "Primary Security Service fingerprint window" \(page 79\)](#). Type **Yes** to verify the Primary Security Service fingerprint.

**Figure 68**  
**Primary Security Service fingerprint window**

```

*****
Please verify the fingerprint of the Primary Security Service server:
64:b3:97:a6:2d:71:39:4e:21:18:77:e3:a7:53:d3:bf

Do you want to trust the above fingerprint? (yes/no)
yes
Setup of SSH Trust was successful.

```

- 12** The nortel password screen appears. Type the password of the nortel account and press **Enter**. The connection to the Primary Security Service server is complete.
- The installation takes approximately 30 minutes to complete. After the installation is complete the disk automatically ejects from the drive and a summary of the installation is shown on the screen.
- For detailed information about NRS, see *Network Routing Service Installation and Commissioning (NN43001-564)* ().

---

--End--

---

### Installing the Network Routing Service with ECM joining an existing secure network

Step	Action
1	Log on to the server using the nortel account.
2	Insert the NRS CD-ROM in the CD-ROM tray.
3	Enter the <code>appinstall</code> CLI command
4	At the prompt, enter the root account password. The system then prompts you to check the media.
5	Enter <b>Y</b> to check the media, or <b>N</b> to proceed without checking the media, and press <b>Enter</b> .
6	The Application installation screen appears, as shown in <a href="#">Figure 69 "Application Installation window" (page 80)</a> . From the Application installation window, select <b>3</b> to install the Network Routing Service with ECM joining an existing secure network. The appropriate packages are installed to the hard drive.

**Figure 69**  
**Application Installation window**

```
#####
#                               Installation stage                               #
#####

Nortel Enterprise Common Manager (ECM)
Network Routing Service (NRS) installation
This server will function as:
1. The Primary ECM Server (install NRS and the primary ECM security service)
2. A Backup ECM Server (install NRS and a backup ECM security service)
3. A Member Server (install NRS with ECM joining an existing secure network)
Please select the supported configuration # to install (q for exit):
```

- 7 The Solid server configuration window appears, as shown in [Figure 70 "Solid server configuration window" \(page 80\)](#). In the Solid server configuration screen, type the number of the Solid server to install.

**Figure 70**  
**Solid server configuration window**

```
Please select the type of Solid server to run

1 - Stand alone Solid database server
2 - Hotstandby Primary Solid database server
3 - Hotstandby Secondary Solid database server

Enter selection: █
```

- Press **Enter** to continue.
- 8 The Solid server configuration confirmation screen appears. Confirm the server selection by selecting **Yes**, or return to the Solid server configuration window by selecting **No**. Press **Enter** to continue.
  - 9 The **Primary Security Service server TLAN IP address** screen appears as shown in [Figure 71 "Primary Security Service server TLAN IP address window" \(page 81\)](#). Enter the IP address of the



TLAN network interface Primary Security Service server. Type **Yes** to confirm the TLAN IP address is correct.

**Figure 71**  
Primary Security Service server TLAN IP address window

```
What is the TLAN IP address of the Primary Security Service server?
192.167.103.10

You entered 192.167.103.10 as the IP address. Is this correct (yes/no)?
Yes
```

- 10 The **Primary Security Service server Fully Qualified Domain Name (FQDN)** appears as shown in [Figure 72 "Primary Security Service server Fully Qualified Domain name window"](#) (page 81). Enter the Fully Qualified Domain name of the Primary Security Service server. Type **Yes** to confirm the FQDN is correct. For a definition of FQDN see ["FQDN requirements, page 30"](#) (page 36) .

**Figure 72**  
Primary Security Service server Fully Qualified Domain name window

```
Please enter the Fully Qualified Domain name of Primary Security Service Server
cs1000em.quantum1.com

You entered cs1000em.quantum1.com as the FQDN. Is this correct (yes/no)?
Yes
```

**Note:**

- **The Primary Security Service must be up and running at this point.**
- **You need to know the password for the nortel account on the Primary Security Service server. Installation will fail if you do not know this password.**

- 11 The **Primary Security Service fingerprint** screen appears as shown in [Figure 73 "Primary Security Service fingerprint window"](#) (page 82). Type **Yes** to verify the Primary Security Service fingerprint.

**Figure 73**  
**Primary Security Service fingerprint window**

```
*****  
Please verify the fingerprint of the Primary Security Service server:  
64:b3:97:a6:2d:71:39:4e:21:18:77:e3:a7:53:d3:bf  
  
Do you want to trust the above fingerprint? (yes/no)  
yes  
Setup of SSH Trust was successful.
```

- 12** The nortel password screen appears. Type the password of the nortel account and press **Enter**. The connection to the Primary Security Service server is complete.
- The installation takes approximately 30 minutes to complete. After the installation is complete the disk automatically ejects from the drive and a summary of the installation is shown on the screen.
- For detailed information about NRS, see *Network Routing Service Installation and Commissioning (NN43001-564)* () .

---

--End--

---

### **Install the Element Manager applications**

Use this procedure to run the application DVD after the reboot is complete for the Linux base install.

#### **Installing the Primary Security Service and Element Manager**

<b>Step</b>	<b>Action</b>
1	Log on to the server using the nortel account.
2	Insert the MGMT DVD in the DVD tray.
3	Enter the <code>appinstall</code> CLI command.
4	At the prompt, enter the root account password. The system then prompts you to check the media.
5	Enter <b>Y</b> to check the media, or <b>N</b> to proceed without checking the media, and press <b>Enter</b> .
6	The Application Installation screen appears, as shown in <a href="#">Figure 74 "Application Installation window" (page 83)</a> . From the Application installation window select <b>1</b> to install the Primary Security Service with Element Manager. The appropriate packages are installed to the hard drive.

**Figure 74**  
Application Installation window

```

=====
4                               Installation steps                               4
=====
Nortel CS1000 Linux Command Manager (1000)
CS1000 Subscriber Manager (EM) Installation
This screen will install the following:
1. The Primary EON Server (install EM and the primary EON security services) 5.20.15
2. A Backup EON Server (install EM and a backup EON security services) 5.20.15
3. A Manager Server (install EM with EON loading an existing secure network) 5.20.15
4. The Primary IEM Server (install IM, Subscriber Manager and the primary IEM security services) 5.20.15
5. A Backup EON Server (install EM, Subscriber Manager and a backup EON security services) 5.20.15
Please select the supported configuration # to install. (q for help):

```

- 7 The Solid server configuration window appears, as shown in [Figure 75 "Solid server configuration window"](#) (page 83). In the Solid server configuration screen, type the number of the Solid server to install.

**Figure 75**  
Solid server configuration window

```

Please select the type of Solid server to run

1 - Stand alone Solid database server
2 - Hotstandby Primary Solid database server
3 - Hotstandby Secondary Solid database server

Enter selection:

```

Press **Enter** to continue.

- 8 The Solid server configuration confirmation screen appears. Type **Yes** to confirm the Solid server selection, or type **No** to return to the Solid server configuration window. Press **Enter** to continue.
- 9 The Private CA certificate window appears as shown in [Figure 76 "Private CA certificate window"](#) (page 84). Press **Enter** to display the prompts for Country, State or Province, Location, Organization Name and Organization Unit. Type the response for each of these categories and press **Enter** to continue.

Figure 76  
Private CA certificate window

```
*****
Information for the Private CA Certificate

The following information is required and can not be omitted.

Country (2-letter code)
State or Province (full name)
Locality (usually city)
Organization Name
Organization Unit (division)

Note: The 'Common Name' information will be filled in automatically by
using your server's FQDN.

Press Enter to proceed.
*****
```

- 10 The Private CA Certificate confirmation window appears as shown in [Figure 77 "Private CA Certificate confirmation window" \(page 84\)](#). Verify that the common name information is correct. Type **Yes** if correct or **No** if incorrect, and press **Enter**. If you enter yes, the installation finishes and the system creates the CA certificate, as shown in [Figure 62 "Making a Private CA certificate window" \(page 75\)](#). If you enter no, edit the information as required and repeat the step.

Figure 77  
Private CA Certificate confirmation window

```
Please confirm the Distinguished Name information:

Country (2-letter code):          CA
Country Full Name:               CANADA
State or Province (full name):   New Brunswick
Locality (usually city):        Saint John
Organization Name:               Innovatia
Organization Unit (division):    T5 Lab
Common Name (your server's FQDN): cs1000em.quantum1.com

Is the information correct (yes/no)?
yes
```

**Figure 78**  
**Making a Private CA certificate window**

```
Making CA certificate ...  
  
Creating a certificate for Web SSL ...  
Done creating a certificate for Web SSL.  
  
The fingerprint of the Certificate-Authority machine is as follows:  
  
2c:77:39:5f:63:90:f9:2c:8f:85:af:fd:f2:2e:d9:b7  
  
You will need to confirm the fingerprint when you install another server that  
does not have a private CA. The fingerprint can also be viewed on the  
Certificates configuration page of the web interface.
```

- 11 The Security services administrator default password screen appears, as shown in [Figure 79 "Security services administrator default password window"](#) (page 86). Enter a new default password for the security services administrator accounts, and then re-enter the new password.

**Figure 79**  
**Security services administrator default password window**

```
Change the default password of security-services administrator
accounts in ECM. The new password must follow current policies. It
must have at least one upper case character, one lower case charac-
ter, one numeric character and one special character. The minimum
number of characters in the new password is twelve. Valid charac-
ters in the password are a-zA-Z0-9{|() ,/.[^~_@!` ;
```

```
Enter a new password that will be used for all accounts.
```

```
Enter "new" password: *****
```

```
Re-enter the new password
```

```
Enter "the new" password: *****
```

```
Passwords match.
```

```
NOTE: Changing passwords. This may take a few minutes ...
```

```
NOTE: Password changes succeeded.
```

---

--End--

---

The installation takes approximately 30 minutes to complete. After the installation is complete the disk automatically ejects from the drive and a summary of the installation is shown on the screen.

For detailed information about Element Manager see *Element Manager System Reference—Administration (NN43001-632) ()*.

### Installing the Backup Security Service and Element Manager

Step	Action
1	Log on to the server using the nortel account.
2	Insert the MGMT DVD in the DVD tray.
3	Enter the <code>appinstall</code> CLI command.
4	At the prompt, enter the root account password. The system then prompts you to check the media.
5	Enter <b>Y</b> to check the media, or <b>N</b> to proceed without checking the media, and press <b>Enter</b> .

- 6 The Application Installation screen appears, as shown in [Figure 74 "Application Installation window" \(page 83\)](#). From the Application installation window select **2** to install the Backup Security Service with Element Manager. The appropriate packages are installed to the hard drive.

**Figure 80**  
Application Installation window

```

#####
4          Installation step          4
#####
Nortel CS1000 Element Manager (EM)
CS1000 Element Manager (EM) installation
This screen will install the following:
1. The Primary EM Server (install EM and the primary EM security services) 5.29.15
2. A Backup EM Server (install EM and a backup EM security services) 5.29.15
3. A Neighbor Server (install EM with EM loading on existing secure network) 5.29.15
4. The Primary EM Server (install EM, Subscriber Manager and the primary EM security services) 5.29.15
5. A Backup EM Server (install EM, Subscriber Manager and a backup EM security services) 5.29.15
Please select the supported configuration # to install. (q for help):

```

- 7 The Solid server configuration window appears, as shown in [Figure 81 "Solid server configuration window" \(page 87\)](#). In the Solid server configuration screen, type the number of the Solid server to install.

**Figure 81**  
Solid server configuration window

```

Please select the type of Solid server to run

1 - Stand alone Solid database server
2 - Hotstandby Primary Solid database server
3 - Hotstandby Secondary Solid database server

Enter selection:

```

Press **Enter** to continue.

- 8 The Solid server configuration confirmation screen appears. Type **Yes** to confirm the Solid server selection, or type **No** to return to the Solid server configuration window. Press **Enter** to continue.
- 9 The Primary Security Service server TLAN IP address screen appears as shown in [Figure 82 "Primary Security Service server TLAN IP address window" \(page 88\)](#). Enter the IP address of the TLAN network interface Primary Security Service server. Type **Yes** to confirm the TLAN IP address is correct or type **No**

to return to the Primary Security Service server TLAN IP address screen. Press **Enter** to continue.

**Figure 82**  
**Primary Security Service server TLAN IP address window**

```
What is the TLAN IP address of the Primary Security Service server?
192.167.103.10

You entered 192.167.103.10 as the IP address. Is this correct (yes/no)?
Yes
```

- 10 The Primary Security Service server Fully Qualified Domain Name (FQDN) screen appears as shown in [Figure 83 "Primary Security Service server Fully Qualified Domain name window" \(page 88\)](#). Enter the Fully Qualified Domain name of the Primary Security Service server. Type **Yes** to confirm the FQDN is correct or type **No** to return to the Primary Security Service server Fully Qualified Domain Name screen. For a definition of FQDN see ["FQDN requirements, page 30" \(page 36\)](#) . Press **Enter** to continue.

**Figure 83**  
**Primary Security Service server Fully Qualified Domain name window**

```
Please enter the Fully Qualified Domain name of Primary Security Service Server
cs1000em.quantum1.com

You entered cs1000em.quantum1.com as the FQDN. Is this correct (yes/no)?
Yes
```

**Note:**

- ***The Primary Security Service must be up and running at this point.***
- ***You need to know the password for the nortel account on the Primary Security Service server. Installation fails if you do not know this password.***

- 11 The Primary Security Service fingerprint screen appears as shown in [Figure 84 "Primary Security Service fingerprint window" \(page 89\)](#). Type **Yes** to verify the Primary Security Service fingerprint.



**Figure 84**  
Primary Security Service fingerprint window

```

*****
Please verify the fingerprint of the Primary Security Service server:
64:b3:97:a6:2d:71:39:4e:21:18:77:e3:a7:53:d3:bf

Do you want to trust the above fingerprint? (yes/no)
yes
Setup of SSH Trust was successful.

```

- 12** The nortel password screen appears. Type the password of the nortel account and press **Enter**. The connection to the Primary Security Service server is complete and the installation finishes.
- The installation takes approximately 30 minutes to complete. After the installation is complete the disk automatically ejects from the drive and a summary of the installation is shown on the screen.

For detailed information about Element Manager see *Element Manager System Reference—Administration (NN43001-632)* ().

---

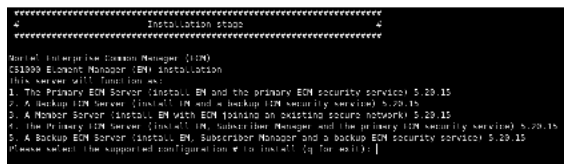
--End--

---

#### Installing the Element Manager joining an existing secure network

Step	Action
1	Log on to the server using the nortel account.
2	Insert the MGMT DVD in the DVD tray.
3	Enter the <code>appinstall</code> CLI command.
4	At the prompt, enter the root account password. The system then prompts you to check the media.
5	Enter <b>Y</b> to check the media, or <b>N</b> to proceed without checking the media, and press <b>Enter</b> .
6	The Application Installation screen appears, as shown in <a href="#">Figure 85 "Application Installation window" (page 90)</a> From the Application installation window select <b>3</b> to install the Element Manager joining an existing secure network. The appropriate packages are installed to the hard drive.

**Figure 85**  
Application Installation window



- 7 The Solid server configuration window appears, as shown in [Figure 86 "Solid server configuration window" \(page 90\)](#). In the Solid server configuration screen, type the number of the Solid server to install.

**Figure 86**  
Solid server configuration window



Press **Enter** to continue.

- 8 The Solid server configuration confirmation screen appears. Type **Yes** to confirm the Solid server selection, or type **No** to return to the Solid server configuration window. Press **Enter** to continue.
- 9 The Primary Security Service server TLAN IP address screen appears as shown in [Figure 87 "Primary Security Service server TLAN IP address window" \(page 91\)](#). Enter the IP address of the TLAN network interface Primary Security Service server. Type **Yes** to confirm the TLAN IP address is correct or type **No** to return to the Primary Security Service server TLAN IP address screen. Press **Enter** to continue.

**Figure 87**  
**Primary Security Service server TLAN IP address window**

```

What is the TLAN IP address of the Primary Security Service server?
192.167.103.10

You entered 192.167.103.10 as the IP address. Is this correct (yes/no)?
Yes

```

- 10 The Primary Security Service server Fully Qualified Domain Name (FQDN) screen appears as shown in [Figure 88 "Primary Security Service server Fully Qualified Domain name window" \(page 91\)](#). Enter the Fully Qualified Domain name of the Primary Security Service server. Type **Yes** to confirm the FQDN is correct or type **No** to return to the Primary Security Service server Fully Qualified Domain Name screen. For a definition of FQDN see ["FQDN requirements, page 30" \(page 36\)](#). Press **Enter** to continue.

**Figure 88**  
**Primary Security Service server Fully Qualified Domain name window**

```

Please enter the Fully Qualified Domain name of Primary Security Service Server
cs1000em.quantum1.com

You entered cs1000em.quantum1.com as the FQDN. Is this correct (yes/no)?
Yes

```

**Note:**

- ***The Primary Security Service must be up and running at this point.***
  - ***You need to know the password for the nortel account on the Primary Security Service server. Installation fails if you do not know this password.***
- 11 The Primary Security Service fingerprint screen appears as shown in [Figure 89 "Primary Security Service fingerprint window" \(page 92\)](#). Type **Yes** to verify the Primary Security Service fingerprint.

**Figure 89**  
**Primary Security Service fingerprint window**

```
*****
Please verify the fingerprint of the Primary Security Service server:
64:b3:97:a6:2d:71:39:4e:21:18:77:e3:a7:53:d3:bf

Do you want to trust the above fingerprint? (yes/no)
yes
Setup of SSH Trust was successful.
```

- 12** The nortel password screen appears. Type the password of the nortel account and press **Enter**. The connection to the Primary Security Service server is complete and the installation finishes.
- The installation takes approximately 30 minutes to complete. After the installation is complete the disk automatically ejects from the drive and a summary of the installation is shown on the screen.

For detailed information about Element Manager see *Element Manager System Reference—Administration (NN43001-632)* ().

---

--End--

---

### Installing the Primary Security Service, Subscriber Manager, and Element Manager

Step	Action
1	Log on to the server using the nortel account.
2	Insert the MGMT DVD in the DVD tray.
3	Enter the <code>appinstall</code> CLI command.
4	At the prompt, enter the root account password. The system then prompts you to check the media.
5	Enter <b>Y</b> to check the media, or <b>N</b> to proceed without checking the media, and press <b>Enter</b> .
6	The Application Installation screen appears, as shown in <a href="#">Figure 90 "Application Installation window"</a> (page 93). From the Application installation window select <b>4</b> to install the Primary Security Service with Subscriber Manager and Element Manager. The appropriate packages are installed to the hard drive.

**Figure 90**  
Application Installation window

```

=====
4                               4
=====
Nortel CS1000 Installation Manager (100%)
CS1000 Element Manager (EM) Installation
This screen will install the following:
1. The Primary EON Server (install EM and the primary EON security services) 5.20.15
2. A Backup EON Server (install EM and a backup EON security services) 5.20.15
3. A Manager Server (install EM with EON loading an existing secure network) 5.20.15
4. The Primary IEM Server (install EM, Subscriber Manager and the primary IEM security services) 5.20.15
5. A Backup EON Server (install EM, Subscriber Manager and a backup EON security services) 5.20.15
Please select the supported configuration # to install. (q for help):

```

- 7 The Solid server configuration window appears, as shown in [Figure 91 "Solid server configuration window"](#) (page 93). In the Solid server configuration screen, type the number of the Solid server to install.

**Figure 91**  
Solid server configuration window

```

Please select the type of Solid server to run

1 - Stand alone Solid database server
2 - Hotstandby Primary Solid database server
3 - Hotstandby Secondary Solid database server

Enter selection:

```

Press **Enter** to continue.

- 8 The Solid server configuration confirmation screen appears. Type **Yes** to confirm the Solid server selection, or type **No** to return to the Solid server configuration window. Press **Enter** to continue.
- 9 The Private CA certificate window appears as shown in [Figure 92 "Private CA certificate window"](#) (page 94). Press **Enter** to display the prompts for Country, State or Province, Location, Organization Name and Organization Unit. Type the response for each of these categories and press **Enter** to continue. At the prompts, enter the Country, State or Province, Location, Organization Name and Organization Unit and press **Enter** to continue.

Figure 92  
Private CA certificate window

```
*****
Information for the Private CA Certificate

The following information is required and can not be omitted.

Country (2-letter code)
State or Province (full name)
Locality (usually city)
Organization Name
Organization Unit (division)

Note: The 'Common Name' information will be filled in automatically by
using your server's FQDN.

Press Enter to proceed.
*****
```

- 10 The Private CA Certificate confirmation window appears as shown in [Figure 93 "Private CA Certificate confirmation window" \(page 94\)](#). Verify that the common name information is correct. Type **Yes** if correct or **No** if incorrect, and press **Enter**. If you entered yes, the installation finishes and the system creates the CA certificate, as shown in [Figure 94 "Making a Private CA certificate window" \(page 95\)](#). If you selected no, edit the information as required and repeat the step.

Figure 93  
Private CA Certificate confirmation window

```
Please confirm the Distinguished Name information:

Country (2-letter code):          CA
Country Full Name:              CANADA
State or Province (full name):   New Brunswick
Locality (usually city):        Saint John
Organization Name:              Innovatia
Organization Unit (division):   T5 Lab
Common Name (your server's FQDN): cs1000em.quantum1.com

Is the information correct (yes/no)?
yes
```

**Figure 94**  
**Making a Private CA certificate window**

```
Making CA certificate ...  
  
Creating a certificate for Web SSL ...  
Done creating a certificate for Web SSL.  
  
The fingerprint of the Certificate-Authority machine is as follows:  
  
2c:77:39:5f:63:90:f9:2c:8f:85:af:fd:f2:2e:d9:b7  
  
You will need to confirm the fingerprint when you install another server that  
does not have a private CA. The fingerprint can also be viewed on the  
Certificates configuration page of the web interface.
```

- 11 The Security services administrator default password screen appears, as shown in [Figure 95 "Security services administrator default password window"](#) (page 96). Enter a new default password for the security services administrator accounts, and then re-enter the new password.

**Figure 95**  
**Security services administrator default password window**

```
Change the default password of security-services administrator
accounts in ECM. The new password must follow current policies. It
must have at least one upper case character, one lower case charac-
ter, one numeric character and one special character. The minimum
number of characters in the new password is twelve. Valid charac-
ters in the password are a-zA-Z0-9{|() ,/.[^~_@!` ;
```

```
Enter a new password that will be used for all accounts.
```

```
Enter "new" password: *****
```

```
Re-enter the new password
```

```
Enter "the new" password: *****
```

```
Passwords match.
```

```
NOTE: Changing passwords. This may take a few minutes ...
```

```
NOTE: Password changes succeeded.
```

---

--End--

---

The installation takes approximately 30 minutes to complete. After the installation is complete the disk automatically ejects from the drive and a summary of the installation is shown on the screen.

For detailed information about Element Manager see *Element Manager System Reference—Administration (NN43001-632) ()* .

For detailed information about Subscriber Manager see the installation and configuration section of *Subscriber Manager Fundamentals (NN43001-120) ()* .

### Installing the Backup Security Service, Subscriber Manager, and Element Manager

Step	Action
1	Log on to the server using the nortel account.
2	Insert the MGMT DVD in the DVD tray.
3	Enter the <code>appinstall</code> CLI command.



- 4 At the prompt, enter the root account password. The system then prompts you to check the media.
- 5 Enter **Y** to check the media, or **N** to proceed without checking the media, and press **Enter**.
- 6 The Application Installation screen appears, as shown in [Figure 96 "Application Installation window" \(page 97\)](#). From the Application installation window select **5** to install the Backup Security Service with Subscriber Manager and Element Manager. The appropriate packages are installed to the hard drive.

**Figure 96**  
Application Installation window

```

=====
4      Installation stage
=====
Nortel Communication Server (1000)
CS1000 Element Manager (EM) Installation
This server will install:
1. The Primary EM Server (install EM and the primary EM security services) 5.20.15
2. A Backup EM Server (install EM and a backup EM security services) 5.20.15
3. A Manager Server (install EM with EM loading on existing secure network) 5.20.15
4. The Primary EM Server (install EM, Subscriber Manager and the primary EM security services) 5.20.15
5. A Backup EM Server (install EM, Subscriber Manager and a backup EM security services) 5.20.15
Please select the supported configuration # to install (q for exit):

```

- 7 The Solid server configuration window appears, as shown in [Figure 97 "Solid server configuration window" \(page 97\)](#). In the Solid server configuration screen, type the number of the Solid server to install.

**Figure 97**  
Solid server configuration window

```

Please select the type of Solid server to run

1 - Stand alone Solid database server
2 - Hotstandby Primary Solid database server
3 - Hotstandby Secondary Solid database server

Enter selection:

```

Press **Enter** to continue.

- 8 The Solid server configuration confirmation screen appears. Type **Yes** to confirm the Solid server selection, or type **No** to return to the Solid server configuration window. Press **Enter** to continue.

- 9 The Primary Security Service server TLAN IP address screen appears as shown in [Figure 98 "Primary Security Service server TLAN IP address window"](#) (page 98). Enter the IP address of the TLAN network interface Primary Security Service server. Type **Yes** to confirm the TLAN IP address is correct or type **No** to return to the Primary Security Service server TLAN IP address screen. Press **Enter** to continue.

**Figure 98**  
**Primary Security Service server TLAN IP address window**

```
What is the TLAN IP address of the Primary Security Service server?
192.167.103.10

You entered 192.167.103.10 as the IP address. Is this correct (yes/no)?
Yes
```

- 10 The Primary Security Service server Fully Qualified Domain Name (FQDN) screen appears as shown in [Figure 99 "Primary Security Service server Fully Qualified Domain name window"](#) (page 98). Enter the Fully Qualified Domain name of the Primary Security Service server. Type **Yes** to confirm the FQDN is correct or type **No** to return to the Primary Security Service server Fully Qualified Domain Name screen. For a definition of FQDN see ["FQDN requirements, page 30"](#) (page 36) . Press **Enter** to continue.

**Figure 99**  
**Primary Security Service server Fully Qualified Domain name window**

```
Please enter the Fully Qualified Domain name of Primary Security Service Server
cs1000em.quantum1.com

You entered cs1000em.quantum1.com as the FQDN. Is this correct (yes/no)?
Yes
```

**Note:**

- **The Primary Security Service must be up and running at this point.**
- **You need to know the password for the "nortel" account on the Primary Security Service server. Installation will fail if you do not know this password.**

- 11 The Primary Security Service fingerprint screen appears as shown in [Figure 100 "Primary Security Service fingerprint"](#)

window" (page 99). Type **Yes** to verify the Primary Security Service fingerprint.

**Figure 100**  
Primary Security Service fingerprint window

```
*****
Please verify the fingerprint of the Primary Security Service server:
64:b3:97:a6:2d:71:39:4e:21:18:77:e3:a7:53:d3:bf

Do you want to trust the above fingerprint? (yes/no)
yes
Setup of SSH Trust was successful.
```

- 12** The nortel password screen appears. Type the password of the nortel account and press **Enter**. The connection to the Primary Security Service server is complete and the installation finishes.

The installation takes approximately 30 minutes to complete. After the installation is complete the disk automatically ejects from the drive and a summary of the installation is shown on the screen.

For detailed information about Element Manager see *Element Manager System Reference—Administration (NN43001-632)* ().

For detailed information about Subscriber Manager see the installation and configuration section of *Subscriber Manager Fundamentals (NN43001-120)* ().

---

--End--

---

### Configuration for Network Routing Service or Element Manager applications in ECM

The Network Routing Service or Element Manager applications must be configured in ECM after installation is complete. For details about configuration and security certificate creation see *Security Management Fundamentals (NN43001-604)* ().



---

# CS 1000 on Linux base

---

## Linux Operating System and Distribution

The selected distribution is Red Hat Enterprise Linux ES 4. This distribution is built on a 2.6 kernel, and supports many Open Source Development Lab (OSDL) Carrier Grade Linux (CGL) features.

Red Hat Enterprise Linux ES 4 supports Linux kernel version 2.6 and the following for the Enterprise Common Manager (ECM) and the Network Routing Service (NRS) :

- Secure Internet Protocol (IPSec)
- Sun JVM 1.4.x
- Radvision Session Initiation Protocol (SIP) stack
- OpenSSL
- OpenSSH
- Perl
- Zlib
- (S)FTP server
- SNMPv3
- A Web application server with support for the following technologies :
  - HTTP Server (HTML, CGI)
  - Web Container (Servlet, JSP, JSF)
  - J2EE Container (EJB)
  - Portal Container (Portlet)
  - Web Services Simple Object Access Protocol (SOAP) (for example, JBoss with appropriate optional packages)

## Network and firewall

All applications operate behind a network firewall. The firewall starts on system boot, which invokes the Linux iptables facility to load the firewall configuration.

Each Linux server supports at least two Ethernet ports; one for ELAN subnet connectivity and another for TLAN subnet connectivity. By default, the TLAN is open to the network, while the ELAN is reachable only within the subnet. The Linux application selects the Ethernet port to use. The firewall protects both ports. For a listing of Linux base open firewall ports see [Table 1 "Linux base open firewall ports" \(page 102\)](#). For a definition of ELAN and TLAN see ["Network configuration" \(page 143\)](#).

Use the CLI command `basefirewallconfig` to configure the network firewall. For a list of Nortel Linux base CLI commands see ["Nortel Linux base CLI commands" \(page 139\)](#).

**Table 1**  
**Linux base open firewall ports**

Protocol	Port number or range
TCP	22
UDP	22
UDP	53 (to DNS servers only)
UDP	123
UDP	500
UDP	514
TCP	2100
UDP	33434-33524

**Note:** The port numbers found in [Table 1 "Linux base open firewall ports" \(page 102\)](#) apply only to the Linux base. Linux applications can require different ports. For a list of ports opened for the application see the appropriate application NTP .

## Software reliability

### Software monitoring

MONIT is an open source package used for monitoring the important daemon services automatically initiated at startup. If a malfunction occurs, MONIT provides actions such as alert, start, stop, and restart. To provide these actions, applications must be registered with MONIT, and the appropriate actions for each application must be specified.

The following system parameters are monitored: memory, CPU, and device space usage. If usage of one of them passes a warning threshold then a message is displayed. The warning and critical thresholds are shown in [Table 2 "Warning and Critical thresholds" \(page 103\)](#).

**Table 2**  
**Warning and Critical thresholds**

System Resource	Warning Clear	Warning Set	Critical Clear	Critical Set
Memory usage	-	-	90%	95%
CPU usage	-	-	90%	95%
/boot (/dev/sda1) Size: 100 MB. Critical.	70%	75%	80%	85%
admin (/dev/sda2) Size: 4 GB.	80%	85%	85%	90%
/ (/dev/sda6) Size: 4 GB.	80%	85%	85%	90%
/opt (/dev/sda7) Size: 8 GB. Not critical.	80%	85%	90%	95%
/home (/dev/sda8) ) Size: 4 GB. Not critical.	80%	85%	90%	95%
/tmp (/dev/sda9) Size: 20 GB. Critical.	80%	85%	85%	90%
/var (/dev/sda10) Size: 30 GB. Critical.	80%	85%	85%	90%

An example of a Critical Set alarm is shown at [Figure 101 "Critical Set alarm example" \(page 104\)](#). An example of a Critical Clear alarm message is shown at [Figure 102 "Critical Clear alarm example" \(page 104\)](#).

**Note:** If critical alarms persist, contact your Nortel technical support.

**Figure 101**  
**Critical Set alarm example**

```
Message from syslogd@ibm2-t at Wed Oct 17 14:23:22 2007 ...
ibm2-t Base: EMERG: alarm(788): CRITICAL SET: CPU utilization has
passed the 95% utilization threshold.
```

**Figure 102**  
**Critical Clear alarm example**

```
Message from syslogd@ibm2-t at Wed Oct 17 14:33:26 2007 ...
ibm2-t Base: EMERG: alarm(788): CRITICAL CLEAR: CPU utilization has
dropped below the 90% utilization threshold.
```

### Hardware watchdog

The IBM x306m and HP DL320 G4 servers offer a hardware watchdog. The watchdog timer is programmed during the server startup and requires continuous resets from a daemon running in Linux. The watchdog timer is based on the current ISP1100 server, which is 5 minutes.

The server is reset if the watchdog timer is not reset within the allotted time. The operating system and applications are reloaded from disk and started after the server reset occurs. The following conditions can trigger the watchdog:

- The software daemon, which notifies hardware watchdog, fails to respond.
- A hardware or software problem causes the system to freeze.

## Linux Security Hardening

The following features enhance Linux base security.

### Virus protection

If antivirus software is installed by the customer the following is recommended:

- Antivirus software that uses 100 megabytes (MB) or less of hard drive space.
- Choose software that uses 84 MB or less of RAM.
- Always set the process priority to low.
- Perform virus scans during off-hours only.



- Choose software you use to remove or clean the viruses, as well as send warning messages.
- Choose software that uses a maximum of 10% of CPU for a scheduled scan and 3% for an active scan.

### BIOS setting and password protection

To secure the server, Nortel recommends the following:

- Disable boot from CD or DVD drive in the Basic Input Output System (BIOS).
- Add a BIOS password. For information about adding a BIOS password to the HP DL320 G4 server see [“Setting the HP DL320 G4 server BIOS password” \(page 130\)](#). For information about adding a BIOS password to the IBM x306m server see [“Setting the IBM x306m server BIOS password” \(page 136\)](#).
- Add a boot loader password.

### Removal of the Ctrl+Atl+Del keyboard shutdown command

The Ctrl+Alt+Del shutdown command is disabled.

### Single-user-text-mode booting is disabled

This booting mode is disabled to prevent the unauthorized access of the system.

### Hardened communications by using secure protocols

Secure Shell (SSH) and its accompanying tools are included by default. The secure protocols are also a replacement for some insecure protocols, as shown in [Table 3 "Security communication protocols" \(page 105\)](#).

**Table 3**  
**Security communication protocols**

Insecure protocols (disabled)	Replacement secure protocols (supported)
telnet	ssh
rsh	ssh
rlogin	ssh
tftp	sftp
ftp	sftp
rcp	scp

**Note 1:** To establish a connection using SSH or SFTP you need to have a valid server address, and you must connect through port 22.

**Note 2:** If SFTP or SCP is not available, File Transfer Protocol (FTP) can be used. Invoke the CLI command `ftpenable` to access FTP; and invoke the CLI command `ftpdisable` to close FTP. The `ftpenable` command opens a timed window that closes after 5 minutes of inactivity. The patch folder is the only folder that is visible if FTP is chosen.

## Patching

Linux base supports two patch categories:

- **Patch:** This category of patch changes program behavior for a period of time. You can use it for such things as fixing bugs or for diagnostic purposes. In some instances, you can apply this category of patch without a program restart.
- **Service Update:** A service update (SU) is a cumulative update of patches. A service update is a full application Red Hat Package Manager (RPM) package distribution that contains all patches that you apply to a specific application, and replaces previous service updates.

An overview of the patching operation is provided in ["Patching Operation" \(page 106\)](#).

### Patching Operation

Step	Action
1	Log in using the <b>nortel</b> account.
2	Once you are logged in, enter the CLI command <code>swVersionShow</code> and press <b>Enter</b> . This displays the installed applications and the application version numbers, as shown in <a href="#">Figure 103 "Installed applications and version numbers" (page 107)</a> .

**Figure 103**  
Installed applications and version numbers

```
[nortel@cs1000em2 ~]$ [nortel@cs1000em2 ~]$ swVersionShow
Configuration version: 5.50.02
privateCA                5.50.02
Jboss-Quantum            5.50.02
cs1000WebService_5-5    5.50.02
bccPhonesMigration      5.50.02
submgr_1-0              5.50.02
sunAm                   5.50.02
Snmp-Daemon-TrapLib    5.50.02
emWeb_5-5              5.50.02
ftrpkg                 5.50.02
nortel-cs1000-linuxbase 5.50.02
bcc                    5.50.02
bcc_5-5                5.50.02
solid                  5.50.02
emWeb                 5.50.02
muleESB               5.50.02
isclient              5.50.02
```

**Note:** Figure 103 "Installed applications and version numbers" (page 107) contains the base or application name in the left column and the corresponding version number in the right column. Make note of the version number for the base or application that you are patching. You must use the correct version number to retrieve the correct patch or service update from the Nortel Enterprise Solutions Product Enhancement Package (PEP) Library (ESPL).

- 3 Retrieve a patch or an SU file from the ESPL.
- 4 Upload the patch file to the Linux server and save it in the /var/opt/nortel/patch directory.

Secure File Transfer Protocol (SFTP) and Secure Copy (SCP) are the supported methods of patch file transfer.

Patch file transfer is initiated from within the Linux server or from an external machine.

- To initiate the patch file transfer from within the Linux server:
  - logon to the Linux server as nortel.
  - Enter the `sftp` or `scp` CLI command.
  - Type the `get` command (for `sftp`) or the `scopy` command (for `scp`) to transfer the patch to the Linux server.
- To initiate the patch file transfer from an external machine:

- Initiate an SFTP or Secure Shell (SSH) program.
- Provide the Linux server's IP address (or host name), the nortel user ID, and password as parameters.
- Type the `put` command (for `sftp`) or the `scopy` command (for `scp`) to transfer the patch to the Linux server.

**Note:** If you cannot access SFTP or SCP, File Transfer Protocol (FTP) can be used. FTP can be accessed by invoking the CLI command `ftpenable`, and closed by invoking the CLI command `ftpdisable`. The `ftpenable` command opens a timed window that closes after 5 minutes of inactivity.

**5** Perform one or more of the following on-target patch management CLI commands:

- `pload`
- `pins`
- `poos`
- `pout`
- `pstat`

---

--End--

---

### Target patcher CLI commands

The on-target patch management CLI provides an interface command set similar to the CS 1000 patcher. [Table 4 "Target-side patching CLI commands" \(page 108\)](#) lists target-side patching CLI commands.

**Table 4**  
Target-side patching CLI commands

Command	Description
<code>pload</code>	Load a patch from a disk file and update the on-switch database with the specific patch information.
<code>pins</code>	Put a patch into service; the patch will be placed into service for all processes to which it applies.
<code>poos</code>	Remove a patch from service. The patch is removed from service from all processes in which it was in service.
<code>pout</code>	Unload a patch that was loaded with the <code>pload</code> command.

<code>pstat</code>	Print a status summary of all loaded patches.
<code>plis</code>	Print detailed information about a specific patch.

**Note:** The `nortel` user account is the designated user account for the execution of these CLI commands.

### Patch retention

A patch is always retained until the `poos` CLI command explicitly puts the patch out of service.

**Note:** In some cases you cannot remove a patch (the `poos` CLI command fails).

## Software exceptions

### Linux kernel exceptions

If the Linux kernel encounters an unrecoverable error, it prints and logs a short description of the problem, and can produce an undefined result. Typical causes of such errors are unrecoverable hardware errors or bugs in the kernel software.

A nonfatal kernel exception is reported through a log in the kernel, and captured in the `syslog`. Kernel logs, due to invalid memory addresses, do not normally result in a kernel panic (crash); instead the process that triggers the fault terminates. These can produce a lasting negative impact on the system. It is recommended that such events be monitored in user space (using the `syslog` mechanism), and that a full system reboot be triggered after receipt of a kernel log report.

## User accounts and access control

User accounts and access control methods are managed by native Linux user account management, and tools such as `Radius` and `PAM`. There is a diagnostic group and some default diagnostic users for debugging and maintenance purposes.

Linux base includes the following accounts:

- `root` (as Linux default)

**Note 1:** Logging in as `root` is strongly discouraged unless you are explicitly directed to do so. All of the base maintenance and debug actions must be performed using the `nortel` or `sysadmin` accounts.

**Note 2:** To log in directly as root you must log in through the COM1 console.

- **sysadmin:** The user account designated for debugging and maintenance. This account is intended for Nortel support.
- **nortel:** The user account for the basic Linux base operation, including patching and application installation. For a list of CLI commands that can be invoked by nortel, see “[Nortel Linux base CLI commands](#)” (page 139).

**Note 1:** If you log in as root or nortel and your account is inactive for 15 minutes, you will automatically be logged out.

**Note 2:** A nortel or sysadmin user account (except root) that makes three successive incorrect logon attempts will be locked for up to 1 hour.

## Passwords

The following regulations govern the use of passwords:

### Password Policy

- System-level passwords (for example, application administration account passwords) expire after three months.
- A new password must differ from the previous three passwords.

### Password creation guidelines

Passwords must meet the following criteria:

- Passwords must contain both uppercase and lowercase letters.
- In addition to letters, passwords must use numeric digits (0 to 9) and special characters (!@#\$%^&\*()\_+|~-=\‘{}[]:”’&;<>?,./).
- The password must contain at least eight alphanumeric characters.
- The password cannot be a word in the English language as defined in the Linux Pluggable Authentication Module (PAM) module.
- Passwords cannot use discernible character patterns such as abcdef or 123123.
- Passwords cannot use the backward spelling of a word.
- Passwords cannot be an English language word (as defined in the Linux PAM module) preceded or followed by a digit. For example, 1secret or secret1.
- You can change your password by using the `passwd` CLI command.

## Resetting Nortel Linux base passwords

Nortel Linux base passwords can be reset if they are forgotten or lost. Use the following procedures to reset Nortel Linux base passwords.

### Resetting the Nortel Linux base root password

#### ATTENTION

Use this procedure to reset the local Nortel Linux base root password only.

You must have physical access to the system to use this procedure. You must have a keyboard, video monitor, and mouse (kvm) connection to use this procedure.

Step	Action
1	Insert the Linux base CD in the CD-ROM tray.
2	Reboot the system.
3	Type <b>kvm</b> at the boot prompt and press <b>Enter</b> to begin the installation, as shown in <a href="#">Figure 104 "CS 1000 Linux base system installer"</a> (page 111).

**Figure 104**  
CS 1000 Linux base system installer

```

System Release:      nortel-cs1000-linuxbase-4.91-30.00
Build Timestamp:    Thu Nov 23 20:26:33 EST 2006

Welcome to the CS 1000 Linux Base System Installer

- To install via a serial console on COM1, type com1 <ENTER>.
  All input and output will be directed to the COM1 serial port. The system
  console will be permanently installed on COM1.

- To install via an attached keyboard/monitor/mouse, type kvm <ENTER>. All
  input and output will be directed to the attached keyboard/monitor/mouse.
  During installation, you will be given the opportunity to permanently
  install the system console on a user specified serial port. If you choose
  not to, the system console will be permanently installed on the attached
  keyboard/monitor/mouse.

***The default is --- com1***.

boot: _

```

- 4 The Installation of new Linux base operating system screen appears, as shown in [Figure 105 "Installation of new Linux base operating system"](#) (page 112). When the Installation of new Linux base operating system screen appears press **(Alt+F2)** to switch to a shell virtual console.

**Figure 105**  
**Installation of new Linux base operating system**

```
#####  
#####  
  
      Installation of New Linux base Operating System  
  
Existing Linux base release:  
  System Release:      nortel-cs1000-linuxbase-5.00-40.00  
  Build Timestamp:    Fri May 18 22:53:48 EDT 2007  
  
New Linux base release:  
  System Release:      nortel-cs1000-linuxbase-5.25.04.00  
  Build Timestamp:    Wed Oct  3 09:59:25 MSD 2007  
  
#####  
#####  
  
Do you wish to proceed with installation (Y/N) [Y]?
```

- 5 Type `cd/tmp/` and press **Enter** to change the path to the tmp directory.
- 6 Type `mkdir mount` and press **Enter** to create a new directory.
- 7 Type `mount /dev/sda6 mount/` and press **Enter** to mount the system image.
- 8 Type `chroot /tmp/mount` and press **Enter**.
- 9 Type `passwd -f (user)` and press **Enter**. The Root password reset window appears, as shown in [Figure 106 "Root password reset window"](#) (page 113).



**Figure 106**  
**Root password reset window**

```
sh-3.00# passwd -f root
Changing password for user root.
You can now choose the new password.

A valid password should be a mix of upper and lower case letters,
digits, and other characters. You can use an 8 character long
password with characters from at least 3 of these 4 classes.

An upper case letter that begins the password and a digit that
ends it do not count towards the number of character classes used.

Enter new password:
Re-type new password:
passwd: System error
```

- 10 In the [Figure 106 "Root password reset window" \(page 113\)](#) type the new password and press **Enter**. You are then prompted to enter the password again. Type the password again and press **Enter**. If you typed the passwords correctly the message System error appears. If the passwords do not match the system prompts you to repeat the process.

**Note:** After you correctly enter the new password the screen displays passwd: System error. Ignore the system error; the password change is successful.

- 11 When you finish the password reset press **Ctrl+Alt+Delete** to reboot the server.
- 12 When the system startup begins push the eject button on the CD-ROM to manually eject the Linux base CD from the CD-ROM tray.

---

--End--

---

### Resetting Nortel Linux base non-root passwords

---

Nortel Communication Server 1000  
Linux Platform Base and Applications Installation and Commissioning  
NN43001-315 02.09  
29 October 2008

**ATTENTION**

Use this procedure to reset local Nortel Linux base non-root passwords only.  
You must have a serial connection to the system to use this procedure.

Step	Action
1	Open the serial connection and logon as root.
2	Type the CLI command <code>passwd (user)</code> and press <b>Enter</b> . The Non-root password reset screen appears, as shown in <a href="#">Figure 107 "Non-root password reset window"</a> (page 114).

**Figure 107****Non-root password reset window**

```
[root@kushalag-hp1 ~]# passwd nortel
Changing password for user nortel.

You can now choose the new password.

A valid password should be a mix of upper and lower case letters,
digits, and other characters. You can use an 8 character long
password with characters from at least 3 of these 4 classes.
An upper case letter that begins the password and a digit that
ends it do not count towards the number of character classes used.

Enter new password:
Re-type new password:
passwd: all authentication tokens updated successfully
```

- 3 In the [Figure 107 "Non-root password reset window"](#) (page 114) type the new password and press **Enter**. You are then prompted to enter the password again. Type the password again and press **Enter**. If the passwords match the message all authentication tokens updated successfully is displayed. If the passwords do not match the system prompts you to repeat the process.
- 4 When you finish the password reset type `logout` and press **Enter** to log out of the root account.

---

--End--

---

## System upgrades

The platform supports upgrades for the delivery of new interim releases. The installation or reinstallation provides the option to preserve the customer installation parameters for upgrade purposes. You can upgrade the complete platform including the operating system and Linux base applications.

Nortel Linux base uses the CLI `upgrade` command to reinstall or upgrade the base installation. Insert the Linux base installation CD is and invoke the `upgrade` command. You can choose to back up the data to a USB device, to an SFTP server, or type `q` to exit the upgrade operation. For more information about SFTP data back up, see [“Network configuration for Secure File Transfer Protocol \(SFTP\) data backup” \(page 143\)](#) At the beginning of reinstallation you can use the data stored in the USB device or the SFTP server. After the base installation is complete, you can invoke the `appinstall` command to install applications from the application CD or DVD .

The following application data is backed up during the Linux upgrade process and is restorable when the applications are reinstalled:

- Enterprise Common Manager data
- Subscriber Manager security certificates and CND connection details
- Element Manager data

**Note:** You must logon as nortel to run the installation or upgrade process.

## Logging

Linux base supports syslog as the standard event logger. Application-specific event logs are stored in directories created by the application. See the application’s documentation for more information.

## SNMP

Linux base supports standard server type Management Information Base (MIB) II MIBs. Linux base does not generate SNMP alarms. For information about the configuration of SNMP on Linux base see *Communication Server 1000 Fault Management — SNMP (NN43001-719)* (). For information about Enterprise Common Manager (ECM) and SNMP on Linux base see *Enterprise Common Manager Fundamentals*

(NN43001-116) (). For information about Network Routing Service (NRS) and SNMP on Linux base see *Network Routing Service Installation and Commissioning (NN43001-564)* ().

## Disaster recovery

Hardware faults can occur that require disaster recovery. Recovery happens in two steps. First restore the Linux base (including operating system) and then restore the applications.

A file system backup and restore option supports the base disaster recovery.

During a system backup the following application data is backed up and is restorable when the applications are reinstalled:

- Enterprise Common Manager data
- Subscriber Manager security certificates and CND connection details
- Element Manager data

### Application configured system data

You can configure values for routes, host records, and firewall rules using the CLI commands `routeconfig`, `hostconfig`, and `basefirewallconfig`. These values are application configured system data. Application configured system data is backed up as part of the application data backup. For more information about Nortel Linux base CLI commands see “[Nortel Linux base CLI commands](#)” (page 139).

### Base recovery

After a successful base installation, you can choose to back up prespecified file systems (both executable binary and configuration data files) onto a USB or network Secure File Transfer Protocol (SFTP) storage device.

The following naming convention is used for the Linux base backup archive:

`hostname-yyyy.mm.dd.hh.MM.ss.tar.gz`

For example, `hp3-e-2008.09.04.18.54.47.tar.gz` is a backup archive name where `hp3-e` is the host name. The archive name begins with the short host name (not the FQDN) and contains the following fields, which are defined as follows:

- yyyy - year
- mm - month
- dd - day
- hh - hour
- MM - minutes
- ss - seconds

Nortel Linux base uses the CLI command `sysbackup` to backup system data to external storage. You can choose to back up the data to a USB device or to an SFTP server. For more information about SFTP data backup, see [“Network configuration for Secure File Transfer Protocol \(SFTP\) data backup” \(page 143\)](#).

**Note:** Only one USB storage device should be attached during backup/restore command execution.

The backup operation has two modes; interactive and noninteractive. Interactive backup is performed by using the CLI command `sysbackup -b`. Interactive backup performs a single backup operation and is intended to backup data before and after critical changes to the system. Interactive backup can be used as an irregular or on-demand backup. Noninteractive backup is performed by using the CLI command `sysbackup -c`. Noninteractive backup performs a regular or scheduled backup. You can configure a Noninteractive backup as shown in [Figure 108 "Backup Scheduler 1" \(page 117\)](#) and [Figure 109 "Backup Scheduler 2" \(page 118\)](#).

**Note:** The minutes parameter in the backup scheduler does not support asterisk as a valid parameter.

**Figure 108**  
**Backup Scheduler 1**

```
Remote Configuration File Validation
-----
Local machine IP: 192.167.105.51
Local machine netmask: 255.255.255.0
Gateway: 192.167.105.1

SFTP server IP: 192.167.104.50

SFTP userid: nortel
SFTP password: *****
SFTP directory: /admin/nortel/
Is this information correct (Y/N) [Y]?
Do you want to use default backup time (midnight Sunday) (Y/N) [Y]? n
The value in the brackets is the default one. Use asterisk if you are
not going to use this parameter.
```

**Figure 109**  
**Backup Scheduler 2**

```
nortel@cs1000nra2 ~]$ ayabackup -s
Backup configured:
  Minute: 10
  Hour: 0
  Month: 1
  Day of month: 1
  Day of week: 7

Star symbol (*) means any number.
[nortel@cs1000nra2 ~]$
```

**Note:** The CLI command `sysbackup` can be used to make a system backup. For a list of Nortel Linux base CLI commands see [Table 11 "Nortel Linux base CLI commands" \(page 141\)](#).

You can use the command `sysrestore` to perform system recovery, as shown in [Figure 110 "sysrestore command" \(page 118\)](#).

Backup files generated by the `sysrestore` command are named according to the Linux base backup archive naming convention. Sysrestore provides a list of the archives that are available on the backup media.

Sysrestore restores application-specific data. Application data backup and restoration is determined by the individual applications; for more information refer to the appropriate application NTP.

#### **ATTENTION**

Archives created prior to Release 5.5 do not contain application configured system data. If you use an archive created prior to Release 5.5 you cannot restore application configured system data.

**Figure 110**  
**sysrestore command**

```
$ sysrestore
All Nortel applications will be stopped.
Do you want to continue (Y/N) [Y]? y

1. Recover from USB device.
2. Recover from SFTP server.

Enter your choice (q for exit):
```

You can also use the installation media as rescue media (CD/DVD for HP DL320 G4 and IBM x306m servers), which supports the recovery of the base system.

The following figure shows the base system recovery option.

**Figure 111**  
**Configuration Data Selection window**

```
Configuration Data Selection
-----
1. Normal installation (do not use any configuration files)
2. Load previously backed up data from external USB device.
   (Note: only one USB device can be plugged-in when prompted.)
3. Load previously backed up data from SFTP-server.

Select (1-3):_
```

When a server boot-up with bootable installation media occurs, you can choose from the following options:

- Normal installation
- Load recovery data from an external USB device
- Load recovery data from a secure SFTP server that is accessible by ELAN





---

## Appendix

# Passthrough end user license agreement

---

**ATTENTION**

Do not contact Red Hat for technical support on your Nortel version of the Linux base operating system. If technical support is required for the Nortel version of the Linux base operating system, contact Nortel technical support through your regular channels.

This section governs the use of the Red Hat Software and any updates to the Red Hat Software, regardless of the delivery mechanism and is governed by the laws of the state of New York in the U.S.A. The Red Hat Software is a collective work under U.S. Copyright Law. Subject to the following terms, Red Hat, Inc. (“Red Hat”) grants to the user (“Customer”) a license to this collective work pursuant to the GNU General Public License. Red Hat Enterprise Linux (the “Red Hat Software”) is a modular operating system consisting of hundreds of software components. The end user license agreement for each component is located in the component’s source code. With the exception of certain image files identified below, the license terms for the components permit Customer to copy, modify, and redistribute the component, in both source code and binary code forms. This agreement does not limit Customer’s rights under, or grant Customer rights that supersede, the license terms of any particular component. The Red Hat Software and each of its components, including the source code, documentation, appearance, structure and organization are owned by Red Hat and others and are protected under copyright and other laws. Title to the Red Hat Software and any component, or to any copy, modification, or merged portion shall remain with the aforementioned, subject to the applicable license. The “Red Hat” trademark and the “Shadowman” logo are registered trademarks of Red Hat in the U.S. and other countries. This agreement does not permit Customer to distribute the Red Hat Software using Red Hat’s trademarks. If Customer makes a commercial redistribution of the Red Hat Software, unless a separate agreement with Red Hat is executed or other permission granted, then

Customer must modify any files identified as “REDHAT-LOGOS” and “anaconda-images” to remove all images containing the “Red Hat” trademark or the “Shadowman” logo. As required by U.S. law, Customer represents and warrants that it: (a) understands that the Software is subject to export controls under the U.S. Commerce Department’s Export Administration Regulations (“EAR”); (b) is not located in a prohibited destination country under the EAR or U.S. sanctions regulations (currently Cuba, Iran, Iraq, Libya, North Korea, Sudan and Syria); (c) will not export, re-export, or transfer the Software to any prohibited destination, entity, or individual without the necessary export license(s) or authorization(s) from the U.S. Government; (d) will not use or transfer the Red Hat Software for use in any sensitive nuclear, chemical or biological weapons, or missile technology end-uses unless authorized by the U.S. Government by regulation or specific license; (e) understands and agrees that if it is in the United States and exports or transfers the Software to eligible end users, it will, as required by EAR Section 740.17(e), submit semi-annual reports to the Commerce Department’s Bureau of Industry & Security (BIS), which include the name and address (including country) of each transferee; and (f) understands that countries other than the United States may restrict the import, use, or export of encryption products and that it shall be solely responsible for compliance with any such import, use, or export restrictions. Red Hat may distribute third party software programs with the Red Hat Software that are not part of the Red Hat Software. These third party programs are subject to their own license terms. The license terms either accompany the programs or can be viewed at <http://www.redhat.com/licenses/>. If Customer does not agree to abide by the applicable license terms for such programs, then Customer may not install them. If Customer wishes to install the programs on more than one system or transfer the programs to another party, then Customer must contact the licensor of the programs. If any provision of this agreement is held to be unenforceable, that shall not affect the enforceability of the remaining provisions. Copyright © 2003 Red Hat, Inc. All rights reserved. "Red Hat" and the Red Hat "Shadowman" logo are registered trademarks of Red Hat, Inc. "Linux" is a registered trademark of Linus Torvalds. All other trademarks are the property of their respective owners.

## Appendix

# COTS Servers

---

The Linux base is installed on one of two commercial off-the-shelf (COTS) servers; the Hewlett Packard (HP) DL320-G4 1U server or the International Business Machines (IBM) x306m 1U server.

This appendix provides a brief description of each server,

### HP DL320 G4 server

The HP DL320 G4 server provides the following features:

- Intel Pentium 4 processor (3.6 GHz)
- Two 80 GB SATA Hard drives (1 configured)
- 4 GB PC2-4200 ECC DDR2 SDRAM (2 GB configured)
- Two 10/100/1000BaseT Ethernet ports
- Three USB ports
- One CD-R/DVD ROM drive
- One serial port
- A reset button

Figure 112  
HP DL320 G4 front view

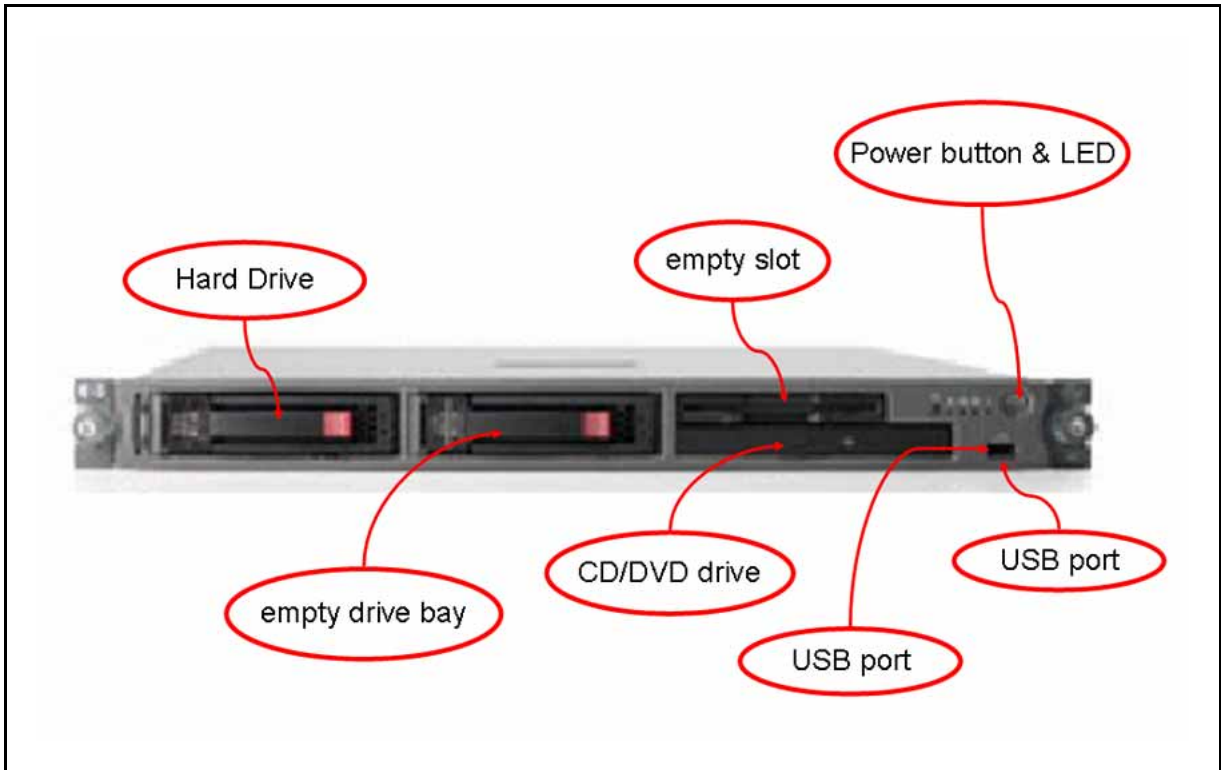


Figure 113  
HP DL320 G4 front view: LEDs

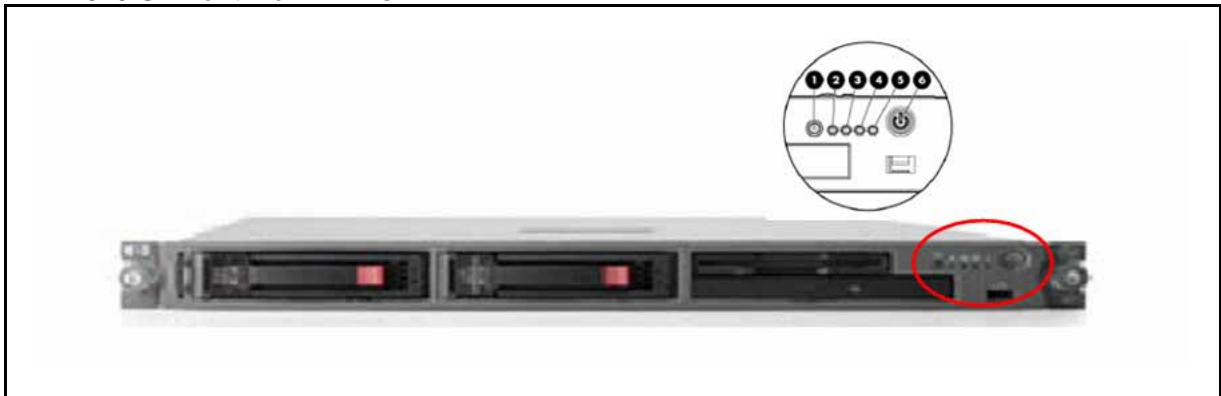
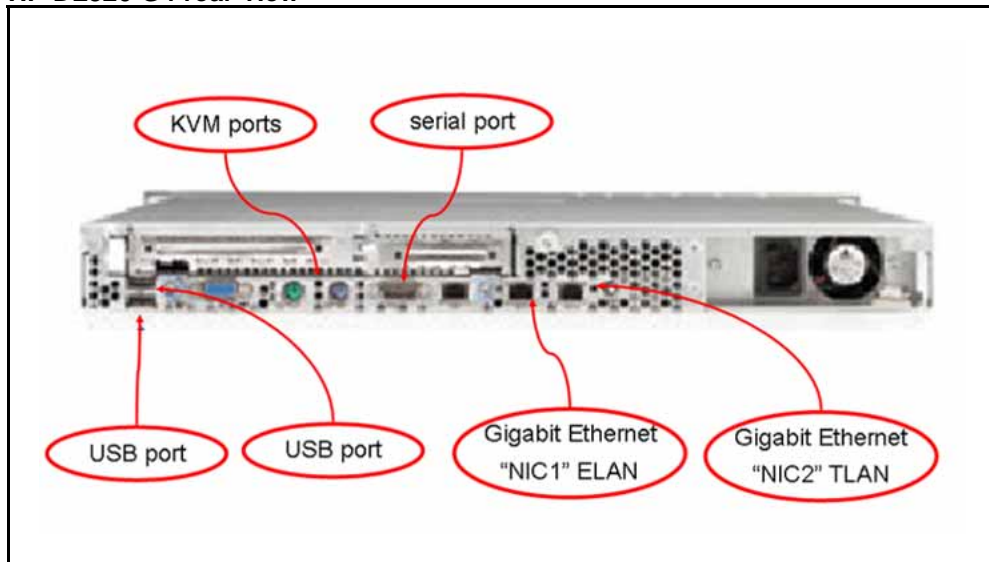


Table 5  
HP DL320 G4 LED item description and status

Item	Description	Status
1	UID button LED (Unit Identification)	<b>Blue</b> – Identification is activated. <b>Flashing blue</b> – System is remotely managed. <b>Off</b> – Identification is deactivated.

Item	Description	Status
2	Internal health LED	<b>Green</b> -- System health is normal. <b>Amber</b> – System is degraded. To identify the component, check the system board LEDs. <b>Red</b> – Critical. To identify the component in a critical state, check the system board LEDs. <b>Off</b> – System health is normal (when in standby mode).
3	NIC 1 link/activity LED	<b>Green</b> – Network link exists. <b>Flashing green</b> – Network link and activity exist. <b>Off</b> – No link to network exists.
4	NIC 2 link/activity LED	<b>Green</b> –Network link exists. <b>Flashing green</b> – Network link and activity exist. <b>Off</b> – No link to network exists.
5	Drive activity LED	<b>Green</b> – Drive activity is normal. <b>Amber</b> – Drive failure occurred. <b>Off</b> – No drive activity.
6	Power button and LED	<b>Green</b> – System is on. <b>Amber</b> – System is shut down, but power is still applied. <b>Off</b> – Power not available.

Figure 114  
HP DL320 G4 rear view



**ATTENTION**  
The TLAN and ELAN port positions are reversed (L and R, 1 and 2) compared to the IBM x306m server.

## HP DL320 G4 BIOS settings

The Basic Input Output System (BIOS) settings on the HP DL320 G4 server shipped through Nortel are correct. The BIOS settings do not require adjustment unless they are reset due to a fault or through maintenance. If a reset of the BIOS settings occurs, check the serial port option. The HP DL320 G4 BIOS settings can be seen at [Table 6 "HP DL320 G4 default BIOS settings" \(page 126\)](#). The HP DL320 G4 servers provide a physical COM1 serial port and a virtual (ILO) COM2 serial port. If the setting for the serial console port is Auto, output can be directed to either the COM1 port or COM2 ILO port. Set the serial console port option to COM1 to ensure the console output goes to the physical COM1. See ["Configure the COM1 serial port on an HP DL320 G4 server" \(page 126\)](#) for instructions.

The HP DL320 G4 server shipped through Nortel has a default baud rate of 9600 b/ps and does not require a reset. If an error occurs and you want to reset the baud rate, or if you want to change to another baud rate, see ["Changing the baud rate on an HP DL320 G4 Signaling Server" \(page 128\)](#) for instructions.

For information about how to enable or disable the BIOS password on the HP DL320 G4 server see ["Setting the HP DL320 G4 server BIOS password" \(page 130\)](#).

**Table 6**  
**HP DL320 G4 default BIOS settings**

BIOS value	Default setting
Devices and I/O port - serial port A	Enabled
Devices and I/O port - baud rate	9600 baud
Devices and I/O port - type of connector	9-pin serial female
Start options - legacy USB support	Disabled

### Configure the COM1 serial port on an HP DL320 G4 server

Step	Action
1	Press <b>Power</b> to boot the server. The server boots and the HP DL320 G4 boot screen appears.

**Figure 115**  
HP DL320 G4 server boot screen

```
Press "F9" key for ROM-Based Setup Utility
Press "F10" key for System Maintenance Menu
Press "F12" key for PXE boot
For access via BIOS Serial Console
Press "ESC+9" for ROM-Based Setup Utility
Press "ESC+0" for System Maintenance Menu
Press "ESC+@" for PXE boot
```

**Note:** If the server is already up and running, power the server off and on to reboot and receive the HP DL320 G4 boot screen.

- 2 Press **F9** to invoke the ROM-based setup utility (RBSU) menu screen.

The RBSU menu screen appears.

**Figure 116**  
HP DL320 G4 server RBSU menu

```

+-----+
|System Options|
|PCI Devices  |
|Standard Boot Order (IPL)|
|Boot Controller Order|
|Date and Time |
|Server Availability|
|Server Passwords|
|BIOS Serial Console & EMS|
|Server Asset Text|
|Advanced Options|
|Utility Language|
+-----+
HP ProLiant DL320 G4
S/N: USE648NCKK
Product ID: AH509A
HP BIOS D20 08/25/2006
Backup Version 08/25/2006
Bootblock 06/01/2005

2048MB Memory Configured

Proc 1: Intel 3.60GHz, 2MB L2 Cache
MAC address for NIC 1: 0019BB257A6F
MAC address for NIC 2: 0019BB257A70
+-----+

<Enter> to View/Modify System Specific Options
<↑/↓> for Different Selection; <ESC> to Exit Utility
```

- 3 Navigate to the **BIOS Serial Console & EMS** option and press **Enter**.

A BIOS Serial Console & EMS configuration menu screen appears.

- 4 Navigate to the **BIOS Serial Console Port** option and press **Enter**.

A BIOS Serial Console Port configuration screen appears. This screen presents you with four options:

- 1 | Auto
- 2 | Disabled
- 3 | COM 1
- 4 | COM 2

- 5**      Navigate to the **COM 1** option and press **Enter**.  
This configures the COM 1 port as the serial port for communicating with the connected maintenance terminal.  
The BIOS Serial Console & EMS configuration menu screen reappears.
- 6**      Press **ESC** to exit the BIOS Serial Console & EMS configuration menu screen.  
The RBSU menu screen reappears.
- 7**      Press **ESC** to exit the ROM-based Setup Utility.

---

--End--

---

#### Changing the baud rate on an HP DL320 G4 Signaling Server

**ATTENTION**

The HP DL320 G4 server shipped through Nortel has a default Baud rate of 9600 b/ps and does not require a reset. Use this procedure only if you want to use another Baud rate, or to correct the Baud rate after it is reset due to an error.

---

<b>Step</b>	<b>Action</b>
<b>1</b>	Press <b>Power</b> to boot the server. The server boots and the HP DL320 G4 boot screen appears.

---



**Figure 117**  
**HP DL320 G4 server boot screen**

```
Press "F9" key for ROM-Based Setup Utility
Press "F10" key for System Maintenance Menu
Press "F12" key for PXE boot
For access via BIOS Serial Console
Press "ESC+9" for ROM-Based Setup Utility
Press "ESC+0" for System Maintenance Menu
Press "ESC+@" for PXE boot
```

**Note:** If the server is already up and running, power the server off and on to reboot and receive the HP DL320 G4 boot screen.

- 2 Press **F9** to invoke the ROM-based Setup Utility (RBSU) menu screen.

The RBSU menu screen appears.

**Figure 118**  
**HP DL320 G4 server RBSU menu**

```

+-----+
|System Options|
|PCI Devices  |
|Standard Boot Order (IPL)|
|Boot Controller Order|
|Date and Time |
|Server Availability|
|Server Passwords|
|BIOS Serial Console & EMS|
|Server Asset Text|
|Advanced Options|
|Utility Language|
+-----+
HP ProLiant DL320 G4
S/N: USE648NCKK
Product ID: AH509A
HP BIOS D20 08/25/2006
Backup Version 08/25/2006
Bootblock 06/01/2005

2048MB Memory Configured

Proc 1: Intel 3.60GHz, 2MB L2 Cache
MAC address for NIC 1: 0019BB257A6F
MAC address for NIC 2: 0019BB257A70
+-----+

<Enter> to View/Modify System Specific Options
<↑/↓> for Different Selection; <ESC> to Exit Utility
```

- 3 Navigate to the **BIOS Serial Console & EMS** option and press **Enter**.  
A BIOS Serial Console & EMS configuration screen appears.
- 4 Navigate to the **BIOS Serial Console Baud Rate** option and press **Enter**.

A BIOS Serial Console Baud Rate configuration window appears. This window presents you with four settings for the serial port speed:

- 9600
- 19200
- 57600
- 115200

- 5 Navigate to the **9600** setting and press **Enter**.  
This configures the serial port speed to 9600 b/ps.  
The BIOS Serial Console & EMS configuration menu screen reappears.
- 6 Press **ESC** to exit the BIOS Serial Console & EMS configuration menu screen.  
The RBSU menu screen reappears.
- 7 Press **ESC** to exit the ROM-based Setup Utility.

---

--End--

---

#### Setting the HP DL320 G4 server BIOS password

Step	Action
1	Press <b>Power</b> to boot the server. The server boots and the HP DL320 G4 boot screen appears.

**Figure 119**  
HP DL320 G4 server boot screen

```
Press "F9" key for ROM-Based Setup Utility
Press "F10" key for System Maintenance Menu
Press "F12" key for PXE boot
For access via BIOS Serial Console
Press "ESC+9" for ROM-Based Setup Utility
Press "ESC+0" for System Maintenance Menu
Press "ESC+@" for PXE boot
```

**Note:** If the server is already up and running, power the server off and on to reboot and receive the HP DL320 G4 boot screen.

- 2 Press **F9** to invoke the ROM-based setup utility (RBSU) menu screen.  
The RBSU menu screen appears.

**Figure 120**  
**HP DL320 G4 server RBSU menu**

```

+-----+
|System Options|
|PCI Devices  |
|Standard Boot Order (IPL)|
|Boot Controller Order|
|Date and Time |
|Server Availability|
|Server Passwords|
|BIOS Serial Console & EMS|
|Server Asset Text|
|Advanced Options|
|Utility Language|
+-----+

HP ProLiant DL320 G4
S/N: USE648NCKK
Product ID: AH509A
HP BIOS D20 08/25/2006
Backup Version 08/25/2006
Bootblock 06/01/2005

2048MB Memory Configured

Proc 1: Intel 3.60GHz, 2MB L2 Cache
MAC address for NIC 1: 0019BB257A6F
MAC address for NIC 2: 0019BB257A70

+-----+
|
+-----+

<Enter> to View/Modify System Specific Options
<↑/↓> for Different Selection: <ESC> to Exit Utility

```

- 3 Select the Server Passwords option and press **Enter**.
- 4 Select the Set Admin Password option and press **Enter**.
- 5 At this point refer to the manufacturer's manual for specific instructions on how to enable or disable the BIOS password.

---

--End--

---

For additional operating information see the Server Product Guide on the resource CD-ROM shipped with the HP DL320 G4 server .

## IBM x306m server

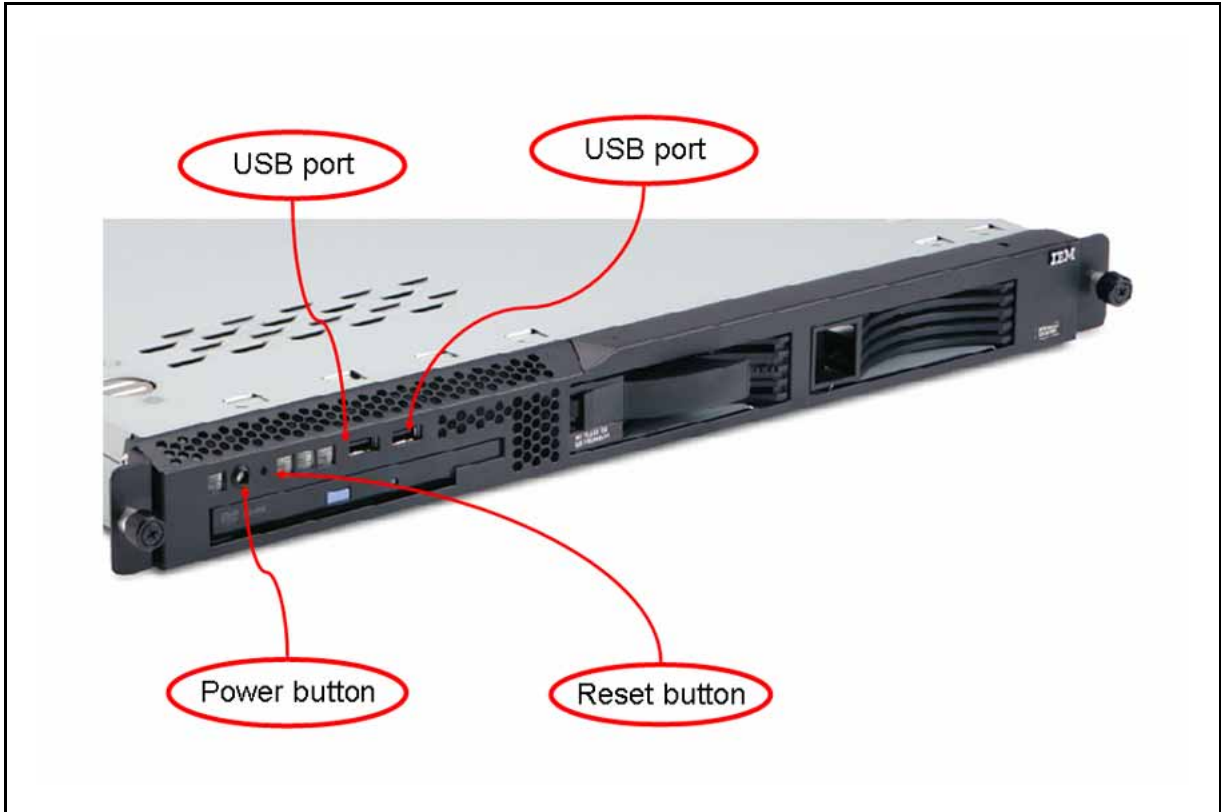
The IBM x306m server provides the following features:

- an Intel Pentium 4 processor (3.6 GHz)
- 2 simple swap Serial ATA, 80 GB (1 drive configured)
- 8 GB of RAM PC4200 DDR II by means of 4 DIMM slots (2 GB configured)
- Two Gigabit Ethernet ports
- Four USB ports (two front, two back)
- One DVD-COMBO (DVD/CD-RW) drive

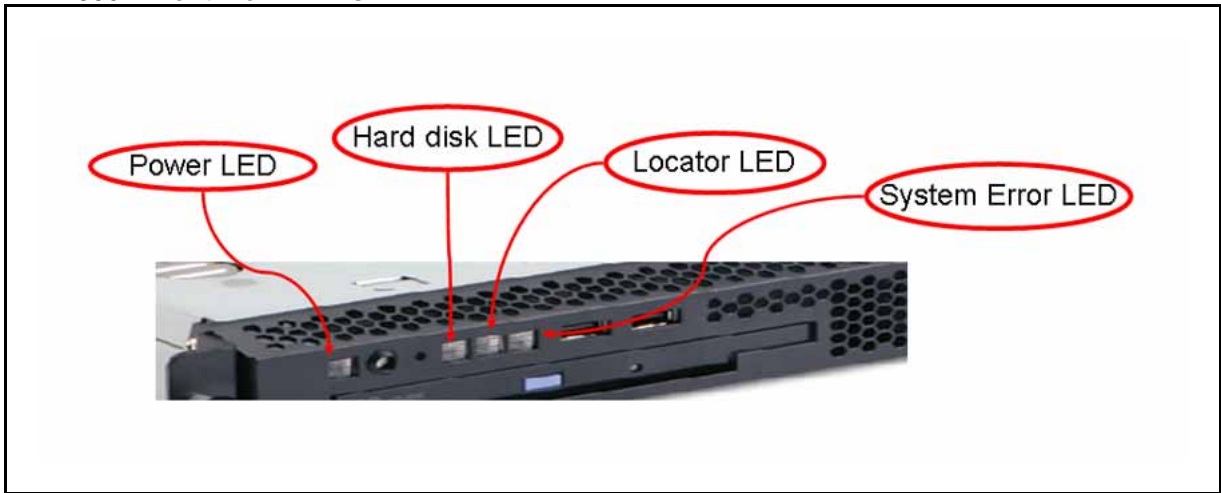
— You use this to load the Signaling Server software files for the Signaling Server, Voice Gateway Media Cards, and IP Phones

- One serial port (back of Signaling Server)
- A reset button

**Figure 121**  
**IBM x306m front view**



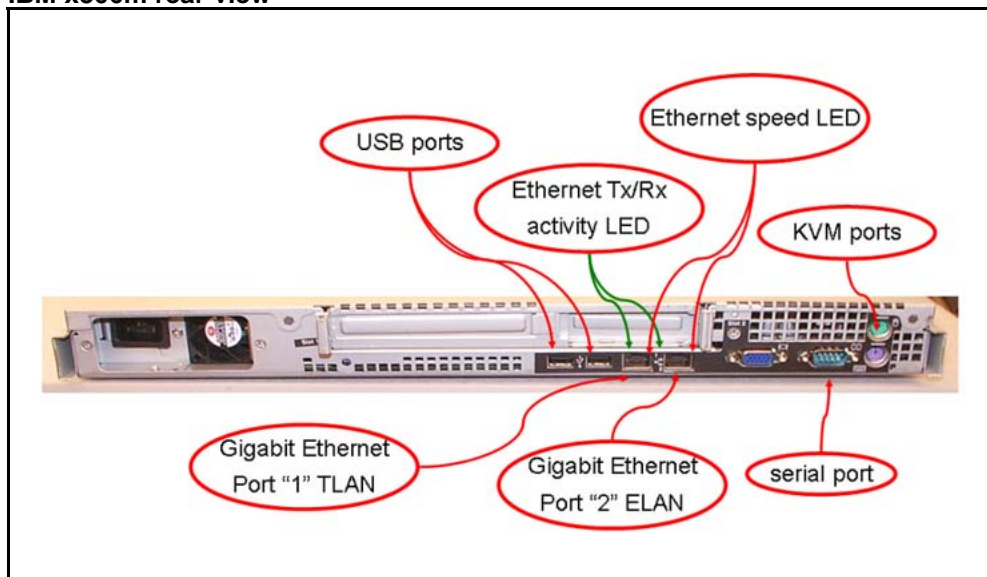
**Figure 122**  
**IBM x306m front view: LEDs**



**Table 7**  
**IBM x306m LED description and status**

Description	Status
Power LED	If this LED is lit, it indicates that the server is turned on. If this LED is off, it indicates that AC power is not present, or the power supply or the LED itself failed.
Hard disk LED	If this LED is lit, it indicates that a hard disk drive is in use.
Locator LEDIf	When this LED is lit, it is lit remotely by the system administrator to aid in visually locating the server.
System Error LED	If this LED is lit, it indicates that a system error occurred.

**Figure 123**  
**IBM x306m rear view**



**ATTENTION**

The TLAN & ELAN port positions are reversed (L and R, 1 and 2) compared to the HP DL320 server. Ethernet speed LED:

- Lit indicates Ethernet network speed of 1 Gbps.
- Off indicates Ethernet network speed is 10/100 Mbps.

### IBM x306m BIOS settings

The BIOS settings on the IBM x306m server shipped through Nortel are correct. These settings can be viewed at [Table 8 "IBM x306m default BIOS settings" \(page 134\)](#).

**Table 8**  
**IBM x306m default BIOS settings**

BIOS value	Default setting
Devices and I/O port - serial port A	Enabled
Devices and I/O port - baud rate	9600 baud
Devices and I/O port - console type	PC ANSI
Devices and I/O port - flow control	Off
Devices and I/O port - continue C.R. after POST	On
Devices and I/O port - type of connector	9-pin serial female
Start options - legacy USB support	Disabled

The IBM x306m server default BIOS settings can be changed by a BIOS reset or other maintenance activity. To return the BIOS settings to the appropriate values, see ["Changing the BIOS settings on an IBM x306m server" \(page 134\)](#) for instructions.

For information about how to enable or disable the BIOS password on the IBM x306m server see ["Setting the IBM x306m server BIOS password" \(page 136\)](#).

#### Changing the BIOS settings on an IBM x306m server

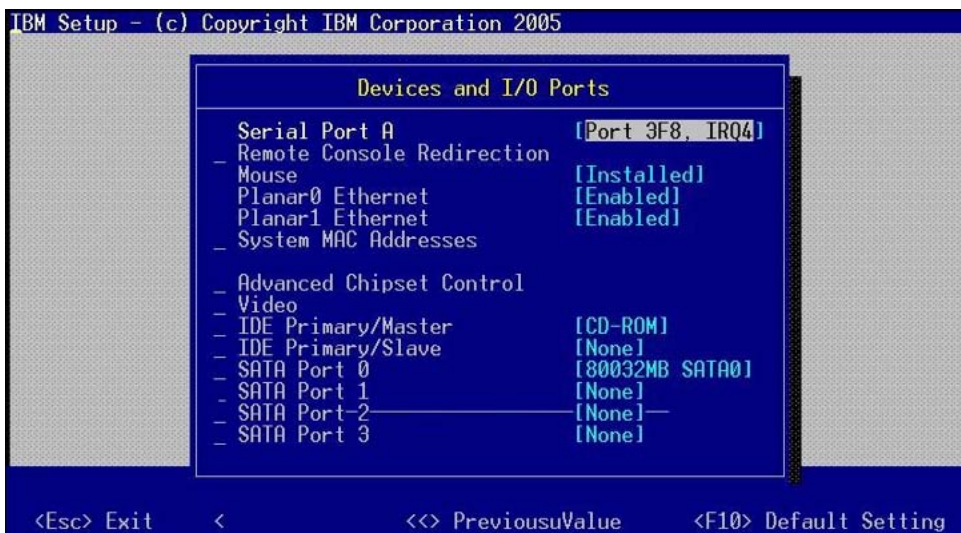
Step	Action
1	<p>Press the Power switch to boot the server.</p> <p>The server boots and the Press F1 for Configuration/Setup message appears on the maintenance terminal.</p> <p><b>Note:</b> If the server is already up and running, power the server off and on or press the reset button to reboot and receive the Press F1 for Configuration/Setup message.</p>
2	<p>Press <b>F1</b> to invoke the IBM x306m server Configuration/Setup Utility.</p> <p>The Configuration/Setup Utility menu screen appears.</p>

**Figure 124**  
IBM x306m server Configuration/Setup Utility menu



- 3 Navigate to the **Devices and I/O Ports** option and press **Enter**.  
The Devices and I/O Ports menu screen appears.

**Figure 125**  
Devices and I/O Ports menu



- 4 Navigate to the **Remote Console Redirection** option and press **Enter**.  
The Remote Console Redirection screen appears.

**Figure 126**  
**IBM x306m server Remote Console Redirection**



- 5 Navigate to the option you wish to change and enter the appropriate value.
- 6 Press **Enter** to change the setting.
- 7 Press **ESC** to exit the **Remote Console Redirection** option.  
The Devices and I/O Ports menu screen appears.
- 8 Press **ESC** to exit the **Devices and I/O Ports** option.  
The Configuration/Setup Utility menu screen appears.
- 9 Navigate to the **Save Settings** option and press **Enter** to save the changed parameters.
- 10 Navigate to the **Exit Setup** option and press **Enter** to exit the IBM x306m Configuration/Setup Utility.  
The server will reboot automatically.

---

--End--

---

#### Setting the IBM x306m server BIOS password

- | Step | Action                                     |
|------|--|
| 1    | Press the Power switch to boot the server. |



The server boots and the Press F1 for Configuration/Setup message appears on the maintenance terminal.

**Note:** If the server is already up and running, power the server off and on or press the reset button to reboot and receive the Press F1 for Configuration/Setup message.

- 2 Press **F1** to invoke the IBM x306m server Configuration/Setup Utility.

The Configuration/Setup Utility menu screen appears.

**Figure 127**  
IBM x306m server Configuration/Setup Utility menu



- 3 Select the System Security option and press **Enter**.
- 4 Select the Administrator Password option and press **Enter**.
- 5 At this point refer to the manufacturer's manual for specific instructions on how to enable or disable the BIOS password.

---

--End--

---

For additional operating information see the Server Product Guide on the resource CD-ROM shipped with the IBM x306m server .



---

## Appendix

# Nortel Linux base CLI commands

---

Table 11 "Nortel Linux base CLI commands" (page 141) contains a list of the command line interface (CLI) commands used in Nortel Linux base. Type `(linuxbase-command) -h | --help` at the command prompt to display a brief summary of the CLI command, as shown in Table 9 "Linux CLI command help" (page 139). Type `man (linuxbase-command)` at the command prompt for a more detailed description, as shown in Table 10 "Linux man command example" (page 140).

**Table 9**  
**Linux CLI command help**

```
$ poos --help
Usage:
poos (patch_id)|-app *(app_name)*|--help,-h

Options:
(patch_id)
Deactivate patch with (patch_id) handle.

-app *(app_name)*
Deactivate all patches for the application (app_name).

--help
Print this help message and exit.
```

**Table 10**  
**Linux man command example**

```

$ man poos

POOS(1) User Contributed Nortel Documentation POOS(1)

NAME
poos - Put a patch out of service.

SYNOPSIS
poos (patch_id)| -app (app_name) | --help,-h

DESCRIPTION
Remove a patch from service. The patch is removed from service from all processes in which it
was in service.

OPTIONS
(patch_id)
Deactivate patch with (patch_id) handle.

-app (app_name)
Deactivate all patches for the application (app_name).

--help Print this help message and exit.

EXAMPLES
Deactivate patch with 2 handle
$ poos 2
Patch handle: 2
Please ensure that the application solid is stopped before proceeding patch un-installation.
Do you want to continue patch un-installation? (Y/N) [N]? y
Performing the uninstallation:
Performing uninstall RPM patch...
Preparing... ##### [100%]
1:nortel-cs1000-solid ##### [100%]
executing Solid DB post install...
Installation nortel Solid database server completed.
Uninstalling the Solid database server package done

Done.
The RPM patch uninstallation is completed.
The patch 2 has been deactivated successfully.

Deactivate all sunAm patches
$ poos -app sunAm
Patch handle: 0
Performing the uninstallation:

```

The patch 0 has been deactivated successfully.

SEE ALSO pload, pout, pins, pstat, plis

5.50 2007-12-18 POOS(1)

**Table 11**  
**Nortel Linux base CLI commands**

Command	Description
appinstall	Install Nortel applications.
appstart	Stop, start, or restart Nortel applications.
appVersionShow	Print the server's application software version.
basefirewallconfig	Configure firewall settings.
baseparamsconfig	Configure base parameters.
baseVersionShow	Print the server's base software version.
datetimeconfig	Configure the date and time.
dnsconfig	Configure DNS values.
ecnconfig	Configure Explicit Congestion Notification settings.
ftpdisable	Disable FTP.
ftpenable	Enable FTP.
ftpstatus	Show the current FTP status.
hostconfig	Configure the static lookup table for host names.
networkconfig	Configure network settings.
ntpconfig	Configure Network Time Protocol settings.
passwd	Change the user's password.
pins	Put the patch in service.
plis	Show detailed information about the patch.
pload	Load the patch into the system database.
poos	Put the patch out of service.
pout	Unload the patch from the system database.
pstat	Show a list of installed patches.
reboot	Reboot the entire system.
routeconfig	Configure routing entries.
swVersionShow	Print the server's software version.
sysbackup	Perform a system backup (both base and applications).
sysrestore	Perform a restore of the application data (backed up by sysbackup).
upgrade	Select the backup data source and reinstall Linux base.

You might need to add the primary host entry in backup and member server before you can access them using the `hostconfig` command.

The command syntax is `nortel user ---> hostconfig add -ip <PRIMARY SERVER IP> -host <PRIMARY SERVER HOST NAME> -domain <PRIMARY SERVER DOMAIN NAME>`.

---

## Appendix

# Network configuration for Secure File Transfer Protocol (SFTP) data backup

---

Use the guidelines in this appendix to assist in data backup to an SFTP server. The section “[Network configuration](#)” (page 143) provides details on network requirements and the section “[SFTP logon](#)” (page 143) provides SFTP logon details. The section “[SFTP network configuration requirements](#)” (page 144) provides specific Embedded Local Area Network (ELAN) and Telephony Local Area Network (TLAN) requirements for SFTP network configuration.

### Network configuration

The network must be configured correctly for data backup to an SFTP server. In order to configure the network you must understand the difference between the ELAN and the TLAN. The ELAN and TLAN are defined as follows:

- ELAN - The ELAN is a secure local area network. The scope of this network is limited to one subnet or node; however the scope of the ELAN network can be expanded to cover multiple nodes with advanced router (data path) configurations.
- TLAN - The TLAN spans the entire enterprise network. Every node on the TLAN has access to every other node.

**Note:** The definitions of ELAN and TLAN are a subset of the definitions provided in the voice media gateway cards section of *IP Line Fundamentals (NN43100-500)* () .

### SFTP logon

Data backup to an SFTP server requires a user logon, password, and path to access the SFTP server storage. The user logon can contain a maximum of 32 characters comprised of lower and upper case letters,

numeric digits, and the special characters `_` `.` `-` and `$`. You cannot use the character `-` at the beginning of the logon string and you can use `$` only at the end of the logon string.

Nortel Linux base does not recognize the `\` character. Do not use the `\` character when you specify the SFTP directory.

## SFTP network configuration requirements

The SFTP option requires an operational ELAN network because the backup and recovery of data must use the ELAN interface. Nortel recommends the destination SFTP server reside on the same ELAN network as the source SFTP server. If the destination SFTP server resides outside the subnet of the source SFTP server, use one of the two options shown in [Table 12 "SFTP network configuration requirements" \(page 144\)](#).

**Table 12**  
**SFTP network configuration requirements**

Option	Details
1	<p>The router connecting the two subnets must be configured to allow pings to pass through. This ensures there is a valid data path between the two subnets</p> <p>If the default gateway is set to the TLAN interface gateway, a routing entry is required to ensure that all ELAN data uses only the ELAN NIC. Use the CLI command <code>routeconfig</code> to add the routing entry. An example of the <code>routeconfig</code> command is as follows:</p> <pre>routeconfig add -net destination_ip -netmask subnet_mask -gw gateway_ip -dev eth0</pre>
2	<p>On the source server set the ELAN interface gateway as the default gateway.</p>



---

# Index

---

## A

Application installation 69

## C

Configuration Data Selection window 39

Configuration for Network Routing

Service or Element Manager 99

Configuration Validation 1 window 43, 62

Configuration Validation 2 window 46, 63

## D

Date and Time Configuration 47, 64

Disaster recovery 116

DNS Server Configuration window 46

## E

ECM

upgrade 28

Element Manager applications 82

## I

Install the CS 1000 applications 70

Install the Linux base software 37

Installation prompt window 38

## L

Linux base installation 35

## N

Network Configuration window 40

Network firewall 102

Network Time Protocol Configuration 44

NRS applications 71

## P

Package Installation window 51, 66

Password Configuration 47

Password recovery 111

Patching 106

Post System Configuration window 51

, 67

Prerequisites to install and configure 70

Primary Security Service server Fully

Qualified Domain Name 78,

81, 88, 91, 98

Primary Security Service server TLAN

IP address window 78, 80, 87,

90, 98

Private CA Certificate confirmation

window 74, 84, 94

## S

Security hardening 104

## T

Task flows 13

## U

Upgrade 53

ECM 28

User accounts 109





Nortel Communication Server 1000

# Linux Platform Base and Applications Installation and Commissioning

Copyright © 2007–2008 Nortel Networks  
All Rights Reserved.

Release: Release 5.5  
Publication: NN43001-315  
Document revision: 02.09  
Document release date: 29 October 2008

To provide feedback or to report a problem in this document, go to [www.nortel.com/documentfeedback](http://www.nortel.com/documentfeedback).

[www.nortel.com](http://www.nortel.com)  
Sourced in Canada

## LEGAL NOTICE

While the information in this document is believed to be accurate and reliable, except as otherwise expressly agreed to in writing NORTEL PROVIDES THIS DOCUMENT "AS IS" WITHOUT WARRANTY OR CONDITION OF ANY KIND, EITHER EXPRESS OR IMPLIED. The information and/or products described in this document are subject to change without notice.

Nortel, the Nortel logo, the Globemark, SL-1, Meridian 1, and Succession are trademarks of Nortel Networks. All other trademarks are the property of their respective owners.



## Free Manuals Download Website

<http://myh66.com>

<http://usermanuals.us>

<http://www.somanuals.com>

<http://www.4manuals.cc>

<http://www.manual-lib.com>

<http://www.404manual.com>

<http://www.luxmanual.com>

<http://aubethermostatmanual.com>

Golf course search by state

<http://golfingnear.com>

Email search by domain

<http://emailbydomain.com>

Auto manuals search

<http://auto.somanuals.com>

TV manuals search

<http://tv.somanuals.com>