



Nortel Networks Communication Server 1000

Nortel Networks DECT Handset 4060

User Guide



Revision history

September 2004

Standard 2.00. This document is up-issued to support Nortel Networks DECT Handset 4060.

July 2004

Standard 1.00. This document is issued to support the Nortel Networks DECT Handset 4060.

Contents

Safety precautions	9
Set up the DECT Handset 4060	11
Install the batteries	11
Before you begin	11
Insert the batteries	12
Charge the batteries	13
Charging guidelines	13
How to charge the batteries	13
Charging and operating times	13
Register the handset	14
About the DECT Handset 4060	17
Basic features	17
Handset controls	18
Illumination	20
Keypad	20
Handset display	21
Icon/text line	21
Text lines	22
Soft key line	23
Powering up your handset	24
Security functions	25
Change the PIN	25
Read-only	27
Reset the handset	28
Configure options on the DECT Handset 4060	30
Key Lock	30
Ringer Settings	32

Melody	32
Ringer Type	34
Device	35
Volume Settings	38
Volume Settings	40
Telephone Options	41
User Name	42
Language	43
Emergency Call	45
Voice Box	49
Attention Tones	51
Silent Charging	52
Charger Answer	55
Auto Quick Hook	57
Auto Answer	59
Disp. Contrast	61
Menu Shortcuts	63
Make a Call	64
Option 1 - On-hook dialing	64
Option 2 - Off-hook dialing	64
Option 3 - Handsfree dialing	65
Make an SOS call	65
Answer or reject a call	66
Answer a call	66
Reject a call	67
Mute the handset ringer	69
While on an active call	71
Place a call on hold	71
Retrieve a call on hold	71

Transfer a call	72
Use Handsfree	72
Mute a call	73
Talk with more than one person	76
Set up a conference call	76
Create a Telephone Book	79
Add, edit, and delete entries	79
Make a call using the Telephone Book	86
Use the Caller List	88
Caller List symbols	88
Access and use the Caller List	89
Use the Redial List	97
Access and use the Redial List	97
Use Quick Call	104
Use Caller Filter	108
List of numbers	108
Filter Options	118
Wild Cards	120
System Settings	125
Access Meridian PBX features	135
Use Voicemail	137
Use Text message	140
Urgent text messages	141
Confirm receipt of urgent text message(s)	146
Normal text messages	147

Confirm receipt of normal text message(s)	149
Store and delete text messages	150
Read text messages	155
Send a text message	158
Accessories	164
Battery	164
Desktop Charger	164
Charger Rack	164
Belt Clip	165
Data cable	165
Headset	166
IBM-compatible PC	166
DECT Handset 4060 software CD	166
PC connection	167
Index	169

Safety precautions

Read the following information before using the Nortel Networks DECT Handset 4060.

**CAUTION**

Do not rely on a cordless phone to make emergency calls. The handset uses radio signals and does not guarantee a connection in all circumstances.

The **CE** symbol on the product certifies its conformity with the technical guidelines concerning user safety and electro-magnetic compatibility valid at the time of approval; in accordance with European directive No. 91\263\EEC.

This product complies with IP50 according to IEC 529 / EN 60 529. Use only in countries where authorized.

Never use your handset in:

- the vicinity of electrical detonators
- shielded rooms
- areas where radio transmission is forbidden
- aircraft

Do not place your handset near:

- water, moisture, or damp areas
- heat sources, direct sunlight, or unventilated areas
- devices that generate strong magnetic fields such as electrical appliances, fluorescent lamps, computers, radios, televisions, or fax machines
- areas where the handset will be covered, thereby impairing ventilation
- near liquid or chemicals
- areas with dust, vibration, shock, or temperature extremes

Observe the following:

**WARNING**

Do not open the handset or charger as doing so could expose you to high voltages. Have all repairs carried out by authorized service personnel.

**WARNING**

Do not store or locate flammable liquids, gases, or explosive materials in the same compartment or vicinity as the cordless handset, its parts or accessories.

**WARNING**

Do not use the handset in a vehicle or hazardous location.

**CAUTION**

Do not let small metal objects come into contact with the handset. This can deteriorate audio quality and damage the handset.

**CAUTION**

- Use only the plug-in AC adapter and battery type supplied.
- Ensure the adapter voltage is the same as the electrical outlet voltage.
- Do not use visibly-damaged AC adapters.

Set up the DECT Handset 4060

Before you use the handset, perform the following:

1. Read the battery safety information and follow the procedure to install the batteries.
2. Charge the batteries.
3. Register your handset with the DECT system.

Install the batteries

Before you begin

The handset uses a rechargeable AAA NiMh of typical 800mAh, 1.2V battery.

**WARNING**

Do not replace the batteries in potentially explosive environments, such as rooms where flammable liquids or gases are present.

**WARNING**

Do not dispose of the batteries in a fire.

**CAUTION**

Do not use disposable AAA 1.5 V batteries.



CAUTION

Do not charge the batteries unless you use the supplied charger and the proper batteries.



CAUTION

Do not let the battery or the charger come into contact with conductive metal objects.

Insert the batteries

Figure 1 illustrates how to insert batteries in the DECT Handset 4060.

Figure 1: Insert the batteries

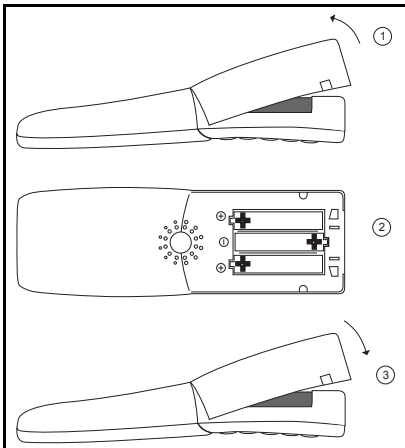

Steps

1. Lift the back cover of the handset as shown in the diagram.
2. Insert the batteries in the battery compartment, ensuring that the polarity is correct. The + - poles of the batteries must correspond to the + - markings in the battery compartment.
3. Replace the cover by placing it on the compartment at a slight angle and pressing it down until it clicks into place.

Charge the batteries



CAUTION

The batteries can become hot during the first charge cycle. If the fully-charged batteries are removed from the handset and inserted again, they can become overcharged when the handset is placed in the charger.

Charging guidelines

- Charge the battery for at least six to seven hours before using the handset for the first time.
- Charge the handset on a regular basis.
- Do not leave the handset connected to the charger longer than one month without using.

How to charge the batteries

1. Plug the charger into an electrical outlet.
2. Place the handset in the charger. The handset display shows **Charging**.

Charging and operating times

- Batteries require 6 to 7 hours to fully charge.
- When a fully-charged handset is switched off, it discharges in approximately one week.
- When batteries are fully charged, the handset has approximately 20 hours of talk time and between 200 and 300 hours of standby time.

The handset display screen shows the batteries' charge status. See Figure 2 for battery charge statuses.

Figure 2: Battery charge status

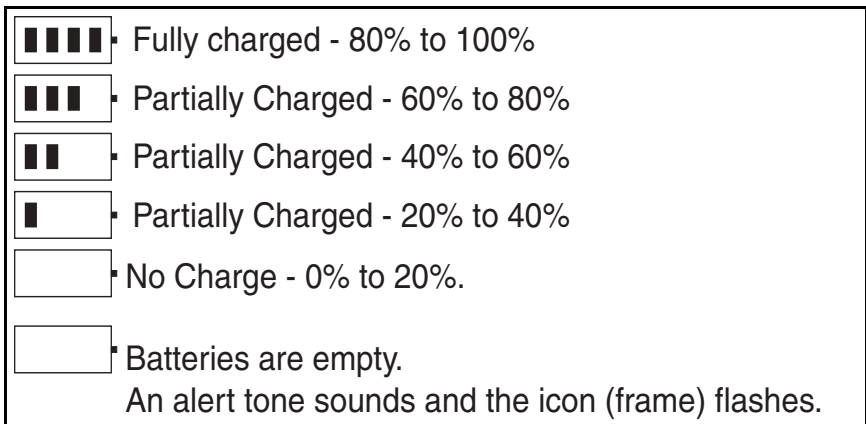

Note: When new batteries are inserted, or the firmware on the handset has been upgraded, a charge status icon will not display until a complete charge cycle has been completed. However, when partially charged batteries are inserted, then the charge status icon will be shown immediately.

Register the handset

Before you can use the DECT Handset 4060, the handset must be registered with the system. A system ID and handset registration code may be required to complete the registration process. Contact your system administrator for proper codes.

To register the handset with the DECT system:

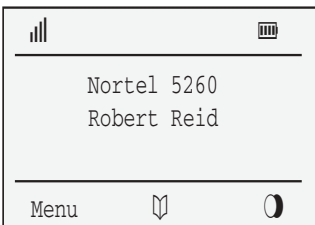

1. Press the **Menu** soft key.

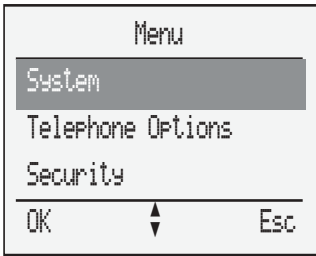

2. Press the **arrow** keys to scroll and highlight the **System** option.

OK

3. Press the **OK** soft key.

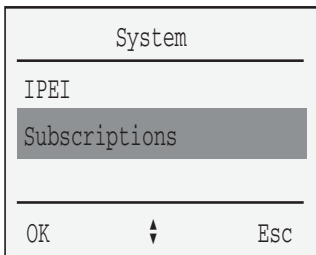

4. Press the **arrow** keys to scroll and highlight the **Subscriptions** option.

OK

5. Press the **OK** soft key.

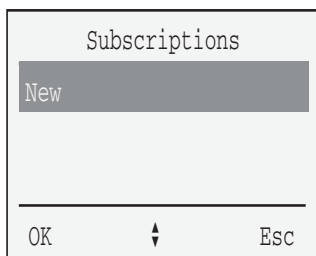

6. Press the **arrow** keys to scroll and highlight the **New** option.

OK

7. Press the **OK** soft key.



OK

OK



OK



OK



OK

8. Choose one of the following:
 - if you are at a location where two DECT systems overlap, use the keypad to enter the system identification number at the **PARK** prompt and press the **OK** soft key.
 - if you are at a location where there is only one DECT system, press the **OK** soft key.

9. Use the keypad to enter the authentication code at the **Auth.Code** prompt and press the **OK** soft key.

10. Use the keypad to enter the system name at the **System Name** prompt and press the **OK** soft key.

11. Use the keypad to enter the local number at the **Local Number** prompt and press the **OK** soft key.

About the DECT Handset 4060

The DECT Handset 4060 is a feature-rich DECT handset that brings a high level of user functionality to in-building mobile workers.

Basic features

The DECT Handset 4060 supports the following features:

- multi-field LCD display
- illuminated keypad
- volume control
- connector for a headset
- connector for a PC adapter
- loudspeaker for on-hook dialing or on-hook listening
- two soft keys (self-labeled) providing access to handset features
- two specialized fixed keys:
 - R (Recall) key
 - Info key
- three Call processing fixed keys:
 - C (Cancel) key
 - Handsfree key
 - Hook key

Handset controls

Figure 3: DECT Handset 4060



Use the **C (Cancel)** key to:

- power On/Off
- delete characters or entire entries
- edit characters





Use the **R** (Recall) key to:

- access Meridian PBX features
- Emergency/SOS calls
- place a call on hold
- retrieve a call on hold
- transfer a call
- set up a conference call



Use the **Hook** key to:

- make a call
- answer a call
- end a call



Use the **Info** key to:

- access Caller List
- access Voicemail
- access Text message



Press the **Handsfree** key to activate handsfree.



Use the soft keys to control handset functions and features.



Press the **arrow** (up/down) keys to select menu items and to access the Telephone Book.

Illumination

The handset keys are illuminated and the display backlight is activated when there is an incoming call, or if a key is pressed. The lights switch off after 10 seconds.

Keypad

Use the keypad to:

- enter the telephone number
- add or edit Telephone Book entries
- create or edit text messages

To enter a character, press a key from 0 to 9. For example, press the 4 key twice to enter the character H. Press  to toggle between upper- and lower-case letters. See Table 1 for handset keypad references.

Table 1: Handset keypad reference

Keypad	Alphabet equivalent	
1	? ! 1 - + * / = () % ¿ i	? ! 1 - + * / = () % ¿ i
2	A B C 2 Ä Å À Á Æ Ç	a b c 2 ä å à á æ ç
3	D E F 3 È Ê É Ë	d e f 3 è ê é ë
4	G H I 4 Ï Î Ï	g h i 4 ï î ï
5	J K L 5	j k l 5
6	M N O 6 Ö Ò Ó Ô Õ Ø	m n o 6 ö ò ó ô õ ø
7	P Q R S 7 ß	p q r s 7 ß
8	T U V 8 Ü Ù Ú Û	t u v 8 ü ù ú û
9	W X Y Z 9	w x y z 9
0	(space) , . 0 : ; _ “ ‘ ^ ~	(space) , . 0 : ; _ “ ‘ ^ ~
*	A -> a	a -> A
#	# @ € \$ £ ¥ § < > { } [\]	# @ € \$ £ ¥ § < > { } [\]

Handset display

The handset has three major display areas:

- Icon / text line
- Text lines (3)
- Soft key line

Figure 4: Handset display

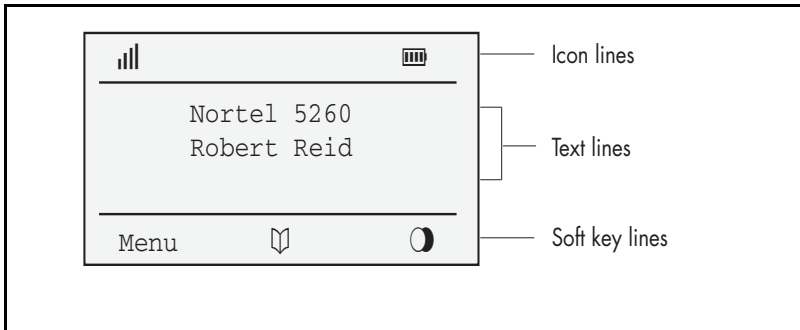

Icon/text line

The Icon/text line displays the current status of the handset during a telephone call or while in idle mode.

When using the menus, this line displays the name of the active menu. When the handset is in an idle state, this line is replaced with an icon line. Refer to Table 2 for handset status symbols.

Table 2: Symbols indicating handset status (Part 1 of 2)









Symbol	Status
	Ringer deactivated
	Caller filter active
	At least 2 bars: Good radio link

Table 2: Symbols indicating handset status (Part 2 of 2)

Symbol	Status
	Steady: handset has a connection Flashing: handset has an incoming call
	Steady: Handsfree is activated
	Flashing: Message in voice box
	Steady: One or more unread messages in the memory Flashing: Message memory full
	Charge status of the batteries
	Steady: Keypad is locked

Text lines

The three text lines are used to display menu lists, text messages, or information about the current connection status. Additionally, your system name, programmed name, and the telephone number of the handset are displayed on these lines. Figure 5 illustrates a menu list appearing in the handset screen display.

Figure 5: Menu appearing in handset screen display

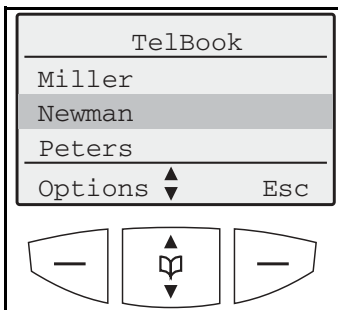

A feature menu's (for example, TelBook) selection list (for example, Miller, Newman, Peters) is displayed as a three-line excerpt. The lines can be moved up or down using the arrow keys. A selectable entry is shown inversely with a dark background.

Soft key line

Soft keys are located below the handset display screen. The functions allocated to the keys are shown on the bottom line of the display. The key functions change automatically according to the operation state of the handset.

Figure 6: Soft key line

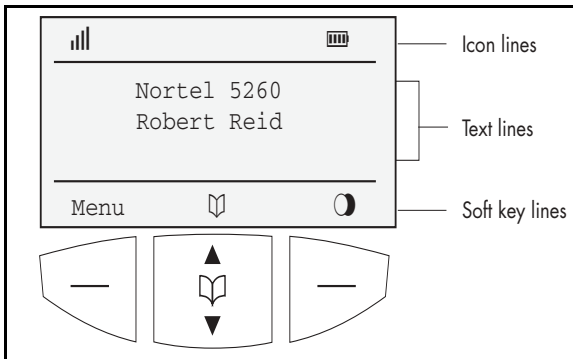

Menu

Use the Menu soft key to access the Menu list.



Use the Telephone Book soft key to access the Telephone Book.



Use the Redial soft key to access the Redial List.

OK soft key

Use the **OK** soft key to confirm the selected function. The **OK** soft key is used to switch between two options in a function. In the display area, only active settings are indicated by a check mark (✓).

Options soft key

Use the **Options** soft key to perform actions on the selected item in the current menu.

Esc soft key

Use the **Esc** soft key to quit the current menu selection. The selection of the previous menu branch or the current idle/connection display is shown. Press the **Esc** soft key for approximately two seconds to quit the present menu and return to the idly display.

Arrow soft keys

Symbols displayed above the arrow keys (up and down keys) identify the respective functionality of the arrow keys.



If continuous text is displayed (such as a message), the text can be scrolled up/down using the arrow keys.



When a selection list (such as Telephone Book of Menu) is displayed, the arrow keys move the cursor to the desired entry.



When entering telephone numbers and names, move the cursor keys left or right using the arrow keys.

Powering up your handset



Press and hold the **C** key for one second to turn the handset power on/off.

Security functions

The security functions are protected by a four-digit Personal Identification Number (PIN). The PIN is only necessary when the Read-only feature is active. The Security option enables you to change the PIN, set the handset to Read-only, and Reset the handset.

Change the PIN

The default setting for the PIN is **0 0 0 0**. The PIN acts as the user's signature to protect personal settings.

To change the PIN:

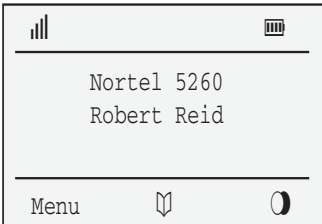

1. Press the **Menu** soft key.

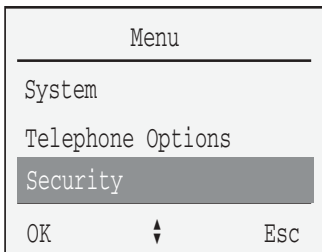

2. Press the **arrow** keys to scroll and highlight the **Security** option.

OK

3. Press the **OK** soft key.



4. Enter your PIN.

OK

5. Press the **OK** soft key.

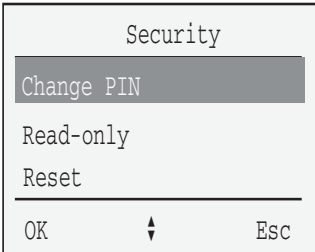

6. Press the arrow keys and scroll to highlight the **Change PIN** option.

OK

7. Press the **OK** soft key.



8. Enter the old PIN.

OK

9. Press the **OK** soft key.



10. Enter the new PIN.

OK

11. Press the **OK** soft key.



12. Re-enter the new PIN.

OK

13. Press the **OK** soft key.

Read-only

The Read-only feature is used to prevent other users from making changes to the handset settings. All menu features are activated, but personal settings are protected.

To activate Read-only:

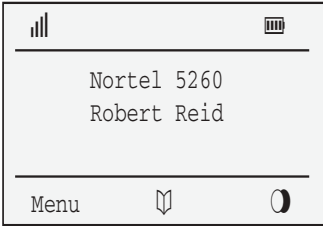

1. Press the **Menu** soft key.

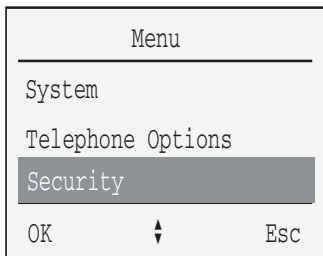

2. Press the arrow keys to scroll and highlight the **Security** option.

OK

3. Press the **OK** soft key.



4. Enter the PIN.

OK

5. Press the **OK** soft key.

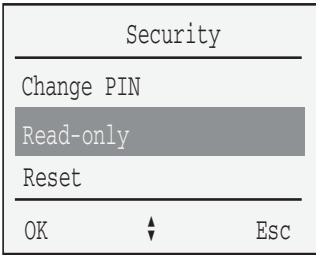

6. Press the arrow keys to scroll and highlight the **Read-only** option.

OK

7. Press the **OK** soft key.

Reset the handset

All settings, with the exception of the Telephone Book, the PIN, and the system registration are reset to the default settings.

To reset the handset:

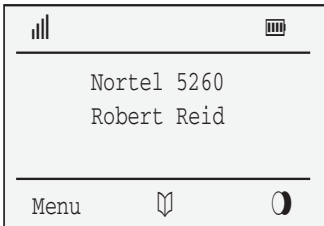

1. Press the **Menu** soft key.

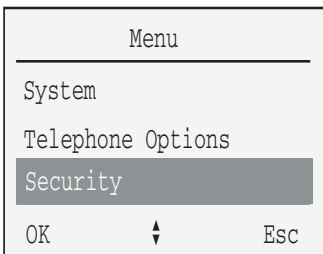

2. Press the **arrow** keys to scroll and highlight the **Security** option.

OK

3. Press the **OK** soft key.



4. Enter the PIN.

OK

5. Press the **OK** soft key.

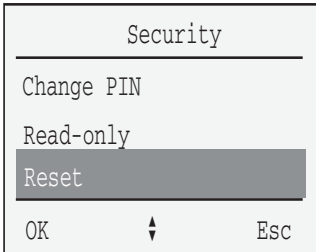

6. Press the **arrow** keys to scroll and highlight the **Reset** option.

OK

7. Press the **OK** soft key.

OK

8. At the **Sure?** prompt, choose one of the following:

- Press the **OK** soft key to accept
- Press the **Esc** soft key to decline

ESC

Configure options on the DECT Handset 4060

The Menu option enables you to configure the following handset preferences:

- Key Lock
- Ringer Settings
- Volume Settings
- Telephone Options

Key Lock

Use the Key Lock feature to disable key input. The keypad can be locked to prevent any accidental operation. Calls can be answered when the key lock is active. Once the call is terminated, the key lock is reactivated.

To lock the keypad Option 1:

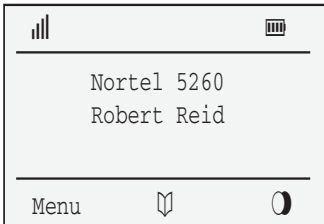

1. Press the **Menu** soft key.



2. Press the  key.

To lock the keypad Option 2:

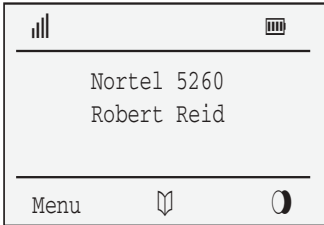

1. Press the **Menu** soft key.

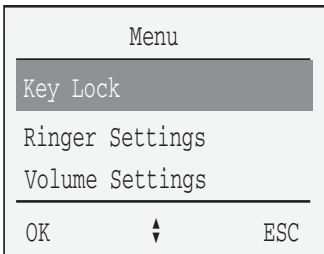

2. Press the **arrow** keys to scroll and highlight the **Key Lock** option.

OK

3. Press the **OK** soft key.

To unlock the keypad:

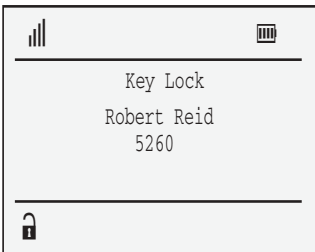

1. Press the **Key Lock** soft key.



2. Press the **#** key.

Ringer Settings

Use the Ringer Settings feature to configure the following options:

- Melody
- Type
- Device
- Volume Settings

Melody

Use the Melody option to set the ringer melody for different types of calls.

To select the ringer melody:

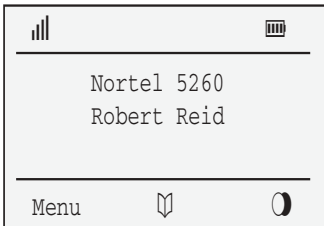

1. Press the **Menu** soft key.

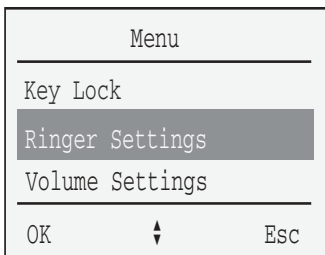

2. Press the **arrow** keys to scroll and highlight the **Ringer Settings** option.

OK

3. Press the **OK** soft key.

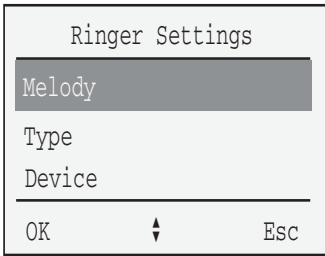

4. Press the **arrow** keys to scroll and highlight the **Melody** option.

OK

5. Press the **OK** soft key.

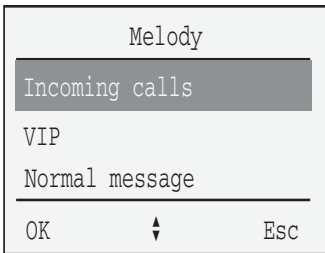

6. Press the **arrow** keys to scroll and highlight one of the following options:

- Incoming calls
- VIP
- Normal message
- Urgent message

OK

7. Press the **OK** soft key.

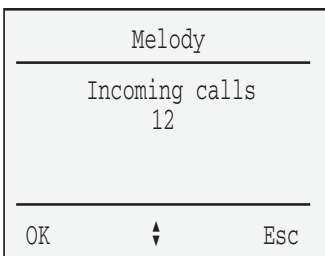

8. Press the **arrow** keys to scroll and highlight the melody number.



9. Choose one of the following:
 - Press the **arrow** keys to increase or decrease the melody number.
 - Use the keypad to enter the melody number.

Note: Enter a number between 1 and 60 to set the melody for each type of call.

OK

10. Press the **OK** soft key.

Ringer Type

Use the Ringer Type option to set the ringer to play a full melody or a short melody for an incoming call.

To select the ringer to play a full melody:

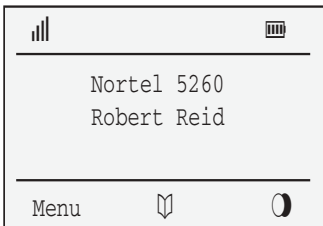

1. Press the **Menu** soft key.

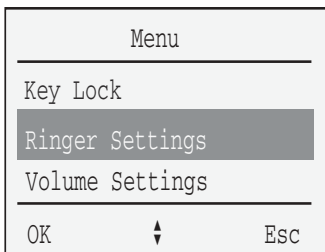

2. Press the **arrow** keys to scroll and highlight the **Ringer Settings** option.

OK

3. Press the **OK** soft key.

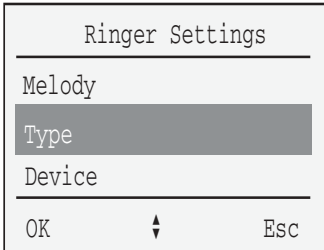

4. Press the **arrow** keys to scroll and highlight the **Type** option.

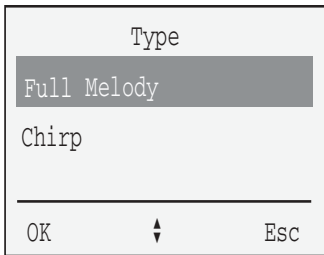

5. Press the **arrow** keys to scroll and highlight one of the following options:

- Full Melody
- Chirp

OK

6. Press the **OK** soft key.

Note: After pressing the OK soft key, a check mark “✓” appears to the left of the activated option.

Device

Use the Device menu option to select the ringer device.

To select the device ringer:

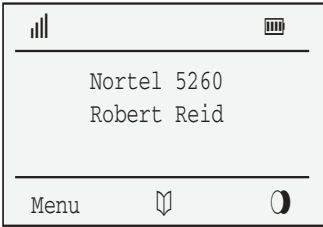

1. Press the **Menu** soft key.

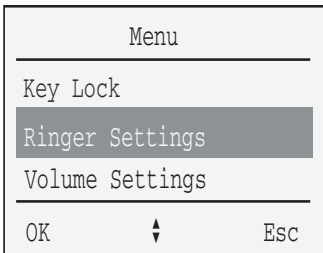

2. Press the **arrow** keys to scroll and highlight the **Ringer Settings** option.

OK

3. Press the **OK** soft key.

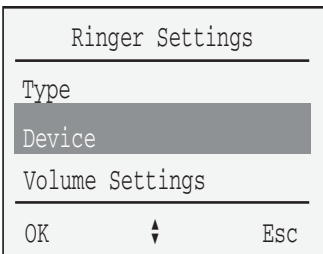

4. Press the **arrow** keys to scroll and highlight the **Device** option.

OK

5. Press the **OK** soft key.

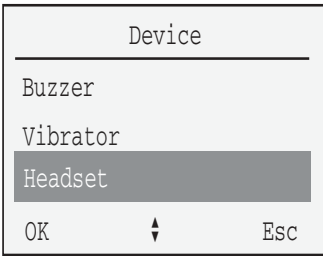

6. Press the **arrow** keys to scroll and highlight one of the following:

- Buzzer
- Vibrator
- Headset

OK

7. Press the **OK** soft key.

Note: A check mark “✓” indicates the selected option is activated.

Volume Settings

Use the Volume Settings option to set the volume for the ringer.

To set the volume for the ringer:

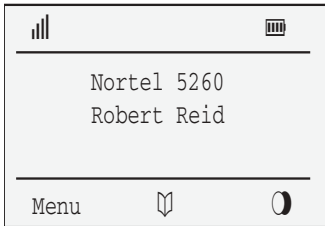

1. Press the **Menu** soft key.

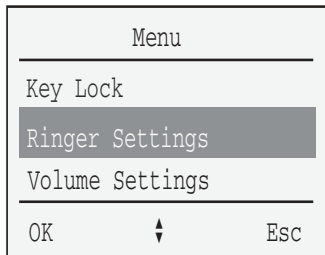

2. Press the **arrow** keys to scroll and highlight the **Ringer Settings** option.

OK

3. Press the **OK** soft key.

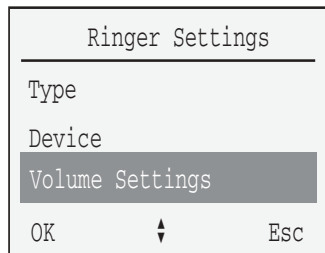

4. Press the **arrow** keys to scroll and highlight the **Volume Settings** option.

OK

5. Press the **OK** soft key.



6. Press the **arrow** keys to increase or decrease the volume.

OK

7. Press the **OK** soft key.

Volume Settings

Use the Volume Settings menu option to set the volume for the speaker phone and the ear piece.

To adjust the volume:

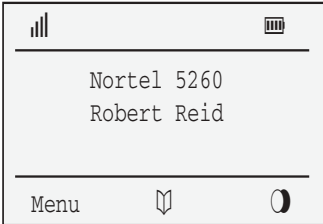

1. Press the **Menu** soft key.

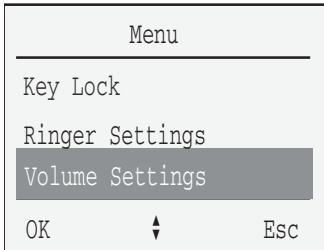

2. Press the **arrow** keys to scroll and highlight the **Volume Settings** option.

OK

3. Press the **OK** soft key.

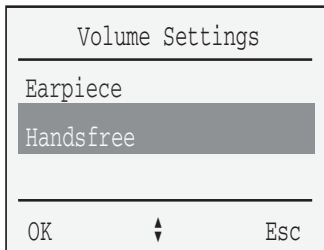

4. Press the **arrow** keys to scroll and highlight one of the following:
 - Ear piece
 - Handsfree

OK

5. Press the **OK** soft key.



6. Press the **arrow** keys to increase or decrease the volume.

OK

7. Press the **OK** soft key.

Telephone Options

Use the **Telephone Options** menu to activate the following functions on your handset:

- User Name
- Language
- Emergency Call
- Voice Box
- Attention Tones
- Silent Charging
- Charger Answer
- Auto Quick Hook
- Auto Answer
- Message Options
- Disp.Contrast

User Name

Use the User Name feature to store a name which appears on the idle display. The name can consist of a maximum 16 characters. See Table 1, "Handset keypad reference," on page 20 for information about using the keypad to enter characters.

To enter a user name:

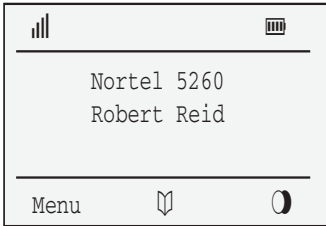

1. Press the **Menu** soft key.

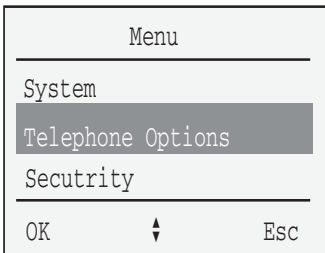

2. Press the **arrow** keys to scroll and highlight **Telephone Options**.

OK

3. Press the **OK** soft key.

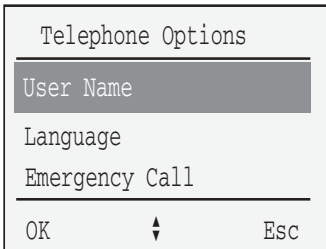

4. Press the **arrow** keys to scroll and highlight the **User Name** option.



5. Use the key pad to enter the user name characters.

OK

6. Press the **OK** soft key.

Language

Use the Language feature to set the display language. English is the default language.

To set the language:

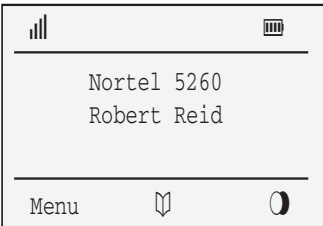

1. Press the **Menu** soft key.

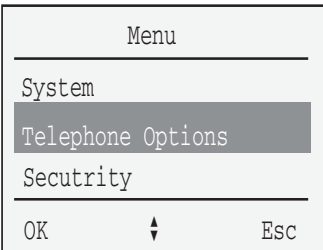

2. Press the **arrow** keys to scroll and highlight the **Telephone Options**.

OK

3. Press the **OK** soft key.

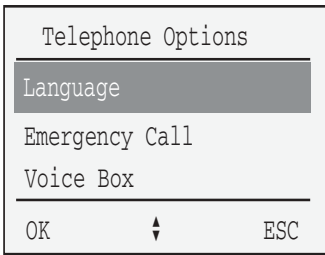

4. Press the **arrow** keys to scroll and highlight the **Language** option.

OK

5. Press the **OK** soft key.

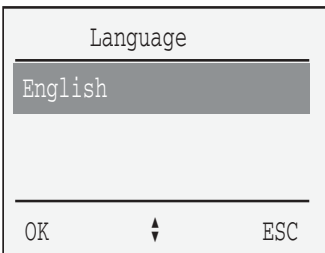

6. Press the **arrow** keys to scroll and highlight the preferred language.

OK

7. Press the **OK** soft key.

Emergency Call

Note: If you wish to use the SOS Emergency Voice Call feature ONLY, do not configure an Emergency Call message.

Only configure an Emergency Call Message if your DECT system supports Messaging.

Use the Emergency Call feature to store an emergency message (maximum of 160 characters) and the number to dial in the event of an emergency.

To store an Emergency Call message:

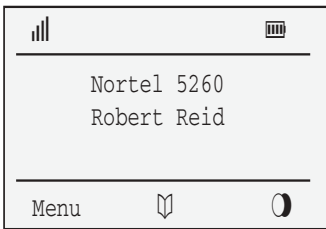

1. Press the **Menu** soft key.

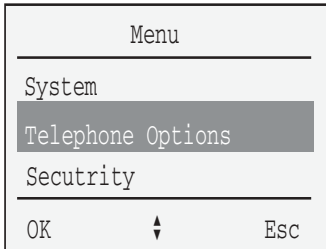

2. Press the **arrow** keys to scroll and highlight **Telephone Options**.

OK

3. Press the **OK** soft key.

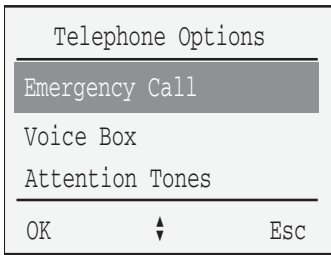

4. Press the **arrow** keys to scroll and highlight the **Emergency Call** option.

OK

5. Press the **OK** soft key.

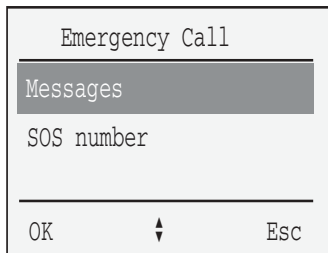

6. Press the **arrow** keys to scroll and highlight the **Messages** option.

OK

7. Press the **OK** soft key.



8. Use the keypad to enter the text of the message.

Note: Refer to Table 1 on page 20 for information about using the keypad to enter text.

OK

9. Press the **OK** soft key.

To store an SOS number:

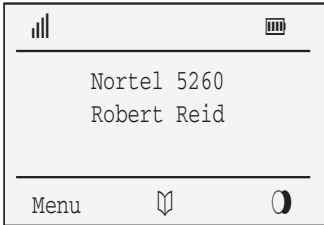

1. Press the **Menu** soft key.

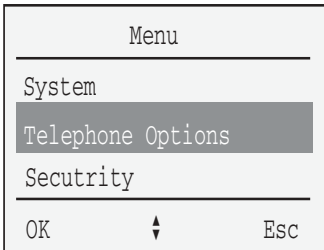

2. Press the **arrow** keys to scroll and highlight **Telephone Options**.

OK

3. Press the **OK** soft key.

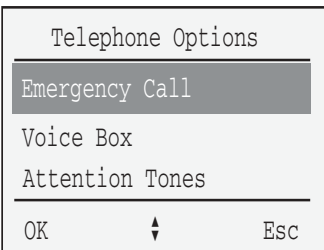

4. Press the **arrow** keys to scroll and highlight the **Emergency Call** option.

OK

5. Press the **OK** soft key.

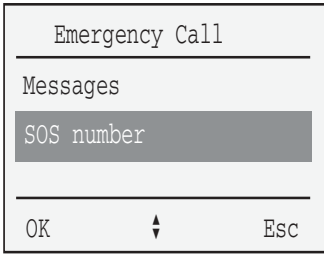

6. Press the **arrow** keys to scroll and highlight the **SOS number** option.

OK

7. Press the **OK** soft key.



8. Use the keypad to enter the **SOS** number.

OK

9. Press the **OK** soft key.

Voice Box

For automated access to your voicemail messages, Nortel Networks recommends you pre-configure the:

- voicemail access number
- voice box number
- voice box password

Pre-configuration automatically dials the voicemail access number, automatically enters your voice box number, and automatically enters your voice box password.

To pre-configure the voicemail access number, your voice box number, and your password:

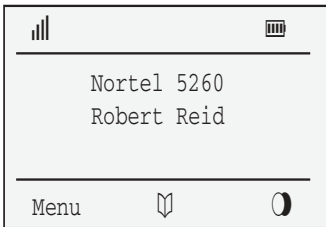

1. Press the **Menu** soft key.

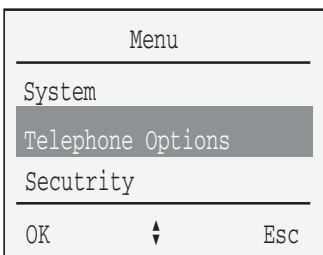

2. Press the **arrow** keys to scroll and highlight **Telephone Options**.

OK

3. Press the **OK** soft key.

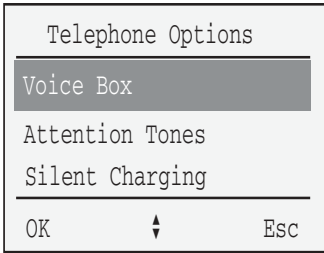



4. Press the **arrow** keys to scroll and highlight the **Voice Box** option.

OK

5. Press the **OK** soft key.



6. Enter the following:
- Voicemail access number
 - P (long pause) — hold down “0” key for longer than 2 seconds
 - Voice box number
 - 
 - Voice box password (optional) followed by 

OK

7. Press the **OK** soft key.

Attention Tones

Use the Attention Tones feature to configure the handset to emit an acoustic warning when a key is pressed, when there is a danger of losing the radio link, when the battery charge is too low, when a setting is confirmed, and when the end of a menu is displayed.

To configure Attention Tones:

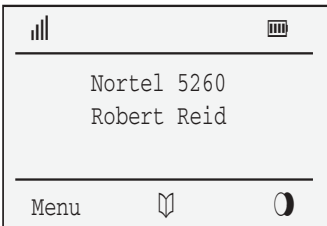

1. Press the **Menu** soft key.

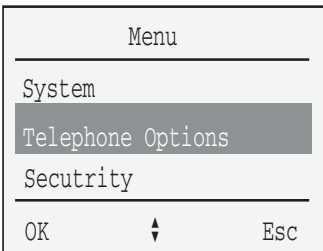

2. Press the **arrow** keys to scroll and highlight **Telephone Options**.

OK

3. Press the **OK** soft key.

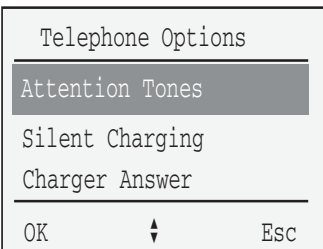

4. Press the **arrow** keys to scroll and highlight the **Attention Tones** option.

OK

5. Press the **OK** soft key.

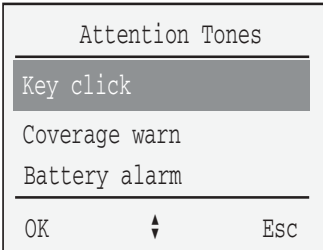

6. Press the **arrow** keys to scroll and highlight one of the following:

- Key click
- Coverage warn
- Battery alarm
- Confirm tones
- End of menu

OK

7. Press the **OK** soft key.

Note: A check mark “✓” indicates the selected option is activated.

Silent Charging

Use the Silent Charging feature to automatically turn off the ringer while the handset is charging.

To activate Silent Charging:

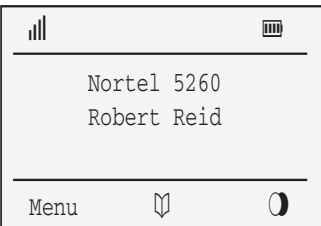

1. Press the **Menu** soft key.

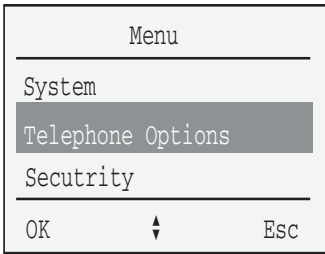

2. Press the **arrow** keys to scroll and highlight **Telephone Options**.

OK

3. Press the **OK** soft key.

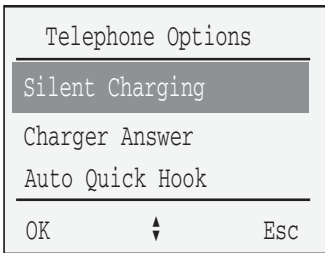

4. Press the **arrow** keys to scroll and highlight the **Silent Charging** option.

OK

5. Press the **OK** soft key.

Note: A check mark “✓” indicates the selected option is activated.

To deactivate Silent Charging:

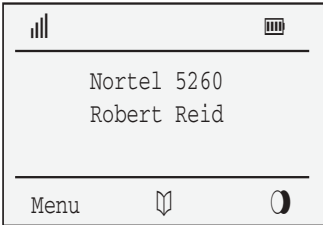

1. Press the **Menu** soft key.

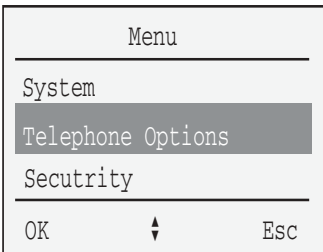

2. Press the **arrow** keys to scroll and highlight **Telephone Options**.

OK

3. Press the **OK** soft key.

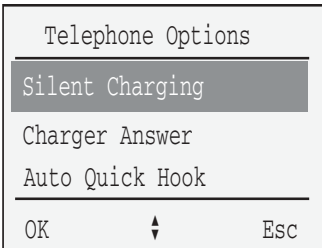

4. Press the **arrow** keys to scroll and highlight the **Silent Charging** option.

OK

5. Press the **OK** soft key.

Note: A check mark "✓" indicates the selected option is activated.

Charger Answer

Use the Charger Answer feature to answer an incoming call by lifting the handset out of the charger. The call is ended again by pressing the  key or by placing the handset on the charger.

To activate Charger Answer:

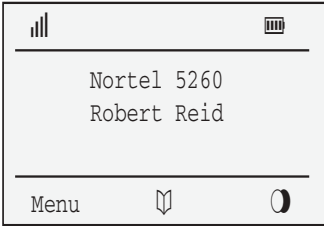

1. Press the **Menu** soft key.

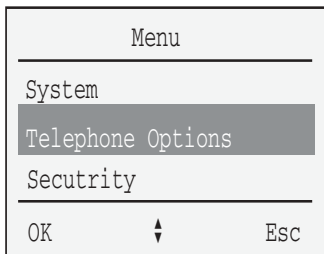

2. Press the **arrow** keys to scroll and highlight **Telephone Options**.

OK

3. Press the **OK** soft key.

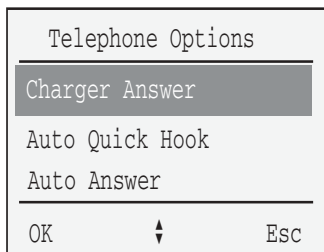

4. Press the **arrow** keys to scroll and highlight the **Charger Answer** option.

OK

5. Press the **OK** soft key.

Note: A check mark “✓” indicates the selected option is activated.

To deactivate Charger Answer:

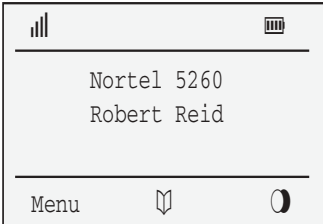

1. Press the **Menu** soft key.

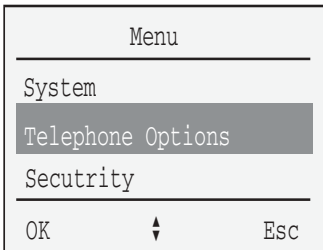

2. Press the **arrow** keys to scroll and highlight **Telephone Options**.

OK

3. Press the **OK** soft key.

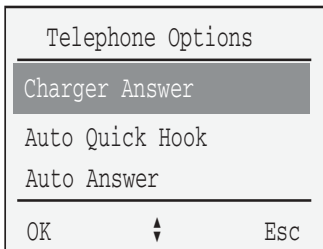

4. Press the **arrow** keys to scroll and highlight the **Charger Answer** option.

- OK 5. Press the **OK** soft key.

Auto Quick Hook

Use the Auto Quick Hook feature to enable a Quick Call number to be dialed automatically.

To activate Auto Quick Hook:

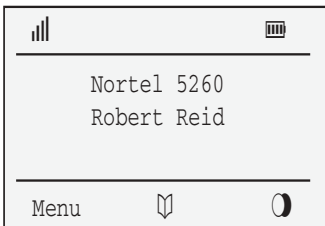

1. Press the **Menu** soft key.

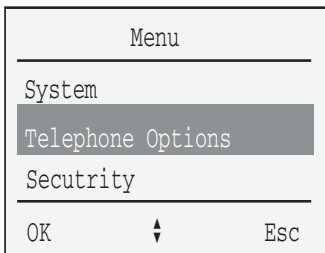

2. Press the **arrow** keys to scroll and highlight **Telephone Options**.

- OK 3. Press the **OK** soft key.

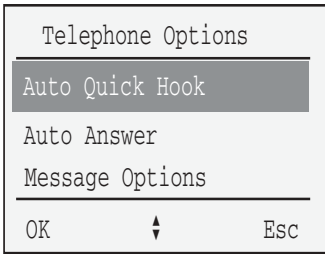

4. Press the **arrow** keys to scroll and highlight the **Auto Quick Hook** option.

OK

5. Press the **OK** soft key.

Note: A check mark “✓” indicates the selected option is activated.

To deactivate Auto Quick Hook:

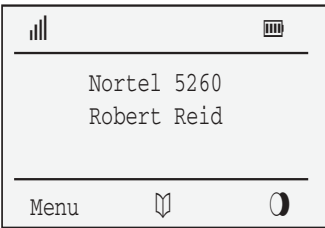

1. Press the **Menu** soft key.

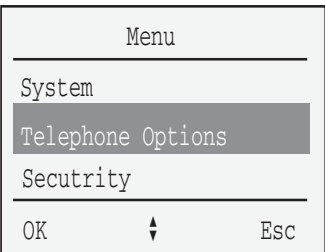

2. Press the **arrow** keys to scroll and highlight **Telephone Options**.

OK

3. Press the **OK** soft key.

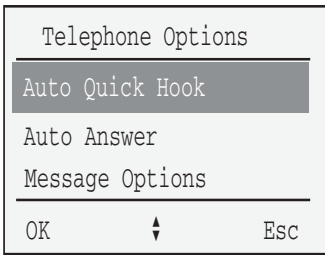

4. Press the **arrow** keys to scroll and highlight the **Auto Quick Hook** option.

OK

5. Press the **OK** soft key.

Auto Answer

Use the Auto Answer feature to configure the handset to automatically answer an incoming call after one ringer alert signal. The Auto Answer function only works when the headset is connected.

To activate Auto Answer:

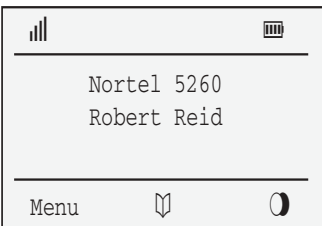

1. Press the **Menu** soft key.

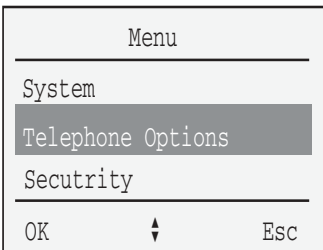

2. Press the **arrow** keys to scroll and highlight **Telephone Options**.

OK

3. Press the **OK** soft key.

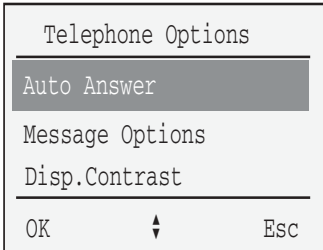

4. Press the **arrow** keys to scroll and highlight the **Auto Answer** option.

OK

5. Press the **OK** soft key.

Note: A check mark "✓" indicates the selected option is activated.

To deactivate Auto Answer:

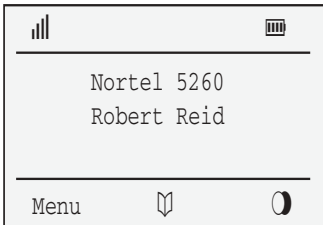

1. Press the **Menu** soft key.

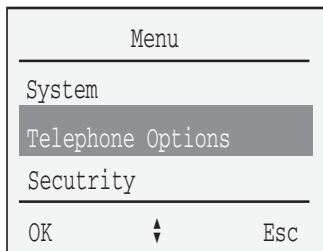

2. Press the **arrow** keys to scroll and highlight **Telephone Options**.

OK

3. Press the **OK** soft key.

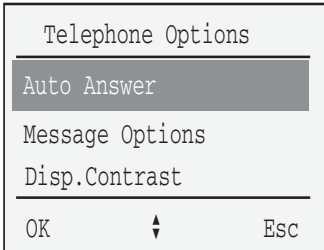

4. Press the **arrow** keys to scroll and highlight the **Auto Answer** option.

OK

5. Press the **OK** soft key.

Disp. Contrast

Use the Disp.Contrast feature to adjust the display contrast.

To adjust the display contrast:

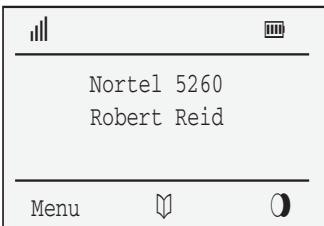

1. Press the **Menu** soft key.

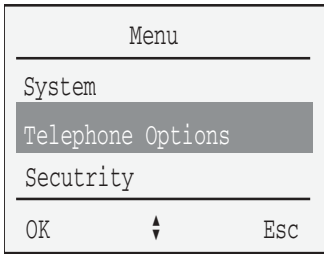

2. Press the **arrow** keys to scroll and highlight **Telephone Options**.

OK

3. Press the **OK** soft key.

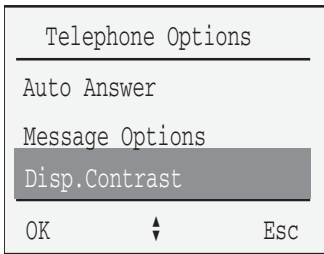

4. Press the **arrow** keys to scroll and highlight **Disp. Contrast** option.

OK

5. Press the **OK** soft key.



6. Press the **arrow** keys to increase or decrease the display contrast.











OK

7. Press the **OK** soft key.

Menu Shortcuts

To use a menu shortcut on an idle handset, press one of the key combinations displayed in Table 3.

Table 3: Key combinations

Feature	Key	Description
Ringer on/off	Menu 	Ringer off
	Menu 	Ringer on
Silent Charging on/off	Menu 	Silent Charging on
	Menu 	Silent Charging off
User Name	Menu 	Change the User Name
Caller Filter Accept List	Menu 	Caller Filter Accept List activated.
Caller Filter Block List	Menu 	Caller Filter Block List activated.
Caller Filter Off	Menu 	Caller Filter off
Buzzer	Menu 	Buzzer on/off
Key Lock	Menu 	Key lock on/off

Make a Call



Press and hold the **C** key to turn the handset on and off.

Option 1 - On-hook dialing



1. Press the **Hook** key.



2. Enter the number.



3. Press the **Hook** key to end the call.

Option 2 - Off-hook dialing



1. Enter the number.



2. Press the **Hook** key.



3. Press the **Hook** key to end the call.

Option 3 - Handsfree dialing



1. Press the **Handsfree** key.



2. Enter the number.



3. Press the **Hook** key to end the call.

Make an SOS call

You can make an SOS Emergency Voice call or send a previously stored Emergency Call Text message to a certain telephone number.

If an Emergency Call Message has been configured (as on page 45), this will take priority over an SOS Emergency Voice Call.

If you wish to use the SOS Emergency Voice Call feature only, do not configure an Emergency Call message.



Press and hold the **R** (Recall) key for longer than two seconds.

Answer or reject a call

This section describes how to:

- answer a call
- reject a call
- mute the handset ringer

Answer a call

When you have an incoming call, your DECT Handset 4060:

- emits an audible signal (for example, short or full melody, vibrate or buzzer)
- displays an incoming caller's name and number (if listed in the Telephone Book)
- displays a flashing handset icon 
- handsfree button flashes

To answer a call:



Charger Answer

Choose one of the following:

- Press the **Hook** key.
- Press the **Handsfree** key.
- **Charger Answer**
Remove the handset from the charger (if Charger Answer is active).

Reject a call

Use the Reject feature to decline an incoming call.

To reject a call – Option 1:

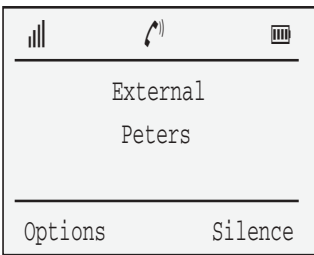

1. Press the **Silence** soft key.

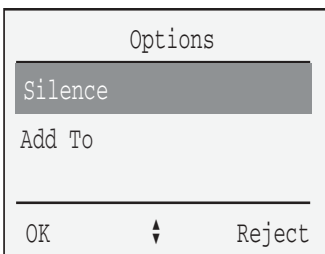

2. Press the **Reject** soft key.

To reject a call – Option 2:

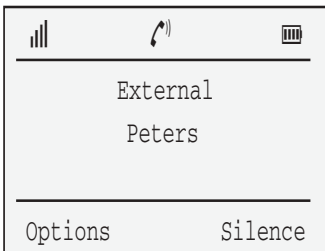

1. Press the **Options** soft key.

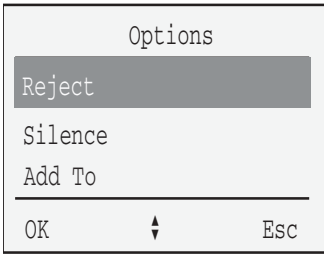

2. Press the **arrow** keys to scroll and highlight the **Reject** option.

OK

3. Press the **OK** soft key.

Mute the handset ringer

Use the Mute feature to turn off the handset ringer.

To mute the ringer – Option 1:

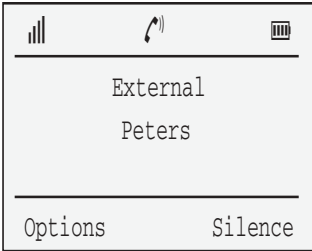

Press the **Silence** soft key.

To mute the ringer – Option 2:

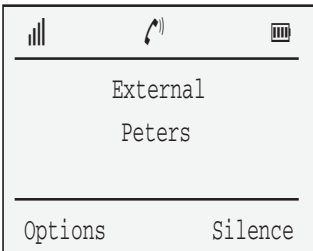

1. Press the **Options** soft key.

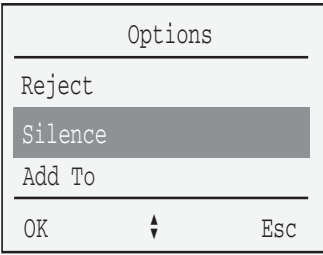

2. Press the **arrow** keys to scroll and highlight the **Silence** option.

OK

3. Press the **OK** soft key.

While on an active call

During and active call, you can:

- place a call on hold
- retrieve a call on hold
- transfer a call
- use handsfree
- mute a call

Place a call on hold

To place a call that is on hold:



Press the **R** (Recall) key.

Retrieve a call on hold

To retrieve a call that is on hold:



Press the **R** (Recall) key.

Transfer a call

To use the Transfer feature to redirect a call to a third party



1. Press the **R** (Recall) key.



2. Enter the number to which the call is to be transferred.

Note: You can speak to the third party before transferring the call.



3. Press the **R** (Recall) key to transfer the call to the third party.

Note: If the third party does not answer, press the **R** (Recall) key again to reconnect to the original call.



4. Press the **Hook** key to disconnect from the call.

Note: You can disconnect from the call before the third party answers (Blind transfer).

Use Handsfree

Use the Handsfree feature to communicate with the call party while you work. Before using the optional headset, activate Handsfree.

Place the handset upright on a smooth, flat surface, leaving the microphone and loudspeaker free of obstruction. Maintain a maximum distance of 0.5 m between you and the handset when speaking.

To activate Handsfree:



Press the **Handsfree** key.

To end a handsfree call:



Press the **Hook** key.

To switch from handsfree to handset:



Press the **Handsfree** key.

Mute a call

Use the Mute feature to listen to the receiving party without transmitting.

To mute an active call – Option 1:

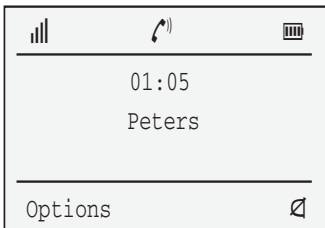

Press the **Mute** soft key.

To mute an active call – Option 2:

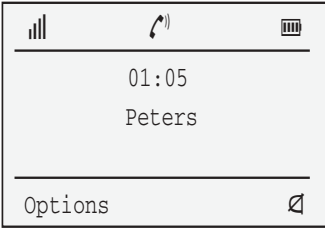

1. Press the **Options** soft key.

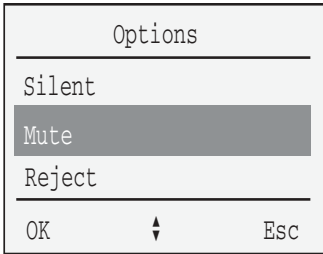

2. Press the **arrow** keys to scroll and highlight the **Mute** option.

OK

3. Press the **OK** soft key.

To return to a two-way conversation – Option 1:

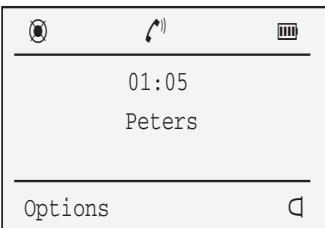

Press the **Unmute** soft key.

To return to a two-way conversation – Option 2:

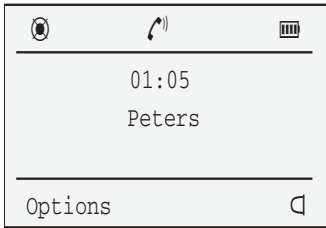

1. Press the **Options** soft key.

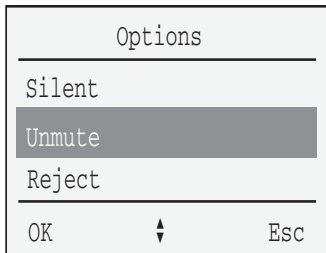

2. Press the **arrow** keys to scroll and highlight the **Unmute** option.

OK

3. Press the **OK** soft key.

Talk with more than one person

This section describes the conference feature that enables conversation between a maximum of three conferees.

Set up a conference call

Use a conference call to enable a conversation between three people. One caller initiates the conference call and connects the other conferees. When the conference call initiator ends the call, all parties are disconnected from the conference call.

To set up a conference call – Option 1:



1. Press the **Hook** key.



2. Enter the number.



3. Press the **R** (Recall) key.



4. Enter the number.



5. Press the **R** (Recall) key.

Note: If the person you attempted to add to the conference is unavailable, press the **R** (Recall) key again to return to a two-way conference.



6. Press the **Hook** key to end the conference call.

To set up a conference call – Option 2 (Pre-dial):



1. Enter the number.



2. Press the **Hook** key.



3. Press the **R** (Recall) key.



4. Enter the number.



5. Press the **R** (Recall) key.

Note: If the person you attempted to add to the conference is unavailable, press the **R** (Recall) key again to return to a two-way conference.



6. Press the **Hook** key to end the call.

To set up a conference call – Option 3 (Handsfree):



1. Press the **Handsfree** key.



2. Enter the number.



3. Press the **R** (Recall) key.



4. Enter the number.



5. Press the **R** (Recall) key.

Note: If the person you attempted to add to the conference is unavailable, press the **R** (Recall) key again to return to a two-way conference.



6. Press the **Hook** key to end the call.

Create a Telephone Book

The Telephone Book feature allows you to store a maximum of 100 alphabetized entries consisting of names and telephone numbers. Each entry can have a maximum of 16 characters in the name, and a maximum of 32 digits in the telephone number.

While creating a Telephone Book, please consider the following information:

- a telephone number cannot be stored without a name
- a name can be entered only once
- a duplicate telephone number can only be stored using different names
- a dashed line indicates the beginning and end of the Telephone Book list

Add, edit, and delete entries

Use the following procedures to add, edit, and delete Telephone Book entries.

To add a name and number:

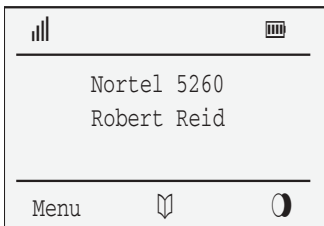

1. Press the **Telephone Book** soft key.

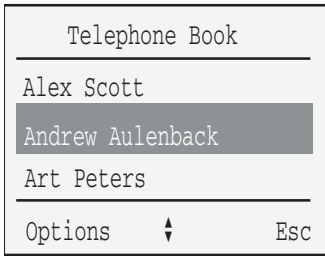

2. Press the **Options** soft key.

Note: The directory shows the first three names in the Telephone Book.

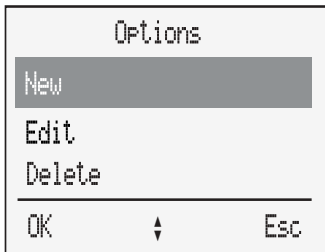

3. Press the **arrow** keys to scroll and highlight the **New** option.

OK

4. Press the **OK** soft key.



5. Enter the telephone number to be stored.

OK

6. Press the **OK** soft key.



7. Use the keypad to enter the name. For more information about using the keypad to enter text, refer to Table 1 on page 20.

OK

8. Press the **OK** soft key.

To edit an entry:

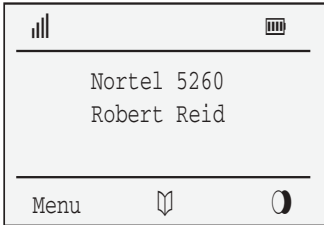

1. Press the **Telephone Book** soft key.

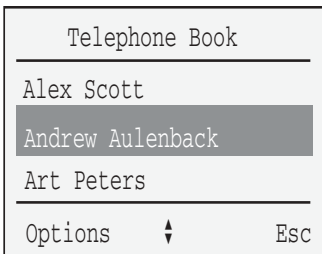

2. Press the **arrow** keys to scroll and highlight the name.

Note: The directory shows the first three names in the Telephone Book.

Options

3. Press the **Options** soft key.

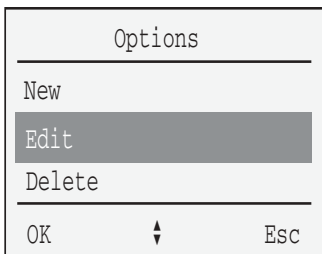

4. Press the **arrow** keys to scroll and highlight the **Edit** option.

OK

5. Press the **OK** soft key.

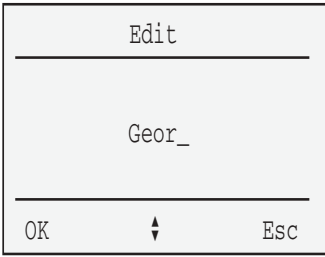

6. Press the **arrow** keys to move the cursor to the letter to be edited.

OK

7. Press the **OK** soft key.

To delete a name and number:

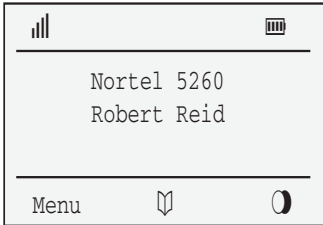

1. Press the **Telephone Book** soft key.

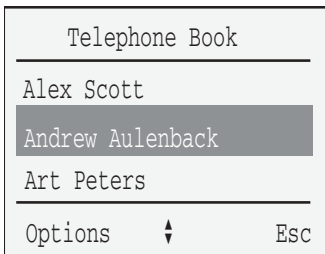

2. Press the **arrow** keys to scroll and highlight the name.

Note: The directory shows the first three names in the Telephone Book.

Options

3. Press the **Options** soft key.

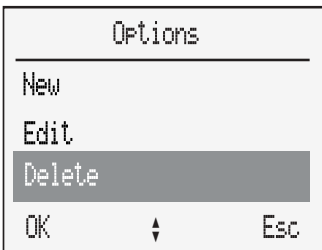

4. Press the **arrow** keys to scroll and highlight the **Delete** option.

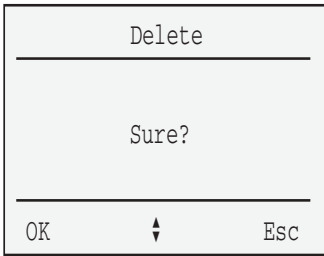

5. At the **Sure?** prompt, choose one the following:

- Press the **OK** soft key to accept.
- Press the **Esc** soft key to decline.

To delete all entries in the Telephone Book:

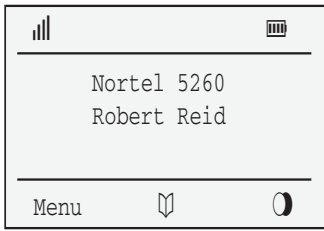

1. Press the **Telephone Book** soft key.

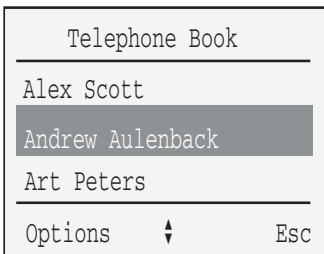

2. Press the **Options** soft key.

Note: The directory shows the first three names in the Telephone Book.



3. Press the **arrow** keys to scroll and highlight the **Delete All** option.

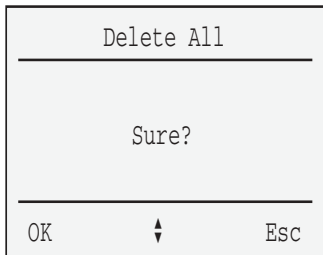

4. At the **Sure?** prompt, choose one of the following:
- Press the **OK** soft key to accept.
 - Press the **Esc** soft key to decline.

Make a call using the Telephone Book

Use one of the following options to make a call using the Telephone Book.

To search for a name and make a call – Options 1:

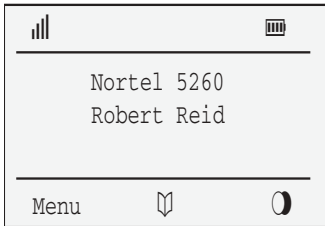

1. Press the **Telephone Book** soft key.

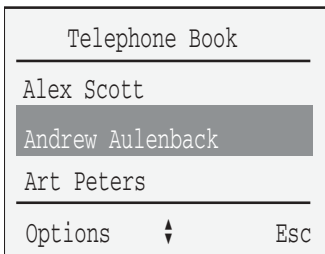

2. Press the **arrow** keys to scroll and highlight the name to be dialed.



3. Press the **Hook** key.

To search for a name and make a call – Option 2:

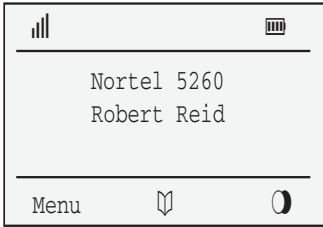

1. Press the **Telephone Book** soft key.



2. Use the keypad to enter a single letter, (for example “A”, or several letters such as “ART”. See Table 3, “Key combinations,” on page 63).

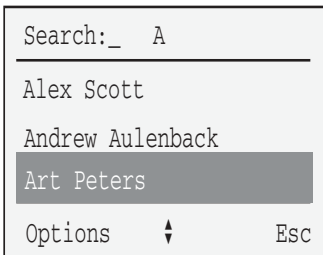

3. Press the **arrow** keys to scroll and highlight the name.



4. Press the **Hook** key.

Use the Caller List

The Caller List automatically stores up to a maximum of 20 accepted and missed calls. Consider the following information:

- after 20 entries have been stored to the Caller List, each additional accepted or missed call overwrites the oldest entry
- when a call back is successfully executed for a Caller List entry, the entry is removed from the Caller List
- multiple calls from the same telephone number appear only once in the Caller List with the time stamp of the last call
- when calls have been missed, the text “Missed Calls” is shown in the display
- each call is marked with a time stamp (if supported on your system); you can monitor the time stamp for each call using the **Details** soft key

Use the Caller List to:

- display details about accepted or missed calls (for example, name and telephone number of caller, type of call)
- dial accepted or missed calls
- transfer telephone numbers to the Telephone Book



Caller List symbols

The following table defines symbols that appear in front of Caller List entries to indicate the type of call:

Table 4: Caller List symbols (Part 1 of 2)

Symbol	Type of call
?	Missed call
✓	Accepted call

Table 4: Caller List symbols (Part 2 of 2)

Symbol	Type of call
	Filtered call Note: For details on Filtered calls, refer “Filter Options” on page 118
	Rejected call Note: For details on Rejected calls, refer to “To reject a call – Option 1:” on page 67.
	Answered call using the Auto Answer feature.

Access and use the Caller List

This section describes how to:

- access the Caller List
- dial a telephone number using the Caller List
- delete a Caller List entry or delete all entries
- transfer a Caller List entry to the Telephone Book

To access the Caller List:



1. Press the **Info** key.

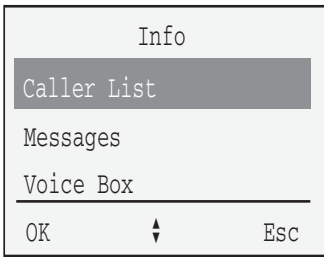

2. Press the **arrow** keys to scroll and highlight the **Caller List** option.

OK

3. Press the **OK** soft key.

Esc

4. Press the **Esc** soft key to exit the **Caller List**.

To dial a telephone number using the Caller List:



1. Press the **Info** key.

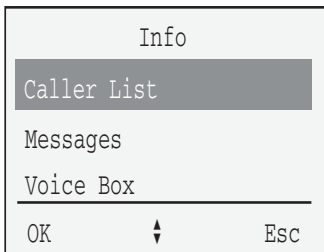

2. Press the **arrow** keys to scroll and highlight the **Caller List** option.

OK

3. Press the **OK** soft key.

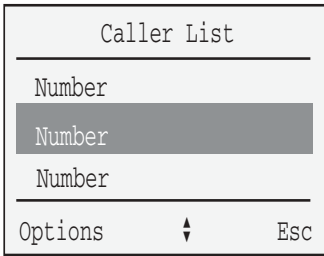

4. Press the **arrow** keys to scroll and highlight a telephone number.



5. Press the **Hook** key to dial the number.

To delete an entry from the Caller List:



1. Press the **Info** key.

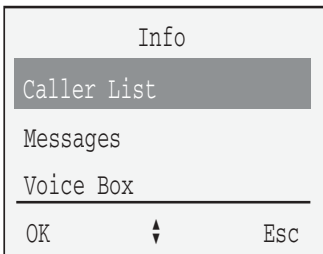

2. Press the **arrow** keys to scroll and highlight the **Caller List** option.

OK

3. Press the **OK** soft key.

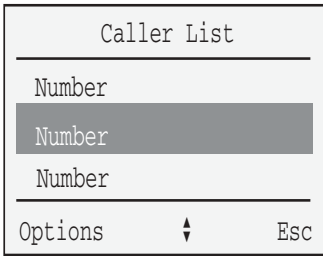

4. Press the **arrow** keys to scroll and highlight a telephone number.

Options

5. Press the **Options** soft key.

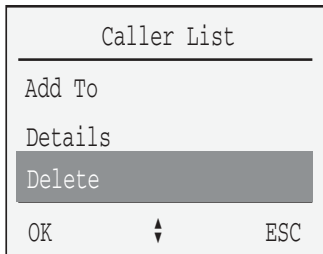

6. Press the **arrow** keys to scroll and highlight the **Delete** option.

OK

7. Press the **OK** soft key.

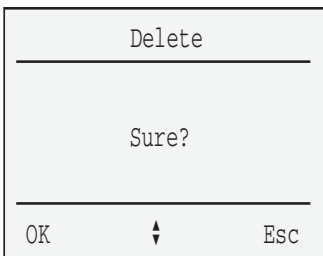

8. At the **Sure?** prompt, choose one of the following:

- Press the **OK** soft key to accept.
- Press the **Esc** soft key to decline.

To delete all entries in the Caller List:



1. Press the **Info** key.

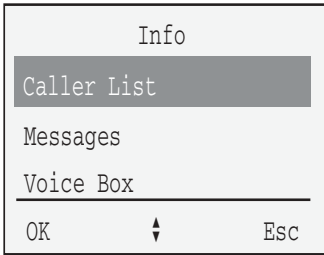

2. Press the **arrow** keys to scroll and highlight the **Caller List** option.

OK

3. Press the **OK** soft key.

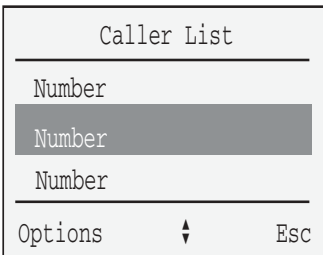

4. Press the **arrow** keys to scroll and highlight a telephone number.

Options

5. Press the **Options** soft key.

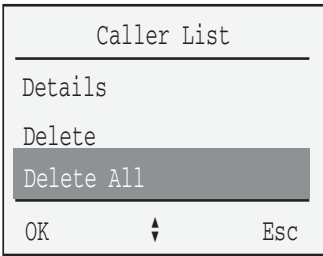

6. Press the **arrow** keys to scroll and highlight the **Delete All** option.

OK

7. Press the **OK** soft key.

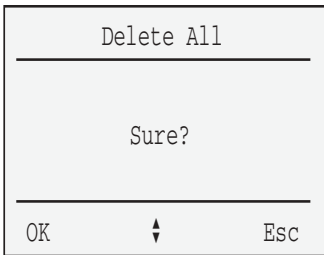

8. At the **Sure?** prompt, choose one of the following:

- Press the OK soft key to accept.
- Press the Esc soft key to decline.

To transfer a number from the Caller List to the Telephone Book:



1. Press the **Info** key.

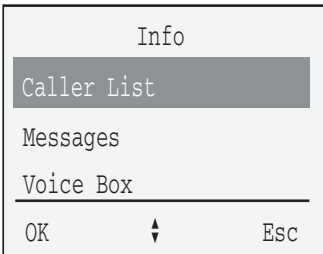

2. Press the **arrow** keys to scroll and highlight the **Caller List** option.

OK

3. Press the **OK** soft key.

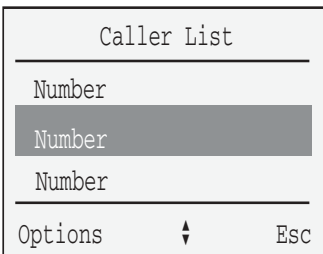

4. Press the **arrow** keys to scroll and highlight a telephone number.

Options

5. Press the **Options** soft key.

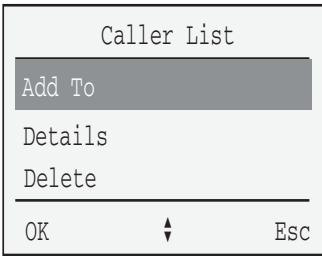

6. Press the **arrow** keys to scroll and highlight the **Add To** option.

OK

7. Press the **OK** soft key.

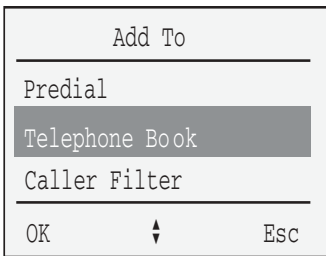

8. Press the **arrow** keys to scroll and highlight the **Telephone Book** option.

OK

9. Press the **OK** soft key.



10. Use the keypad to edit the telephone number.

OK

11. Press the **OK** soft key.



12. Use the keypad to enter the name associated with the telephone number.

OK

13. Press the **OK** soft key.

Use the Redial List

A maximum of 20 previously dialed telephone numbers are automatically stored in the Redial List.

Use the Redial List to:

- display details about previously dialed telephone numbers (for example, telephone numbers dialed)
- redial previously dialed telephone numbers
- transfer telephone numbers to the Telephone Book

Access and use the Redial List

To access the Redial List:

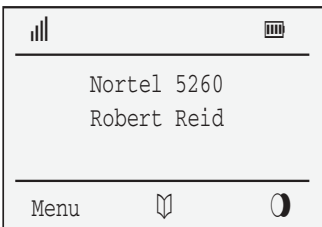

1. Press the **Redial** soft key.

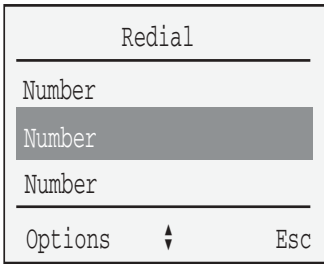

2. Press the **arrow** keys to scroll and highlight the number.

Esc

3. Press the **Esc** soft key to exit the Redial list.

To dial a telephone number from the Redial List:

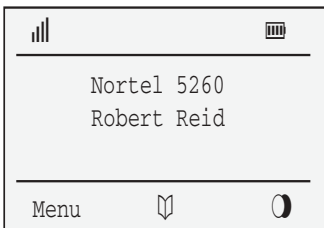

1. Press the **Redial** soft key.

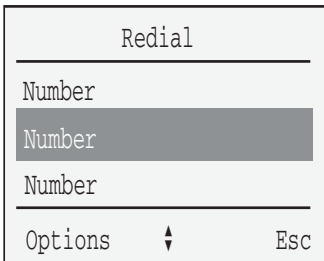

2. Press the **arrow** keys to scroll and highlight a telephone number.



3. Press the **Hook** key.

To delete an entry from the Redial List:

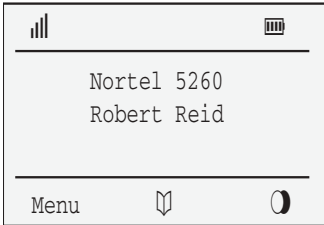

1. Press the **Redial** soft key.

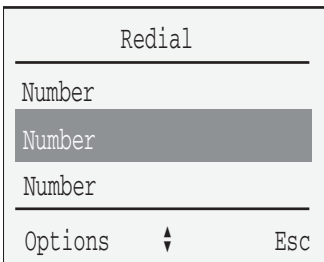

2. Press the **arrow** keys to scroll and highlight a telephone number.

Options

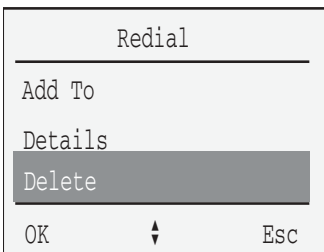

3. Press the **Options** soft key.
4. Press the **arrow** keys to scroll and highlight the **Delete** option.

OK

5. Press the **OK** soft key.

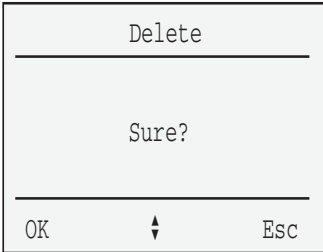

6. At the **Sure?** prompt, choose one of the following:
- Press the **OK** soft key to accept.
 - Press the **Esc** soft key to decline.

To delete all entries in the Redial list:

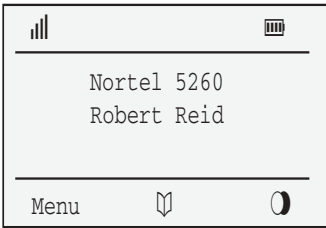

1. Press the **Redial list** soft key.

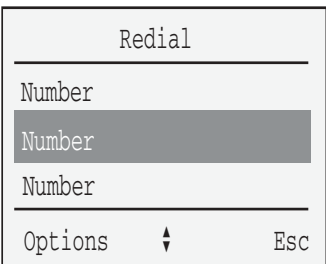

2. Press the **arrow** keys to scroll and highlight a telephone number.

OK

3. Press the **OK** soft key.

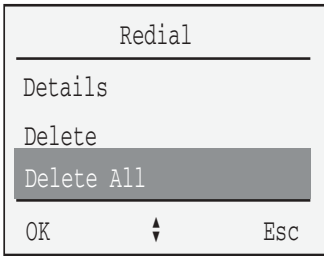

4. Press the **arrow** keys and scroll to highlight the **Delete All** option.

OK

5. Press the **OK** soft key.

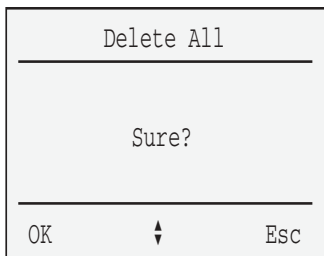

6. At the **Sure?** prompt, choose one of the following:
- Press the **OK** soft key to accept.
 - Press the **Esc** soft key to decline.

To transfer a number from the Redial List to the Telephone Book:

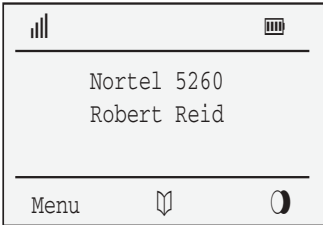

1. Press the **Redial** soft key.

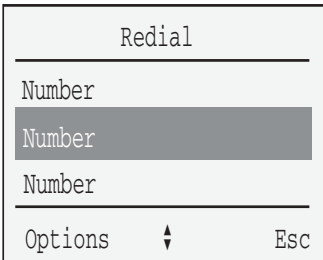

2. Press the **arrow** keys to scroll and highlight a telephone number.

Options

3. Press the **Options** soft key.

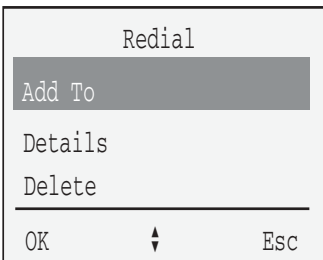

4. Press the **arrow** keys to scroll and highlight the **Add To** option.

OK

5. Press the **OK** soft key.

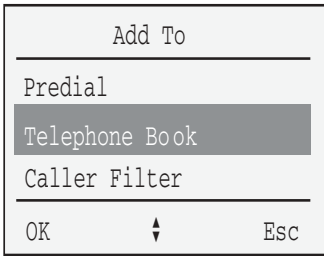

6. Press the **arrow** keys to scroll and highlight the **Telephone Book** option.

OK

7. Press the **OK** soft key.



8. Edit the number.

OK

9. Press the **OK** soft key.



10. Edit the name

OK

11. Press the **OK** soft key.

Use Quick Call

Use the Quick Call feature to place calls by dialing a one-digit code. You can create a maximum of nine Quick Call numbers.

To create a Quick Call number:

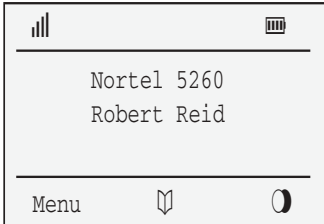

1. Press the **Telephone Book** soft key.

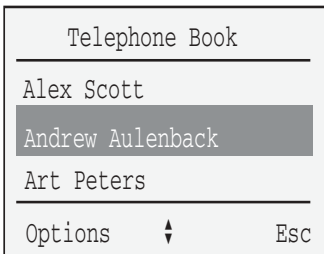

2. Press the **arrow** keys to scroll and highlight an entry in the **Telephone Book**.

Options

3. Press the **Options** soft key.

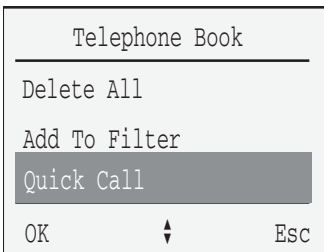

4. Press the **arrow** keys to scroll and highlight the **Quick Call** option.

OK

5. Press the **OK** soft key.6. Enter a digit from 1 to 9 as the **Quick Call** number.

OK

7. Press the **OK** soft key.

Note: The **Telephone Book** entry shows the assigned **Quick Call** number in front of the name.

To make a call using Quick Call:



Press and hold the assigned **Quick Call** number key.

Note: The above scenario depends on the settings in the **Telephone Option > Auto > Quick Hook** menu.

To delete a Quick Call number assignment:

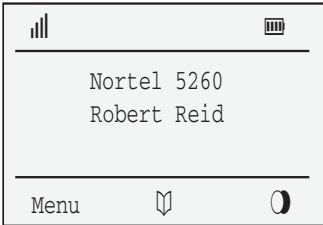

1. Press the **Telephone Book** soft key.

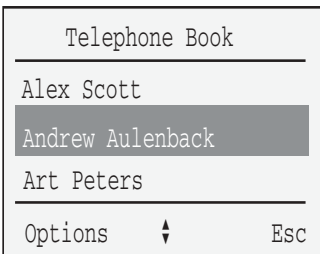

2. Press the **arrow** keys to scroll and highlight the entry.

Options

3. Press the **Options** soft key.

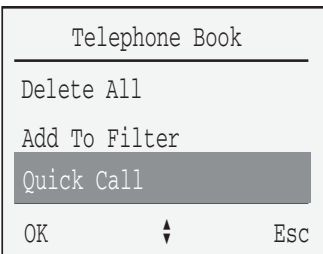

4. Press the arrow keys to scroll and highlight the **Quick Call** option.

OK

5. Press the **OK** soft key.



6. Press the  to delete the **Quick Call** number.

OK

7. Press the **OK** soft key.

Use Caller Filter

Use the Caller Filter feature to accept or block incoming calls. Numbers must be stored in the Caller Filter before using the filter functions. A maximum of 10 telephone numbers can be assigned to the Caller Filter list.

Note: Caller Filter does not work for forwarded calls. This feature is not available for Text Messaging.

List of numbers

If you select the List of numbers option, a list of the numbers you have already filtered is displayed. If the list of numbers is empty, then the word “Empty” is displayed.

Use the List of numbers feature to:

- add a new entry
- edit an existing entry
- delete an entry
- delete the entire Caller Filter list

To add an entry to the Caller Filter list when the list is empty:

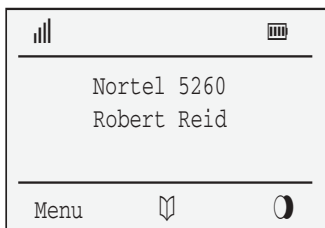

1. Press the **Menu** soft key.

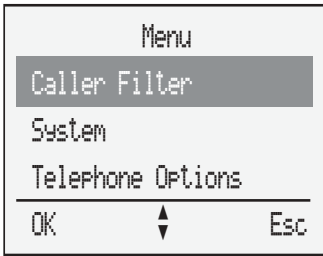

2. Press the **arrow** keys to scroll and highlight the **Caller Filter** option.

OK

3. Press the **OK** soft key.

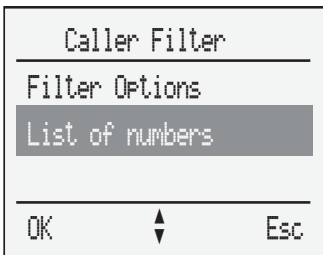

4. Press the **arrow** keys to scroll and highlight the **List of numbers** option.

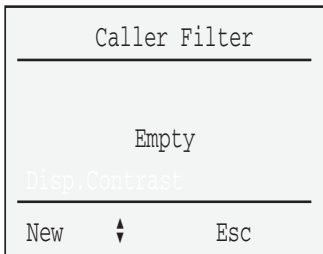

5. Press the **New** soft key.

Note: When there are no numbers stored in the List of numbers, Empty appears on the display and there is a New soft key option.



6. Enter the number.

OK

7. Press the **OK** soft key.



8. Enter the name.

OK

9. Press the **OK** soft key.

To add an entry to the Caller Filter list when there is an existing entry in the list:

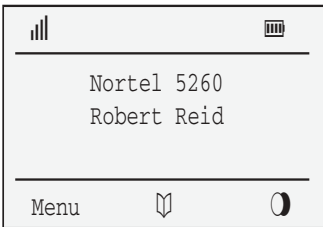

1. Press the **Menu** soft key.

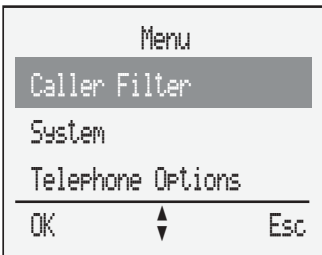

2. Press the **arrow** keys to scroll and highlight the **Caller Filter** option.

OK

3. Press the **OK** soft key.

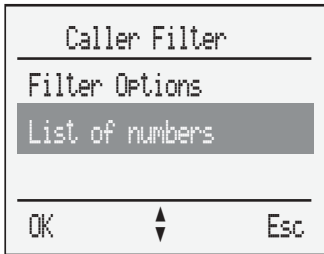

4. Press the **arrow** keys to scroll and highlight the **List of numbers** option.

OK

5. Press the **OK** soft key.

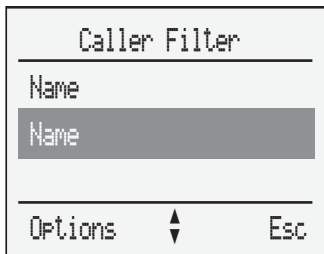

6. Press the **Options** soft key.

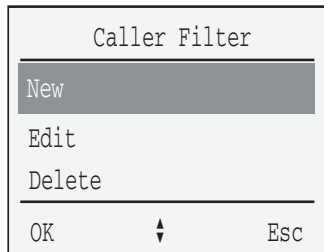

7. Press the **arrow** keys to scroll and highlight the **New** option.

OK

8. Press the **OK** soft key.



9. Enter the number.

OK

10. Press the **OK** soft key.



11. Enter the name.

OK

12. Press the **OK** soft key.

To edit an entry:

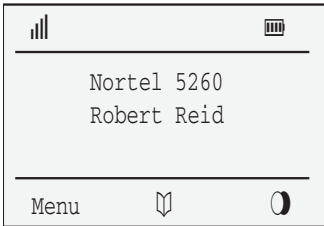

1. Press the **Menu** soft key.

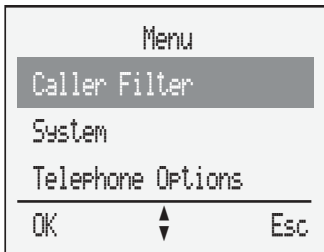

2. Press the **arrow** keys to scroll and highlight the **Caller Filter** option.

OK

3. Press the **OK** soft key.

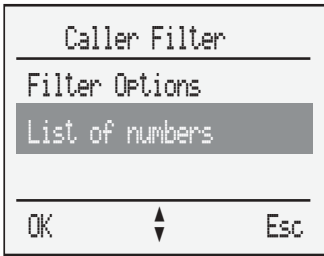

4. Press the **arrow** keys to scroll and highlight the **List of numbers** option.

OK

5. Press the **OK** soft key.

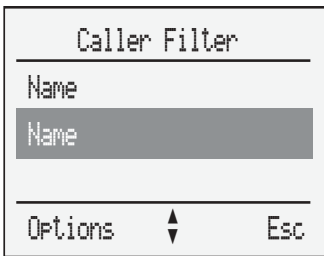

6. Press the **Options** soft key.

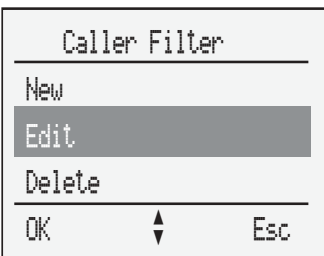

7. Press the **arrow** keys to scroll and highlight the **Edit** option.



8. Edit the number.

OK

9. Press the **OK** soft key.



10. Edit the name.

OK

11. Press the **OK** soft key.

To delete an entry:

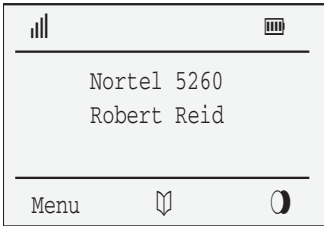

1. Press the **Menu** soft key.

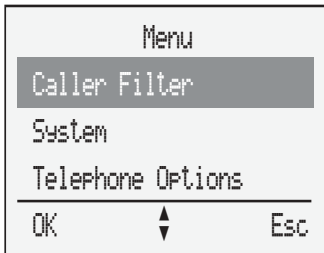

2. Press the **arrow** keys to scroll and highlight the **Caller Filter** option.

OK

3. Press the **OK** soft key.

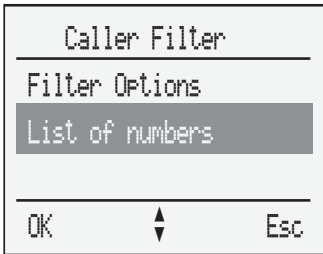

4. Press the **arrow** keys to scroll and highlight the **List of numbers** option.

OK

5. Press the **OK** soft key.

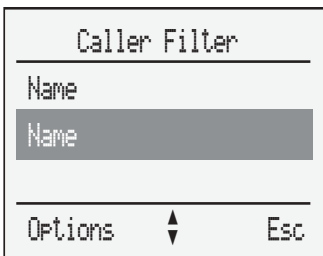

6. Press the **Options** soft key.

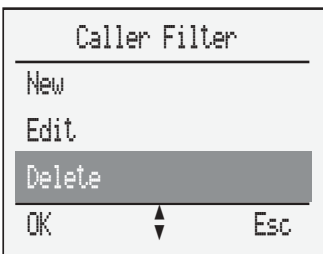

7. Press the **arrow** keys to scroll and highlight the **Delete** option.

OK

8. Press the **OK** soft key.

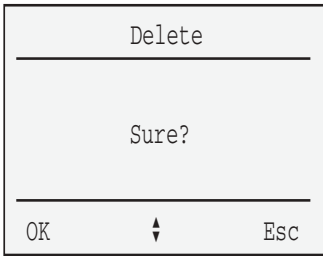

9. At the **Sure?** prompt, choose one of the following:
 - Press the **OK** soft key to accept.
 - Press the **Esc** soft key to decline.

To delete all entries:

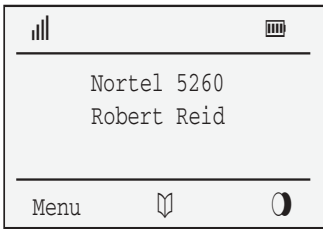

1. Press the **Menu** soft key.

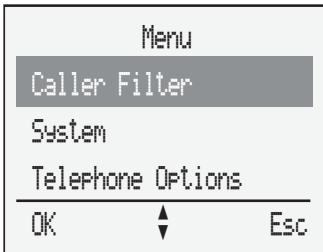

2. Press the **arrow** keys to scroll and highlight the **Caller Filter** option.

OK

3. Press the **OK** soft key.

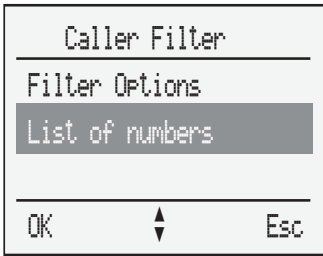

4. Press the **arrow** keys to scroll and highlight the **List of numbers** option.

OK

5. Press the **OK** soft key.

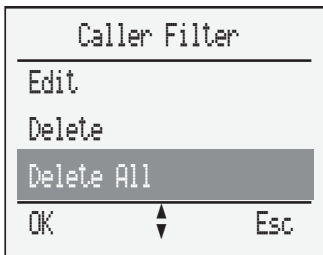

6. Press the **arrow** keys to scroll and highlight the **Delete All** option.

OK

7. Press the **OK** soft key.

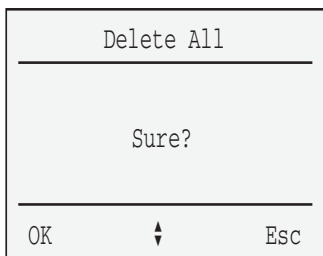

8. At the **Sure?** prompt, choose one of the following:
- Press the **OK** soft key to accept.
 - Press the **Esc** soft key to decline.

Filter Options

Use the Filter Options feature to choose one of the following:

- Accept list — indicates those calls you will accept
- Block list — indicates those calls you will not accept
- Filter off — indicates that Caller Filter is inactive

To select Filter options:

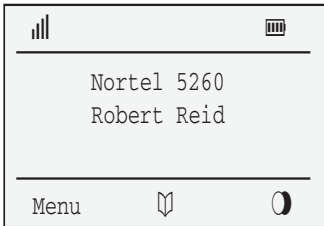

1. Press the **Menu** soft key.

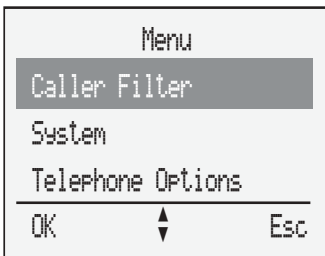

2. Press the **arrow keys** to scroll and highlight the **Caller Filter** option.

OK

3. Press the **OK** soft key.

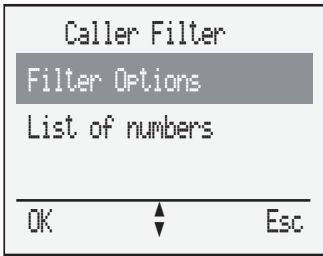

4. Press the **arrow** keys to scroll and highlight **Filter Options**.

OK

5. Press the **OK** soft key.

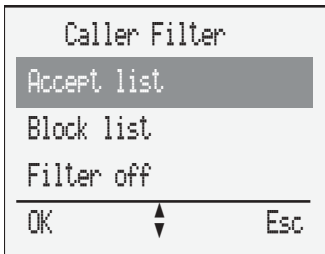

6. Choose one of the following options:

- Accept list
- Block list
- Filter off

Note: If the filter mode is set to accept and the caller filter is activated, the numbers in the Caller filter are the only ones that will be received by the handset.

OK

7. Press the **OK** soft key.

Note: The selected item is indicated by a check mark and a confirmation tone.

Wild Cards

When entering numbers in the Caller Filter, a wild card feature is provided, so that a group of numbers can be selected as entries in the Caller Filter.

For example, if the characters **0*** are entered as a number in the Caller Filter, all numbers beginning with the digit 0 (external numbers) are selected as entries in the Caller Filter. If only the character ***** is entered as a number in the Caller Filter, then all numbers are selected as entries in the Caller Filter.

When using the wild card function, the  character must always be the last character entered in the number.

Transfer a number to the Caller Filter from the Caller List:



1. Press the **Info** key.

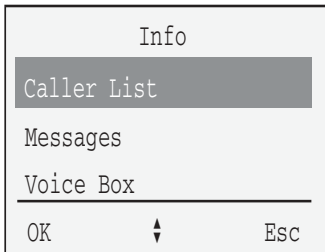

2. Press the **arrow** keys to scroll and highlight the **Caller List** option.

OK

3. Press the **OK** soft key.

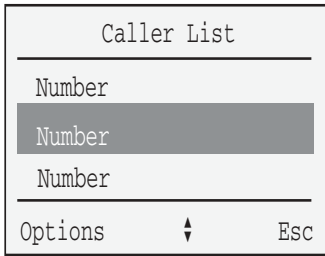

4. Press the **arrow** keys to scroll and highlight the number.

Options

5. Press the **Options** soft key.

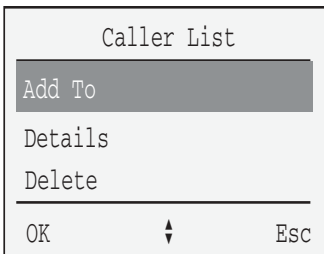

6. Press the **arrow** keys to scroll and highlight the **Add To** option.

OK

7. Press the **OK** soft key.

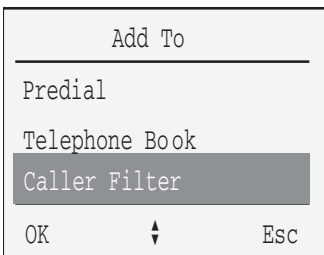

8. Press the **arrow** keys to scroll and highlight the **Caller Filter** option.

OK

9. Press the **OK** soft key.



10. Edit the number.

OK

11. Press the **OK** soft key.



12. Edit the name.

OK

13. Press the **OK** soft key.

To transfer a number to the Caller Filter from the Telephone Book:

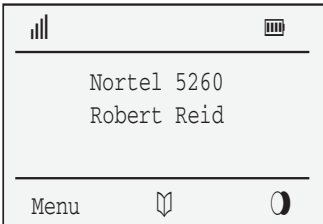

1. Press the **Telephone Book** soft key.

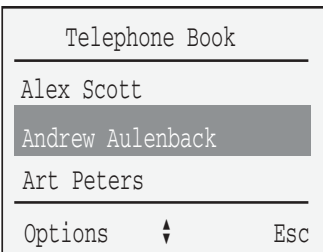

2. Press the **arrow** keys to scroll and highlight the entry.

Options

3. Press the **Options** soft key.

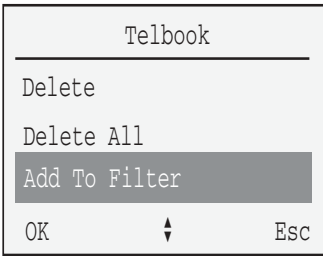

4. Press the **arrow** keys to scroll and highlight the **Add To Filter** option.

OK

5. Press the **OK** soft key.

Note: A confirmation tone sounds.

To transfer a number to the Caller Filter from the Redial List:

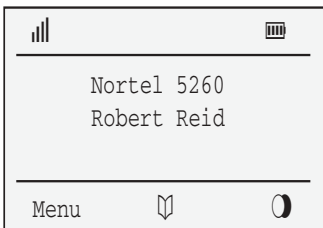

1. Press the **Redial** soft key.

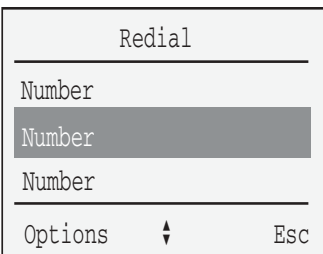

2. Press the **arrow** keys to scroll and highlight the entry.

Options

3. Press the **Options** soft key.

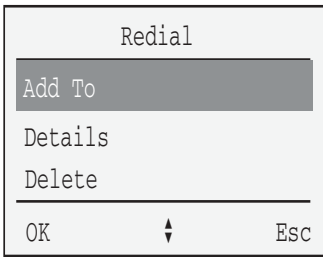

4. Press the **arrow** keys to scroll and highlight the **Add To** option.

OK

5. Press the **OK** soft key.

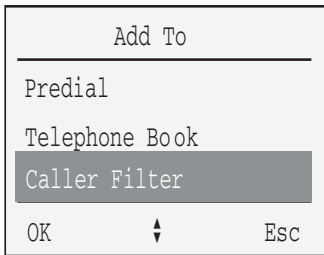

6. Press the **arrow** keys to scroll and highlight the **Caller Filter** option.

OK

7. Press the **OK** soft key.



8. Edit the number.

OK

9. Press the **OK** soft key.



10. Edit the name.

OK

11. Press the **OK** soft key.

System Settings

The handset can be operated with a maximum of ten DECT systems. Before you can make a telephone call using the DECT system, the handset must be registered. A system ID and registration code may be necessary for the registration process. Contact your system administrator for the code. When the handset is not yet subscribed to the system, the display shows “No Subscription”.

The System menu sets the following options of the handset:

- register the handset
- select the DECT system
- search automatically for a system
- delete a system
- change a system’s name and telephone number
- set equipment ID

To select a DECT system manually:

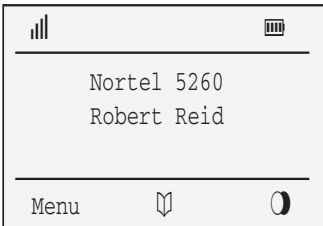

1. Press the **Menu** soft key.

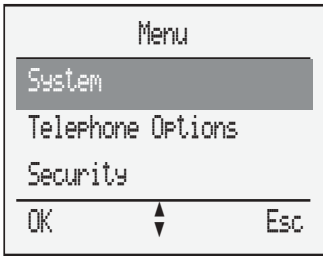

2. Press the **arrow** keys to scroll and highlight the **System** option.

OK

3. Press the **OK** soft key.

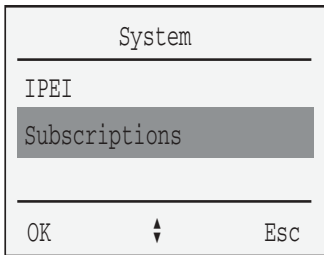

4. Press the **arrow** keys to scroll and highlight the **Subscriptions** option.

OK

5. Press the **OK** soft key.

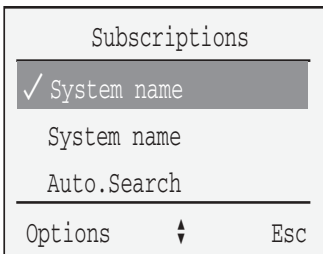

6. Press the **arrow** keys to scroll and highlight the system name.

Options

7. Press the **Options** soft key.

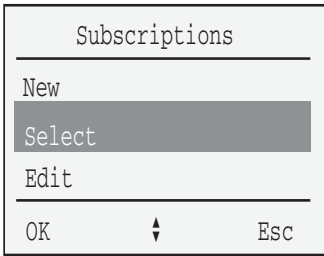

- Press the **arrow** keys to scroll and highlight the **Select** option.

OK

- Press the **OK** soft key.

Note: A check mark “✓” indicates the selected option is activated.

To select a DECT system automatically:

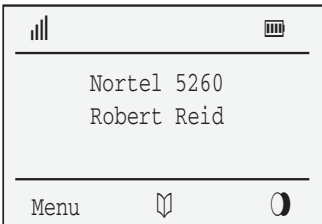

- Press the **Menu** soft key.

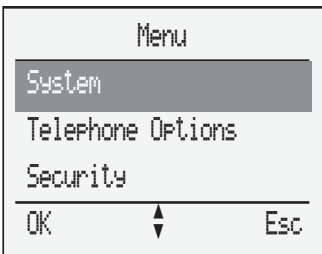

- Press the **arrow** keys to scroll and highlight the **System** option.

OK

3. Press the **OK** soft key.

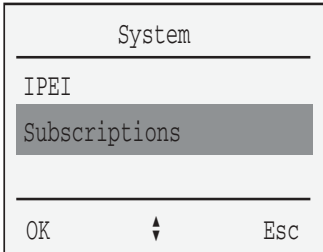

4. Press the **arrow** keys to scroll and highlight the **Subscriptions** option.

OK

5. Press the **OK** soft key.

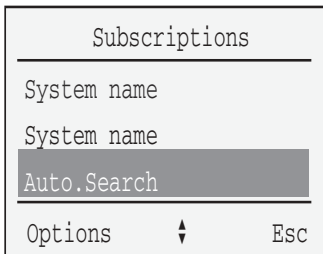

6. Press the **arrow** keys to scroll and highlight the **Auto.Search** option.

Options

7. Press the **Options** soft key.

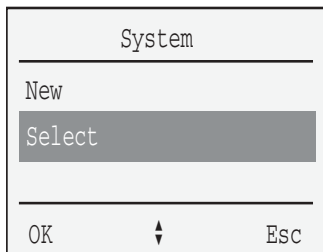

8. Press the **arrow** keys to scroll and highlight the **Select** option.

OK

9. Press the **OK** soft key.

Note 1: The selected item is indicated by a check mark and a confirmation tone.

Note 2: Your handset automatically selects the most appropriate DECT system to use. If you move out of the range of one system, the handset automatically selects a system within range.

To delete a DECT system:

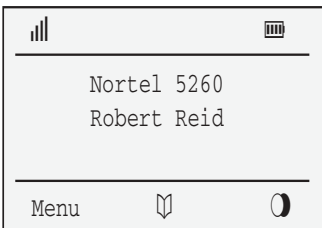

1. Press the **Menu** soft key.

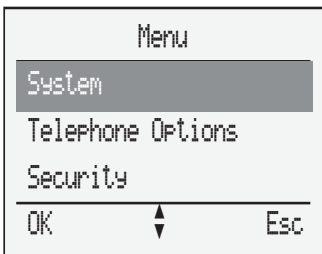

2. Press the **arrow** keys to scroll and highlight the **System** option.

OK

3. Press the **OK** soft key.

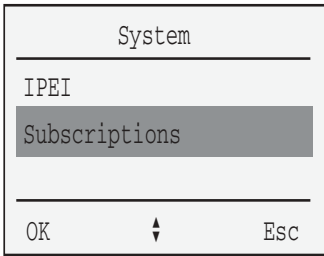

4. Press the **arrow** keys to scroll and highlight the **Subscriptions** option.

OK

5. Press the **OK** soft key.

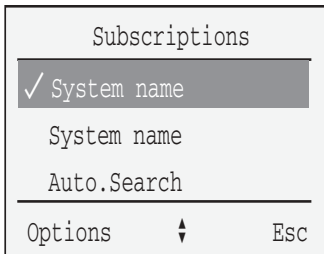

6. Press the **arrow** keys to scroll and highlight the system name.

Options

7. Press the **Options** soft key.

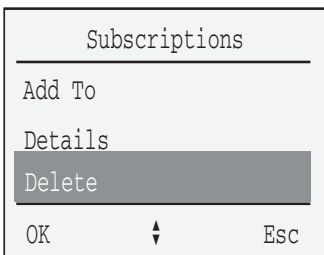

8. Press the **arrow** keys to scroll and highlight the **Delete** option.

OK

9. Press the **OK** soft key.

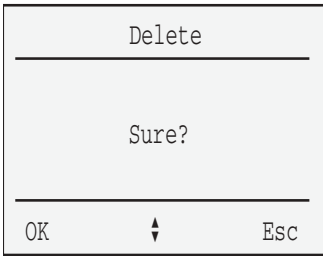

10. At the **Sure?** prompt, choose one of the following:
 - Press the **OK** soft key to accept.
 - Press the **Esc** soft key to decline.

Note: You can delete a DECT system only when the handset is out of range or when the handset is not registered to any system. The handset must be registered before use.

To change a system's name and telephone number:

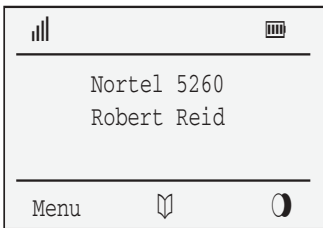

1. Press the **Menu** soft key.

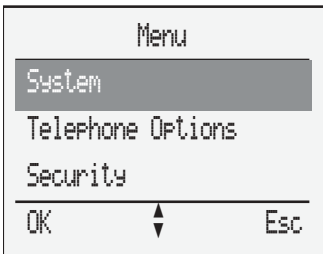

2. Press the **arrow** keys to scroll and highlight the **System** option.

OK

3. Press the **OK** soft key.

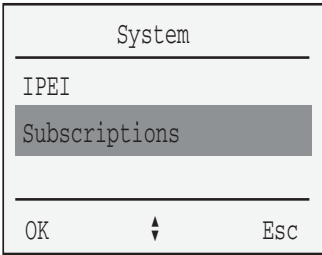

4. Press the **arrow** keys to scroll and highlight the **Subscriptions** option.

OK

5. Press the **OK** soft key.

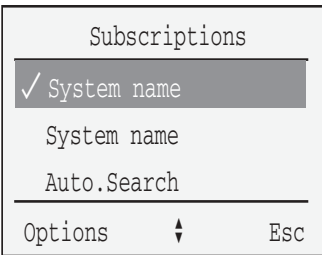

6. Press the **arrow** keys to scroll and highlight the system name.

Options

7. Press the **Options** soft key.

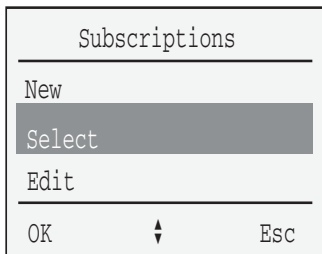

8. Press the **arrow** keys to scroll and highlight the **Edit** option.



9. Edit the name.

OK 10. Press the **OK** soft key.



11. Edit the number.

OK 12. Press the **OK** soft key.

To read equipment identification:

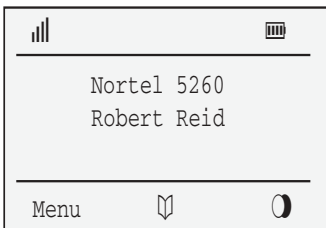

1. Press the **Menu** soft key.

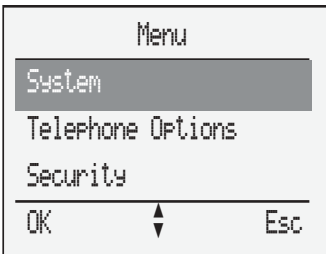

2. Press the **arrow** keys to scroll and highlight the **System** option.

OK 3. Press the **OK** soft key.

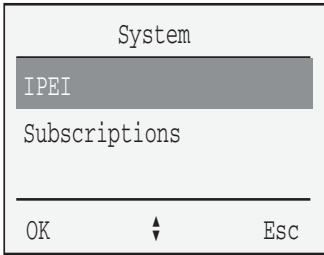

4. Press the **arrow** keys to scroll and highlight the **IPEI** option.

OK

5. Press the **OK** soft key.

Access Meridian PBX features

Use Flexible Feature Codes (FFC) and Special Prefix (SPRE) to access the Meridian PBX features.

Dial an FFC to access some of the handset features.

Dial a SPRE code plus a one- or two-digit number to access some of the handset's features. The SPRE codes are unique to your handset; however, the digits following the SPRE code are fixed. For example, dial SPRE + 74 to forward all your calls to another number.

To access Meridian PBX features:



1. Enter the FFC while the handset is idle.



2. Press the **hook** key.



3. Press the **hook** key.

Note: Contact the system administrator for the FFC and SPRE codes.

Use Table 5 to list the FFCs or the SPRE codes assigned by your system administrator.

Table 5: FFCs and SPRE codes

Code	Feature
	Call Forward – to activate
	Call Forward – to deactivate
	Call Park – to park a call
	Call Park – to retrieve a call

Use Voicemail

Use the Voicemail feature to listen to voice messages left by calling parties. New voicemails are indicated by:

- the  (voicemail) symbol flashes on the display screen (the symbol disappears after the voice message is played)
- the flashing Info key
- Voice Message text is displayed on the display screen

Note: When the handset is switched OFF, or is out of the coverage zone, the Info and Loudspeaker keys flash and the  (voicemail) symbol appears when the handset is turned ON, or re-enters the coverage zone.

For automated access to your voicemail messages, Nortel Networks recommends you pre-configure the:

- voicemail access number
- voice box number

Pre-configuration automatically dials the voicemail access number, automatically enters your voice box number, and automatically enters your voice box password.

To pre-configure the voicemail access number, your voice box number, and your password:

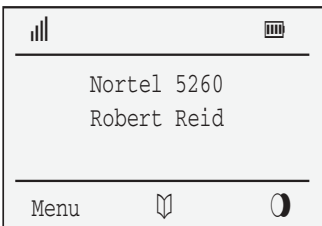

1. Press the **Menu** soft key.

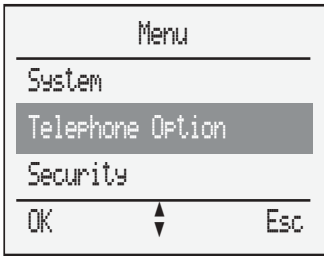

2. Press the **arrow** keys to scroll and highlight **Telephone Option**.

OK

3. Press the **OK** soft key.

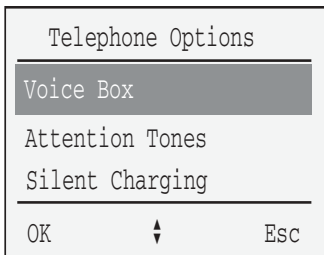



4. Press the **arrow** keys to scroll and highlight the **Voice Box** option.

OK

5. Press the **OK** soft key.



6. Enter the following:
 - a. Voicemail access number
 - b. P (long pause) — hold down “0” key for longer than 2 seconds
 - c. Voice box number
 - d. 
 - e. Voice box password (optional) followed by 

OK

7. Press the **OK** soft key.

To automatically access voicemail messages using a pre-configured voicemail access number, voice box number, and password:



1. Press the **Info** key.

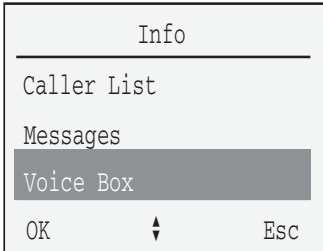

2. Press the **arrow** keys to scroll and highlight **Voice Box** option.

Note: The **Voice Box** option does not appear as a menu item if you did not pre-configure the voicemail access number and voice box number and password.

OK



3. Choose one of the following:
 - Press the **OK** soft key.
 - Press the **Hook** key.

The voicemail access number is automatically dialed, and your voice box number and password are automatically entered.

Note: Press the **Esc** key at any time to abort this procedure.

Use Text message

Use the Text message feature to send and receive text messages. New text messages are indicated by:





- user-configured melody (can be configured to distinguish between normal and urgent messages)
- the  (text message) icon flashes on the display screen
- the flashing Info key

Note 1: Messages can be sent and received while on a telephone call. However, messages cannot be sent or received if the handset is out of the system's range. If a message cannot be sent, an error tone is generated.

Note 2: If a message is received while making a menu selection, the menu is aborted and all entries not saved are lost.

The following table indicates text message symbols and the statuses that can appear on the handset display screen.

Table 6: Message status

Symbol	Status
	Urgent Message
	Normal message read
	Normal message unread
	Transmitted message confirmed
	Message was not transmitted successfully

Urgent text messages

Urgent text messages are indicated by:

- the \neq symbol and “New Message” displayed on the screen (if automatic message Display function is disabled), or the text message displayed on the screen (if automatic message Display function is enabled)
- the urgent message melody (if the ringer is turned ON); the volume increases to maximum during the signaling process
- the flashing Info key
- a repeating melody while on a call

This section describes how to:

- configure an urgent text message melody
- configure the handset so urgent text messages are automatically displayed

To configure an urgent text message melody:

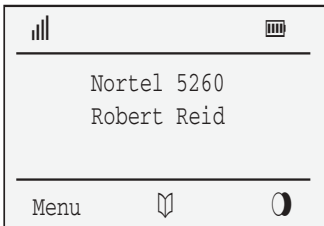

1. Press the **Menu** soft key.

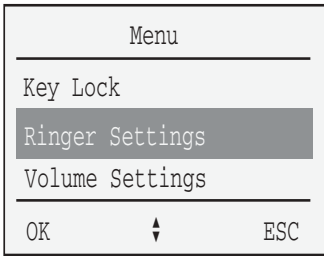

2. Press the **arrow** keys to scroll and highlight **Ringer Settings**.

OK

3. Press the **OK** soft key.

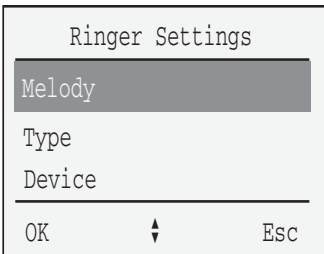

4. Press the **arrow** keys to scroll and highlight the **Melody** option.

OK

5. Press the **OK** soft key.

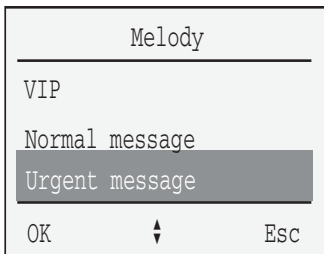

6. Press the **arrow** keys to scroll and highlight the **Urgent Message** option.

OK

7. Press the **OK** soft key.

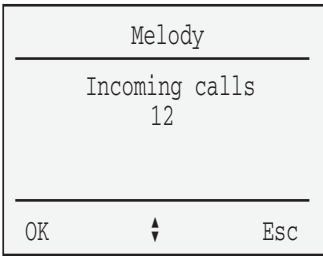

8. Press the **arrow** keys to scroll and highlight the melody number.



9. Choose one of the following:

- Press the **arrow** keys to increase or decrease the melody number.
- Use the keypad to enter the melody number.

Note: Enter a number between 1 and 30 to set the melody number for each type of call.

OK

10. Press the **OK** soft key.

To enable automatic text message Display function:

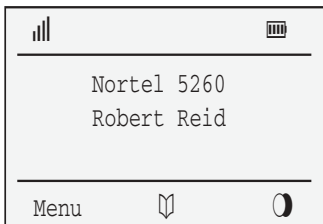

1. Press the **Menu** soft key.

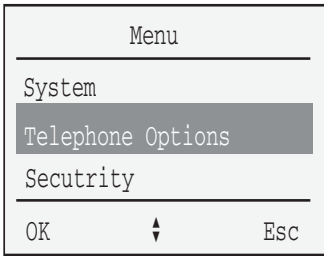

2. Press the **arrow** keys to scroll and highlight the **Telephone Option** menu.

OK

3. Press the **OK** soft key.

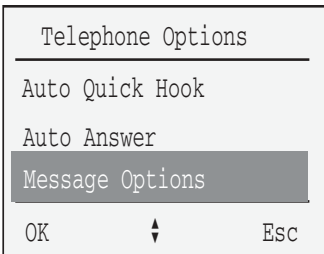

4. Press the **arrows** keys to scroll and highlight the **Message Options** option.

OK

5. Press the **OK** soft key.

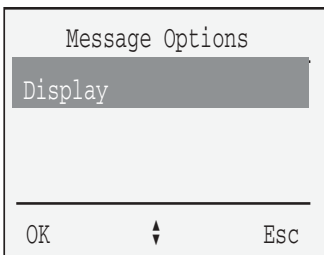

6. Press the **arrow** keys to scroll and highlight the **Display** option.

OK

7. Press the **OK** soft key. A check mark (✓) indicates the automatic text message display function is enabled.

Note 1: A text message cannot be received while the handset is ringing. The sender receives an error message.

Note 2: If a text message is received while menu changes are being made on a handset, all unsaved menu changes are lost. This includes telephone numbers being entered, and message text being entered.

Confirm receipt of urgent text message(s)

You must confirm receipt of an urgent text message. All key functions are blocked until you confirm an urgent text message.

Note: An activated key lock is temporarily deactivated when receiving an urgent text message so that its receipt can be confirmed.

To confirm receipt of an urgent text message:



Choose one of the following:

- Press the **OK** soft key.
- Press the **Delete** soft key to confirm receipt and to delete the text message.

Note: Press the **arrow** keys to scroll through the text message.

Normal text messages

Normal text messages are indicated by:

- the  symbol and “New Message” displayed on the screen (if automatic text message Display function is disabled), or the text message displayed on the screen (if automatic text message Display function is enabled)
- the normal text message melody (if the ringer is turned ON)
- the flashing Info key
- a short melody while on a call

This section describes how to:

- configure a normal text message melody
- configure the handset so normal text messages are automatically displayed

To configure a normal text message melody:

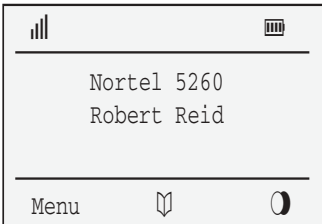

1. Press the **Menu** soft key.

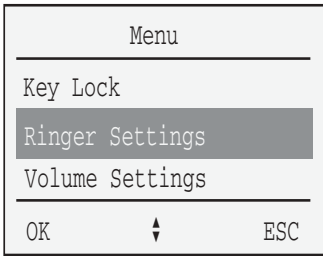

2. Press the **arrow** keys to scroll and highlight **Ringer Settings**.

OK

3. Press the **OK** soft key.

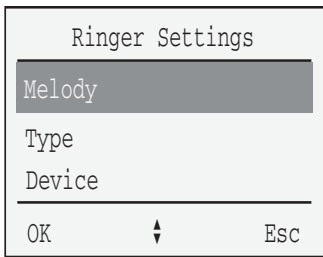

4. Press the **arrow** keys to scroll and highlight the **Melody** option.

OK

5. Press the **OK** soft key.

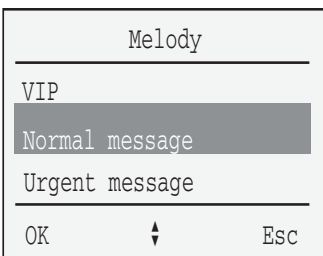

6. Press the **arrow** keys to scroll and highlight the **Normal Message** option.

OK

7. Press the **OK** soft key.

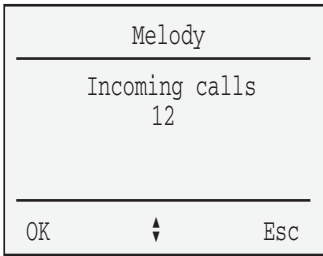

8. Press the **arrow** keys to scroll and highlight the melody number.



9. Choose one of the following:

- Press the **arrow** keys to increase or decrease the melody number.
- Use the keypad to enter the melody number.

Note: Enter a number between 1 and 30 to set the melody number for each type of call.

OK

10. Press the **OK** soft key.

Confirm receipt of normal text message(s)

Normal text messages do not need to be confirmed.

Store and delete text messages

The handset automatically stores up to a maximum of 10 text messages, indicating the date and time received (if supported) and the caller's identification. Each stored text message is located in the message list with the first few words of the message displayed.

When the message list contains 10 text messages, the flashing  symbol on the display screen and the flashing **Info** key indicates the message list is full. Delete messages to free-up storage space, or enable the overwrite feature.

This section describes how to:

- enable the Overwrite option
- delete text messages

To enable the Overwrite feature:

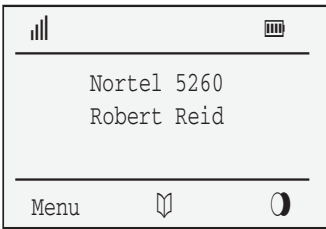

1. Press the **Menu** soft key.

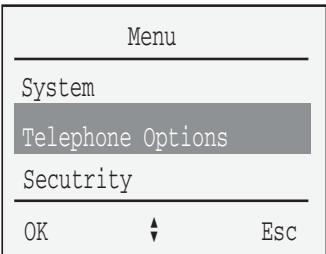

2. Press the **arrow** keys to scroll and highlight the **Telephone Option** menu.

OK

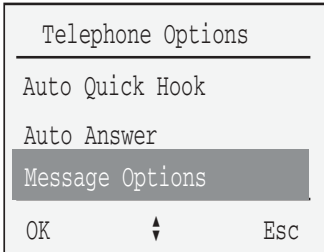
3. Press the **OK** soft key.4. Press the **arrow** keys to scroll and highlight the **Message Options** option.

OK

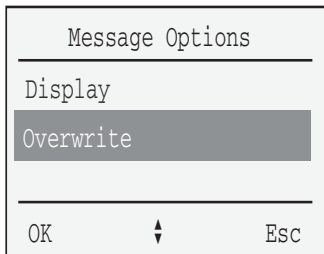
5. Press the **OK** soft key.6. Press the **arrow** keys to scroll and highlight the **Overwrite** option.

OK

7. Press the **OK** soft key. A check mark (✓) and confirmation tone (if configured) indicates the automatic **Overwrite** function is enabled. The oldest text message is deleted to free-up storage space.**CAUTION**

If the **Overwrite** function is not enabled, new text messages are not stored. It is necessary to regularly delete messages to free-up storage space.

To delete a text message:



1. Press the **Info** key.

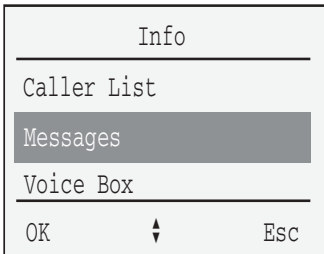

2. Press the **arrow** keys to scroll and highlight the **Messages** option.

OK

3. Press the **OK** soft key.

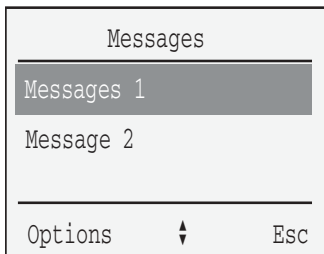

4. Press the **arrow** keys to scroll through the message list and highlight the text message to be deleted.

Options

5. Press the **Options** soft key.

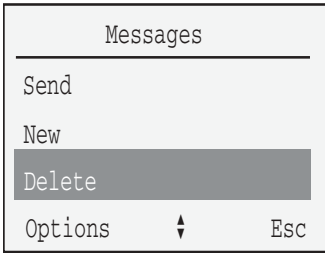

- Press the arrow keys to scroll and highlight the **Delete** option.

OK

- Press the **OK** soft key.

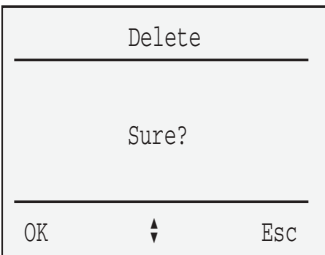

- At the **Sure?** prompt, choose one of the following:

- Press the **OK** soft key to accept.
- Press the **Esc** soft key to decline.

Note: A confirmation tone sounds (if configured).

To delete all text messages:



- Press the **Info** key.

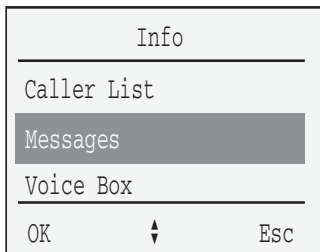

- Press the **arrow** keys to scroll and highlight the **Messages** option.

OK

3. Press the **OK** soft key.

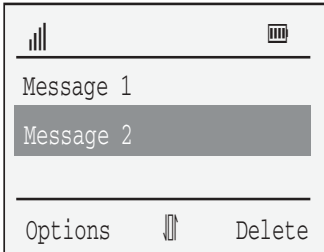

4. Press the **arrow** keys to scroll through the message list and highlight the text message to be deleted.

Options

5. Press the **Options** soft key.



6. Press the **arrow** keys to scroll and highlight the **Delete All** option.

OK

7. Press the **OK** soft key.

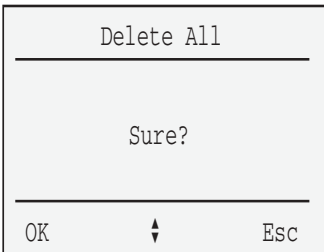

8. At the **Sure?** prompt, choose one of the following:

- Press the **OK** soft key to accept.
- Press the **Esc** soft key to decline.

Note: A confirmation tone sounds (if configured).

Read text messages

This section describes how to read a text message.

To read a text message (automatic text message Display enabled):



Press the **arrow** keys to scroll through the message.

To read a text message (automatic text message Display disabled):



1. Press the **Info** key.

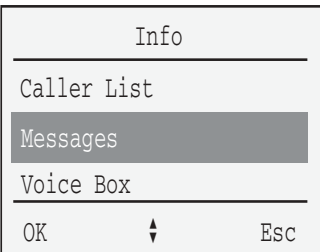

2. Press the **arrow** keys to scroll and highlight the **Messages** option.

OK

3. Press the **OK** soft key.

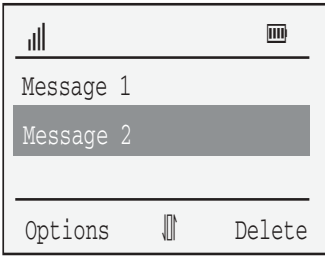

4. Press the **arrow** keys to scroll through the message list and highlight the message to be read.

Note: The first few words of each text message are displayed.

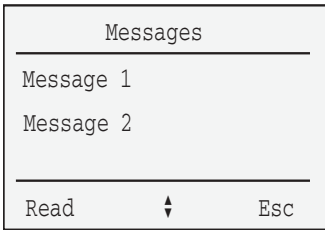

5. Choose one of the following:

— If the text message is unread:

- a. Press the **Read** soft key.
- b. Press the **arrow** keys to scroll through the message if message is larger than handset display screen.

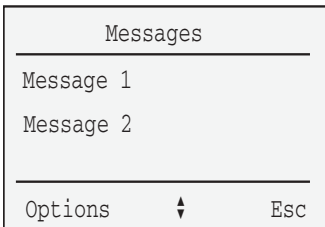

— If the text message has been previously read:

- a. Press the **Options** soft key.
- b. Press the **arrow** keys to highlight the **Read** option.
- c. Press the **OK** soft key.
- d. Press the **arrow** keys to scroll through the message if message is larger than handset display screen.

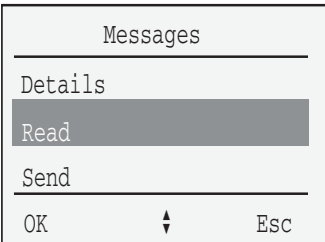

Send a text message

For handset-to-handset messaging, a new text message can be written or an existing message can be sent or edited and sent.

This section describes how to:

- send a new text message
- send an existing text message
- view text message details



CAUTION

1. To send a text message, the stored message list cannot be full. If the list is full, delete one or more messages.
2. If you edit an existing message and send it, it will replace/overwrite the original message received.

To send a new text message:



1. Press the **Info** key.

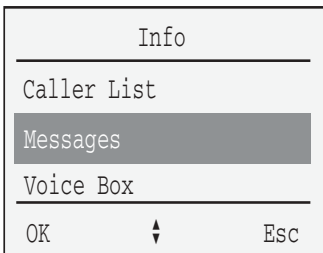

2. Press the **arrow** keys to scroll and highlight the **Messages** option.

OK

3. Press the **OK** soft key.

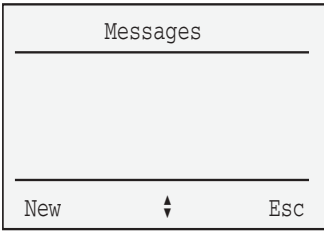

4. Choose one of the following:
- If there are no text messages in the menu:
 - a. Press the **New** soft key.

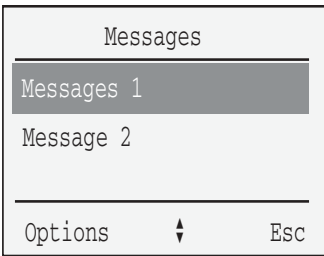

- If there are text messages appearing in the message list:
 - a. Use the **Options** soft key.
 - b. Press the **arrow** keys to scroll and highlight the **New** option.
 - c. Press the **OK** soft key.



5. Enter the new text message.

Note: For information on using the keypad to enter a new text message, see “Handset keypad reference” on page 20.

Options

6. When you have completed entering the new text message, press the **Options** soft key.

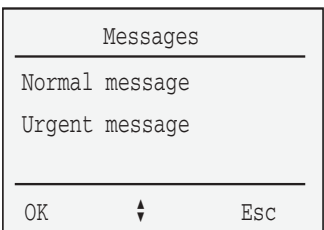

7. Press the **arrow** keys to scroll and highlight one of the following:
- **Normal Message** option
 - **Urgent Message** option

OK

8. Press the **OK** soft key.



9. Enter the telephone number to where the text message is to be sent.

OK

10. Press the **OK** soft key.

To send an existing text message:



1. Press the **Info** key.

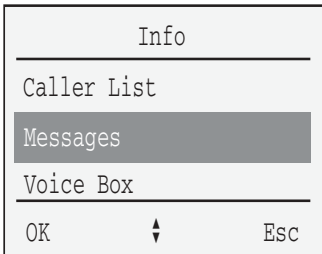

2. Press the **arrow** keys to scroll and highlight the **Messages** option.

OK

3. Press the **OK** soft key.

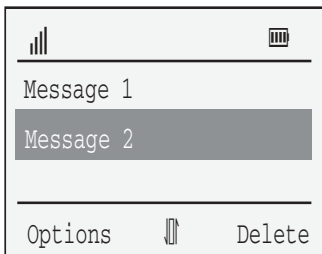

4. Press the **arrow** keys to scroll through the message list and highlight the message to be sent.

Options

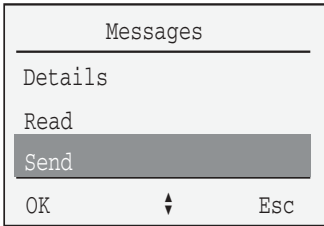
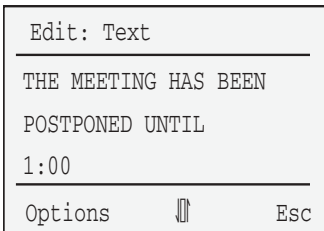
5. Press the **Options** soft key.6. Press the **arrow** keys to scroll and highlight the **Send** option.7. Press the **OK** soft key. The original text message is displayed. You can edit the message.

Options

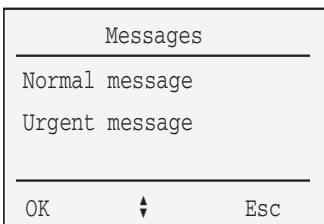
8. Press the **Options** soft key.9. Press the **arrow** keys to scroll and highlight one of the following:

- **Normal Message** option
- **Urgent Message** option

OK

10. Press the **OK** soft key.



11. Enter the new number where the text message is to be sent by editing the original telephone number.

OK

12. Press the **OK** soft key.

Note: A confirmation tone is generated (if configured).

To view text message details:



1. Press the **Info** key.

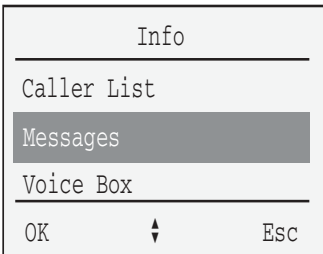

2. Press the **arrow** keys to scroll and highlight **Messages** option.

OK

3. Press the **OK** soft key.

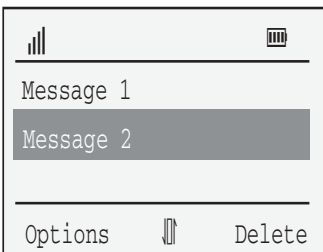

4. Press the **arrow** keys to scroll through the message list and highlight the desired message for details.

Options

5. Press the **Options** soft key.

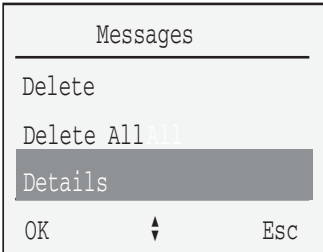

6. Press the **arrow** keys to scroll and highlight the **Details** option.

OK

7. Press the **OK** soft key. Message details are displayed.

Note: At this point, you can press the **arrow** keys to scroll through the message list to display details of all messages. Press the **Esc** key to exit.

Accessories

The following accessories are available for use with your handset.

Battery

The DECT Handset 4060 requires a rechargeable AAA NiMh of typical 800mAh, 1.2V battery.

Desktop Charger

Figure 7: Desktop Charger



Charger Rack

A maximum of eight handsets can be charged simultaneously. The charger rack is designed for desktop use and for wall mounting.

Figure 8: Charger rack

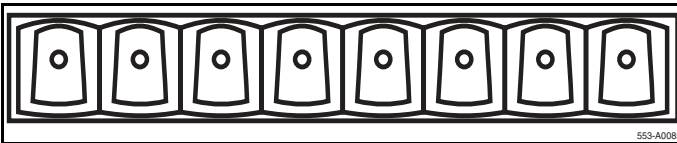

Belt Clip

The adapter is clipped to the handset and is removable without any remains or damages.

Figure 9: The belt clip and adapter for the handset.

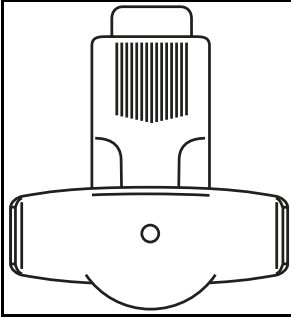

Data cable

The data cable connects the PC to the handset.

Figure 10: Cable to connect the handset with a PC.

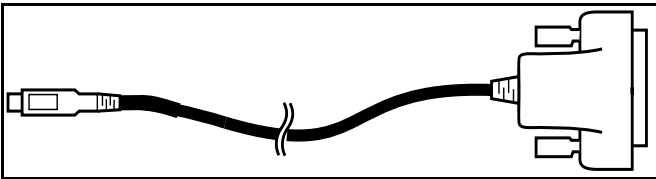

Headset

The headset, in conjunction with the belt clip, makes handsfree telephone calls possible. This is optimized by the handset feature “Auto Answer”.

Figure 11: Headset

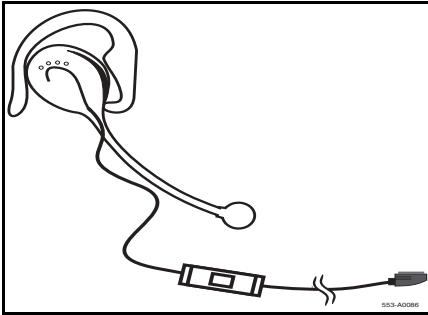

IBM-compatible PC

The following lists minimum PC requirements:

- IBM or 100% compatible personal computer
- Pentium 133 MHz or higher processor
- Minimum 16 MB RAM
- Microsoft Windows 95/98/NT44/2000/XP
- COM port
- CD-ROM drive

DECT Handset 4060 software CD

The software CD contains the following two applications:

- **Telephony Application Programmer’s Interface (TAPI)** — an interface that enables remote control of the handset.
- **Configuration** — used to configure the handset from the PC.

Upon installation, the Start menu of your PC contains a folder called C4060. In this directory you can find the configuration program and the Readme.txt file.

PC connection

Use the data cable to connect the COM port (V.24 port) of the PC to the USB port found on the side of the handset.

Figure 12: PC connection



Index

A

About the handset 17
Accessories 164
Add entries in phone book 79
Answer a call 66
Arrow soft keys 24
Attention Tones 51
Auto Answer 59
Auto Quick Hook 57

B

Basic features 17
Battery 164
Before you begin 11
Belt clip 165

C

Callers List 89
Callers List symbols 88
Change the PIN 25
Charge the batteries 13
Charger Answer 55
Charger rack 164
Charging and operating times 13
Charging guidelines 13
Conference call 76
Configure options 30
Confirm urgent text message 146
Create a Telephone Book 79

D

Data cable 165
Delete a text message 150
Desktop charger 164
Device 35
Disp. Contrast 61

E

Emergency Call 45
Esc soft key 24

F

Filter Options 118

H

Handset controls 18
Handset display 21
Handsfree dialing 65
Headset 166

I

IBM compatible PC 166
Icon / text line 21
Illumination 20
Insert the batteries 12
Install the batteries 11

K

Key lock 30
Keypad 20

L

- Language 43
- List of numbers 108

M

- Make a call 64
- Make and SOS call 65
- Melody 32
- Mute a call 73
- Mute the ringer 69

N

- Normal text message 147

O

- Off-hook dialing 64
- OK soft key 23
- On-hook dialing 64
- Options soft key 23

P

- PBX features 125, 135
- PC connection 167
- Place a call on hold 71
- Power up your handset 24

R

- Read text message 155
- Read-only 27
- Redial List 97
- Register the handset 14
- Reject a call 67
- Reset the handset 28
- Ringer settings 32

- Ringer type 34

S

- Safety precautions 9
- Security functions 25
- Send text message 158
- Set up the handset 11
- Silent Charging 52
- Soft key line 23
- Store a text message 150
- System Settings 125

T

- Telephone Options 41
- Text lines 22

U

- Urgent text message 141
- Use Caller Filter 108
- Use handsfree 72
- Use Quick Call 104
- Use Text message 140
- Use the Callers List 88
- Use the Redial List 97
- Use the Telephone Book 86
- Use Voice Mail 137
- User name 42

V

- Voice Box 49
- Volume 35
- Volume settings 40

W

Wild Cards 120

Nortel Networks Communication Server 1000

Nortel Networks DECT Handset 4060

User Guide

Copyright © 2004 Nortel Networks

All Rights Reserved

Information is subject to change without notice. Nortel Networks reserves the right to make changes in design or components as progress in engineering and manufacturing may warrant.

SL-1, Meridian 1, and Succession are trademarks of Nortel Networks.

Publication Number: P1014046

Document Release: Standard 2.00

Date: September 2004

Produced in Canada



Internet address

<http://www.nortelnetworks.com>

Free Manuals Download Website

<http://myh66.com>

<http://usermanuals.us>

<http://www.somanuals.com>

<http://www.4manuals.cc>

<http://www.manual-lib.com>

<http://www.404manual.com>

<http://www.luxmanual.com>

<http://aubethermostatmanual.com>

Golf course search by state

<http://golfingnear.com>

Email search by domain

<http://emailbydomain.com>

Auto manuals search

<http://auto.somanuals.com>

TV manuals search

<http://tv.somanuals.com>