

Nikon

DIGITAL CAMERA

COOLPIX P5100

User's Manual









En

Trademark Information

- Microsoft and Windows Vista are either registered trademarks or trademarks of Microsoft Corporation in the United States and/or other countries.
- Macintosh, Mac OS, and QuickTime are trademarks of Apple Inc.
- Adobe and Acrobat are registered trademarks of Adobe Systems Inc.
- The SD logo is a trademark of the SD Card Association.
- PictBridge is a trademark.
- D-Lighting technology is provided by  Apical Limited.
- All other trade names mentioned in this manual or the other documentation provided with your Nikon product are trademarks or registered trademarks of their respective holders.

Download from [Www.Somanuals.com](http://www.Somanuals.com). All Manuals Search And Download.

Introduction	
First Steps	
 Basic Photography and Playback: Auto Mode	
 Shooting Suited for the Scene	
 Anti-shake Mode	
 High-Sensitivity Shooting Mode	
PSAM P, S, A and M modes	
 More on Playback	
 Movies	
 Voice Recordings	
Connecting to Televisions, Computers and Printers	
MENU Shooting, Playback and Setup Menus	
Technical Notes	

For Your Safety

To prevent damage to your Nikon product or injury to yourself or to others, read the following safety precautions in their entirety before using this equipment. Keep these safety instructions where all those who use the product will read them. The consequences that could result from failure to observe the precautions listed in this section are indicated by the following symbol:



This icon marks warnings, information that should be read before using this Nikon product, to prevent possible injury.

WARNINGS

Turn off in the Event of Malfunction

Should you notice smoke or an unusual smell coming from the camera or AC adapter, unplug the AC adapter and remove the battery immediately, taking care to avoid burns. Continued operation could result in injury. After removing or disconnecting the power source, take the equipment to a Nikon-authorized service representative for inspection.

Do not Disassemble

Touching the internal parts of the camera or AC adapter could result in injury. Repairs should be performed only by qualified technicians. Should the camera or AC adapter break open as the result of a fall or other accident, take the product to a Nikon-authorized service representative for inspection, after unplugging the product and/or removing the battery.

Do not use the Camera or AC Adapter in the Presence of Flammable Gas

Do not use electronic equipment in the presence of flammable gas, as this could result in explosion or fire.

Handle the Camera Strap with Care

Never place the strap around the neck of an infant or child.

Keep out of Reach of Children

Particular care should be taken to prevent infants from putting the battery or other small parts into their mouths.

Observe caution when handling the battery

The battery may leak or explode if improperly handled. Observe the following precautions when handling the battery for use in this product:

- Before replacing the battery, turn the product off. If you are using the AC adapter, be sure it is unplugged.
- Only use a Rechargeable Li-ion Battery EN-EL5 (supplied). Use the Battery Charger MH-61 (supplied) to charge the battery.
- When inserting the battery, do not attempt to insert it upside down or backwards.
- Do not short or disassemble the battery or attempt to remove or break the battery insulation or casing.
- Do not expose the battery to flames or to excessive heat.
- Do not immerse in or expose to water.
- Replace the terminal cover when transporting the battery. Do not transport or store with metal objects such as necklaces or hairpins.
- The battery is prone to leakage when fully discharged. To avoid damage to the product, be sure to remove the battery when no charge remains.
- Discontinue use immediately should you notice any change in the battery, such as discoloration or deformation.
- If liquid from the damaged battery comes in contact with clothing or

skin, rinse immediately with plenty of water.

Observe the following precautions when handling the battery charger

- Keep dry. Failure to observe this precaution could result in fire or electric shock.
- Dust on or near the metal parts of the plug should be removed with a dry cloth. Continued use could result in fire.
- Do not handle the power cable or go near the battery charger during lightning storms. Failure to observe this precaution could result in electric shock.
- Do not damage, modify, forcibly tug or bend the power cable, place it under heavy objects, or expose it to heat or flames. Should the insulation be damaged and the wires become exposed, take it to a Nikon-authorized service representative for inspection. Failure to observe these precautions could result in fire or electric shock.

For Your Safety

- Do not handle the plug or battery charger with wet hands. Failure to observe this precaution could result in electric shock.

Use appropriate cables

When connecting cables to the input and output jacks, use only the cables provided or sold by Nikon for the purpose, to maintain compliance with product regulations.

Handle moving parts with care

Be careful that your fingers or other objects are not pinched by the lens cover or other moving parts.

CD-ROMs

The CD-ROMs supplied with this device should not be played back on audio CD equipment. Playing CD-ROMs on an audio CD player could cause hearing loss or damage the equipment.

Observe caution when using the flash

Using the flash close to your subject's eyes could cause temporary visual impairment. Particular care should be observed if photographing infants, when the flash should be no less than one meter (39 in.) from the subject.

Do not operate the flash with the flash window touching a person or object

Failure to observe this precaution could result in burns or fire.

Avoid Contact with Liquid Crystal

Should the monitor break, care should be taken to avoid injury caused by broken glass and to prevent liquid crystal from the monitor touching the skin or entering the eyes or mouth.

Notices

Notice for Customers in the U.S.A.

Federal Communications Commission (FCC) Radio Frequency Interference Statement

This equipment has been tested and found to comply with the limits for a Class B digital device, pursuant to Part 15 of the FCC rules. These limits are designed to provide reasonable protection against harmful interference in a residential installation. This equipment generates, uses, and can radiate radio frequency energy and, if not installed and used in accordance with the instructions, may cause harmful interference to radio communications. However, there is no guarantee that interference will not occur in a particular installation. If this equipment does cause harmful interference to radio or television reception, which can be determined by turning the equipment off and on, the user is encouraged to try to correct the interference by one or more of the following measures:

- Reorient or relocate the receiving antenna.
 - Increase the separation between the equipment and receiver.
 - Connect the equipment into an outlet on a circuit different from that to which the receiver is connected.
- Consult the dealer or an experienced radio/television technician for help.



Nikon
COOLPIX P5100

CAUTIONS

Modifications

The FCC requires the user to be notified that any changes or modifications made to this device that are not expressly approved by Nikon Corporation may void the user's authority to operate the equipment.

Interface Cables

Use the interface cables sold or provided by Nikon for your equipment. Using other interface cables may exceed the limits of Class B Part 15 of the FCC rules.

Notice for customers in the State of California

WARNING: Handling the cord on this product will expose you to lead, a chemical known to the State of California to cause birth defects or other reproductive harm.

Wash hands after handling.

Nikon Inc.,
1300 Walt Whitman Road, Melville,
New York 11747-3064 USA
Tel: 631-547-4200

Notice for customers in Canada

CAUTION

This Class B digital apparatus complies with Canadian ICES-003.

ATTENTION

Cet appareil numérique de la classe B est conforme à la norme NMB-003 du Canada.

Symbol for Separate Collection in European Countries

This symbol indicates that this product is to be collected separately.











The following apply only to users in European countries:























- This product is designated for separate collection at an appropriate collection point. Do not dispose of as household waste.
- For more information, contact the retailer or the local authorities in charge of waste management.

Table of Contents

For Your Safety	ii
WARNINGS	ii
Notices	v
<hr/>	
Introduction	1
About This Manual	1
Information and Precautions	2
Parts of the Camera	4
The Camera Body	4
The Monitor	6
Shooting	6
Playback	7
Basic Operations	8
The Mode Dial	8
The Command Dial and Fn (FUNC) Button	9
The Multi Selector	10
The MENU Button	11
Help Displays	11
The □ Button	12
Attaching the Camera Strap	13
<hr/>	
First Steps	14
Charging the Battery	14
Inserting the Battery	16
Removing the Battery	17
Turning On and Off the Camera	17
Setting Display Language, Date and Time	18
Inserting Memory Cards	20
Removing Memory Cards	21

 Basic Photography and Playback: Auto Mode	22
Step 1 Turn the Camera On and Select  (Auto) Mode	22
Step 2 Frame a Picture	24
Using the Viewfinder	24
Step 3 Focus and Shoot	26
Step 4 Viewing and Deleting Pictures	28
Using the Flash	30
Setting the Flash Mode	30
Shooting with the Self-timer	32
Choosing a Focus Mode	33
Setting the Focus Mode	33
Exposure Compensation	34
<hr/>	
 Shooting Suited for the Scene	35
Shooting in the Scene Mode	35
Setting the Scene Mode	35
Features	36
<hr/>	
 Anti-shake Mode	43
Shooting in Anti-shake Mode	43
<hr/>	
 High-Sensitivity Shooting Mode	44
Shooting in High-Sensitivity Shooting Mode	44
<hr/>	
PSAM P, S, A and M modes	45
Shooting in P, S, A, and M Modes	45
Shooting in P (Programmed Auto)	46
Shooting in S (Shutter-Priority Auto)	47
Shooting in A (Aperture-Priority Auto)	48
Shooting in M (Manual)	49

 More on Playback.....	51
Viewing Multiple Pictures: Thumbnail Playback	51
Viewing Multiple Pictures: Thumbnail Wheel Playback.....	52
Taking a Closer Look: Playback Zoom	53
Editing Pictures.....	54
Enhancing Brightness and Contrast: D-Lighting.....	55
Creating a Cropped Copy: Crop	56
 Resizing Pictures: Small Picture	57
Adding Black Frame on Pictures: Black Border.....	58
Voice Memos: Recording and Playback	59
Viewing Pictures by Date	60
<hr/>	
 Movies	64
Recording Movies	64
The Movie Menu.....	65
Selecting Movie Options.....	65
Auto-focus Mode.....	67
Time-Lapse Movies.....	68
Movie Playback.....	70
Deleting Movie Files.....	70
<hr/>	
 Voice Recordings.....	71
Making Voice Recordings.....	71
Playing Voice Recordings.....	73
Deleting Sound Files.....	74
Copying Voice Recordings.....	75
<hr/>	
Connecting to Televisions, Computers and Printers.....	76
Connecting to a TV.....	76
Connecting to a Computer.....	77
Before Connecting the Camera.....	77
Transferring Pictures from the Camera to a Computer	78
Connecting to a Printer.....	81
Connecting the Camera and Printer.....	82
Printing Pictures One at a Time	83
Printing Multiple Pictures	84
Creating a DPOF Print Order: Print Set.....	87

MENU Shooting, Playback and Setup Menus	89
Shooting Options: The Shooting Menu	89
Displaying the Shooting Menu and High-sensitivity Menu	90
 Image Quality	91
 Image Size	92
 Optimize Image	94
 White Balance	97
 ISO Sensitivity	99
 Metering	100
 Continuous	101
 Auto Bracketing	104
 AF Area Mode	105
 Auto-focus Mode	107
 Flash Exp. Comp	108
 Flash Control	108
 Fixed Aperture	109
 Noise Reduction	109
 Converter	110
 User Setting	111
 Reset User Setting	112
 Distortion Control	112
Restrictions on Camera Settings	112
Playback Options: The Playback Menu	115
Displaying the Playback Menu	115
 Slide Show	117
 Delete	118
 Protect	118
 Hide Image	118
 Copy	119

















Basic Camera Setup: The Setup Menu	120
Displaying the Setup Menu.....	121
 Menus.....	121
 Welcome Screen.....	122
 Date.....	123
 Brightness.....	126
 Date Imprint.....	126
 Vibration Reduction.....	128
 AF Assist.....	129
 Digital Zoom.....	129
 Sound Settings.....	130
 Auto Off.....	130
 Format Memory/  Format Card.....	131
 Language.....	132
 Video Mode.....	132
 FUNC Button.....	132
 Reset All.....	133
 Firmware Version.....	135

Table of Contents

Technical Notes.....	136
Optional Accessories	136
Approved Memory Cards	137
Attaching Converter Lenses	138
Using Optional Speedlights.....	139
Image/Sound File and Folder Names	140
Caring for the Camera	141
Cleaning	143
Storage.....	143
Error Messages	144
Troubleshooting.....	148
Specifications	154
Supported Standards	157
Index.....	158

About This Manual

Thank you for your purchase of a Nikon COOLPIX P5100 digital camera. This manual was written to help you enjoy shooting with your Nikon digital camera. Read this manual thoroughly before use, and keep it where all those who use the product will read it.

Symbols and Conventions

To make it easier to find the information you need, the following symbols and conventions are used:



This icon marks cautions, information that should be read before use, to prevent damage to the camera.



This icon marks tips, additional information that may be helpful when using the camera.



This icon marks notes, information that should be read before using the camera.



This icon indicates that more information is available elsewhere in this manual or in the *Quick Start Guide*.

Notations

- A Secure Digital (SD) memory card is referred to as a "memory card."
- The setting at the time of purchase is referred to as the "default setting."
- The names of menu items displayed in the camera monitor, and the names of buttons or messages displayed in the computer monitor are indicated with brackets ([]).

Screen Samples

In this manual, images are sometimes omitted from monitor display samples so that monitor indicators can be more clearly shown.

Illustrations and Screen Display

Illustrations and text displays shown in this manual may differ from actual display.



Memory Cards

Pictures shot with this camera can be stored in the camera's internal memory or on removable memory cards. If a memory card is inserted, all new pictures will be stored on the memory card and delete, playback and format operations will apply only to the pictures on the memory card. The memory card must be removed before the internal memory can be formatted or used to store, delete or view pictures.

Download from Www.Somanuals.com. All Manuals Search And Download.

Information and Precautions

Life-Long Learning

As part of Nikon's "Life-Long Learning" commitment to ongoing product support and education, continually updated information is available online at the following sites:

- For users in the U.S.A.: <http://www.nikonusa.com/>
- For users in Europe and Africa: <http://www.europe-nikon.com/support/>
- For users in Asia, Oceania, and the Middle East: <http://www.nikon-asia.com/>

Visit these sites to keep up-to-date with the latest product information, tips, answers to frequently asked questions (FAQs), and general advice on digital imaging and photography. Additional information may be available from the Nikon representative in your area. See the URL below for contact information:

<http://nikonimaging.com/>

Use Only Nikon Brand Electronic Accessories

Nikon COOLPIX cameras are designed to the highest standards and include complex electronic circuitry. Only Nikon brand electronic accessories (including battery chargers, batteries, AC adapters, and flash accessories) certified by Nikon specifically for use with this Nikon digital camera are engineered and proven to operate within the operational and safety requirements of this electronic circuitry.

THE USE OF NON-NIKON ELECTRONIC ACCESSORIES COULD DAMAGE THE CAMERA AND MAY VOID YOUR NIKON WARRANTY.

For more information about Nikon brand accessories, contact a local authorized Nikon dealer.

Holographic seal: Identifies this device as an authentic Nikon product.

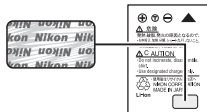

Rechargeable Li-ion Battery EN-EL5

Before Shooting Important Pictures

Before shooting pictures on important occasions (such as at weddings or before taking the camera on a trip), take a test shot to ensure that the camera is functioning normally. Nikon will not be held liable for damages or lost profits that may result from product malfunction.

About the Manuals

- No part of the manuals included with this product may be reproduced, transmitted, transcribed, stored in a retrieval system, or translated into any language in any form, by any means, without Nikon's prior written permission.
- Nikon reserves the right to change the specifications of the hardware and software described in these manuals at any time and without prior notice.
- Nikon will not be held liable for any damages resulting from the use of this product.
- While every effort was made to ensure that the information in these manuals is accurate and complete, we would appreciate it were you to bring any errors or omissions to the attention of the Nikon representative in your area (address provided separately).

Notice Concerning Prohibition of Copying or Reproduction

Note that simply being in possession of material that was digitally copied or reproduced by means of a scanner, digital camera or other device may be punishable by law.

- **Items prohibited by law from being copied or reproduced**

Do not copy or reproduce paper money, coins, securities, government bonds or local government bonds, even if such copies or reproductions are stamped "Sample." The copying or reproduction of paper money, coins, or securities which are circulated in a foreign country is prohibited. Unless the prior permission of the government was obtained, the copying or reproduction of unused postage stamps or post cards issued by the government is prohibited. The copying or reproduction of stamps issued by the government and of certified documents stipulated by law is prohibited.

- **Cautions on certain copies and reproductions**

The government has issued cautions on copies or reproductions of securities issued by private companies (shares, bills, checks, gift certificates, etc.), commuter passes or coupon tickets, except when a minimum of necessary copies are to be provided for business use by a company. Also, do not copy or reproduce passports issued by the government, licenses issued by public agencies and private groups, ID cards and tickets, such as passes and meal coupons.

- **Comply with copyright notices**

The copying or reproduction of copyrighted creative works such as books, music, paintings, woodcut prints, maps, drawings, movies and photographs is governed by national and international copyright laws. Do not use this product for the purpose of making illegal copies or to infringe copyright laws.

Disposing of Data Storage Devices



Please note that deleting images or formatting data storage devices such as memory cards or built-in camera memory does not completely erase the original image data. Deleted files can sometimes be recovered from discarded storage devices using commercially available software, potentially resulting in the malicious use of personal image data. Ensuring the privacy of such data is the user's responsibility.

Before discarding a data storage device or transferring ownership to another person, erase all data using commercial deletion software, or format the device and then completely refill it with images containing no private information (for example, pictures of empty sky). Be sure to also replace any pictures selected for the welcome screen (📷 122). Care should be taken to avoid injury or damage to property when physically destroying data storage devices.

Parts of the Camera

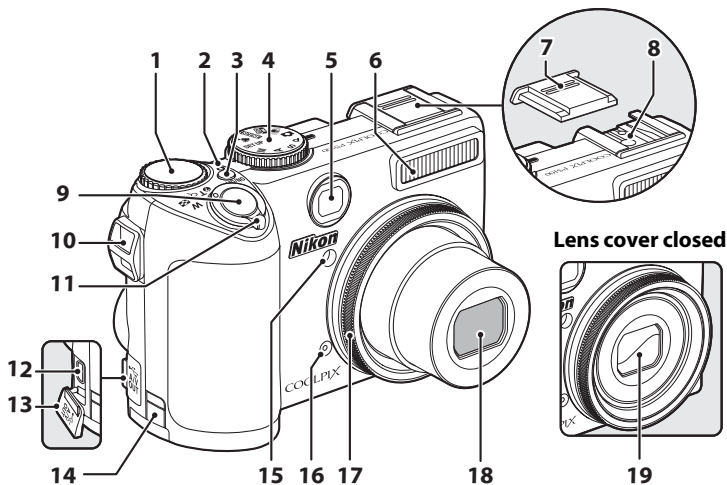
The Camera Body



1	Command dial	9	12	Cable connector.....	76, 78, 82
2	Power-on lamp	17, 130	13	Connector cover	76, 78, 82
3	Power switch.....	17	14	Power connector cover.....	136
4	Mode dial.....	8	15	Self-timer lamp.....	32, 142
5	Viewfinder.....	24		AF-assist illuminator.....	27, 129, 142
6	Built-in flash	30	16	Microphone.....	59, 64, 71
7	Accessory shoe cover	139	17	Lens ring.....	138
8	Accessory shoe	139	18	Lens	143, 154
9	Shutter-release button.....	26	19	Lens cover	
10	Eyelet for camera strap (x2)				
11	Zoom control.....	25			
	W (wide)	25			
	T (tele).....	25			
	 (thumbnail playback)	51			
	 (playback zoom).....	53			
	 (help)	11			

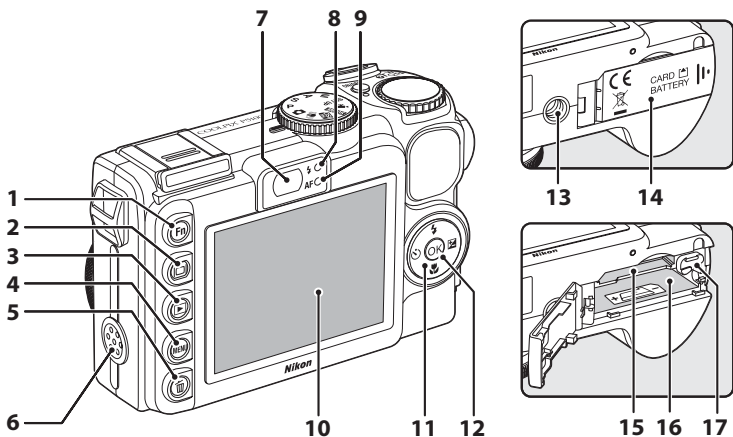

1	Fn (FUNC) button.....	9, 132	10	Monitor	6, 12, 23
2	(monitor) button	12	11	Multi selector.....	10
3	(playback) button	28	12	button	10
4	MENU (menu) button.....	11, 65, 90, 115	13	Tripod socket	
5	(delete) button	28, 29, 59, 70, 74	14	Battery-chamber/memory card slot cover.....	16, 20
6	Speaker	59, 70, 73	15	Memory card slot.....	20
7	Viewfinder.....	24	16	Battery chamber.....	16
8	Flash lamp.....	31	17	Battery latch.....	16, 17
9	Auto focus (AF) lamp.....	26			

The Monitor

The following indicators may appear in the monitor during shooting and playback (actual display varies with current camera settings).

Shooting

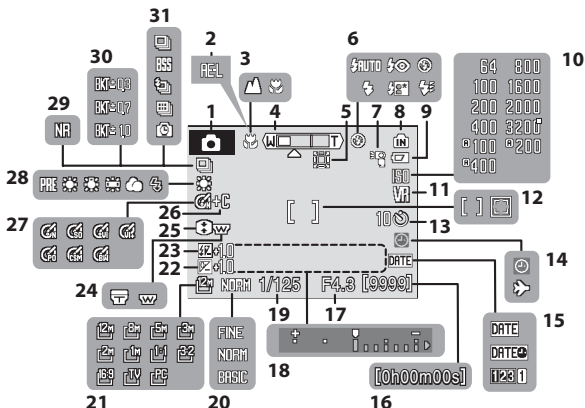

1	Shooting mode*22, 35, 43, 44, 45, 64	15	Date imprint/date counter 126	
2	Exposure lock.....42	16	Number of exposures remaining22	
3	Focus mode.....33		17	Movie length64
4	Zoom indicator.....25		18	Aperture45
5	Digital zoom interpolation indicator25		19	Exposure display49
6	Flash mode (built-in flash)30		20	Shutter speed.....45
7	Flash mode (flash unit, available separately from Nikon).....139		21	Image quality91
8	Internal memory indicator.....23		22	Image size.....92
9	Battery level indicator22		23	Exposure compensation34
10	ISO sensitivity.....31, 99		24	Flash exposure compensation108
11	Vibration reduction icon.....23, 128		25	Converter lens setting110
	Focus area.....26, 105		26	Distortion control112
	Focus area (when a face is recognized)105		27	B&W + color96
12	Focus area (when a face is recognized)105		28	Image optimization.....94
13	Self-timer indicator.....32		29	White balance.....97
	"Date not set" indicator144		30	Noise reduction109
14	Time zone indicator123		31	Bracketing.....104
				Continuous shooting mode101

* Differs according to the current shooting mode. Refer to the sections on each mode for details.

Playback

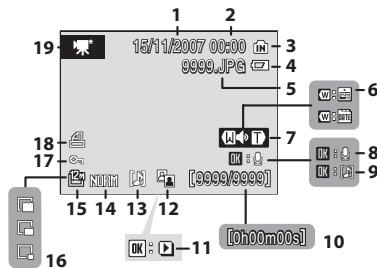

1	Date of recording.....	18	11	Movie playback indicator.....	70
2	Time of recording.....	18	12	D-Lighting icon.....	55
3	Internal memory indicator.....	28	13	Voice memo icon.....	59
4	Battery level indicator.....	22	14	Image quality.....	91
5	File number and type.....	140	15	Image size.....	92
6	Calendar guide/list by date guide	60, 61	16	Small picture indicator.....	57
7	Volume indicator.....	59, 70	17	Protect icon.....	118
8	Voice memo recording guide.....	59	18	Print-order icon.....	87
9	Voice memo playback guide.....	59	19	Movie indicator*.....	70
10	Current frame number/ total number of frames.....	28			
	Movie length.....	70			

* Differs according to the selected movie option.

Basic Operations

The Mode Dial

Align the mode icon with the mark next to the mode dial.

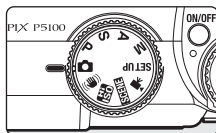

Auto (22): Choose this simple “point-and-shoot” mode, suited to first-time users of digital cameras, in which the camera automatically adjusts settings.

Anti-shake (43): Prevent or reduce blur using vibration reduction (128) and the Best Shot Selector (BSS) (101).

High sensitivity (44): Choose this mode to reduce blur when the subject is poorly lit.

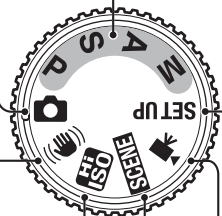

P,S,A,M (45): Choose these modes for greater control over shutter speed and aperture.

SET UP Setup (89): Display the setup menu, where you can perform such tasks as setting the camera clock and adjusting monitor brightness.

Movie (64): Choose this mode to shoot movies.

SCENE Scene (35): Choose this mode for automatic adjustment of settings to suit the selected subject type, or use the voice recording option to record sound only.

The Command Dial and Fn (FUNC) Button

Rotate the command dial, and use the dial with **Fn**, to select mode or menu quickly and change settings.

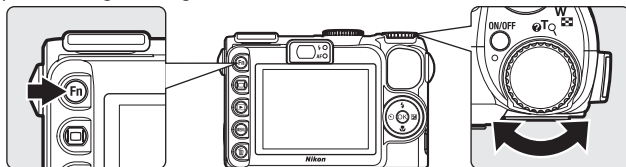

With Shooting

Mode	Use	Description	
P (Programmed auto)		Rotate the command dial to choose flexible program.	46
S (Shutter-priority auto)		Rotate the command dial to adjust shutter speed.	47
A (Aperture-priority auto)		Rotate the command dial to adjust aperture.	48
M (Manual)		Rotate the command dial to adjust shutter speed or aperture. Press the multi selector to select a different option.	49
P, S, A or M	Fn +	Press Fn and rotate the command dial to adjust the setting assigned to Fn . At the default setting, the ISO sensitivity setting can be adjusted.	132
SCENE	Fn +	Press Fn and rotate the command dial to choose a scene mode.	35
(movie)	Fn +	Press Fn and rotate the command dial to choose a movie option.	65

With Playback

Mode	Use	Description	
Playback	Fn +	Press Fn and rotate the command dial to switch between calendar mode and list by date mode.	60, 61
Full-frame playback		Rotate the command dial to switch to the thumbnail wheel playback.	52
Thumbnail playback or Thumbnail wheel playback		Rotate the command dial to choose a picture.	51, 52
Playback zoom		Rotate the command dial to zoom in on the current picture.	53
Movie/Audio playback		Rotate the command dial to fast-forward or rewind.	70, 74

The Multi Selector

This section describes standard uses of the multi selector to select modes, select menu options and to apply selection.

With Shooting

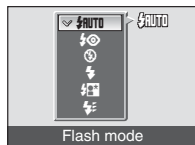
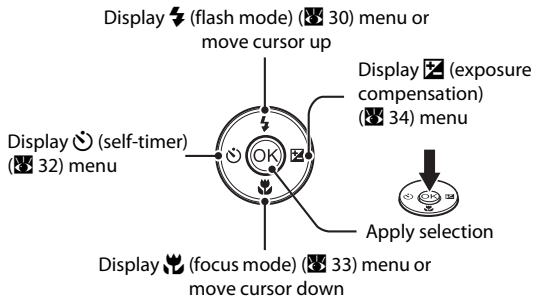

With Playback

Choose the previous picture

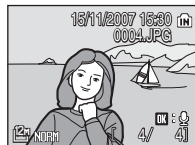
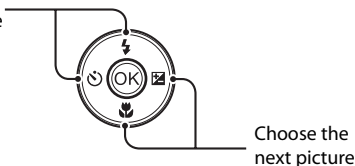

With Menu Screens

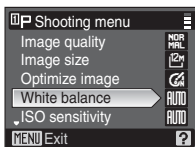
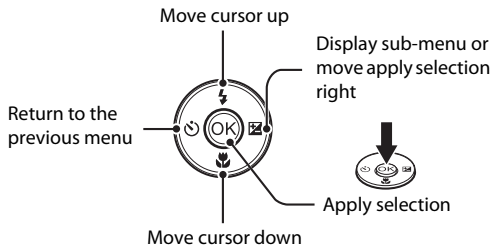

Notes on the Multi Selector

In the manual, the button indicating up, down, left and right of the multi selector is shown as ▲, ▼, ◀, and ▶.

The MENU Button

Press **MENU** to display the menu for the selected mode. Use the multi selector to navigate the menu (10). Menu options can also be selected by rotating the command dial.

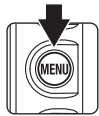

Displayed when there are one or more menu items to follow

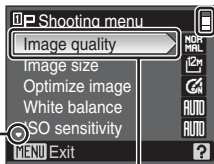

The selected option

Displayed when the menu contains two or more pages

Displayed when there are more previous menu items



Press **OK** or the multi selector **▶** to proceed to the next set of options.

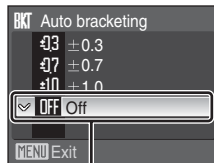

Press **OK** or the multi selector **▶** to apply selection.

Help Displays

Rotate the zoom control to **T** (?) when (?) is displayed at the lower right of the menu screen to view a description of the currently selected menu option.

To return to the original menu, rotate the zoom control to **T** (?) again.

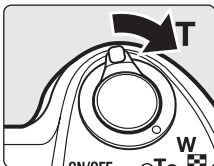



The Button

To hide or show monitor indicators during shooting and playback, press .

With Shooting

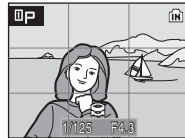
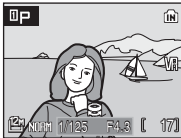
Current settings



Framing guides
 (())**P**, **S**, **A**, and **M** modes only)

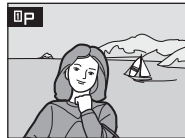

View through lens only



Monitor off (**P**, **S**, **A**, and **M** modes only). Shooting is available only when camera is in focus (AF lamp is lit).



With Playback

Photo information displayed



Shooting data displayed
 (see below)

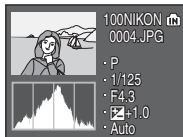





Photo information hidden



Shooting data: Shows the folder name, file name, exposure mode, shutter speed, aperture, exposure compensation, ISO sensitivity, and histogram for the current picture. Shooting data are not displayed if the current picture is a movie.

- **Exposure mode:** **P**, **S**, **A**, or **M** ( 45). **P** is also displayed on pictures shot in  (auto),  (anti-shake),  (high sensitivity), and **SCENE** (scene) modes.
- **Histogram:** A graph showing tone distribution. The horizontal axis corresponds to pixel brightness, with dark tones to the left and bright tones to the right; the vertical axis shows number of pixels of each brightness in image.

Attaching the Camera Strap

Attach both ends of the camera strap to the eyelet as shown below.

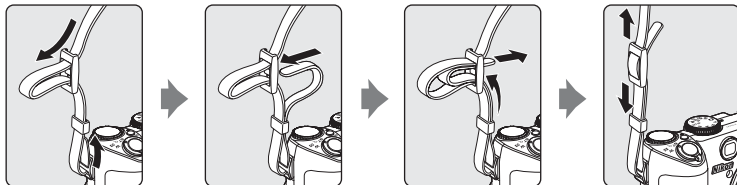

Charging the Battery

Charge the supplied Rechargeable Li-ion Battery EN-EL5 with the supplied Battery Charger MH-61 before first use or when the battery is running low.

1 Plug the charger in

Connect the power cable to the charger ① and then plug it into an electrical outlet ②. The CHARGE lamp will light ③.

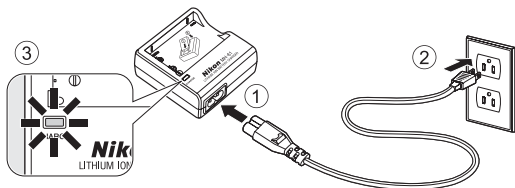

2 Charge the battery

Remove the battery terminal cover and insert the battery as shown, matching the projections on the battery to the indentations in the charger.

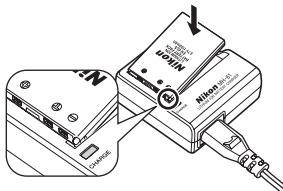

The CHARGE lamp will blink ① as the battery recharges. Charging is complete when the CHARGE lamp stops blinking ②.

A fully-exhausted battery will charge in about two hours.

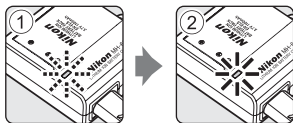

CHARGE lamp	Description
Blinks	Battery charging.
On	Battery fully charged.
Flickers	<ul style="list-style-type: none"> Use the charger at an ambient temperature range of 5 to 35 °C (41 to 95 °F) to charge the battery. The battery is faulty. Unplug the charger immediately and stop charging the battery. Bring the battery and charger to a Nikon-authorized service representative for inspection.

- 3** When the charging is complete, remove the battery and unplug the power cable from the electrical outlet.

The Battery Charger

- The supplied Battery Charger MH-61 is for use only with the Rechargeable Li-ion Battery EN-EL5.
- Be sure to read and follow the warnings and cautions on pages iii to iv of this manual, before using the battery charger.

Inserting the Battery

Insert a Rechargeable Li-ion Battery EN-EL5 (supplied) into the camera. Charge the battery before first use or when the battery is running low (14).

- 1 Open the battery-chamber/memory card slot cover.

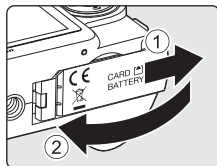

- 2 Insert the battery.

Confirm that the positive (+) and negative (-) terminals are oriented correctly, as described on the label at the entrance of the battery chamber, and insert the battery.

Use the side of the battery to push the orange battery latch up 1 as the battery is inserted 2. The latch drops back into place when the battery is fully inserted.

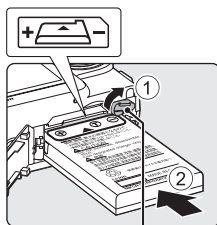

Battery latch

✓ Inserting the Battery

Inserting the battery upside down or backwards could damage the camera. Be sure to check the battery is in the correct orientation.

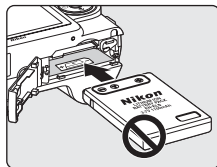

- 3 Close the battery-chamber/memory card slot cover.

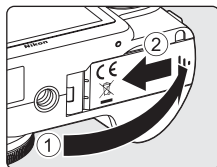

Removing the Battery

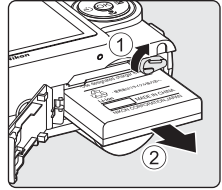

Turn the camera off and confirm that the power-on lamp is off before removing the battery. To eject the battery, open the battery-chamber/memory card slot cover and slide the battery latch in the direction shown ①. The battery can then be removed by hand ②.

- Note that the battery may become hot during use; observe due caution when removing the battery.



Turning On and Off the Camera

To turn on the camera, press the power switch. The power-on lamp (green) will light and the monitor will turn on. To turn off the camera, press the power switch again.

If the camera is turned off, hold down  to turn the camera on in playback mode ( 28).

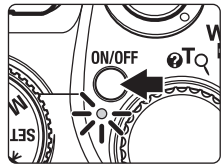

Notes on the Battery

- Only the Rechargeable Li-ion Battery EN-EL5 can be used. **Do not, under any circumstances, attempt to use another type of battery.**
- Be sure to read and follow the warnings for the battery on page iii and the section "Caring for the Camera" ( 141), before using the battery.

AC Adapter

The AC Adapter EH-62A (available separately from Nikon) can be used to power the COOLPIX P5100 from an electrical outlet. Do not, under any circumstances, use another make or model of AC adapter. Failure to observe this precaution could result in overheating or in damage to the camera.

Download from www.Somanuals.com. All Manuals Search And Download.

Setting Display Language, Date and Time

A language-selection dialog is displayed the first time the camera is turned on.

1 Press the power switch to turn on the camera.

The power-on lamp will light and the monitor will turn on.

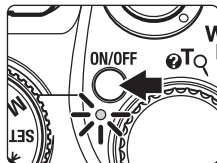

2 Use the multi selector to choose the desired language and press **OK**.

For information on using the multi selector, see "The Multi Selector" (10).



3 Choose [Yes] and press **OK**.

If [No] is selected, the date and time will not be set.

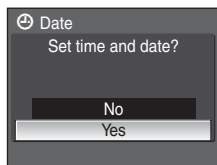

4 Press **OK**.

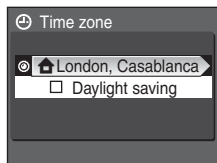

Daylight Saving Time

If daylight saving time is in effect, turn on [Daylight saving] in the time zone menu and set the date.

- 1 Before pressing **OK**, press the multi selector ▼ to choose [Daylight saving].
- 2 Press **OK** to enable daylight saving time (✓). Pressing **OK** toggles the daylight saving time option on and off.
- 3 Press the multi selector ▲, and then press **OK** to proceed to step 5.

When daylight saving time ends, turn [Daylight saving] off from the date menu (123) in the setup menu. The camera's clock is automatically set back one hour.

5 Select your home time zone (F125) and press **OK**.

The date menu is displayed.



6 Edit the date.

- Press the multi selector ▲ or ▼, to edit the highlighted item.
- Press the multi selector ► to highlight the day ([D]), month ([M]), year ([Y]), time, minute, and date display order. Press the multi selector ◀ to highlight items in reverse order (order may differ in some regions).

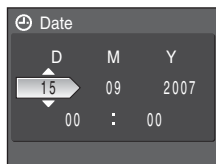

7 Choose the order in which the day, month and year are displayed and press **OK** or the multi selector ►.

The settings are applied and monitor display exits to shooting mode.

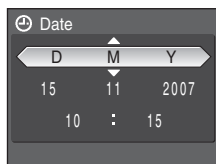

Editing the Date and Time

To edit the date and time, select [Date] from the [Date] menu (F123) in the setup menu (F120) and follow the procedure described in step 6.

Download from [Www.Somanuals.com](http://www.Somanuals.com). All Manuals Search And Download.

Inserting Memory Cards

Pictures are stored in the camera's internal memory (approx. 52 MB) or on removable Secure Digital (SD) memory cards (available separately) (Ⓜ 137).

If a memory card is inserted in the camera, pictures are automatically stored on the memory card and pictures recorded to the memory card can be played back, deleted or transferred. Remove the memory card to store pictures in the internal memory, or play back, delete or transfer pictures from the internal memory.

First Steps

1 Turn the camera off and open the battery-chamber/memory card slot cover.

If the power-on lamp is lit, press the power switch to turn off the camera.

Make sure that the camera is off (power-on lamp is off) before inserting or removing the memory card.

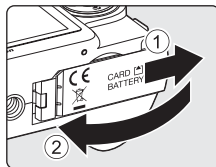

2 Insert the memory card.

Slide the memory card in correctly until it clicks into place.

Close the battery-chamber/memory card slot cover.

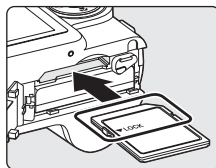

Inserting Memory Cards

Inserting the memory card upside down or backwards could damage the camera or the memory card. Make sure that the memory card is correctly oriented.

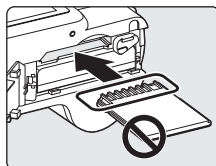

Removing Memory Cards

Before removing memory cards, **turn the camera off** and confirm that the power-on lamp is off. Open the battery-chamber/memory card slot cover and press the card in ① to partially eject the card ②. The card can then be removed by hand.

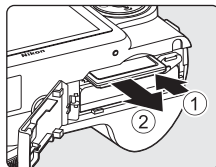

✔ Formatting Memory Cards

If the message at right is displayed, the memory card must be formatted before use (☒ 131). Note that **formatting permanently deletes all pictures** and other data on the memory card. Be sure to make copies of any pictures you wish to keep before formatting the memory card.

Use the multi selector to choose [Yes] and press **OK**. The confirmation dialog will be displayed. To start formatting, choose [Format] and press **OK**.

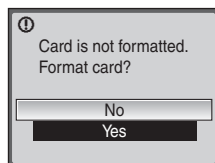

• **Do not turn the camera off or open the battery-chamber/memory card slot cover until formatting is complete.**

• The first time you insert the memory cards used in other devices into the COOLPIX P5100, be sure to format them (☒ 131) with this camera.

✔ The Write Protect Switch

SD memory cards are equipped with a write protect switch. Pictures cannot be recorded or deleted and the memory card cannot be formatted when this switch is in the "lock" position. Unlock by sliding the switch to the "write" position.

Write protect switch

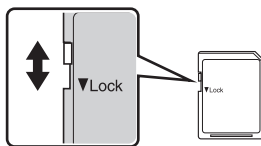

✔ Memory Cards

- Use only Secure Digital memory cards.
- Do not perform the following during formatting, while data is being written to or deleted from the memory card, or during data transfer to a computer. Failure to observe this precaution could result in the loss of data or in damage to the camera or memory card:
 - Eject the memory card
 - Remove the battery
 - Turn off the camera
 - Disconnect the AC adapter
- Do not disassemble or modify.
- Do not drop, bend, or expose to water or strong physical shocks.
- Do not touch the metal terminals with your fingers or metal objects.
- Do not affix labels or stickers to the memory card.
- Do not leave in direct sunlight, closed vehicles or areas exposed to high temperatures.
- Do not expose to humidity, dust, or to corrosive gases.

Step 1 Turn the Camera On and Select (Auto) Mode

This section describes how to shoot in  (auto) mode, an automatic, “point-and-shoot” mode recommended for first-time users of digital cameras.

- 1 Rotate the mode dial to .

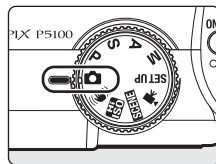

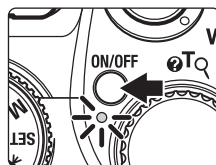

- 2 Press the power switch to turn on the camera.

The power-on lamp will light, the monitor will turn on, and the lens will extend.



- 3 Check the battery level and number of exposures remaining.

Battery Level

Monitor	Description
NO INDICATOR	Battery fully charged.
	Battery low; prepare to charge or replace the battery.
 Warning! Battery exhausted.	Cannot shoot pictures. Recharge or replace with a fully-charged battery.

Battery level indicator

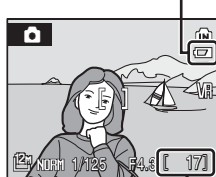

Number of exposures remaining





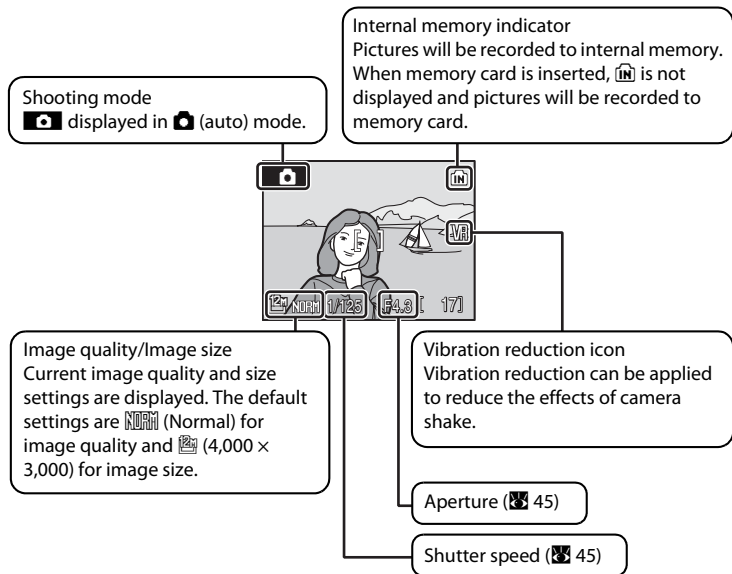

Number of Exposures Remaining

The number of pictures that can be stored depends on the capacity of the memory or memory card, image quality, and image size.

Indicators Displayed in (Auto) Mode



Available Functions in (Auto) Mode

In  (auto) mode, focus mode ( 33) and exposure compensation ( 34) can be applied and the camera can shoot using the flash mode ( 30) and self-timer ( 32). Pressing **MENU** displays the shooting menu options for specifying the image quality ( 91) and image size ( 92).

Vibration Reduction

[Vibration reduction] ( 128), when [On] (default setting) is selected, can be applied to effectively reduce blur, caused by slight hand movement known as camera shake, that commonly occurs when shooting with zoom applied or at slow shutter speeds.

Vibration reduction can be used in all shooting modes.

Auto Power-Off in (Auto) Mode (Standby Mode)

The monitor will dim to reduce the drain on the battery if no operations are performed for about five seconds. The monitor will brighten when camera controls are used. At default settings, the monitor will turn off altogether if no operations are performed for about a minute during shooting and playback. The camera will turn off automatically if no operations are performed for another three minutes ( 130).

Step 2 Frame a Picture

1 Ready the camera.

Hold the camera steadily in both hands, keeping your fingers and other objects away from the lens, built-in flash and self-timer lamp.

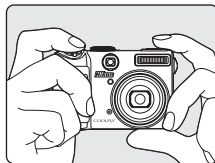

When shooting in "tall" (portrait) orientation, hold the camera so that the built-in flash is up.

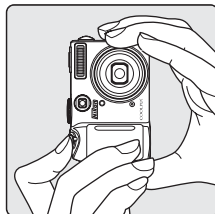

2 Frame the picture.

Position the main subject near the center of the monitor.

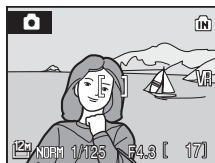





Using the Viewfinder

Use the viewfinder to frame pictures when bright light makes it difficult to see the display in the monitor.

The Viewfinder

As the area visible in the viewfinder may differ from that of the final picture, use the monitor to frame pictures in the following situations:

- When shooting at ranges of about 1 m (3 ft. 3 in.) or less
- When a converter lens is used (available separately from Nikon;  110, 138)
- When digital zoom is applied ( 25, 129)
- When shooting at an image size of  (3,984 × 2,656),  (3,968 × 2,232), or  (2,992 × 2,992)

Download from Www.Somanuals.com. All Manuals Search And Download.

Using the Zoom

Use the zoom control to activate optical zoom. Rotate the zoom control to **W** (📷) to zoom out, increasing the area visible in the frame, or **T** (🔍) to zoom in so that the subject fills a larger area of the frame.

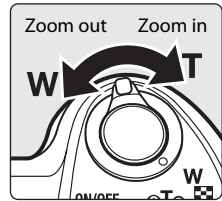

When the camera is zoomed in to the maximum magnification (3.5x), rotating and holding the zoom control at **T** (🔍) triggers digital zoom. The subject is magnified up to 4x, for a total magnification of 14x.

When digital zoom is in effect, the camera will focus on the subject in the center focus area.

A monitor indicator shows the current zoom ratio.

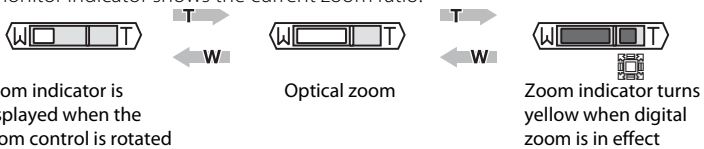

Zoom indicator is displayed when the zoom control is rotated

Optical zoom

Zoom indicator turns yellow when digital zoom is in effect

✓ Digital Zoom and Image Quality

If possible, digital zoom will create a picture by cropping the area visible in the monitor to the current image size (📷 92), increasing magnification without affecting quality.

If the crop would be smaller than the current image size, additional pixels are added through a process known as interpolation, creating a slightly “grainy” image.

The amount of zoom available before interpolation is used depends on the option currently selected for image size, as shown in the following table. The camera pauses temporarily in its zooming operation when it reaches the maximum zoom ratio possible before interpolation is used.

📷 is displayed when interpolation is in effect.

Maximum zoom ratio without interpolation

Image size	Zoom ratio
📷, 📷, 📷, 📷, 📷	3.5x (up to the maximum optical zoom ratio)
📷	4.2x (digital zoom up to 1.2x)
📷	4.9x (digital zoom up to 1.4x)
📷	6.3x (digital zoom up to 1.8x)

Image size	Zoom ratio
📷	8.4x (digital zoom up to 2.4x)
📷	10.5x (digital zoom up to 3.0x)
📷	13.3x (digital zoom up to 3.8x)
📷	14x (digital zoom up to 4x)

Digital zoom can be limited to the range at which interpolation is not in effect, or it can be turned off (📷 129).

Step 3 Focus and Shoot

1 Press the shutter-release button halfway.

The camera automatically focuses on the subject in the center focus area.

When the subject in focus, the focus area will glow green, and the green AF lamp next to the viewfinder will light.

When the camera is unable to focus, the focus area blinks red, and the AF lamp will flicker. Change the composition and try again.

When digital zoom is in effect, the focus area will not be displayed and the camera will focus on the subject in the center focus area.

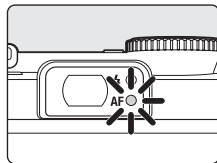
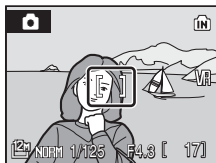
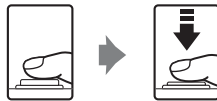

2 Press the shutter-release button the rest of the way down.

The picture will be recorded to the memory card or internal memory.



Shutter-release Button

The camera features a two-stage shutter-release button. To set focus and exposure, press the shutter-release button halfway, stopping when you feel resistance. Focus and exposure lock while the shutter-release button is held in this position. To release the shutter and shoot, press the shutter-release button the rest of the way down.

Do not use force when pressing the shutter-release button, as this may result in camera shake and blurred pictures.



Press the shutter-release button halfway to set focus and exposure.

Press the shutter-release button the rest of the way down to shoot.

✓ During Recording

While pictures are being recorded, the ⏸ (wait) icon will be displayed, the 📷 or 📷 (when a memory card is inserted in the camera) icon blinks, and the AF lamp blinks. Do not turn the camera off, open the battery-chamber/memory card slot cover, or remove or disconnect the power source while these icons are displayed. Cutting power or removing the memory card in these circumstances could result in loss of data or in damage to the camera or card.

✎ Autofocus

Autofocus may not perform as expected in the following situations. In some rare cases, the subject may not be in focus despite the fact that the active focus area and the AF lamp glow green:

- Subject is very dark
- Objects of sharply differing brightness are included in the scene (e.g. the sun is behind the subject and is in deep shadow)
- No contrast between the subject and surroundings (e.g. when the subject is standing in front of a white wall, wearing a white shirt)
- Several objects are at different distances from the camera (e.g. the subject is inside a cage)
- Subject is moving rapidly

In the situations noted above, try pressing the shutter-release button halfway to refocus several times, or focus on another subject and use focus lock. When using focus lock, be sure that the distance between the camera and the subject with which focus was locked is the same as that for the actual subject.

🔒 Focus Lock

To focus on an off-center subject when [Center] is selected for [AF area mode], use focus lock as described below.

- Be sure that the distance between the camera and the subject does not change while focus is locked.
- When the shutter-release button is pressed halfway, exposure is locked.



Position the subject in the center focus area.



Press the shutter-release button halfway.



Confirm that the focus area is green.

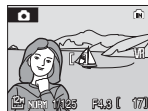

Continue holding down the shutter-release button halfway and recompose the picture.



Press the shutter-release button the rest of the way down.

🔒 AF-assist Illuminator and Flash

If the subject is poorly lit, the AF-assist illuminator may light by pressing the shutter-release button halfway, or the flash may fire by pressing the shutter-release button all the way down. The illuminator has a range of about 1.9 m (6.2 ft.) at the maximum wide-angle position and about 1.1 m (3.6 ft.) at the maximum telescopic position. The AF-assist illuminator can be set to [Off] manually (🔑 129), although in this case the camera may not focus when lighting is poor.







Download from Www.Somanuals.com. All Manuals Search And Download.

Step 4 Viewing and Deleting Pictures

Viewing Pictures (Playback Mode)



Press .

The last picture shot will be displayed in full-frame playback mode.

Press the multi selector , , , or  to view additional pictures. Hold down the multi selector , , , or  to fast forward pictures.

Pictures may be displayed briefly at low resolution while being read from the memory card or internal memory.

Press  or the shutter-release button to switch to shooting mode.

When  is displayed, pictures stored in the internal memory will be displayed. When memory card is inserted,  is not displayed and pictures stored on the memory card will be displayed.

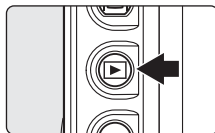



Internal memory

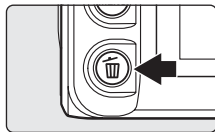

Deleting Pictures

- 1 Press  to delete the picture currently displayed in the monitor.







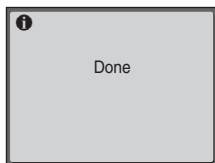
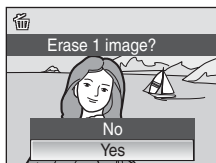





- 2 Use the multi selector to select [Yes] and press .

To exit without deleting the picture, choose [No] and press .



Playback Mode

The following options are available in full-frame playback mode.

Option	Use	Description	
Playback zoom	T (Q)	Press T (Q) to enlarge view of picture currently displayed in monitor, up to about 10x. Press OK to return to full-frame playback mode.	53
View thumbnails	W 	Press W  to display four-, nine- or 16- picture thumbnails.	51
Display thumbnail wheel		Rotate the command dial to display the thumbnail wheel.	52
Hide or show photo info		Hide or show photo info in monitor.	12
Record/play voice memo		Press  to record or play back voice memos up to 20 seconds in length.	59
Switch to shooting mode	  	Press  or the shutter-release button to switch to the mode selected with the mode dial.	28

Pressing to Turn On the Camera

When the camera is off, holding down  will turn the camera on in playback mode. The lens does not extend.

Viewing Pictures

Pictures stored in the internal memory can only be viewed if no memory card is inserted.

Deleting the Last Picture Shot

In shooting mode, press  to delete the last picture shot.

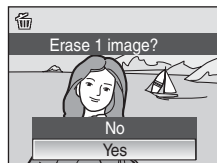

Using the Flash

The flash has a range of about 0.3-8 m (1-26 ft. 2.9 in.) when the camera is zoomed out all the way. With maximum optical zoom applied, the range is about 0.3-4 m (1-13 ft. 1.5 in.) (when [ISO sensitivity] is set to [Auto]). The following flash modes are available.

Auto (default setting for (auto) mode)

Flash fires automatically when lighting is poor.

Auto with red-eye reduction

Reduces "red-eye" in portraits ( 31).

Off

Flash will not fire even when lighting is poor.

Fill flash

Flash fires when a picture is shot. Use to "fill-in" (illuminate) shadows and back-lit subjects.

Slow sync

 (auto) is combined with slow shutter speed.

Flash illuminates main subject; slow shutter speeds are used to capture background at night or under dim light.

Rear-curtain sync

Flash fires just before shutter closes, creating effect of a stream of light behind moving subjects.

Setting the Flash Mode



1 Press .

The flash menu is displayed.



2 Use the multi selector to choose the desired flash mode and press .

The icon for the selected flash mode is displayed at the top of the monitor.

When  (auto) is applied,  is only displayed for five seconds.

If a setting is not applied by pressing  within a few seconds, the selection will be cancelled.

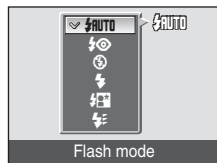

✓ Shooting When Lighting Is Poor and the Flash Is Disabled (📷)

- Use of a tripod is recommended to stabilize the camera during shooting and avoid the effects of camera shake. Turn vibration reduction (📷 128) off when using a tripod.
- Place the camera on a flat, level surface or use a tripod (recommended).
- The 📷 symbol is displayed when the camera automatically increases sensitivity to minimize blur caused by slow shutter speed. Pictures shot when 📷 is displayed may be slightly mottled.

✓ Note on Using the Flash

When using the flash at a wide-angle zoom position, reflections from dust particles in the air may appear as bright spots in pictures. To reduce these reflections, set the flash to 📷 (Off) or zoom in on the subject.

🔧 The Flash Lamp

The flash lamp indicates flash status when the shutter-release button is pressed halfway.

- **On:** Flash will fire when picture is shot.
- **Blinks:** Flash charging. Wait a few seconds and try again.
- **Off:** Flash will not fire when picture is shot.

When pictures are shot using the flash and a low battery, the monitor display will turn off and the flash lamp will blink until the flash is fully charged.

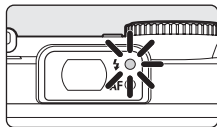

🔧 The Flash Mode Setting

In 📷 (auto), high-sensitivity shooting, **P**, **S**, **A**, and **M** modes, the default setting is 📷 (auto). When any flash mode other than 📷 (auto with red-eye reduction) is applied in 📷 (auto) mode, the setting is only enabled until the camera is turned off. Turning the camera off returns flash mode to 📷 (auto). When flash mode is applied in a scene mode, the setting is only enabled until another shooting mode is selected or the camera is turned off.

🔧 Red-eye Reduction

This camera uses advanced red-eye reduction ("In-Camera Red-Eye Fix"). The flash fires repeatedly at low intensity before the main flash, reducing red-eye. The camera then analyzes the picture; if red-eye is detected, the affected area will be processed to further reduce red-eye before the picture is saved. Note that because there is a slight lag between the shutter-release button being pressed and the picture being shot, this mode is not recommended when a quick shutter response is required. The time before the next picture can be shot also increases slightly. Advanced red-eye reduction may not produce the desired results in all situations. In extremely rare instances, areas not subject to red-eye may be affected by advanced red-eye reduction processing; in these cases, choose another mode and try again.

🔍 More Information

See "Using Optional Speedlights" (📷 139) for more information.

Shooting with the Self-timer

The camera is equipped with a ten-second and three-second timer for self-portraits. When using the self-timer, use of a tripod is recommended. Turn vibration reduction ( 128) off when using a tripod.

1 Press (self-timer).

The self-timer menu is displayed.



2 Use the multi selector to choose [10s] or [3s] and press .

[10s] (ten seconds): Suited for important occasions (such as weddings)

[3s] (three seconds): Suited for preventing camera shake

The mode selected for self-timer is displayed.

If a setting is not applied by pressing  within a few seconds, the selection will be cancelled.

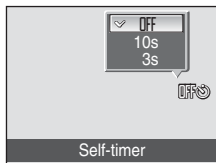

3 Frame the picture and press the shutter-release button halfway.

Focus and exposure will be set.

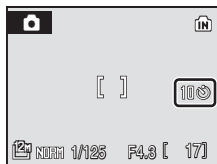

4 Press the shutter-release button the rest of the way down.

The self-timer starts and the self-timer lamp will blink. The lamp stops blinking one second before the photograph is shot and remains lit until the shutter is released.

The number of seconds remaining before the shutter is released is displayed in the monitor. When the shutter is released, the self-timer turns off.

To stop the timer before a picture is shot, press the shutter-release button again.

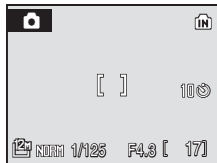

Choosing a Focus Mode

Choose a focus mode according to the subject and composition.

AF Autofocus

Camera automatically adjusts focus according to distance to subject. Use when the distance from subject to lens is 30 cm (1 ft.) or more, or 70 cm (2 ft. 4 in.) or more when camera is zoomed all the way out.

∞ Infinity

Use when shooting distant scenes through foreground objects such as windows or when shooting landscapes at ranges of 5 m (16 ft. 5 in.) or more. Flash turns off automatically.

🌸 Macro close-up

Use for close-ups. If zoomed in or out until **🌸** icon in display turns green, camera can focus on objects as close as 4 cm (1.6 in.) to lens. Camera focuses continuously until shutter-release button is pressed halfway.

Setting the Focus Mode

1 Press **🌸** (focus mode).

The focus menu is displayed.



2 Use the multi selector to choose the desired focus mode and press **OK**.

The icon for the selected focus mode is displayed at the top of the monitor.

When **AF** (autofocus) is applied, **AF** is only displayed for five seconds.

If a setting is not applied by pressing **OK** within a few seconds, the selection will be cancelled.



📎 Macro Close-up Mode

In macro close-up mode, the camera focuses continuously, even when the shutter-release button is not pressed halfway to lock focus.

However, in **P**, **S**, **A**, and **M** modes, the setting of [Auto-focus mode] (🌸 107) will be applied.

📎 The Focus Mode Setting

In **📷** (auto), anti-shake, high-sensitivity shooting, **P**, **S**, **A**, and **M** modes, the default setting is **AF** (autofocus). The focus mode applied in **📷** (auto) mode will be restored to its default setting when another shooting mode is selected or the camera is turned off. The focus mode applied in scene mode will be restored to its default setting when another shooting mode is selected or the camera is turned off.

Download from [Www.Somanuals.com](http://www.Somanuals.com). All Manuals Search And Download.

Exposure Compensation

Exposure compensation is used to alter exposure from the value suggested by the camera to make pictures brighter or darker.

1 Press (exposure compensation).

The exposure compensation value will be displayed.

Exposure compensation is not available in mode **M** (manual).



2 Press the multi selector or to adjust exposure.

The exposure compensation menu is displayed.

When the picture is too dark, adjust the exposure compensation in the positive (+) direction.

When the picture is too bright, adjust the exposure compensation in the negative (-) direction.

Exposure compensation can be set to values between -2.0 and +2.0 EV in increments of 1/3 EV.

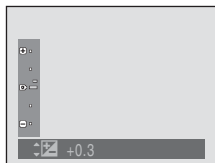

3 Press the shutter-release button to shoot.

Repeat steps 2 and 3 to shoot while adjusting the exposure compensation value a little at a time.



4 Press .

When an exposure compensation value other than [0.0] is applied, the value is displayed with the  icon in the monitor.

To cancel exposure compensation, select [0.0] before pressing , or follow steps 1 and 2 to select [0.0].

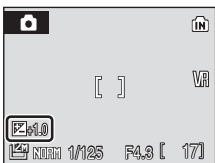

Exposure Compensation Value

When exposure compensation is adjusted in  (auto) mode, a scene mode, or anti-shake mode, the setting is only enabled until another shooting mode is selected or the camera is turned off.

Switching to another shooting mode or turning the camera off cancels exposure compensation and returns to [0.0].

Using Exposure Compensation

The camera tends to lower exposure when the frame is dominated by brightly lit objects and to increase exposure when the frame is mostly dark. *Positive* compensation may therefore be required to capture the brilliancy of very bright objects that fill the frame (for example, sunlit expanses of water, sand, or snow) or when the background is much brighter than the main subject. *Negative* compensation may be called for when large areas of the frame contain very dark objects (for example, a swath of dark green leaves) or when the background is much darker than the main subject.

Shooting in the Scene Mode

Camera settings are automatically optimized for the selected subject type. The following scene modes are available.

The voice recording option can also be selected to record sound only.

Portrait	Party/indoor	Night landscape	Copy
Landscape	Beach/snow	Close up	Backlight
Sports	Sunset	Museum	Panorama assist
Night portrait	Dusk/dawn	Fireworks show	Voice recording*

* See "Voice Recordings" (71).

Setting the Scene Mode

- 1 Rotate the mode dial to **SCENE**.

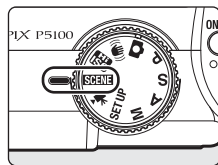

- 2 Press **MENU** to display the scene menu screen, choose the desired scene with the multi selector and press **OK**.

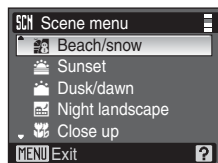
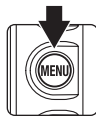

- 3 Frame the subject and shoot.



Using the Command Dial to Select a Scene

A scene can also be selected by holding down **Fn** and rotating the command dial.

Image Quality and Image Size

[Image quality] (91) and [Image size] (92) can be set in the scene menu. Changes made to these settings apply to all shooting modes.

Download from Www.Somanuals.com. All Manuals Search And Download.

Features

Portrait

Use this mode for portraits in which the main subject stands out clearly. Portrait subjects exhibit smooth, natural-looking skin tones.

- The camera detects and focuses on a face looking toward the camera (Shooting with Face-Priority →  106).
- If the camera detects multiple faces, the camera focuses on the face closest to the camera.
- If no face is recognized, the camera will focus on the subject in the center focus area.
- Digital zoom is not available.



* Other settings can be selected.

Landscape











Use this mode for vivid landscapes and cityscapes.

- Camera focuses at infinity. The AF lamp ( 26) always glows green when the shutter-release button is pressed halfway. Note, however, that objects in the foreground may not always be in focus.



* Other settings can be selected.

Icons Used for Descriptions

The following icons are used for descriptions in this section: , flash mode ( 30); , self-timer ( 32); , focus mode ( 33); , exposure compensation ( 34); , AF-assist illumination ( 129).

Scene Mode Settings

Adjustments to the flash mode setting, self-timer setting, focus mode setting, and exposure compensation value applied in any scene mode are cancelled and these settings return to their default values whenever another shooting mode is selected or the camera is turned off.

Sports

Use this mode for dynamic action shots that freeze the action in a single shot and record motion in a series of pictures.

- While the shutter-release button is pressed halfway, the camera focuses continuously until focus is acquired and locked.
- While the shutter-release button is held down, the camera shoots at a rate of about 1.1 frames per second (fps) when image quality is set to Normal and image size is set to  (4,000 × 3,000). This rate is maintained for up to 5 pictures. Focus, exposure compensation, and white balance are fixed at values determined with the first shot in each series.
- The maximum frame rate with continuous shooting may vary depending upon the current image mode setting and the memory card used.
- Camera focuses on subject in center of frame.



* Other settings can be selected.

Night portrait

Use this mode to achieve a natural balance between the main subject and background lighting in portraits shot at night.

- The camera detects and focuses on a face looking toward the camera (Shooting with Face-Priority →  106).
- If the camera detects multiple faces, the camera focuses on the face closest to the camera.
- If no face is recognized, the camera will focus on the subject in the center focus area.
- Digital zoom is not available.

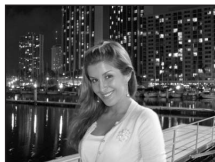

¹ Fill flash with slow sync and red-eye reduction.

² Other settings can be selected.

Party/indoor

Captures the effects of candlelight and other indoor background lighting.



- Camera focuses on subject in center of frame.
- As pictures are easily affected by camera shake, check the [Vibration reduction] ( 128) setting and hold the camera steadily.



¹ Fill flash with slow sync and red-eye reduction. Other settings can be selected.

² Other settings can be selected.

: For those scene modes with , use of a tripod is recommended. Turn vibration reduction ( 128) off when using a tripod.

: Pictures shot in scene modes utilizing  may be processed to reduce noise and therefore take longer to record.

Shooting in the Scene Mode

Beach/snow

Captures the brightness of such subjects as snowfields, beaches, or sunlit expanses of water.

- Camera focuses on subject in center of frame.



* Other settings can be selected.

Sunset

Preserves the deep hues seen in sunsets and sunrises.

- Camera focuses on subject in center of frame.



* Other settings can be selected.

Dusk/dawn



Preserves the colors seen in the weak natural light before sunrise or after sunset.

- Camera focuses at infinity. When the shutter-release button is pressed halfway, the AF lamp ( 26) always lights. Note, however, focus may not be set for near subjects, while the camera focuses at infinity.



* Other settings can be selected.

: For those scene modes with , use of a tripod is recommended. Turn vibration reduction ( 128) off when using a tripod.

: Pictures shot in scene modes utilizing  may be processed to reduce noise and therefore take longer to record.

Night landscape



Slow shutter speeds are used to produce stunning night landscapes.



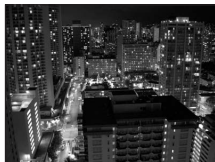



- Camera focuses at infinity. When the shutter-release button is pressed halfway, the AF lamp ( 26) always lights. Note, however, focus may not be set for near subjects, while the camera focuses at infinity.



* Other settings can be selected.

Close up

Photograph flowers, insects and other small objects at close range.



-  (macro close-up) is selected for focus mode ( 33) and the camera automatically zooms to the position at the closest distance at which the camera can focus.
- The camera can focus at distances as close as 4 cm (1.6 in.) at the wide-angle zoom position at which  glows green.
- The closest distance at which the camera can focus varies depending upon zoom position.
- [AF area mode] is set to [Manual] ( 105). When  is pressed, camera focuses on subject in active focus area.
- While the shutter-release button is pressed halfway, the camera focuses continuously until focus is acquired and locked.
- As pictures are easily affected by camera shake, check the [Vibration reduction] ( 128) setting and hold the camera steadily.



* Other settings can be selected. Note that the flash may be unable to light entire subject at distances of less than 30 cm (11.8 in.)

Museum



Use indoors where flash photography is prohibited (for example, in museums and art galleries) or in other settings in which you do not want to use the flash.



- Camera focuses on subject in center of frame.
- [BSS] (Best Shot Selector) ( 101) is used when shooting.
- As pictures are easily affected by camera shake, check the [Vibration reduction] ( 128) setting and hold the camera steadily.



¹ Other settings can be selected.

² Also  (macro close-up) can be selected.

 For those scene modes with , use of a tripod is recommended. Turn vibration reduction ( 128) off when using a tripod.

 Pictures shot in scene modes utilizing  may be processed to reduce noise and therefore take longer to record.

Download from [Www.Somanuals.com](http://www.Somanuals.com). All Manuals Search And Download.

Shooting in the Scene Mode

Fireworks show



Slow shutter speeds are used to capture the expanding burst of light from a firework.

- Camera focuses at infinity. When the shutter-release button is pressed halfway, the AF lamp ( 26) always lights. Note, however, focus may not be set for near subjects, while the camera focuses at infinity.



Copy

Provides clear pictures of text or drawings on a white board or in print.

- Camera focuses on subject in center of frame.
- Use  (macro close-up) mode ( 33) in focus mode with this mode to focus at short ranges.
- Colored text and drawings may not show up well.

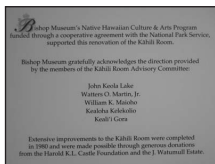

¹ Other settings can be selected.

² Also  (macro close-up) can be selected.



Backlight

Use when light is coming from behind your subject, throwing features or details into shadow. The flash fires automatically to “fill in” (illuminate) shadows.

- Camera focuses on subject in center of frame.



* Other settings can be selected.

 For those scene modes with , use of a tripod is recommended. Turn vibration reduction ( 128) off when using a tripod.

Download from Www.Somanuals.com. All Manuals Search And Download.

Panorama assist



Use when shooting a series of pictures that will later be joined to form a single panorama using the supplied Panorama Maker software.



- Camera focuses on subject in center of frame.



* Other settings can be selected.

Shooting Pictures for a Panorama





The camera focuses on the subject in the center of the frame. Use a tripod for best results. Turn vibration reduction ( 128) off when using a tripod.

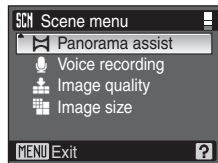





- Use the multi selector to choose [ Panorama assist] in the scene menu and press .

The yellow panorama direction icon () is displayed to show the direction in which pictures will be joined.



- Use the multi selector to choose the direction and press .

Select how pictures will be joined together in the completed panorama; right () , left () , up () or down () .

The panorama direction icon () is displayed to the direction pressed and changes to white when  is pressed. Apply flash mode ( 30), self-timer ( 32), focus mode ( 33) and exposure compensation ( 34) settings with this step, if necessary. Press  to reselect the direction.



- Shoot the first picture.

The first picture is displayed in the first third of the monitor.



4 Shoot the second picture.

Compose the next picture so that it overlaps the first picture.

Repeat until you have shot the necessary number of pictures to complete the scene.



5 Press **OK** when shooting is completed.

The camera returns to step 2.



Panorama Assist

Flash mode (F30), self-timer (F32), focus (F33) and exposure compensation (F34) settings cannot be adjusted after the first shot. Pictures cannot be deleted, nor can zoom, image quality (F91), or image size (F92) be adjusted until the series is finalized.

The panorama series is terminated if the camera enters standby mode with the auto off function (F130) during shooting. Setting the time allowed to elapse before the auto off function is enabled to a longer setting is recommended.

Exposure Lock

AE/L is displayed to indicate that white balance and exposure have been locked at the values set with the first shot. All pictures shot in a panorama series have the same exposure and white-balance settings.

Panorama Maker

Install Panorama Maker from the supplied Software Suite CD. Transfer pictures to a computer (F77) and use Panorama Maker (F80) to join them in a single panorama.

More Information



Shooting in Anti-shake Mode

In anti-shake mode, [Vibration reduction] (📷 128) is enabled, and [BSS] is selected for [Continuous] (📷 101). In addition, ISO sensitivity is automatically raised to 1600 depending upon the brightness of the subject, and shutter speed is faster than with 📷 (auto) mode, under the same lighting conditions, to reduce blurring caused by camera shake or subject movement. The flash is disabled. This mode is most effective when shooting under natural light. Combine it with the telephoto zoom when you are forced to shoot from a distance, in order to capture a fleeting expression on a portrait subject or to photograph an animal without frightening it off.

1 Rotate the mode dial to (📷).

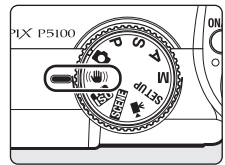

2 Frame the subject and shoot.

Camera focuses on subject in center of frame.

While the shutter-release button is held down, camera shoots up to ten pictures. They are compared and sharpest picture (picture with highest level of detail) is saved.

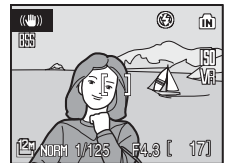

✓ Notes on Anti-shake Mode

- Shutter speed is limited to a certain value for dark subjects.
- Use of the high-sensitivity shooting mode (📷 44) is recommended for shooting subjects under low lighting.
- Pictures shot in this mode may become somewhat grainy.

🔧 Anti-shake Mode Settings

[Vibration reduction] (📷 128) is enabled, and [BSS] is selected for [Continuous] (📷 101); the flash mode is disabled. Focus mode and exposure compensation are available; the self-timer is not available.

📷 Image Quality and Image Size in Anti-shake Mode

When MENU is pressed in anti-shake mode, the anti-shake mode menu is displayed to enable adjustment of image quality (📷 91) and image size (📷 92) settings. Changes made to these settings apply to all shooting modes.

Shooting in High-Sensitivity Shooting Mode

In high-sensitivity shooting mode, sensitivity is increased when shooting under low lighting, to reduce blurring caused by camera shake or subject movement, allowing you to capture the atmosphere of the scene. ISO sensitivity will be automatically increased to a maximum of 1600, depending upon the brightness of the subject.

1 Rotate the mode dial to .

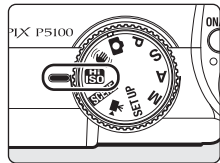

2 Frame the subject and shoot.

By default, the camera automatically chooses the focus area (one of nine) containing the subject closest to the camera and adjusts exposure accordingly ( 26, 105).

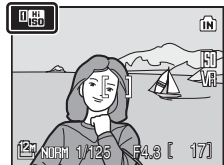



Notes on High-Sensitivity Shooting Mode

- This mode reduces effects of camera shake even for shooting under low lighting; however, when shooting without the flash, use of a tripod is recommended. Turn vibration reduction ( 128) off when using a tripod.
- Pictures shot in this mode may become somewhat grainy.
- Focus may not be precisely fixed in extremely dark places.

High-Sensitivity Shooting and Anti-Shake Modes

Both high-sensitivity shooting mode and anti-shake mode ( 43) reduce blurring caused by camera shake and subject movement. However, high-sensitivity shooting mode is suited for shooting under low lighting. In some circumstances, disabling the flash may make it even easier to capture the true essence of the scene.





In high-sensitivity shooting mode, pressing **MENU** displays the high-sensitivity menu. The items available in this menu are the same as those available in the  (auto) mode shooting menu ( 89), except that [ISO sensitivity] is not available in the high-sensitivity menu. Just as with  (auto) mode, the flash mode, self-timer, focus mode and exposure compensation are available.

In anti-shake mode, [Vibration reduction] ( 128) is enabled, and [BSS] is selected for [Continuous] ( 101), to reduce blurring caused by camera shake or subject movement, and the flash is disabled.

Download from [Www.Somanuals.com](http://www.Somanuals.com). All Manuals Search And Download.

Shooting in P, S, A, and M Modes

P, S, A, and **M** modes offer control over a variety of advanced settings, including shutter speed, aperture, and white balance.

Mode	Description
P Programmed auto ( 46)	Camera sets shutter speed and aperture for optimal exposure. Recommended for snapshots and in other situations in which there is little time to adjust camera settings. Flexible program, which changes the combination of shutter speed and aperture, can be used ( 46).
S Shutter-priority auto ( 47)	User chooses shutter speed; camera selects aperture for best results. Use to freeze or blur motion.
A Aperture-priority auto ( 48)	User chooses aperture; camera selects shutter speed for best results. Use to blur background or bring both foreground and background into focus.
M Manual ( 49)	User controls both shutter speed and aperture.

Shutter Speed and Aperture

The same exposure can be achieved with different combinations of shutter speed and aperture, allowing you to freeze or blur motion and control depth of field. The following figure shows how shutter speed and aperture affect exposure.

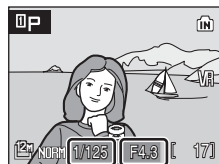

Shutter speed  Aperture 



Fast shutter speed:
1/1,000s

Slow shutter speed:
1/30s

Small aperture (large
f-number): f/7.6

Large aperture (small
f-number): f/2.7

Download from Www.Somanuals.com. All Manuals Search And Download.

Shooting in P (Programmed Auto)

1 Rotate the mode dial to P.

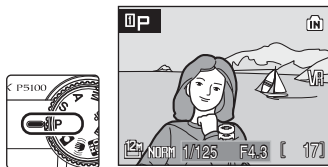

2 Frame the subject, focus, and shoot.

At default setting, the camera automatically selects the focus area containing the closest subject, from nine focus areas, and adjusts focus accordingly (83 105).



Flexible Program

In mode **P**, different combinations of shutter speed and aperture can be selected by rotating the command dial ("flexible program"). While flexible program is in effect, an asterisk (*) appears next to the mode indicator (**P**) in the monitor.

- Rotate the command dial to the right for large apertures (small f-numbers) that blur background details or fast shutter speeds that "freeze" motion.
- Rotate the command dial to the left for small apertures (large f-numbers) that increase depth of field or slow shutter speeds that blur motion.
- To restore default shutter speed and aperture settings, rotate the command dial until the asterisk next to the mode indicator is no longer displayed. Selecting another mode, or turning off the camera, also restores default shutter speed and aperture settings.

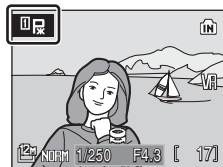
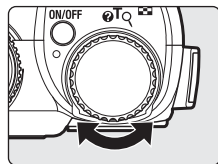

✓ Note on Shutter Speed

When [Continuous], [BSS], [Continuous flash] or [Multi-shot 16] is selected for [Continuous] (83 101), or when a setting other than [Off] is selected for [Auto bracketing] (83 104), the slowest shutter speed available is down to 1/2 sec.

Shooting in S (Shutter-Priority Auto)

- 1** Rotate the mode dial to **S**.

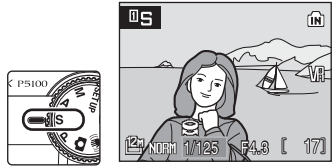

- 2** Rotate the command dial to choose the shutter speed value between 1/2,000 sec. and 8 sec.

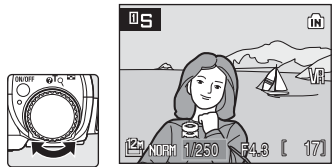

- 3** Focus and shoot.

At default setting, the camera automatically selects the focus area containing the closest subject, from nine focus areas, and adjusts focus accordingly (☒ 105).



☑ S (Shutter-Priority Auto) Mode

- If the selected shutter speed would result in the picture being over- or underexposed, the shutter-speed display will flash when the shutter-release button is pressed halfway. Choose another shutter speed and try again.
- At speeds slower than 1/4 sec, the shutter speed indicator will turn red to show that noise reduction (☒ 109) is recommended to reduce “noise” in the form of randomly-spaced, brightly colored dots.

☑ Note on Shutter Speed

When [Continuous], [BSS], [Continuous flash] or [Multi-shot 16] is selected for [Continuous] (☒ 101), or when a setting other than [Off] is selected for [Auto bracketing] (☒ 104), the slowest shutter speed available is down to 1/2 sec.

☑ Shutter Speed

A shutter speed of 1/2,000s is only available when the camera is zoomed all the way out.

Download from [Www.Somanuals.com](http://www.Somanuals.com). All Manuals Search And Download.

Shooting in A (Aperture-Priority Auto)

- 1 Rotate the mode dial to **A**.

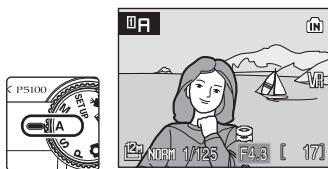

- 2 Rotate the command dial to choose the f-number (aperture value).

When the camera is zoomed all the way out, aperture can be set to values between $f/2.7$ and $f/7.6$; at maximum zoom, aperture can be set to values between $f/5.3$ and $f/7.3$.

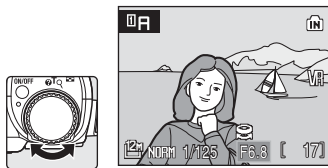

- 3 Focus and shoot.

At default setting, the camera automatically selects the focus area containing the closest subject, from nine focus areas, and adjusts focus accordingly (📷 105).



✓ A (Aperture-Priority Auto) Mode

If the selected aperture would result in the picture being over- or underexposed, the aperture display will flash when the shutter-release button is pressed halfway. Choose another aperture and try again.

✓ Note on Shutter Speed

When [Continuous], [BSS], [Continuous flash] or [Multi-shot 16] is selected for [Continuous] (📷 101), or when a setting other than [Off] is selected for [Auto bracketing] (📷 104), the slowest shutter speed available is down to 1/2 sec.

📷 Aperture and Zoom

Aperture is expressed as an f-number, which is the ratio of the focal length of the lens to the effective diameter of the opening (aperture) through which light enters the camera. Large apertures (expressed by small f-numbers) let more light into the camera, small apertures (large f-numbers) less. When the camera is zoomed out, the focal length of the lens diminishes and the f-number decreases. When the camera is zoomed in, the focal length and f-number increase. In modes **A** and **M**, this effect can be minimized by selecting [On] for [Fixed aperture] (📷 109). Aperture can be controlled in the range of $f/5.1$ to $f/7.3$.

The COOLPIX P5100 has a lens with a focal length of 7.5–26.3 mm and an aperture of $f/2.7$ to $f/5.3$.

Download from Www.Somanuals.com. All Manuals Search And Download.

Shooting in M (Manual)

- 1** Rotate the mode dial to **M**.

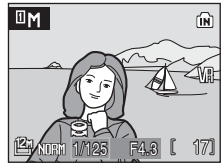

- 2** Press the multi selector **▶** to activate the shutter speed setting.

The active setting switches between shutter speed and aperture each time the multi selector **▶** is pressed.

At speeds slower than 1/4 sec., the shutter speed indicator turns red (Ⓢ 47).

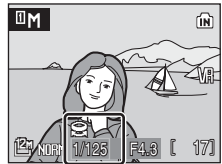

- 3** Rotate the command dial to choose a shutter speed between 1/2,000 sec. and 8 sec.

When adjusting aperture or shutter speed, the degree of deviation from the exposure value measured by the camera is displayed for a few seconds in the exposure display.

The degree of deviation in the exposure display is shown in EVs (-2 to +2 EV in increments of 1/3 EV). A display similar to that illustrated at right indicates that the picture will be overexposed by 1 EV (+1).

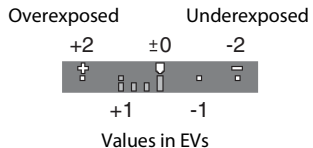
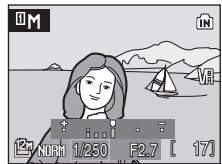

- 4** Press the multi selector **▶** to activate the aperture setting.

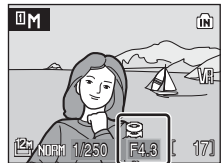

5 Rotate the command dial to choose an aperture value.

Repeat steps 2 to 5 to modify shutter speed and aperture settings until the desired exposure is achieved.

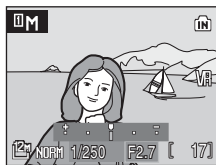

6 Focus and shoot.

At default setting, the camera automatically selects the focus area containing the closest subject, from nine focus areas, and adjust focus accordingly (☒ 105).



☑ Note on Shutter Speed

When [Continuous], [BSS], [Continuous flash], or [Multi-shot 16] is selected for [Continuous] (☒ 101), or when a setting other than [Off] is selected for [Auto bracketing] (☒ 104), the slowest shutter speed available is down to 1/2 sec.

☑ Shutter Speed of 1/2,000 Sec.

A shutter speed of 1/2,000 sec. is available only when the camera is zoomed all the way out.

Viewing Multiple Pictures: Thumbnail Playback

Rotate the zoom control to **W** (📐) (thumbnail playback) in full-frame playback mode (📷 28) to display pictures in “contact sheets” of thumbnail images. The following operations can be performed while thumbnails are displayed.

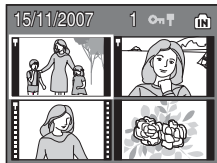

To	Use	Description	📷
Choose pictures		Press the multi selector ▲▼◀▶ to choose pictures.	10
		Rotate the command dial to choose pictures.	–
Change number of pictures displayed	W (📐) T (📷)	Rotate the zoom control to W (📐), display picture thumbnails in the following order: 4 → 9 → 16 Rotate the zoom control to T (📷), the number of thumbnails changes reversely.	–
Cancel thumbnail playback	OK	Press OK .	28
Switch to shooting mode	 	Press or the shutter-release button to switch to the mode selected with the mode dial.	28

Thumbnail Playback Mode Display

When protected (🔒 118) pictures are displayed in thumbnail playback mode (except 16-picture thumbnail playback mode), the icons shown at right are displayed with them. Movies are displayed as film frames.

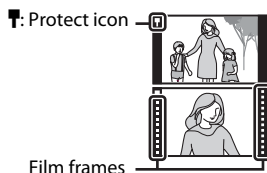

Viewing Multiple Pictures: Thumbnail Wheel Playback

Rotate the command dial in full-frame playback mode (28) to display the thumbnail wheel. The thumbnail wheel is displayed at the right of the monitor. When rotation of the command dial is stopped, the thumbnail in the center will be selected and displayed at the left of the monitor.

The following operations can be performed while thumbnail wheel is displayed.

If no operations are performed for about ten seconds in thumbnail wheel playback mode, the thumbnail at the left of the monitor will be displayed in full-frame playback mode.

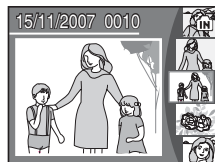
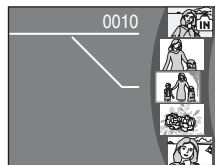

To	Use	Description	
Choose pictures		Rotate the command dial to choose pictures.	-
Choose pictures		Press the multi selector to choose pictures.	10
Cancel thumbnail playback	 T	Press or rotate the zoom control to T (playback zoom).	28
Switch to shooting mode	 	Press or the shutter-release button to switch to the mode selected with the mode dial.	28

Taking a Closer Look: Playback Zoom

Rotating the zoom control to **T** (Q) (playback zoom) during full-frame playback mode (28) zooms the current picture in 3x, with the center of the picture displayed in the monitor (Quick Playback Zoom). The guide at lower right shows which portion of the picture is enlarged. Change the portion of the picture displayed by pressing the multi selector **▲**, **▼**, **◀** or **▶**. When using playback zoom with pictures shot using the face-priority function, the picture will be enlarged, with the face recognized during shooting, at the center of the monitor. If more than one face was recognized, the picture would be enlarged with the face, on which focus was acquired, at the center of the monitor. Press the multi selector **▲**, **▼**, **◀**, or **▶** to display a different recognized face.

The magnification ratio can be changed further by operating the zoom control. The zoom ratio will be displayed in the monitor, and can be increased up to 10x. The following operations can be performed while pictures are zoomed in.

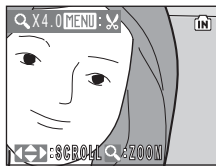
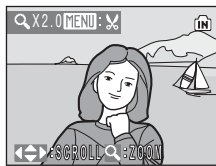
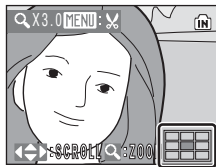

To	Use	Description	28
Zoom in	T (Q)	Zoom increases each time the zoom control is rotated to T (Q), to a maximum of 10x. Zoom also increases by rotating the command dial to right.	-
Zoom out	W (Z)	Zoom decreases each time the zoom control is rotated to W (Z). When the magnification ratio reaches 1x, the display returns to full-frame playback mode. Zoom also decreases by rotating the command dial to left.	-
View other areas of picture		Press the multi selector ▲ , ▼ , ◀ or ▶ to move to areas of the picture not visible in the monitor.	10
Switch to full-frame playback	OK	Press OK .	28
Crop picture	MENU	Press MENU to crop current picture to contain only the portion visible in the monitor.	56
Switch to shooting mode		Press or the shutter-release button to switch to the mode selected with the mode dial.	28

Editing Pictures

Use the COOLPIX P5100 to edit pictures in-camera and store them as separate files (📷 140). The editing features described below are available.

Editing function	Description
D-Lighting	Create a copy of the current picture with enhanced brightness and contrast, brightening dark portions of the picture.
Crop	Enlarge the image or refine the composition and create a copy containing only the portion visible in the monitor.
Small picture	Create a small copy of pictures suitable for use on web pages or as e-mail attachments.
Black border	Create a copy with a black frame along border of the picture that provides a little more impact.

Picture Editing

- Pictures shot at an image size of 📷 (3,984 × 2,656), 📷 (3,968 × 2,232), and 📷 (2,992 × 2,992) (📷 92) cannot be modified using an editing function other than black border.
- The COOLPIX P5100's editing functions may not be available for pictures shot with non-COOLPIX P5100 digital cameras.
- If a copy created using the COOLPIX P5100 is viewed on a different digital camera, the picture may not be displayed or may not be transferred to a computer.
- Editing functions are not available when there is not enough free space in the internal memory or on the memory card.

Restrictions on Picture Editing

(✓: available, -: not available)

1st editing	2nd editing			
	D-Lighting	Crop	Small picture	Black border
D-Lighting	-	✓	✓	-
Crop	-	-	-	-
Small picture	-	-	-	-
Black border	-	-	-	-

- Pictures cannot be edited twice with the same editing function.
- The D-Lighting should be done first while the restricted use of combination exists.
- A black border cannot be applied to copies created using editing functions.

Original Pictures and Edited

- Copies created with editing functions are not deleted if the original pictures are deleted. The original pictures are not deleted if copies created with editing functions are deleted.
- Edited copies are stored with the same recording date and time as the original.
- Edited copies are not marked for printing (📷 87) or protecting (📷 118) as the original.

Download from Www.Somanuals.com. All Manuals Search And Download.

Enhancing Brightness and Contrast: D-Lighting

D-Lighting can be used to create copies with enhanced brightness and contrast, brightening dark portions of a picture. Enhanced copies are stored as separate files.

- 1 Select the desired picture from full-frame (F28) or thumbnail (F51) playback mode and press **MENU**.

The playback menu is displayed.

Pictures can also be selected from thumbnail wheel playback mode (F52).

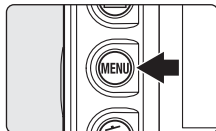

- 2 Use the multi selector to choose [D-Lighting] and press **OK**.

The original version will be shown on the left and the edited version will be shown on the right.



- 3 Choose [OK] and press **OK**.

A new copy with enhanced brightness and contrast is created.

To cancel D-Lighting, choose [Cancel] and press **OK**.

D-Lighting copies can be recognized by the  icon displayed during playback.



More Information

See "Image/Sound File and Folder Names" (F140) for more information.

Download from www.Somanuals.com. All Manuals Search And Download.

Creating a Cropped Copy: Crop

This function is only available when **MENU: %** is displayed in the monitor with playback zoom ( 53) enabled. Cropped copies are stored as separate files.

- 1 Rotate the zoom control to **T** () in full-frame playback mode to zoom in on the image.

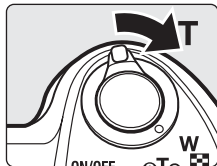

- 2 Refine copy composition.

Rotate the zoom control to **T** or **W** to adjust the zoom ratio.

Press the multi selector , ,  or  to scroll the picture until only the portion you want to copy is visible in the monitor.



- 3 Press **MENU**.

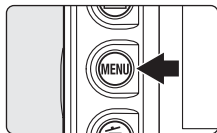

- 4 Use the multi selector to choose [Yes] and press .

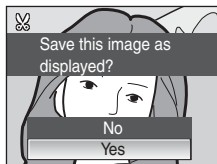

A new picture, containing only the portion visible in the monitor, is created.

To cancel creating a cropped copy, choose [No].



Depending on the size of the original picture and the zoom ratio in effect at the time the copy was created, the camera will automatically select one of the following image size settings for cropped copies (unit: pixels).

-  4,000 × 3,000
-  3,264 × 2,448
-  2,592 × 1,944
-  2,272 × 1,704
-  2,048 × 1,536
-  1,600 × 1,200
-  1,280 × 960
-  1,024 × 768
-  640 × 480
-  320 × 240
-  160 × 120

When the image size setting for cropped copies is  320x240 or  160x120, these pictures are displayed with a gray frame.



More Information



See "Image/Sound File and Folder Names" ( 140) for more information.

Download from www.Somanuals.com. All Manuals Search And Download.

Resizing Pictures: Small Picture

Create a small copy of the current picture. Small copies are stored as JPEG files with a compression ratio of 1:16. The following sizes are available.

Option	Description
 640×480	Suited to television playback.
 320×240	Suited to display on web pages.
 160×120	Suitable for e-mail attachments.

- 1 Select the desired picture from full-frame ( 28) or thumbnail ( 51) playback mode and press **MENU**.

The playback menu is displayed.

Pictures can also be selected from thumbnail wheel playback mode ( 52).

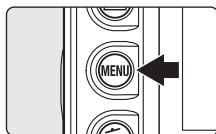

- 2 Use the multi selector to choose [Small pic.] and press **OK**.

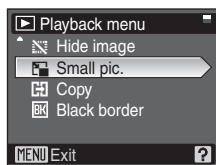

- 3 Choose the desired copy size and press **OK**.

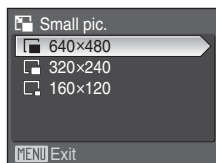

- 4 Choose [Yes] and press **OK**.

A new, smaller copy is created.

To cancel creating a small copy, choose [No].

The copy is displayed with a gray frame.

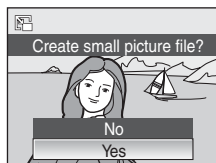

More Information

See "Image/Sound File and Folder Names" ( 140) for more information.

Download from [Www.Somanuals.com](http://www.Somanuals.com). All Manuals Search And Download.

Adding Black Frame on Pictures: Black Border

This function creates copies with [Thin], [Medium], or [Broad] black lines, along borders of pictures. Copies with black frame are stored as separate files.

- 1 Select the desired picture from full-frame (F28) or thumbnail (F51) playback mode and press **MENU**.

The playback menu is displayed.

Pictures can also be selected from thumbnail wheel playback mode (F52).

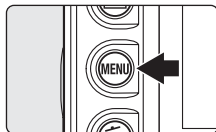

- 2 Use the multi selector to choose [Black border] and press **OK**.

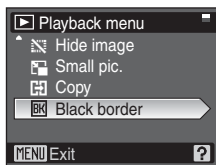

- 3 Choose the desired thickness of frame and press **OK**.

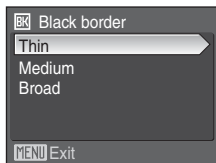

- 4 Choose [Yes] and press **OK**.

A new copy with black frame is created.

To cancel creating a copy with black frame, choose [No].

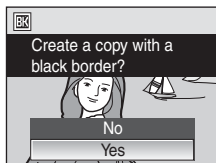

Black Border



- Borders of a picture will be hidden with black lines because black portion is drawn from picture's edges according to their thickness.
- When a picture with black border are printed using printer's borderless print function, black frame may not be printed.

More Information

See "Image/Sound File and Folder Names" (F140) for more information.

Download from [Www.Somanuals.com](http://www.Somanuals.com). All Manuals Search And Download.

Voice Memos: Recording and Playback

Use the camera's built-in microphone to record voice memos for pictures marked with **OK** :  in full-frame playback mode ( 28).

Recording Voice Memos

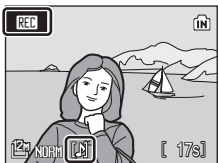
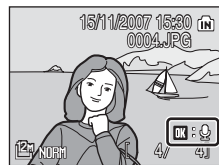

A voice memo, up to 20 seconds in length, will be recorded while **OK** is pressed down.

- Do not touch the built-in microphone during recording.
- During recording, **REC** and  blink in the monitor display.





Playing Voice Memos

Press **OK** while a picture is displayed in full-frame playback mode to play voice memo. Playback ends when the voice memo ends or **OK** is pressed again.

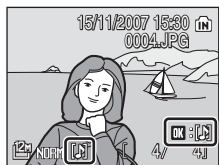
- Pictures with voice memos can be recognized by the **OK** :  and  icons.
- Use the zoom control to adjust playback volume.



Deleting Voice Memos

Select a picture with a voice memo and press . Use the multi selector to choose  and press **OK**. Only the voice memo will be deleted.

Voice Memos

- When a picture with a voice memo attached is deleted, both the picture and its voice memo are deleted.
- If a voice memo already exists for the current picture, it must be deleted before a new voice memo can be recorded.
- The COOLPIX P5100 cannot be used to attach voice memos to pictures shot with cameras other than the COOLPIX P5100.

More Information

See "Image/Sound File and Folder Names" ( 140) for more information.
Download from [Www.Somanuals.com](http://www.Somanuals.com). All Manuals Search And Download.

Viewing Pictures by Date

In calendar mode or list by date mode, pictures shot on a specified date can be displayed.

When **MENU** is pressed, the calendar menu or the list by date menu is displayed, and all pictures shot on a specified date can be selected for deletion, printing, and protection.

Selecting a Date in Calendar Mode

- 1 In playback mode, hold down **Fn** and rotate the command dial to choose [Calendar].

When **Fn** is released, the camera enters calendar mode.

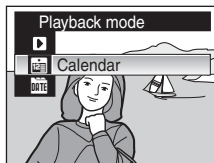
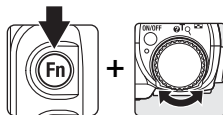

- 2 Choose the desired date and press **OK**.

Dates for which pictures exist are underlined in yellow.

Rotate the zoom control to **W** (🏠) to view previous month, rotate the zoom control to **T** (🕒) to view following month.



The first picture for that date will be displayed in full-frame playback.

Rotate the zoom control to **W** (🏠) in full-frame playback mode to return to calendar mode.

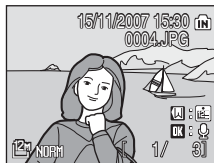

Selecting a Date in List by Date Mode

- 1 In playback mode, hold down **Fn** and rotate the command dial to choose [List by date], and then release **Fn**.

When **Fn** is released, the camera enters list by date mode.

Dates for which pictures exist will be listed.

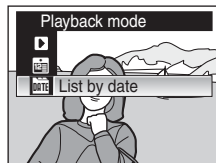
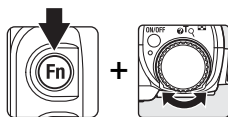

- 2 Choose the desired date and press **OK**.

Camera lists up to 29 dates. If pictures exist for more than 29 dates, all pictures recorded earlier than most recent 29 dates will be listed together as [Others].





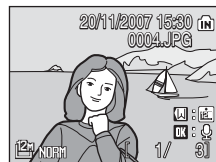
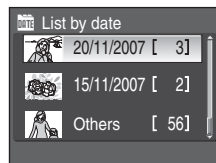









The first picture for that date will be displayed in full-frame playback.

Rotate the zoom control to **W** () in full-frame playback mode to return to the date list.



Using Calendar Mode and List by Date Mode

The following operations are possible from the date selection screen.









To	Use	Description	
Select date		Use the multi selector to select a date. The date can also be selected by rotating the command dial.	–
Select month (calendar mode only)	W  T 	Rotate the zoom control to W  to view previous month, rotate the zoom control to T  to view following month.	–
Switch to full-frame playback		Press  to display the first picture shot on the selected date. Rotate the zoom control to W  in full-frame playback to return to the calendar or list by date mode selected before viewing in full-frame playback.	29
Delete picture		Press  after selecting a date, and a confirmation dialog will be displayed. Choose [Yes] and press  to delete all pictures shot on the selected date.	28
View calendar or list by date menu	MENU	Press MENU to display the calendar or list by date menu.	63
Switch to shooting mode	 	Press  or shutter-release button to switch to the mode selected with the mode dial.	28

Notes on Calendar Mode and List by Date Mode

- Only the most recent 9,000 pictures can be displayed in calendar mode or in list by date mode. If a date includes the 9,001st picture, an asterisk [*] is displayed next to the number of pictures for that date.
- Pictures shot with no date stamp are not listed in these modes.

Calendar and List by Date Menus

Press **MENU** in either mode to display the following menus for only the pictures shot on the specified date.

D-Lighting*	 55
Print set	 87
Slide show	 117
Delete	 118
Protect	 118
Hide image	 118
Small picture*	 57
Black border*	 58

* During full-frame playback only

When **MENU** is pressed in the date selection screen ( 60, 61), options can be applied to all pictures shot on the same date, or all pictures shot on the same date can be deleted. To apply options to individual pictures, or to select individual pictures for deletion, display a picture full-frame and press **MENU**.

Print Set Marking

When print marking already exists for pictures shot on dates other than that specified, a confirmation dialog [Save print marking for other dates?] will be displayed. Select [Yes] to add the new print marking to the existing marking. Select [No] to remove the existing print marking and leave only the new marking.

Recording Movies

To shoot movies with sound recorded via the built-in microphone, follow the steps below.

1 Rotate the mode dial to **Movie**.

Exposure count display shows maximum total length of movie that can be recorded.

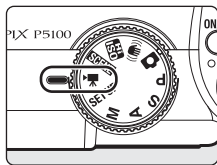

2 Press the shutter-release button all the way down to start recording.

Camera focuses on the subject in the center focus area.

A progress bar at the bottom of the monitor shows the amount of recording time remaining.

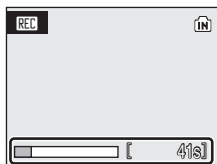

To end recording, press the shutter-release button all the way down a second time.

Recording Movies

- Flash mode (F 30) can only be used for time-lapse movies. Focus mode (F 33) and exposure compensation (F 34) are available in all modes. Self-timer (F 32) cannot be used.
- Flash mode (F 30), focus mode (F 33), and exposure compensation (F 34) settings cannot be applied or changed while movies are being recorded. Apply or change settings as necessary before movie recording begins.
- Optical zoom cannot be applied or adjusted once movie recording begins. Digital zoom cannot be applied before movie recording begins. However, digital zoom (up to 2x) can be applied while movies, other than stop-motion movies, are being recorded.
- The maximum file size for movies is 4 GB.

Changing Movie Settings

- Movie options or auto-focus mode can be changed (F 65).
- When [Movie options] is set to [Time-lapse movie ★], movies are recorded without sound.

Download from Www.Somanuals.com. All Manuals Search And Download.







The Movie Menu

[Movie options] and [Auto-focus mode] settings can be changed from the movie menu.

Press **MENU** in movie mode to display the movie menu and use the multi selector to modify and apply settings.

Selecting Movie Options







The movie menu offers the options shown below.

Option	Image size and frame rate
 TV movie 640★ (default setting)	Image size: 640 × 480 pixels Frame rate: 30 frames per second
 TV movie 640	Image size: 640 × 480 pixels Frame rate: 15 frames per second
 Small size 320	Image size: 320 × 240 pixels Frame rate: 15 frames per second
 Smaller size 160	Image size: 160 × 120 pixels Frame rate: 15 frames per second
 Time-lapse movie★	The camera automatically shoots pictures at intervals and joins them into a silent movie (68). Image size: 640 × 480 pixels Frame rate: 30 frames per second
 Sepia movie 320	Record movies in sepia tones. Image size: 320 × 240 pixels Frame rate: 15 frames per second
 B&W movie 320	Record movies in black and white. Image size: 320 × 240 pixels Frame rate: 15 frames per second

Using the Command Dial to Choose Movie Options

Movie options can also be selected by holding down **Fn** and rotating the command dial.
Download from www.Somanuals.com. All Manuals Search And Download.

Movie Options and Maximum Movie Length and Frames

Option	Internal memory (approx. 52 MB)	Memory card (256 MB)
 TV movie 640★ (default setting)	47 sec.	Approx. 3 min. 40 sec.
 TV movie 640	1 min. 33 sec.	Approx. 7 min. 20 sec.
 Small size 320	3 min. 4 sec.	Approx. 14 min. 20 sec.
 Smaller size 160	10 min. 10 sec.	Approx. 47 min. 40 sec.
 Time-lapse movie★	555 frames	1,800 frames per movie
 Sepia movie 320	3 min. 4 sec.	Approx. 14 min. 20 sec.
 B&W movie 320	3 min. 4 sec.	Approx. 14 min. 20 sec.



* Movies can be as long as free space in the internal memory or on the memory card allows. All figures are approximate. Maximum movie length or frames varies with make of memory card. The maximum file size for movies is 4 GB.

More Information

See "Image/Sound File and Folder Names" ( 140) for more information.

Auto-focus Mode

Choose how the camera focuses in movie mode.

Option	Description
 Single AF (default setting)	Camera focuses when shutter-release button is pressed halfway and locks at this position during shooting.
 Full-time AF	Camera focuses continuously until focus is acquired and locked. To prevent sound of camera focusing from interfering with recording, use of [Single AF] is recommended.

Time-Lapse Movies

Record flowers opening or butterflies emerging from cocoons.

- 1 Use the multi selector to choose [Movie options] in the movie menu and press **OK**.

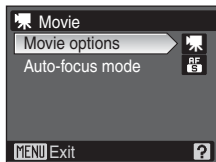

- 2 Choose [Time-lapse movie★] and press **OK**.



- 3 Choose the interval between shots and press **OK**.

Choose from intervals between 30 seconds and 60 minutes.

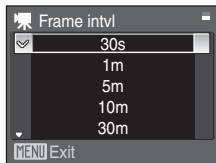

- 4 Press **MENU**.

The camera returns to shooting mode.

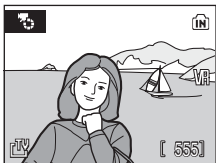





- 5 Press the shutter-release button all the way down to start recording.

Monitor turns off and power-on lamp blinks between shots.
Monitor reactivates automatically for the next shot.

- 6 Press the shutter-release button all the way down a second time to end recording.

Recording will automatically stop if the internal memory or memory card becomes full, or when 1,800 frames have been recorded. An 1,800-frame movie has a playback time of 60 seconds.
Download from Www.Somanuals.com. All Manuals Search And Download.

Time-Lapse Movie

- Flash mode ( 30), focus mode ( 33), and exposure compensation ( 34) cannot be adjusted after the first picture is shot. Apply the appropriate settings before shooting begins.
- To prevent the camera from turning off unexpectedly during recording, use a fully charged battery.
- To power the camera continuously for extended periods, use an AC Adapter EH-62A (available separately from Nikon) ( 136). **Do not, under any circumstances, use another make or model of AC adapter.** Failure to observe this precaution could result in overheating or in damage to the camera.
- Do not rotate the mode dial to a different setting during recording.

Movie Playback

In full-frame playback mode (28), movies are recognized by movie mode icons. To play a movie, display it in full-frame playback mode and press **OK**.

The movie mode icon varies depending upon a movie option (65) selected in shooting mode.

Use the zoom control to adjust playback volume.

Rotate the command dial to advance or rewind the movie.

Press the multi selector ◀ or ▶ to choose a control at the top of the monitor, then press **OK** to perform the selected operation. The following operations are available.

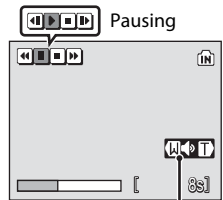

Volume indicator
During playback

To	Press	Description
Rewind	◀	Rewind movie. Playback resumes when OK is released.
Advance	▶	Advance movie. Playback resumes when OK is released.
Pause	⏸	Pause playback. While paused, use the multi selector to advance or rewind the movie. The following operations can be performed while playback is paused.
	◀	Rewind movie by one frame. Rewind continues while OK is pressed.
	▶	Advance movie by one frame. Advance continues while OK is pressed.
	▶	Resume playback.
End	■	End playback and return to full-frame playback.

Deleting Movie Files

Press **Trash** when being played back, when displayed in full-frame playback mode (28), or when selected in thumbnail (51) or thumbnail wheel (52) playback mode. A confirmation dialog is displayed. Choose [Yes] and press **OK** to delete the movie, or choose [No] and press **OK** to return to the normal playback display without deleting the movie.

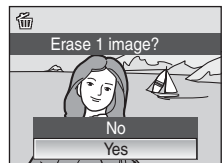



Making Voice Recordings

Audio voice recordings can be recorded over the built-in microphone and played back over the built-in speaker.

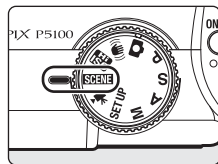
- 1** Rotate the mode dial to **SCENE**.



- 2** Press **MENU** to display the scene menu, use the multi selector to choose  (voice recording), and press .

The length of recording that can be made will be displayed.

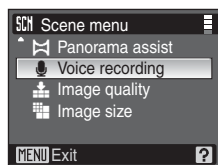

- 3** Press the shutter-release button all the way down to start recording.

The AF lamp lights during recording. After about 30 seconds, the camera's auto off function is enabled and the monitor turns off.

See "Operations During Recording" ( 72) for more information.

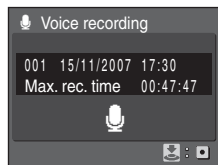

- 4** Press the shutter-release button all the way down a second time to end recording.

Recording will end automatically if the internal memory or memory card becomes full, or after five hours of recording on the memory card.

More Information

See "Image/Sound File and Folder Names" ( 140) for more information.

Download from [Www.Somanuals.com](http://www.Somanuals.com). All Manuals Search And Download.

Operations During Recording



To	Press	Description
Reactivate the monitor		If the monitor has turned off, press to reactivate.
Pause/resume recording		Press once to pause recording; AF lamp will blink.
Create index*		During recording, press the multi selector , , , or to create index. Camera can skip to any intended index during playback. Start of recording is index number 01; other numbers that follow are assigned in ascending order each time the multi selector is pressed, up to index number 98.
End recording		Press the shutter-release button all the way down a second time to end recording.

* The copied files can be played back using QuickTime or any other WAV-compatible audio player. Note that index points created with the camera cannot be used when voice recordings are played back on computers.

Playing Voice Recordings

- 1 Press  in the voice recording screen ( 71, step 3).

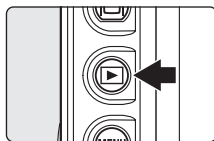

- 2 Use the multi selector to choose the desired sound file and press .

The selected sound file will be played back.

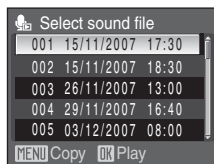

Operations During Playback

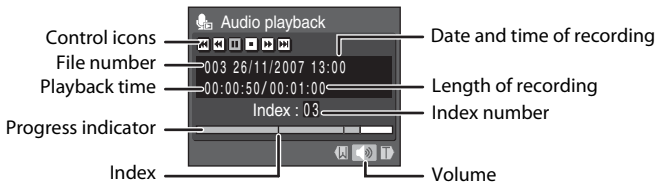

Use the zoom control to adjust audio playback volume.

Use the command dial to advance or rewind the voice recording.

Playback controls appear at the top of the monitor. Press the multi selector ◀ or ▶ to choose a control, then press **OK** to perform the selected operation. The following operations are available.

To	Press	Description
Rewind	⏮	Rewind voice recording. Playback resumes when OK is released.
Advance	⏭	Advance voice recording. Playback resumes when OK is released.
Skip to previous index	⏮	Skip to previous index.
Skip to next index	⏭	Skip to next index.
Pause	⏸	Pause playback.
	▶	The following operations can be performed while playback is paused: Resume playback.
End	⏹	End playback and return to the sound file selection screen.

Deleting Sound Files

Press **⏹** during playback or after selecting a sound file (use the multi selector). A confirmation dialog will be displayed. To delete the file, choose [Yes] and press **OK**. To cancel deletion, choose [No] and press **OK**.

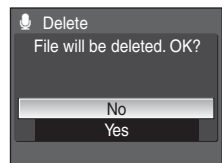

Copying Voice Recordings

Copy voice recordings between the internal memory and a memory card.
This option is available only when a memory card is inserted.

- 1** Press **MENU** in the select sound file screen
(73, step 2).

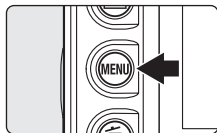

- 2** Use the multi selector to choose the option and press **OK**.

: Copy recordings from internal memory to memory card

: Copy recordings from memory card to internal memory

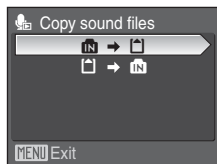

- 3** Choose the copy option and press **OK**.

[Selected files]: Proceed to step 4

[Copy all files]: Proceed to step 5

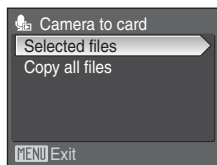

- 4** Choose the desired file.

Press the multi selector to select the file (). Press the multi selector again to cancel the selection.

- Multiple files can be selected.
- Press **OK** to finalize file selection.

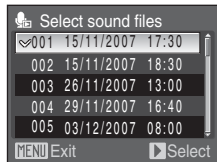

- 5** When a confirmation dialog is displayed, choose [Yes] and press **OK**.

Copying starts.

Voice Recordings

The COOLPIX P5100 may be unable to play or copy sound files created with cameras other than the COOLPIX P5100.

[No sound file.] Message

If there are no sound files stored on the memory card when is pressed (73, step 1), the message [No sound file.] will be displayed. Press **MENU** to display the copy sound files screen, and copy the sound files stored in the camera's internal memory to the memory card.

Download from www.Somanuals.com. All Manuals Search And Download.

Connecting to a TV

Connect the camera to a television using the supplied audio/video cable to play back pictures on the television.

- 1 Turn off the camera.

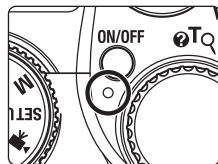

- 2 Connect the camera to the TV using the supplied audio/video cable.

Connect the yellow plug to the video-in jack on the TV, and the white plug to the audio-in jack.

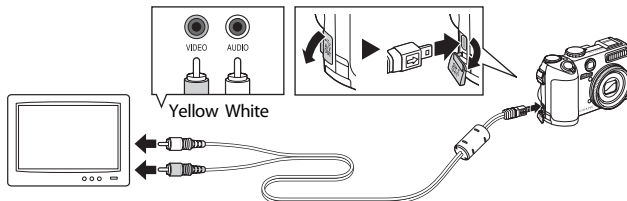

- 3 Tune the television to the video channel.

See the documentation provided with your television for details.

- 4 Hold down  to turn on the camera.

The camera enters playback mode, and pictures recorded to the internal memory, or memory card, will be displayed on the television.

While connected to the TV, the camera monitor will remain off.

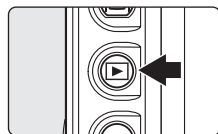

Connecting an Audio/Video Cable

When connecting the audio/video cable, be sure that the camera connector is oriented correctly. Do not use force when connecting the audio/video cable to the camera. When disconnecting the audio/video cable, do not pull the connector at an angle.

Video Mode

Be sure that the camera's video mode setting conforms to the standard used by your television. The video mode setting is an option set in the setup menu (F120) > [Video mode] (F132).

Download from [Www.Somanuals.com](http://www.Somanuals.com). All Manuals Search And Download.

Connecting to a Computer

When the camera is connected to a computer using the supplied USB cable, pictures recorded with the camera can be copied (transferred) to the computer for storage using the Nikon Transfer software.

Before Connecting the Camera

Installing the Software

Before connecting the camera to a computer, software, including Nikon Transfer and Panorama Maker for creating panorama images, must be installed from the supplied Software Suite CD.

For more information on installing the software, refer to the *Quick Start Guide*.

Operating Systems Compatible with COOLPIX P5100

Windows

Preinstalled versions of Windows Vista (32-bit Home Basic/Home Premium/Business/Enterprise/Ultimate editions), Windows XP Service Pack 2 (Home Edition/Professional)

If your computer is running Windows 2000 Professional, use a card reader or similar device to transfer pictures stored on the memory card to the computer (📷 79).

Macintosh

Mac OS X (version 10.3.9, 10.4.9)

Refer to the Nikon website for the latest information on operating system compatibility.

📌 Notes on Power Source

- When connecting the camera to a computer or printer, use a fully-charged battery to prevent the camera from turning off unexpectedly.
- To power the camera continuously for extended periods, use an AC Adapter EH-62A (available separately from Nikon) (📷 136). **Do not, under any circumstances, use another make or model of AC adapter.** Failure to observe this precaution could result in overheating or in damage to the camera.

Download from [Www.Somanuals.com](http://www.Somanuals.com). All Manuals Search And Download.

Transferring Pictures from the Camera to a Computer

- 1 Start the computer to which Nikon Transfer has been installed.
- 2 Turn off the camera.
- 3 Connect the camera to the computer using the supplied USB cable.

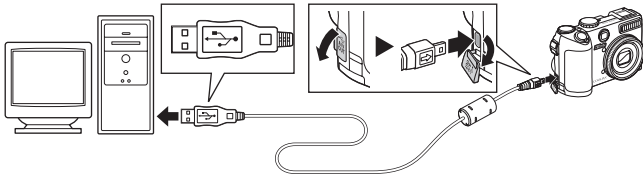

- 4 Turn on the camera.

Windows Vista/XP

When the AutoPlay dialog is displayed, select [Copy pictures to a folder on my computer using Nikon Transfer] (Windows Vista) or [Nikon Transfer Copy pictures to a folder on my computer] (Windows XP), and click [OK] (Windows XP only). To bypass this dialog in the future, check [Always do this for this device:] (Windows Vista), or [Always use this program for this action.] (Windows XP).

Nikon Transfer will start.

Mac OS X

Nikon Transfer will start automatically if [Yes] was selected in the Auto-Launch setting dialog when Nikon Transfer was first installed.

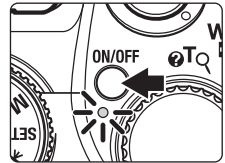

✓ Connecting the USB Cable

Be sure that the connectors are oriented correctly, and do not use force, to connect the USB cable. When disconnecting the USB cable, do not pull the connector at an angle.

Connection may not be recognized when the camera is connected to a computer via a USB hub.

Download from [Www.Somanuals.com](http://www.Somanuals.com). All Manuals Search And Download.

5 Transfer pictures when Nikon Transfer has finished loading.

Click [Start Transfer] in Nikon Transfer. At the default setting, all pictures are transferred to the computer.

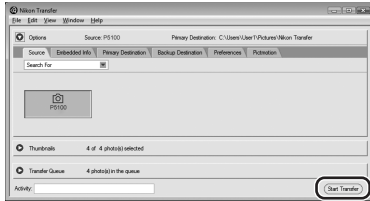

At the Nikon Transfer default setting, the folder to which pictures are transferred is automatically opened when transfer is complete.

For more information on using Nikon Transfer, refer to help information contained in Nikon Transfer.

6 Disconnect the camera when transfer is complete.

Turn the camera off and disconnect the USB cable.

For Users of Windows 2000 Professional

Use a card reader or similar device to transfer the pictures stored on the memory card to the computer.

If your memory card has a capacity greater than 2 GB, the intended device must support the memory card.

- At the Nikon Transfer default settings, Nikon Transfer will start automatically when a memory card is inserted into the card reader or similar device. See step 5 above to transfer pictures.
- Do not connect the camera to the computer. If the camera is connected to the computer, the [Found New Hardware Wizard] dialog will be displayed. Select [Cancel], close the dialog, and disconnect the camera from the computer.
- To transfer pictures stored in the camera's internal memory to the computer, the pictures must first be copied to a memory card using the camera (📷 75, 115, 119).



Using Standard OS Operations to Open Image/Sound Files

- Navigate to the folder on the computer's hard disk to which pictures were saved and open a picture in the viewer supplied with your operating system.
- Sound files copied to the computer can be played back using QuickTime or any other WAV-compatible audio player.



Panorama Creation with Panorama Maker

- Use a series of pictures shot using the [Panorama assist] option in scene mode (📷 41) to create a single panorama photo with Panorama Maker.
- Panorama Maker can be installed to a computer using the supplied Software Suite CD.
- After installation is complete, follow the procedure described below to start Panorama Maker.

Windows

Open [All Programs] ([Programs] under Windows 2000) from the [Start] menu > [ArcSoft Panorama Maker 4] > [Panorama Maker 4].

Macintosh

Open Applications by selecting [Applications] from the [Go] menu, and double-click the [Panorama Maker 4] icon.

- For more information on using Panorama Maker, refer to the on-screen instructions and help information contained in Panorama Maker.



More Information

See "Image/Sound File and Folder Names" (📷 140) for more information.

Connecting to a Printer

Users of PictBridge-compatible (🔑 157) printers can connect the camera directly to the printer and print pictures without using a computer.

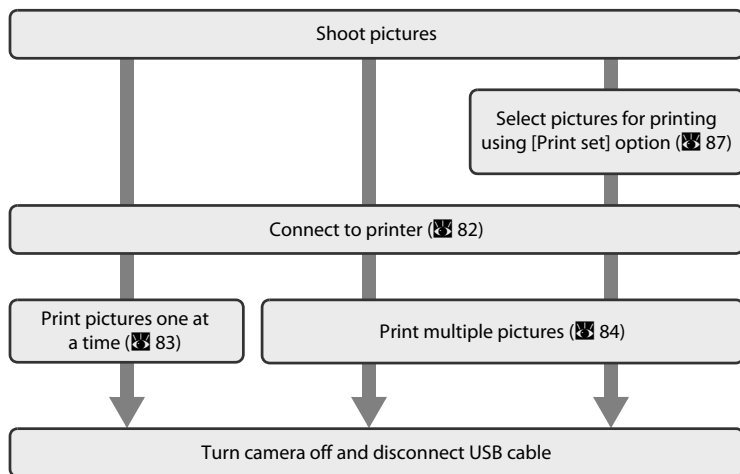

✔ Notes on Power Source

- When connecting the camera to a computer or printer, use a fully-charged battery to prevent the camera from turning off unexpectedly.
- To power the camera continuously for extended periods, use an AC Adapter EH-62A (available separately from Nikon) (🔑 136). **Do not, under any circumstances, use another make or model of AC adapter.** Failure to observe this precaution could result in overheating or in damage to the camera.

🔍 Printing Pictures

In addition to printing pictures transferred to a computer from your personal printer and printing over a direct camera-to-printer connection, the following options are also available for printing pictures:

- Insert a memory card into a DPOF-compatible printer's card slot
- Take a memory card to a digital photo lab

For printing using these methods, specify the pictures and the number of prints each using your camera's print set menu (🔑 87).

Download from [Www.Somanuals.com](http://www.Somanuals.com). All Manuals Search And Download.

Connecting the Camera and Printer

- 1 Turn off the camera.

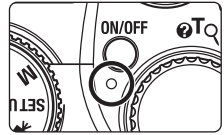

- 2 Turn on the printer.

Check printer settings.

- 3 Connect the camera to the printer using the supplied USB cable.

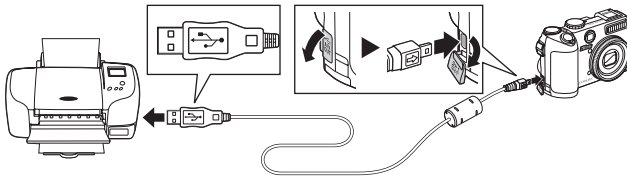

- 4 Turn on the camera.

When connected correctly, the PictBridge startup screen

① will be displayed in the camera monitor. Then the print selection screen will be displayed ②.

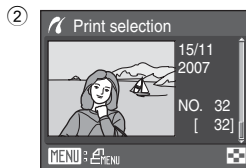
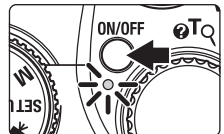

✔ Connecting the USB Cable

Be sure that the connectors are oriented correctly, and do not use force, to connect the USB cable. When disconnecting the USB cable, do not pull the connector at an angle.

Printing Pictures One at a Time

After connecting the camera to the printer correctly (82), print pictures by following the procedure below.

- 1 Use the multi selector ◀▶ to choose the desired picture and press **OK**.

The command dial can also be used to choose the picture. Rotate the zoom control to **W** (📷) to display 12 thumbnails, and **T** (📺) to switch back to full-frame playback.

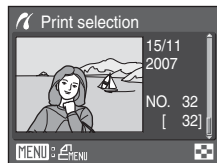

- 2 Choose [Copies] and press **OK**.

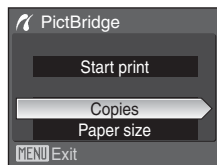

- 3 Choose the number of copies (up to nine) and press **OK**.

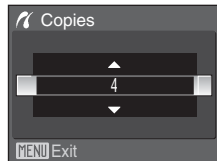

- 4 Choose [Paper size] and press **OK**.

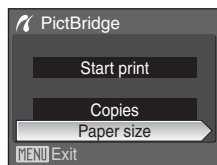

- 5 Choose the desired paper size and press **OK**.

To specify paper size using printer settings, choose [Default] in the paper size menu.

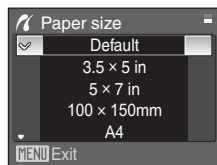

- 6** Choose [Start print] and press **OK**.



- 7** Printing starts.

Monitor display returns to that shown in step 1 when printing is complete.

To cancel before all copies have been printed, press **OK**.

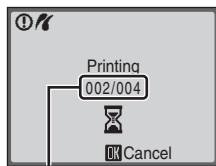

Current print/total number of prints

Printing Multiple Pictures

After connecting the camera to the printer correctly (82), print pictures by following the procedure below.

- 1** When the print selection screen is displayed, press **MENU**.

The print menu is displayed.

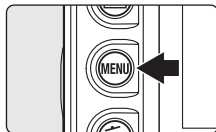

- 2** Use the multi selector to choose [Paper size] and press **OK**.

To exit to the print menu, press **MENU**.

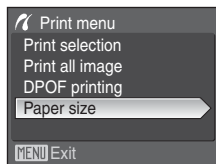

- 3** Choose the desired paper size and press **OK**.

To specify paper size using printer settings, choose [Default] in the paper size menu.

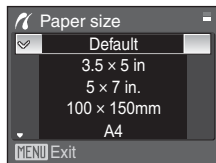

- 4** Choose [Print selection], [Print all images] or [DPOF printing] and press **OK**.

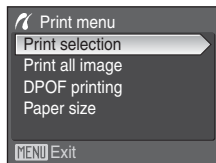

Print selection

Choose the pictures and number of copies (up to nine) of each.

Press the multi selector **◀▶** to select pictures, and press **▲** or **▼** to set the number of copies for each. The command dial can also be used to choose the pictures.

Pictures selected for printing can be recognized by the check mark (✓) and the numeral indicating the number of copies to be printed.

Pictures for which no copies have been specified will not be printed.

Rotate the zoom control to **T** (🔍) to switch to full-frame playback.

Rotate the zoom control to **W** (🖼️) to switch back to thumbnail display.

Press **OK** when setting is complete.

The menu shown at right will be displayed.

To print, choose [Start print] and press **OK**.

Choose [Cancel] and press **OK** to return to the print menu.

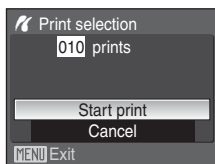
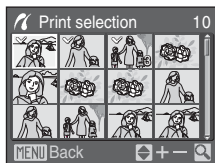

Print all images

All pictures stored in the internal memory, or on the memory card, are printed one at a time.

The menu shown at right will be displayed.

To print, choose [Start print] and press **OK**.

Choose [Cancel] and press **OK** to return to the print menu.

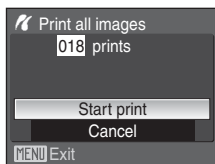

DPOF printing

Print pictures for which a print order was created in [Print set] (87). The menu shown at right will be displayed. To print, choose [Start print] and press **OK**. Choose [Cancel] and press **OK** to return to the print menu.

To view the current print order, choose [View images] and press **OK**. To print pictures, press **OK** again.

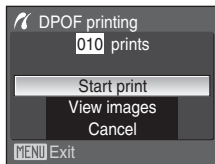

5 Printing starts.

Monitor display returns to the print menu (step 2) when printing is complete.

To cancel before all copies have been printed, press **OK**.

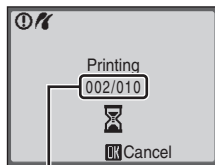

Current print/total number of prints

Paper Size

The camera supports the following paper sizes: [Default] (the default paper size for the current printer), [3.5 × 5 in.], [5 × 7 in.], [100 × 150mm], [4 × 6 in.], [8 × 10 in.], [Letter], [A3], and [A4]. Only sizes supported by the current printer will be displayed. To specify paper size using printer settings, choose [Default] in the paper size menu.

Creating a DPOF Print Order: Print Set

The [Print set] option in the playback menu is used to create digital “print orders” for printing on DPOF-compatible devices (❏ 157).

When the camera is connected to a PictBridge-compatible printer, pictures can be printed from the printer according to the DPOF print order you have created for pictures on the memory card. If the memory card is removed from the camera, you can create the DPOF print order for pictures in the internal memory and print pictures according to the DPOF print order.

1 Press **MENU** in playback mode.

The playback menu is displayed.

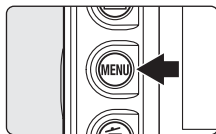

2 Use the multi selector to choose [Print set] and press **OK**.

The print set menu is displayed.

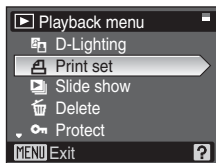

3 Choose [Print selected] and press **OK**.

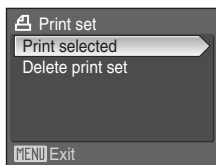

4 Choose the pictures and number of copies (up to nine) of each.

Press the multi selector ◀▶ to select pictures, and press ▲ or ▼ to set the number of copies for each. The command dial can also be used to choose the pictures. Pictures selected for printing can be recognized by the check mark (✔) icon and the numeral indicating the number of copies to be printed. The pictures for which no copies have been specified will not be printed.

Rotate the zoom control to **T** (📷) to switch to full-frame playback.

Rotate the zoom control to **W** (📷) to switch back to thumbnail display.

Press **OK** when setting is complete.





5 Choose whether or not to also print shooting date and photo information.

Choose [Date] and press **OK** to print date of recording on all pictures in the print order.

Choose [Info] and press **OK** to print photo information (shutter speed and aperture) on all pictures in the print order.

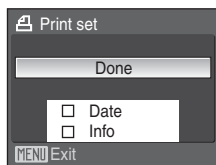
Choose [Done] and press **OK** to complete the print order and exit.



Pictures selected for printing are recognized by the  icon displayed during playback.

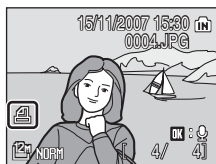

Notes on Printing Shooting Date and Photo Information

When the [Date] and [Info] options are enabled in the print set menu, shooting date and photo information are printed on pictures when a DPOF-compatible (**85** 157) printer which supports printing of shooting date and photo information is used.

- Photo information cannot be printed when the camera is connected directly to a printer, via the supplied USB cable, for DPOF printing (**85** 86).
- [Date] and [Info] are reset each time the print set menu is displayed.

Deleting All Print Orders

Choose [Delete print set] in step 3 and press **OK**. Print orders for all pictures will be deleted.

Note on the Print Set [Date] Option

The date and time printed on pictures with DPOF printing, when [Date] in the print set menu is enabled, are those recorded with the picture as it was shot. Date and time printed using this option are not affected when the camera's date and time setting are changed from the setup menu after pictures are recorded.































Date Imprint









When date and time of recording are imprinted on pictures using the [Date imprint] option (**85** 126) in the setup menu, pictures with the date and time imprinted on them can be printed from printers that do not support printing of the date and time on pictures. Only the [Date imprint] date and time on pictures will be printed, even if [Print set] is enabled with [Date] selected in the print set screen.

Shooting Options: The Shooting Menu

The shooting menu of **P**, **S**, **A**, and **M** modes, and high-sensitivity menu of high-sensitivity shooting mode, contain the following options.

	Image quality ¹	 91
Choose the image quality (compression ratio) of recorded pictures.		
	Image size ^{1, 3}	 92
Choose the image size of recorded pictures.		
	Optimize image ³	 94
Control contrast, sharpness, and saturation.		
	White balance ³	 97
Match white balance to the light source.		
	ISO sensitivity ^{2, 3}	 99
Control the camera's sensitivity to light.		
	Metering	 100
Choose how the camera meters exposure.		
	Continuous ³	 101
Select the option to shoot pictures one at a time, in a sequence, or with Best Shot Selector (BSS).		
	Auto bracketing ³	 104
Vary exposure over a sequence of pictures.		
	AF area mode ³	 105
Choose where the camera focuses.		
	Auto-focus mode	 107
Choose how the camera focuses.		
	Flash exp. comp.	 108
Adjust flash level.		
	Flash control	 108
Control built-in flash.		
	Fixed aperture	 109
Choose whether aperture changes with zoom position.		
	Noise reduction ³	 109
Reduce noise in pictures shot at slow shutter speeds.		

Shooting Options: The Shooting Menu

 Converter ³	 110
Adjust settings for converter lenses (available separately from Nikon).	
 User setting	 111
Store button and shooting menu settings in two separate user setting banks.	
 Reset user setting	 112
Restore user settings to their default values.	
 Distortion control ³	 112
Correct the distortion.	

¹ Settings can be applied from other shooting menus (except the movie menu).

² This setting cannot be set in the high-sensitivity menu.

³ See the information on restrictions that may apply to these settings ( 112).

Displaying the Shooting Menu and High-sensitivity Menu

Choose **P** (Programmed Auto), **S** (Shutter-Priority Auto), **A** (Aperture-Priority Auto), **M** (Manual), or  (high sensitivity) by rotating the mode dial. Press **MENU** to display the shooting menu or high-sensitivity menu.

Shooting, Playback and Setup Menus

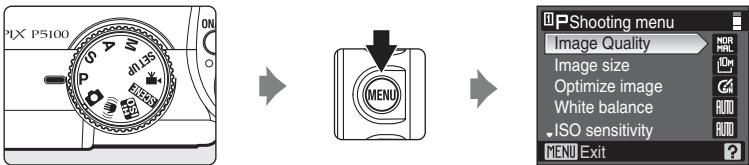

- The high sensitivity menu is displayed when  is selected by the mode dial.
- To return to the shooting mode from the shooting or high-sensitivity menu, press **MENU** or the shutter-release button.

Navigating the Camera Menu



Press the multi selector  or  to select items and set functions on menus ( 10). The command dial can also be used in place of the multi selector.

Image Quality

Choose the amount of compression applied to pictures. Lower compression ratios result in higher quality pictures, but also larger file sizes, limiting the number of pictures that can be recorded.

FINE	Fine
	Fine quality images (compression ratio of 1:4), suitable for enlargement or high-quality prints.

NORMAL	Normal (default setting)
	Normal image quality (compression of 1:8), suited to most applications.

BASIC	Basic
	Basic image quality (compression of 1:16), suitable for pictures that will be distributed by e-mail or used in web pages.

Image quality is shown by an icon in the monitor ( 6, 7).

More Information

See "Number of Exposures Remaining" ( 93) for more information.
Download from www.Somanuals.com. All Manuals Search And Download.

Image Size

Choose the size of pictures in pixels for recording. Pictures shot at smaller sizes require less memory, making them suited to distribution by e-mail or the web. Conversely, the larger the image, the larger the size at which it can be printed or displayed without becoming noticeably “grainy,” limiting the number of pictures that can be recorded.



























Option	Description
 4000×3000 (default setting)	Record pictures exhibiting greater detail than those shot at  3264×2448] or  2592×1944].
 3264×2448	Good balance between file size and quality makes this the best choice in most situations.
 2592×1944	
 2048×1536	Smaller than  4000×3000],  3264×2448], and  2592×1944] for recording more pictures.
 1600×1200	
 1280×960	
 1024×768	Record pictures suited to display on a computer monitor.
 640×480	Record pictures suited to display on a television, or to distribution via e-mail or the web.
 3984×2656	Record pictures with the same aspect ratio (3:2) as those shot with 35mm film cameras.
 3968×2232	Record pictures with the same aspect ratio (16:9) as wide-screen televisions.
 2992×2992	Record perfectly square pictures.

Image size is shown by an icon in the monitor ( 6, 7).

Number of Exposures Remaining

The following table lists the approximate number of pictures that can be stored in internal memory, and on a 256-MB memory card, at each combination of image quality (📷 91) and image size (📷 92) settings. Note that the number of pictures that can be stored will differ depending on the composition of the picture (due to JPEG compression). In addition, this number may differ depending on the make of memory card, even if the capacity for the memory card is the same.

Image size	Image quality	Internal memory (52 MB)	256 MB memory card ¹	Print size (printed at 300 dpi; cm/in.) ²
 4000×3000 (default setting)	Fine	9	Approx. 42	Approx. 34 × 25/13.3 × 10
	Normal	17	Approx. 83	
	Basic	35	Approx. 166	
 3264×2448	Fine	13	Approx. 63	Approx. 28 × 21/10.8 × 8.1
	Normal	26	Approx. 124	
	Basic	52	Approx. 243	
 2592×1944	Fine	21	Approx. 99	Approx. 22 × 16/8.6 × 6.4
	Normal	41	Approx. 195	
	Basic	81	Approx. 380	
 2048×1536	Fine	33	Approx. 157	Approx. 17 × 13/6.8 × 5.1
	Normal	65	Approx. 305	
	Basic	123	Approx. 577	
 1600×1200	Fine	54	Approx. 255	Approx. 14 × 10/5.3 × 4
	Normal	104	Approx. 487	
	Basic	185	Approx. 866	
 1280×960	Fine	83	Approx. 390	Approx. 11 × 8/4.2 × 3.2
	Normal	151	Approx. 709	
	Basic	277	Approx. 1300	
 1024×768	Fine	123	Approx. 577	Approx. 9 × 7/3.4 × 2.5
	Normal	222	Approx. 1040	
	Basic	370	Approx. 1733	
 640×480	Fine	277	Approx. 1300	Approx. 5 × 4/2.1 × 1.6
	Normal	416	Approx. 1950	
	Basic	666	Approx. 3121	
 3984×2656	Fine	10	Approx. 47	Approx. 34 × 22/13.2 × 8.8
	Normal	20	Approx. 95	
	Basic	39	Approx. 185	
 3968×2232	Fine	12	Approx. 57	Approx. 34 × 19/13.2 × 7.4
	Normal	24	Approx. 113	
	Basic	47	Approx. 222	
 2992×2992	Fine	12	Approx. 56	Approx. 25 × 25/9.9 × 9.9
	Normal	23	Approx. 112	
	Basic	46	Approx. 219	

¹ If the number of exposures remaining is 10,000 or more, the number of exposures remaining display shows [9999].

² Print sizes are calculated by dividing the number of pixels by printer resolution (dpi) and multiplying by 2.54 cm (1 in.). However, at the same image size, pictures printed at higher resolutions will print smaller the size indicated, and those printed at lower resolutions will print larger than the size indicated.

Optimize Image

Optimize contrast, sharpening, and other settings according to how pictures will be used or the type of scene.



Normal (default setting)

Recommended in most situations.



Softer

Softens outlines, producing natural results suitable for portraits or retouching on a computer.



Vivid

Enhances saturation, contrast, and sharpness to produce vivid images with vibrant reds, greens, and blues.



More vivid

Maximizes saturation, contrast, and sharpness to produce crisp images with sharp outlines.



Portrait

Lowers contrast while lending natural texture and rounded feel to skin of portrait subjects.



Custom

Customize image optimization settings (p. 95).



Black-and-white

Shoot photos in black-and-white (p. 96).

The indicator for the current optimize image setting is displayed in the monitor during shooting (p. 6).



Optimize Image

At settings other than [Custom] and [Black-and-white] > [Custom], results are optimized for current shooting conditions and vary with exposure and the position of the subject in the frame. For consistent results over a series of photographs, select [Custom] and choose a setting other than [Auto] for contrast, sharpening, and saturation.

Customizing Image Enhancement Options: [Custom]

Select [Custom] to make separate adjustments to the following options.

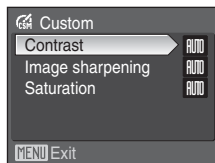

Contrast

Control contrast. Lower settings prevent loss of detail in highlights under harsh lighting or in direct sunlight. Higher settings preserve detail in misty landscapes and other low-contrast subjects. The default setting is [Auto].

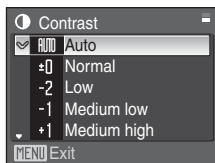
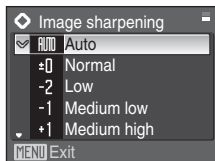

Image sharpening

Choose how much outlines are sharpened during shooting. Choose high settings for sharp outlines, low settings for softer outlines. The default setting is [Auto].



Saturation

Control the vividness of colors. Choose [Moderate] for less saturated colors, [Enhanced] for more vivid colors. The default setting is [Auto].

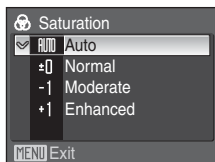

✔ Note on Image Sharpening

The effects of image sharpening cannot be previewed in the monitor during shooting. Check results in playback mode.

Download from [Www.Somanuals.com](http://www.Somanuals.com). All Manuals Search And Download.

Shooting in Black-and-White: [Black-and-White]

When [Black-and-white] is selected, the options described below are available.

Choose [Standard] to shoot in basic black-and-white, or [Custom] to manually adjust contrast, sharpening, and filter effects. When the [B&W + color] option is enabled (✓), one black-and-white picture and the same picture in full color are recorded simultaneously.

The following options can be adjusted in [Custom].

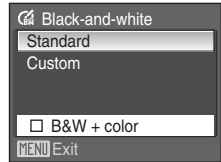

Contrast

Same as [Optimize image] > [Custom] > [Contrast] (95).

Image sharpening

Same as [Optimize image] > [Custom] > [Image sharpening] (95).

Monochrome filter

This effect simulates black-and-white photography with a color filter.

[Yellow], [Orange], [Red]

Enhance contrast. Can be used to tone down the brightness of the sky in landscape photographs. Orange filter results in greater contrast than yellow filter, and red filter greater contrast than orange filter.

[Green]

Softens skin tones. Suitable for portraits.

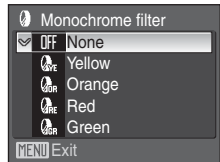

B&W + Color

Color pictures recorded when [B&W + color] is enabled are the same as those shot at an [Optimize image] setting of [Normal].

WB White Balance

The color of light reflected from an object varies with the color of the light source. The human brain is able to adapt to changes in the color of the light source, with the result that white objects appear white whether seen in the shade, direct sunlight, or under incandescent lighting. Digital cameras can mimic this adjustment by processing images according to the color of the light source. This is known as “white balance.” For natural coloration, choose a white balance setting that matches the light source before shooting. Although the default setting, [Auto], can be used under most types of lighting, you can apply the white balance setting suited to a particular light source to achieve more accurate results.

Auto (default setting)

White balance automatically adjusted to suit lighting conditions. Best choice in most situations.

Preset manual

Neutral-colored object used as reference to set white balance under unusual lighting conditions, see “Preset Manual” ( 98) for details.

Daylight

White balance adjusted for direct sunlight.

Incandescent

Use under incandescent lighting.

Fluorescent

Use under most types of fluorescent lighting.

Cloudy

Use when shooting under overcast skies.

Flash

Use with the flash mode.

The effects of the selected option can be previewed in the monitor. At settings other than [Auto], the icon for the current setting is displayed in the monitor ( 6).

Flash Mode

At white-balance settings other than [Auto] or [Flash], turn the flash off (  30).

Download from Www.Somanuals.com. All Manuals Search And Download.

Preset Manual

Preset manual is used with mixed lighting or to compensate for light sources with a strong color cast (for example, to make pictures shot under a lamp with a red shade look as though they had been shot under white light).

1 Place a white or gray reference object under the lighting that will be used during shooting.

2 Use the multi selector to choose [PRE Preset manual] in the white balance menu, and press **OK**.

The camera zooms in.

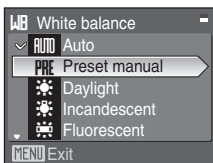

3 Choose [Measure].

To apply the most recently measured value for preset manual, choose [Cancel] and press **OK**.

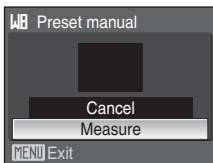

4 Frame the reference object.

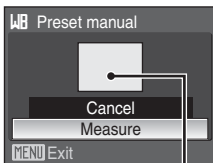

Reference object frame

5 Press **OK**.

The shutter is released and the new white-balance value is set. No pictures are recorded.

Note on Preset Manual

Regardless of the flash mode selected, the flash will not fire when **OK** is pressed in step 5. Therefore, the camera cannot measure a value for preset manual for when the flash is used.

Download from Www.Somanuals.com. All Manuals Search And Download.

ISO ISO Sensitivity

Sensitivity is a measure of how quickly the camera reacts to light. The higher the sensitivity, the less light needed to make an exposure. Although a high ISO rating is suited for shooting pictures of subjects in action or in poor lighting, high sensitivity is often associated with “noise” - randomly spaced, brightly colored pixels concentrated in dark parts of the image.

Auto (default setting)

Sensitivity is ISO 64 under normal conditions; when lighting is poor and the flash is off, the camera compensates by raising sensitivity to a maximum of ISO 800. When a Speedlight (available separately from Nikon) is used with sensitivity set to [Auto], the maximum sensitivity applied is ISO 400. In **M** mode, sensitivity will be locked at ISO 64.

Fixed range auto

Choose the range in which the camera automatically adjusts ISO sensitivity, in **P**, **S**, and **A** modes, from [ISO 64 - 100] (default setting), [ISO 64 - 200], or [ISO 64 - 400]. The camera will not raise sensitivity beyond the maximum value in the selected range for effective control over the amount of “grain” that appears in images.

64, 100, 200, 400, 800, 1600, 2000, 3200

Sensitivity will be locked at the specified value.

At the settings other than [Auto], the current setting is displayed in the monitor (📷 6). If [Auto] is selected and the sensitivity is raised above ISO 64, the 📷 icon will be displayed (📷 31). When [Fixed range auto] is selected, the maximum value of [R] + the sensitivity will be displayed.

✓ Notes on ISO 3200

- When [3200] is selected for ISO sensitivity, image size is displayed in red during shooting.
- [Image size] cannot be set to [📷 4000×3000], [📷 3264×2448], [📷 3984×2656], [📷 3968×2232], and [📷 2992×2992] when [ISO sensitivity] is set to [3200]. If [ISO sensitivity] is set to [3200] while [Image size] is set to [📷 4000×3000], [📷 3264×2448], [📷 3984×2656], [📷 3968×2232], or [📷 2992×2992], the [Image size] setting automatically switches to [📷 2592×1944]. When any option other than [3200] is next selected for [ISO sensitivity], the original image size setting is restored.

✓ Note on Shutter Speed

When [1600], [2000], or [3200] is selected for [ISO sensitivity], the slowest shutter speed available is down to 2 sec.

Download from [Www.Somanuals.com](http://www.Somanuals.com). All Manuals Search And Download.

Metering

Choose how the camera meters exposure.



Matrix (default setting)

Camera sets exposure for entire frame. Recommended in most situations.



Center-weighted

Camera meters entire frame but assigns greatest weight to subject in center of frame. Classic meter for portraits; preserves background details while letting lighting conditions at center of frame determine exposure. Can be used with focus lock ( 27) to meter off-center subjects.



Spot

Camera meters area shown by circle in center of frame. Ensures that subject in metering target is correctly exposed even if background is much lighter or darker. Can be used with focus lock ( 27) to meter off-center subjects.



Spot AF area

Camera meters selected focus area ( 105). Available only when a setting other than [Center] is selected for [AF area mode].

Digital Zoom

- When digital zoom is in effect, [AF area mode] is set to [Center] ( 105).
- At magnifications of 1.2X to 1.8X, [Metering] is set to [Center-weighted], and at magnifications of 2.0X to 4.0X, [Metering] is set to [Spot].



Metering Area

The active metering area is displayed in the monitor when [Center-weighted] or [Spot] is selected.

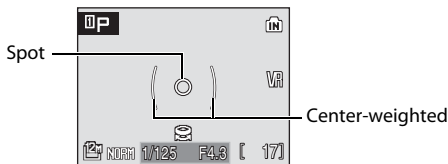

Continuous

Capture motion in a series of pictures and apply Best Shot Selector (BSS). When [Continuous], [BSS], or [Multi-shot 16] is selected, the flash will be disabled. At settings other than [Intvl timer shooting], focus, exposure and white balance are fixed at the values for the first picture in each series.

Single (default setting)

One picture is shot each time shutter-release button is pressed.

Continuous

While the shutter-release button is held down, up to 5 pictures are shot at a rate of 1.1 frames per second (fps) when image quality is set to [Normal] and image size is set to [4000x3000].

BSS

BSS is recommended for shooting under low lighting without the flash, with the camera zoomed in, or in other situations in which camera shake is likely to blur pictures.

When Best Shot Selector (BSS) is enabled, the camera shoots up to ten pictures while the shutter-release button is held down. The sharpest picture (picture with the most detail) in the series is automatically selected and saved.

Continuous flash

While the shutter-release button is held down, the camera shoots three flash pictures, at up to 1.1 fps, when image quality is set to [Normal] and image size is set to [4000x3000]. Once shooting ends, no additional pictures can be shot until built-in flash has charged. Because ISO sensitivity is raised during shooting, pictures may be affected by "noise" (randomly-spaced, brightly-colored dots).

Multi-shot 16

Each time shutter-release button is pressed, camera shoots 16 pictures at about 1.1 frames per second and arranges them in a single picture with image quality is set to [Normal] and image size is set to [2592x1944]. Digital zoom cannot be applied.

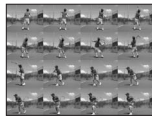

Intvl timer shooting

Camera shoots (up to 1,800 frames) automatically at specified interval (103).

At settings other than [Single], the indicator for the current setting is displayed in the monitor (6).



Note on Best Shot Selector

BSS may not produce the desired results if the subject moves or the composition changes while the shutter-release button is pressed all the way down.

Note on Continuous Flash

When [Continuous flash] is selected for [Continuous], turning on the Speedlight will change the option to [Single].

Note on Shutter Speed

When [Continuous], [BSS], [Continuous flash], or [Multi-shot 16] is selected for [Continuous] ( 101), or when a setting other than [Off] is selected for [Auto bracketing] ( 104), the slowest shutter speed available is down to 1/2 sec.

Note on Continuous Shooting

The maximum frame rate with continuous shooting may vary, depending upon the current image quality setting, image size setting, and the memory card used.

More Information

See “Built-in flash, Speedlights (available separately from Nikon)” ( 114) and “Using Optional Speedlights” ( 139) for more information.

Interval Timer Photography

Pictures are shot automatically at specified intervals. Choose from intervals between 30 seconds and 60 minutes.

- 1 Use the multi selector to choose [Intvl timer shooting] in the continuous menu, and press .

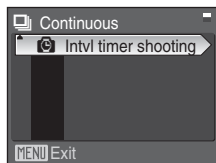

- 2 Choose interval between shots and press .

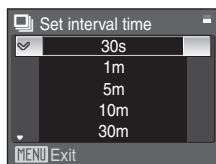

- 3 Press MENU.

The camera returns to shooting mode.

- 4 Press the shutter-release button all the way down to shoot the first picture and initiate interval timer shooting.

Monitor turns off and power-on lamp blinks between shots.

The monitor turns back on automatically right before the next picture is shot.

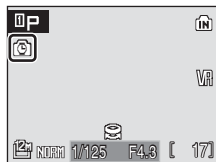

- 5 Press the shutter-release button all the way down a second time to end recording.

Recording will end automatically if the internal memory or memory card becomes full, or when 1,800 pictures have been recorded.

Note on Interval Timer Shooting

- To prevent the camera from turning off unexpectedly during recording, use a fully charged battery.
- To power the camera continuously for extended periods, use an AC Adapter EH-62A (available separately from Nikon) ( 136). **Do not, under any circumstances, use another make or model of AC adapter.** Failure to observe this precaution could result in overheating or in damage to the camera.
- Do not rotate the mode dial, while performing interval-timer shooting.

More Information

See "Image/Sound File and Folder Names" ( 140) for more information.

Download from [Www.Somanuals.com](http://www.Somanuals.com). All Manuals Search And Download.

BKT Auto Bracketing

Auto bracketing is used to vary exposure by a selected amount over a series of pictures, “bracketing” the exposure value selected by the camera or with exposure compensation. Use in situations in which it is difficult to guess the correct exposure.

 ±0.3

Camera varies exposure by 0 EV, +0.3EV, and -0.3EV over next three shots. Keep shutter-release button pressed to take all three shots in sequence.

 ±0.7

Camera varies exposure by 0 EV, +0.7EV, and -0.7EV over next three shots. Keep shutter-release button pressed to take all three shots in sequence.

 ±1.0

Camera varies exposure by 0 EV, +1.0EV, and -1.0EV over next three shots. Keep shutter-release button pressed to take all three shots in sequence.

OFF Off (default setting)

Bracketing is not performed.

At settings other than [Off], the icon for the current setting is displayed in the monitor during shooting ( 6).

Notes on Auto Bracketing

- Auto bracketing is not available in **M** mode.
- When exposure compensation is applied ( 34), and [±0.3], [±0.7], or [±1.0] is selected for [Auto bracketing], the combined exposure compensation values will be applied.
- When a setting other than [Off] is selected for [Auto bracketing], the slowest shutter speed available is down to 1/2 sec.

[AF] AF Area Mode

Use this option to determine where the camera focuses.

When digital zoom is effect, the camera will focus on the subject in the center focus area regardless of the applied [AF area mode] option.



Face priority

The camera automatically detects and focuses on a face looking toward the camera (Shooting with Face-Priority → [106]).

When shooting pictures of subjects other than people, or framing a subject with which no face is recognized, [AF area mode] will be set to [Auto]. The camera chooses the focus area (one of nine) containing the subject closest to the camera and focuses on the subject. When the monitor has been turned off, the camera focuses using only the center focus area.

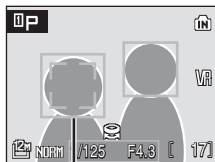

Focus area



Auto (default setting)

Camera automatically selects the focus area (one of nine) containing the subject closest to the camera. Press the shutter-release button halfway to activate the focus area. When the shutter-release button is pressed halfway, the focus area selected by the camera will be displayed in the monitor.

When the monitor has been turned off, the camera focuses using only the center focus area.

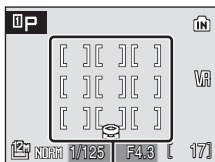

Focus area



Manual

This option is suited to situations in which the intended subject is relatively still and not positioned in the center of the frame.

Press the multi selector ▲, ▼, ◀ or ▶ to select from 99 focus areas in the frame. Pictures can be shot while focus-area selection screen is displayed.

To end focus-area selection and adjust the flash mode, focus mode, self-timer and exposure compensation settings, press **OK**. To return to the focus-area selection screen, press **OK**.

- At an [Image size] setting ([92]) of [L1] 2992x2992, 81 focus areas are available.

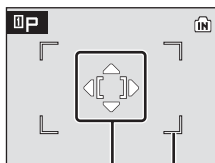

Focus area
Selectable focus areas

Center

Camera focuses on subject in center of frame.
Center focus area is used.

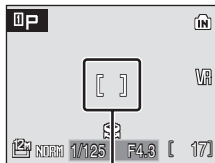

Focus area

Shooting with Face-Priority

When [Face priority] is selected for [AF area mode], or the [Portrait] scene mode or [Night portrait] scene mode is selected during shooting, the face-priority function will be applied.

The camera automatically detects and focuses on a face looking toward the camera.

1 Frame the picture.

When the camera detects a face, the focus area containing the face will be displayed with a yellow double border.

When the camera detects more than one face, the closest face is framed by a double border and the others by single borders. Up to 12 faces can be detected.

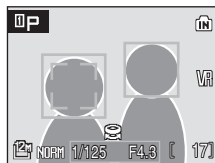

2 Press the shutter-release button halfway.

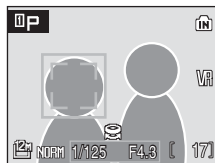

The camera focuses on the face framed by the double border. The double border will glow green and focus will be locked.

When the double border blinks, the camera is unable to focus. Press the shutter-release button again to focus.



Press the shutter-release button all the way down to shoot.

Face-Priority

- When [Face priority] is selected for [AF area mode], the setting will automatically switch to [Auto] if no face is recognized when the shutter-release button is pressed halfway.
- If no face is recognized when the shutter-release button is pressed halfway in [Portrait] or [Night portrait] scene mode, the camera will focus on the subject in the center focus area.
- If [Face priority] is selected for [AF area mode] with framing guides displayed, the monitor setting changes so that shooting data is displayed.
- The camera may be unable to detect faces in the following situations:
 - When faces are partially hidden by sunglasses or other obstructions
 - When faces take up too much or too little of the frame
 - When the subject is not looking directly at the camera
- The camera's ability to detect faces depends on a variety of factors, including whether or not the subject is facing the camera.
- In some rare cases shooting subjects with which autofocus may not perform as expected ( 27), the subject may not be in focus despite the fact that the focus area glows green. Should this occur, switch to  (auto) mode or change the [AF area mode] setting to [Manual] or [Center] in high-sensitivity shooting, **P**, **S**, **A**, and **M** modes, refocus on another subject positioned at the same distance from the camera as the actual portrait subject, and use focus lock ( 27).
- When a face is detected during shooting, pictures will be rotated automatically, in full-frame and thumbnail playback modes, according to the orientation of the face detected.

More Information

See "Autofocus" ( 27) for more information.

Auto-focus Mode

Choose how the camera focuses.

Single AF (default setting)

Camera focuses when shutter-release button is pressed halfway.

Full-time AF

Camera adjusts focus continuously until shutter-release button is pressed halfway. Use with moving subjects.

Flash Exp. Comp.

Flash compensation is used to adjust flash output by ± 2.0 EV in increments of $1/3$ EV, changing the brightness of the main subject relative to the background. When the Speedlight SB-400, SB-600, or SB-800 flash unit (available separately from Nikon) ( 139) is mounted on the camera, flash output for the flash (available separately from Nikon) is adjusted.

-0.3 - -2.0

Flash output is reduced from -0.3 to -2.0 EV, in increments of $1/3$ EV, to prevent unwanted highlights or reflections.

0 (default setting)

Flash output is not adjusted.

+0.3 - +2.0

Flash output is increased from +0.3 to +2.0 EV, in increments of $1/3$ EV, to make the main subject of the frame appear brighter.

At settings other than [0], the icon for the current setting is displayed in the monitor during shooting ( 6).

Flash Control

Specify whether or not the built-in flash fires when a flash unit (available separately from Nikon) mounted on the camera's accessory shoe is not used ( 139).

Auto (default setting)

When a flash (available separately from Nikon) is mounted, the flash fires. When there is no flash mounted on the accessory shoe, the built-in flash fires.

Built-in off

The built-in flash is disabled.

Notes on Flash Control

When [Flash control] is set to [Built-in off], only  (Auto), and  (Off), and  (Fill flash) flash modes ( 30) are available.

Fixed Aperture

Choose whether aperture varies with zoom position.

On

In **A** and **M** modes, aperture is kept as close as possible to selected f-number. To prevent selected f-number from exceeding exposure range at new zoom position, set aperture to around $f/5.1$ – $f/7.3$.

Off (default setting)

Aperture varies with zoom position.

NR Noise Reduction

At slow shutter speeds, pictures may be affected by “noise” in the form of randomly-spaced, brightly-colored dots concentrated in dark parts of the image. Use this option to reduce noise at slow shutter speeds. Enabling noise reduction increases the time needed to record pictures after they are shot.

AUTO Auto (default setting)

Noise reduction is performed at slow shutter speeds, likely to result in pictures affected by noise.

When a setting other than [Single] or [Intvl timer shooting] is selected for [Continuous], or when a setting other than [Off] is selected for [Auto bracketing], noise reduction will not be performed.

NR On

Noise reduction is applied to pictures shot at shutter speeds slower than 1/4 sec. [On] is recommended when shooting at slow shutter speeds.

Only [Single] or [Intvl timer shooting] can be selected for [Continuous]. [Auto bracketing] cannot be applied.

When noise reduction is performed, the **NR** icon is displayed in the monitor during shooting ( 6).

Converter

This option is for use with the Step-down Ring Adapter UR-E20 (available separately from Nikon) to attach the converter lenses (available separately from Nikon) listed below. For more information, see “Attaching Converter Lenses” ( 138) of this manual or the documentation provided with the converter lens.

OFF None (default setting)

No modifications made to camera settings. Use when no converter lens is attached (be sure to remove lens adapter ring).

Wide-angle converter

Use with the Wide-angle Converter WC-E67. When selecting this option, the camera is zoomed out to the maximum wide-angle position. Enjoy wide-angle shooting at a focal length of roughly 23.5 mm (0.9 in.) (equivalent with 35mm [135] picture angle) when [Distortion control] is set to [Off] and the camera is zoomed out to the maximum wide-angle position. The full range of optical zoom is available, however, by its very nature, best results are achieved with the camera zoomed out to the maximum wide-angle position. Digital zoom is not available.

Telephoto converter

Use with the Telephoto Converter TC-E3ED. When selecting this option, the camera is zoomed to the maximum telephoto position. Enjoy telephoto shooting at a focal length of roughly 369 mm (14.5 in.) (equivalent with 35mm [135] picture angle) with the camera zoomed in to the maximum telephoto position. Optical zoom is limited to near the maximum telephoto position. Focus mode ( 33) cannot be adjusted.



















At settings other than [None], the icon for the current setting is displayed in the monitor during shooting ( 6).

Notes on Converter

- Be sure to select the appropriate option when using a converter lens. Select [None] when no converter lens is attached.
- At settings other than [None], the built-in flash and AF-assist illuminator turn off. [Continuous flash] cannot be used. Flash units (available separately from Nikon) can still be used, although the converter may cast shadows in pictures shot with the Speedlight SB-400, SB-600, or SB-800 (☒ 139; a wide panel is recommended when shooting with the Speedlight SB-600 or SB-800). Check pictures in the monitor after shooting.

User Setting

Fourteen shooting menu settings and three button operations can be stored in two separate “banks,” **1** and **2**. Assigning different settings to each bank allows for quick adjustment of settings to suit a variety of situations. The setting assigned for each function is stored, as is, in the designated user setting bank when the camera is turned off. The following settings can be stored in user setting banks.

 Image quality ¹	 ISO ISO sensitivity ³	 AF area mode ⁴	 Fixed aperture
 Image size ¹	 Metering	 Auto-focus mode	 NR Noise reduction
 Optimize image	 Continuous	 Flash exp. comp.	 Converter
 White balance ²	 Auto bracketing	 Flash control	 Distortion control
 (Flash mode)	 (exposure compensation)	 (Focus mode)	

¹ The current image quality and size settings will be displayed. These settings will not be stored in user setting banks.

² Preset white balance value measured using [Preset manual] cannot be stored in either user settings bank.

³ In high-sensitivity shooting mode, ISO sensitivity is automatically set so that [Auto] is displayed. When any mode other than high-sensitivity shooting mode is selected, the setting assigned to the bank will be recalled.

⁴ Focus area selected in [Manual] can be stored in user settings banks.

Reset User Setting

Choose [Yes] to restore all settings in the selected user setting bank to their default values. For further information on settings that can be stored in user setting banks, see [User setting] ( 111).

Distortion Control

Specify whether or not the distortion is corrected. Enabling distortion control reduces the size of the frame.



On



Distortion at frame peripheries is corrected.





Off (default setting)

No distortion correction performed.

Restrictions on Camera Settings

Restrictions apply to the following settings in  (auto), **P, S, A, M**, and  (high sensitivity) modes.

Flash mode

Flash mode is disabled () when [Continuous], [BSS], or [Multi-shot 16] is selected for [Continuous], when [Auto bracketing] is enabled, or at [Converter] settings of [Wide-angle converter] or [Telephoto converter]. When [Continuous] is set to [Continuous flash], the flash mode is set to . Applied setting is restored when [Single] or [Intvl timer shooting] is selected for [Continuous], or [Auto bracketing] is turned off.

Self-timer

If self-timer is on, only one picture will be shot when shutter is released, regardless of settings chosen for [Continuous] and [Auto bracketing]. Applied [Continuous] and [Auto bracketing] settings are restored when picture is shot or self-timer is turned off.

Focus mode

[▲ Infinity] is not available when [Continuous] is set to [Continuous flash]. If [Continuous] is set to [Continuous flash] while focus mode is set to [▲ Infinity], the focus mode setting automatically switches to [AF Autofocus].

When [Face priority] is selected for [AF area mode], setting focus mode to [▲ Infinity] changes [AF area mode] to [Auto]. Selecting an option other than [▲ Infinity] for focus mode restores [AF area mode] to [Face priority].

Optimize image

Selecting [Black-and-white] for [Optimize image] changes [White balance] to [Auto]. Selecting an option other than [Black-and-white] for [Optimize image] restores the original [White balance] setting.

Enabling the [B&W + color] option (✓) for the [Black-and-white] item in the [Optimize image] menu changes the [Continuous] setting to [Single] and the [Auto bracketing] setting to [Off]. These [Continuous] and [Auto bracketing] settings do not change when the [B&W + color] option is disabled.

ISO sensitivity

[Image size] cannot be set to [L 4000×3000], [8M 3264×2448], [2.2M 3984×2656], [6.9M 3968×2232], and [1.1M 2992×2992] when [ISO sensitivity] is set to [3200].

If [ISO sensitivity] is set to [3200] while [Image size] is set to [L 4000×3000], [8M 3264×2448], [2.2M 3984×2656], [6.9M 3968×2232], or [1.1M 2992×2992], the [Image size] setting automatically switches to [5M 2592×1944]. When any option other than [3200] is next selected for [ISO sensitivity], the original image size setting is restored.

Continuous

Selecting an option other than [Single] for [Continuous] turns [Auto bracketing] off. Selecting [Multi-shot 16] changes image quality setting to [Normal] and image size setting to [5M 2592×1944].

Auto bracketing

When [Auto bracketing] is enabled, [Continuous] will be set to [Single] and the flash mode will be disabled (⊗).

Noise reduction

When [Auto] of [Noise reduction] is applied with [Continuous] set to an option other than [Single] or [Intvl timer shooting], or with [Auto bracketing] set to an option other than [Off], noise reduction will not be performed. Selecting [On] for [Noise reduction] changes [Continuous] to [Single], when an option other than [Intvl timer shooting] is selected for [Continuous], and [Auto bracketing] to [Off].

Converter

Selecting [Wide-angle converter] or [Telephoto converter] for [Converter] changes the flash mode to .

Distortion control

When [Distortion control] is set to [On], [Continuous] is automatically set to [Single] and [Auto bracketing] is set to [Off].

When the [Distortion control] option is disabled, the [Continuous] and [Auto bracketing] settings will be restored.

Built-in flash, Speedlights (available separately from Nikon)



















Built-in flash and Speedlight SB-400, SB-600, or SB-800 flash unit (available separately from Nikon) operation is restricted, as shown below, depending upon the applied [Continuous] setting.

Continuous mode	Built-in flash	Flash units
Single	Available	Available
Continuous	Off	Available
BSS	Off	Available
Continuous flash	Available	Not available
Multi-shot 16	Off	Available
Intvl timer shooting	Available	Available

When a flash unit (available separately from Nikon) is mounted on the camera's accessory shoe, the built-in flash is automatically disabled.

Playback Options: The Playback Menu

The playback menu contains the following options.

 D-Lighting  55	
Copy current picture with enhanced details in shadows.	
 Print set  87	
Select pictures to print and the number of copies for each.	
 Slide show  117	
View pictures stored in the internal memory or on a memory card in an automatic slide show.	
 Delete  118	
Delete all or selected pictures.	
 Protect  118	
Protect selected pictures from accidental deletion.	
 Hide image  118	
Hide selected pictures during playback.	
 Small pic.  57	
Create a small copy of the current picture.	
 Copy  119	
Copy files between memory card and internal memory.	
 Black border  58	
Create the new picture surrounding with black border.	

Displaying the Playback Menu

Display the playback menu by pressing  and pressing **MENU**.

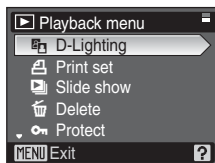
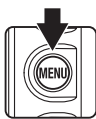

- Use the multi selector to choose and apply settings ( 10).
- To exit the playback menu, press **MENU**.

Selecting Multiple Pictures

The picture selection screen, as shown at right, will be displayed with the following menus:

- **Playback menu:** print set (87), delete (118), protect (118), hide image (118), copy (119)
- **Setup menu:** welcome screen (122)

Follow the procedure described below to select multiple pictures.

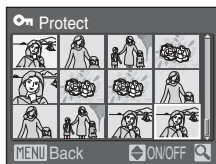

1 Press the multi selector ◀ or ▶ to choose the desired picture.

The command dial can also be used in place of the multi selector.

Only one picture can be selected for [Welcome screen]. Proceed to step 3.

Rotate the zoom control to **T** (Q) to switch to full-frame playback.

Rotate the zoom control to **W** (checkered icon) to switch back to thumbnail display.

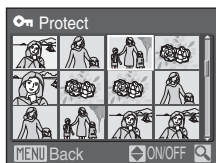

2 Press ▲ or ▼ to select [ON] or [OFF] (or the number of copies).

When [ON] is selected, a check mark (✓) is displayed in the top left corner of the current picture. Repeat steps 1 and 2 to select additional pictures.

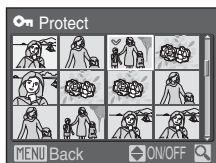

3 Press OK.

The setting is enabled.

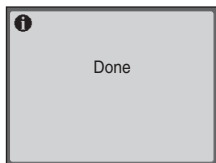

Slide Show

Play back pictures, stored in the internal memory or on a memory card, one by one in an automated "slide show."

1 Use the multi selector to choose [Start] and press **OK**.

To change the interval between pictures, choose [Frame intvl], select the desired interval time, and press **OK** before choosing [Start].

To repeat the slide show automatically, enable [Loop] and press **OK** before choosing [Start]. The check mark (**✓**) will be added to the loop option when enabled.

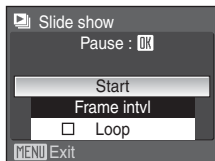

2 The slide show begins.

While the slide show is in progress, the following operations can be performed:

- Press the multi selector **▶** to view pictures in the order recorded, or **◀** to view pictures in reverse order. Press and hold **▶** to fast forward, or **◀** to rewind.
- Press **OK** to pause the slide show.



3 Choose [End] or [Restart].

When the slide show ends or is paused, choose [End] and press **OK** to return to the playback menu, or choose [Restart] to play the slide show again.

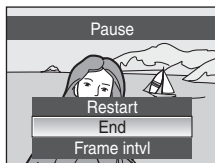

Notes on Slide Show

- Only the first frame of movies (**70**) included in slide shows is displayed.
- Even if [Loop] is selected, the monitor will turn off automatically if no operations are performed for 30 minutes. The camera will turn off automatically if no operations are performed for another three minutes.

Download from [Www.Somanuals.com](http://www.Somanuals.com). All Manuals Search And Download.

Delete

Delete selected pictures or all pictures.

Erase selected images

Delete selected pictures ( 116).

Erase all images

Delete all pictures.





Notes on Deletion

- Once deleted, pictures cannot be recovered. Transfer important images to a computer before deletion.
- Pictures marked with the  icon are protected and cannot be deleted.

Protect

Protect selected pictures from accidental deletion (Selecting Multiple Pictures →  116).

Note, however, that formatting the camera's internal memory or the memory card will permanently erase protected files ( 131).

Protected pictures are recognized by the  icon ( 7) in full-frame playback mode and the erase selected images screen, and by the  icon ( 51) in four-picture or nine-picture thumbnail playback mode.

Hide Image

Use this setting to hide pictures during playback.

See "Selecting Multiple Pictures" ( 116) for more information on using this function.

Hidden pictures cannot be deleted using the [Delete] option. Note, however, that formatting the internal memory or memory card ( 131) will delete hidden pictures.

Copy

Copy pictures between the internal memory and a memory card.

1 Use the multi selector to select an option from the copy screen and press **OK**.

IN → **IN**: Copy pictures from internal memory to memory card.

IN → **IN**: Copy pictures from memory card to internal memory.

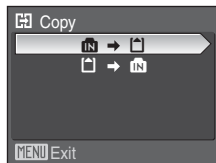

2 Select a copy option and press **OK**.

Selected images: Copy pictures selected from the picture selection screen (**OK** 116).

All images: Copy all pictures.

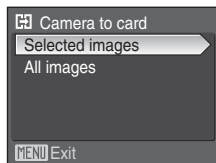

Notes on Copying Pictures

- JPEG-, AVI-, and WAV-format images can be copied. Images recorded in any other format cannot be copied.
- If voice memos (**OK** 59) are attached to pictures selected for copying, voice memos are copied with the pictures. However, sound files recorded in voice recording mode (**OK** 71) cannot be copied with this option. Sound files can be copied using the [Copy sound files] option (**OK** 75) in audio playback mode.
- Pictures recorded with another make of camera or that have been modified on a computer cannot be copied.
- Edited copies have the same protection marking (**OK** 118) as the original, but are not marked for printing (**OK** 87).
- Hidden pictures (**OK** 118) cannot be copied.

[Memory contains no images.] Message

If there are no pictures stored on the memory card when playback mode is applied, the message [Memory contains no images.] will be displayed. Press **MENU** to display the copy option screen, and copy the pictures stored in the camera's internal memory to the memory card.

































More Information

See "Image/Sound File and Folder Names" (**OK** 140) for more information.

Download from [Www.Somanuals.com](http://www.Somanuals.com). All Manuals Search And Download.

Basic Camera Setup: The Setup Menu

The setup menu contains the following options.

	Menu	 121
	Choose how menus are displayed.	
	Welcome screen	 122
	Select screen displayed when camera is turned on.	
	Date	 123
	Set camera clock and choose home and destination time zones.	
	Brightness	 126
	Adjust monitor brightness.	
	Date imprint	 126
	Imprint date or date counter on pictures.	
	Vibration reduction	 128
	Adjust vibration reduction settings for shooting.	
	AF assist	 129
	Enable or disable AF-assist illumination.	
	Digital zoom	 129
	Enable or disable digital zoom.	
	Sound settings	 130
	Adjust sound and volume settings.	
	Auto off	 130
	Set time before camera enters standby mode.	
	Format memory/Format card	 131
	Format internal memory or memory card.	
	Language	 132
	Choose the language used for camera monitor display.	
	Video mode	 132
	Adjust settings for connection to TV.	
	FUNC button	 132
	Choose function performed when Fn is pressed.	
	Reset all	 133
	Restore camera settings to default values.	
	Firmware version	 135
	Display camera firmware version.	

Displaying the Setup Menu

Rotate the mode dial to **SET UP**.

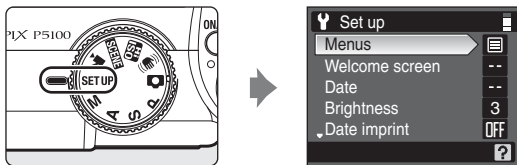

- Use the multi selector to choose and apply settings (📷 10).
- To exit the setup menu, rotate the mode dial to another mode.

MENU Menus

Switch the initial menu displayed.

Text (default setting)

Text labels for menus are displayed in list format.

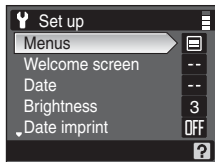

Icons

All menu items can be displayed in a single page.

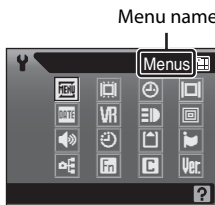

Welcome Screen

You can select the welcome screen to be displayed when the camera is turned on.



Disable welcome (default setting)







Welcome screen is not displayed.

COOLPIX

Displays a welcome screen.

Select an image

Select a picture in the internal memory or on the memory card for the welcome screen. Choose a picture in the picture selection screen ( 116) and press . As the selected image is stored in the camera, the image will appear in the welcome screen even if the original picture is deleted.

Pictures shot at an [Image size] setting ( 92) of [ 3984x2656], [ 3968x2232], or [ 2992x2992], or copies created with [ 160x120] of the small picture function ( 57), cannot be selected.

Date



Set the camera clock and choose home and travel destination time zones.

Date

Set camera clock to current date and time.

See steps 6 and 7 of the section, "Setting Display Language, Date and Time" (19), for more information.

Time zone

 (home time zone) can be specified and daylight saving enabled or disabled from [Time zone] options. When  (destination time zone) is selected, the time difference (125) is automatically calculated and the date and time in the selected region are recorded. Useful when travelling.

Setting Travel Destination Time Zone

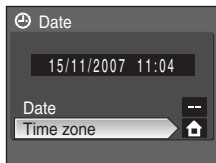

- 1 Use the multi selector to choose [Time zone] and press .

The time zone menu is displayed.



- 2 Choose  and press .

The date and time displayed on the monitor changes according to the region currently selected.

If daylight saving time is in effect, use the multi selector to choose [Daylight saving] and press , and then press the multi selector . The time is automatically advanced one hour.

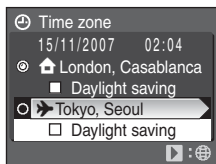

3 Press the multi selector .

The new city time zone menu is displayed.

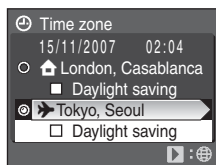

4 Choose the travel destination time zone and press .

The setting is enabled.

While the travel destination time zone is selected, the  icon will be displayed in the monitor when the camera is in shooting mode.

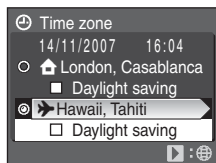



The Clock Battery

The clock battery charges when the main battery is installed or the AC Adapter EH-62A (available separately from Nikon) is connected, and can provide several days of backup power after about ten hours of charging.

Home Time Zone

- To switch to the home time zone, choose  in step 2.
- To change the home time zone, choose  in step 2 and perform steps 3 and 4, to set the home time zone.

Daylight Saving Time

- If date and time are set when daylight saving time is not in effect: Turn [Daylight saving] on () when daylight saving time begins, to automatically advance the camera's clock one hour.
- If date and time are set with [Daylight saving] turned on () when daylight saving time is in effect: Turn [Daylight saving] off when daylight saving time ends, to automatically set the camera's clock back one hour.

 **Time Zones (18)**

The camera supports the time zones listed below. For time differences not listed below, set the camera clock to local time (18, 123).

GMT +/-	Location	GMT +/-	Location
-11	Midway, Samoa	+1	Madrid, Paris, Berlin
-10	Hawaii, Tahiti	+2	Athens, Helsinki
-9	Alaska, Anchorage	+3	Moscow, Nairobi
-8	PST (PDT): Los Angeles, Seattle, Vancouver	+4	Abu Dhabi, Dubai
-7	MST (MDT): Denver, Phoenix, La Paz	+5	Islamabad, Karachi
-6	CST (CDT): Chicago, Houston, Mexico City	+5.5	New Delhi
-5	EST (EDT): New York, Toronto, Lima	+6	Colombo, Dhaka
-4	Caracas, Manaus	+7	Bangkok, Jakarta
-3	Buenos Aires, São Paulo	+8	Beijing, Hong Kong, Singapore
-2	Fernando de Noronha	+9	Tokyo, Seoul
-1	Azores	+10	Sydney, Guam
±0	London, Casablanca	+11	New Caledonia
		+12	Auckland, Fiji

Brightness

Choose from five settings for monitor brightness. The default setting is [3].

Date Imprint

Date and time of recording can be imprinted on pictures. This information can be printed even from printers that do not support printing of date and time ( 88).

Off (default setting)

Date and time are not imprinted on pictures.

Date

Date is imprinted on the bottom right corner of pictures shot while this option is in effect.

Date and time





Date and time are imprinted on the bottom right corner of pictures shot while this option is in effect.

Date counter

Time stamp shows number of days between date of recording and selected date.

At settings other than [Off], the icon for the current setting is displayed in the monitor ( 6).

Date Imprint

- Imprinted dates form a permanent part of image data and cannot be deleted.
- Dates imprinted at an image size setting ( 92) of  (640 × 480) may be difficult to read. Choose  (1,024 × 768) or larger when using date imprint.
- The date is recorded using the format selected in the setup menu's [Date] item ( 18, 123).
- Date cannot be imprinted on pictures shot in certain modes ( 149).

Date Imprint and Print Set

When printing from DPOF-compatible printers which support printing of shooting date and photo information, the date and information can be printed on pictures without date and time imprinted on them, using options in the [Print set] menu ( 87).

Download from Www.Somanuals.com. All Manuals Search And Download.

Date Counter

Pictures shot while this option is in effect are imprinted with the number of days remaining until, or the number of days elapsed since a specified date. Use it to track the growth of a child or count down the days until a birthday or wedding.

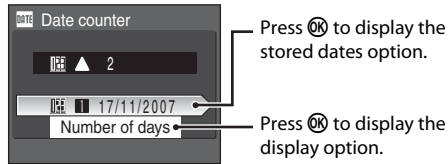

Stored dates

Up to three dates can be stored. To set, choose an option, press the multi selector **▶**, enter a date (see 19, step 6), and press **OK**. To select a different date, choose an option and press **OK**.

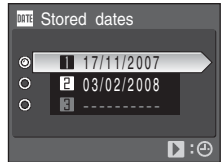

Display options

Choose [Number of days], [Years and days], or [Yrs, mnths, days] and press **OK**.

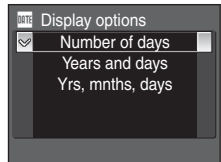

Sample date counter time stamps are shown below.



Two days remaining



Two days elapsed

Vibration Reduction

Vibration reduction effectively corrects blur, caused by slight hand movement known as camera shake, that commonly occurs when shooting with zoom applied or at slow shutter speeds. Vibration reduction can be used in all shooting modes.

Vibration reduction is enabled in anti-shake mode ( 43) regardless of the option selected for [Vibration reduction].

On (default setting)

Vibration reduction is enabled when shooting still pictures and recording movies. Camera detects and factors out panning movements when reducing camera shake. When camera is panned horizontally, for example, vibration reduction reduces only vertical shake. If camera is panned vertically, vibration reduction affects only horizontal shake.

Off

Vibration reduction is not enabled.

When vibration reduction is enabled, the current setting is displayed in the monitor during shooting (when [Off] is selected, an icon for the current setting is not displayed in the monitor) ( 6).

Notes on Vibration Reduction

- Vibration reduction may take a few seconds to activate after the power is turned on, or the camera enters shooting mode from playback mode. Wait until the display stabilizes before shooting.
- Due to characteristics of the vibration reduction function, images displayed in the camera's monitor immediately after shooting may appear blurry.
- Turn vibration reduction off when using a tripod to stabilize the camera during shooting.
- Vibration reduction may be unable to completely eliminate the effects of camera shake in some situations.
- [VR] stands for vibration reduction.

AF Assist

Enable or disable AF-assist illumination.

Auto (default setting)

AF-assist illumination will be used to assist the focus operation when the subject is poorly lit. Note that for some scene modes, AF-assist illumination turns off automatically.

Off

Disable this function. The camera may be unable to focus if lighting is poor.

Digital Zoom

Use this setting to control digital zoom operation.

On (default setting)

Rotating and holding the zoom control at **T** (Q), at the maximum optical zoom position, triggers digital zoom (25).

Crop

Limit digital zoom to the range at which image quality does not suffer.

Off

Disable digital zoom except when recording movies.

Notes on Digital Zoom

- When digital zoom is in effect, [AF area mode] is set to [Center] (105).
- Digital zoom is not available in the following situations.
 - When [Portrait] or [Night portrait] is selected in scene mode
 - When [Multi-shot 16] is selected for [Continuous] (101)
 - When [Converter] (110) is set to [Wide-angle converter]
 - Before movie recording begins (however, digital zoom of up to 2x can be applied while movies, other than stop-motion movies, are being recorded)
- At magnifications of 1.2x to 1.8x, [Metering] is set to [Center-weighted], and at magnifications of 2.0x to 4.0x, [Metering] is set to [Spot].

Sound Settings

Adjust the following sound settings.

Button sound

Turn button sound on or off.

When [On] (default setting) is selected, a beep will sound once when operations are completed successfully, twice when the camera acquires focus on the subject, and three times when an error is detected. Start-up sound will also play when the camera is turned on.

Shutter sound

Choose shutter sound from [On] (default setting) or [Off].

Auto Off

If no operations are performed for the selected length of time, the monitor will turn off and the camera will enter standby mode ( 23) to reduce the drain on the battery. The power-on lamp will blink in standby mode. If no operations are performed for about another three minutes, the camera will turn off automatically. Choose the time allowed to elapse before the camera enters standby mode. The time options are [30s], [1m] (default setting), [5m], and [30m].

Notes on Auto Off

Regardless of the option selected, the monitor will remain on for three minutes when menus are displayed, or for 30 minutes during continuous playback for slide shows or when the AC Adapter EH-62A (available separately from Nikon) is connected.

Download from [Www.Somanuals.com](http://www.Somanuals.com). All Manuals Search And Download.

Format Memory / **Format Card**

Use this option to format the internal memory or a memory card.

Formatting the Internal Memory

To format the internal memory, remove the memory card from the camera.

The [Format memory] option appears in the setup menu.

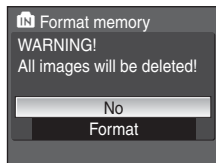

Formatting a Memory Card

When the memory card is inserted in the camera, the [Format card] option appears in the setup menu.

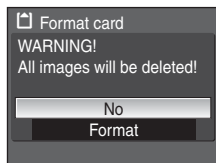

Formatting Internal Memory and Memory Cards

- Formatting the internal memory or memory cards permanently deletes all data. Be sure to transfer important pictures to a computer before formatting.
- Do not turn the camera off, disconnect the AC adapter, or open the battery-chamber/memory card slot cover during formatting.
- The first time you insert the memory cards used in other devices into the COOLPIX P5100, format them with this camera.

Download from Www.Somanuals.com. All Manuals Search And Download.

Language

Choose one of 23 languages for display of camera menus and messages.

Čeština	Czech
Dansk	Danish
Deutsch	German
English	(default setting)
Español	Spanish
Ελληνικά	Greek
Français	French
Indonesia	Indonesian
Italiano	Italian
Magyar	Hungarian
Nederlands	Dutch
Norsk	Norwegian

Polski	Polish
Português	Portuguese
Русский	Russian
Suomi	Finnish
Svenska	Swedish
Türkçe	Turkish
中文简体	Simplified Chinese
中文繁體	Traditional Chinese
日本語	Japanese
한국	Korean
ภาษาไทย	Thai

Video Mode

Adjust settings for connection to TV.

Choose [NTSC] or [PAL].

FUNC Button

Change the function performed by **Fn** in **P**, **S**, **A**, and **M** modes.

Press **Fn** to display the shooting menu option assigned to **Fn**. This option is applied using the [FUNC button] item.

Hold down **Fn** and rotate the command dial to select a function, and then the setting can be assigned simply by releasing **Fn**.

One of the following shooting menu options can be assigned to **Fn**.

ISO sensitivity (🔍 99) (default setting)	Image quality (🔍 91)	Image size (🔍 92)
White balance* (🔍 97)	AF area mode (🔍 105)	Continuous (🔍 101)
Distortion cntl (🔍 112)	Converter (🔍 110)	Vibration reduction (🔍 128)
User setting (🔍 111)		

* When [Preset manual] is selected, the screen shown in step 3 of the section, "Preset Manual" (🔍 98), will be displayed.

Reset All

When [Reset] is selected, the camera's settings will be restored to their default values.

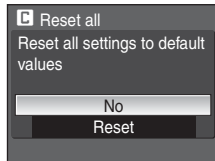

Pop-up Menu

Option	Default value
Flash mode (F 30)	Auto
Self-timer (F 32)	Off
Focus mode (F 33)	Autofocus
Exposure compensation (F 34)	0.0

Scene Mode

Option	Default value
Scene mode (F 35)	Portrait

Movie Menu

Option	Default value
Movie options (F 65)	TV movie 640★
Time-lapse movies (F 68)	30s
Auto-focus mode (F 67)	Single AF

Shooting Menu

Option	Default value
Image quality (F 91)	Normal
Image size (F 92)	 4000x3000
Optimize image (F 94)	Normal
Custom in Optimize image (F 95)	Contrast: Auto Image sharpening: Auto Saturation: Auto
Custom of Black-and-white in Optimize image (F 96)	Contrast: Auto Image sharpening: Auto Saturation: Auto
White balance (F 97)	Auto

Basic Camera Setup: The Setup Menu

Option	Default value
ISO sensitivity (📷 99)	Auto
Fixed range auto (📷 99)	ISO 64 - 100
Metering (📷 100)	Matrix
Continuous (📷 101)	Single
Interval timer photography (📷 103)	30s
Auto bracketing (📷 104)	Off
AF area mode (📷 105)	Auto
Auto-focus mode (📷 107)	Single AF
Flash exp. comp. (📷 108)	0
Flash control (📷 108)	Auto
Fixed aperture (📷 109)	Off
Noise reduction (📷 109)	Auto
Converter (📷 110)	None
Distortion control (📷 112)	Off

Setup Menu

Option	Default value
Menus (📷 121)	Text
Welcome screen (📷 122)	Disable welcome
Brightness (📷 126)	3
Date imprint (📷 126)	Off
Vibration reduction (📷 128)	On
AF assist (📷 129)	Auto
Digital zoom (📷 129)	On
Button sound (📷 130)	On
Shutter sound (📷 130)	On
Auto off (📷 130)	1m
FUNC button (📷 132)	ISO sensitivity

Others

Option	Default value
Paper size (M 83, 84)	Default
Slide show (M 117)	3s

- Choosing [Reset all] also clears the current file number (M 140) from the memory. Numbering will continue from the lowest number available.
- To reset file numbering to "0001", delete all pictures (M 118) before selecting [Reset all].
- The following settings in the menus will remain unaffected even if [Reset all] is performed.

Shooting menu: preset white balance value measured using [Preset manual] (M 98)

Setup menu: [Date] (M 123), [Date counter] (M 127), [Language] (M 132), and [Video mode] (M 132)

Ver. Firmware Version

View the current camera firmware version.

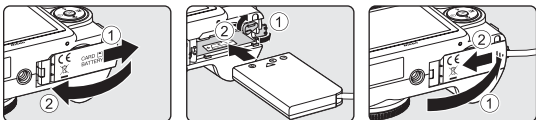

Optional Accessories

Rechargeable battery	Rechargeable Li-ion Battery EN-EL5
Battery charger	Battery Charger MH-61
AC adapter	<p>AC Adapter EH-62A (connects as shown)</p> <p>1 2 3</p>  <p>Ensure that the power connector cord passes through the opening before closing the battery-chamber/memory card slot cover. Failure to observe this precaution could cause damage to the battery-chamber/memory card slot cover.</p>
USB cable	USB Cable UC-E6
A/V cable	Audio/Video Cable EG-CP14
Converter lenses (require UR-E20 lens adapter ring)	<ul style="list-style-type: none"> • Wide-angle Converter WC-E67 (0.67×) • Telephoto Converter TC-E3ED (3×)
Lens adapter ring	Step-down Ring Adapter UR-E20
Speedlights	Speedlight SB-400, 600, 800

Converters and Adapter Rings

Do not attach lens hoods or filters to the converter lens or adapter ring, as they may cause shading around the edges of pictures shot with the COOLPIX P5100.

Download from www.Somanuals.com. All Manuals Search And Download.

Approved Memory Cards

The following memory cards have been tested and approved for use in the COOLPIX P5100.

SanDisk	128 MB, 256 MB, 512 MB, 1 GB, 2 GB ¹ , 4 GB ^{1,2} High-speed, 10-MB/s cards: 512 MB, 1 GB, 2 GB ¹ , 4 GB ^{1,2} High-speed, 20-MB/s cards: 1 GB, 2 GB ¹
Toshiba	128 MB, 256 MB, 512 MB, 1 GB, 2 GB ¹ , 4 GB ^{1,2} High-speed, 10-MB/s cards: 256 MB, 512 MB, 1 GB High-speed, 20-MB/s cards: 512 MB, 1 GB, 2 GB ¹
Panasonic	128 MB, 256 MB, 512 MB, 1 GB, 2 GB ¹ , 4 GB ^{1,2} High-speed, 10-MB/s cards: 4 GB ^{1,2} High-speed, 20-MB/s cards: 512 MB, 1 GB, 2 GB ¹ , 4 GB ^{1,2}

¹ If the memory card will be used with a card reader or similar device, the device must support memory card specifications.

²  SDHC-compliant.

Other cards have not been tested. For more details on the memory cards listed above, please contact the manufacturer.

Attaching Converter Lenses

Attach the Wide-angle Converter WC-E67 and Telephoto Converter TC-E3ED (available separately from Nikon) as described below (the illustrations show the WC-E67). See the converter instruction manual for details.

1 Remove the lens ring.

Turn the camera off and remove the lens ring as shown at right.

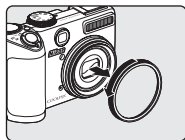

2 Remove the rear cap from the converter lens.

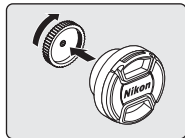

3 Attach the Step-down Ring Adapter UR-E20 and the converter (available separately from Nikon).

Attach the Step-down Ring Adapter UR-E20 to the camera lens ①.

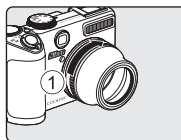

Then screw the converter lens into the Step-down Ring Adapter UR-E20 ②.

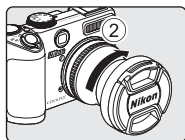

4 Choose a [Converter] option.

Rotate the mode dial to **P** (Programmed Auto), **S** (Shutter-Priority Auto), **A** (Aperture-Priority Auto), **M** (Manual), or **HI ISO** (High sensitivity) and select the appropriate converter type for the [Converter] option in the camera shooting menu (☑ 110).

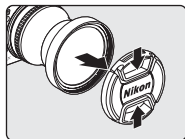

5 Remove the lens cap.

Remove the front cap from the converter lens.



Rotate the mode dial to **P**, **S**, **A**, **M**, or **HI ISO** when using converter lenses (available separately from Nikon). To remove the converter, turn the camera off and perform steps 1 to 4 in reverse order. Set the [Converter] option in the camera shooting menu (☑ 110) to [None] when no converter is attached.

Using Optional Speedlights

The camera is equipped with an accessory shoe with a safety lock, allowing Speedlights SB-400, SB-600, and SB-800 (available separately from Nikon) to be mounted directly on the camera without a sync cable. Use Speedlights for indirect lighting or when additional lighting is required. The built-in flash turns off automatically when using Speedlights. While  is displayed in the monitor, Speedlights flash mode is also displayed in the monitor, and it can be set with the same procedure as the built-in flash ( 30).

- Remove the accessory shoe cover before attaching a Speedlight. Slide the accessory shoe cover to the direction of an arrow to remove it.
- Refer to the Speedlight manual for more information on how to attach Speedlight and details.
- Replace the accessory shoe cover when the Speedlight is not in use.

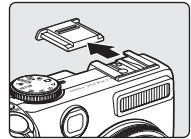

Speedlights SB-400, SB-600, and SB-800

- Speedlights SB-400, SB-600, and SB-800 are equipped with a safety lock so that it prevents Speedlight from coming off easily.
- When set to STBY (stand-by), the Speedlight will power on and off at the same time as the camera. Confirm the Ready-light is on with Speedlight unit.
- Before using Speedlights SB-600 or SB-800, set the Speedlight flash control mode to TTL for i-TTL flash control, which uses monitor pre-flashes to adjust flash output automatically in response to lighting conditions. Refer to the Speedlight manual for more information on i-TTL flash control.
- The camera does not support Advanced Wireless Lighting, Flash Color Information Communication, Auto FP High-Speed Sync, FV lock, or AF-assist for multi-area AF when using Speedlights SB-600 or SB-800.
- Power zoom can be used with Speedlights SB-600 and SB-800, setting illuminating angle automatically depending upon focal length.
- When using Speedlights SB-600 or SB-800, a wide panel may be needed to illuminate the edges of the picture at ranges under 2 m (6 ft. 7 in.) when the camera is zoomed out.

Image/Sound File and Folder Names

Pictures, movies, voice memos and voice recordings are assigned file names as follows.

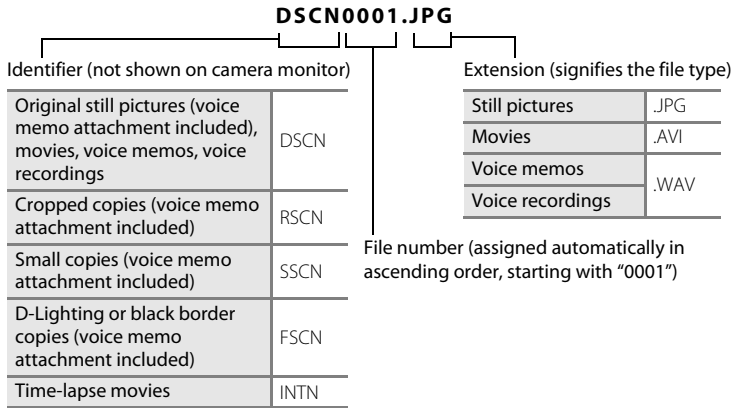

- Files are stored in folders named with a folder number followed by a five-character identifier: "P_" plus a three-digit sequence number for pictures shot using panorama assist (e.g. "101P_001"; 41), "INTVL" for interval timer photography (e.g. "101INTVL"; 103), "SOUND" for voice recordings (e.g. "101SOUND"; 71), and "NIKON" for all other pictures (e.g. "100NIKON"). When the number of files within a folder reaches 9999, a new folder will be created. File numbers will be assigned automatically starting with "0001."
- Files copied using [Copy] > [Selected images] or [Copy sound files] > [Selected files] are copied to the current folder, where they are assigned new file numbers in ascending order starting from the largest file number in memory. [Copy] > [All images] and [Copy sound files] > [Copy all files] copy all folders from the source medium; file names do not change but new folder numbers are assigned in ascending order, starting from the largest folder number on the destination medium (75, 119).
- A single folder can hold up to 200 pictures; if the current folder already contains 200 pictures, a new folder, named by adding one to the current folder name, will be created the next time a picture is shot. If the current folder is numbered 999 and contains 200 pictures, or a picture is numbered 9999, no further pictures can be shot until the internal memory or memory card is formatted (131), or a new memory card is inserted.

Caring for the Camera

To ensure continued enjoyment of this Nikon product, observe the following precautions when using or storing the device:

Keep Dry

The device will be damaged if immersed in water or subjected to high humidity.

Do Not Drop

The product may malfunction if subjected to strong shock or vibration.

Handle the Lens and all Moving Parts with Care

Do not apply force to the lens, lens cover, monitor, memory card slot or battery chamber. These parts are easily damaged. Applying force to the lens cover could result in camera malfunction or damage to the lens. Should the monitor break, care should be taken to avoid injury caused by broken glass and to prevent the liquid crystal from the display touching the skin or entering the eyes or mouth.

Do Not Point the Lens at Strong Light Sources for Extended Periods

Avoid pointing the lens at the sun or other strong light sources for extended periods when using or storing the camera. Intense light may cause deterioration of the CCD image sensor, producing a white blur effect in photographs.

Keep Away from Strong Magnetic Fields

Do not use or store this device in the vicinity of equipment that generates strong electromagnetic radiation or magnetic fields. Strong static charges or the magnetic fields produced by equipment such as radio transmitters could interfere with the monitor, damage data stored on the memory card, or affect the product's internal circuitry.

Avoid Sudden Changes in Temperature

Sudden changes in temperature, such as when entering or leaving a heated building on a cold day, can cause condensation to form inside the device. To prevent condensation, place the device in a carrying case or a plastic bag before exposing it to sudden changes in temperature.

Turn the Product Off Before Removing or Disconnecting the Power Source

Do not remove the battery while the product is on, or while images are being recorded or deleted. Forcibly cutting power in these circumstances could result in loss of data or in damage to product memory or internal circuitry.

The Self-timer Lamp/AF-assist Illuminator LED

The light-emitting diode (LED;  4, 32, 129) used in the self-timer lamp/AF-assist illuminator conforms to the following IEC standard:

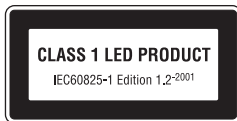

The Battery

- Check the battery level when taking the camera out, and charge the battery if necessary ( 14). Do not continue charging once the battery is fully charged, as this will result in reduced battery performance. If possible, carry a fully-charged spare battery when shooting pictures on important occasions.
- Do not use the battery at ambient temperatures below 0 °C (32 °F) or above 40 °C (104 °F). During charging, the temperature should be in the vicinity of 5 to 35 °C (41 to 95 °F). Note that the battery may become hot during use; wait for the battery to cool before charging. Failure to observe these precautions could damage the battery, impair its performance or prevent it from charging normally.
- On cold days, the capacity of batteries tends to decrease. Be sure that the battery is fully charged before heading outside to shoot in cold weather. Keep spare batteries in a warm place and exchange as necessary. Once warmed, a cold battery may recover some of its charge.
- Dirt on the battery terminals can prevent the camera from functioning.
- When the battery is not in use, remove it from the camera or battery charger and replace the terminal cover. The camera and battery charger draw minute amounts of current even when off; if left in place, the battery could be drained to the point that it no longer functions. Turning the camera on or off while the battery is exhausted can result in reduced battery life. If the battery will not be used for an extended period, store it in a cool (15 to 25 °C / 59 to 77 °F), dry place. Recharge it at least once a year and run it flat before returning it to storage.
- Replace the battery when it no longer holds a charge. Used batteries are a valuable resource. Please recycle used batteries in accordance with local regulations.

Cleaning

Lens/ viewfinder	Avoid touching glass parts with your fingers. Remove dust or lint with a blower (typically a small device with a rubber bulb attached to one end that is pumped to produce a stream of air out the other end). To remove fingerprints or other stains that cannot be removed with a blower, wipe the lens with a soft cloth, using a spiral motion that starts at the center of the lens and working toward the edges. If this fails, clean the lens using a cloth lightly dampened with commercial lens cleaner.
Monitor	Remove dust or lint with a blower. To remove fingerprints and other stains, clean the monitor with a soft, dry cloth, being careful not to apply pressure.
Body	Use a blower to remove dust, dirt or sand, then wipe gently with a soft, dry cloth. After using the camera at the beach or seaside, wipe off any sand or salt with a dry cloth lightly dampened with fresh water, then dry thoroughly. Note that foreign matter inside the camera could cause damage not covered by the warranty.

Do not use alcohol, thinner, or other volatile chemicals.

Storage

Turn the camera off when not in use. Check that the power-on lamp is off before putting the camera away. Remove the battery if the camera will not be used for an extended period. Do not store the camera with naphtha or camphor moth balls, or in any of the following locations:

- Next to equipment that produces strong electromagnetic fields, such as televisions or radios
- Exposed to temperatures below -10°C (14°F) or above 50°C (122°F)
- Poorly ventilated or subject to humidities of over 60 %

To prevent mold or mildew, take the camera out of storage at least once a month. Turn the camera on and release the shutter a few times before putting the camera away again.

Use Only Nikon Flash Accessories

Use only Nikon Speedlights. Negative voltages or voltages over 250 V applied to the accessory shoe could not only prevent normal operation, but damage the sync circuitry of the camera or flash. Before using a Nikon Speedlight not listed in this section, contact a Nikon-authorized service representative for more information.













Notes on the Monitor



- The monitor may contain a few pixels that are always lit or that do not light. This is a characteristic common to all TFT LCD displays, and does not indicate a malfunction. Images recorded using the product will not be affected.
- When framing bright subjects, vertical comet-like streaks that whiten toward either end may appear in the display. This phenomenon, known as “smear,” does not appear in the final photograph and does not indicate a malfunction. Some smear may appear in movies.
- Images in the monitor may be difficult to see under bright lighting.
- The monitor is lit by an LED backlight. Should the monitor begin to dim or flicker, contact your Nikon-authorized service representative.

Download from www.Somanuals.com. All Manuals Search And Download.











Error Messages















The following table lists the error messages and other warnings displayed in the monitor, as well as the solutions for dealing with them.

Display	Problem	Solution	
 (blinks)	Clock not set.	Set clock.	123
	Battery running low.	Prepare to charge or change battery.	14, 16
 Warning! Battery exhausted.	Battery exhausted.	Charge or change battery.	14, 16
 Warning!! Please wait for the camera to finish recording. 	Camera cannot perform other operations until recording is complete.	Wait until message clears from display automatically when recording is complete.	27
 Memory card is write protected.	Write-protect switch is in "lock" position.	Slide write-protect switch to "write" position.	21
 This card cannot be used.	Error accessing memory card.	<ul style="list-style-type: none"> • Use approved card. • Check that connectors are clean. • Confirm that memory card is correctly inserted. 	137
 Warning! This card cannot be read.			20
 Card is not formatted. Format card? No Yes	Memory card has not been formatted for use in camera.	Choose [Yes] and press  to format card, or turn camera off and replace card.	21
 Out of memory.	Memory card is full.	<ul style="list-style-type: none"> • Choose lower image quality or smaller image size. • Delete pictures or sound files. • Insert new memory card. • Remove memory card and use internal memory. 	91, 92 28, 70, 74, 118 20 21

Display	Problem	Solution	
i Image cannot be saved.	Error occurred while recording picture.	Format internal memory or memory card.	131
	Camera has run out of file numbers.	<ul style="list-style-type: none"> • Insert new memory card. • Format internal memory or memory card. 	20 131
	Picture cannot be used for welcome screen.	Choose picture of 640 × 480 pixels or larger, or picture shot at an image size setting other than  (3,984 × 2,656) and  (3,968 × 2,232).	56, 57, 92
	Cannot copy picture.	Delete pictures from destination.	118
i Sound file cannot be saved.	Camera has run out of file numbers.	<ul style="list-style-type: none"> • Insert new memory card. • Format internal memory or memory card. 	20 131
i Image can not be modified.	Pictures cannot be modified using the D-Lighting, crop, small picture, or black border functions.	<ul style="list-style-type: none"> • Editing functions, other than black border, may not be available for pictures of some original image sizes. 	54
		<ul style="list-style-type: none"> • Some editing functions are not available for pictures that have already been edited once. Confirm restrictions on editing using the D-Lighting, crop, small picture, and black border functions. • Movies cannot be edited. 	54 -
i Cannot record movie.	Time out error while recording movie.	Choose memory card with faster write speed.	137

Error Messages

Display	Problem	Solution	
 Memory contains no images.	<ul style="list-style-type: none"> No pictures or sound file in the internal memory or memory card. 	–	–
 No sound file.	<ul style="list-style-type: none"> Memory card does not contain pictures or sound file. 	To copy picture or sound file from internal memory to memory card, press MENU . The copy option screen or copy sound file screen will be displayed.	119, 75
 File contains no image data.	File not created with COOLPIX P5100.	View file on computer or other device.	–
 This file cannot be played back.			
 All images are hidden.	<ul style="list-style-type: none"> Date and time are not set for pictures to be displayed in calendar mode or list by date mode. All pictures in internal memory/memory card are hidden. 	– Disable [Hide image] setting to view images.	– 118
 This image cannot be deleted.	Picture is protected.	Disable protection.	118
 New city is in the current time zone.	Destination in same time zone as home.	–	125
 WARNING! Mode dial is not in the proper position.	Mode dial is between two modes.	Rotate mode dial to select desired mode.	8
Lens error 	Lens error.	Turn camera off and then on again. If error persists, contact retailer or Nikon-authorized service representative.	22

Display	Problem	Solution	
 Communications error	USB cable disconnected during transfer or printing.	If Nikon Transfer displays error, click [OK] to exit. Resume operation after turning camera off and reconnecting cable.	77, 82
System error 	Error has occurred in camera's internal circuitry.	Turn camera off, remove and reinsert battery, and turn camera on. If error persists, contact retailer or Nikon-authorized service representative.	16, 22
 Printer error. Check printer status.	Running out of ink or printer error.	Check printer. After checking the ink or solving the problem, select [Resume] and press  to resume printing*.	-
 Printer error: check paper	Specified size of paper is not loaded in printer.	Load the specified paper, select [Resume] and press  to resume printing*.	-
 Printer error: paper jam	Paper has jammed in the printer.	Eject the jammed paper, select [Resume] and press  to resume printing*.	-
 Printer error: out of paper	No paper is loaded in printer.	Load the specified paper, select [Resume] and press  to resume printing*.	-
 Printer error: check ink	Ink error.	Check ink, select [Resume] and press  to resume printing*.	-
 Printer error: out of ink	Ink cartridge is empty.	Replace ink, select [Resume] and press  to resume printing*.	-
 Printer error: file corrupt	An error caused by the image file has occurred.	Select [Cancel] and press  to cancel printing.	-





* See the documentation provided with your printer for further guidance and information.

Troubleshooting

If the camera fails to function as expected, check the list of common problems below before consulting your retailer or Nikon-authorized service representative. Refer to the page numbers in the right-most column for more information.

Display, Settings and Power Supply



Problem	Cause/Solution	
Monitor is blank.	<ul style="list-style-type: none"> • Camera is off. • Battery is exhausted. • Standby mode for saving power: press the shutter-release button halfway. • Monitor is off; press [O]. • When flash lamp blinks red, wait until flash has charged. • Camera and computer are connected via USB cable. • Camera and TV are connected via audio/video cable. • Time lapse or interval timer photography in progress. 	22 22 23, 26 12 31 77 76
Monitor is hard to read.	<ul style="list-style-type: none"> • Ambient lighting too bright: use viewfinder or move to darker location. • Adjust monitor brightness. • Monitor is dirty. Clean monitor. • Monitor has dimmed to save power. Monitor brightens when controls are used. 	24 126 143 23
Camera turns off without warning.	<ul style="list-style-type: none"> • Battery is low. • Camera has turned off automatically to save power. • Battery is cold. 	22 23 142
Date and time of recording are not correct.	<ul style="list-style-type: none"> • Pictures recorded before clock was set, and "Date not set" indicator blinks during shooting, will have time stamp of "00/00/0000 00:00"; movies and voice recordings will be dated "01/09/2007 00:00." • Check camera clock regularly against more accurate timepieces and reset as required. 	18 123
No indicators displayed in monitor.	Shooting data and photo information may be hidden. Press [O] until shooting data or photo information will be displayed.	12
[Date imprint] not available.	Camera clock has not been set.	18, 123

Problem	Cause/Solution	
Date not appearing on pictures even when [Date imprint] is enabled.	Date does not appear on movies, on pictures shot using  ([Sports]),  ([Museum]), or  ([Panorama assist]) in scene mode, when [Continuous], [Continuous flash], or [BSS] is selected for [Continuous], options other than [Off] is selected for [Auto bracketing] in shooting menu, or shooting in anti-shaking mode.	37, 39, 41, 43, 64, 101, 104
Camera settings reset.	Backup battery is exhausted; all settings were restored to their default values.	124











Electronically Controlled Cameras









In extremely rare instances, unusual characters may appear in the monitor and the camera may stop functioning. In most cases, this phenomenon is caused by a strong external static charge. Turn the camera off, remove and replace the battery, then turn the camera on again. In the event of continued malfunction, contact your retailer or Nikon-authorized service representative. Note that disconnecting the power source as described above may result in the loss of any data not recorded to internal memory or the memory card at the time the problem occurred. Data already recorded will not be affected.

Shooting





Problem	Cause/Solution	
Camera does not shoot when shutter-release button is pressed.	<ul style="list-style-type: none"> When camera is in playback mode, press  or the shutter-release button. When menus are displayed, press MENU. Battery is exhausted. When flash lamp blinks, flash is charging. 	28 11 22 31
Camera cannot focus.	<ul style="list-style-type: none"> The intended subject is one with which autofocus does not perform well. Set [AF assist] in the setup menu to [Auto]. AF lamp flickers: subject not in focus area when shutter-release button pressed halfway. Focus error. Turn camera off and then on again. 	27 129 26, 105 22

Troubleshooting

Problem	Cause/Solution	
Pictures are blurred.	<ul style="list-style-type: none"> • Use flash. • Use anti-shake mode. • Use high-sensitivity shooting mode. • Use vibration reduction. • Use BSS. • Use tripod and self-timer. • The [Converter] setting does not match the converter lens mounted on the camera. Be sure to check the [Converter] setting before shooting. 	30 43 44 128 101 32 110
Bright specks appear in pictures shot with flash.	Flash is reflecting off particles in air. Turn flash off.	30
Built-in flash does not fire.	<ul style="list-style-type: none"> • Flash is off. • Some scene modes that cannot turn on flash are selected. •  of focus mode is applied. • Anti-shake mode is applied. •  modes other than [Time-lapse movie ] is selected. • [Continuous], [BSS], or [Multi-shot 16] is selected for [Continuous]. • Option other than [Off] is selected for [Auto bracketing] in shooting menu. • Option other than [None] is selected for [Converter] in shooting menu. • [Built-in off] is selected for [Flash control] in shooting menu. • Speedlight (available separately from Nikon) is used. 	30 35 33 43 64 101 104 110 108 139
Optical zoom cannot be used.	Optical zoom cannot be used while recording movies.	64
Digital zoom cannot be used.	Digital zoom is not available when shooting in the  Portrait scene mode or  Night portrait scene mode, before movie recording begins, when [Continuous] is set to [Multi-shot 16], or when [Digital zoom] in the setup menu is set to [Off].	36, 37, 64, 101, 129
[Image size] not available.	<ul style="list-style-type: none"> • [Image size] cannot be adjusted when [Multi-shot 16] is selected for [Continuous]. • When [ISO sensitivity] is set to [3200],  4,000 × 3,000],  3,264 × 2,448],  3,984 × 2,656],  3,968 × 2,232], or  2,992 × 2,992] cannot be selected for [Image size]. 	101 99

Problem	Cause/Solution	
No sound when shutter is released.	• [Off] is selected for [Sound settings] > [Shutter sound] in setup menu.	130
	• [Continuous], [BSS], [Continuous flash], or [Multi-shot 16] is selected for [Continuous] in shooting menu.	101
	• Option other than [Off] is selected for [Auto bracketing] in shooting menu.	104
	•  ([Sports] scene mode) or  ([Museum] scene mode) is selected.	37, 39
	• Anti-shake mode or  mode is selected.	43, 64
AF-assist illuminator does not light.	• [Off] is selected for AF assist option in camera setup menu.	129
	• AF-assist illuminator turns off automatically in some modes.	36-41
Pictures appear smeared.	Lens is dirty. Clean lens.	143
Colors are unnatural.	White balance setting is not appropriate for light source.	97
Randomly spaced bright pixels ("noise") appear in image.	Shutter speed too slow. Noise can be reduced by:	
	• Using flash	30
	• Specifying a lower ISO sensitivity setting	99
	• Applying [Noise reduction] in the shooting menu to suit situations.	109
	• Choosing scene mode with noise reduction	37
Pictures are too dark (underexposed).	• Flash is off.	30
	• Flash window is blocked.	24
	• Subject is beyond flash range.	30
	• Adjust exposure compensation.	34
	• Apply high-sensitivity shooting mode, or raise the ISO sensitivity.	44, 99
	• Subject is backlit. Select  ([Backlight] scene mode) or use fill flash.	30, 40
Pictures are too bright (overexposed).	Adjust exposure compensation.	34
Unexpected results when flash set to  (auto with red-eye reduction).	When  or "fill flash with slow sync and red-eye reduction" of the [Night portrait] scene mode is applied during shooting, In-Camera Red-Eye Fix may, in very rare cases, be applied to areas not affected by red-eye. Set a flash mode other than  when in a shooting mode other than the [Night portrait] scene mode during shooting.	30, 37
Camera does not shoot continuously.	[On] is selected for [Noise reduction] in the shooting menu.	109

Playback

Problem	Cause/Solution	
File cannot be played back.	<ul style="list-style-type: none"> File was overwritten or renamed by computer or other make of camera. Time-lapse or interval timer photography in progress: pictures cannot be played back until recording is complete. 	–
Cannot zoom in on picture.	Playback zoom cannot be used with movies, small pictures, or pictures that have been cropped to below 320 × 240.	–
Cannot record voice memo.	<ul style="list-style-type: none"> Voice memos cannot be appended to movies. Voice memos cannot be appended to pictures shot by other cameras, and voice memos recorded by other cameras cannot be played back. 	70 59
Cannot use D-Lighting, crop, small picture, or black border options.	<ul style="list-style-type: none"> These options cannot be used with movies. The options other than black border cannot be used with pictures shot when  (3,984 × 2,448),  (3,968 × 2,232), or  (2,992 × 2,992) is applied in the image size setting. Select picture that supports crop, D-Lighting, small picture, or black border. Pictures shot with other cameras cannot be edited. Other cameras may be unable to play back pictures edited with this camera. 	70 92 54 – –
Pictures not displayed on television.	<ul style="list-style-type: none"> Choose correct video mode. Memory card contains no pictures. Replace memory card. Remove memory card to play back pictures from internal memory. 	132 20
Nikon Transfer does not start when camera is connected.	<ul style="list-style-type: none"> Camera is off. Battery is exhausted. USB cable is not correctly connected. Camera is not recognized by the computer. Computer is not set to launch Nikon Transfer automatically. If your computer is running Windows 2000 Professional, camera cannot be connected to the computer. <p>See the help information contained in Nikon Transfer.</p>	22 22 78 – – 79

Problem	Cause/Solution	
Pictures to be printed are not displayed.	Memory card contains no pictures. Replace memory card. Remove memory card to print pictures from internal memory.	20
Cannot select paper size with camera.	Paper size cannot be selected from the camera if the printer does not support the page sizes used by the camera, or the printer automatically selects the page size. Use the printer to select page size.	83, 84

Specifications

Nikon COOLPIX P5100 Digital Camera

Type	Compact digital camera
Effective pixels	12.1 million
Image sensor	1/1.72-in. CCD; total pixels: approx. 12.43 million
Lens	3.5× Zoom-Nikkor lens
Focal length	7.5-26.3 mm (equivalent with 35mm [135] format picture angle: 35-123 mm)
f/-number	f/2.7-5.3
Construction	7 elements in 6 groups
Digital zoom	Up to 4× (equivalent with 35mm [135] format picture angle: approx. 492 mm)
Vibration reduction	Lens shift
Autofocus (AF)	Contrast-detect AF, Multi area AF
Focus range (from lens)	<ul style="list-style-type: none">• 30 cm (1 ft.) to ∞ (W); 70 cm (2 ft. 4 in.) to ∞ (T)• Macro close-up mode: 4 cm (1.6 in.) (wide-angle zoom position) to ∞
Focus-area selection	Face priority, auto (9-area automatic selection), center, manual with 99 focus areas
AF-assist illumination	Class 1 LED product (IEC 60825-1 Edition 1.2 ⁻²⁰⁰¹); max. output: 1,500 μW
Viewfinder	Real-image optical viewfinder with LED indication
Frame coverage	Approx. 80 % vertical and 80 % horizontal
Monitor	2.5 in., 230,000-dot, wide viewing angle TFT LCD with anti-reflection coating and 5-level brightness adjustment
Frame coverage (shooting mode)	Approx. 97 % horizontal and 97 % vertical
Frame coverage (playback mode)	Approx. 100 % horizontal and 100 % vertical
Storage	
Media	<ul style="list-style-type: none">• Internal memory (approx. 52 MB)• SD (Secure Digital) memory cards
File system	DCF, Exif 2.2, and DPOF compliant
File formats	Compressed: JPEG-baseline compliant FINE (1:4), NORMAL (1:8), BASIC (1:16) Movies: AVI Sound files: WAV
Image size (pixels)	<ul style="list-style-type: none">• 4,000 × 3,000 [12 M]• 2,592 × 1,944 [5 M]• 1,600 × 1,200 [2 M]• 1,024 × 768 [PC]• 3,984 × 2,656 [3:2]• 2,992 × 2,992 [1:1]• 3,264 × 2,448 [8 M]• 2,048 × 1,536 [3 M]• 1,280 × 960 [1 M]• 640 × 480 [TV]• 3,968 × 2,232 [16:9]

ISO sensitivity (Standard output sensitivity)	ISO 64, 100, 200, 400, 800, 1600, 2000, 3200, Auto (auto gain from ISO 64 to 800), Fixed range auto (100, 200, 400)
Exposure	
Metering	256-segment matrix, center-weighted spot, spot AF area (with support for 99 focus areas)
Exposure control	Programmed auto exposure with flexible program, shutter-priority auto, aperture-priority auto, manual, exposure compensation (-2.0 to +2.0 EV in steps of 1/3 EV), auto bracketing
Range (ISO 100)	[W]: -1.0 to +17.5 EV [T]: +0.9 to +16.4 EV
Shutter	Mechanical and charge-coupled electronic shutter
Speed	1/2000-8 s
Aperture	6-blade iris diaphragm
Range	10 steps of 1/3 EV
Self-timer	Can be selected from 10 and 3 second duration
Built-in flash	
Range (approx.) (ISO sensitivity: [Auto])	[W]: 0.3 to 8 m (1 ft. to 26 ft. 2.9 in.) [T]: 0.3 to 4 m (1 ft. to 13 ft. 1.5 in.)
Flash control	Sensor flash system
Accessory shoe	ISO 518 hot-shoe contact with safety lock
Sync contact	X-contact only
Interface	USB
Date transfer protocol	MTP, PTP
Video output	Can be selected from NTSC and PAL
I/O terminal	Audio/video out; digital I/O (USB)
Supported languages	Chinese (Simplified and Traditional), Czech, Danish, Dutch, English, Finnish, French, German, Greek, Hungarian, Indonesian, Italian, Japanese, Korean, Norwegian, Polish, Portuguese, Russian, Spanish, Swedish, Thai, Turkish
Power sources	<ul style="list-style-type: none"> • One Rechargeable Li-ion Battery EN-EL5 (supplied) • AC Adapter EH-62A (available separately from Nikon)
Battery life*	Approx. 240 shots (EN-EL5)
Dimensions (W × H × D)	Approx. 98 × 64.5 × 41 mm (3.8 × 2.5 × 1.6 in.) (excluding projections)
Weight	Approx. 200 g (7 oz) (without battery and SD memory card)
Operating environment	
Temperature	0 to 40 °C (32 to 104 °F)
Humidity	Less than 85 % (no condensation)

* Based on Camera and Imaging Products Association (CIPA) standards for measuring the life of camera batteries. Measured at 23 °C (73 °F); zoom adjusted with each shot, flash fired with every other shot, image quality set to [Normal], image size set to [4000×3000]. Battery life may vary depending on shooting interval and length of time menus and images are displayed.

- Unless otherwise stated, all figures are for a camera with a fully-charged Rechargeable Li-ion Battery EN-EL5 operated at an ambient temperature of 25 °C (77 °F).

Download from www.Somanuals.com. All Manuals Search And Download.

Rechargeable Li-ion Battery EN-EL5

Type	Rechargeable lithium-ion battery
Rated capacity	3.7 V, 1,100 mAh
Operating temperature	0 to 40 °C (32 to 104 °F)
Dimensions (W × H × D)	Approx. 36 × 54 × 8 mm (1.4 × 2.1 × 0.3 in.) (excluding projections)
Weight	Approx. 30 g (1.1 oz) (excluding terminal cover)

Battery Charger MH-61

Rated input	100-240V AC, 50/60 Hz, 0.12 to 0.08 A
Rated capacity	11 to 16 VA
Rated output	DC 4.2V, 950 mA
Supported battery	Rechargeable Li-ion Battery EN-EL5 (supplied)
Charging time	Approximately 2 hours when battery is fully discharged
Operating temperature	0 to 40 °C (32 to 104 °F)
Dimensions (W × H × D)	Approx. 67 × 26 × 67 mm (2.6 × 1.0 × 2.6 in.) (excluding projections)
Weight	Approx. 70 g (2.5 oz) (excluding power cable)

✓ Specifications

Nikon will not be held liable for any errors this manual may contain. The appearance of this product and its specifications are subject to change without notice.

Download from Www.Somanuals.com. All Manuals Search And Download.

Supported Standards

- **DCF:** Design Rule for Camera File System is a standard widely used in the digital camera industry to ensure compatibility among different makes of camera.
- **DPOF:** Digital Print Order Format is an industry-wide standard that allows pictures to be printed from print orders stored on the memory card.
- **Exif version 2.2:** This camera supports Exif (Exchangeable Image File Format for Digital Still Cameras) version 2.2, a standard that allows information stored with photographs to be used for optimal color reproduction when images are output from Exif-compliant printers.
- **PictBridge:** A standard developed cooperatively by the digital camera and printer industries, allowing photographs to be output directly to a printer without connecting the camera to a computer.

Index

Symbols

 Anti-shake mode 43

A (aperture-priority auto) 45, 48

 (apply selection) button 5

 Audio playback mode 73

 Auto mode 22–29

 Calendar mode 60

 (delete) button 9, 28

 (D-Lighting) 55

 (exposure compensation) 34

Fn (FUNC) button 5, 9

 Help 4, 11

 High-sensitivity shooting mode 44

 List by date mode 61

M (manual) 45, 49

MENU button 9

 (monitor) button 5, 12

 Movie mode 9, 64, 65

 (playback) button 5, 28

 Playback zoom 53, 56

P (programmed auto) 45, 46

 Scene mode 9, 35

S (shutter-priority auto) 45, 47

T (tele) 25

 Thumbnail playback 51, 56

 Vibration reduction 23, 128

 Voice recording mode 71, 121

W (wide) 25

 Wait icon 27, 144

A

Accessories 136

AE-L 42

AF area mode 105

AF assist 129

AF-assist illuminator 4, 27, 129

Anti-shake mode 43

Aperture-priority auto 45, 48

Audio/video cable 76

Auto bracketing 104

Auto focus (AF) lamp 5, 26

Auto off 130

Autofocus 33

Auto-focus mode 67, 107

AVI 140

AV-out connect 76

B

Backlight  40

Backlit subjects 30, 40

Battery 14

Battery charger 136

Battery level indicator 144

Battery-chamber/memory card slot cover 5

Beach/snow  38

Best shot selector 39, 101

Black Border 58

Blur 150

C

Cable connector 4, 82

Cleaning

Body 143

Lens 143

Monitor 143

Close up  39

Close-up 33, 39

Color options 113, 114

Command dial 4

Computer 76–78, 132

copying pictures to 76–78

Continuous 101

Continuous flash 101

Converter 110, 138

Copy 119

Copy  40

Crop 56

D

Date 18–19, 123, 126

printing 88

Date counter 127

Date imprint 126

Daylight saving time 123, 124

DCF 157

Delete 28, 29, 118

button 74

Design rule for camera file system 157

Digital print order format 87–88, 157
 Digital zoom 129
 Distortion control 112
 D-Lighting 55
 DPOF 157
 DSCN 140
 Dusk/dawn (🌅) 38

E

Error messages 144–147
 Exif version 2.2 157
 Exposure compensation 34
 Extension 140

F

File names 140
 Fill flash 30
 Fireworks show (🎆) 40
 Firmware version 135
 Fixed aperture 109
 Flash 30, 133
 lamp 5, 31
 mode 30
 Flash control 108
 Flash exp. comp. 108
 Flash mode 112
 Focus 6, 26, 33, 107
 area 6, 26
 Folder names 140
 Format 21, 131
 Framing 24
 FSCN 140
 Full-time AF 67, 107
 FUNC button 132

H

Help 11
 Hide image 118
 High-sensitivity shooting mode 44

I

Image quality 91
 Image size 92
 Infinity 33

Internal memory 6–7, 20, 93, 131
 capacity 93
 formatting 131
 ISO sensitivity 99

J

JPEG 154
 JPG 140



L

Landscape (🏞️) 36
 Language 18, 132
 Lens 4, 143

M

Macro close-up 33
 Manual 45, 49
 Memory card 6–7, 20, 93, 137
 approved 137
 capacity of 93
 formatting 131
 Inserting and removing 20
 slot 20
 Menus 121
 Metering 100
 Microphone 4
 Mode dial 4, 8
 Monitor 5, 6–7, 22, 143
 brightness 126
 indicators in 6–7
 Movie menu 65
 Movie mode 64
 Movie options 65
 maximum movie length 66
 small size 65, 66
 smaller size 65
 Time-lapse movie 65
 TV movie 65
 Movies 64, 70
 deleting 70
 playback 70
 recording 64
 Multi connector 5
 Multi selector 5, 10
 Museum (🏛️) 39



N

- Night landscape  39
- Night portrait  37
- Noise reduction 109

O

- Optimize image 94

P

- Panorama 41–42
- Panorama assist  41
- Party/indoor  37
- PictBridge 81–87, 157
- Playback 28, 51–57
 - full-frame 28, 29
 - menu 115–119
 - mode 9, 28, 29
 - thumbnail 51
 - zoom 53
- Playback menu 115–119
- Portrait  36
- Power switch 4, 17
- Power-on lamp 4, 17, 22
- Preset manual (white balance) 98
- Print set 87
- Print size 93
- Programmed auto 45, 46
- Protect 118

R

- Rear-curtain sync 30
- Red-eye reduction 31
- Reset all 133
- Reset user setting 112
- RSCN 140

S

- Scene mode 9, 35
- Self-timer 32, 112
- Self-timer lamp 4, 32
- Setup menu 120–135
- Shooting menu 89–114
- Shooting Pictures for a Panorama  41
- Shutter-priority auto 45, 47
- Shutter-release button 4

- Single AF 67, 107
- Slide show 117
- Small picture 57
- Smear 143
- Sound settings 130
- Speaker 5
- Speedlights 139
- Sports  37
- SSCN 140
- Strap, Camera 13
- Sunset  38
- Support information 2

T

- Tele 4, 25
- Telephoto converter 110
- Television 76
 - connecting to 76
- Thumbnail playback 51, 52
- Thumbnail wheel playback 52
- Time zone 18–19, 123, 125
- Transfer 78
- Tripod 5

U

- USB cable 77, 82
- User setting 111

V

- Vibration reduction 128
- Video mode 132
- Viewfinder 4, 5, 24
- Voice memo 59
 - deleting 59, 74
 - playing 59
 - recording 59
- Voice recordings
 - Copying 75
 - making 71
 - Playing 73
- Volume 70, 74

W

- WAV 140
- Welcome screen 120

White balance 97

Wide 4, 25

Wide-angle converter 110

Z

Zoom 25

 indicator 6

 playback 53

Zoom control 4, 25, 33, 70, 73, 83

Nikon

No reproduction in any form of this manual, in whole or in part (except for brief quotation in critical articles or reviews), may be made without written authorization from NIKON CORPORATION.



NIKON CORPORATION

Fuji Bldg., 2-3 Marunouchi 3-chome,
Chiyoda-ku, Tokyo 100-8331, Japan

Printed in Japan
YP7G01000101(11)
6MA30611--

Free Manuals Download Website

<http://myh66.com>

<http://usermanuals.us>

<http://www.somanuals.com>

<http://www.4manuals.cc>

<http://www.manual-lib.com>

<http://www.404manual.com>

<http://www.luxmanual.com>

<http://aubethermostatmanual.com>

Golf course search by state

<http://golfingnear.com>

Email search by domain

<http://emailbydomain.com>

Auto manuals search

<http://auto.somanuals.com>

TV manuals search

<http://tv.somanuals.com>