Meridian 1

Option 11C and 11C Mini

Technical Reference Guide

Document Number: 553-3011-100
Document Release: Standard 14.00
Date: January 2002

Copyright © 1991–2002 Nortel Networks
All Rights Reserved

Printed in Canada

Information is subject to change without notice. Nortel Networks reserves the right to make changes in design or components as progress in engineering and manufacturing may warrant. This equipment has been tested and found to comply with the limits for a Class A digital device pursuant to Part 15 of the FCC rules, and the radio interference regulations of Industry Canada. These limits are designed to provide reasonable protection against harmful interference when the equipment is operated in a commercial environment. This equipment generates, uses and can radiate radio frequency energy, and if not installed and used in accordance with the instruction manual, may cause harmful interference to radio communications. Operation of this equipment in a residential area is likely to cause harmful interference in which case the user will be required to correct the interference at their own expense.

SL-1 and Meridian 1 are trademarks of Nortel Networks.

Revision history

January 2002

Standard 14.00. This is a global document and is up-issued for Release 25.40.

December 2000

Standard 13.00. This global document is up-issued to include updates and changes required for Option 11C IP Expansion with Release 25.3x software.

April 2000

Standard 12.00. This is a global document and is up-issued for X11 Release 25.0x. Document changes include removal of: redundant content; references to equipment types except Options 11C and 11C Mini; and references to previous software releases.

September 1999

Issue 11.00, Standard

July 1999

Issue 10.00, Standard

May 1999

Issue 9.00, Standard

March 1998

Issue 8.00, Standard

July 1996

Release 7.00, Standard

July 1995

Release 6.00, Standard.

December 1994

Release 5.00, Standard.

July 1994

Release 4.00, Standard.

October 1993

Release 3.00, Standard.

January 1993

Release 2.00, Issue 2.0, Standard.

April 1992

Release 2.00, Issue 1.0, Standard.

June 1991

Release 1.00, Standard.

Contents

About this guide	9
Chapter 1 — Memory, Storage and CPU capacity	11
Chapter 2 — Provisioning	87
Chapter 3 — Transmission parameters	157
Chapter 4 — Cabinet distribution over a data network	177
Chapter 5 — Spares planning	187
Chapter 6 — Power supplies	197
Chapter 7 — System Controller cards	207
Chapter 8 — SDI ports	227
Chapter 9 — The TDS/DTR card	243
Chapter 10 — NTBK22 MISP card	261
Chapter 11 — Meridian Digital Telephones	265
Chapter 12 — M2317 Telephone	271
Chapter 13 — Meridian Modular Telephones	283

Chapter 14 — M3900 telephone series	309
Chapter 15 — European Digital telephones: 3110, 3310, and 3820	319
Chapter 16 — M5317 BRI Terminal	335
Chapter 17 — M2250 Attendant Console	353
Chapter 18 — NT8D02 and NTDK16 Digital Line Cards	365
Chapter 19 — NT8D09 Analog Message Waiting Line Card	371
Chapter 20 — NT8D14 Universal Trunk Card	377
Chapter 21 — NT8D15 E&M Trunk Card	389
Chapter 22 — NT5K21 XMFC/MFE card	399
Chapter 23 — NTAG26 XMFR card	409
Chapter 24 — NT6D70 SILC line card	415
Chapter 25 — NT6D71 UILC line card	419
Chapter 26 — NT1R20 Off Premise Station (OPS) analog line card	423
Chapter 27 — Cable specifications and interfaces	439
Chapter 28 — NTAK09 1.5 Mb DTI/PRI card	447
Chapter 29 — NTRB21 DTI/PRI/DCH TMDI card	455
Chapter 30 — NTAK10 2.0 Mb DTI card	467

Chapter 31 — NTAk79 2.0 Mb PRI card 479

Chapter 32 — NTBk50 2.0 Mb PRI card 493

Chapter 33 — NTAk20 clock controller 503

**Chapter 34 — NTAk93 D-channel handler
interface 513**

**Chapter 35 — NTBk51 Downloadable
D-channel handler 519**

Chapter 36 — NT5D14 Line Side T-1 card 525

List of terms 531

Index 537

About this guide

This Technical Reference guide contains detailed technical information about the Option 11C and Option 11C Mini systems. It includes such things as:

- circuit cards information
- spares planning
- SDI ports information
- tones and cadences
- transmission parameters
- Meridian modular telephone sets
- M2250 attendant console

This document is a global document. Contact your system supplier or your Nortel Networks representative to verify that the hardware and software described is supported in your area.

Chapter 1 — Memory, Storage and CPU capacity

Contents

This section contains information on the following topics:

Reference List	12
Overview	12
Option 11C and Option 11C Mini data storage, loading, and restoring ..	12
Data storage	14
Data loading	16
Data restoring	18
Pre-programmed data	18
Components of pre-programmed data	19
Model telephones	19
Trunk route data and model trunks	20
Numbering plan	20
SDI ports	21
Tone services	21
Benefits of pre-programmed data	21
Software Installation program and pre-programmed data	22
Removing pre-programmed data	23
Customer Configuration Backup and Restore	23
Operations performed	23
File transfer time	24

Equipment requirements	24
Real time CPU capacity	25
Software Program store	28
Resident Program store	28
Data store requirements	30
Unprotected data requirements	30
Notes to Table 11	34
Protected data requirements	48
Notes for Table 12	53

Reference List

The following are the references in this section:

- *Maintenance (553-3001-511)*
- *Option 11C Customer Controlled Backup and Restore (CCBR) (553-3011-330)*
- *Option 11C Mini Planning and Installation (553-3021-209)*
- *Option 11C Planning and Installation (553-3021-210)*
- *Option 11C and 11C Mini Upgrade Procedures (553-3021-250)*

Overview

This chapter presents an outline of Real Time CPU capacity for the Option 11C, and Option 11C Mini. In addition, it describes Option 11C and Option 11C Mini data storage, loading and restoring, as well as the unprotected and protected memory requirements for features applicable to the these systems.

Option 11C and Option 11C Mini data storage, loading, and restoring

For the Option 11C and Option 11C Mini system, configuration data is both stored and loaded by accessing overlay programs 43 and 143. The sequence of events where data is copied from one area to the next depends on the status of the switch - new installation, software upgrade - and the purpose of the data transfer, such as to make a backup copy of the customer database.

An Option 11C with IP Expansion can be made up of both Option 11C cabinets and Option 11C Mini chassis. However, when an Option 11C Mini chassis is used, the NTDK97 Mini System Controller (MSC) card is replaced with an NTDK20 Small System Controller (SSC) card and an appropriate IP Expansion daughterboard.

Option 11C and Option 11C Mini software is stored in various areas of the NTDK20 SSC and NTDK97 MSC cards. In terms of customer data, there are four possible areas where these records can be stored (Refer to Figure 1):

- DRAM — stores and accesses the active version of customer records, system data and overlay data
- Primary Flash drive c: — contains two copies of customer records (primary and backup records)
- Backup Flash drive z: — retains the true backup copy of the customer database
- PCMCIA device a: or b: — if equipped, this 40 Mbyte device can store a complete backup copy of the customer database

Data storage

The Option 11C and 11C Mini data dump performed in LD 43, is the system's method of backing up configuration data to its file storage devices. By invoking one of the several data dump commands in the overlay, the user is ensured that at least one backup copy of configuration data exists in a location other than DRAM (Refer to Table 1).

Table 1
LD 43 data dump commands

Command	Description
BKO	Customer records in the Primary Flash drive are copied to the PCMCIA device.
EDD	Customer data in DRAM is written to the Primary and Backup flash drives on the NTDK20 SSC and NTDK97 MSC.
EDD NBK	Customer data in DRAM is written to the Primary and Backup flash drives on the NTDK20 SSC and NTDK97 MSC. (Same as the EDD command).
SWP	A swap or exchange of database records is completed between the Primary Flash drive's main and secondary databases (Refer to Figure 1).

The effects of the LD 43 commands described above are better illustrated by referring to Figure 1.

Note: Refer to the Option *Maintenance* (553-3001-511) for a complete listing and description of LD 43 commands.

Figure 1
Data storage on the NTDK20 SSC and NTDK97 MSC

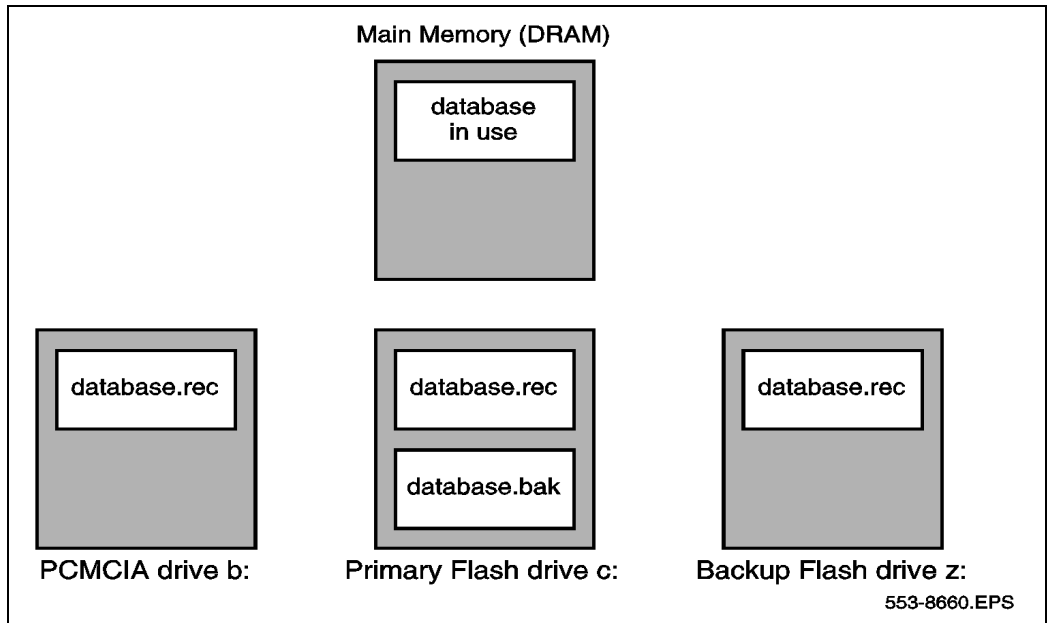

The Option 11C and Option 11C Mini offer one additional area of data storage that is truly external to the switch. This storage device can be an IBM-type PC or Macintosh-type computer, running an Option 11C software feature called "Customer Configuration Backup and Restore" (CCBR). Through the use of LD 143 and the CCBR feature, the user can transfer customer records between the SSC or MSC's Primary Flash drive to either an on-site or remote-computer system (Refer to Table 2 for a listing of CCBR commands supported in LD 143).

Table 2
LD 143 CCBR commands

Command	Description
XBK	Customer database records in the Primary Flash drive are backed up to an external computer hard-drive.
XRT	Customer database records are restored from an external computer hard-drive to the Backup Flash drive and on the NTDK20 SSC and NTDK97 MSC.
XSL	The Option 11C or Option 11C Mini is remotely “sysloaded” with customer records stored in the Primary Flash drive.
XVR	Customer files stored on an external computer are verified for validity and integrity with records in the Backup Flash drive.

Note: Refer to *Administration* (553-3001-311) and *Maintenance* (553-3001-511) for a complete listing and description of LD 143 commands.

Data loading

An Option 11C and 11C Mini “SYSLOAD” is a sequence of events whereby the switch loads and verifies system and customer records into the NTDK20 SSC’s or NTDK97 MSC’s active memory area, or DRAM. The flow of data depends on the status of the software - new installation, software release upgrade, or a user-initiated sysload - or the commands initiated in either LD 143, or the Install Setup Program.

Despite the various ways to initiate a Sysload, the flow of data generally follows the path described below (Refer to Figure 2 for a graphical illustration):

- 1 The Option 11C and 11C Mini searches for customer records in the Primary Flash drive. If the files are located and verified, data is loaded into the NTDK20 SSC’s or NTDK97 MSC’s DRAM.
- 2 If the records are corrupt or cannot be found in the Primary Flash drive, the system searches the Backup Flash drive. If the customer records are located and verified, the Option 11C and 11C Mini loads the data into DRAM.

- 3 If the customer records cannot be located in the Backup Flash drive, the Option 11C and 11C Mini automatically searches the PCMCIA drive. If customer records are located and verified, data is loaded into DRAM.
- 4 If the customer records cannot be located in the PCMCIA drive, the Option 11C and 11C Mini searches the Primary Flash drive for the secondary backup (.bak) file. If the customer records are located and verified, data is loaded into DRAM.

Figure 2
Flow of data during an Option 11C or Option 11C Mini Sysload

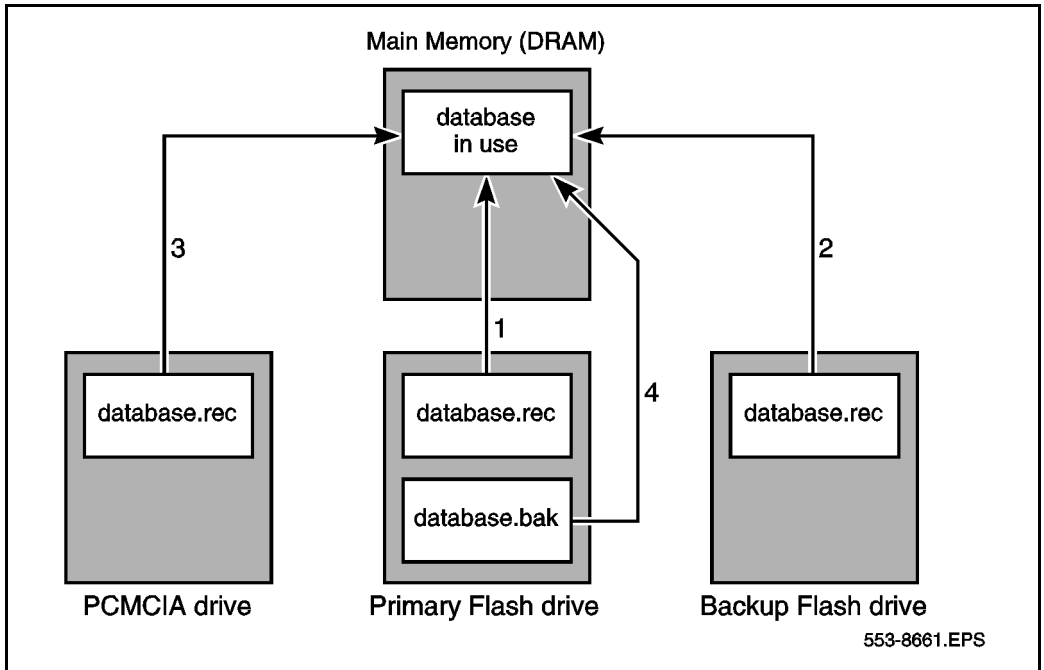

Sysload and a new Option 11C or Option 11C Mini installation

Software for new Option 11C and 11C Mini systems is delivered on a pre-programmed Software Daughterboard for the Option 11C, or directly on the MSC for the Option 11C Mini. Once this hardware is installed and the system is powered up (SYSLOAD), the Install Setup and Loader program (LD 143) is automatically invoked. This program is menu driven and assists in loading the software into the system.

Data restoring

In the unlikely event configuration data becomes corrupted, a backup copy of the current database can be restored to the Option 11C and 11C Mini. There are four possible areas of where a backup of configuration data can be restored from — the secondary primary database, the backup flash drive, the PCMCIA drive, or an external computer hard-drive. (Refer to Table 2 for a description of the commands used to restore backup data to the Option 11C and 11C Mini.)

Table 3
Commands used to restore data to the Option 11C and Option 11C Mini

Command	Overlay	Description
SWP (see note)	43	Secondary primary files are “swapped” with the contents of the primary flash drive (Refer to database.bak in Figure 2).
RES	43	Restore files to the primary flash drive from the PCMCIA drive.
RIB	43	Restores the missing files in primary flash drive from the internal backup drive.
XRT	143	Customer database records are restored from an external computer hard-drive to the Primary and Backup Flash drives on the NTDK20 SSC or NTDK97 MSC.

Note: The SWP command in LD 43 does not “restore” data to the primary flash drive: it swaps or replaces the contents of the primary drive with the data stored in the primary drive’s secondary database.

Pre-programmed data

When an Option 11C or Option 11C Mini system is initially installed, customer data must be entered into the overlay programs. Telephones, for example, must be assigned features on their keys to allow them to function properly.

However, the Main SSC or the Mini MSC can be pre-programmed with customer data. If you load pre-programmed data into the system during installation, some overlay entries will be automatically configured on the telephones. For example, you can choose a telephone model that has predetermined feature and key assignments and a preassigned class of

service. This can be a significant time-saver if you have to program numerous types of telephone models.

Pre-programmed data is not mandatory for software installation. In fact, the NTDK20 or the NTDK97, can be programmed with the minimum number of files to allow the Option 11C and 11C Mini to operate.

During start-up, the Software Installation Program is automatically invoked. The Option 11C or Option 11C Mini, loads system data from the NTDK20, or the NTDK97 respectively, and prompts the user for a variety of information, including the time and date, type of installation, feature set required, and type of database. At this point, if the user selects any response other than "Default database," pre-programmed data will not be loaded on the system.

Pre-programmed data cannot be removed from the Option 11C and 11C Mini system once it is loaded into the system. However, pre-programmed data can be bypassed during first-time system installations.

Note: The pre-programmed data on the Option 11C and 11C Mini system can provide an effective starting point for programming telephone and trunk information. Before bypassing the option of loading pre-programmed data, take the time to determine whether the default data can be used at this site.

Components of pre-programmed data

The following items are pre-programmed in the Default database on the Main Option 11C NTKK13 Software Daughterboard:

- Model telephones
- Trunk route data and model trunks
- Numbering plan
- SDI ports
- Tone and digit switch

Model telephones

A model telephone can be thought of as a default set of features and class of service assigned to a telephone.

Telephone models simplify telephone installation. During telephone activation, the telephone prompts you to accept a default model. If a model is chosen, all keys are automatically assigned a feature and no further key programming is required. (The extension number is also predefined using the default numbering plan.)

If you do not want to accept the default model, you can create other models by following the procedures in Chapter 19 of the *Option 11C Planning and Installation* (553-3021-210), or Chapter 17 of the *Option 11C Mini Planning and Installation* (553-3021-209).

Note: Off-Premise Station (OPS) telephones do not have their own telephone models. You can, however, create OPS models by entering DD in response to the CDEN prompt in LD 10.

Trunk route data and model trunks

Pre-programmed trunk routes and trunk models simplify trunk installation procedures. A pre-programmed trunk route supports a certain trunk type, has a default access code, and must be assigned a trunk model. A trunk model supports a certain card type, trunk type, and signalling arrangement.

Trunk models are assigned to default trunk routes using the administration telephone. You can create other models by following the procedures in Chapter 20 of the *Option 11C Planning and Installation* (553-3021-210) or Chapter 18 of the *Option 11C Mini Planning and Installation* (553-3021-209).

Numbering plan

The pre-programmed numbering plan automatically assigns default extension numbers to the following (this list may not be representative of all countries):

- Local extension numbers
- Attendant extension
- Night number
- ACD queues
- Meridian Mail extensions
- Call park extensions

If the default numbering plan does not suit this system's needs, you can change it using the procedures Chapter 22 of the *Option 11C Planning and Installation* (553-3021-210) or Appendix A of the *Option 11C Mini Planning and Installation* (553-3021-209).

SDI ports

There are three pre-programmed SDI ports on Option 11C and 11C Mini systems. The NTDK20 SSC or NTDK97 MSC provides TTY ports 0, 1, and 2. All three SDI interfaces can be used as either modem or maintenance ports for TTY terminals.

Tone services

The SSC/MSC provides 30 channels of tone and cadence transmission to the system.

The SSC/MSC also provides tone detection. Units 0-7 can be configured to support DTR/XTD. Units 8-15 can also be configured to support DTR/XTD

Optionally, units 8-11 can be configured to support other tone detection functions in lieu of DTR/XTD on units 8-15. These other tone functions include one of MFC/MFE/MFK5/MFK6/MFR.

LD 56 contains default tables used for tone and cadence generation.

Table 4
LD 56 tone and cadence data

Pre-configured TDS/DTR data	
TDS loop	Channels 1-30
DTR or XTD	Card 0, units 0-7

Benefits of pre-programmed data

The main benefit of pre-programmed data is that it simplifies installation and activation procedures. Table 5 compares how a task would be performed using pre-programmed data and how it would be performed without pre-programmed data.

Table 5
Benefits of pre-programmed data

Task	Task performed using pre-programmed data	Task performed without using pre-programmed data
Activating telephones	Plug telephone into socket, lift handset, choose model, choose extension	Enter LD 10 or 11, enter telephone type, specify TN, assign class of service, assign a feature to each key on telephone LD 10 has approximately 120 prompts LD 11 has approximately 160 prompts
Activating trunks	Use the administration menu to add a trunk: <ul style="list-style-type: none"> • enter a route access code • enter a TN • enter a trunk model 	Enter LD 16, enter trunk type, access code, signalling arrangements Enter LD 14, enter TN, route member number, signalling arrangements, class of service, and so on LD 16 has approximately 200 prompts LD 14 has approximately 50 prompts
Establishing a numbering plan	No effort required. Default extension numbers become active when telephones are activated. Default plan is sequential.	A numbering plan must be developed to map TNs to DNs.

Software Installation program and pre-programmed data

The Software Installation program is automatically invoked when the new Option 11C or Option 11C Mini is started up (SYSLOAD). After successfully responding to various prompts in the program, you are given the option of selecting a database to be loaded.

Detailed information about the Software Installation program can be found in the *Option 11C Planning and Installation (553-3021-210)* or the *Option 11C Mini Planning and Installation (553-3021-209)* used for first-time installations; or the *Option 11C and 11C Mini Upgrade Procedures (553-3021-250)* used for upgrades from an Option 11 or 11E to an Option 11C system.

Removing pre-programmed data

Pre-programmed data cannot be removed from the Option 11C or Option 11C Mini system once it is loaded into the system. However, pre-programmed data can be bypassed during first-time system installations.

During start-up, the Software Installation Program is automatically invoked. The Option 11C and 11C Mini then loads system data from the Software Daughterboard, or MSC for the Option 11C Mini, and prompts the user for a variety of information, including the time and date, type of installation, feature set required, and type of database. At this point, if the user selects any response other than "Default database," pre-programmed data will not be loaded on the system

Note: The pre-programmed data on the Option 11C and 11C Mini system can provide an effective starting point for programming telephone and trunk information. Before bypassing the option of loading pre-programmed data, take the time to determine whether the default data can be used at this site.

Customer Configuration Backup and Restore

The Customer Configuration Backup and Restore (CCBR) feature provides the ability to store the configuration database of the Option 11C on an external hard-drive of an IBM-type PC or Macintosh-type computer.

The CCBR feature can be invoked on-site with the use of a modem eliminator, or remotely over a modem connection.

Operations performed

The CCBR feature performs two different functions of safeguarding customer programmed data. The first involves storing the configuration database in the unlikely event of a system failure - such as a continuous SYSLOAD or INI - or data corruption. To correct this problem, the backup copy of the configuration database can be restored to the Option 11C or Option 11C Mini.

The second function of the CCBR feature has to do with the role it plays in upgrading software from an Option 11 or 11E to an Option 11C system. To illustrate, if the CCBR feature is invoked in LD 43 of an Option 11 or 11E, its configuration data can be backed up on a hard-drive of an external computer. When the new Option 11C hardware is fully installed, and the PCMCIA card is inserted in the System Core card, the backup copy of the configuration data - stored on the computer - can be transferred back to the upgraded Option 11C system as part of the software upgrade process. Immediately upon download, the Option 11 or 11E database files will be automatically converted to the Option 11C format.

Note: Whenever the CCBR feature is used, configuration data is always backed up to the primary flash drive. Prior to invoking the CCBR command, a data dump should be performed to ensure the primary database is current.

File transfer time

Depending on the number of records in the configuration data base, it can take over 30 minutes to backup or restore data at a rate of 1200 bps. CCBR access time can be significantly decreased using a 19200 baud modem: 19200 baud is the maximum data transfer rate supported by the Option 11C or Option 11C Mini.

Equipment requirements

Communications software

Communications software compatible with XModem CRC protocol is required to operate the CCBR feature. This requirement applies to on-site and remote access.

On-site access

On-site access to the Option 11C or Option 11C Mini system can be made by directly connecting a computer to SDI port 0, 1, or 2.

Note: You will need to connect a modem eliminator between the SDI cable and the computer cable for on-site computer access.

Remote access

Remote access to the Option 11C or Option 11C Mini is established by connecting SDI port 0, 1, or 2 on the SSC/MSC to an analog line (Central Office line) through an on-site modem. This will allow the computer to dial directly into the Option 11C or Option 11C Mini from a remote location.

Detailed information about the CCBR feature can be found in the *Option 11C Customer Controlled Backup and Restore (CCBR)* (553-3011-330).

Real time CPU capacity

Table 6
CPU capacity

Release	Average Msecs of CPU for PBX Call (Equivalent Basic Call)	Equivalent Basic IPE Calls per Hour
16.90G	250	10075
18.30H	306	8225
18.40H	300	8400
20.06	338	7450
20.19	374	6750
21.0x	373	6075
22.0x	50	58000
23	50	55775
24	47	50175
25	49	46324

Table 7
Option 11C Real Time Measurements PRI Calls (msecs) (with IP Expansion)

Call Type	2527d(2530) No Expansion cabinet	2527d (2530) With IP Expansion cabinet
pbx - tie	57	89
tie - pbx	51	86
aries - tie	56	127
tie - aries	59	99
tie - tie		
Average	58	100

Figure 3
Option 11C Real Time Measurements i2004 Calls (msecs)

Call Type	ITG card on Expansion cabinet PRI card on Expansion cabinet 2527d	ITG card on Main cabinet PRI card on Expansion cabinet 2527d
i2004-aries	236	231
aries-i2004	197	190
i2004-i2004	323	321
i2004-tie	319	321

Option 11C memory requirements are calculated using the following tables:

- Table 9 on page 28 - Resident Program Store
- Table 10 on page 29 - IP Memory Impacts
- Table 11 on page 30 - Unprotected data store requirements
- Table 12 on page 48 - Protected data store requirements

Record the memory requirements on “Worksheet D: Unprotected memory calculations” on page 141 and “Worksheet E: Protected memory calculations” on page 142.

Network Delay

There is some impact on real-time performance (estimated to be 20%) when digital trunks are installed in IP Expansion cabinets. However, there is still sufficient real-time to support five fully configured Option 11C cabinets in a typical business configuration.

Table 8
Basic LAN Requirements for Excellent Voice Quality

LAN requirement	Value for Excellent Voice Quality
Packet loss rate	<0.5%
PDV jitter buffer (maximum)	RTD<5 ms
Round trip Delay	<5 ms
PDV jitter buffer (minimum)	RTD<12 ms
100BaseT/F Layer 2/Layer 3 switch	Full Duplex connection

Software Program store

Resident Program store

The Resident Program store requirements are listed in Table 9

Table 9
Resident Program Store

Program 1024 words = 1K	Storage in words
Basic (BASE)	0
Read/Write Firmware	0
Overlay	46 000
Options (OPTF)	0
Multi Customer (CUST)	0
ROM Firmware	<u>8 000</u>
Total	54 000

For IP connectivity, extra memory usage is required. Table 10 summarizes the additional memory requirements of the Survivable IP configuration.

Table 10
IP Memory impacts

Functional area	Flash	DRAM	C-drive	PCMCIA
CDR storage			4 Mb (17500)	
Survivable db		x	x	x
start-up	3K	2K		3K
100baseT/F				218981 B
multi-clock	28 words			
cardlan		30K		
SSD		40K		
IP config		0.8K	0.8K	0.8K
voice		1K		
bootP		20K	0.8K	0.8K
remote TTY		35K		
TOTAL				

Data store requirements

Unprotected data requirements

Table 11 lists the unprotected data store requirements per item in words.

Table 11
Unprotected data store requirements (Part 1 of 4)

Data Store by Feature	Fixed Number of 1k Words per Item	Calculated number of Words Per Item
Fixed Address Globals	22389	-
500-type telephones	8.5	-
2500-type telephones	8.5	-
SL-1 sets (no digit display)	20.25	-
SL-1 sets (digit display)	22.25	-
Add-on K/L Strips	10	-
Data Service/VMS Access TNs	-	See Note 10 on page 40
Analog Trunks	-	See Note 17 on page 44
BRI Trunks	83	-
DTI	82	-
JDM/DTI2	57	-
ISDN PRI/PRI2/ISL	-	See Note 18 on page 46
Attendant	131	-
Customers	234	-
Console Presentation Group (CPG) Data Block	29, 35	#Customer, #CPG
Trunk Routes	-	See Note 1 on page 34

Table 11
Unprotected data store requirements (Part 2 of 4)

Data Store by Feature	Fixed Number of 1k Words per Item	Calculated number of Words Per Item
Network-Location Code	69	-
Tone and Digit Switch	59	-
Conference	166	-
Digitone Receivers	12	-
MFR - MF Receiver	-	See Note 20 on page 47
Tone Detect	12	-
Low Priority Input Buffers (LPIB) (from note 4)	4	See Note 11 on page 41
High Priority Input Buffers (HPIB) (from note 4)	4	See Note 11 on page 41
PBXOB	4 x PBXOB	See Note 11 on page 41
BCSOB	4 x PCSOB	See Note 11 on page 41
AML (CSL)	-	See Note 21 on page 47
MSDL	1273	-
Automatic Call Distribution (ACD)	-	See Note 3 on page 35
ACD Enhancement	-	See Note 8 on page 39
ESN Communication Management Center (CMAC)	350	-
NARS/BARS/CDP	-	See Note 4 on page 36

Table 11
Unprotected data store requirements (Part 3 of 4)

Data Store by Feature	Fixed Number of 1k Words per Item	Calculated number of Words Per Item
BGD Terminal Time	13	-
BGD/AWU Traffic Block	350	-
Call Register	161	See Note 5 on page 37
Call Park	-	See Note 6 on page 39
Integrated Message System Link (IMS)	16	See Note 7 on page 39
Auxiliary Processor Link (APL)	179	-
Automatic Trunk Maintenance (ATM) Schedule Block	-	No impact
ATM Data Block	-	No impact
Digital Telephones	-	See Note 9 on page 40
Multi-Tenant	32	-
Command Status Link (CSL)	$(143 + 483) \times \text{\#Links}$	-
Background Terminal	89	-
Display Messages	12	-
ISDN Basic Rate Interface (BRI)		See Note 16 on page 42
ISDN Primary Rate Access (PRA)	81	-

Table 11
Unprotected data store requirements (Part 4 of 4)

Data Store by Feature	Fixed Number of 1k Words per Item	Calculated number of Words Per Item
Overlay Data Space	260	-
ISDN Signalling Link (ISL)	81	-
Enhanced Busy Lamp Field (EBLF)	-	See Note 13 on page 42
Enhanced Night Service	1	-
Periodic Pulse Metering (PPM)	-	See Note 14 on page 42
Flexible Feature Codes (FFC)	3	-
Group Hunt	17	-
Model Telephones	-	See Note 15 on page 42
Model Trunks	-	See Note 15 on page 42
IP Expansion		See Note 22 on page 47

Notes to Table 11

The following notes are referred to in Table 11.

Note 1

The size of the trunk block is calculated from:

CT + w + x + y + z (words) where:

CT = 10

w = line block (see table below)

Trunk Types	Other	MS
RAN	5	5
RLA	15	14
ADM	18	18
IDA	43	43
Others	29	29 (Includes ISA)

x = 0 if the trunk belongs to a route which does not have CDR or has CDR with dialed digits

x = 9 if the trunk belongs to a route which has CDR with outpulse digits

y = 0 if the trunk belongs to a route which does not have the Timed Forced Disconnect option

y = 5 if the trunk belongs to a route which has the Timed Forced Disconnect option

z = 0 if the trunk does not have CNA defined

z = 4 if the trunk has CNA defined

Note 2

The size of a TTY block (in words) is calculated from:

$$t + x,$$

where $t = 2075$ and

x is defined in the following table:

Input Buff Data	Output Q
CDR Link	128
HS Link	128 + 15
APL Link	128 + 179 + 4
PMS Link	128 + 2
Other	128

Note 3

For ACD features, the following additional storage per system is required:

$$\mathbf{K0} \times [(\mathbf{K1} \times \mathbf{CROUT}) + (\mathbf{K2} \times \mathbf{CPID}) + (\mathbf{K3} \times \mathbf{CDN}) + \mathbf{CTM} + (\mathbf{K4} + \mathbf{CRT}) + (\mathbf{K5} \times \mathbf{CCUST})] + (\mathbf{K6} \times \mathbf{DN}) + (\mathbf{K7} \times \mathbf{PID}) + (\mathbf{K8} \times \mathbf{DN})$$

Where the multiplication constants (K_i) are:

K0 = 0 if ACD-C package is not equipped

K0 = 1 If ACD-C package is equipped

K1 = 46

K2 = 14 If long report is selected

K2 = 42 If short report is selected

K3 = 80

K4 = 30

K5 = 240

K6 = 149

K7 = 29

+ 2 for DN Expansion

+ 1 for ACD ACNT CODE

+ 1 for 500/2500 ACD set feature

K8 = 0 if priority agent package (PAGT) is not equipped

K8 = 32 for Option 11C with PAGT

And the variables represent the following:

CCUST = total number of customers with ACD-C package

CDN = total number of ACD DNs for ACD-C customers

CPID = total number of AGENT POSITIONs for ACD-C customers

CROUT = total number of ACD routes in ACD-C customers

CTM = total number of TRUNK members in CROUT

DN = total number of ACD DNs (for system)

PID = total number of AGENT POSITIONs (for the system)

CRT = total number of ACD CRTs

Note 4

If the NTRF package is equipped, the unprotected data store requirements (on a per customer basis) for NARS/BARS/CDP are as follows:

COS = TRAFSIZE + RLSIZE + NCOSIZE + QROUTSIZE

where:

	If OHQ or MCBQ is equipped	If OHQ or MCBQ not equipped
TRAFSIZE	216	200
RLSIZE =	2 x (45 x RL)	2 x (40 x RL)
NCOSIZE =	2 x (10 x NCOS)	2 x (6 x NCOS)
QROUTSIZE =	2 x (12 x QROUT)	0

QROUT = number of routes with either CBQ or OHQ

RL = number of route lists

NCOS = number of NCOS defined

Note 5

The total number of Call Registers may not exceed 2048. The recommended number of Call Registers is:

$$(T + 815)/33.8 + M + X + Y$$

where:

$$T = (A/2 \times C \times 1.42) - (M \times L)$$

A = the total voice loop traffic in CCS

C = the call register factor

- = 1
- + 0.037 if CDR Charge Account
- + 0.150 if NARS/BARS/CDP
- + 0.150 of FCBQ and OHQ
- + 0.033 if ACD RAN
- + 0.019 if Telset Messaging
- + 0.140 if Integrated Messaging System
- + 0.083 if Ring Again
- + 0.033 if Music Trunk
- + 0.067 if Call Park
- + 0.003 if New Flexible Code Restriction
- + 0.039 if ESN signalling
- + 0.000 if Stored Number Re-dial (negligible impact)

L = average CCS per ACD trunk

M = the number of ACD incoming trunks

X = 0 if no Network ACD (NACD)
 = the number of ACD calls which overflow out of Source ACD DN's on this node
 = (# Source ACD DN's) x (average overflow from Source ACD DN's)

$Y = 0$ if no Network ACD (NACD)
= the number of ACD calls which overflow into Target ACD DN
in this node
= (# Target ACD DN) x (average overflow into Target ACD DN)

The averages for NACD overflow must be estimated, and should be engineered for peak periods.

Assumptions for Call Register Factors:

- The peak day traffic = 1.42 x ABSBH for business offices.
- All outgoing calls require authorization (worse case assumption).
- An additional call register is required for 20 seconds to hold the authorization code.
- Fifty percent of outgoing calls use the charge account feature (worse case assumption).
- An additional call register is required for 20 seconds to hold the charge account.
- The additional holding time of the call register for CDR purposes is 5 seconds.
- The average number of ports used in the multiple CDR ports feature is 2.
- A call register is required for each incoming ACD trunk.
- The intra-office ratio $R = 0$ (worse case assumption).
- The number of originating calls equals the number of terminating calls.
- The blocking peak of the day traffic is P0.01.
- The average NARS/BARS call takes 20 seconds to dial and 20 seconds to complete outpulsing and delay for answer.
- The average holding time of a RAN is 15 seconds.
- The average Telset Message takes 6 seconds to dial and 20 seconds to complete outpulsing and delay for answer.
- The average IMS call takes 8 seconds to dial, 15 seconds ringing and 40 seconds with message attendant. During the busy hour, 60 percent of terminating calls are unanswered, of which 50 percent require IMS.
- A call register is required for active Ring Again call.

- Music Trunk holding time is 30 seconds.
- Average Call Park holding time is 1 minute.
- Average holding time for New Flexible Code Restriction is 4 seconds.
- ESN Signaling Feature holding time is 15 seconds and 25 percent of calls need the signaling feature.

Note 6

Size per item for Call Park:

$$k + \text{ceiling}(s/16), \text{ for UCALL_PARK_BLOCK}$$

where,

s = number of System Park DN's per customer.

k = 6, size(UCALL_PARK_BLOCK) (6.0)

Note 7

IMS unprotected memory requirements are:

LINK_OQ_TBL	16 words
APL_LINK_DATA	179 words x N *
QUEUE_DATA_BLOC	4 words x N*
N	number of APL links defined in CFN Block
Total IMS Unprotected	(16 + (183 x N)) words

* (183 x N) words are already accounted for in “Note 2” on page 35.

Note 8

ACD Enhancement - an ACD-C customer (See Note 3 on page 35).

Note 9

Unprotected data store (size in words) for digital telephone ports:

	Voice or Data Ports without Digit Display	VOD Ports with Digit Display
M2006	18	20
M2008	18	20
M2009	24.25	26.25
M2016	26	28
M2018	35.25	37.25
M2112	26.25	28.25
M2216	26 + 24 x #AOM	28 + 24 x #AOM
M2317	41.25	43.25
M2616	26 + 24 x #AOM	28 + 24 x #AOM
M3000	51.25	53.25

#AOM = Number of Add-on Modules

Note 10

The additional unprotected data store for a virtual terminal (DS access TN, or VMS access TN) is dependent on the card to which the terminal is assigned.

The increment in words are as follows:

	Preallocated card	Otherwise
DS/VMS Access TN:	15	16.25

Where a preallocated card is one of the following: 0/1-0/7, 1/1-1/8, 2/1-2/8 or 3/8 on a Digital Line Interface (DLI) loop. (See Note 12 on page 41.)

Note 11

The size of Input/Output buffers is specified in “messages”. Each message uses 4 words of unprotected data store. The recommended size for I/O buffers is:

LPIB (Low Priority Input Buffers) = 96 messages

HPIB (High Priority Input Buffers) = 32 messages - single group 32 x # groups - multi-group

PBXOB (Non-SL-1 Output Buffer) = 160 messages

BCSOB (SL-1 Output Buffer) = 160 messages

Note 12

The DCHI supports both 1.5 Mb PRI and 2.0 Mb PRI.

Each DCHI consists of the following unprotected data blocks:

DCH_U_BLOCK	60 words
Output Request Buffers	5 x number of OTBFs (LD 17)
Output Buffer	261 words
Input Buffer	261 words
Unprotected call reference table	2 + M
Unprotected message link table	1 + M

M is computed for each DCHI, depending on Mode, as follows:

PRA Mode	M =	NChan x [Highest Loop Interface ID(defined in LD 17 by PRI 111 nn)(zero if not defined)+ 1 (for primary channel_+1 (if backup channel is on)
ISL Mode	M =	maximum number of ISL trunks defined
Shared Mode	M =	the sum of the values for PRA and ISL mode

2Mb PRI only: unprotected data block = 91 words.

Note 13

The following applies to each customer:

- Two words are required in the attendant unprotected data block (per attendant console). This requirement is already accounted for in the size of the attendant data block.
- If EBLF (Enhanced Busy Lamp Fields) is on (LD 15), there is a bit required to indicate the busy or idle status of each DN. This amounts to 7 (16 bit) words per hundred groups defined.

Note 14

Total Unprotected data store per system is increased by the following:

$$(2 \times \text{CR}) + (4 \times \text{BGD}) + \text{TRUNK} + \text{PPM_CARD} + 4$$

where:

CR = number of Call Registers defined

BGD = number of background terminals

TRUNK = number of trunks

PPM_CARD = number of CO or E&M trunk card

Note 15

Model telephones and trunks require card block components only.

Model trunks — average 5 words

Model telephones — average 2 words

Note 16

The following tables show unprotected memory requirements for ISDN Basic Rate Interface.

Per System:

Function	Memory Requirements
MISP input buffer	170 words per system
MISP expedited input buffer	128 words per system

Per MISP:

Function	Memory Requirements
MISP loop block	270 words
MISP output buffer (transmit receive)	512 words
MISP expedited output buffer	32 words
MISP output request buffer	7 words
MISP block data block	303 words
Socket ID table	48 words
Meridian 1 expedited receive buffer	128 words
Meridian 1 receive buffer	266 words
Meridian 1 expedited transmit buffer	528 words
MISP traffic accumulating block	48 words
MISP traffic holding block	48 words

Per DSL:

Function	Memory Requirements
2 TN line blocks	2 x 9 words
SSD block	10 words
Incoming call reference table	33 words
Outgoing call reference table	33 words
Incoming call ref. usage map	4 words
Outgoing call ref. usage map	4 words
Incoming message call reg. table	33 words
Outgoing message call reg. table	33 words
BRI DSL data block	3 words

Per BRSC:

Function	Memory Requirements
BRSC data block	48 words
MISP traffic accumulating block	48 words
MISP traffic holding block	48 words

Per Line Card:

Function	Memory Requirements
Line card	5 words

Note 17

The size of the trunk block is calculated from:

$$CT + x + y + z \text{ (words)}$$

where, 9 average card block + 6 trunk timing block

CT = 15 words

x = (see the following table) --> line block

y = 9 CDR extension

z = 0 If the trunk belongs to a route which does not have the Timed Forced Disconnect option, or

z = 6 If the trunk belongs to a route which has the Timed Forced Disconnect option.

Trunk Type	Memory Requirements
RLA	20 words
ADM	72 words
IDA (DPN)	65 words
IDA (DASS)	53 words
OTHERS	61 words

Note 18

The DCH application supports both 1.5 Mbit PRI and 2.0 Mbit PRI2.

527 per system

197 + 2 x M

Where:

M is computed as follows for each DCHI, depending on Mode:

PRA Mode:

If PRI is defined:

$$M = NChan * (nn + 1)$$

If PRI is NOT defined:

$$M = NChan * [1 \text{ (for primary channel)} \\ + 1 \text{ (if backup channel is on)}]$$

Where:

nn = Highest Loop Interface Id (defined in Ov117 by PRI Ill nn), and

NChan = 24 for PRI and 31 for PRI2.

ISL Mode:

M = maximum number of ISL trunks defined.

Shared Mode:

M is the sum of the values for PRA and ISL Mode.

PRI2 only:

Unprotected data block = 68 words

Note 19

The size of the memory requirements needed for junctor groups are:

$$(N \times (N - 1) / 2) \times 73$$

Where:

N = Number of junctor groups

Note 20

Memory requirement are calculated for MFR from:

$$7 \times (\# \text{ MFR Cards}) + 3 \times (\# \text{ MFR Units})$$

Note 21

Memory requirements are calculated for AML from:

$$143 + 483 \times (\# \text{ Links(AML)})$$

Note 22

To support IP Expansion in IP expansion cabinets, an additional 2.0 Mb of memory is required on the Main and each survivable IP expansion cabinet.

An additional 0.5 Mb (only) is required on any non-survivable IP expansion cabinets.

Memory requirements are calculated as follows:

$$\text{Total memory} = 2\text{K} + (5.25\text{K} + \text{Number of Maintenance Connections}) + (16\text{K} + \text{Number of I/O Connections})$$

Protected data requirements

Table 12
Protected data store requirements (Part 1 of 5)

Data Store by Feature	Fixed Number of 1k Words per Item	Calculated number of Words Per Item
Fixed Address globals	9220	-
500 sets	-	See Note 1 on page 53
2500 sets	-	See Note 1 on page 53
M2000 Series	-	-
Delta-II M2000 Series	-	See Note 64 on page 85
DS/VMS Access TN's	-	See Note 65 on page 85
AOM	10/rs	-
DS/VMS/ACC/TNs	-	See Note 23 on page 67
Template Head Table	-	See Note 50 on page 79
Templates	-	See Note 50 on page 79
Trunks	20	See Note 19 on page 66
Attendant	-	See Note 2 on page 55
Auxiliary Customer	187	-
Customers	-	See Note 31 on page 70
CPG Level Services	46	-
Trunk Routes	-	See Note 28 on page 69
Code Restriction	51	-
New Flexible Code Restriction	-	See Note 16 on page 65
Peripheral Signaling	30	-
Digitone Receivers	9	-

Table 12
Protected data store requirements (Part 2 of 5)

Data Store by Feature	Fixed Number of 1k Words per Item	Calculated number of Words Per Item
Tone Detectors	-	See Note 53 on page 80
DLI/DTI	-	See Note 55 on page 81
DN Translators	-	See Note 3 on page 56
Serial Data Interface	(N x 8)	-
Application Module Link	(N x 18)	-
Dial Intercom Group(DIG) Translator	-	See Note 4 on page 58
Speed Call Master Head	-	See Note 31 on page 70
Speed Call Head Table	-	See Note 14 on page 64
Speed Call List	-	See Note 5 on page 58
Configuration	84	-
Configuration - Aux.	112	-
Basic Automatic Route Selection (BARS)	-	See Note 6 on page 59
Flexible Tones and Cadences (FTC)	-	See Note 35 on page 72
Enhanced FTC (EFTC)	-	See Note 35 on page 72
Network Automatic Route Selection (NARS)	-	See Note 7 on page 60
Coordinated Dialing Plan (CDP)	-	See Note 8 on page 61 and Note 51
Automatic Call Distribution (ACD)	-	See Note 9 on page 62
Network ACD (NACD)	-	See Note 36 on page 72
Group DND (Do Not Disturb)	-	See Note 10 on page 63
Direct Inward System Access (DISA)	-	See Note 11 on page 63

Table 12
Protected data store requirements (Part 3 of 5)

Data Store by Feature	Fixed Number of 1k Words per Item	Calculated number of Words Per Item
Authority Code	-	See Note 12 on page 63
CAS - Main	0	
CAS - Remote	15	-
History File	-	See Note 13 on page 64
Logical I/O	-	See Note 58 on page 82
Physical I/O	-	See Note 59 on page 82
Call Park	-	See Note 51 on page 79
Integrated Message System Link (IMS)	370	See Note 15 on page 65
New Flexible Code Restriction (NFCR)	-	See Note 16 on page 65
Soft Memory	35	-
Code Screening	-	See Note 18 on page 66
M2006	-	See note on page 72
M2008	-	See Note on page 73
M2216/M2616	-	See Note on page 74
Add-on modules	20/rs	-
Multi-tenant		See Note 20 on page 66
ATM Schedule Block	-	See Note 22 on page 67
Digital Line Interface (DLI)	-	See Note 17 on page 66
Enhanced Serial Data Interface (ESDI)	16 + N x 9 (N = # of ports)	-
Command Status Link (CSL)	4	-
Value Added Server (VAS)	16 + N (N = # of servers)	-

Table 12
Protected data store requirements (Part 4 of 5)

Data Store by Feature	Fixed Number of 1k Words per Item	Calculated number of Words Per Item
VAS DSDNs	-	See Note 24 on page 67
IMP	-	See Note 60 on page 82
Call Party Name Display (CPND)	-	See Note 26 on page 68
Line Load Control (LLC)	5	-
ISDN BRI	-	See Note 47 on page 74
ISDN PRA	-	See Note 27 on page 69
ISDN PRA	-	See Note 28 on page 69
ISDN PRI2	-	See Note 56 on page 81
ISDN PRI2	-	See Note 56 on page 81
DTI1	-	See Note 57 on page 81
Automatic Wakeup (AWU) Count	288	-
ISDN Signaling Link (ISL)	-	See Note 30 on page 70
Enhanced Busy Lamp Field (EBLF)	-	See Note 33 on page 71
BGD Automatic Timed Job	-	See Note 52 on page 80
Pretranslation	-	See Note 33 on page 71
LAPW	-	See Note 61 on page 83
Name Display for DMS	-	See Note 62 on page 84

Table 12
Protected data store requirements (Part 5 of 5)

Data Store by Feature	Fixed Number of 1k Words per Item	Calculated number of Words Per Item
FGD ANI Database	-	See Note 63 on page 84
Direct Inward Dialing/Direct Outward Dialing (DID/DOD)	1	-
Trunk Barring	-	See Note 37 on page 72
Periodic Pulse Metering (PPM)	-	See Note 39 on page 72
Flexible Feature Code (FFC)	-	See Note 40 on page 73
Network Attendant Console Service	-	See Note 41 on page 73
Group Hunt	10	-
ABCD	-	See Note 42 on page 73
Model Telephones	-	See Note 42 on page 73
Model Trunks	-	See Note 43 on page 73

Notes for Table 12

The following notes are referred to in Table 12.

Note 1

The size of the protected line block for Analog (500/2500 type) telephones is determined from the following:

Basic Line Block = 10 words

Basic Line Block (ODAS) = 13 words

Card Block component = 2 words (1/4 pcard block)

The key layout portion of the template requires $(4 + nf)/rs$ where “nf” is the number of features defined for the set, and “rs” is the number of sets sharing the same template.

In addition to the basic line block, each feature requires extra data space as follows:

Table 13
Feature data space requirements (Part 1 of 2)

DN	words	words
Dial Intercom Group	2 words	word
Speed Call User	1 word	word
System Speed Call User	1 word	word
Speed Call Controller	1 word	word
Call Forward Number	1-6 words (4-24 digits)	words (4 - 24 digits)
Call Park	2 words	words
CFCT	2 words	words
CFNA/Hunting Number	4 words	words
Stored Number Redial	1-8 words (4 - 32 digits)	words (4 - 32 digits)
Manual Line	2 words	words
Message Center DN	2 words	words

Table 13
Feature data space requirements (Part 2 of 2)

DN	words	words
Hot Line DN	2-10 (words(1 - 31 digits)	words (1 - 31 digits)
Tenant Number	1 word	word
Internal Call Forward	19 words	words
Last Number Redial	1-8 words	words
SCI/CCOS/RMS	2 words	word
Authcode	6-24 words	words
Automatic Wake Up	2 words	word
Message Registration	1 word	word
Call Party Name Display	1 word (if name is defined for this DN)	word (if name is defined for this DN)
Offhook Interdigit Index	1 word	word
Pre-translation Enhancement	1/2 word (for 255 calling groups)	Word (for 255 calling groups)
CFCT	2 words	words
EHOT feature	2-10 words	words
FAXS	17 words	words
FFC SCP PASS	2 words	words
Associate Set (AST)	2 words	words
EFD/EHT/ DN	4 words	words

Note 2

The size of the protected line block for attendant telephones is determined from the following:

Primary Line Block = 205 words

Secondary Line Block = 6 words

Card Block Component = 4 words

In addition to the basic line block, each feature requires extra data space as follows:

Autodial Key = 8 words

Paging Key = 2 words

Store Number Redial Key = 8 words

Note 3

The memory requirements for the Directory Number (DN) Translator are shown in the table below. The memory requirements are formulated as a sum, for which each row in the table describes an additive term; a term consisting of factor * item. Factors and items are represented by constants, variable descriptions and combinations of these. Units are words of protected data store.

Table 14
Directory Number (DN) data space requirements (Part 1 of 2)

Factor	Factor Description	Item	Item Description
2		S	# of different DN's appearing on SL-1/500/2500 sets
1			# of appearances of DN's within S
12	size(DNXBLOCK)	Sum N's	1+N1+N2+N3+N4+N5+N6: see below
	number of ACD DN's	2	
	number of ACD DN's	2 x AI	size(ACD_ID_DNBLOCK) x # ACD position ids in each ACD DN
	# DISA DN's	2	size(DISA_DNBLOC)
1			number of System Park DN's
1			number of listed DN's
	# defined DN's	2	
1		66	1 + size(ATTN_DNBLOC)

Table 14
Directory Number (DN) data space requirements (Part 2 of 2)

Factor	Factor Description	Item	Item Description
1	If special service prefix defined.	1	
	If special service prefix defined.	3	
1	If RSANI access code defined.	11	size(RSANI_BLK).
1	If CAS hold DN defined.	2	1+size(CAS_HOLD_DNBLOCK)
1	If CAS hold DN defined.	2	1+size(CAS_RLT_DNBLOCK).
	# CDP steering codes defined	3	size(CDP_DATA_BLOCK)
	# Testline DN's	2	size(TSTLINE_DNBLK)
	# ACD DN's defined	3	size(ACD_DNBLOCK)
	# DIG groups defined	2	size(DIG_DATA_BLK)
	# SL1 DN's	2	size(BCS_DNENTRY)

Where

N_n = number of different sequence of the first n digits in the numbering plan (if DN is more than n digits).

Note 4

The equation for calculating the protected memory requirement for dial intercom data is shown in the table below. The memory requirements are formulated as a sum, for which each row in the table describes an additive term consisting of factor * item. Factors and items are represented by constants, variable descriptions and combinations of these. Units are words of protected data store.

Refer to page 71 for computation of DIG CPND Name Pointer Table Size.

Table 15
Protected memory for dial intercom data

Factor	Factor Description	Item	Item Description
1			1 + configured max # of DIGs (OV 15)
	actual # of DIGs configured	2	
	actual # of DIGs configured	2 x avg	size(DIG_DATA_BLK) * avg # members in each DIG

Note 5

The size of a speed call list is:

$$((NB - 1) \times 256) + (NBR \times WE)$$

where:

NB and **WE** are calculated as described in Note 14 under the Speed Call List Head Table, and **NBR** is the remainder of the calculation to determine **NB**, which is:

$$NB = EL/EB$$

Note 6

The protected data store requirements for BARS (on a per customer basis) are:

$$\mathbf{BASIC_ESN + SUM + RL \times (8 + 3 \times RLE) + DME \times (4 + I/4) + FCAS + SDRR \times (3 + 2 \times SDE) + ITGE}$$

where:

$$\mathbf{BASIC_ESN = Size(ESN_DATA_BLOCK) + Size(NCTL_DATA_BLOCK)}$$

$$\mathbf{SUM = (Size(ESN_TRAN_BLOCK) \times [(10 \times (\#digits (0-9)) \times R) \times N] - 1) / (10 \times R) - 1}$$

$$\mathbf{Size(ESN_TRAN_BLOCK) = 11}$$

$$\mathbf{Size(ESN_DATA_BLOCK) = 131}$$

$$\mathbf{Size(NCTL_DATA_BLOCK) = 506}$$

n = maximum level of tree (n>0)

R = the rate of digits equipped in each level of the tree (translator)

RL = number of route lists

RLE = average number of route lists entries per route list

DME = number of distinct digit manipulation entries (including the default 0th entry)

I = average number of digits that must be inserted as part of digit manipulation

$$\mathbf{FCAS = (N + 1) + N(M + 1) + MN[4 + (100P + 15)/16]}$$

where:

N = number of defined FCAS tables

M = average number of NPA codes per table

P = average number of the first digits in NXX codes

SCC = number of entries in the SCC table

SDRR = number of supplemental digit restricted/recognized blocks defined for npa, nxx, loc, spn

SDE = average number of SDRR entries for each SDRR block

ITGE = $9 \times \text{ITEI}$, where ITEI is the number of Incoming Trunk Group Exclusion Index

This number is based on the assumption that the NPA/NXX translation tree is half full and distributed evenly. This should represent the typical case. For a more precise calculation, use the NARS formula.

Note 7

The protected data store requirements for NARS (on a per customer basis) are:

$$\mathbf{BASIC_ESN + SUM1 + SUM2 + SDRR \times (3 + 2 \times SDE) + RL \times (8 + 3 \times RLE) + DME \times (4 + I/E) + LOC \times 6 + FCAS + SCC + ITGE + MDID}$$

where:

$$\mathbf{BASIC_ESN} = \text{Size(ESN_DATA_BLOCK)} + \text{Size(NCTL_DATA_BLOCK)}$$

$$\text{Size(ESN_DATA_BLOCK)} = 131$$

$$\text{Size(NCTL_DATA_BLOCK)} = 306$$

$$\mathbf{SUM1} = (\text{SUM of network translator 1})$$

$$\mathbf{SUM2} = (\text{SUM of network translator 2})$$

$$\mathbf{SUM} = \frac{11 \times [(10 \times R) \times n] - 1}{(10 \times R) - 1}$$

n = maximum level of tree (n > 0)

R = the rate of digits equipped in each level of the tree (translator)

RL = number of route lists

RLE = average number of route lists entries per route list

DME = number of distinct digit manipulation entries (including the default 0th entry)

- I** = average number of digits that must be inserted as part of digit manipulation
- LOC** = number of on-net or virtual locations
- FCAS** = $(N + 1) + N(M + 1) + MN[4 + (100P + 15)/16]$
where:
N = number of defined FCAS tables
M = average number of NPA codes per table
P = average number of the first digits in NXX codes
- SCC** = number of entries in the SCC table
- SDRR** = number of supplemental digit restricted/recognized blocks defined for npa, nxx, loc, spn
- SDE** = average number of SDRR entries for each SDRR block
- ITGE** = $9 \times \text{ITEI}$, where ITEI is the number of Incoming Trunk Group Exclusion Index
- MDID** = $(2 \times \text{number of total office codes}) + (2 \times \text{number of total DID ranges regardless of which office codes they belong to})$. A maximum of 20 ranges of office codes can be defined per locations code. (That is, one office code and 20 ranges, or 20 office codes and one range for each office code.)

Note 8

The protected data store requirements for CDP (on a per customer basis) are:

$$\text{BASIC_ESN} + \text{SC} \times 3 + \text{RL} \times (8 + 3 \times \text{RLE}) + \text{DME} \times (3 + \text{I}/4)$$

where:

$$\text{BASIC_ESN} = \text{Size}(\text{ESN_DATA_BLOCK}) + \text{Size}(\text{NCTL_DATA_BLOCK})$$

$$\text{Size}(\text{NCTL_DATA_BLOCK}) = 306$$

SC = number of steering codes

RL = average number of route lists

- RLE** = average number of route lists entries per route
- DME** = number of distinct digit manipulation entries
- I** = average number of digits that must be inserted as part of digit manipulation

CDP steering Codes also occupy SL-1 DN tree spaces. This portion of data store is calculated in DN tree formulas. (See See “Note 3” on page 56.).

Note 9

The ACD feature requires the following additional data store (total for system):

For ACD-C not equipped:

$$(K3 \times DN) + (K4 \times PID) + AID + (K5 \times CUST)$$

For ACD-C equipped:

$$[K1 + (K2 \times CCUST)] + (K3 \times DN) + (K4 \times PID) + AID + (K5 \times CUST)$$

Where the multiplication constants (Ki) are:

$$K1 = 33 = \text{Size (P_ACD_I_BLK)}$$

$$K2 = 8 = \text{Size (P_ACD_SCHED_BLK)}$$

$$K3 = 72 = \text{Size (P_ACD_BLOCK) (=53) + ptr to blk from ACD_L:IST (=1) + word offset (ACD_POS_TN) (=16)}$$

$$K4 = 14 = \text{Size (P_ACD_KEY_DATA) (=14) + store for ACD_POS_TN (=1)}$$

$$K5 = 3 = \text{header (ACD_LIST) (=1) + header (ACD_AGENT_ID_TBL) (=2)}$$

And the variables represent:

AID = total number of AGENT IDs (for the system)

CCUST = total number of customers with ACD-C package

CUST = total number of customers with ACD-C/D packages

DN = total number of ACD DNs (for the system)

PID = total number of AGENT POSITIONS (for the system)

Note 10

The protected store requirements for Group DND (on a per customer basis) are:

$$1 + G \times (1 + 2 \times M)$$

where:

G = number of groups

M = number of members in each group (2 words per member)

Note 11

The protected store requirements for DISA (on a customer basis) are:

$$1 + (DN \times 7) \rightarrow 1 + (DN \times 7)$$

DN is the number of DISA DNs.

Note 12

The protected store requirements for Authorization Code (on a per customer basis) are:

$$\begin{aligned} & \text{Size(AUTH_TABLE_BLOCK)} + (A \times (L/4 \times 128)) + 64 \\ & + (B \times [\text{Size(AUTH_BLOCK)} + (C \times \text{Size} \\ & \text{(RESOLUTION_BLOCK))}] \end{aligned}$$

where:

Size(AUTH_TABLE_BLOCK) = 153 words

Size(AUTH_BLOCK) = 1018 words

Size (RESOLUTION_BLOCK) = 64 words

L = digit length

T = total auth code

A = number of overflow blocks

B = number of auth blocks

C = number of resolution blocks per auth block

For L less than or greater than 7:

A = $(T/128) + 1$

$$\mathbf{B} = 0$$

$$\mathbf{C} = 0$$

For L less in the range of 4 - 7

$$\mathbf{A} = (0.2 \times T)/128 + 1$$

$$\mathbf{B} = (0.8 \times T)/1000 + 1$$

$$\mathbf{C} = 8$$

Note 13

The History file buffer can be 1 - 64 K per customer option.

Note 14

For System Speed Call List Head Table the requirements are as follows:

$$\mathbf{k} + \mathbf{NB}/4 + \mathbf{NB} \text{ (Round NB/r up)}$$

where:

K = 3, and includes:

SLENTRYYS_BLK (0.5)

SCHTBLKLNKTH (0.5)

SCLHTWD (1.0)

SLENTRYYS_LST, SCLNUMDIGITS, and SCLWORDS_ENTRY
(1.0)

NB = number of blocks = EL/EB (round up any remainder)

EL = entries per list (given)

EB = entries per block, 256/WE (round up remainder)

WE = words per entry, DNS/4 (round up)

DNS = DN size (given)

Note 15

IMS protected memory requirements:

APP_SIZE_TBL = 10

MSG_SIZE_TBL = 20

LTN_TN_TBL = 255

LTN_LINK_TBL = 65

Note 16

If New Flexible Code Restriction (NFCR) is chosen for a customer, the following memory requirements are also needed:

- A 129 word block that contains:
 - A 128 word table containing the pointers to the FRL block for each route
 - A pointer to the tree root address table
- A table that contains the pointers to the NFCR trees. Its length will be defined by the maximum number of trees (defined in the customer data block)
- Four words will be required for each route that has defined FRL codes
- Storage for customer defined trees. Amount of memory used depends on the size of code restriction trees the customer has defined.

It is possible to calculate an upper bound for the amount of memory that a tree is using by applying the following:

- The INIT condition occupies 14 words
- For each digit sequence after the INIT condition:
 - if the digit sequence is greater than 1 digit, then memory required for digit sequence increases by 1.
 - if the digit sequence has a count field, then memory required for digit sequence increases by 1.
 - if the digit sequence is from a BYPS, then memory required for digit sequence increases by 1.

Note 17

DTI/DLI protected data store (in words) is comprised of:

$$\begin{aligned} & \mathbf{PDD_BLOCK + (N \times P_DTI_TSET_BLOCK)} \\ & \mathbf{+ ((T + L) \times \text{local network data})} \\ & \mathbf{+ (L \times (P_LOOP_DLI + \text{preallocated card data}))} \\ & \mathbf{= 18 + (N \times 11) + ((T + L) \times 70) + (L \times (19 + 144))} \end{aligned}$$

where:

N = the number of Threshold telephones

T = the number of DTI loops

L = the number of DLI loops

Note 18

The size of the protected multiple office code screening line block is determined from the following:

- 2 words for each NXX code defined
- 2 words for each range defined (maximum 20 ranges per location code - 80 words pds)

Note 19

The trunk block size is 20 words with ODAS.

Note 20

Requirements for the voice/data port are the same as an SL-1 basic telephone except the key layout portion of the template requires $10 + (\# \text{ of non-key features}) / (\# \text{ of telephones sharing the same template})$.

Note 21

Protected data store required by the Multi-Tenant Service feature includes the following:

1285 words per customer that enables Tenant Service:

= size (P_TENANT_PTRS) (=582)
 + size (TEN_CPG_ORDLS) (=256)
 + size (RTE_CPG_ORDLS) (=256)
 + size (CPG_DEFS) (=288)
1285 1382

42 words per tenant access map
 = size (ACCESS_ARRAY)

42 words per outgoing route access map
 = size (ACCESS_ARRAY)

Note 22

The protected data store requirements for ATM schedule block are as follows:

$$= 24 + ((9 \times NC + 1) \times NH) + 13 \times AR$$

where:

NC = number of customers

NH = number of hours to be scheduled

AR = number of routes schedules to be tested

Note 23

For all machine types, the additional protected data store for a virtual terminal (DS, access TN, or VMS access TN) is exactly the same with one exception. For any of the two TN types, the Card Block Component is dependent on the card to which the terminal is assigned. The component is 0 if the TN is on a preallocated card, and 1.5 words otherwise. See “Note 17” on page 66.

Note 24

Protected data store requirements per customer for VAS Data Services (for each customer having at least one DSDN) are:

$$DSDN_VAS_TBL + (DSDN_LIST \times N)$$

$$=16 + (77 \times N)$$

where:

N = the number of VAS having at least one DSDN is defined.

Note 25

Requirements for the voice/data port are the same except the key layout portion of the template requires $34 + (\# \text{ of non-key features}) / (\# \text{ of telephones sharing the same template})$.

For the M2317 data port, requirements are the same .

Note 26

Protected data store requirements for CPND per system in words is:

$$32 + (10 \times C) + SP + (DIG_TBL_SIZE \times DIG) + ((1 + n/2) \times NA) + SL$$

where:

C = number of customers configured with CPND

SP = number of single appearance Analog (500/2500 type) DNs with name defined

DIG_TBL_SIZE = 11 for 1 digit DIG groups, 101 for 2 digit DIG groups

DIG = number of DIG groups

n = average name length

NA = number of names

SL = number of non-Analog (500/2500 type) DNs (including trunk routes, ACD, ATTN) with or without name defined.

Note 27

Protected memory requirements for ISDN PRA are as follows:

Per system with DCHIs: P_DCH_TBL = 16 words

Per DCHI: P_DCH_BLOCK = 32 words

If	Protected call reference table:
If DCHI is in "PRA" mode	$1 + M \times (\text{\# of PRI or 2Mb PRI loops controlled by DCHI})$ where: $M = 24$ for PRI, and 31 for 2Mb PRI
If DCHI is in "ISL" mode	$1 + (\text{maximum number of ISL trunks defined})$
If DCHI is in "SHARED" mode	$1 + (M \times \text{\# of PRI/2Mb PRI loops controlled by DCHI})$ $+ (\text{maximum \# of ISL trunks defined})$ where: $M + 24$ for PRI and 31 for 2Mb PRI

Note 28

The equation for calculating the protected memory required for trunk routes is:

$$B + (X \times 92)$$

where:

$$B = 256$$

X = number of routes actually defined

$$RD = 116 = \text{size}(P_ROUTE_DATA)$$

For each ISA route configured for any IFC, add 10 words for the ISA_SRVC_BLOCK

Note 29

A pointer has been added to fix memory. The name of the pointer is “ISA_SID_MTHPTR” and is set to nil when SID is not defined for ISDN routes.

A data block of 32 words is defined and accessed through the pointer if SID is defined for at least one ISDN route in the system. This data block contains the pointer to SID tables for each customer. The structure mapping onto this data block is “ISA_CUSTID_TPTR”.
(size (ISA_CUSTID_TPTR = 100))

A data block of 128 words is allocated to each customer if at least one route is defined as having SID. The structure mapping onto this data block is “ISA_SID_RT_LIST”. The size of this data block is 512.

Note 30

Protected ISL trunk TN table = 1 + maximum number of ISL trunks defined

Note 31

The equation for calculating the protected memory requirements for customer data is:

$$\mathbf{B} + (\mathbf{X} \times (\mathbf{P} + \mathbf{A}))$$

where:

$$\mathbf{B} = 320$$

\mathbf{X} = number of customer groups actually defined

\mathbf{P} = protected customer data = 255

\mathbf{A} = auxiliary customer data = 59

If a background terminal is equipped, an additional auxiliary data block is allocated which requires 43 words. This brings the total memory requirement to 357 words.

Note 32

If the system is equipped with Speed Call package (66) and MSCL defined by LD 17 as being greater than zero, the protected memory required for the SCL main header table is:

$$N + A$$

where:

N = # of header words

A = number of SCL as defined in LD 17 (MSCL), otherwise no protected storage is required.

Note 33

For each customer, an additional 256 words is needed for PREXL_SCLN in pool CDB (compool).

Note 34

A bit is required in the customer data block to indicate if EBLF is allowed/denied.

A bit is required in the protected attendant block whether or not the ATTN console has CGM configured on the attendant console.

Additional protected memory is required, depending on the system configuration, and is allocated only if EBLF is turned on.

Words required:

$$XX \times ((ZZ - 3) \times YY \times 11)$$

where:

XX = number of customers who will have EBLF

YY = average number of hundreds group per customer

ZZ = average DN length (4, 5, 6, 7)

There are 104 words allocated in the fixed protected memory even if EBLF is not being used.

Note 35

Flexible Tones and Cadences (FTC):

FTC Pointers: 32 words

FTC tables: 187 x (# of FTC tables) (default = 1, others can be allocated using LD 56)

Note 36

Enhanced Flexible Tones and Cadences (EFTC)

MCAD pointers: 256 words

MCAD table: 18 x (# of MCAD tables) (default = 15, others can be allocated using LD 56)

Note 37

Network ACD has resulted in an increase of 7 words to the Protected ACD block (already accounted for in “Note 9” on page 62).

In addition, add 115 words per Source ACD-DN, as shown in the associated target table {0,2}, and 174 words per target ACD-DN.

Note 38

The protected data store for TRUNK BARRING consists of two structures:

TBAR_BLOCK 66 words

RCDT_BLOCK 3 + number of access restriction tables (ARTs)

Note 39

The total protected data store increases by the following amount per system

$$(12 \times \mathbf{BGD}) + (5 \times \mathbf{CUST}) + (3 \times \mathbf{ROUTE}) + \mathbf{TRUNK}$$

where:

BGD = number of background terminals

CUST = number of customers

ROUTE = number of trunk routes

TRUNK = number of trunks

Note 40

The protected data store for FFC consists of three structures:

Structure name	Increase in number of words
FFC_DNXL_BLOCK	13
FFC_GRHP_BLOCK	2
FFC_ELK_PASS	3

Note 41

NAS has one protected data structure added:

Structure name	Increase in number of words
NAS_SCHED_BLK	32 + (3 x schedule period)

Note 42

The protected data store for ABCD consists of two structures:

Structure name	Increase in number of words
ABCDHT	256
ABCDDATABLOCK	120

Note 43

Model telephones require the same protected memory as the corresponding telephone type.

Note 44

Model trunks require the same protected memory as the corresponding trunk type.

Note 45

Requirements for the voice/data port are the same except the key layout portion of the template requires

$$7 + (\text{\# of non-key features}) / (\text{\# of telephones sharing the same template}).$$

Note 46

Requirements for the voice/data port are the same except the key layout portion of the template requires

$$9 + (\text{\# of non-key features}) / (\text{\# of telephones sharing the same template}).$$

Note 47

Requirements for the voice/data port are the same except the key layout portion of the template requires

$$17 + (\text{\# of non-key features}) / (\text{\# of telephones sharing the same template}).$$

Note 48

The following table shows protected memory storage requirements for ISDN BRI.

Per System:

$$\mathbf{HT + DATA * G + MT + BT}$$

where

$$\mathbf{HT} = 16 = \text{size (P_BRI_PROT_HT)}$$

$$\mathbf{DATA} = 5 = \text{size (P_BRI_PROT_DATA)}$$

$$\mathbf{G} = \text{\# of groups}$$

$$\mathbf{MT} = 128 = \text{size (P_MSDL_MISP_TABLE)}$$

$$\mathbf{BT} = 96 = \text{size (SYS_BRSC)}$$

and

HT is BRI protocol group table

DATA is BRI protocol group data block

BT is system BRSC pointer table

LAPD Protocol:

LAPD protocol group master head ptr (P_BRI_PROTMHTPTR) =

LAPD protocol group table (BRI_PROT_GRPTR[]) =

LAPD protocol group data (P_BRI_PROT_DATA) = 5

Per MISP:

MLB + MMB + SID + PIO + IO

where

MLB = 145 = size (PMISPLOOP_BLOCK)

MMB = 50 = size (P_MSJLMISP_BLOCK)

SID = 49 = size (P_SOCKET_ID_TABLE)

PIO = 5 = size (PHY_MISP_IOBLK)

IO = 259 = increase per MISP in size (IO_TABLE)

and

PIO is Physical IO block

IO is IO table

A typical large system will support about 5 MISPs.

Per DSL (Digital Subscriber Loop):

BB + ODAS + CLS + DD + BD + USID + TB + TF

where

BB = 26 = size (PBCSBLOCK) digital set

ODAS = 3 = data services addend to PBCSBLOCK

CLS = 12 = CLS: EFD, HUNT, EHT @ 4w each

DD = 17 = size (P_BRI_DSL_DATA) (nonkey function)

BD = 40 = size (P_BRI_LTID_DATA) (nonkey function)

USID = 16 = size (P_BRI_USID_MAP)

TB = 15 = Template(base)

TF = 4 = Template(features): LTID, EFD, HUNT, EHT @ 4w each

Each MISP can control up to 4 line cards. Each line card can hold up to 8 DSL's.

Per TSP (Terminal Service Profile):

TSP + BRIDN * NDN

where

TSP = 76 = size (P_BRI_TSP_DATA)

BRIDN = 7 = size (BRI_DNBLOCK)

NDN = # BRI DN's

Each DSL can hold up to 16 TSP's. Each TSP supports 8 physical sets and 20 logical units.

Per BRSC (): (BRSC is a Release 19 innovation that increases the number of line cards served by one MISP from 4 to 120)

BB

where

BB = 34 = size (P_BRSC_BLOCK)

Each MISP can control 8 BRSC cards. Each BRSC can control 15 line cards.

Note 49

The size of the protected line block for SL-1 sets is determined from the following (size in SL-1 words):

Feature	Memory Requirements
Basic Line Block	21
Basic Line Block (ODAS)	24
Card Block Component	2

The key layout portion of the template for :

$$M2006 \quad 10 + (\# \text{ of non-key features}) / rs$$

$$M2008 \quad 10 + (\# \text{ of non-key features}) / rs$$

$$M2216 \quad 20 + 30 \times (\#AOM) + (\# \text{ of non-key features}) / rs$$

$$M2616 \quad 20 + 30 \times (\#AOM) + (\# \text{ of non-key features}) / rs$$

where rs = the number of sets sharing the same template, and #AOM = the number of add-on modules.

In addition to the basic line block requirement, each feature requires extra data space as follows:

Table 16
Feature memory requirements (Part 1 of 3)

Feature	Memory Requirements
ACD Agent Key	1
ACD Display Queue Key	2
ACD IN-CALLS Key	11
ACD Interflow Key	2
ACD night service DN	2
Associate Set (AST)	1
Authcode	6-24
Autodial Key	1-6
Automatic Wakeup	2
Call Forward key	1-6
Call Park	2
Call Party Name Display	1
CFCT feature	2
CFNA DN	4

Table 16
Feature memory requirements (Part 2 of 3)

Feature	Memory Requirements
Conference Autodial Key	1-6
Conference hotline key	3-10
Conference speed call key	1
DID Route Control	1
DIG Key	2
DN Key	2
EFD DN	4
EHT DN	4
Enhanced Hot Line DN	2-10
FAXS	17
Flash Call Key	1
Flash Override Call Key	1
Hot Line DN	2-10
HUNT DN	4
Immediate Call Key	1
Last Number Redial	1-8
Message Center DN	2
Message Registration	1
Notification Keylamp	1
Park Key	1
Pretranslation Enhancement	1/2

Table 16
Feature memory requirements (Part 3 of 3)

Feature	Memory Requirements
Priority Call Key	1
Private Call Key	2
SCI/CCOS/RMS	2
Signal Key	2
Speed Call Controller	1
Speed Call user	1
Stored number redial	1-8
Tenant Number	1
Time and Date Key	1
Voice call Key	2

Note 50

The following calculation applies to Template memory requirements:

$$\mathbf{HDT + (\# \text{ of templates}) * (avg. template length)}$$

Where:

$$\mathbf{HDT = 4097 = size(TEMPLATE_HD_TBL)}$$

Note 51

The protected data store requirements for Coordinated Dialing Plan (CDP) (on a per-customer basis) are:

$$\mathbf{BASIC_ESN + SC \times 3 + RL \times (8 + 3 \times RLE) + DME \times (3 + I/4)}$$

where,

$$\text{BASIC_ESN} = \text{SIZE}(\text{ESN_DATA_BLOCK}) + \text{SIZE}(\text{NCTL_DATA_BLOCK})$$

$$\text{SIZE}(\text{ESN_DATA_BLOCK}) = 131$$

$$\text{SIZE}(\text{NCTL_DATA_BLOCK}) = 506$$

SC = number of steering codes

RL = the number of route lists

RLE = the average number of route lists entries per route list

DME = the number of distinct digit manipulation entries

I = the average number of digits that must be inserted as part of digit manipulation

CDP Steering Codes also occupy DN tree spaces. This portion of data store is calculated in DN tree formula. (See“Note 3” on page 35).

Note 52

Protected data store for the BGD Automatic Timed Job feature:

$$= (\text{for blocklength}) + 13 * \text{ATJE Words}$$

Where:

ATJE = number of Automatic Timed Job Entries ranges from 1 to 12.

Note 53

Protected memory requirements for MFRs:

MFRs will use 7 words per card + 2 words per unit (up to 2 units per card)

Note 54

Protected memory requirements in words for Tone Detectors:

$$= \text{size}(\text{PTDET_BLOCK}) = 2 + 1 \text{ word from TDET_LIST}$$

$$= 3 * (\# \text{TDET's})$$

Note 55

DTI/DLI protected data (in words) is comprised of:

$$\begin{aligned} & \mathbf{PDD_BLOCK + (N \times P_DTI_TSET_BLOCK)} \\ & \mathbf{+ (T + L) \times local\ network\ data)} \\ & \mathbf{+ (L \times (P_LOOP_DLI + preallocated\ card\ data))} \\ & \mathbf{= 21 + (N \times 11) + ((T + L) \times 70) + (L \times (19 + 144))} \end{aligned}$$

Where:

N = the number of Threshold Sets

T = the number of DTI loops

L = the number of DLI loops

Note 56

For each PRI or PRI2 loop configured, add 7 words for the P_PRILP_BLOCK to the PTERM LOOP_BLOCK (= 78)

Note 57

Protected memory requirements for DCH:

P_DCH_BLOCK = 89 words

Protected call reference table:

= If DCH is in "PRA" mode:

1 + M words, where M is defined as follows:

If PRI is defined:

$$M = NChan * (nn + 1)$$

If PRI is NOT defined:

$$M = NChan * [1 \text{ (for primary channel)} + 1 \text{ (if backup channel is on)}]$$

Where:

nn = Highest Loop Interface Id (defined in Ov117 by PRI Ill nn), and

NChan = 24 for PRI and 31 for PRI2.

If DCH is in “ISL” mode:

1 + (maximum number of ISL trunks defined)

If DCH is in “SHARED” mode:

**1 + (M * # of PRI/PRI2 loops controlled by DCH) +
(maximum number of ISL trunks defined)**

where M = 24 for PRI, and 31 for PRI2.

Note 58

The protected data store requirements for DTI2 is as follows:

DTI2_SYSTEM_DATA = 11 words

DTI2_SCAT_HT = 16 words

DTI2_SCAT = 95 words

DTI2_PDCA_HT = 16 words

DTI2_PDCA = 10 words

Note 59

The logical applications are AML, DCH, and SDI.

logical master head table = 4 words

logical application head table for

SDI = 16 words

AML = 16 words

DCH = 64 words

Total (if all three applications are used) = 100 words

Note 60

Memory requirements for physical I/O table:

I/O polling table = 3 + (# of serial I/O devices) + (# of service loops)

In addition to the above, memory is also allocated for each existing physical card for a service loop or serial I/O device as follows:

Service loops:

TDS = 4 MISP = 5 MSS = 4 XCT = 4PMON = 4

I/O Serial Devices:

ESDI, DCH, SDI, SDI2, SDI3, SDI4 = 7

MSDL = 13

Note 61

Limited Access to Overlays (LAPW)

The number of words required to store protected data for this feature can range from 38 to 5950, as listed below:

Fixed Address Globals (already accounted for in the first table item):

Protected pointer to the main LAPW data structure
(LAPW_DATA_BLK) = 1 word

“Invalid login threshold” and “lock-out time” = 1 word

System defined passwords (PWD1 and PWD2) = 16 words

Port lock-out information (MAX_NUM_OT_TTYS = 16) = 2 words per
TTY

Audit trail (size of configured buffer) = 0 - 1000 words

Dynamically allocated storage per Limited Access Password (LAPW):

Configured optional data = 1 word

Password = 8 words

Overlay restriction data = 7 words

Customer and Tenant restriction data (1 word per Customer/Tenant) = 0-
32 words

Pointer to password blocks = 1 word

= 17 + # of tenants

Note 62

Protected data store for the Name Display DMS feature. Dynamically allocated per terminating number of a DMS number (= 3 words).

Note 63

FGD ANI database memory requirements:

guide = ANI = xxx-xxx-xxxx (10 digits) = npa-nxx-sub

Up to 31 different ANI data blocks (tables) per SL-1 system could be configured in order to provide flexibility of ANI screening. Once an ANI data block (table) is created:

ANI HEAD BLOCK (FGDANI_HEADER) (fixed size):

1 word + (contains master pointers to all the 31 ANI Datablocks in the system)

31 words (contains pointers to each of the 31 ANI datablocks)

NPA BLOCK (dynamically allocated by # of NPAs configured):

6 words (TRMT_INFO in NPA_BLK) + (3 words (NPATYPE) * (# NPAs configured for this ANI data block));

up to 160 NPAs can be configured in a NPA block

NXX HEAD BLOCK (Dynamically allocated by # of NXX blocks):

1 word + (3 words (HDBLKTYPE) * (# NXX blocks configured));

Up to 7 NXX blocks can be configured under one NPA block.

NXX BLOCKS (NXX_BLK) (Fixed size 255 words)

SUB HEAD BLOCK (Dynamically allocated by # of SUB blocks):

1 word + (3 words (SUBTYPE) * (# SUB blocks configured));

Up to 118 SUB blocks can be configured under one NXX block.

SUB BLOCKS (SUB_BLK) (Fixed size 256 words)

Note 64

Requirements for voice/data port are the same (see“Note 2” on page 35) except the key layout portion of the template requires $34 + (\# \text{ of nonkey features}) / (\# \text{ of sets sharing the same template})$.

Note 65

For all machine types, the additional protected data store for a virtual terminal (DS, access TN, or VMS access TN) is exactly the same with one exception. For any of the two TN types, the Card Block Component is dependent on the shelf/card to which the terminal is assigned. The component is 0 if the TN is on a preallocated card, and size (PCARDBLOCK)/4 (=2) words otherwise. (The following shelf/cards are preallocated: 0/1 - 0/7, 1/1 - 1/8, 2/1 - 2/8, or 3/8 on a DLI loop.) Refer to page 66.

Chapter 2 — Provisioning

Contents

This section contains information on the following topics:

List of tables	89
List of Worksheets	90
Introduction	91
Provisioning a new system	91
Defining and forecasting growth	91
Estimating CCS per terminal	93
Comparative method	93
Manual calculation	95
Default method	96
Calculating number of trunks required	97
Calculating line, trunk, and console load	98
Line load	98
Trunk load	98
Console load	98
Calculating Digitone receiver requirements	99
Model 1	100
Model 2	100
Model 3	100
Model 4	100
Detailed calculation: Method 1	101

Detailed calculation: Method 2	102
Calculating total system load	102
Calculating number of loops required	102
Calculating number of IPE cards required	103
Provisioning conference/TDS loops	108
Conference loops	108
TDS loops	109
Calculating memory requirements	110
Assigning equipment and preparing equipment summary	110
Calculating battery backup time	110
Procedure	111
Worksheet A: Growth forecast	135
Worksheet B: Total load	137
Worksheet C: System cabinet / Main chassis requirements	138
Worksheet D: Unprotected memory calculations	141
Worksheet E: Protected memory calculations	142
Worksheet F: Equipment summary	143
Worksheet G: System power consumption	144
Worksheet Ga: System power consumption: Main cabinet	146
Worksheet Gb: System power consumption: first expansion cabinet ..	147
Worksheet Gc: System power consumption: second expansion cabinet ..	148
Worksheet Gd: System power consumption: third expansion cabinet ..	149
Worksheet Ge: System power consumption: fourth expansion cabinet ..	150
Worksheet Gf: Total Option 11C system power consumption	151
Worksheet Gg: Option 11C Mini power consumption: Main chassis ..	151
Worksheet Gh: Option 11C Mini power consumption: Chassis expander	152
Worksheet Gi: Total Option 11C Mini system power consumption ..	152

Worksheet H: Battery current and AC line calculation for AC systems using NTA75 and NTA76	153
Worksheet I: Battery current calculation for customer-provided DC reserve power	154

List of tables

- Table 22: “Trunk traffic — Poisson 1 percent blocking” on page 112
- Table 23: “Trunk traffic — Poisson 2 percent blocking” on page 114
- Table 24: “Digitone receiver (DTR) requirements — Model 1” on page 117
- Table 25: “Digitone receiver (DTR) requirements — Model 2” on page 118
- Table 26: “Digitone receiver (DTR) requirements — Model 3” on page 119
- Table 27: “Digitone receiver (DTR) requirements — Model 4” on page 120
- Table 28: “Digitone receiver (DTR) load capacity — 6 to 15 second holding time” on page 121
- Table 29: “Digitone receiver (DTR) load capacity — 16 to 25 second holding time” on page 123
- Table 30: “Digitone receiver (DTR) requirements — Poisson 0.1 percent blocking” on page 126
- Table 33: “Conference and TDS loop requirements” on page 131
- Table 34: “Digitone receiver provisioning” on page 132

List of Worksheets

- “Worksheet A: Growth forecast” on page 135
- “Worksheet B: Total load” on page 137
- “Worksheet C: System cabinet / Main chassis requirements” on page 138.
- “Worksheet D: Unprotected memory calculations” on page 141
- “Worksheet E: Protected memory calculations” on page 142
- “Worksheet F: Equipment summary” on page 143
- “Worksheet G: System power consumption” on page 144
 - “Worksheet Ga: System power consumption: Main cabinet” on page 146
 - “Worksheet Gb: System power consumption: first expansion cabinet” on page 147
 - “Worksheet Gc: System power consumption: second expansion cabinet” on page 148
 - “Worksheet Gd: System power consumption: third expansion cabinet” on page 149
 - “Worksheet Ge: System power consumption: fourth expansion cabinet” on page 150
 - “Worksheet Gf: Total Option 11C system power consumption” on page 151
 - “Worksheet Gg: Option 11C Mini power consumption: Main chassis” on page 151
 - “Worksheet Gh: Option 11C Mini power consumption: Chassis expander” on page 152
 - “Worksheet Gi: Total Option 11C Mini system power consumption” on page 152

- Worksheet H: Battery current and AC line calculation for AC systems using NTA75 and NTA76 on page 153
- Worksheet I: Battery current calculation for customer-provided DC reserve power on page 154

Introduction

This chapter outlines the procedures required to determine equipment requirements.

Provisioning a new system

The following summarizes the tasks required to provision a new system:

- 1 Define and forecast growth (page 91).
- 2 Estimate CCS per terminal (page 93).
- 3 Calculate number of trunks required (page 97).
- 4 Calculate line, trunk, and console load (page 98).
- 5 Calculate DTR requirements (page 99).
- 6 Calculate total system load (page 102).
- 7 Calculate number of loops required (page 102).
- 8 Calculate number of IPE cards required (page 103).
- 9 Provision Conference/TDS loops (page 108).
- 10 Calculate memory requirements (page 110).
- 11 Assign equipment and prepare equipment summary (page 110).
- 12 Calculate battery backup time (page 110).

Defining and forecasting growth

The first step in provisioning a new system is to forecast the number of telephones required at two-year and five-year intervals.

The number of telephones required when the system is placed in service (cutover) is determined by the customer. If the customer is unable to provide a two-year and five-year growth forecast, then an estimate of annual personnel growth in percent is used to estimate the number of telephones required at the two-year and five-year intervals.

Example

A customer has 180 employees and needs 100 telephones to meet the system cutover. The customer projects an annual increase of 5 percent of employees based in future business expansion. The employee growth forecast is:

- $180 \text{ employees} \times 0.05 \text{ (percent growth)} = 9$
- $189 \text{ employees} \times 0.05 = 10 \text{ additional employees at 1 year}$
- $199 \text{ employees} \times 0.05 = 10 \text{ additional employees at 2 years}$
- $209 \text{ employees} \times 0.05 = 10 \text{ additional employees at 3 years}$
- $219 \text{ employees} \times 0.05 = 11 \text{ additional employees at 4 years}$
- $230 \text{ employees} \times 0.05 = 12 \text{ additional employees at 5 years}$

The ratio of telephones to employees is $100/180$, which equals 0.556.

To determine the number of telephones required from cutover through a five-year interval, the number of employees required at cutover, one, two, three, four and five years is multiplied by the ratio of telephones to employees (0.556).

- $180 \text{ employees} \times 0.556 = 100 \text{ telephones at cutover}$
- $189 \text{ employees} \times 0.556 = 105 \text{ telephones at 1 year}$
- $199 \text{ employees} \times 0.556 = 111 \text{ telephones at 2 years}$
- $209 \text{ employees} \times 0.556 = 116 \text{ telephones at 3 years}$
- $219 \text{ employees} \times 0.556 = 122 \text{ telephones at 4 years}$
- $230 \text{ employees} \times 0.556 = 128 \text{ telephones at 5 years}$

This customer requires 100 telephones at cutover, 111 telephones at two years, and 128 telephones at five years

Each DN assigned to a 500/2500 telephone requires a TN. Determine the number of 500/2500 TNs required for each customer and enter this information in "Worksheet A: Growth forecast" on page 135. Perform this calculation for cutover, two-year and five-year intervals.

Estimating CCS per terminal

Estimate the station and trunk CCS per terminal (CCS/T) for the installation of a system using any one of the following methods:

- comparative method
- manual calculation
- default method

Comparative method

Select three existing systems which have a record of traffic study data. The criteria for choosing comparative systems are:

- similar line size (± 25 percent)
- similar business (such as bank, hospital, insurance, manufacturing)
- similar locality (urban or rural)

Once similar systems have been selected, their station, trunk, and intra CCS/T are averaged. The averages are then applied to calculate trunk requirements for the system being provisioned (see the example in Table 17).

Table 17
Example of station, trunk, and intra CCS/T averaging

	Customer A	Customer B	Customer C	Total	Average
Line size	200	250	150	600	200
Line CCS/T	4.35	4.75	3.50	12.60	4.20
Trunk CCS/T	2.60	3.0	2.0	7.60	2.50
Intra CCS/T	1.70	1.75	1.50	4.95	1.65

If only the trunk CCS/T is available, multiply the trunk CCS/T by 0.5 to determine the intra-CCS/T (assuming a normal traffic pattern of 33 percent incoming calls, 33 percent outgoing calls, and 33 percent intra-system calls). The trunk CCS/T and intra CCS/T are then added to arrive at the line CCS/T (see the example in Table 18).

Table 18
Example of CCS/T averaging when only trunk CCS/T is known

Trunk type	Number of trunks	Grade of service	Load in CCS	Number of terms	CCS/T
DID	16	P.01	294	234	1.20
CO	14	P.02	267	234	1.14
Tie	7	P.05	118	215	0.54
Paging	2	10 CCS/trunk	20	207	0.09
Out WATS	4	30 CCS/trunk	120	218	0.54
FX	2	30 CCS/trunk	60	218	0.27
Private line	4	20 CCS/trunk	80	4	20.00
			Total: 959		Total: 23.78

The individual CCS/T per trunk group is not added to form the trunk CCS/T. The trunk CCS/T is the total trunk load divided by the total number of lines at cutover.

From the preceding information, trunk CCS/T can be computed as follows:

$$\text{trunk CCS/T} = \text{total trunk load in CCS/} / (\text{number of lines}) = 959/234 = 4.1$$

Assuming a 33 percent intra-calling ratio:

$$\text{intra CCS/T} = 4.1 \times 0.5 = 2.1$$

$$\text{line CCS/T} = 4.1 (\text{trunk CCS/T}) + 2.1 (\text{intra CCS/T}) = 6.2$$

Manual calculation

Normally, the customer can estimate the number of trunks required at cutover and specify the grade of service to be maintained at two-year and five-year periods (see Table 19). (If not, use the comparative method described on page 93.)

The number of trunks can be read from the appropriate trunking table to select the estimated usage on the trunk group. The number of lines that are accessing the group at cutover are divided into the estimated usage. The result is the CCS/T which can be used to estimate trunk requirements.

Example:

- Line CCS/T = 6.2
- Trunk CCS/T = 4.1
- 2 consoles = 30 CCS

Table 19
Example of manual calculation of CCS/T

Cutover	Line CCS = $275 \times 6.2 =$	1705
	Trunk CCS = $275 \times 4.1 =$	1128
	Subtotal =	2833
	Console CCS =	30
	Total system load = 2863	
2 years	Line CCS = $304 \times 6.2 =$	1885
	Trunk CCS = $304 \times 4.1 =$	1247
	Subtotal =	3132
	Console CCS =	30
	Total system load = 3162	
5 years	Line CCS = $352 \times 6.2 =$	2183
	Trunk CCS = $352 \times 4.1 =$	1444
	Subtotal =	3627
	Console CCS =	30
	Total system load = 3657	

This method is used for each trunk group in the system, with the exception of small special services trunk groups (such as tie, WATS, and FX trunks). Normally, the customer will tolerate a lesser grade of service on these trunk groups. Table 20 lists the estimated usage on special services trunks.

Table 20
Estimated load per trunk

Trunk type	CCS
Tie	30
Foreign exchange	30
Out WATS	30
In WATS	30
Paging	10
Dial dictation	10
Individual bus lines	20

Default method

Studies conducted estimate that the average line CCS/T is never greater than 5.5 in 90 percent of all businesses. If attempts to calculate the CCS/T using the comparative method or the manual calculation are not successful, the default of 5.5 line CCS/T can be used.

The network line usage is determined by multiplying the number of lines by 5.5 CCS/T. The total is then multiplied by two to incorporate the trunk CCS/T. However, when this method is used, the intra CCS/T is added twice to the equation, and the result could be over provisioning if the intra CCS/T is high.

Another difficulty experienced with this method is the inability to forecast individual trunk groups. The trunk and intra CCS/T are forecast as a sum group total. Examples of the default method and the manual calculation method are shown in Table 21 for comparison.

Example:

- 275 stations at cutover
- 304 stations at two years
- 352 stations at five years

Cutover: $275 \times 5.5 \text{ (CCS/T)} \times 2 = 3025 \text{ CCS total system load}$

Two-year: $304 \times 5.5 \text{ (CCS/T)} \times 2 = 3344 \text{ CCS total system load}$

Five-year: $352 \times 5.5 \text{ (CCS/T)} \times 2 = 3872 \text{ CCS total system load}$

Table 21
Default method and manual calculations analysis

	Default method	Manual calculations	Difference
Cutover	3025	2863 CCS	162 CCS
Two years	3344	3162 CCS	182 CCS
Five years	3872	3657 CCS	215 CCS

Calculating number of trunks required

Enter the values obtained through any of the three previous methods in Worksheet A. Add the calculations to the worksheet. Once the trunk CCS/T is known and a grade of service has been specified by the customer, the number of trunks required per trunk group to meet cutover, two-year, and five-year requirements is determined as shown in the following example.

Example

The customer requires a Poisson 1 percent blocking grade of service (see Reference Table 1). The estimated trunk CCS/T is 1.14 for a DID trunk group. With the cutover, two-year, and five-year number of lines, the total trunk CCS is determined by multiplying the number of lines by the trunk CCS/T:

Cutover: $275 \text{ (lines)} \times 1.14 \text{ (trunk CCS/T)} = 313.5 \text{ CCS}$

Two-year: $304 \text{ (lines)} \times 1.14 \text{ (trunk CCS/T)} = 346.56 \text{ CCS}$

Five-year: $352 \text{ (lines)} \times 1.14 \text{ (trunk CCS/T)} = 401.28 \text{ CCS}$

Use Reference Table 2 on page 114 to determine the quantity of trunks required to meet the trunk CCS at cutover, two-year, and five-year intervals. In this case:

- 17 DID trunks are required at cutover
- 18 DID trunks are required in two years
- 21 DID trunk are required in five years

For trunk traffic greater than 4427 CCS, allow 29.5 CCS/T.

Calculating line, trunk, and console load

Once the quantity of trunks required has been estimated, enter the quantities in Worksheet A for cutover, two-year, and five-year intervals. This calculation must be performed for each trunk group to be equipped. The total trunk CCS/T is the sum of each individual trunk group CCS/T. This value is also entered in “Worksheet A: Growth forecast” on page 135.

Line load

Line load is calculated by multiplying the total number of 500-telephone TNs by the line CCS/T. The number of TNs is determined as follows:

- one TN for every DN assigned to one or more Analog (500/2500 type) telephone
- one TN for every Meridian Digital Telephone without data option
- two TNs for every Meridian Digital Telephone with data option

Trunk load

Trunk load is calculated by multiplying the total number of digital telephone and 500-line TNs which have access to the trunk route by the CCS/T per trunk route.

Console load

Console load is calculated by multiplying the number of consoles by 30 CCS per console.

Calculating Digitone receiver requirements

The NTDK20 SSC card and the NTDK97 MSC card meet all DTR requirements. DTR provisioning methods are provided below for exceptional cases requiring extra DTR capacity.

The Option 11C system has 50 universal card slots when four expansion cabinets are equipped. The maximum possible number of lines is therefore:

$$50 \text{ cards} \times 16 \text{ units/card} = 800 \text{ lines}$$

Reference Tables 24 through Table 27 are based on models of traffic environments and can be used to determine DTR needs in most cases.

When the system being provisioned does not fall within the bounds of these models or is equipped with any special features, the detailed calculations must be performed for each feature. The number of DTRs must accommodate the highest result.

Some special features are:

- Authorization Code
- Centralized Attendant Service (CAS)
- Charge Account for Call Detail Recording (CDR)
- Direct Inward System Access (DISA)
- Integrated Messaging System Link

From the appropriate reference table (Tables 24 through Table 27), determine the number of DTRs required and the DTR load for cutover, two-year, and five-year intervals. Record this information in Worksheet B on “Worksheet B: Total load” on page 137.

The following models are based on some common PBX traffic measurements.

Model 1

Table 24, “Digitone receiver (DTR) requirements — Model 1,” on page 117 is based on the following factors:

- 33 percent intra-office calls, 33 percent incoming calls, and 33 percent outgoing calls
- 1.5 percent dial tone delay grade of service
- no Digitone DID trunks or incoming Digitone tie trunks

Model 2

Table 25, “Digitone receiver (DTR) requirements — Model 2,” on page 118 is based on the following factors:

- the same traffic pattern as Model 1
- Digitone DID trunks or incoming Digitone tie trunks
- Poisson 0.1 percent blockage grade of service

Model 3

Table 26, “Digitone receiver (DTR) requirements — Model 3,” on page 119 is based on the following factors:

- 15 percent intra-office calls, 28 percent incoming calls, and 56 percent outgoing calls
- 1.5 percent dial tone delay grade of service
- no Digitone DID trunks or incoming Digitone tie trunks

Model 4

Table 27, “Digitone receiver (DTR) requirements — Model 4,” on page 120 is based on the following factors:

- the same traffic pattern as Model 3
- Digitone DID trunks or incoming Digitone tie trunks
- Poisson 0.1 percent blockage grade of service

Detailed calculation: Method 1

This method can be used when there are no incoming Digitone DID trunks and the following is assumed:

- Digitone receiver traffic is inflated by 30 percent to cover unsuccessful dialing attempts.
- Call holding time used in intra-office and outgoing call calculations is 135 seconds if unknown.
- Digitone receiver holding times are 6.2 and 14.1 seconds for intra and outgoing calls respectively.
- Factor $(1 - R) / 2$ in (1) outgoing (incoming calls and outgoing calls are equal). R is the intra-office ratio.

Follow the procedure below for detailed calculation Method 1.

1 Calculate Digitone calls:

Intra-office traffic = $\frac{100 \times \text{Digitone station traffic (CCS)} \times R}{\text{call holding time in seconds } 2}$

Outgoing traffic = $\frac{100 \times \text{Digitone station traffic} \times (1-R)}{\text{call holding time in seconds } 2}$

Calculate total DTR traffic:

Total DTR traffic = $\frac{1.3 \times [(6.2 \times \text{intra}) + (14.1 \times \text{outgoing})]}{100}$

Calculate average holding time:

Average holding time = $\frac{(6.2 \times \text{intra}) + (14.1 \times \text{outgoing})}{(\text{intra calls} + \text{outgoing calls})}$

2 See Tables 22 and 23 and use the answers from steps 2 and 3 to determine the number of DTRs required.

Detailed calculation: Method 2

This method is used when incoming Digitone trunks are included in the system. This method uses the same assumptions as Method 1, with the DTR holding time assumed to be 2.5 seconds for a DID call. Follow the procedure below for detailed calculation Method 2.

- 1 Calculate intra-office and outgoing Digitone calls as shown in step 1 of Method 1:

$$\text{DID calls} = \frac{100 \times \text{Digitone station traffic (in CCS)}}{\text{call holding time in seconds}}$$

- 2 Calculate total DTR traffic:

$$\text{DTR traffic} = \frac{1.3 \times [(6.2 \times \text{intra}) + (14.1 \times \text{outgoing})] + (2.5 \times \text{DID calls})}{100}$$

- 3 See Table 30, “Digitone receiver (DTR) requirements — Poisson 0.1 percent blocking,” on page 126 and use the answer from step 2 to determine the number of DTRs required.

Calculating total system load

Total the line, trunk, console and DTR load for each customer to get the total load figure for each customer, two-year and five-year intervals. Enter this figure into “Worksheet B: Total load” on page 137.

Calculating number of loops required

Loop provisioning is not required with Option 11C since each card is automatically assigned to its own loop. By default, the system is non-blocking.

Each cabinet can house up to 10 Intelligent Peripheral Equipment (IPE) cards.

Each Option 11C Mini chassis can house up to 4 IPE cards.

Calculating number of IPE cards required

Using information from “Worksheet A: Growth forecast” on page 135, enter the number of Meridian Digital Telephone TNs, Analog (500/2500 type) TNs, and trunk TNs required at cutover, two-year, and five-year intervals (for all customers) in “Worksheet C: System cabinet / Main chassis requirements” on page 138.

Divide each entry by the number of TN assignments for each card, round up to the next higher figure, and total the number of cards required.

IPE card slot assignments with IP Expansion

If you are using IP Expansion cabinets, then trunk and line cards may be distributed throughout each of the system cabinets in such a way as to allow for survival operation. The intent is for a cabinet equipped with both trunk and line cards in survival mode to still handle calls.

IPE card slot assignments without IP Expansion

If you are not using IP Expansion cabinets, then trunk and line cards should be placed in the system cabinets in such a way as to allow for future expansion. Line cards are placed in the left hand slots of the cabinets. If the system is using the default numbering plan and consecutive DN numbering is desired, the line cards should be placed one after another leaving no blank slots in between. Trunk cards are placed in the right hand slots of the cabinets.

Plan the card slot assignments so that the trunk and line card growth is towards the middle. For example Figure 6 on page 105 shows the slot assignment plan for systems equipped with two expansion cabinets.

IPE card slot assignments on the Option 11C Mini Main Chassis

Digital trunks cards must be placed in the main chassis. Slot 4 must contain the 48 port DLC. Figure 9 on page 107 shows the typical card slot assignment for the Option 11C Mini Main.

Note: Slot 4 is keyed to prevent accidental insertion of cards other than the 48 port DLC.

IPE card slot assignments on the Option 11C mini chassis expander

Any IPE card may be placed in cards slots 7 through 9. Slot 10 can contain any IPE card or the Meridian Mail Mini. Refer to Figure 10 on page 108.

When planning the number of card slots that will be required in a system, the following items must be considered in addition to IPE card requirements:

- Additional SDI/DCHI/ESDI ports
- Tone Detectors (International only)
- Adding Meridian Mail

Figure 4
Card slot assignment plan: one-cabinet system

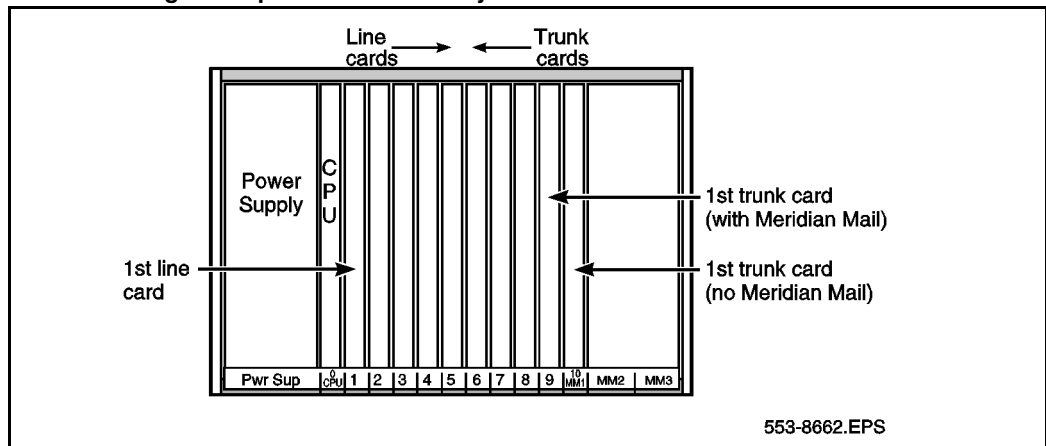

Figure 5
Card slot assignment plan: two-cabinet system without IP expansion.

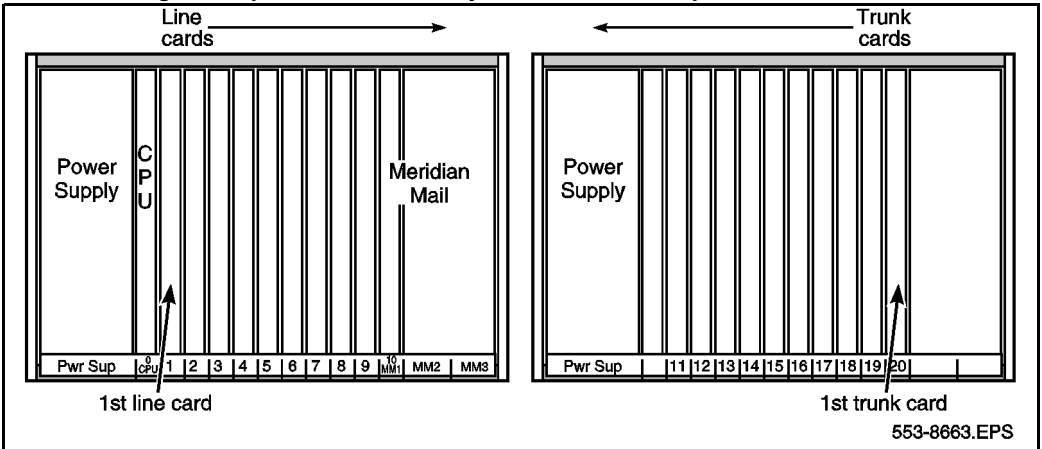

Figure 6
Card slot assignment plan: three-cabinet system without IP expansion

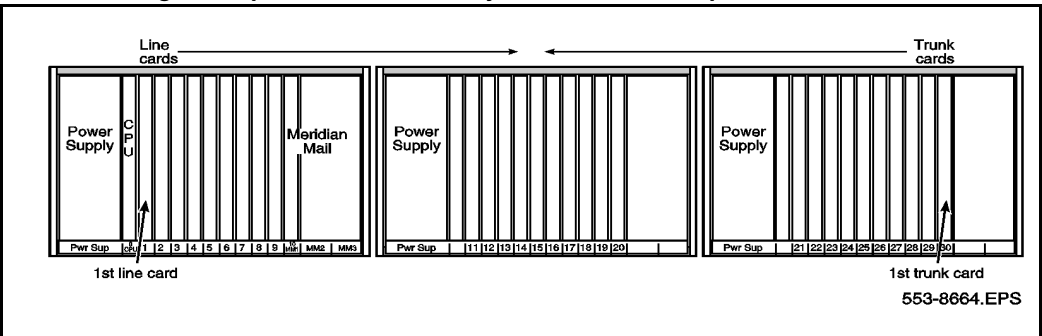

Figure 7
Card slot assignment plan: four-cabinet system without IP expansion

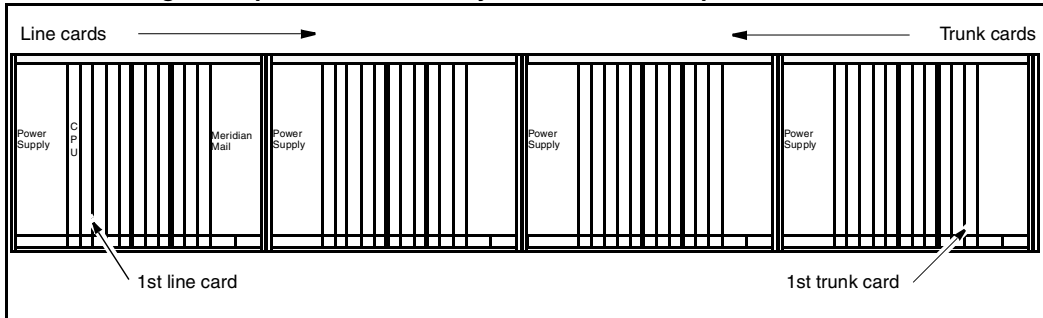

Figure 8
Card slot assignment plan: five-cabinet system without IP expansion

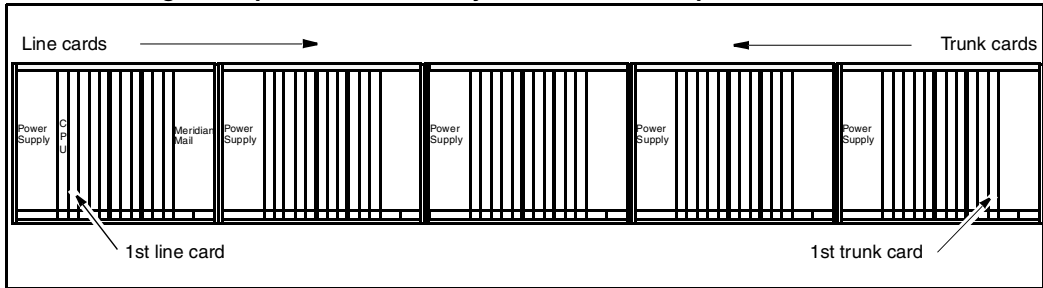

Figure 9
Card slot assignment plan: Option 11C Mini Main Chassis

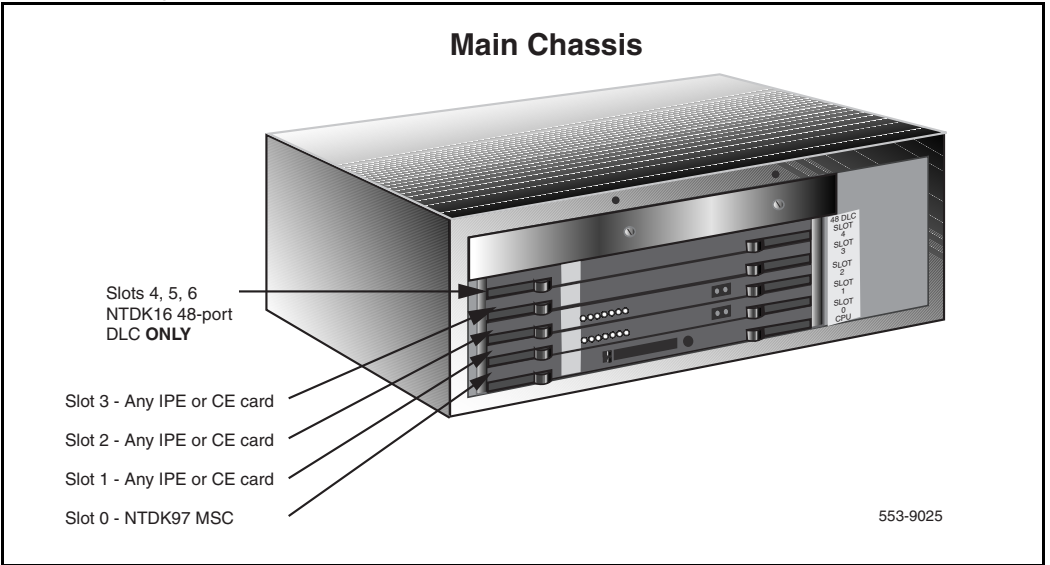
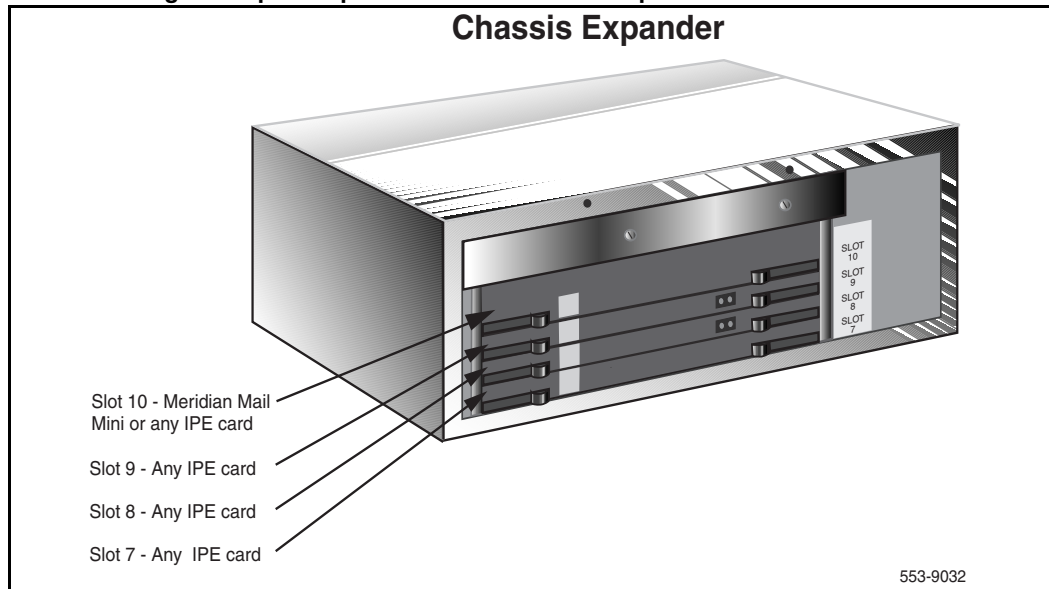

Figure 10
Card slot assignment plan: Option 11C Mini Chassis Expander



Provisioning conference/TDS loops

Conference loops

The Conference function is provided by the NTDK20 Small System Controller (SSC) in Option 11C, and the NTDK97 Mini System Controller (MSC) in Option 11C Mini.

For the Option 11C, each conference loop supports 16 conferees. By default, two conference loops are always active, more becomes active when the expansion cabinets are equipped. Therefore the SSC supports a total of 32 conferees by itself.

Each port on a Fiber Expansion Daughterboard on the Small System Controller supports an additional conference loop for a total of:

- 48 conferees when equipped with one Fiber Expansion Link
- 64 conferees when equipped with two Fiber Expansion Link

- 80 conferees when equipped with three Fiber Expansion Link
- 96 conferees when equipped with four Fiber Expansion Link

For the Option 11C Mini, the MSC provides 16 channels of conferencing with a maximum of six conferees per conference call on conference loop 29. This allows for up to five simultaneous three-party conferences and up to two simultaneous six-party conferences.

TDS loops

Option 11C has been engineered such that a single SSC card, SSC, or MSC, with 30 channels of TDS. This should be enough to meet all TDS requirements.

To illustrate this point, two examples are given below.

Example 1

Option 11C configured with two expansion cabinets provides 30 slots for trunk and line cards.

The SSC card can support 7260 CCS of call traffic. A digital line card supports 16 units per card. A Universal trunk card supports 8 units per card.

The CCS per card would be:

Digital Line card 16 Units/card x 6 CCS/Unit = 96 CCS/card

Universal trunk card 8 units/card x 22 CCS/Unit = 176 CCS/card

Assume the following:

- An average station generates 6 CCS of traffic
- A 20 percent trunking ratio
- An average trunk generates 22 CCS of traffic.

The 30 card slots available can support a system configuration of 384 lines (24 line cards) and 48 trunks (6 trunk cards). The total CCS for this configuration will be:

$$\begin{aligned}\text{Total CCS: } & (24 \text{ line cards} \times 96 \text{ CCS/card}) + (6 \text{ trunk cards} \times 176 \text{ CCS/card}) \\ & = 2304 \text{ CCS} + 1056 \text{ CCS} \\ & = 3360 \text{ CCS}\end{aligned}$$

If the number you receive is greater than one, you can add an NTAK03 TDS/DTR card to the system.

Example 2

A system that is more heavily trunked, say a one to one ratio, can support a configuration of 192 lines (12 line cards) and 144 trunks (18 trunk cards):

$$\begin{aligned}\text{Total CCS: } & 12 \text{ line cards} \times 96 \text{ CCS/card} + 18 \text{ trunk cards} \times 176 \text{ CCS/card} \\ & = 1152 \text{ CCS} + 3168 \text{ CCS} \\ & = 4320 \text{ CCS}\end{aligned}$$

The SSC card, at 7260 CCS, still provides plenty of TDS capability.

Calculating memory requirements

Use “Worksheet D: Unprotected memory calculations” on page 141 and “Worksheet E: Protected memory calculations” on page 142 to calculate memory requirements. Use the two-year figure for telephones, consoles, and trunks for the calculation. Add 10 percent to the total memory requirements.

Assigning equipment and preparing equipment summary

Use “Worksheet F: Equipment summary” on page 143 to record the equipment requirements for the complete system at cutover. Assign the equipment. The equipment summary may have to be updated as a result of assignment procedures. Use the finalized equipment summary to order the equipment for the system.

Calculating battery backup time

Use this procedure to determine:

- system power consumption
- battery current for customer-provided DC reserve power

- battery backup time for the NTAK75
- battery backup time for the NTAK76

Use the circuit-card power-consumption table and worksheets provided below.

Procedure

- 1 Determine the circuit card configuration in each system cabinet. Record the card codes against their cabinet slot numbers, on “Worksheet Ga: System power consumption: Main cabinet” on page 146 through “Worksheet Ge: System power consumption: fourth expansion cabinet” on page 150.
- 2 For each circuit card, transfer the power consumption values from “Worksheet G: System power consumption” on page 144 to the power-consumption column on the corresponding Worksheets Ga - Ge.
- 3 Calculate the total option 11C system power consumption on “Worksheet Gf: Total Option 11C system power consumption” on page 151.
- 4 If your system is AC-powered, go to “Worksheet H: Battery current and AC line calculation for AC systems using NTAK75 and NTAK76” on page 153. If your system is DC-powered, go to “Worksheet I: Battery current calculation for customer-provided DC reserve power” on page 154.
- 5 Transfer the P_{out} (Main) and P_{out} (Expan.) values from Worksheet G to Worksheet H or I.
- 6 Calculate P_{in} (Main), I_{Batt} (Main), P_{in} (Expan), and I_{Batt} (Expan) as shown on Worksheet H or I.
- 7 Calculate I_{line} if required, as shown on Worksheet H.
- 8 Transfer the values calculated for I_{Batt} (Main) and I_{Batt} (Expan), onto the NTAK75/QBL24A1 and the NTAK76 discharge time graphs.
- 9 Select the battery unit that provides the most appropriate backup time.

Note: For customer-provided DC reserve power systems, use I_{Batt} (Main) and I_{Batt} (Expan) along with the battery manufacturer’s specifications to determine battery requirements and backup times.

Table 22
Trunk traffic — Poisson 1 percent blocking (Part 1 of 3)

Trunks	CCS	Trunks	CCS	Trunks	CCS
1	0.4	25	535	49	1231
2	5.4	26	562	50	1261
3	15.7	27	590	51	1291
4	29.6	28	618	52	1322
5	46.1	29	647	53	1352
6	64	30	675	54	1382
7	84	31	703	55	1412
8	105	32	732	56	1443
9	126	33	760	57	1473
10	149	34	789	58	1504
11	172	35	818	59	1534
12	195	36	847	60	1565
13	220	37	876	61	1595
14	244	38	905	62	1626
15	269	39	935	63	1657
16	294	40	964	64	1687
17	320	41	993	65	1718
18	346	42	1023	66	1749
19	373	43	1052	67	1780
20	399	44	1082	68	1811
21	426	45	1112	69	1842

Table 22
Trunk traffic — Poisson 1 percent blocking (Part 2 of 3)

Trunks	CCS	Trunks	CCS	Trunks	CCS
22	453	46	1142	70	1873
23	480	47	1171	71	1904
24	507	48	1201	72	1935
73	1966	97	2721	121	3488
74	1997	98	2752	122	3520
75	2028	99	2784	123	3552
76	2059	100	2816	124	3594
77	2091	101	2874	125	3616
78	2122	102	2879	126	3648
79	2153	103	2910	127	3681
80	2184	104	2942	128	3713
81	2215	105	2974	129	3746
82	2247	106	3006	130	3778
83	2278	107	3038	131	3810
84	2310	108	3070	132	3843
85	2341	109	3102	133	3875
86	2373	110	3135	134	3907
87	2404	111	3166	135	3939
88	2436	112	3198	136	3972

Table 22
Trunk traffic — Poisson 1 percent blocking (Part 3 of 3)

Trunks	CCS	Trunks	CCS	Trunks	CCS
89	2467	113	3230	137	4004
90	2499	114	3262	138	4037
91	2530	115	3294	139	4070
92	2563	116	3326	140	4102
93	2594	117	3359	141	4134
94	2625	118	3391	142	4167
95	2657	119	3424	143	4199
96	2689	120	3456	144	4231
145	4264	147	4329	149	4395
146	4297	148	4362	150	4427

Table 23
Trunk traffic — Poisson 2 percent blocking (Part 1 of 3)

Trunks	CCS	Trunks	CCS	Trunks	CCS
1	4	25	571	49	1268
2	7.9	26	562	50	1317
3	20.9	27	627	51	1348
4	36.7	28	656	52	1374
5	55.8	29	685	53	1352
6	76.0	30	715	54	1441
7	96.8	31	744	55	1472
8	119	32	773	56	1503
9	142	33	803	57	1534

Table 23
Trunk traffic — Poisson 2 percent blocking (Part 2 of 3)

Trunks	CCS	Trunks	CCS	Trunks	CCS
10	166	34	832	58	1565
11	191	35	862	59	1596
12	216	36	892	60	1627
13	241	37	922	61	1659
14	267	38	952	62	1690
15	293	39	982	63	1722
16	320	40	1012	64	1752
17	347	41	1042	65	1784
18	374	42	1072	66	1816
19	401	43	1103	67	1817
20	429	44	1133	68	1878
21	458	45	1164	69	1910
22	486	46	1194	70	1941
23	514	47	1125	71	1973
24	542	48	1255	72	2004
73	2036	97	2803	121	3581
74	2067	98	2838	122	3614
75	2099	99	2868	123	3647
76	2130	100	2900	124	3679
77	2162	101	2931	125	3712
78	2194	102	2964	126	3745
79	2226	103	2996	127	3777

Table 23
Trunk traffic — Poisson 2 percent blocking (Part 3 of 3)

Trunks	CCS	Trunks	CCS	Trunks	CCS
80	2258	104	3029	128	3810
81	2290	105	3051	129	3843
82	2322	106	3094	130	3875
83	2354	107	3126	131	3908
84	2368	108	3158	132	3941
85	2418	109	3190	133	3974
86	2450	110	3223	134	4007
87	2482	111	3255	135	4039
88	2514	112	3288	136	4072
89	3546	113	3321	137	4105
90	2578	114	3353	138	4138
91	2611	115	3386	139	4171
92	2643	116	3418	140	4204
93	2674	117	3451	141	4237
94	2706	118	3483	142	4270
95	2739	119	3516	143	4302
96	2771	120	3548	144	4335
145	4368	147	4434	149	4500
146	4401	148	4467	150	4533

Table 24
Digitone receiver (DTR) requirements — Model 1

Number of DTRs	Max. number of Digitone lines	DTR load (CCS)
2	7	2
3	33	9
4	69	19
5	120	33
6	179	49
7	249	68
8	332	88
9	399	109
10	479	131
11	564	154
12	659	178
13	751	203
14	848	229
15	944	255
16	1044	282

Note: See Calculating Digitone receiver requirements on page 99 for Model 1 assumptions.

Table 25
Digitone receiver (DTR) requirements — Model 2

Number of DTRs	Max. number of Digitone lines	DTR load (CCS)
2	2	2
3	21	7
4	52	15
5	90	27
6	134	40
7	183	55
8	235	71
9	293	88
10	353	107
11	416	126
12	483	145
13	553	166
14	623	187
15	693	208
16	770	231

Note: See Calculating Digitone receiver requirements on page 99 for Model 2 assumptions.

Table 26
Digitone receiver (DTR) requirements — Model 3

Number of DTRs	Max. number of Digitone lines	DTR load (CCS)
2	5	2
3	22	9
4	50	19
5	87	33
6	132	49
7	180	68
8	234	88
9	291	109
10	353	131
11	415	154
12	481	178
13	548	203
14	618	229
15	689	255
16	762	282
Note: See Calculating Digitone receiver requirements on page 99 for Model 3 assumptions.		

Table 27
Digitone receiver (DTR) requirements — Model 4

Number of DTRs	Max. number of Digitone lines	DTR load (CCS)
2	4	2
3	18	7
4	41	15
5	72	27
6	109	40
7	148	55
8	193	71
9	240	88
10	291	107
11	340	126
12	391	145
13	448	166
14	505	187
15	562	208
16	624	231

Note: See Calculating Digitone receiver requirements on page 99 for Model 4 assumptions.

Table 28
Digitone receiver (DTR) load capacity — 6 to 15 second holding time (Part 1 of 3)

Average holding time in seconds	6	7	8	9	10	11	12	13	14	15
Number of DTR's										
1	0	0	0	0	0	0	0	0	0	0
2	3	2	2	2	2	2	2	2	2	2
3	11	10	10	9	9	9	9	8	8	8
4	24	23	22	21	20	19	19	19	18	18
5	41	39	37	36	35	34	33	33	32	32
6	61	57	55	53	52	50	49	49	48	47
7	83	78	75	73	71	69	68	67	66	65
8	106	101	91	94	91	89	88	86	85	84
9	131	125	120	116	113	111	109	107	106	104
10	157	150	144	140	136	133	131	129	127	126
11	185	176	170	165	161	157	154	152	150	148
12	212	203	196	190	185	182	178	176	173	171
13	241	231	223	216	211	207	203	200	198	196
14	270	259	250	243	237	233	229	225	223	220
15	300	288	278	271	264	259	255	251	248	245
16	339	317	307	298	292	286	282	278	274	271
17	361	346	335	327	310	313	319	306	302	298
18	391	377	365	356	348	342	336	331	327	324

Table 28
Digitone receiver (DTR) load capacity — 6 to 15 second holding time (Part 2 of 3)

Average holding time in seconds	6	7	8	9	10	11	12	13	14	15
Number of DTR's										
19	422	409	396	386	378	371	364	359	355	351
20	454	438	425	414	405	398	393	388	383	379
21	487	469	455	444	435	427	420	415	410	406
22	517	501	487	475	466	456	449	443	438	434
23	550	531	516	504	494	487	479	472	467	562
24	583	563	547	535	524	515	509	502	497	491
25	615	595	579	566	555	545	537	532	526	521
26	647	628	612	598	586	576	567	560	554	548
27	680	659	642	628	618	607	597	589	583	577
28	714	691	674	659	647	638	628	620	613	607
29	746	724	706	690	678	667	659	651	644	637
30	779	758	738	723	709	698	690	682	674	668
31	813	792	771	755	742	729	719	710	703	696
32	847	822	805	788	774	761	750	741	733	726
33	882	855	835	818	804	793	781	772	763	756
34	913	889	868	850	836	825	812	803	795	787
35	947	923	900	883	867	855	844	835	826	818
36	981	957	934	916	900	886	876	866	857	850

Table 28
Digitone receiver (DTR) load capacity — 6 to 15 second holding time (Part 3 of 3)

Average holding time in seconds	6	7	8	9	10	11	12	13	14	15
Number of DTR's										
37	1016	989	967	949	933	919	909	898	889	881
38	1051	1022	1001	982	966	951	938	928	918	912
39	1083	1055	1035	1015	999	984	970	959	949	941
40	1117	1089	1066	1046	1029	1017	1002	990	981	972

Note: Load capacity is measured in CCS.

Table 29
Digitone receiver (DTR) load capacity — 16 to 25 second holding time (Part 1 of 3)

Average holding time in seconds	16	17	18	19	20	21	22	23	24	25
Number of DTRs										
1	0	0	0	0	0	0	0	0	0	0
2	2	2	2	2	2	2	2	2	2	2
3	8	8	8	8	8	8	8	8	8	8
4	18	18	18	18	18	17	17	17	17	17
5	31	31	31	30	30	30	30	30	30	29
6	47	46	46	45	45	45	45	44	44	44
7	64	63	63	62	62	62	61	61	61	60

Table 29
Digitone receiver (DTR) load capacity — 16 to 25 second holding time (Part 2 of 3)

Average holding time in seconds	16	17	18	19	20	21	22	23	24	25
Number of DTRs										
8	83	82	82	81	80	80	79	79	79	78
9	103	102	101	100	100	99	99	98	98	97
10	125	123	122	121	121	120	119	119	118	118
11	147	145	144	143	142	141	140	140	139	138
12	170	168	167	166	165	164	163	162	161	160
13	193	192	190	189	188	186	185	184	184	183
14	218	216	214	213	211	210	209	208	207	206
15	243	241	239	237	236	234	233	232	231	230
16	268	266	264	262	260	259	257	256	255	254
17	294	292	290	288	286	284	283	281	280	279
18	322	319	317	314	312	311	309	308	306	305
19	347	344	342	339	337	335	334	332	331	329
20	374	371	368	366	364	361	360	358	356	355
21	402	399	396	393	391	388	386	385	383	381
22	431	427	424	421	419	416	414	412	410	409
23	458	454	451	448	445	442	440	438	436	434
24	486	482	478	475	472	470	467	465	463	461
25	514	510	506	503	500	497	495	492	490	488
26	544	539	535	532	529	526	523	521	518	516

Table 29
Digitone receiver (DTR) load capacity — 16 to 25 second holding time (Part 3 of 3)

Average holding time in seconds	16	17	18	19	20	21	22	23	24	25
27	573	569	565	561	558	555	552	549	547	545
28	603	598	594	590	587	584	581	578	576	573
29	631	626	622	618	614	611	608	605	602	600
30	660	655	651	646	643	639	636	633	631	628
31	690	685	680	676	672	668	665	662	659	656
32	720	715	710	705	701	698	694	691	688	686
33	751	745	740	735	731	727	724	721	718	715
34	782	776	771	766	761	757	754	750	747	744
35	813	807	801	796	792	788	784	780	777	774
36	841	835	829	824	820	818	814	810	807	804
37	872	865	859	854	849	845	841	837	834	831
38	902	896	890	884	879	875	871	867	863	860
39	934	927	921	914	909	905	901	897	893	890
40	965	952	952	945	940	936	931	927	923	920
Note: Load capacity is measured in CCS.										

Table 30
Digitone receiver (DTR) requirements — Poisson 0.1 percent blocking (Part 1 of 2)

Number of DTRs	DTR load (CCS)	Number of DTRs	DTR load (CCS)
1	0	26	469
2	2	27	495
3	7	28	520
4	15	29	545
5	27	30	571
6	40	31	597
7	55	32	624
8	71	33	650
9	88	34	676
10	107	35	703
11	126	36	729
12	145	37	756
13	166	38	783
14	187	39	810
15	208	40	837
16	231	41	865
17	253	42	892

Table 30
Digitone receiver (DTR) requirements — Poisson 0.1 percent blocking (Part 2 of 2)

Number of DTRs	DTR load (CCS)	Number of DTRs	DTR load (CCS)
18	276	43	919
19	299	44	947
20	323	45	975
21	346	46	1003
22	370	47	1030
23	395	48	1058
24	419	49	1086
25	444	50	1115

Table 31
Digitone receiver (DTR) load capacity — 16 to 25 second holding time (Part 1 of 3)

Average holding time in seconds	16	17	18	19	20	21	22	23	24	25
Number of DTRs										
1	0	0	0	0	0	0	0	0	0	0
2	2	2	2	2	2	2	2	2	2	2
3	8	8	8	8	8	8	8	8	8	8
4	18	18	18	18	18	17	17	17	17	17
5	31	31	31	30	30	30	30	30	30	29
6	47	46	46	45	45	45	45	44	44	44
7	64	63	63	62	62	62	61	61	61	60

Table 31
Digitone receiver (DTR) load capacity — 16 to 25 second holding time (Part 2 of 3)

Average holding time in seconds	16	17	18	19	20	21	22	23	24	25
Number of DTRs										
8	83	82	82	81	80	80	79	79	79	78
9	103	102	101	100	100	99	99	98	98	97
10	125	123	122	121	121	120	119	119	118	118
11	147	145	144	143	142	141	140	140	139	138
12	170	168	167	166	165	164	163	162	161	160
13	193	192	190	189	188	186	185	184	184	183
14	218	216	214	213	211	210	209	208	207	206
15	243	241	239	237	236	234	233	232	231	230
16	268	266	264	262	260	259	257	256	255	254
17	294	292	290	288	286	284	283	281	280	279
18	322	319	317	314	312	311	309	308	306	305
19	347	344	342	339	337	335	334	332	331	329
20	374	371	368	366	364	361	360	358	356	355
21	402	399	396	393	391	388	386	385	383	381
22	431	427	424	421	419	416	414	412	410	409
23	458	454	451	448	445	442	440	438	436	434
24	486	482	478	475	472	470	467	465	463	461
25	514	510	506	503	500	497	495	492	490	488
26	544	539	535	532	529	526	523	521	518	516

Table 31
Digitone receiver (DTR) load capacity — 16 to 25 second holding time (Part 3 of 3)

Average holding time in seconds	16	17	18	19	20	21	22	23	24	25
27	573	569	565	561	558	555	552	549	547	545
28	603	598	594	590	587	584	581	578	576	573
29	631	626	622	618	614	611	608	605	602	600
30	660	655	651	646	643	639	636	633	631	628
31	690	685	680	676	672	668	665	662	659	656
32	720	715	710	705	701	698	694	691	688	686
33	751	745	740	735	731	727	724	721	718	715
34	782	776	771	766	761	757	754	750	747	744
35	813	807	801	796	792	788	784	780	777	774
36	841	835	829	824	820	818	814	810	807	804
37	872	865	859	854	849	845	841	837	834	831
38	902	896	890	884	879	875	871	867	863	860
39	934	927	921	914	909	905	901	897	893	890
40	965	952	952	945	940	936	931	927	923	920
Note: Load capacity is measured in CCS.										

Table 32
Digitone receiver (DTR) requirements — Poisson 0.1 percent blocking (Part 1 of 2)

Number of DTRs	DTR load (CCS)	Number of DTRs	DTR load (CCS)
1	0	26	469
2	2	27	495
3	7	28	520
4	15	29	545
5	27	30	571
6	40	31	597
7	55	32	624
8	71	33	650
9	88	34	676
10	107	35	703
11	126	36	729
12	145	37	756
13	166	38	783
14	187	39	810
15	208	40	837
16	231	41	865
17	253	42	892

Table 32
Digitone receiver (DTR) requirements — Poisson 0.1 percent blocking (Part 2 of 2)

Number of DTRs	DTR load (CCS)	Number of DTRs	DTR load (CCS)
18	276	43	919
19	299	44	947
20	323	45	975
21	346	46	1003
22	370	47	1030
23	395	48	1058
24	419	49	1086
25	444	50	1115

Table 33
Conference and TDS loop requirements

Network loops required at 2 years	TDS loops required	Conference loops required
1 - 12	1	1
13 - 24	2	2
25 - 36	3	3
37 - 48	4	4
49 - 60	5	5
61 - 72	6	6
73 - 84	7	7
85 - 96	8	8
97 - 108	9	9
109 - 120	10	10

Table 34
Digitone receiver provisioning (Part 1 of 3)

DTR CCS	DTR ports	DTR CCS	DTR ports
1-2	2	730-761	32
3-9	3	762-793	33
10-19	4	794-825	34
20-34	5	826-856	35
35-50	6	857-887	36
51-69	7	888-919	37
70-89	8	920-951	38
90-111	9	952-984	39
112-133	10	985-1017	40
134-157	11	1018-1050	41
158-182	12	1051-1084	42
183-207	13	1085-1118	43
208-233	14	1119-1153	44
234-259	15	1154-1188	45
260-286	16	1189-1223	46
287-313	17	1224-1258	47
314-342	18	1259-1293	48
343-371	19	1294-1329	49
372-398	20	1330-1365	50
399-427	21	1366-1400	51
428-456	22	1401-1435	52

Table 34
Digitone receiver provisioning (Part 2 of 3)

DTR CCS	DTR ports	DTR CCS	DTR ports
457-487	23	1436-1470	53
488-515	24	1471-1505	54
516-545	25	1506-1540	55
546-576	26	1541-1575	56
577-607	27	1576-1610	57
608-638	28	1611-1645	58
639-667	29	1646-1680	59
668-698	30	1681-1715	60
699-729	31	1716-1750	61
1751-1785	62	2871-2905	94
1786-1820	63	2906-2940	95
1821-1855	64	2941-2975	96
1856-1890	65	2976-3010	97
1891-1925	66	3011-3045	98
1926-1960	67	3046-3080	99
1961-1995	68	3081-3115	100
1996-2030	69	3116-3465	101
2031-2065	70		
2066-2100	71		
2101-2135	72		
2136-2170	73		
2171-2205	74		

Table 34
Digitone receiver provisioning (Part 3 of 3)

DTR CCS	DTR ports	DTR CCS	DTR ports
2206-2240	75		
2241-2275	76		
2276-2310	77		
2311-2345	78		
2346-2380	79		
2381-2415	80		
2416-2450	81		
2451-2485	82		
2486-2520	83		
2521-2555	84		
2556-2590	85		
2591-2625	86		
2626-2660	87		
2661-2695	88		
2696-2730	89		
2731-2765	90		
2766-2800	91		
2801-2835	92		
2836-2870	93		

Note: Provisioning assumes an 11 second holding time.

Worksheet A: Growth forecast

Customer: _____

Date: _____

Prepare one worksheet for each customer and one worksheet for the complete system.

Stations	Cutover	2 years	5 years	CCS/T
Meridian Digital Telephones				
Meridian Digital Telephone TNs				
500 telephones				
500 TNs				
2500 telephones				
2500 TNs				
2-way				
1-way in				
1-way out				
DID				
Tie				
CCSA				
InWATS				
OutWATS				
FX				
Private line				

Stations	Cutover	2 years	5 years	CCS/T
Dial dictation				
Paging				
RAN				
AIOD				
DTI				
E&M 2W				
E&M 4W				
CO				

Line CCS/T _____

Total trunk CCS/T _____

Intra CCS/T _____

Worksheet B: Total load

Customer: _____

Date: _____

Prepare one worksheet for each customer for cutover, 2-year, and 5-year intervals, and one worksheet for the system for cutover, 2-year, and 5-year intervals.

Line usage

Meridian Digital sets: TN _____ x _____ CCS/T = _____ CCS

500: TN _____ x _____ CCS/T = _____ CCS

2500: TN _____ x _____ CCS/T = _____ CCS

Total line load = _____ CCS

Trunk usage

Number of TNs CCS/T per Total CCS load

Trunk route accessing route trunk route per trunk route

_____ x _____ = _____ CCS

_____ x _____ = _____ CCS

_____ x _____ = _____ CCS

_____ x _____ = _____ CCS

_____ x _____ = _____ CCS

_____ x _____ = _____ CCS

Total trunk load = _____ CCS

Console usage

Number of consoles _____ x 30 CCS

= Total console load = _____ CCS

Digitone receivers

Number of DTRs (from tables) _____

= Total DTR load = _____ CCS

= Total load = _____ CCS

Worksheet C: System cabinet / Main chassis requirements

Customer: _____

Date: _____

Prepare one worksheet for the complete system at cutover, 2-year, and 5-year intervals.

IPE card calculations

	Cutover	2 years	5 years
Number of digital line cards = <u>number of digital ports (M2250 uses 2 ports)</u> 16			
Number of analog line cards = <u>number of analog ports in service</u> 16			
Number of analog waiting line cards = <u>number of analog ports with message waiting</u> 16			
Number of universal trunk cards = <u>total number of CO/DID/RAN/paging trunks</u> 8			
Number of E&M trunk cards = <u>total number of E&M/paging/dictation trunks</u> 4			
Total cards			
<p>Note: For higher reliability, do not configure more than one M2250 console on one digital line card. Use paging trunks on universal trunk cards or E&M trunk cards, depending on what combination minimizes the total number of trunk cards required.</p>			

**Worksheet C: System cabinet / Main chassis requirements
(continued)**

To determine the number of chassis required for Option 11C, go to “Option 11C Mini Calculations” on page 140. To determine the number of cabinets required for Option 11C, follow the guidelines below:

Option 11C Calculations without Meridian Mail

The first cabinet provides a total of 9 slots for trunk and line cards:

Number of IPE cards	Number of cabinets required (maximum 5 cabinets)
1-9	1
10-19	2
20-29	3
30-39	4
40-49	5

For systems requiring SDI/DCH cards, subtract one available card slot from the first cabinet for each additional SDI/DCH card required.

Option 11C Calculations with Meridian Mail

Subtract one available card slot from the first cabinet:

Number of IPE cards	Number of cabinets required (maximum 5 cabinets)
1-8	1
9-18	2
19-28	3
29-38	4
39-48	5

Option 11C Mini Calculations

The main chassis provides a total of 3 locations for trunk and line cards, with the chassis expander providing 4 additional locations:

Number of IPE cards	Number of chassis required (maximum 2 chassis)
1-3	1
4-7 ^a	2

a. If you are adding a Meridian Mail Mini card, it must be located in slot 10 of the chassis expander, which reduces the maximum number of IPE cards to 6.

For systems requiring extra TDS/DTR or SDI/DCH cards, subtract one available card slot from the main chassis for each additional TDS/DTR or SDI/DCH card required.

Number of chassis required: _____

Worksheet D: Unprotected memory calculations

Customer: _____

Date: _____

Prepare one worksheet for the complete system.

	Items	Words	Total
Fixed amount of storage required			
500 and 2500 TNs			
Add-on modules			
Network groups	2		
Trunk units			
Consoles			
Customer groups			
Network loops	30		
Peripheral Signalling	2		
Trunk routes			
SDI cards			
TDS loops			
Conference loops	3		
DTR loops			
Call registers			
Low priority input buffers			
High priority input buffers			

Total from table _____

Total words from table _____

Capacity _____ **64** ___ k words (k = 1024 words)

Worksheet E: Protected memory calculations

Customer: _____

Date: _____

Prepare one worksheet for the complete system.

	Items	Words	Total
Fixed amount of storage required			
500 and 2500 TNs			
Add-on modules			
Trunk units			
Consoles			
Customer groups			
Trunk routes			
Code restricted trunk routes			
DTR loops (in excess on 1)			
Speed call head table			
Speed call lists (10 numbers)			
Speed call lists (50 numbers)			
TDS loops (in excess of 1)			
History file			
Note: Record totals on the next page.			

Total from table _____

Add 10% _____

Total words from table _____

Capacity _____ **64** _____ k words (k = 1024 words)

Worksheet F: Equipment summary

Customer: _____

Date: _____

Prepare one worksheet for the complete system.

Equipment summary	Quantity	Based on
Line and trunk cards		Cutover
DTRs		2 years
TDS loops		2 years
Call registers		2 years
High priority input buffers		Cutover
Low priority input buffers		Cutover
System cabinets		2 years

Worksheet G: System power consumption

For Option 11C Mini, go to Worksheet Gg: Option 11C Mini power consumption: Main chassis on page 151.

Table 35
Circuit Card Power Consumption (Part 1 of 2)

Circuit card	Type	% active sets (off-hook)	Power consumption
Mail	Meridian Mail	steady state	35W
NT1R20	Off premise Station analog line card	50%	22W
NT6R16	Meridian Mail Mini	steady state	35W
NT5D26	EXUT Card for ASia Pacific	DID-enabled	28W
NT8D02	Digital line card	100%	25W
NT9D09	Message-waiting line card	50%	26W
NT8D14	Universal trunk card	DID-enabled	28W
NT8D15	E&M trunk card	N/A	29W
NT5K07	Universal Trunk Card	DID-enabled	28W
NT5K19	Extended E&M trunk card	N/A	29W
NT5K82	XCOT Card for Switzerland	DID-enabled	28W
NT5K83	XFEM trunk card for Switzerland	N/A	29W
NTAK02	SDI/DCH card	N/A	10W
NTAK03	TDS/DTR card	N/A	8W
NTAK09	1.5Mb DTI/PRI card	N/A	10W
NTAK10	2.0Mb DTI card	N/A	12W
NTAK79	2.0Mb PRI card	N/A	12W
NTBK22	MISP card	N/A	12W
NTBK50	2.0Mb PRI card	N/A	12W

Table 35
Circuit Card Power Consumption (Part 2 of 2)

Circuit card	Type	% active sets (off-hook)	Power consumption
NTCK16BC	XFCDD Card	DID-enabled	28W
NTDK16	48 port Digital Line Card (Option 11C Mini)	100%	75w
NTDK20	SSC card (Option 11C)	N/A	15w
NTDK22	10 m Fiber Daughterboard (Option 11C)	N/A	3W
NTDK23	10 m Receiver card (Option 11C)	N/A	3W
NTDK24	3 km Fiber Daughterboard (Option 11C)	N/A	3W
NTDK25	3 km Receiver card (Option 11C)	N/A	3W
NTDK26	Upgrades Daughterboard (Option 11C)	N/A	2W
NTDK79	3 km Fiber Daughterboard (Option 11C)	N/A	3W
NTDK80	3 km Receiver card (Option 11C)	N/A	3W
NTDK85	Dual Fiber Daughterboard (Option 11C)	N/A	7.5W
NTDK97	Mini System Controller (Option 11C Mini)	N/A	15 w
NTRB21	1.5mb TMDI	N/A	12W

Worksheet Ga: System power consumption: Main cabinet

Slot	Circuit card	Type	Power consumption from Table 35
0			
1			
2			
3			
4			
5			
6			
7			
8			
9			
10			
		Total	

Worksheet Gb: System power consumption: first expansion cabinet

Slot	Circuit card	Type	Power consumption from Table 35
11			
12			
13			
14			
15			
16			
17			
18			
19			
20			
		Total	

Worksheet Gc: System power consumption: second expansion cabinet

Slot	Circuit card	Type	Power consumption from Table 35
21			
22			
23			
24			
25			
26			
27			
28			
29			
30			
		Total	

Worksheet Gd: System power consumption: third expansion cabinet

Slot	Circuit card	Type	Power consumption from Table 35
31			
32			
33			
34			
35			
36			
37			
38			
39			
40			
		Total	

Worksheet Ge: System power consumption: fourth expansion cabinet

Slot	Circuit card	Type	Power consumption from Table 35
41			
42			
43			
44			
45			
46			
47			
48			
49			
50			
		Total	

Worksheet Gf: Total Option 11C system power consumption

<i>Pout</i> Main (total for slots 1-10 in main cabinet)	
<i>Pout</i> Expan (total for slots 11-20 in the first expansion cabinet)	
<i>Pout</i> Expan (total for slots 21-30 in the second expansion cabinet)	
<i>Pout</i> Expan (total for slots 31-40 in the third expansion cabinet)	
<i>Pout</i> Expan (total for slots 41-50 in the fourth expansion cabinet)	
Total	

Worksheet Gg: Option 11C Mini power consumption: Main chassis

Slot	Circuit card	Type	Power consumption from Table 35
1	NTDK97	MSC	15 w
2			
3			
4, 5, 6	NTDK16	48 port DLC	75w
		Total	

Worksheet Gh: Option 11C Mini power consumption: Chassis expander

Slot	Circuit card	Type	Power consumption from Table 35
7			
8			
9			
10			
Total			

Note: For an IP Expansion system use the Option 11C Worksheets.

Worksheet Gi: Total Option 11C Mini system power consumption

<i>Pout</i> Main (total for slots 1-6 in main chassis)	
<i>Pout</i> Expan (total for slots 7-10 in the chassis expander)	
Total	

Worksheet H: Battery current and AC line calculation for AC systems using NTAK75 and NTAK76

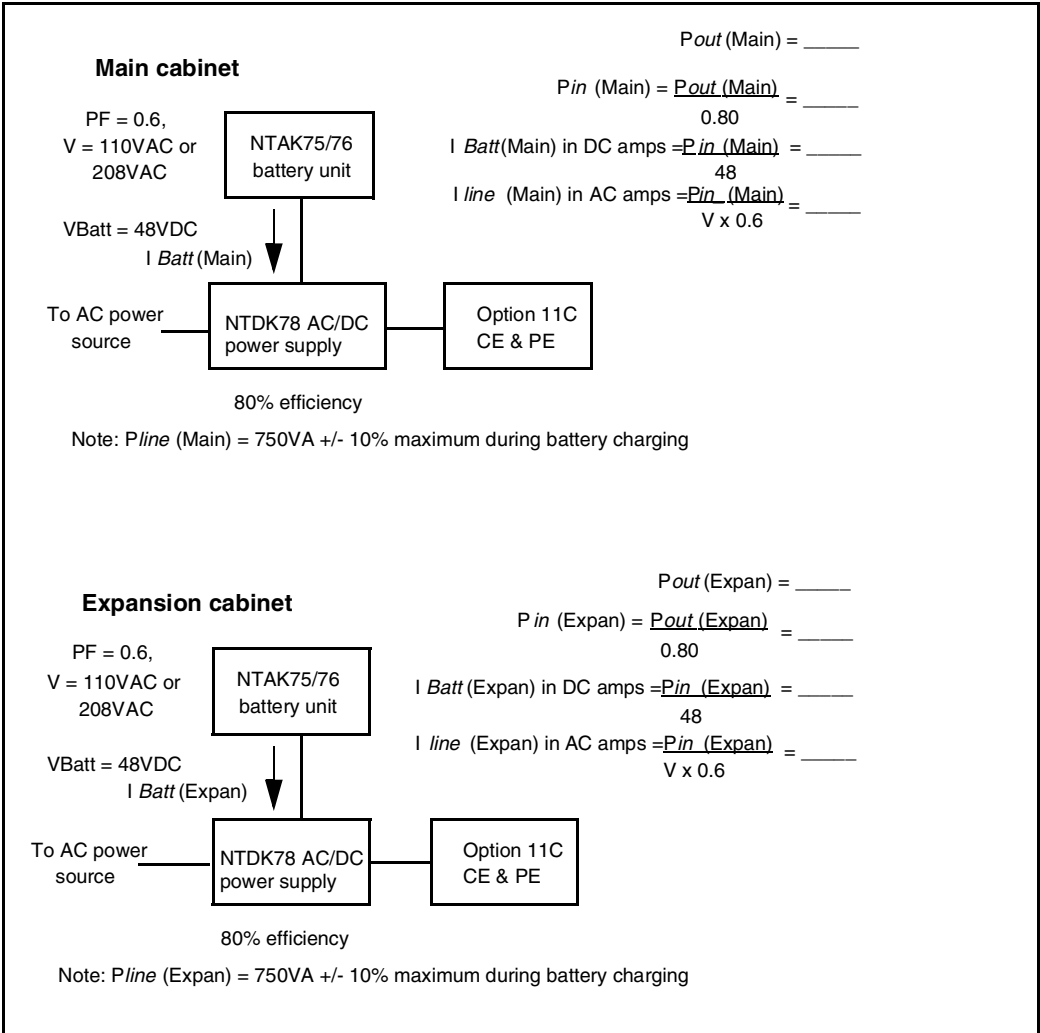

Worksheet I: Battery current calculation for customer-provided DC reserve power

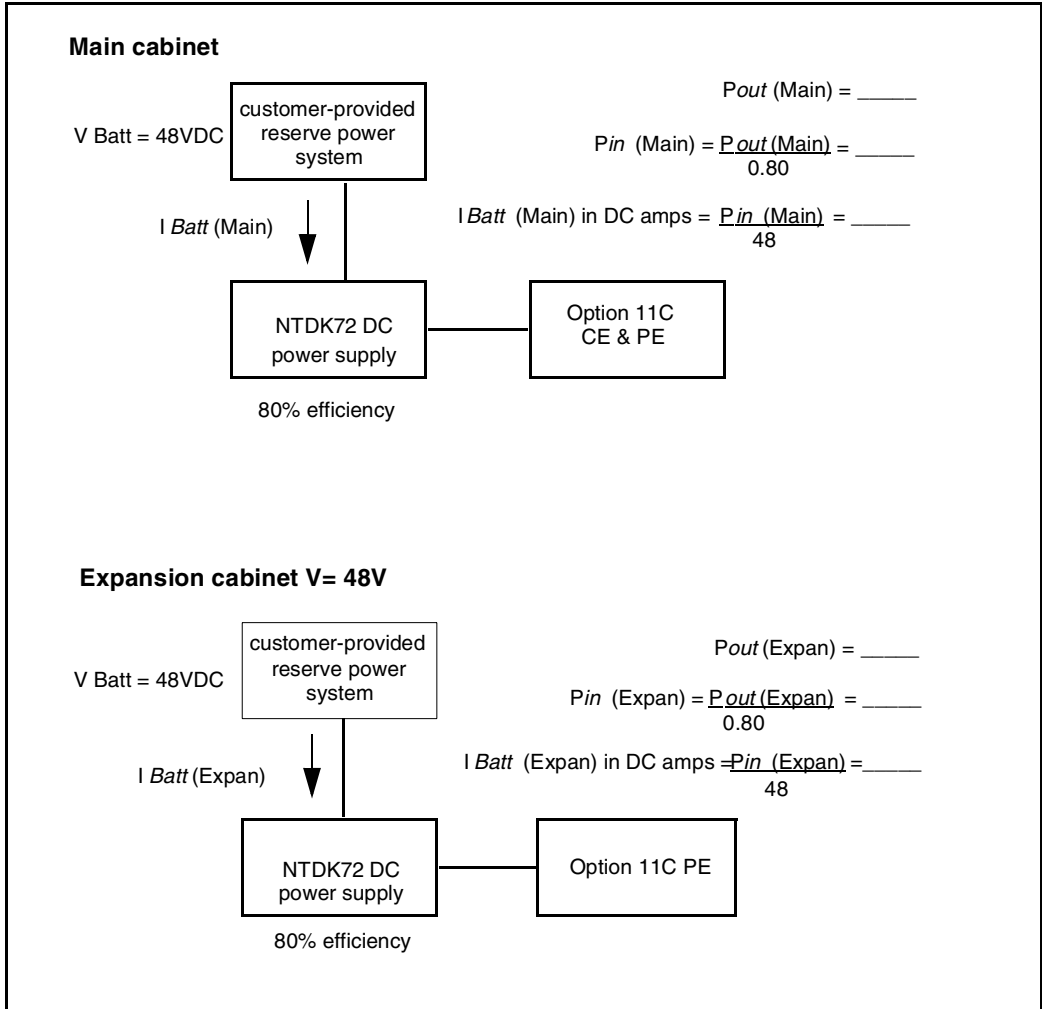

Figure 11
Discharge Time for the NTAK76 Battery

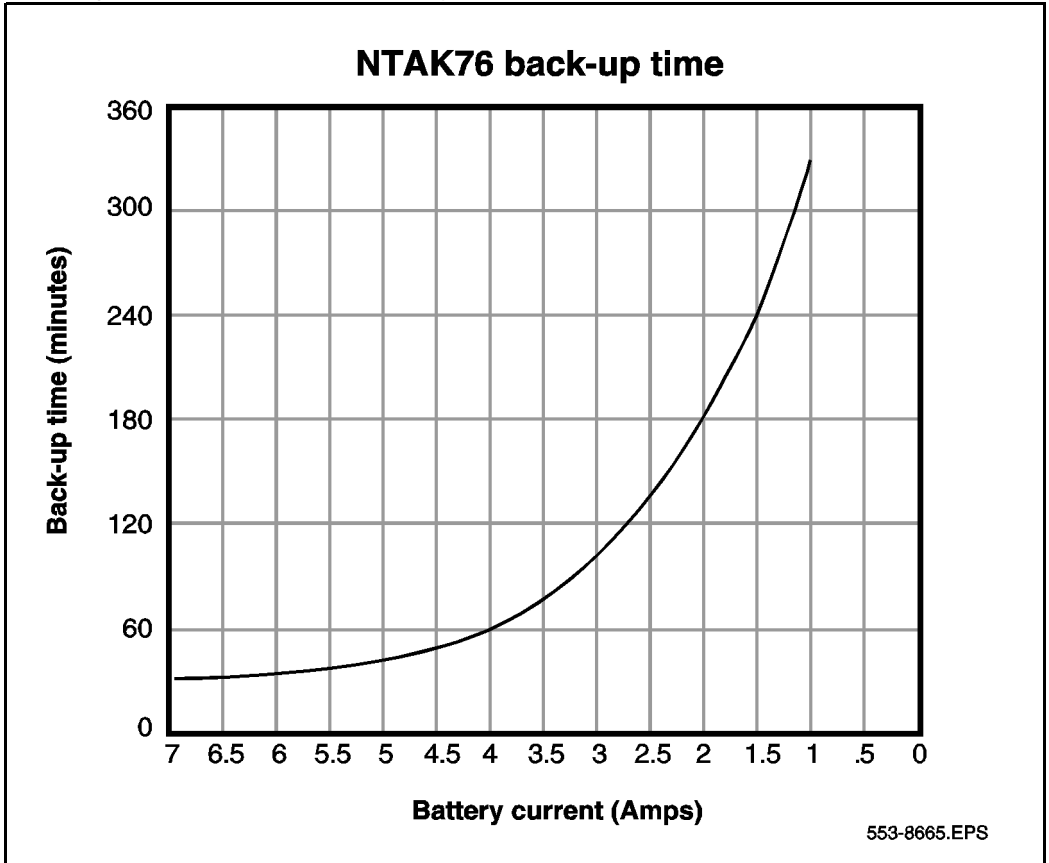
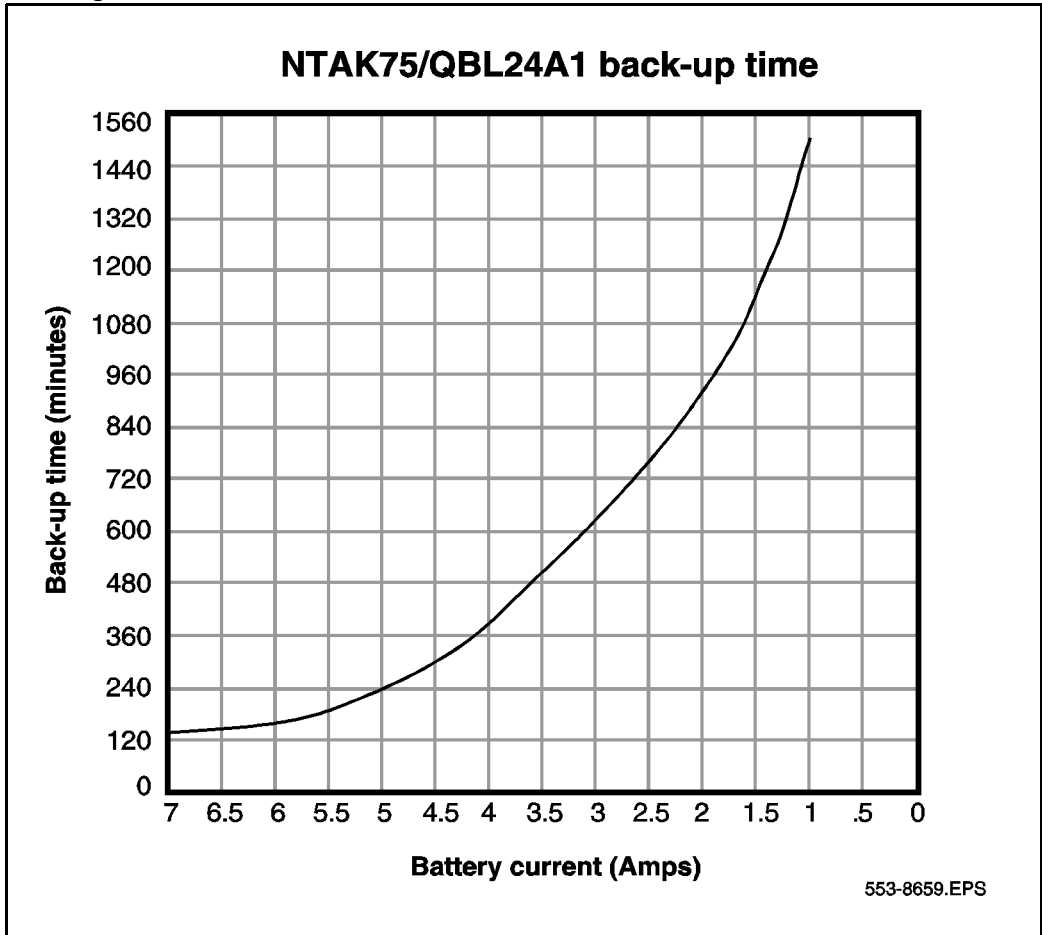

Figure 12
Discharge Time for the NTA75/QBL24A1 Batteries



Chapter 3 — Transmission parameters

Contents

This section contains information on the following topics:

Introduction	158
Transmission A-Law and μ -Law	159
Loss Plan	159
Frequency Response	165
Input impedance and balance impedance	166
Return Loss	166
Transhybrid Loss	167
Idle Channel Noise	168
Impulse Noise	169
Variation of gain versus level	169
Method 1	169
Method 2	170
Total distortion including quantization distortion	170
Method 1	171
Method 2	171
Spurious in-band signal	172
Spurious out-of-band signal	172
Discrimination against out-of-band signals	172
Intermodulation	172
Group Delay	173

Absolute group delay 173
Group delay distortion 173
Longitudinal balance 174
Crosstalk 174

Introduction

The Meridian 1 Option 11C system accommodates two companding laws to convert signals from analog to digital and from digital to analog:

- μ -Law which is used in North America and Japan.
- A-Law which is used in most other areas of the world, including Europe.

The following transmission specification applies to both standard μ -Law and A-Law cards. There are other countries which have their own transmission plans and thus use unique cards which have had adjustments made to accommodate their transmission specifications. These adjustments were generally in A/D and D/A gains.

The transmission characteristics are given in the following section. Except where indicated otherwise, the design objectives given are met when measured between 2 wire and 4 wire analog input and output interfaces terminated with their nominal impedance.

IMPORTANT

The reference frequency for μ -Law is 1024 Hz and A-Law is 820 Hz. The reference level is -10 dBmO (as an alternative a reference level of 0 dBmO may be used).

Transmission A-Law and μ -Law Loss Plan

Insertion loss

The insertion loss of a private branch exchange (PBX) connection is defined as the difference between the power delivered from the (test) reference source into the input port and the power at the output port. For insertion loss tests both the signal source and the measurement instrument have impedances of 600 ohms. The test frequency is 820 Hz for A-Law and 1024 Hz for μ -Law.

The insertion losses between various Intelligent Peripheral Equipment (IPE) ports are connection - specific in order to be compatible with end-to-end network connection loss requirements. The Meridian 1 Option 11C loss specifications are in agreement with North American standards, which are formulated to provide satisfactory end-to-end performance for connections within private networks and between private and public networks.

The loss plan strategy for IPE combines electrical loss with terminal acoustic parameters for optimum transmission performance. For this reason, some connections have asymmetrical loss in order to conform with network loss plans. This asymmetry is resolved at a remote point (another switch) in the overall connection.

Tables 37, 38, and 39 provide loss values measured in decibels (dB) for connections between:

- IPE ports (lines and trunks)
- Digital ports (PRI or DTI)

CAUTION

Tables 37, 38, and 39 are in matrix format. Be aware of the direction of the arrows when searching for a loss value.

Table 36
Guide to loss values tables

	IPE Port	Digital Port
IPE Ports	Table 37	
Digital Ports	Table 38	Table 39

Table 37
Insertion Loss from IPE Ports to IPE Ports (measured in dB) (Part 1 of 2)

	IPE Ports									
	500/2500 Line		Digital Line		2/4 Wire E&M Trunk		4 Wire (ESN) E&M Trunk		CO/FX/WATS Loop Tie Trunk	
IPE Ports	↑	↓	↑	↓	↑	↓	↑	↓	↑	↓
500/2500 Line										
→	6									
←		6								
Digital Line										
→	2.5		0							
←		3.5		0						
2/4 Wire E&M Trunk										
→	6		3.5		1					
←		3		-0.5		1				

Table 37
Insertion Loss from IPE Ports to IPE Ports (measured in dB) (Part 2 of 2)

		IPE Ports					
4 Wire (ESN) E&M Trunk	→	5.5	3	0.5	0		
	←		2.5	-1	0.5	0	
CO/FX/WATS Loop Tie Trunk	→	2.5	0	0.5	0		0.5
	←		0	-3.5	0	-0.5	0.5

Table 38
Insertion Loss Digital Ports To IPE Ports (measured in dB) (Part 1 of 2)

		IPE Ports									
		500/2500 Line		Digital Line		2/4 Wire E&M Trunk		4 Wire (ESN) E&M Trunk		CO/FX/WATS Loop Tie Trunk	
Digital Ports		↑	↓	↑	↓	↑	↓	↑	↓	↑	↓
Tie Trunk	→	8.5		6		3.5		3		2.5	
	←		2.5		0		-2.5		-3		-2.5
Satellite Tie Trunk (See note 1)	→	2.5		-3		0.5		0		-0.5	
	←		2.5		0		0.5		0		-0.5

Table 38
Insertion Loss Digital Ports To IPE Ports (measured in dB) (Part 2 of 2)

	IPE Ports					
CO/FX/WATS Loop Tie Trunk	→	0.5	2	2.5	2	0.5
	←	4.5	-1	2.5	2	-0.5
Toll Office (See note 2)	→	8.5	6	3.5	3	5.5
	←	2.5	0	-2.5	-3	0.5
Primary Rate Interface (PRI) (See note 3)	→	6.5	6	3.5	3	2.5
	←	3.5	0	0.5	0	-2.5

Notes to Table 38

- 1 A satellite tie trunk connects a satellite or tributary PBX to a main PBX. A tributary PBX does not have its own directory number for incoming calls.
- 2 The toll office designation is for a trunk to an office in the public switched network with a higher rank than the local office (class 5).
- 3 The 1.5Mb PRI and DTI have digital pads which are controlled by Meridian 1 software to provide the insertion loss given above. The 2Mb PRI and DTI have programmable digital pads. The default value for these pads gives the insertion loss in Table 38. The pad values can be printed and changed in overlay 73 (LD 73).

Table 39
Electrical loss Digital ports to Digital ports (measured in dB)

	Digital ports									
	Tie Trunk		Satellite Tie Trunk (note 1)		CO/FX/WATS Loop Tie Trunk		Toll Office Trunk (note 2)		Primary Rate Interface (PRI) (note 3)	
Digital Ports	↑	↓	↑	↓	↑	↓	↑	↓	↑	↓
Tie Trunk										
→	0									
←		0								
Satellite Tie Trunk (See note 1)										
→	0		0							
←		0		0						
CO/FX/WATS Loop Tie Trunk										
→	0		0		3					
←		6		0		3				
Toll Office (See note 2)										
→	0		6		6		0			
←		0		0		0		0		
Primary Rate Interface (PRI) (See note 3)										
→	0		6		3		0		0	
←		0		0		0		0		0

Notes to Table 39

- 1 A satellite tie trunk connects a satellite or tributary PBX to a main PBX. A tributary PBX does not have its own directory number for incoming calls.
- 2 The toll office designation is for a trunk to an office in the public switched network with a higher rank than the local office (class 5).
- 3 The 1.5Mb PRI and DTI have digital pads which are controlled by Meridian 1 software to provide the insertion loss given above. The 2Mb PRI and DTI have programmable digital pads. The default value for these pads gives the insertion loss in Table 39. The pad values can be printed and changed in LD 73.

Insertion loss limits

Table 40 gives the analog insertion loss limits for trunk and line connections.

Table 40
Insertion loss limits for trunk and line connections

Connection	Insertion Loss Variation Limits (dB)
Line — Line	± 1.0
Line — Analog Trunk	± 0.7
Line — Digital Trunk	± 0.7
Analog Trunk — Analog Trunk	± 0.7
Analog Trunk — Digital Trunk	± 0.7
Digital Trunk — Digital Trunk	± 0.2

Frequency Response

Frequency Response, or Attenuation Distortion, at a given frequency is the difference between the loss at the test frequency and the loss at the reference frequency. Table 41 gives the frequency response for 2 wire and 4 wire interfaces.

Table 41
Frequency Response for 2 wire and 4 wire interfaces

Frequency (Hz)	2 Wire Interface		4 Wire Interface	
	Minimum	Maximum	Minimum	Maximum
200	0	5	0	3
300	-0.5	1.0	-0.5	0.5
3000	-0.5	1	-0.5	0.5
3200	-0.5	1.5	-0.5	1.5
3400	0	3.0	0	3.0

Notes to Table 41

- 1 The symbol (+) denotes a loss and the symbol (-) denotes a gain.
- 2 Reference Sources:
 μ-Law -1024 Hz -10 dBmO
 A-Law - 820 Hz -10 dBmO

Input impedance and balance impedance

Input Impedance for a port is the impedance as seen looking into the port from the tip and ring.

The Balance Impedance is the output source impedance of the port and is designed to match the impedance of the transmission line plus the far end trunk.

Table 42
Input impedance/balance impedance

Connection	System	Input Impedance	Balance Impedance
500/2500 Line	IPE	600	600
2 Wire E&M Trunk	IPE	600	600
4 Wire E&M Trunk	IPE	600	600
DID/DOD/LOOP TIE Trunk	IPE	600/900	600/3COM (3 COM is the EIA termination of 350 + 1000//0.21 μ F)
C.O.Trunk	IPE	600/900	600/3COM (3 COM is the EIA termination of 350 + 1000//0.21 μ F)

Return Loss

The return loss measures how closely the input impedance matches the required impedance (source impedance). Return loss at an impedance discontinuity in a transmission path is the ratio (in dB) of the power level of an incident signal to the power level of the resulting reflected signal.

Echo Return Loss (ERL) is a weighted average of the return loss value over the frequency range of 500 to 2500 Hz.

Single Frequency Return Loss (SFRL) is the lowest value of return loss in the frequency range of 200 to 3200 Hz.

The line or trunk undergoing testing is connected to a 4 wire E&M trunk, which is terminated with 600 OHMS. The return loss is measured against its characteristic input impedance (see Table 43).

Reference Source for μ -Law or A-Law is 0 dBmO.

Table 43
Return Loss

Interface	Echo Return Loss (dB)	Single Frequency Return Loss (dB)
4 Wire Trunk	>28	>22
2 Wire Line	>18	>12
2 Wire Trunk	>22	>17

Transhybrid Loss

The source impedance of a two wire interface must match the terminating impedance (line plus telephone set or line plus far end trunk). If the source impedance does not match, there will be a problem with stability and listener echo.

The match of the output source impedance to the line or trunk impedance is measured by connecting the interface to a 4 wire trunk. The reflected signal from the hybrid is then measured when the 2 wire interface is terminated with the balance impedance given in Table 42.

The values for the transhybrid (return) loss of a 2 wire interface when terminated in its balance impedance is given in Table 44.

Reference Level is 0 dBmO.

Table 44
Transhybrid loss

Input Frequency (Hz)	Transhybrid Return Loss (dB)
300	16
500	20
2500	20
3400	16

Idle Channel Noise

Idle channel noise is noise in the absence of a signal. It is the short-term average absolute noise power, measured with either C-message weighting for μ -Law or Psophometric weighting for a A-Law. The 3 k Hz flat measurement uses equal weighting for all frequencies in the 20-3000 Hz range. The values are shown in Table 45.

Table 45
Idle Channel Noise

Connection	μ -Law C Message Noise dBrnC0	A-Law Psophometric dBmP0	3 kHz dBm0
Line — Line	<20	>65	<29
Line — Trunk	<20	>65	<29
Trunk — Trunk	<20	>65	<29

Impulse Noise

Impulse noise is defined as noise bursts or spikes that exceed normal peaks of idle-channel noise. Impulse noise is measured by counting the number of spikes exceeding a pre-set threshold; it is the number of counts above 55 dBm0 during a five minute interval, under fully loaded busy hour PBX traffic conditions.

Table 46
Impulse Noise

Time	Level	Counts
5 Minutes	>55 dBmO	0

Variation of gain versus level

The variation of gain versus level (tracking error) measures how closely changes in input levels causes corresponding changes in output levels.

The tracking error is measured in decibels and is defined as the deviation in gain or loss through a range of input level relative to the gain or loss at the reference frequency and level of 0 dBmO.

The two methods of measuring the tracking error are listed below.

Method 1

When a noise signal as defined in CCITT, recommendation 0.131 is applied at the input of any interface, the gain versus level deviation at the output meets the limits set out in Table 47.

Table 47
Variation of gain versus level method 1

Input Level dBm0	Gain Variation dB
-55 to -10	+/-0.5

Alternatively, when a sine wave input in the frequency range 700 - 1100 Hz is applied at the input of any interface, the gain vs level deviation at the output meets the limits given in Table 48.

Reference frequency:

- 700 - 1100 Hz
- 820 Hz A-Law
- 1024 Hz μ -Law

Table 48
Variation of gain versus level method 1

Input Level dBm0	Gain Variation dB
-10 to +3	+/-0.5

Method 2

With a sine wave in the frequency range of 700-1100 Hz applied to the input port of any interface, the variation of the gain versus level at the output port meets the limits given in Table 49.

Reference frequency:

- 700-1100 Hz
- 820 Hz A-Law
- 1024 Hz μ -Law

Table 49
Variation of gain versus level method 2

Input Level dBm0	Gain Variation dB
-37 to -50	+/-1
0 to 37	+/-0.5

Total distortion including quantization distortion

The quantization distortion is the difference between the original analog signal and the analog signal (signal plus noise) resulting from the decoding process. There are two methods of measuring the quantization distortion:

Method 1

With a noise signal corresponding to CCITT recommendation 0.131 applied to the input interface, the total distortion measured at the output interface lies above the limit given in Table 50.

Table 50
Total distortion method 1

Input Signal dBmO	Analog — Analog dB	Digital — Analog dB
-55	11.1	13.1
-40	26.1	28.1
-34	30.7	32.7
-27 to -6	32.4	34.4
-3	24.0	26.8

Method 2

With a sine wave at the reference frequency is applied to the input interface, the total distortion measured at the output port interface lies above the limit given in Table 51.

Reference frequency:

- 1020 Hz μ -Law
- 820 or 420 Hz A-Law

Table 51
Total distortion method 2

Input signal dBm0	Analog — Analog dB	Digital — Analog dB
-45	22	24
-40	27	29
-30 to 0	33	35

Spurious in-band signal

When a sine wave signal in the range of 700-1100 Hz, at a level of 0 dBmO is applied to the input port, the output level (at any frequency other than that of the applied signal,) is less than -40 dBmO when measured selectively in the band 300-3400 Hz.

Spurious out-of-band signal

When a sine wave signal in the range of 300-3400 Hz, at a level of 0 dBmO is applied to the input port, the level of spurious out-of-band image signals measured selectively at the output port is lower than -25 dBmO.

Discrimination against out-of-band signals

With any sine wave signal above 4.6 kHz applied to the input port at -25 dBm0, the level of any image frequency produced at the output is at least 25 dB below the level of the test signal.

Intermodulation

When two sine wave signals, f1 and f2, in the range of 450 to 2050 Hz, not harmonically related and of equal level in the range -21 to -4 dBmO are applied to the input, they do not create any 2f2-f1 intermodulation product greater than 35 dB below the power level of the input signal.

Group Delay

Absolute group delay

The absolute group delay is the minimum group delay measured in the frequency band 500-2800 Hz. The absolute group delay meets the limits given in Table 52.

Table 52
Absolute group delay

Interface type	Absolute Group Delay Microseconds
Analog — Analog	3000
Analog — Digital	2700
Digital — Digital	2400

Group delay distortion

The group delay distortion is the difference between the absolute group delay (minimum delay) and the group delay in the range 500 to 2800 Hz.

Table 53
Group delay distortion

Frequency range	Group delay distortion Microseconds
500-600	1800
600-1000	900
1000-2600	300
2600-2800	1500

Longitudinal balance

Longitudinal balance defines the amount of impedance balance that exists between the tip and ring conductor with respect to ground. Longitudinal balance is measured by injecting a longitudinal signal on the tip and ring conductors with respect to ground and measuring the amount of signal (noise) that is introduced between the tip and ring. The equation for calculating longitudinal balance is:

$$\text{Longitudinal Balance} = 20 \text{ Log } V_s/V_m$$

V_s is the disturbing longitudinal voltage and V_m is the tip to ring metallic noise voltage. Ideally the metallic noise voltage would be negligible and the longitudinal balance would approach infinity.

Table 54
Longitudinal balance for loop start interfaces

Frequency Hz	Minimum balance dB	Average balance dB
200	58	63
500	58	63
1000	58	63
3000	53	58

Crosstalk

Crosstalk is speech signal (signalling) energy transferred from one voice channel to another. The crosstalk coupling loss for every possible type of connections over the frequency range of 200 to 3200 Hz is shown in Table 55.

Test Source:

Frequency 200-3200 Hz 0 dBmO.

Table 55
Crosstalk

Connection type	Minimum Attenuation dBm0	Design Objective dBm0
Line — Line	>65	>75
Line — Trunk	>65	>75
Trunk — Trunk	>65	>75

Chapter 4 — Cabinet distribution over a data network

Contents

This section contains information on the following topics:

Reference List	177
Overview	177
Monitoring IP link voice quality of service for IP Expansion cabinets ..	178
Meridian Data	180
Network Requirements	180

Reference List

The following are the references in this section:

- *Maintenance (553-3001-511)*
- *Features and Services (553-3001-306)*
- *Administration (553-3001-311)*

Overview

Option 11C IP Expansion allows connectivity of IP Expansion cabinets either point to point or over a distributed campus data network. The campus data network connectivity is provided through IP daughterboards in the Main and IP Expansion cabinets.

Figure 13 on page 178 provides an example of Main and IP expansion cabinets and Mini chassis connected over a campus data network using both 100BaseT and 100BaseF connectivity.

In order to satisfy PBX voice quality requirements, engineering guidelines are imposed on the campus data network. Refer to “Basic LAN requirements for Excellent Voice Quality” on page 181 and “LAN recommendations for Excellent Voice Quality” on page 184.0

Note: Contact your local Data Administrator to obtain specific IP information.

Figure 13
IP Expansion configuration of cabinets over a campus data network

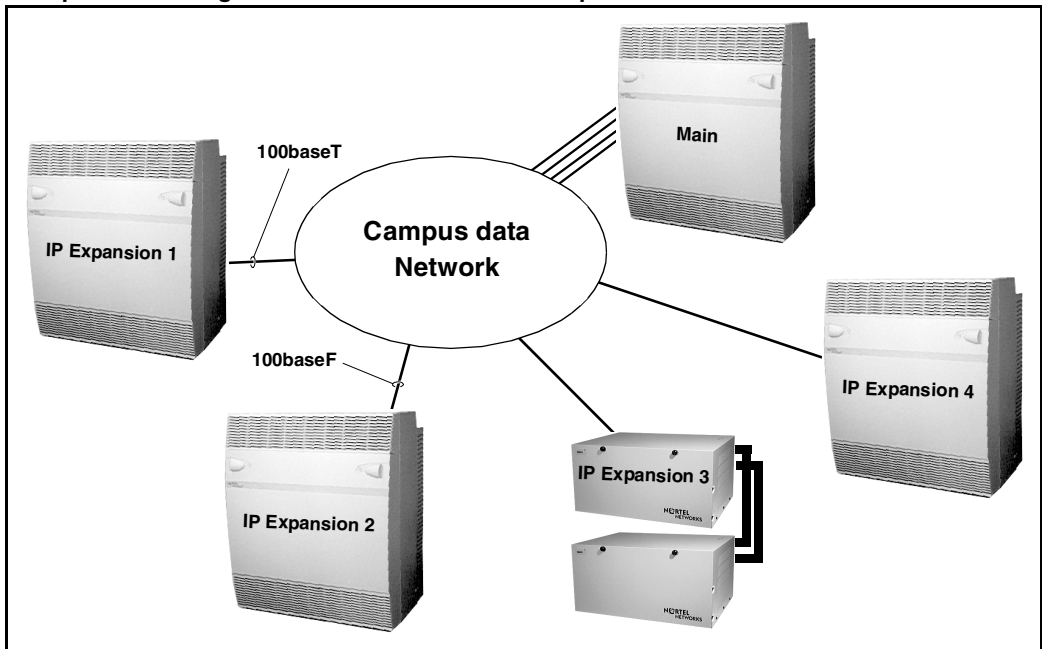

Monitoring IP link voice quality of service for IP Expansion cabinets

Behavioral characteristics of the network are dependent on the factors like Round Trip Delay (RTD), queuing delay in the intermediate nodes, packet loss and available bandwidth. The service level of each IP link will be measured and maintained on the Main for IP Expansion operation. Information for latency and packet loss will be collected from the hardware and processed.

Based on system configured thresholds, the level of service will be derived and reported to the craftsperson with the **PRT QOS <cab#>** command in LD 117. See *Administration* (553-3001-311) and *Maintenance* (553-3001-511).

Data Network Ratings (Excellent, Good, Fair, Poor) along with the actual parameter values for network delay are displayed in Table 56.

Table 56
Campus data network voice quality measurements

Voice QoS Rating	Network Round Trip Delay (PDV Max 7.8 ms)	Network Round Trip Delay (PDV Min 0.5 ms)	Network Packet Loss
Excellent	<5 ms	<12 ms	<0.5%
Good	5 - 25 ms	12 - 32 ms	0.5 - 1%
Fair	25 - 45 ms	32 - 52 ms	1 - 1.5 ms
Poor	>45 ms	>52 ms	>1.5%

The values in Table 56 assume that there is no echo cancellation mechanism and no particular mechanism for recovering lost packets.

The command **PRT PDV <cab#>** in LD 117 displays both the current size of the PDV buffer and the number of PDV underflows.

In addition, a warning message is printed when a parameter threshold (or combination of thresholds) is reached. These thresholds are not user configurable.

In LD 117, the command **CHG PDV <port#> <delay>** is used to set Packet Delay Variation (PDV buffer size) on a per link basis. The **<delay>** parameter can take values from 0.5 ms to 8 ms. This value should be initially tested at default settings. Increase the **<delay>** parameter value by 0.5 ms increments if an unacceptable level of voice quality is experienced (“pops and clicks”). Decrease this value if echo is experienced. The goal is to operate with the smallest buffer possible.

The PDV buffer size for each IP connection is configured at the Main and is automatically downloaded to the IP Expansion cabinet.

Meridian Data

The Meridian 1 PBX supports the switching of data through its TDM fabric. This allows for several applications in which the voice network can be used to transport data traffic. One such application would allow a communication device at a given location, such as a PC, to access a server at another location. Speeds up to 64Kbps can be achieved, as normal voice channels are assigned to a data call for the duration of the session. Connectivity is achieved through data modules which stand alone or exist as modules within digital sets. At the PBX, several card options are supported, including the XDLC. As a result, a highly reliable physical path is achieved through the Meridian 1 TDM fabric. Please refer to *Features and Services* (553-3001-306) for more information.

The reliability of this data application relies on a highly robust layer 1, in this case, the TDM fabric. The above NTP gives the following bit error rate as a measure of this reliability:

- In-house error rate $\leq 1 \text{ error} \times 10^{-7}$ (1 error in 10Mbits)
- Trunk error rate $\leq 1 \text{ error} \times 10^{-5}$ (1 error in 100Kbits)

In the case of IP Expansion, a packet loss of $< 1\%$ has been quoted to achieve acceptable voice quality. This potentially means 1 error in 100 bits can be fully tolerated for voice, but this is absolutely not suitable for Meridian 1 data traffic. Therefore, Meridian 1 data can be transported to the same level of reliability on an IP Expansion cabinet if the customer's LAN can achieve 1 error in 100Kbits. Otherwise, it must be recognized that packet loss could impact any application being transported. The zero bandwidth parameter for the CHG IPR command in LD 117 must be set to NO to ensure that packet loss due to synchronization of the IP link is avoided.

Network Requirements

When a Main and an IP Expansion Cabinet are connected by an Campus Data Network, the quality of voice depends on the network. The network requirements defined here must be met.

Basic LAN requirements for Excellent Voice Quality***Summary of requirements:***

- 100Base-Tx/F Layer 2 switch that supports full duplex connection (Layer 3 switching is supported). The Data Port on the Campus Data Network/LAN must have Auto-negotiation disabled and the Speed/Duplex set to 100 Full Duplex.
- Packet Loss < 0.5%
- Idle System Bandwidth approximately 0 Mbps, Peak Bandwidth under high traffic conditions 14 Mbps, Theoretical Maximum peak bandwidth 24 Mbps
- Network Delay - Round Trip Delay (RTD) < 5 msec (*)
 - * with PDV jitter buffer set to maximum, RTD < 5 ms
 - * with PDV jitter buffer set to minimum, RTD < 12 ms
- Support of Port Priority Queuing recommended
- Support of VLAN configuration recommended

The network must provide full duplex capability between the Main and all IP Expansion cabinets for excellent voice quality. A Layer 2 or Layer 3 switch that supports full duplex connection over 100BaseT/F is required to achieve this minimum network requirement.

Figure 14
Basic LAN Configuration for excellent voice quality

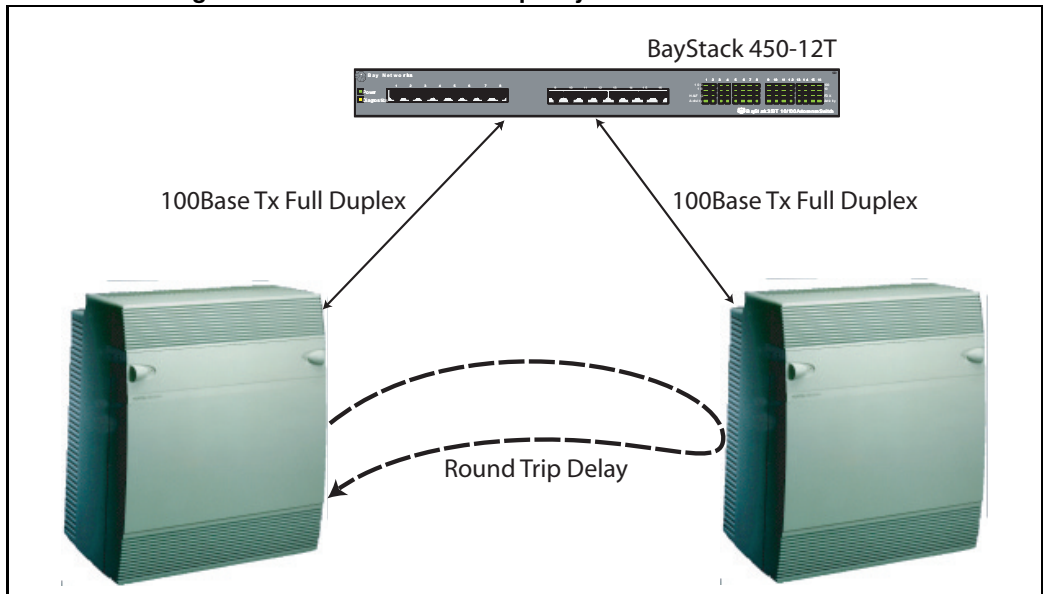

Bandwidth

The IP Expansion system is designed for non-blocking transmission between Main and IP Expansion cabinets. The throughput of the network must be guaranteed.

When using either an Option 11C cabinet or an Option 11C Mini chassis as your Main system controller, the idle system bandwidth is approximately 0 Mbps. Under high traffic conditions, a peak bandwidth of 14Mbps is required for excellent voice quality. The theoretical maximum peak bandwidth is 24Mbps.

Note: If there is no traffic flow, there are no bandwidth requirements. Only active channels use bandwidth.

Table 57
Bandwidth Requirements

Talk Slot	Voice Traffic (Mbps)	Signaling Traffic (Mbps)	Total (Mbps)
320	23.5	0.5	24.0
160	13.3	0.5	13.8
75	7.8	0.5	8.3
40	5.6	0.5	6.1
16	4.1	0.5	4.6
0	0.0	0.11	0.11

PDV Jitter Buffer

Packet Delay Variation (PDV) jitter buffer is used to smooth out any variations in the arrival rate of the UDP/IP voice packets with respect to the rate at which the voice samples are played. The minimum and maximum values for excellent voice quality are given in Table 56 on page 179.

The PDV jitter buffer is also used to re-sequence out of order voice packets.

Note 1: If you experience buffer underflow errors or clicking and popping noises on a voice call, the size of the PDV buffer needs to be increased.

Note 2: Increase the PDV buffer as little as possible (0.5 ms) in order to keep the round trip delay as short as possible. The goal is to operate with as small a buffer as possible to keep the round trip delay as short as possible.

CAUTION

Excessive delay will cause a degradation in voice quality in the form of echo.

LAN recommendations for Excellent Voice Quality

It is recommended that the Port Based Virtual LAN (VLAN) feature should be utilized to isolate the Option 11C from the broadcast domain of the customer's LAN equipment. This will reduce the risk of link outages due to broadcast storms.

Packet Prioritizing Scheme

The packet prioritizing scheme can be used to effectively utilize bandwidth. However, the network delay requirement that the one way trip delay not exceed 2.5 ms must be met. Support of priority queuing is recommended.

Port priority queuing will help maintain excellent voice quality during heavy usage or congestion. Refer to Figure 15 on page 184 for an example of port priority queuing.

Figure 15
Example of Port Priority Queuing Configuration

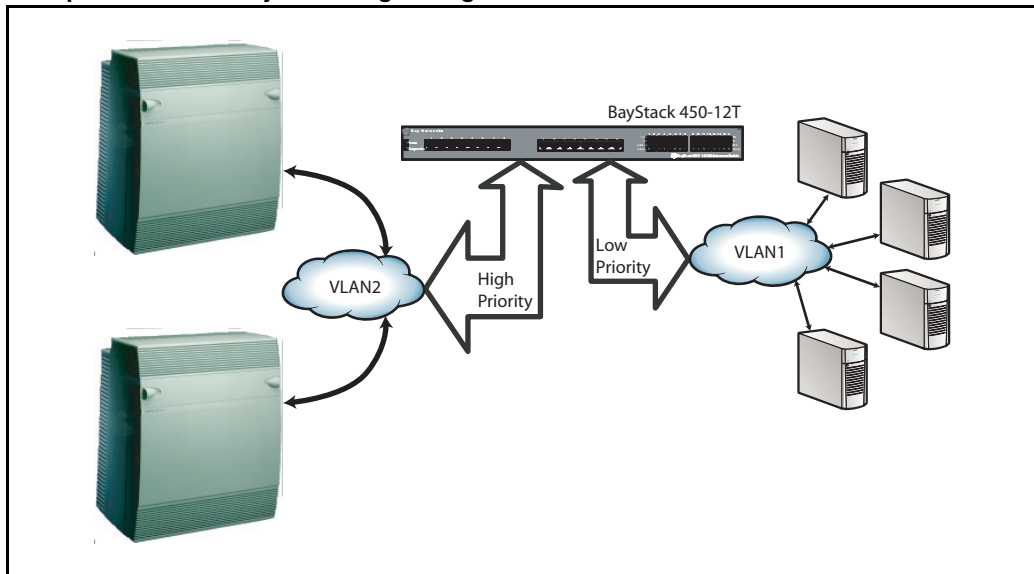

Media conversion devices

Third-party media conversion devices can be used to extend the range of the 100BaseT and 100BaseF IP solutions. One such device, the IMC Networks Ethernet Compatible Media Converter with a McLIM Tx/Fx-SM/Plus module, provides acceptable transmission between cabinets located up to 40 km apart. This solution is illustrated in Figure 16. However caution must be used when extending the length of cable used in the point-to-point configuration. The round trip delay parameters specified in Table 57 must not be exceeded.

Figure 16
Example of third-party media device used with 100BaseT hardware

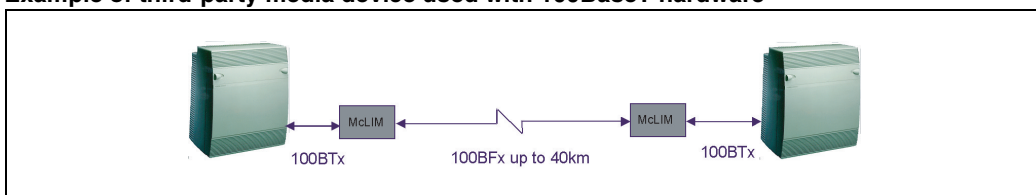

IP Security

IP security in IP Expansion configuration is addressed in two ways:

- Filtering to protect CPU integrity and call processing stability.
 - ARP Filtering - ARPs are filtered when the IP link between Main cabinet and IP Expansion cabinet is up.
 - IP Filtering - Only packets from/to M1 nodes (cabinets) IP addresses are processed when the IP link between the Main cabinet and IP Expansion cabinet is up.

Note: IP Expansion cabinets, during IP link up mode, cannot be "pinged" from other data network nodes. However the Main cabinet can ping IP Expansion cabinets and vice-versa.

- Voice Channels Security (Privacy)
 - Multiplexed Voice Channels Packets - PCM samples from all active channels are packetized every 125usec. There is no single voice packet associated with the call as with standard VoIP protocols.

- Dynamic Allocation of the channel in the packet - Channel position in the packet is dynamically allocated on a per call basis. Therefore, Set A has different channels allocated for different calls.

Chapter 5 — Spares planning

Contents

This section contains information on the following topics:

Reference List	187
Introduction	187
Definitions and assumptions	188
Calculating spares requirements	189
Failure rates	191
NFT values	193
NTAK76 battery back-up unit	194
NTAK75 extended battery back-up unit	195

Reference List

The following are the references in this section:

- *Option 11C and 11C Mini Fault Clearing (553-3011-500)*

Introduction

Spares planning is used to determine desired inventory levels of spares (replaceable) items. Spares planning is used by repair houses and centralized depots in order to ensure that there is an adequate stock of replaceable items on hand.

This section will provide the information necessary to calculate spares for the Option 11C system.

Definitions and assumptions

Failure rate: Spares planning is based on the Failure rate of the replaceable part. The failure rate is defined as the estimated number of failures for that item during one million (10^6) hours of operation.

Sparing interval: the sparing interval is the period of time that the stock of items should last without being replenished. This period is assumed to be one year after the installation of the system.

Stock confidence level: the stock confidence level is the allowed probability of not going out of stock during the sparing interval. This is assumed to be greater than 99.9 percent.

Turnaround time for repair: the turnaround time for repair is the length of time it takes to repair a failed spares item.

The turnaround time from a repair house is estimated to be 10 working days (240 hours). (See Figure 17).

Figure 17
Single depot or repair house service

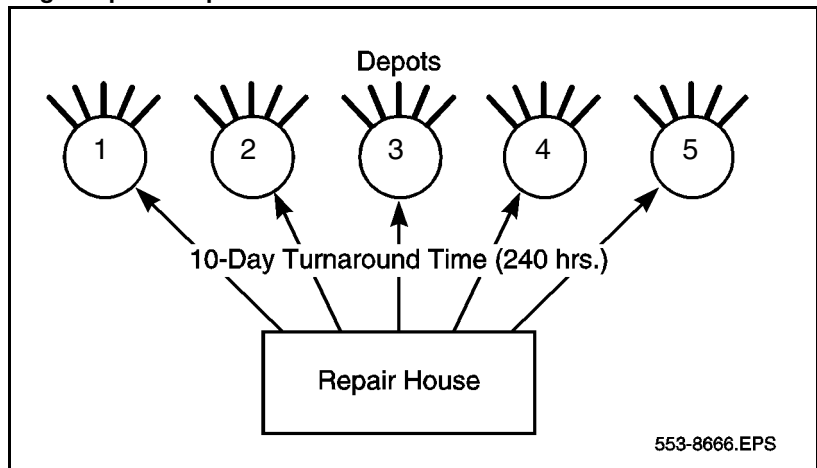

The turnaround time from a centralized depot is estimated to be 2 working days (48 hours). (See Figure 18.)

Figure 18
Centralized depot service

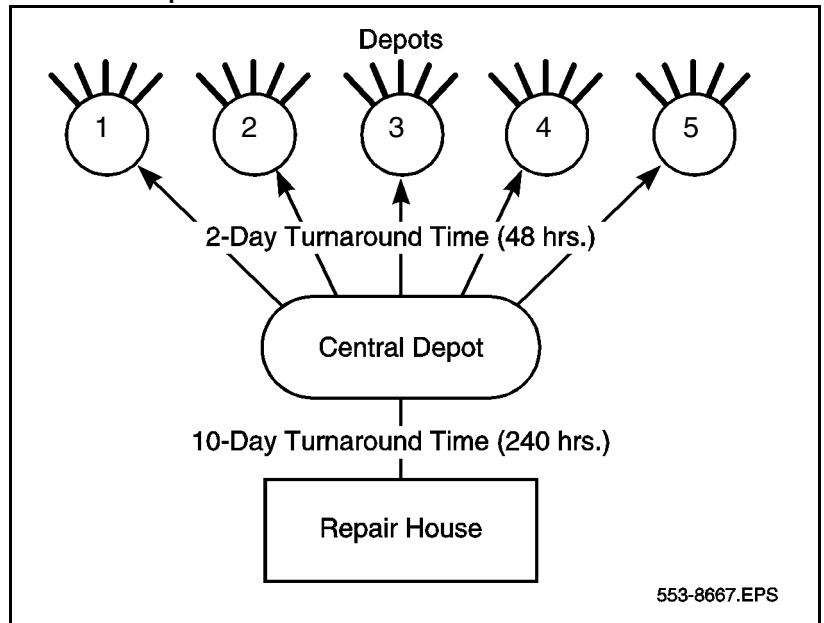

Actual turnaround periods will vary in the field.

Population range: the population range is the quantity of each type of Meridian 1 switch in the area served by the depot.

Spare stock size: the spare stock size for a given item depends on the sparing interval, stock confidence level, failure rate, turnaround time for repair, and population range.

Calculating spares requirements

The quantity of a replaceable item that is required to stock a depot for one year can be calculated using a formula:

$$N \times F \times T$$

The spares planning formula has the following components:

N — The number of a spares item in use.

F — The failure rate of a particular spares item.

T — The turnaround time for repairing a failed spares item in hours.

The formula will produce an NFT value. The number of spares required for a one year period may be found by looking up the NFT value in the table provided in this section.

The following procedure is an example of spares planning for the NT8D14AA Universal Trunk Card.

Determining spares quantities for a one year sparing interval

- 1** Determine the number (N) of the particular item that is being serviced by the depot.
For example, a single depot services 10,000 Universal Trunk Cards.
- 2** Determine the failure rate (F) for the specified item.
From the Failure rates listed in Table 58 on page 191, the failure rate for the Universal Trunk Card is 3.4.
- 3** Determine the turnaround time (T) in hours.
Assume a centralized depot with a turnaround time of 48 hours.
- 4** Calculate the NFT value by multiplying $N \times F \times T$.

$$\text{NFT} = (10,000 \text{ units} \times 3.4 \text{ failures} \times 48 \text{ hrs}) / 1,000,000 \text{ hrs} = 1.632$$

From the NFT values in Table 59 on page 193, the number of spares required for NFT value 1.632 = 8.

That is, eight NT8D14AA Universal Trunk Cards are needed to last an interval of one year when servicing 10, 000 Universal Trunk Cards.

Failure rates

The failure rates in Table 58 are for Option 11C system components.

Note: Rates for circuit cards are based on 40°C ambient temperature.

Table 58
Failure rates for Option 11C system components (Part 1 of 2)

NT code	Description	Failure rate per 10 ⁶ hrs.
NTAK02	SDI/DCH circuit card	2.9
NTAK04	AC/DC power supply	3.6
NTAK10	2.0Mb DTI	2.4
NTAK20	clock controller	.54
NTBK22	MISP circuit card	7.66
NTBK50	2.0Mb PRI	3.4
NTBK51	DDCH	1.22
NTDK16	48 port Digital Line Card	1.8
NTDK22	10 m Fiber Daughterboard	2.19
NTDK23	10 m Receiver card	2.15
NTDK24	3 km Fiber Daughterboard	2.19
NTDK25	3 km Receiver card	2.15
NTDK26	Upgrade Daughterboard	0.46
NTDK72	DC power supply	3.6
NTDK78	AC/DC power supply	3.6
NTDK79	3 km Fiber Daughterboard	2.19
NTDK80	3 km Receiver card	2.15
NTDK81	Software Daughterboard	0.83

Table 58
Failure rates for Option 11C system components (Part 2 of 2)

NT code	Description	Failure rate per 10⁶ hrs.
NTDK85	Dual Fiber Expansion Daughterboard	2.28
NTDK91	Option 11C Mini Main Chassis	1.7
NTDK92	Option 11C Mini Chassis Expander	1.7
NTDK97	Mini System Controller (MSC)	3.39
NTZK06	M2006 telephone	3.08
NTZK08	M2008 telephone	3.10
NTZK16	M2616 telephone	3.88
NTZK22	M2216ACD-1 telephone	4.68
NTZK23	M2216ACD-2 telephone	5.37
NT1F05	M2009 telephone	12.22
NT6G00	M2250 TCM Console	N/A
NT8D02	Digital Line Card	1.8
NT8D09	Message Waiting Line Card	5.8
NT8D14	Universal Trunk Card	3.4
NT8D15	E & M/DICT/PAG Trunk Card	3.7

NFT values

Table 59 translates NFT values to the number of spares required in stock:

N—Number in use

F—Failure rate

T—Turnaround time (in hours)

Table 59
Number of spares required (Part 1 of 2)

NFT values		Number of spares
0	0.0010	1
0.0010	0.0452	2
0.0452	0.1890	3
0.189	0.425	4
0.425	0.734	5
0.734	1.090	6
1.09	1.50	7
1.50	1.95	8
1.95	2.43	9
2.43	2.94	10
2.94	3.46	11
3.46	4.01	12
4.01	4.58	13
4.58	5.16	14
5.16	5.76	15
5.76	6.37	16

Table 59
Number of spares required (Part 2 of 2)

NFT values		Number of spares
6.37	6.99	17
6.99	7.62	18
7.62	8.26	19
8.26	8.91	20
8.91	9.57	21
9.57	10.20	22
10.2	10.90	23
10.9	11.50	24
11.5	12.20	25
12.2	12.90	26
12.9	13.60	27
13.6	14.30	28
14.3	15.00	29
15.0	15.80	30

NTAK76 battery back-up unit

The batteries supplied with the NTA76 have an average useful life of four years, meaning the batteries are depleted to 80% of capacity, and backup time is diminished. After this period of time the batteries should be replaced. For more information refer to the *Option 11C and 11C Mini Fault Clearing (553-3011-500)* The mean time between failures (MTBF) of the NTA76 without batteries is 370 years at 25° C.

NTAK75 extended battery back-up unit

The batteries supplied with the NTA75 have an average useful life of four years, meaning the batteries are depleted to 80% of capacity, and backup time is diminished. After this period of time the batteries should be replaced. For more information refer to *Option 11C and 11C Mini Fault Clearing* (553-3011-500). The mean time between failures (MTBF) of the NTA75 without batteries is 100 years at 25° C.

Table 60
Dimensions of NTA75 and NTA76 batteries

Card	Length	Width	Depth
NTA75	19" (480 mm)	11.5" (290 mm)	11" (280 mm)
NTA76	12.25" (312 mm)	9.75" (250 mm)	6.25" (160 mm)

Chapter 6 — Power supplies

Contents

This section contains information on the following topics:

Introduction	198
Features of the Option 11C power supply	198
Dimensions and weight	198
AC/DC power supply features	198
DC power supply features	199
Voltage	199
Ringing Generator	199
Power supply LED	199
Under-voltage	200
Over-voltage	201
Temperature sensor	201
Reserve power LED	201
PFTU operation	202
Reserve power	203
Discharge requirements	203
Backup options	203
Battery charging in AC-powered systems	204
Reserve time	204
Features of the Option 11C Mini power supply	204
Dimensions and weight	205

AC power supply features	205
Voltage	206
Over-voltage	206
Under-voltage	206

Introduction

This chapter describes the Option 11C AC/DC power supplies (NTAK04, NTAK05, NTDK72, and NTDK78) reserve power requirements, and the operation of the Power Fail Transfer Unit (PFTU). The NTDK15 power supply for the Option 11C Mini is described on page 204.

Features of the Option 11C power supply

Dimensions and weight

The AC/DC and DC power supplies measure approximately 12.5 inches (305 mm) high, 5 inches (127 mm) wide and 10 inches (245 mm) deep.

It weighs approximately 12 lb (5.5 kg), while the DC power supply weighs approximately 8 lb (3.5 kg).

AC/DC power supply features

The NTAK04 and NTDK78 AC/DC power supply has the following features:

- A current limiting circuit which limits the surge of current on the input line when the system is first switched on.
- Accommodates a reserve power system. The system continues to operate on DC reserve power in case of AC power failure.

Note: The NTAK04 or NTDK78 AC/DC power supply cannot power up on battery alone. If the NTAK04 or NTDK78 is powered down while operating on DC reserve power, then AC power is required to power up the system.

- Battery charging for the reserve power system. Charging current in a worst-case scenario (when Meridian Mail is installed) is 1.0 amp.
- Power ($\pm 15V$) for one attendant console.
- Generation of a system line transfer signal and power (-52V) for the Power Fail Transfer Unit (250 MA maximum).

- Differential mode and common mode EMI filtering of input.
- Input power (-52VDC) for the Meridian Mail power supply (NTAK13).

DC power supply features

The DC power supply has the following features:

- Power ($\pm 15V$) for one attendant console.
- Generation of a system line transfer signal and power (-52V) for the Power Fail Transfer Unit (250 MA maximum).

Voltage

The AC/DC power supply and the DC power supply provide +5.1, +8.5, +15, -15V, -150V, -52V power supplies and filtered -48V.

There is a 1.0 second start-up delay on the +5V rail.

Ringling Generator

The AC/DC power supply and the DC power supply provide the ringling generator for telephones:

- Ringling voltage: 70, 75, 80, 86V.
- Ringling frequency: 20, 25, 50 Hz, switch selectable.
- Ring sync: A pulse 500 us wide, 6 or 11 ms (± 3 ms) before the positive going zero crossing of the ringling waveform (11 ms for 20/25 Hz).
- Power: The output capability is 8VA which is capable of ringling 8CA4 ringers.

Power supply LED

The LED on the power supply faceplate labelled "DC" will be turned off whenever there is a problem with the power supply.

Under-voltage

Under-voltage to the AC/DC or DC power supply will result in partial failure of the Option 11C system. The faceplate LED labelled “DC” will be turned off.

WARNING

Under-voltage, in the case of +5.1V, will result in the complete shutdown of the system.

Table 61 outlines the nominal and under-voltage limits of the power supply.

Table 61
Nominal and under-voltage limits of NTAK04, NTAK05, NTDK72, and NTDK78 power supplies

Nominal	Under-voltage limit	Power supply status
+5.1V	+3.8V	Complete Shutdown
8.5V	+6.4V	Partial failure
-150V	-100.0V	Partial failure
+15V	+11.2V	Partial failure
-15V	-11.2V	Partial failure
-48V	-36.0V	Partial failure
Ring (Pk V)	70V	Partial failure
-52V	-45V	Partial failure

Over-voltage

An OVP (Over-Voltage Protection) circuit will shut down the power supply if the output voltage exceeds the limits given in Table 62.

Table 62
Nominal and over-voltage limits of NTAK04, NTAK05, NTDK72 and NTDK78 power supplies

Nominal voltage	Overvoltage limit	Power supply status
+5.1V	+6.4V	Complete Shutdown
+8.5V	+10.6V	Complete Shutdown
-150V	-187.5V	Complete Shutdown
+15V	+18.7V	Complete Shutdown
-15V	-18.7V	Complete Shutdown
-48V	N/A	N/A
Ring (Pk V)	150V	Complete Shutdown
-52V	-58V	Complete Shutdown

All outputs in a shutdown state are reset by the SSC card.

The system power will not automatically reset when there is overvoltage on the -52V DC output. Manual intervention is required. The manual int button is located on the faceplate of the SSC card.

Temperature sensor

The power supplies are sensitive to the temperature of the cabinet and the system power. A thermostat is located at the top of the power supply unit. The AC or DC input breaker will be tripped for temperatures higher than 80°C (176°F).

Reserve power LED

The NTAK04 and NTDK78 AC/DC power supplies oversee the status of the reserve power system. When the breaker on the NTAK28, NTAK75, or NTAK76 breaker assembly trips, the “Batt” LED on the NTAK04 or NTDK78 faceplate is turned off.

PFTU operation

Power is switched over to the Power Fail Transfer Unit (PFTU) during any of the following conditions:

- The CPU sends a signal to the PFTU
- A power failure occurs
- A CPU failure occurs
- The PFTU is manually activated
- The fiber link to an expansion cabinet fails (PFTU for that cabinet only)

The Option 11C power supply connects to the PFTU through the AUX connector at the bottom of the main cabinet, and in each expansion cabinet. Table 63 provides the pinouts at the cross connect terminal for the Auxiliary cable.

Table 63
Auxiliary cable pinouts

Cable	Signal
BL-W 1 Dot	BRTN
BL-W 2 Dot	BRTN
O-W 1 Dot	-48 V AUX
O-W 2 Dot	PFTS
G-W 1 Dot	-15V AUX
G-W 2 Dot	+15V AUX
BR-W 1 Dot	-
BR-W 2 Dot	-

Reserve power

Discharge requirements

Reserve batteries must be able to provide 500 watts of power to each cabinet. This is a worst-case figure based on the maximum power consumption per cabinet.

Backup options

The options available when backing up the AC-powered Option 11C system are as follows:

- Use customer-supplied batteries along with the NTAK28 breaker assembly.
- Connect an Uninterrupted Power Supply (UPS) to the Option 11C system.
- Use Nortel Networks supplied NTAK75 or NTAK76 battery units.

CAUTION

Always follow the manufacturer's instructions when installing batteries.

Customer supplied reserve batteries with NTAK28

Customer supplied batteries may be used as long they meet the requirements set out in Table 64. One NTAK28 breaker assembly is required per cabinet.

NTAK75 or NTAK76 battery units

Two battery units are available. The NTAK75 supplies a minimum of two hours backup at full load, while the NTAK76 supplies a minimum of fifteen minutes backup at full load.

Table 64
Reserve battery requirements

Sealed cells	Cell float voltage	String float voltage
23	2.30 — 2.36	52.95 — 54.25
24	2.20 — 2.26	52.95 — 54.25

Uninterrupted Power Supply (UPS)

A 750VA Uninterrupted Power Supply (UPS) may be connected to AC-powered systems in order to provide a continuous supply of AC-power.

If two cabinets are equipped, two 750VA UPSs or one 1.5KVA UPS can be used.

Battery charging in AC-powered systems

During normal operation, the AC/DC power supply (NTAK04 or NTDK78) provides a constant float voltage to the reserve batteries. This charger voltage is not adjustable and will not provide equalization voltages. See Table 65.

Table 65
NTAK04 or NTDK78 AC/DC power interface to reserve power systems

	Minimum	Nominal	Maximum
Float Voltage	52.95 Volts	53.6 Volts	54.50 Volts
Charge Current ^a	1.0 Amps	—	7.0 Amps

a. The charge current available to the reserve batteries depends on the system configuration and the line size.

Reserve time

Table 66 outlines the Ampere hours required (AHR) per cabinet during a power failure. The reserve times are based on nominal load for a typical installation.

Table 66
Reserve time

Duration of Power Failure	AHRs required per Option 11C cabinet
30 – 40 minutes	6 AHR
1.5 – 2 hours	12 AHR
3 – 4 hours	25 AHR

Features of the Option 11C Mini power supply

This section describes the Option 11C NTDK15 Mini AC power supply.

Dimensions and weight

The AC power supply is factory installed in the chassis and is not accessible. The power supply measures approximately 1.75 in. (44 mm) high, 8 in. (203 mm) wide and 10 in. (254 mm) deep.

It weighs approximately 3 lb (1.4 kg).

AC power supply features

The Option 11C Mini AC power supply has the following features:

- A current limiting circuit which limits the surge of current on the input line when the system is first switched on.
- All outputs fully regulated.
- Universal 100-240 VAC input.
- 363 Watt total output power.
- Meets CISPR B emission per EN 55022.
- Power status indicator LED is located on the top front left corner of the chassis.

The Green LED indicates all voltages are within specification. The LED is off when one or more voltages are not within specification.

- Ringing voltage: 70, 75, 80, or 86 Vrms depending on DIP switch settings.
- Ringing frequency: 20, 25, or 50 Hz depending on DIP switch settings.

Note: The DIP switch discussed here is located on the front top plate of the chassis, and can only be accessed with the chassis faceplate removed.

- Cooling is provided by a fan mounted inside the chassis.
- Power: The output capability is 5VA which is capable of ringing 5C4A ringers.
- Provides ring synchronization (zero current crossing) signal.
- Power on/off switch.
- Power status output to CPU.

Voltage

The Option 11C Mini AC power supply provides +5.1, +8, +15, -15, and -48V. -120V/-150V is selected or disabled by DIP switch settings.

There is a 1.0 second start-up delay on the +5V rail.

Over-voltage

An OVP (Over-Voltage Protection) circuit will shut down all outputs if the +5 V output voltage exceeds the over-voltage threshold.

Under-voltage

An under-voltage protection circuit will shut down all outputs if +5V output is below the under-voltage threshold.

There is a 1.0 minute recovery delay from an under-voltage condition.

Chapter 7 — System Controller cards

Contents

This section contains information on the following topics:

Reference List	207
Introduction	207
NTDK20 Small System Controller card	208
Memory	208
Expansion Daughterboards.	210
NTDK97 Mini System Controller card	221
Memory	221

Reference List

The following are the references in this section:

- *Option 11C Mini Planning and Installation (553-3021-209)*
- *Option 11C Planning and Installation (553-3021-210)*

Introduction

This chapter describes the System Core cards used with Option 11C, and Option 11C Mini.

These cards are:

- the NTDK20 Small System Controller card used with Option 11C and Option 11C Mini
- the NTDK97 Mini System Controller card (MSC) card used exclusively with Option 11C Mini when one main chassis and one chassis expander (only) are connected.

NTDK20 Small System Controller card

The NTDK20 Small System Controller (SSC) card is used with the Option 11C and Option 11C Mini in an IP Expansion system. It controls call processing, stores system and customer data, and provides various expansion interfaces (see Figure 22 on page 215). The NTDK20 SSC card is comprised of the following components and features:

- Flash daughterboard memory, DRAM and Backup memory
- Two expansion daughterboard interfaces
- One PCMCIA socket
- Three Serial Data Interface (SDI) ports
- 32 channels of Conferencing (64 if two single port Expansion Daughterboards are present, or 96 if two dual port Expansion Daughterboards are present)
- One Ethernet (10 Mbps interface) port
- 30 channels of tone and digit switch (TDS) and a combination of eight Digitone receivers (DTR) or dial tone detectors (XTD)
- Networking and Peripheral Signalling
- Additional tone service ports (four units of MFC/MFE/MFK5/MFK6/MFR or eight DTR/XTD units)

Memory

The majority of system and customer configured data is both controlled and stored on the NTDK20 SSC card's Flash ROM. An active and backup copy of customer data is also kept on the Flash ROM.

Additional memory, referred to as DRAM on the NTDK20 SSC card, stores and processes temporary automated routines and user-programmed commands. The NTDK20 SSC card also retains a copy of customer files in the event of data loss, in an area called the Backup flash drive.

The NTDK20 SSC card's Flash daughterboard (the NTKK13), performs the significant portion of system software storage and data processing for the Option 11C.

NTTK13

The NTKK13 is a 48 Mbyte daughterboard comprised of Flash ROM and Primary Flash drive.

- The Flash ROM holds 32 Mbytes of ROM memory, comprising operating system data and overlay programs. Flash ROM is expandable using an expansion flash daughterboard.
- The Primary Flash drive contains 16 Mbytes of storage space. Most of the data storage is allocated to the Primary Flash drive - the main storage area of customer configured data.

The boot code on existing SSC (Option 11C) cards must be NTDK34FA Release 07 or later to support the NTDK81 or NTKK13 Flash Daughterboards. It is recommended that the boot code be upgraded to the latest issue every time the software is upgraded. The boot code can be found on the programmed PCMCIA card.

Note: New Option 11C systems will have the latest version of software pre-programmed on the software daughterboard.

Other system data such as the Secure Storage Area (SSA) also resides in the Flash drive. The SSA holds data that must survive power-downs.

Boot ROM is a 2 Mbyte storage device located on the NTDK20 SSC card's motherboard. It is comprised of boot code, system data, patch data and the backup copy of the Primary Flash drive's customer database.

The NTDK20 SSC card is equipped with 8 Mbytes of temporary memory space called DRAM. DRAM functions much like RAM on a computer system, whereby system and user files are stored while the system is up and running. DRAM on the Option 11C stores operating system files, overlay data, patch codes, and the active copy of the customer database.

Expansion Daughterboards.

Expansion Daughterboards mounted on the NTDK20 SSC card (Figure 22 on page 215) allow the connection of the main cabinet to expansion cabinets in multi cabinet Option 11C systems. Each port on each daughterboard also provides an additional 16-channel conference loop and up to 3 SDI ports on the expansion cabinet. Table 67 provides the ports, cables and connection data on the expansion daughterboards. A description of and purpose for each daughterboard is given below:

- The NTDK22 Expansion Daughterboard is used when the expansion cabinet is within 10 m (33 ft.) of the main Option 11C cabinet. It connects to one A0618443 Fiber Optic plastic cable.

One of these boards is required for each expansion cabinet located within 10 m (33 ft.) of the main cabinet that is to be connected using the A0618443 Fiber Optic plastic cable.

- The NTDK84 Expansion Daughterboard has the same features as the NTDK22 except that it can interface with two expansion cabinets.
- The NTDK24 Expansion Daughterboard is used when the expansion cabinet is up to 3 km (1.8 mi.) of the main cabinet. It connects to one glass multi-mode fiber optic cable which is dedicated to the Option 11C system.
One NTDK24 daughterboard is required for each expansion cabinet located up to 3 km (1.8 mi.) of the main cabinet.
- The NTDK85 Expansion Daughterboard has the same features as the NTDK24 except that it can interface with two expansion cabinets.
- The NTDK79 Expansion Daughterboard provides the same functions as the NTDK24 except that it connects to Single Mode glass fiber optic cable.

- The NTDK99 (single-port) and NTDK83 (dual-port) 100BaseT IP Daughterboards provide connectivity to IP expansion cabinets located within 100m.
- The NTTK01 (single-port) and NTTK02 (dual-port) 100BaseF IP Daughterboards provide connectivity to IP expansion cabinets located within 2 km.

Note: Third party media conversion devices can be used to extend the range of IP Expansion cabinets from the Main Option 11C cabinet. Refer to later in this chapter for more information.

A sample of these daughterboards is shown in Figure 19.

Table 67
Expansion Daughterboards

Daughterboard	Number of ports	Cable type	Max. distance between Main and expansion cabinets
NTDK22	one	A0618443 Fiber Optic plastic cable	10 m (33 ft.)
NTDK84	two		
NTDK24	one	glass fiber optic cable	3 km (1.8 mi)
NTDK85	two		
NTDK79	one	Single Mode glass fiber optic cable	
NTDK99	one	100baseT cable (see "EMC grounding clip" on page 213)	100 m (328 ft.), or over 20 km (12 mi) with a third party converter
NTDK83	two		
NTTK01	one	100baseF fiber optic cable	2 km (1.2 mi), or over 20 km (12 mi) with a third party converter
NTTK02	two		

Figure 19
Expansion Daughterboards

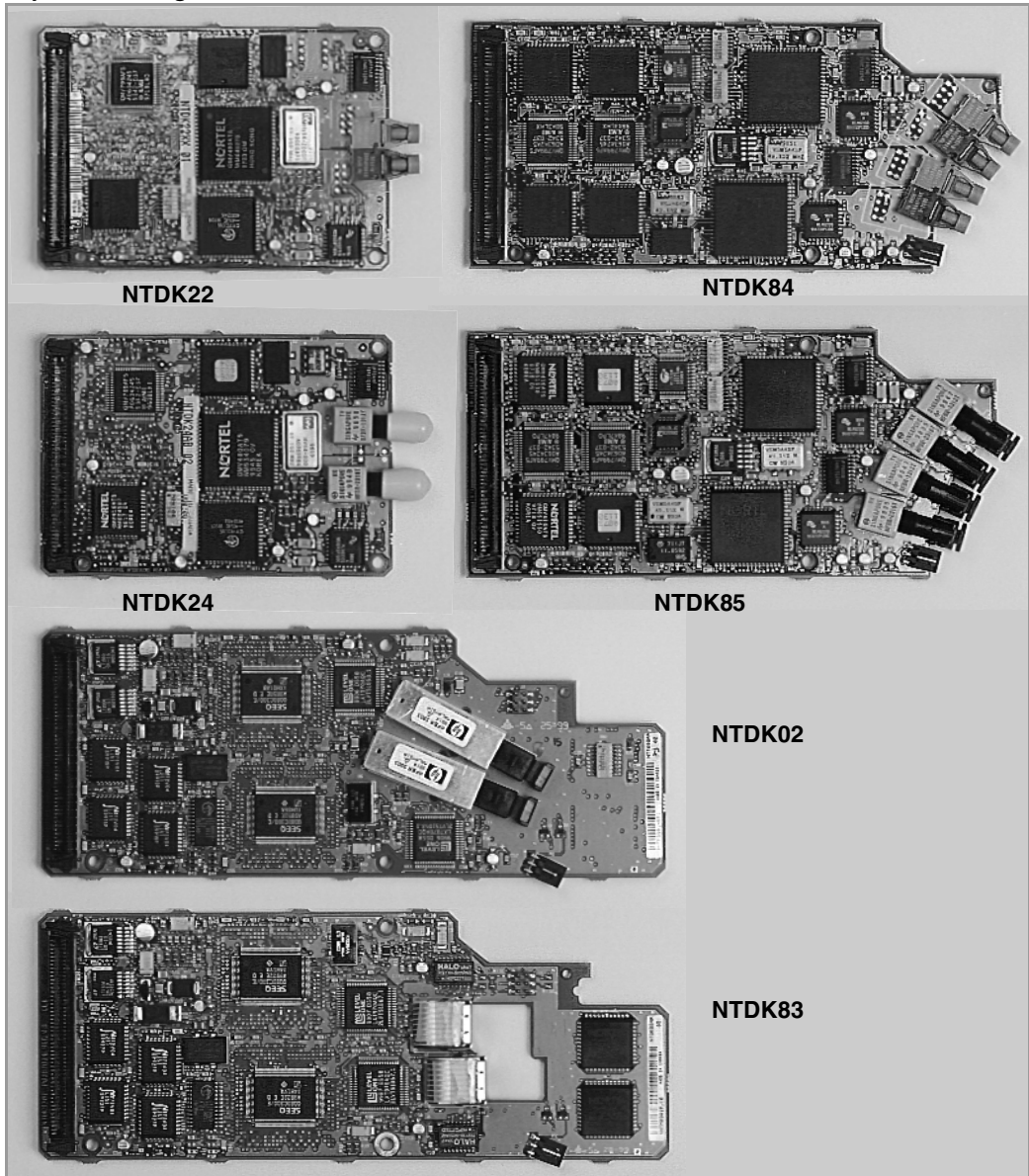

EMC grounding clip

Option 11C and Option 11C Mini Main cabinets connected with 100BaseT IP connectivity, must route the cables through the EMC grounding clip. This ensures electrical contact between the ground rail and 100BaseT cable for EMC containment

The NTDK41AA EMC grounding clip is used on the Option 11C system on each IP Expansion cabinet.

Figure 20
EMC grounding clip on Option 11C Main cabinet

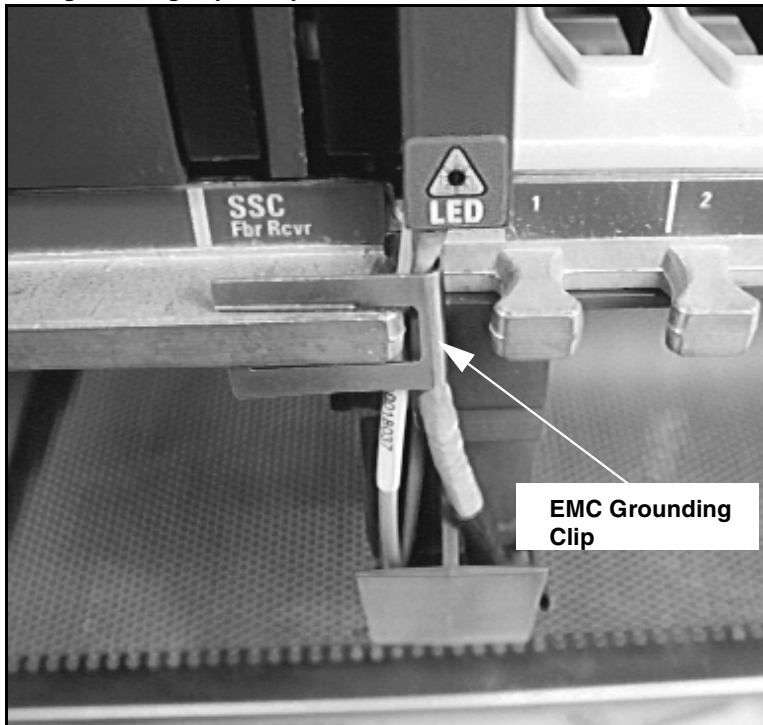

The NTKK43AA EMC grounding clip is used on the Option 11C Mini Main chassis and IP Expansion chassis.

Figure 21
EMC Grounding Clip on Option 11C Mini Cabinet

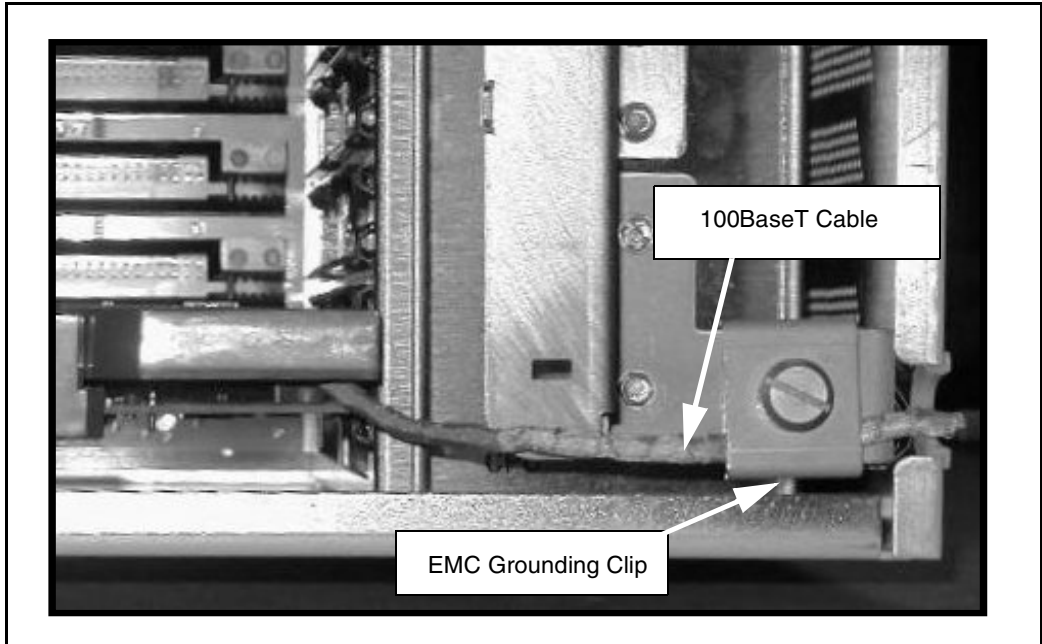

CAUTION

Use of the EMC grounding clip is required for EMC compliance.

For further information or installation instructions, refer to the *Option 11C Mini Planning and Installation (553-3021-209)* and *Option 11C Planning and Installation (553-3021-210)*.

Figure 22
NTDK20 SSC card and Expansion Daughterboard

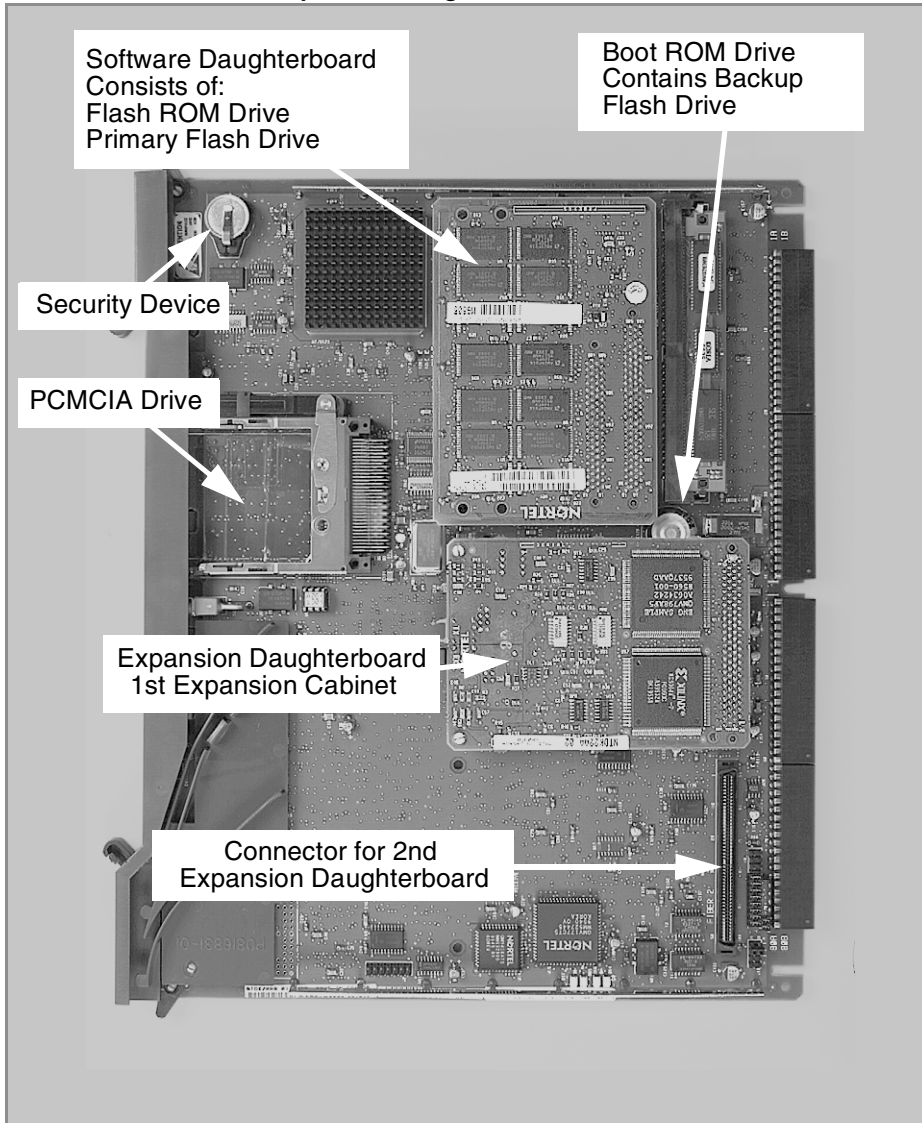

Fiber Receiver cards.

Fiber Receiver cards in fiber expansion cabinets, allow for fiber connectivity between the Main Option 11C and 11C Mini and up to four fiber expansion cabinets/chassis.

There are three versions of the Fiber Receiver card, each of which has a corresponding fiber daughterboard:

- 1** The NTDK23 Fiber Receiver card is used when the expansion cabinet is within 10 m (33 ft.) of the main cabinet. It connects to one A0618443 Fiber Optic plastic cable.
- 2** The NTDK25 Fiber Receiver card is used when the expansion cabinet is between 10 m (33 ft.) and 3 km (1.8 mi.) of the main cabinet. It connects to one glass multi-mode fiber optic cable which is dedicated to the Option 11C system.
- 3** The NTDK80 Fiber Receiver card provides the same functions as the NTDK25 except that it connects to Single Mode fiber optic cable and is used for connections over 3 km.

Figure 23
Fiber Receiver card in fiber expansion cabinet (NTDK23 shown)

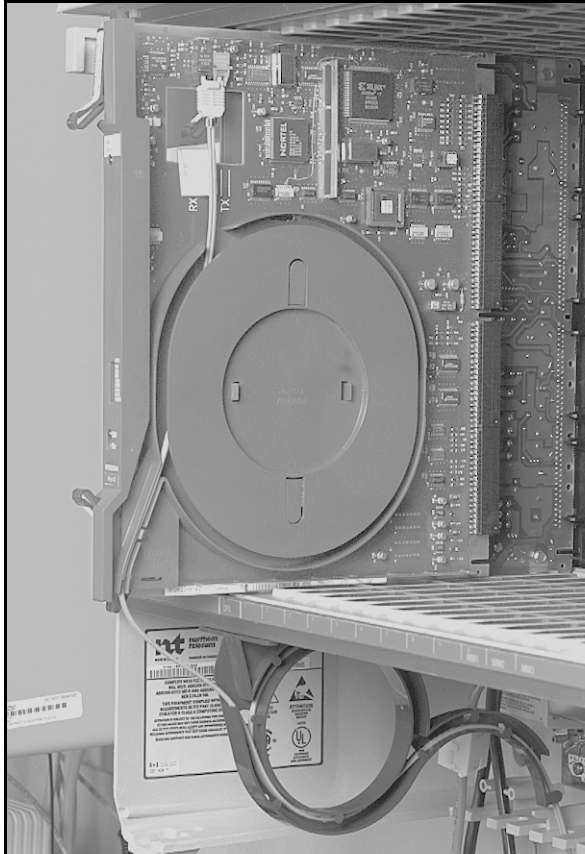

PCMCIA interface

The NTDK20 SSC card has a PCMCIA interface through a socket located on its faceplate. The PCMCIA socket can accommodate a Software Delivery card used for software upgrading and as backup media.

Security device for the IP Expansion

The SSC card on the Option 11C Main cabinet must contain a NTDK57AA Security device which is keyed to match the NTDK57DA Security device on each IP expansion cabinet.

This maintains the requirement of a single keycode for each Option 11C system with survivable IP expansion cabinets. Refer to Table 22, "NTDK20 SSC card and Expansion Daughterboard," on page 215 for the location of the device.

The main objectives of this security scheme are

- 1 to allow the system to operate as a single system when all links are up.
- 2 to allow the Survivable IP Expansion cabinet to continue operating with its existing configuration in the event of a failure of the Main, or of the link to the Main.
- 3 to prevent users from configuring or using more TNs or features than have been authorized.

The IP expansion cabinet security device will provide the following capabilities at the expansion cabinet:

- System software can be installed but no calls will be processed or features activated until communication with a main has been established and a match between the security id of the main and the IP Expansion cabinet has been confirmed.
- System software can be upgraded.
- Local data dump is not permitted, as well as all Overlay 43 and Overlay 143 commands.

SDI ports

The NTDK20 SSC card contains three SDI ports used to connect on-site terminals or remote terminals through a modem. The default settings on the ports are as follows:

Table 68
Default SDI port settings on the NTDK20 SSC card

TTY Port	Baud rate	Data bits	Stop bits	Parity	Use
0	Set by a DIP switch	8	1	None	MTC/SCH/BUG
1	1200	8	1	None	MTC/SCH/BUG
2	1200	8	1	None	MTC/SCH/BUG

Refer to “SDI ports” on page 227 of this guide for more information on the SDI ports.

Conferencing

Thirty-two conference channels are provided by the NTDK20 SSC card’s conference devices. Conference capability can be increased by mounting expansion daughterboards on the NTDK20 SSC card. Each daughterboard increases the total number of conference channels by 16: the maximum number of conference ports is 64.

Each conference device provides 16 ports of conferencing capabilities (one conference participant for each port). A conference call can have three to six participants. To illustrate, you can have a maximum of five 3-party conferences for each device, or two 6-party conferences plus one 3-party conference. It is not possible to conference between conference devices.

IP expansion 10BaseT port

The Option 11C system provides one 10 Mbps Ethernet connection to a Local Area Network (LAN). The 10BaseT Ethernet port available on the SSC of an IP Expansion cabinet is functional. However, the Ethernet port on the IP Expansion cabinet does not have a default IP configuration. This means that the IP port configuration must be performed before it can be used.

It is not recommended to use the remote 10BaseT port in normal mode as maintenance or alarm management are not available. In survival mode it assumes the system level configuration of the main cabinet port.

External connections to the ethernet port is provided by a 50-pin connector located in the main cabinet. An NTDK27 Ethernet Adaptor cable adapts this 50-pin connector to the standard 15-pin AUI interface for a MAU.

Network Switching and signalling

Option 11C has thirty DS-30X loops. The main cabinet accommodates the first ten loops, the first expansion cabinet accommodates the second ten loops, the second expansion cabinet provides the third ten, the third expansion cabinet provides the fourth ten, and the fourth expansion cabinet provides the fifth ten.

Each IPE circuit card has a loop entirely dedicated to it. Every group of four IPE card slots is programmed as an individual superloop. The superloop configuration is as follows:

Table 69
Option 11C superloops

Main Cabinet			First Expansion Cabinet			Second Expansion Cabinet			Third Expansion Cabinet			Fourth Expansion Cabinet		
Card Slot	CE Loop	Super Loop	Card Slot	CE Loop	Super Loop	Card Slot	CE Loop	Super Loop	Card Slot	CE Loop	Super Loop	Card Slot	CE Loop	Super Loop
1	20	0	11	—	8	21	—	32	31	—	40	41	—	64
2	21	0	12		8	22		32	32		40	42		64
3	22	0	13		12	23		32	33		44	43		64
4	23	0	14		12	24		32	34		44	44		64
5	24	4	15		12	25		36	35		44	45		68
6	25	4	16		12	26		36	36		44	46		68
7	26	4	17		16	27		36	37		48	47		68
8	27	4	18		16	28		36	38		48	48		68
9	28	8	19		16	29		40	39		48	49		72
10		8	20		16	30		40	40		48	50		72

There are a total of 640 timeslots (channels) for each Option 11C system. Each superloop provides 120 timeslots, while an IPE slot provides 30 timeslots.

Tone services

The NTDK20 SSC card incorporates the functions of the existing NTAK03 TDS/DTR, NT5K20 XTD and NT5K48 XTD cards.

NTDK97 Mini System Controller card

The NTDK97 Mini System Controller (MSC) card is used exclusively with the Option 11C Mini Main cabinet when one (only) expander chassis is connected to the Mini Main. It controls call processing and stores system and customer data. The NTDK97 MSC card is comprised of the following components and features:

- Flash memory, DRAM, Boot ROM, and Backup memory
- One PCMCIA socket
- Three Serial Data Interface (SDI) ports
- 16 channels of Conferencing
- One Ethernet (10 Mbps interface) port
- 30 channels of tone and digit switch (TDS) and a combination of eight Digitone receivers (DTR) or dial tone detectors (XTD)
- Networking and Peripheral Signalling
- Additional tone service ports (four units of MFC/MFE/MFK5/MFK6/MFR or eight DTR/XTD units)

Memory

Flash Memory

The majority of system and customer configured data is both controlled and stored on the NTDK97 MSC card's Flash ROM. (This memory is located on the motherboard. It is not on a separate daughterboard as is the case for the NTDK20.)

The NTDK97AB contains 48 MBytes of flash memory storage:

- 32 MBytes are used for operating system programs and overlay programs.
- 16 Mbytes are used for the Primary Flash Drive, also referred to as the c: drive. The Primary Flash Drive stores the primary copy of the customer data, patches, and other configuration data.

Boot ROM and Backup Memory

Boot ROM and backup memory is a 2 Mbyte storage device located on the NTDK97 MSC card. The boot code is stored in this memory. This memory also contains the backup flash drive, also referred to as the z: drive. The backup flash drive stores a backup copy of key system data, the customer database, and patches. The minimum release of bootcode for the MSC is NTDK34FA Release 03. You should upgrade the boot code to the latest issue each time the software is upgraded. The boot code can be found on the programmed PCMCIA card.

DRAM

The NTDK97 MSC card is equipped with 16 Mbytes of temporary memory space called DRAM. (This memory is located on the motherboard. It is not on a separate SIMM.) DRAM functions much like RAM on a computer system, whereby system and user files are stored while the system is up and running. DRAM on the Option 11C Mini stores operating system files, overlay data, patch codes, and the active copy of the customer database.

Figure 24
NTDK97 MSC card



PCMCIA interface

The NTDK97 MSC card has a PCMCIA interface socket located on its faceplate. The PCMCIA socket can accommodate a Software Delivery card used for software upgrading and as backup media.

SDI ports

The NTDK97 MSC card contains three SDI ports used to connect on-site terminals or remote terminals through a modem. The default settings on the ports are as follows:

Table 70
Default SDI port settings on the NTDK97 MSC card

TTY Port	Baud rate	Data bits	Stop bits	Parity	Use
0	Set by a DIP switch	8	1	None	MTC/SCH/BUG
1	1200	8	1	None	MTC/SCH/BUG
2	1200	8	1	None	MTC/SCH/BUG

Refer to “SDI ports” on page 227 of this guide for more information on the SDI ports.

Conferencing

Sixteen conference channels are provided by the NTDK97 MSC card’s conference device.

The conference device provides 16 ports of conferencing capabilities (one conference participant per port). A conference call can have three to six participants. To illustrate, you can have a maximum of five 3-party conferences per device, or two 6-party conferences plus one 3-party conference.

Ethernet Interface

The NTDK97 MSC card is equipped with a 10 Mbps Ethernet port. A 15 pin connector located in the back of the main chassis provides an external connection to the ethernet port. This is for a standard 15-pin AUI interface for a MAU.

Network Switching and signalling

Option 11C Mini has 10 DS-30x loops. The main chassis accommodates the first 6 (loops 4, 5, and 6 occupy slot 4). The chassis expander accommodates the last 4.

Each IPE circuit card has a loop entirely dedicated to it. Every group of four Option 11C card slots is programmed as an individual superloop. The superloop configuration is as follows:

Table 71
Option 11C Mini superloops

Main Chassis			Chassis Expander		
Card Slot	CE Loop	Super Loop	Card Slot	CE Loop	Super Loop
1	20	0	7	26	4
2	21	0	8	27	4
3	22	0	9	28	8
4	23	0	10		8
5	24	4			
6	25	4			

Each superloop provides 120 timeslots, while an IPE slot provides 30 timeslots.

Tone services

The NTDK97 MSC card incorporates the functions of the existing NTAK03 TDS/DTR, NT5K20 XTD, and NT5K48 XTD cards.

Chapter 8 — SDI ports

Contents

This section contains information on the following topics:

Introduction	227
System controller cards	228
NTAK03 TDS/DTR card	231
Connecting to the ports	231
NTAK02 SDI/DCH card	234
Connecting to the ports	236
Characteristics of the low speed port	237
Characteristics of the high speed port	240
ESDI settings	240
NTDK23, NTDK25, and NTDK80 Fiber Receiver cards	241
Parameter settings	241
Connection to external equipment	242

Introduction

This chapter describes the ports on the Option 11C system. Serial Data Interface (SDI) ports are used to connect devices such as terminals and modems to the Option 11C. The two types of SDI ports supported are:

- Data Terminal Equipment (DTE); typically a TTY or computer
- Data Communication Equipment (DCE); typically a modem

SDI ports are found on the SSC card, the optional TDS/DTR card, and the optional SDI/DCH card. An additional SDI port is located on the Fiber Receiver card to allow remote TTY access.

The possible Option 11C SDI port configurations are summarized in Table 72.

Table 72
SDI Port configurations

Circuit Card	Number of Ports	DTE	DCE	RS232	RS422
SSC NTDK20	3	Yes	No	Port 0	No
TDS/DTR NTAK03	2	Ports 0/1	No	Ports 0/1	No
SDI/DCH NTAK02	4	Ports 0/1/ 2/3	Ports 0/1/ 2/3	Ports 0/1/ 2/3	Ports 1/3
NTDK23 Fbr Rcvr card	1	Yes	No	Yes	No
NTDK25 and NTDK80 Fbr Rcvr card	1	Yes	No	Yes	No

System controller cards

The NTDK20 Small System Controller card (used with Option 11C), and the NTDK97 MSC card (used with Option 11C Mini) are each equipped with three SDI ports.

Each port can be used to connect a modem or terminal to the system. If connection to a terminal is desired, an A0378652 NO modem (NULL modem without hardware handshaking) is required.

For the Option 11C, the SDI port connector is located at the bottom rear of the cabinet next to the connectors to the cross connect terminal. (An NTBK48 three-port cable is required to connect to system equipment.) Refer to Figure 25 on page 229.

Figure 25
Option 11C SDI cable connector

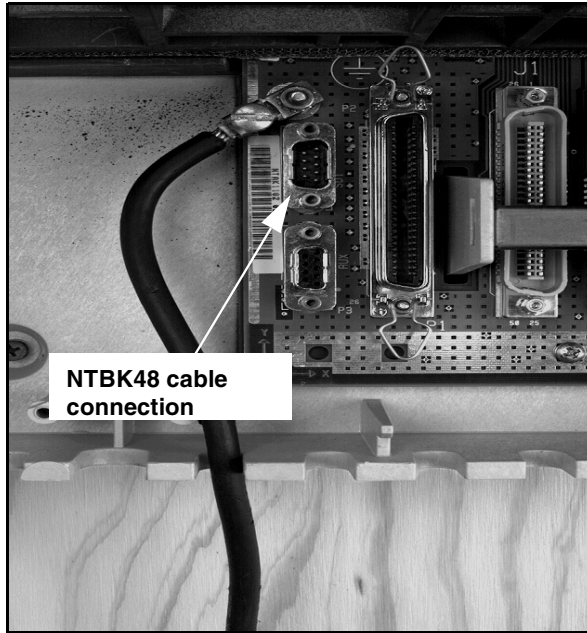

For the Option 11C Mini, the SDI port connector is located on the bottom left side at the rear of the main chassis.

Figure 26
Option 11C Mini SDI cable connector

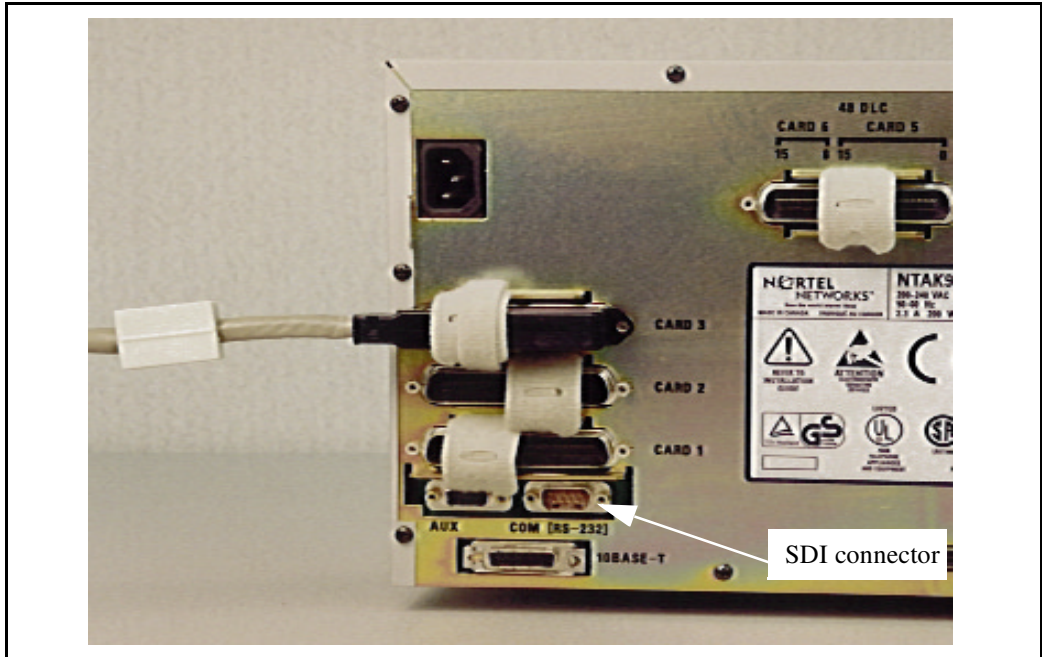

The Baud rate for port 0 is selected by setting switches on the faceplate of the SCC, SSC, and MSC cards. Baud rates for ports 1 and 2 are set using overlay programs.

The baud rates available on all three ports are 300, 600, 1200, 2400, 4800, and 19200 baud.

Table 73
Default port configuration

TTY Number	Card	Port	Use	Configuration
0	0	0	MTC/SCH/BUG	1200/8/1/NONE
1	0	1	MTC/SCH/BUG	1200/8/1/NONE
2	0	2	CTY	1200/8/1/NONE

NTAK03 TDS/DTR card

Table 74 shows the default settings.

Table 74
Default port configuration

TTY Number	Card	Port	Use	Configuration
0	0	0	MTC/SCH/BUG	1200/8/1/NONE
1	0	1	MTC/SCH/BUG	1200/8/1/NONE
2	0	2	CTY	1200/8/1/NONE

The NTAK03 TDS/DTR card is replaced by the NTDK20 SSC card in Option 11C, and the NTDK97 MSC in Option 11C Mini. However, it is still supported and can be retained to gain access to extra ports.

Connecting to the ports

The methods by which external devices may be connected to the TDS/DTR card are:

- Use the NTAK19EC two port SDI cable. The NTAK19EC cable does not have to be terminated at the cross connect terminal since it is equipped with connectors.
- Use the NE-A25-B cable and terminate it at the cross connect terminal. Tables 75 and 76 give the pinouts for the TDS/DTR card.

Table 75
NTAK03 connections at the cross-connect terminal— Port 0

Pair	Color	Signal	Designations I=input O=output
1T	W-BL	DSR	I
1R	BL-W	DCD	I
2T	W-O	-	-
2R	O-W	DTR	O
3T	W-G	RTS	O
3R	G-W	CTS	I
4T	W-BR	RX	I
4R	BR-W	TX	O
5T	W-S	SG	O
5R	S-W	-	-

Table 76
NTAK03 connections at the cross-connect terminal— Port 1

Pair	Color	Signal	Designations I=input O=output
6T 6R	R-BL BL-R	DSR -	I -
7T 7R	R-O O-R	- DTR	- O
8T 8R	R-G G-R	RTS CTS	O I
11T 11R	BK-BL BL-BK	RX TX	I O
13T 13R	BK-G G-BK	- DCD	- I
22T 22R	V-O O-V	SG -	O -

Other pertinent information on the TDS/DTR ports is given below:

- **Baud rates:** 00; 600; 1200; 2400; 4800; 9600; 19,200
Default 1200.
- **Data bits:** 5, 6, 7, 8
Default 8.
- **Parity:** none, odd, even.
Default none.
- **Stop bits:** 1, 1.5, 2
Default 1
- **Flow control:** none, XON/XOFF, CTS/RTS
Default none.

NTAK02 SDI/DCH card

The optional SDI/DCH card provides a maximum of four serial I/O ports, which are grouped into two pairs:

- port 0 and port 1
and
- port 2 and port 3

Ports 1 and 3 may be configured as DCH or ESDI. Ports 0 and 2 may only be configured as SDI. Each pair is controlled by a switch, as shown in Table 77.

Table 77
Switch settings

Port 0	Port 1	SW 1-1	SW 1-2
SDI	DCH/DPNSS	OFF	OFF
SDI	DCH/DPNSS	OFF	ON
—	ESDI	ON	ON

Port 2	Port 3	SW 1-3	SW 1-4
SDI	DCH/DPNSS	OFF	OFF
SDI	DCH/DPNSS	OFF	ON
—	ESDI	ON	ON

In the U.K, DPNSS (Digital Private Network Signalling System) can replace the DCH function.

Two ports offer the option for DTE/DCE configuration. This option is selected from a jumper on the card. Table 78 shows the jumper settings:

Table 78
Jumper settings

Port	Jumper location	Strap for DTE	Strap for DCE	Jumper location	RS422	RS232
0	J10	C - B	B - A			
1	J7 J6	C - B C - B	B - A B - A	J9 J8	C - B C - B	B - A B - A
2	J5	C - B	B - A			
3	J4 J3	C - B C - B	B - A B - A	J2 J1	C - B C - B	B - A B - A

Connecting to the ports

The methods by which external devices may be connected to the SDI/DCH card are:

- Use the NTA19FB four port SDI cable. This cable does not have to be terminated at the cross connect terminal since it is equipped with connectors.
- Use the NE-A25-B cable and terminate it at the cross connect terminal. Tables 79 through 82 give the pinouts for the SDI/DCH card.

Table 79
NTAK02 pinouts — Port 0 at the cross-connect terminal

Cable		RS232			
		Signal		Designations I=input O=output	
Pair	Color	DTE	DCE	DTE	DCE
1T 1R	W-BL BL-W	0 DTR	0 DCD	- O	- I
2T 2R	W-O O-W	DSR DCD	CH/CI DTR	I I	O O
3T 3R	W-G G-W	RTS CTS	CTS RTS	O I	I O
4T 4R	W-BR BR-W	RX TX	TX RX	I O	O I
5T 5R	W-S S-W	- SG	- SG	- -	- -

Table 80
NTAK02 connections at the cross-connect terminal — Port 1

Cable		RS422				RS232			
		Signal		Designations I=input O=output		Designations I=input O=output		Signal	
Pair	Color	DTE	DCE	DTE	DCE	DTE	DCE	DTE	DCE
5T 5R	W-S S-W	SCTEA -	SCTA -	O -	I -	O -	I -	SCT -	SCT -
6T 6R	R-BL BL-R	SCTEB DTR	SCTB DCD	O O	I I	- -	- -	CH/CI DTR	- DCD
7T 7R	R-O O-R	DSR DCD	CH/CI DTR	I I	O O	I I	O O	DSR DCD	CH/CI DTR
8T 8R	R-G G-R	RTS CTS	CTS RTS	O I	I O	O I	I O	RTS CTS	CTS RTS
9T 9R	R-BR BR-R	SCRA SCTA	SCTEA RXCA	I I	O O	I I	O O	SCR SCT	SCT -
10T 10R	R-S S-R	SCRB SCTB	SCTEB RXCB	I I	O O	- -	- -	- -	- -
11T 11R	BK-BL BL-BK	RXDA TXDA	TXDA RXDA	I O	O I	I O	O I	RXD TXD	TXD RXD
12T 12R	BK-O O-BK	RXDB TXDB	TXDB RXDB	I O	O I	- -	- -	- -	- -
25T 25R	V-S S-V	SG -	SG -	- -	- -	- -	- -	SG -	SG -

Characteristics of the low speed port

Ports 0 and 2 are asynchronous, low speed ports. They transfer data to and from the line one bit at a time.

Table 81
NTAK02 connections at the cross-connect terminal — Port 2

Cable		RS422				RS232			
		Signal		Designations I=input O=output		Designations I=input O=output		Signal	
Pair	Color	DTE	DCE	DTE	DCE	DTE	DCE	DTE	DCE
13T 13R	BK-G G-BK			- -	- -	- O	- I	- DTR	- DCD
14T 14R	BK-BR BR-BK			- -	- -	I I	O O	DSR DCD	CH/CI DTR
15T 15R	BK-S S-BK			- -	- -	O I	I O	RTS CTS	CTS RTS
16T 16R	Y-BL BL-Y			- -	- -	I O	O I	RX TX	TXD RXD
17T 17R	Y-O O-Y			O -	I -	O -	I -	- SG	- SG

Table 82
NTAK02 connections at the cross-connect terminal — Port 3 (Part 1 of 2)

Cable		RS422				RS232			
		Signal		Designations I=input O=output		Designations I=input O=output		Signal	
Pair	Color	DTE	DCE	DTE	DCE	DTE	DCE	DTE	DCE
17T 17R	Y-O O-Y	SCTEA -	SCTA -	O -	I -	O -	I -	SCT -	SCT -
18T 18R	Y-G G-Y	SCTEB DTR	SCTB DCD	O O	I I	- -	- -	CH/CI DTR	- DCD

Table 82
NTAK02 connections at the cross-connect terminal — Port 3 (Continued) (Part 2 of 2)

Cable		RS422				RS232			
		Signal		Designations I=input O=output		Designations I=input O=output		Signal	
Pair	Color	DTE	DCE	DTE	DCE	DTE	DCE	DTE	DCE
19T 19R	Y-BR BR-Y	DSR DCD	CH/CI DTR	I I	O O	I I	O O	DSR DCD	CH/CI DTR
20T 20R	Y-S S-Y	RTS CTS	CTS RTS	O I	I O	O I	I O	RTS CTS	CTS RTS
21T 21R	V-BL BL-V	SCRA SCTA	SCTEA RXCA	I I	O O	I I	O O	SCR SCT	SCT -
22T 22R	V-O O-V	SCRB SCTB	SCTEB RXCB	I I	O O	- -	- -	- -	- -
23T 23R	V-G G-V	RXDA TXDA	TXDA RXDA	I O	O I	I O	O I	RXD TXD	TXD RXD
24T 24R	V-BR BR-V	RXDB TXDB	TXDB RXDB	I O	O I	- -	- -	- -	- -
25T 25R	V-S S-V	- SG	- SG	- -	- -	- -	- -	SG -	SG -

The characteristics of the low speed port are as follows:

- **Baud rate:** 300; 600; 1200; 2400; 4800; 9600; 19,200
Default 1200.
- **Parity:** Odd, even, none.
Default none.
- **Stop bits:** 1, 1.5, 2
Default 1
- **Flow control:** XON/XOFF, CTS, none.
Default none.
- **Duplex:** Full.

- **Interface:** RS-232-D
- **Data bits:** 5, 6, 7, 8
Default 8.

Characteristics of the high speed port

Ports 1 and 3 are synchronous, high speed ports with the following characteristics:

- **Baud rate:** 1200; 2400; 4800; 9600; 19,200; 56,000; 64,000.
- **Data bit:** Transparent (1).
- **Duplex:** Full.
- **Clock:** Internal or external.
- **Interface:** RS-232-D, RS-422-A.

ESDI settings

Port 9 is pre-programmed as an ESDI port and supports Meridian Mail. It functions as a Command Status Link with settings as shown in Table 83.

Table 83
ESDI settings (Part 1 of 2)

Setting	Code
ESDI	YES
SYNC	YES
DUPX	FULL
BPS	4800
CLOK	EXT
IADR	003
RADR	001
T1	10
T2	002

Table 83
ESDI settings (Part 2 of 2)

T3	040
N1	128
N2	08
K	7
RXMT	05
CRC	10
ORUR	005
ABOR	005
USER	CMS

NTDK23, NTDK25, and NTDK80 Fiber Receiver cards

Both the NTDK23, NTDK25 and NTDK80 Receiver cards used in Option 11C support one Serial Data Interface (SDI) port.

Parameter settings

Baud rates are selected by setting switches located in the faceplate of each Fiber Receiver card. The available settings are:

- 150, 300, 600, 1200, 2400, 4800, 9600 and 19200 baud

Other RS232 parameters are fixed as shown in Table 84.

Table 84
Fixed parameter settings

Parameter	Setting
Parity	None
Mode	Asynchronous
Stop Bits	1
Data Bits	8

The port can be used for MTC/SCH/BUG modes.

Connection to external equipment

The connection to external devices (such as TTYs, Modems and so on) is achieved through the nine-pin SDI connector located in the expansion cabinet. It is extended to the external equipment with an NTAK1118 single port SDI cable.

Chapter 9 — The TDS/DTR card

Contents

This section contains information on the following topics:

Introduction	243
Features	244
Tone Transmitter	244
Tone Detector	244
SDI function	244
Tones and Cadences	244

Introduction

The TDS/DTR card function was incorporated into the NTDK20 SSC used with Option 11C. However, it is still supported on the system.

The TDS/DTR functionality is also incorporated into the NTDK97 MSC card used with Option 11C Mini. The TDS/DTR is not required in a 2 chassis Option 11C Mini configuration.

The TDS/DTR card can occupy any of slot numbers 1 - 9 in the main cabinet. it must be manually programmed in LD 13 (for DTR) and LD 17 (for TDS and TTY).

The TDS/DTR card can not be placed in the expansion cabinet or slot 10 of the main cabinet.

The TDS/DTR card provides:

- 30 channels of Tone and Digit Switch
- Two Serial Data Interface ports
- 8 tone detection circuits configured as Digitone Receivers

Features

Tone Transmitter

The TDS/DTR tone transmitter provides 30 channels of tone transmission. Up to 256 tones are available as u-Law or A-Law and up to 256 bursts and cadences are downloaded from the CPU.

The TDS/DTR card does not provide the Music on Hold feature as do other Meridian 1 TDS cards. The music source must come from a standard Meridian 1 trunk card.

Tone Detector

The TDS/DTR card provides eight channels of DTMF (Dual Tone Multi-Frequency) detection in A-Law or μ -Law.

In North America, pre-programmed data is configured for μ -Law tone detection.

SDI function

The TDS/DTR card provides two SDI (Serial Data Interface) ports.

Refer to the “SDI ports” on page 227 in this guide for more information on the TDS/DTR card SDI ports.

Tones and Cadences

The following tables give the tones and cadences provided by the NTAK03 TDS/DTR card.

Table 85
NTAK03, NTDK20, and NTDK97 μ -Law tones and cadence (Part 1 of 6)

Tone #	Frequency (Hz)	dB below overload	Precision Ringing Tones	DTMF Digits	MF Digits
1	350/440	-23/-23	√		
2	(533 + 666) x 10	-23/-23	√		
3	440	-23	√		
4	350/440	-19/-19	√		
5	440/480	-25/-25	√		
6	480	-23	√		
7	480/620	-30/-30	√		
8	1020	-16	√		
9	600	-23	√		
10	600	-16	√		
11	440/480	-22/-22	√		
12	350/480	-23/-23	√		
13	440/620	-24/-24	√		
14	940/1630	-12/-10		P	
15	700/1210	-12/-10		1	
16	700/1340	-12/-10		2	
17	700/1480	-12/-10		3	
18	770/1210	-12/-10		4	

Table 85
NTAK03, NTDK20, and NTDK97 μ -Law tones and cadence (Part 2 of 6)

Tone #	Frequency (Hz)	dB below overload	Precision Ringing Tones	DTMF Digits	MF Digits
19	770/1340	-12/-10		5	
20	770/1480	-12/-10		6	
21	850/1210	-12/-10		7	
22	850/1340	-12/-10		8	
23	850/1480	-12/-10		9	
24	940/1340	-12/-10		0	
25	940/1210	-12/-10		*	
26	940/1480	-12/-10		#	
27	700/1630	-12/-10		Fo	
28	770/1630	-12/-10		F	
29	850/1630	-12/-10		I	
30	reserved				
31	reserved				
32	reserved				
33	400	-19	√		
34	[400 x (120@85%)]	-19	√		
35	940/1630	-17/-15		P	
36	700/1210	-17/-15		1	
37	700/1340	-17/-15		2	
38	700/1480	-17/-15		3	

Table 85
NTAK03, NTDK20, and NTDK97 μ -Law tones and cadence (Part 3 of 6)

Tone #	Frequency (Hz)	dB below overload	Precision Ringing Tones	DTMF Digits	MF Digits
39	770/1210	-17/-15		4	
40	770/1340	-17/-15		5	
41	770/1480	-17/-15		6	
42	850/1210	-17/-15		7	
43	850/1340	-17/-15		8	
44	850/1480	-17/-15		9	
45	940/1340	-17/-15		0	
46	940/1210	-17/-15		*	
47	940/1480	-17/-15		#	
48	700/1630	-17/-15		Fo	
49	770/1630	-17/-15		F	
50	850/1630	-17/-15		I	
51	reserved				
52	reserved				
53	1300/1500	-13/-13			0
54	700/900	-13/-13			1
55	700/1100	-13/-13			2/CC
56	900/1100	-13/-13			3
57	700/1300	-13/-13			4
58	900/1300	-13/-13			5
59	1100/1300	-13/-13			6

Table 85
NTAK03, NTDK20, and NTDK97 μ -Law tones and cadence (Part 4 of 6)

Tone #	Frequency (Hz)	dB below overload	Precision Ringing Tones	DTMF Digits	MF Digits
60	700/1500	-13/-13			7
61	900/1500	-13/-13			8
62	1100/1500	-13/-13			9
63	700/1700	-13/-13			ST3P/RB/ C11
64	900/1700	-13/-13			STP/C12
65	1100/1700	-13/-13			KP/CR/KP1
66	1300/1700	-13/-13			ST2P/KP2
67	1500/1700	-13/-13			ST/CC
68	400	-11	√		
69	400	-14	√		
70	400 x 50	-14	√		
71	(533 + 666) x 20	-23/-23	√		
72	reserved				
73	350/440	-15/-15	√		
74	480/620	-15/-15	√		
75	440/480	-15/-15	√		
76	400	-25	√		
77	400/450	-14/-14	√		
78	480/620	-19/-19	√		

Table 85
NTAK03, NTDK20, and NTDK97 μ -Law tones and cadence (Part 5 of 6)

Tone #	Frequency (Hz)	dB below overload	Precision Ringing Tones	DTMF Digits	MF Digits
79	440/480	-19/-19	√		
80	480	-19	√		
81	420	-9	√		
82	440	-29	√		
83	reserved				
84	350/440	-17/-17	√		
85	400/450	-17/-17	√		
86	400	-17	√		
87	1400	-26	√		
88	950	-12	√		
89	1400	-12	√		
90	1800	-12	√		
91	470	0	√		
92	940	0	√		
93	1300	0	√		
94	1500	0	√		
95	1880	0	√		
96	350/440	-10/-10			
97	TBD				

Table 85
NTAK03, NTDK20, and NTDK97 μ -Law tones and cadence (Part 6 of 6)

Tone #	Frequency (Hz)	dB below overload	Precision Ringing Tones	DTMF Digits	MF Digits
98	TBD				
99	TBD				
100	TBD				
101	600	-19	√		
102	800	-19	√		
103	1400	-23	√		
104	820	-7			

Note: Tones #1 - 16 (inclusive) and #234 - 249 (inclusive) are included for Norwegian and Malaysian specifications.

Table 86
NTAK03, NTDK20, and NTDK97 A-Law tones and cadences (Part 1 of 10)

Tone #	Frequency (Hz)	dB below overload	Precision Ringing Tones	DTMF Digits	MF Digits
1	940 X 1630	-14/-13		P	
2	700 X 1210	-14/-13		1	
3	700 X 1340	-14/-13		2	
4	700 X 1480	-14/-13		3	
5	770 X 1210	-14/-13		4	
6	770 X 1340	-14/-13		5	
7	770 X 1480	-14/-13		6	

Table 86
NTAK03, NTDK20, and NTDK97 A-Law tones and cadences (Part 2 of 10)

Tone #	Frequency (Hz)	dB below overload	Precision Ringing Tones	DTMF Digits	MF Digits
8	850 X 1210	-14/-13		7	
9	850 X 1340	-14/-13		8	
10	850 X 1480	-14/-13		9	
11	940 X 1340	-14/-13		0	
12	940 X 1210	-14/-13		*	
13	940 X 1480	-14/-13		#	
14	700 X 1630	-14/-13		F0	
15	770 X 1630	-14/-13		F	
16	850 X 1630	-14/-13		I	
17	1400	-37			
89	940/1630	-13/-12		P	
90	700/1210	-13/-12		1	
91	700/1340	-13/-12		2	
92	700/1480	-13/-12		3	
93	770/1210	-13/-12		4	
94	770/1340	-13/-12		5	
95	770/1480	-13/-12		6	
96	850/1210	-13/-12		7	
97	850/1340	-13/-12		8	
98	850/1480	-13/-12		9	
99	940/1210	-13/-12		0	

Table 86
NTAK03, NTDK20, and NTDK97 A-Law tones and cadences (Part 3 of 10)

Tone #	Frequency (Hz)	dB below overload	Precision Ringing Tones	DTMF Digits	MF Digits
100	940/1340	-13/-12		*	
101	940/1480	-13/-12		#	
102	700/1630	-13/-12		F0	
103	770/1630	-13/-12		F0	
104	850/1630	-13/-12		I	
105	350/440	-17/-17	√		
106	400/450	-17/-17	√		
107	1400	-26	√		
108	440	-23	√		
109	420	-9	√		
110	950	-12	√		
111	1400	-12	√		
112	1800	-12	√		
113	940/1630	-12/-10		P	
114	700/1210	-12/-10		1	
115	700/1340	-12/-10		2	
116	700/1480	-12/-10		3	
117	770/1210	-12/-10		4	
118	770/1340	-12/-10		5	
119	770/1480	-12/-10		6	

Table 86
NTAK03, NTDK20, and NTDK97 A-Law tones and cadences (Part 4 of 10)

Tone #	Frequency (Hz)	dB below overload	Precision Ringing Tones	DTMF Digits	MF Digits
120	850/1210	-12/-10		7	
121	850/1340	-12/-10		8	
122	850/1480	-12/-10		9	
123	940/1340	-12/-10		0	
124	940/1210	-12/-10		*	
125	940/1480	-12/-10		#	
126	700/1630	-12/-10		F0	
127	770/1630	-12/-10		F	
128	850/1630	-12/-10		I	
129	350/440	-22/-22	√		
130	400	-19	√		
131	400	-25	√		
132	400/450	-22/-22	√		
133	1400	-15	√		
134	950	-19	√		
135	1400	-20	√		
136	1800	-20	√		
137	420	-19	√		
138	940/1630	-18/-17		P	
139	700/1210	-18/-17		1	

Table 86
NTAK03, NTDK20, and NTDK97 A-Law tones and cadences (Part 5 of 10)

Tone #	Frequency (Hz)	dB below overload	Precision Ringing Tones	DTMF Digits	MF Digits
140	700/1340	-18/-17		2	
141	700/1480	-18/-17		3	
142	770/1210	-18/-17		4	
143	770/1340	-18/-17		5	
144	770/1480	-18/-17		6	
145	850/1210	-18/-17		7	
146	850/1340	-18/-17	√	8	
147	850/1480	-18/-17	√	9	
148	940/1340	-18/-17	√	0	
149	940/1210	-18/-17	√	*	
150	940/1480	-18/-17	√	#	
151	700/1630	-18/-17		F0	
152	770/1630	-18/-17		F	
153	850/1630	-18/-17		I	
154	(533 + 666) X 10	-23	√		
155	(533 + 666) X 20	-23	√		
156	400	-12	√		
157	820	-14	√		
158	420	-12	√		

Table 86
NTAK03, NTDK20, and NTDK97 A-Law tones and cadences (Part 6 of 10)

Tone #	Frequency (Hz)	dB below overload	Precision Ringing Tones	DTMF Digits	MF Digits
159	420	-25	√		
160	420 X 25	-12	√		
161	(553 + 666) X 10	-23	√		
162	(553 + 666) X 20	-23	√		
163	420	-22	√		
164	480	-22	√		
165	330	-11	√		
166	330/440	-11/-14	√		
167	1700	-19	√		
168	440	-14	√		
169	380	-8	√		
170	1400	-32	√		
171	820	-7		P	
172	850	-8		1	
173	420	-32		2	
174	reserved			3	
175	420	-6		4	
176	420	-2		5	
177	1020	-13		6	

Table 86
NTAK03, NTDK20, and NTDK97 A-Law tones and cadences (Part 7 of 10)

Tone #	Frequency (Hz)	dB below overload	Precision Ringing Tones	DTMF Digits	MF Digits
178	1800	-17		7	
179	1400	-23		8	
180	950	-29		9	
181	1400	-29		0	
182	1800	-29		*	
183	950	-22		#	
184	470	0		F0	
185	940	0		F	
186	1880	0		I	
187	400	-22			
188	420 X 25	-17			
189	950	-16			
190	950	-25			
191	940/1630	-9/-7			
192	700/1210	-9/-7			
193	700/1340	-9/-7			
194	700/1480	-9/-7			
195	770/1210	-9/-7			
196	770/1340	-9/-7			
197	770/1480	-9/-7			
198	850/1210	-9/-7			

Table 86
NTAK03, NTDK20, and NTDK97 A-Law tones and cadences (Part 8 of 10)

Tone #	Frequency (Hz)	dB below overload	Precision Ringing Tones	DTMF Digits	MF Digits
199	850/1340	-9/-7			
200	850/1480	-9/-7			
201	940/1340	-9/-7			
202	940/1210	-9/-7			
203	940/1480	-9/-7			
204	700/1630	-9/-7			
205	770/1630	-9/-7			
206	850/1630	-9/-7			
207	420	-10			
208	420	-8			
209	420	-4			
210	1400	-18			
211	1400	-9			
212	350/420	-9/-9			
213	420	-14			
214	450	-12			
215	450	-22			
216	820	-16			
217	350/420	-14/-14			
218	940/1630	-14/-12			
219	700/1210	-14/-12			

Table 86
NTAK03, NTDK20, and NTDK97 A-Law tones and cadences (Part 9 of 10)

Tone #	Frequency (Hz)	dB below overload	Precision Ringing Tones	DTMF Digits	MF Digits
220	700/1340	-14/-12			
221	700/1480	-14/-12			
222	770/1210	-14/-12			
223	770/1340	-14/-12			
224	770/1480	-14/-12			
225	850/1210	-14/-12			
226	850/1340	-14/-12			
227	850/1480	-14/-12			
228	940/1340	-14/-12			
229	940/1210	-14/-12			
230	940/1480	-14/-12			
231	700/1630	-14/-12			
232	770/1630	-14/-12			
233	850/1630	-14/-12			
234	940 X 1630	-17/-15		p	
235	700 X 1210	-17/-15		1	
236	700 X 1340	-17/-15		2	
237	700 X 1480	-17/-15		3	
238	770 X 1210	-17/-15		4	
239	770 X 1340	-17/-15		5	
240	770 X 1480	-17/-15		6	

Table 86
NTAK03, NTDK20, and NTDK97 A-Law tones and cadences (Part 10 of 10)

Tone #	Frequency (Hz)	dB below overload	Precision Ringing Tones	DTMF Digits	MF Digits
241	850 X 1210	-17/-15		7	

Chapter 10 — NTBK22 MISP card

Contents

This section contains information on the following topics:

Reference List	261
Overview	261
NTBK22 Multi-Purpose ISDN Signaling Processor (MISP)	261
Functional description	262
Micro Processing Unit (MPU)	263
High-Level Data Link Controller (HDLC)	263
Meridian 1 CPU to MISP bus interface	263
MISP network bus interface	263
Power consumption	264

Reference List

The following are the references in this section:

- *Option 11C ISDN BRI Hardware Installation and Maintenance (553-3011-311)*

Overview

NTBK22 Multi-Purpose ISDN Signaling Processor (MISP)

The NTBK22 Multi-Purpose ISDN Signaling Processor (MISP) card is specific to Option 11C system and is supported on the Main cabinet. It performs Data Link (Layer 2) and Network (Layer3) processing associated with ISDN BRI and the OSI protocol. A description of the ISDN BRI feature is contained in *Option 11C ISDN BRI Hardware Installation and Maintenance (553-3011-311)*.

Functional description

Each MISP can support 4 line cards (UILC or SILC or any combination of the two). Each line card supports 8 DSLs, therefore each MISP supports 32 DSLs. Since each DSL uses two B-channels and one D-channel the MISP supports 64 B-channels and 32 D-channels. If the MISP is carrying packet data, it must dedicate one of its D-channels to communicate with the external packet handler. In this case the MISP supports only 31 DSLs.

The main functions of the MISP are:

- to communicate with the CPU to report ISDN BRI status and receive downloaded application software and configuration parameters
- to manage *data link* layer and *network* layer signaling that controls call connection and terminal identification
- to control terminal initialization and addressing
- to assign B-channels for switched voice and data transmission by communicating with the BRI terminal over the D-channel and allocating to it an idle B-channel with appropriate bearer capabilities
- to separate D-channel data from signaling information and route the data to the packet handler
- to send call control messages to ISDN BRI terminals over the D-channel

The MISP supports the downloading of ISDN applications from the Option 11C software daughterboard. The MISP will be downloaded with the appropriate application code:

- on the first enabling of the MISP card
- when Option 11C Software is upgraded
- when MISP Applications are added/changed

The applications for the MISP are copied from the software cartridge into RAM on the MISP card. Only the new/different applications are downloaded. This information is then copied into the Flash ROM on the MISP for storage. This process requires approximately 10 minutes to complete and is carried out while the MISP pack is operational. The next time the system or MISP card resets, the application is loaded from the MISP Flash ROM provided there are no new or different applications on the software cartridge.

Micro Processing Unit (MPU)

The MPU coordinates and controls data transfer and addressing of the peripheral devices and communicates with the Meridian 1 CPU using a message channel on the CPU bus. The tasks that the MPU performs depend on the interrupts it receives. The interrupts are prioritized by the importance of the tasks they control.

High-Level Data Link Controller (HDLC)

The HDLC is a format converter that supports up to 32 serial channels that communicate at speeds up to 64 kbps. The HDLC converts messages into the following two message formats:

- a serially transmitted, zero-inserted, CRC protected message that has a starting and an ending flag
- a data structure

Meridian 1 CPU to MISP bus interface

Information exchange between the CPU and the MISP is performed with packetized messages transmitted over the CPU bus. This interface has a 16-bit data bus, an 18-bit address bus, and interrupt and read/write control lines.

This interface uses shared Static Random Access Memory (SRAM) as a communication exchange center between the CPU and the MPU. Both the CPU and the MPU can access this memory over the transmit and receive channels on the bus.

MISP network bus interface

The network bus interface:

- converts bit interleaved serial data received from the network bus into byte interleaved data for transmission over the 32 time slots used by the HDLC controller
- accepts byte interleaved data transmitted from the HDLC controller and converts it into a bit interleaved data stream for transmission over the network bus

Power consumption

Power consumption is +5V at 2 A; +15V at 50 mA; and -15V at 50 mA.

Chapter 11 — Meridian Digital Telephones

Contents

This section contains information on the following topics:

Reference List	265
Introduction	265
Functional description	266
Volume control	266
Line engineering	266
Local alerting tones	266
Powering requirements	267
Data characteristics	269

Reference List

The following are the references in this section:

- *Administration* (553-3001-311)
- *Maintenance* (553-3001-511)

Introduction

Meridian Digital Telephones are connected to the system through a 2-wire loop carrying two independent 64 kb/s PCM channels with associated signaling channels. One of the two PCM channels is dedicated to voice, while the other is dedicated to data traffic. Line cords and handset cords on all Meridian digital telephones are equipped with snap-in TELADAPT connectors for quick and easy connecting procedures.

The telephone interfaces with the Digital Line Card (DLC) in the Option 11C system.

Functional description

This chapter describes the features and capabilities of Meridian 1 digital telephones.

Volume control

Speaker volume (or piezo-disc transducer volume in digital telephones not equipped with a Handsfree unit) is controlled by one key with two toggle positions. Operating the “Volume Up” or “Volume Down” pad of the key increases or decreases the volume for the tone or sound which is currently active.

Line engineering

Meridian Digital Telephones operate through twisted pair wiring. The maximum permissible loop length is 3500 ft. of 24AWG standard twisted wire with no bridge taps.

Local alerting tones

Four alerting tones and a buzz sound are provided. The alerting tone cadences cannot be changed from the telephone, but can be altered for individual Meridian Digital Telephones by software controlled adjustments in the system. Refer to *Administration* (553-3001-311) and *Maintenance* (553-3001-511) for more information. All other tones such as dial tone or overflow tones, are provided by the system from a Tone and Digit Switch.

Alerting tone characteristics

The tone frequency combinations are as follows:

Tone	Frequencies	Warble rate (Hz)
1	(667 Hz, 500 Hz)	10.4
2	(667 Hz, 500 Hz)	2.6
3	(333 Hz, 250 Hz)	10.4
4	(333 Hz, 250 Hz)	2.6

Note: A 500 Hz buzz signal is provided for incoming call notification while the receiver is off-hook.

Powering requirements

Both the M2009 telephone and M2018 telephone are loop powered. Loop power uses +15 V and -15 V sources, and assumes 3500 feet maximum loop length of 24 AWG wire and a minimum of 13.5 V at the telephone terminals.

The Handsfree unit, which is integrated in the Meridian M2112, requires an auxiliary power supply. Power can be obtained from either a QUT1 25 V AC closet power supply or a local plug-in transformer (AO273077) over a separate pair of wires.

If the power supply fails, Handsfree will not operate, but all other features will continue to function, provided the power failure does not affect the system. The loop-powered functions of all Meridian digital telephones remain operational only if the system is equipped with a backup battery.

Additional power is obtained over a separate pair of wires. Maximum Handsfree current is 110 mA with a minimum of 16 V AC to be present at the telephone terminal. The following rules apply:

- For the QUT1 closet power supply:
 - The power supply loop for the Handsfree unit should follow the same rules as the loop powering requirements, i.e. the maximum allowable loop length and wire gauge are 3500 ft. of 24 AWG wire.
 - Each M2112 Handsfree must be powered by one tap of one winding, however, it is permissible to connect two (2) 12.5 V AC windings in series to provide 25 V AC power for Handsfree.
- For the local plug-in transformer:
 - A single winding transformer equipped with a 3 m (10 ft.) cord of 22 AWG two-conductor stranded and twisted wire with a modular duplex adapter (NE-267QA) at the end is required.
 - The following minimum specifications have to be met by this transformer:
 - No load output voltage: 21 V AC max.
 - Voltage at rated current: 16 V AC \pm 10%
 - Rated load current: 375 mA

Data

If the Asynchronous Data Option (ADO) is installed, an external power supply is needed in addition to the power from the line (see Table). A 110 V AC 60 Hz, 100 V AC 50/60 Hz or a 220 V AC 50 Hz multi-output power supply unit provides nominal voltages of +5 V, +12 V and -12 V DC. The power supply connects to the back of the telephone through a 5-pin Molex power connector.

If the AC power supply fails, data calls cannot be processed. All external power supplies are equipped with short circuit and thermal shutdown protection.

The following units are available:

Table 87
External power supply for Meridian Digital Telephones ADO (Part 1 of 2)

North American version	
NPS50220-03L5	Multi-output external power supply (CPC-# A0336823), UL listed and CSA approved.
Input:	57 - 63 Hz 115 - 132 V AC
Output:	+5 V DC, 1.0 A (pin 3 for supply, pin 2 for return) +12 V DC, 200 mA (pin 6 for supply, pin 1 for return) -12 V DC, 200 mA (pin 4 for supply, pin 1 for return)
Japanese version	
NPS50220-03L8	Multi-output external power supply (CPC-# A0336891), Japan Standard ("T" Mark).
Input:	47 - 63 Hz 85 - 115 V AC
Output:	+5 V DC, 1.0 A (pin 3 for supply, pin 2 for return) +12 V DC, 200 mA (pin 6 for supply, pin 1 for return) -12 V DC, 200 mA (pin 4 for supply, pin 1 for return)

Table 87
External power supply for Meridian Digital Telephones ADO (Part 2 of 2)

European version	
NPS50220-03L5	Multi-output external power supply (CPC-# A0336166), conforming to NPS50561 general requirements and UL1012.
Input:	57 - 53 Hz 200 - 240 V AC
Output:	+5 V DC, 1.0 A (pin 3 for supply, pin 2 for return) +12 V DC, 200 mA (pin 6 for supply, pin 1 for return) -12 V DC, 200 mA (pin 4 for supply, pin 1 for return)

Data characteristics

The Asynchronous Data Option (ADO) communicates with the data terminal equipment having characteristics as shown in Table 88.

Table 88
Meridian Digital Telephone ADO characteristics

Data type	ASCII
Synchronization External power supply for Meridian Digital Telephones ADO	Asynchronous, Start-Stop
Number of Bits	8 bits
Parity	none (unchecked)
Data rate	300, 1200, 2400, 4800, 9600, 19200 bits per second (autobaud)
Stop bits	2 bits for 110 bits per second; 1 bit for all other speeds
Transmission	Full duplex

Voice and Voice Signaling Channel

The Digital telephone Interface Chip functions as a control to switch the handset, speaker, keyboard scanning, and LCD controls on and off.

Data and Data Signaling Channel

The ADO supports asynchronous ASCII operation. A data byte is received from your terminal or personal computer, a control byte is added, and the two bytes are transferred to the associated line card. In the other direction, two data bytes are received from the line card, and the data byte is delivered to your terminal in a bit serial format, at the terminal's bit rate.

The Meridian Digital ADO (equipped with the RS-232-C EIA interface) supports the following features for ASCII, asynchronous, character mode, interactive data terminals:

- HAYES dialing
- Keyboard dialing (KBD) - all transmission speeds supported
- Call origination to local and remote hosts
- Call termination
- Ring Again Capability
- Auto Dial
- Speed Call
- Automatic or Manual answering of incoming data calls
- Manual Modem pooling
- Remote loopback

Details for accessing and operating the various features are given in the *Asynchronous Data Option (ADO) User Guide* (P0661883).

Chapter 12 — M2317 Telephone

Contents

This section contains information on the following topics:

Introduction	272
Physical description	273
LCD indicators	274
Alphanumeric display	275
Handsfree operation	275
Specifications	275
Safety considerations	275
Environmental considerations	276
Dimensions and weight	276
Line engineering	277
Powering requirements	277
Data communication	279
Data characteristics	280
Features description	280
Firmware features	280
Software features	281

Introduction

The M2317 Telephone can provide simultaneous voice and data communications. It connects to the system using digital transmission. The M2317 Telephone is intended for professionals and managers, and secretaries in group answer positions. It interfaces with the system through the Digital Line Card (DLC). It is connected to the switching equipment through a two-wire loop carrying two independent 64 kb/s Time Compressed Multiplex (TCM) channels with associated signaling channels. One of the two TCM channels is dedicated to voice, and the other to data traffic.

The M2317 Telephone is equipped with a microphone and speaker to permit Handsfree operation.

Figure 27 shows the M2317 Telephone.

Figure 27
M2317 Telephone

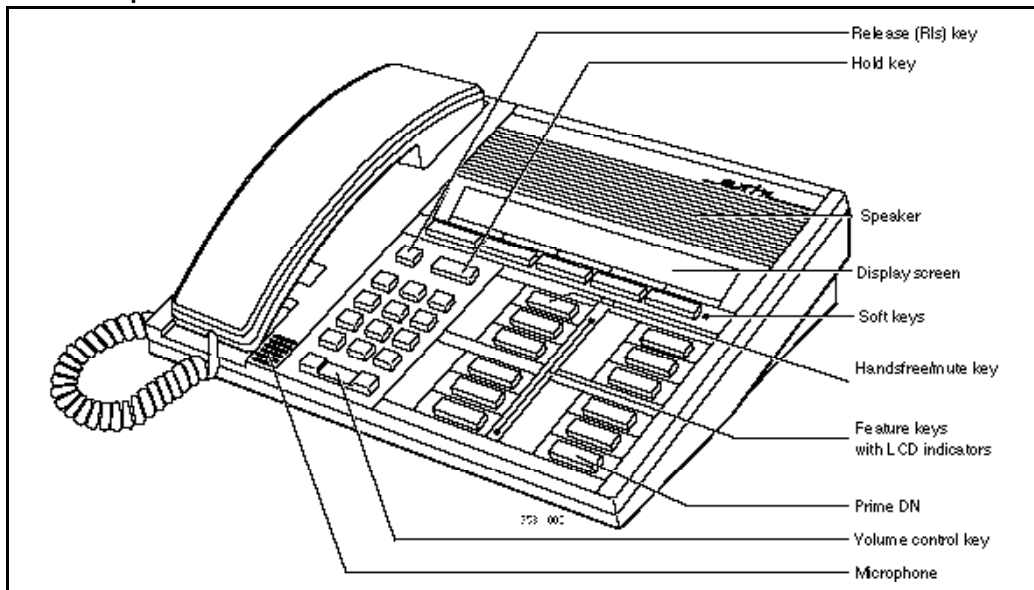

Physical description

The M2317 Telephone is fully modular. The telephone line cord and the handset cord are both equipped with TELADAPT connectors at each end, which permits quick replacement when required.

The M2317 Telephone is equipped with 32 keys (see Figure 28) which are arranged as follows:

Fixed keys These are 16 keys to which a fixed function is assigned. They consist of:

- 12 dial pad keys
- 1 Release key
- 1 Hold key
- 1 Volume control key (with 2 toggle positions)
- 1 Handsfree/Mute key (with associated LCD indicator)

Feature keys There are 11 feature keys on the telephone faceplate. Each has an associated LCD indicator. Up to a maximum of ten voice Directory Numbers and specific features such as Auto Answerback, Call Waiting and Dial Intercom can be assigned.

Softkeys Five soft keys are located beneath the display screen. Each softkey has a seven character wide on the display screen immediately above the key. The labels change as the available features change. For example, a soft key could access one feature in the idle state and a different feature in the active state.

The M2317 provides independent volume adjustments for Handsfree, handset and alerting tone volumes. For detailed adjusting information, refer to the *M2317 Telephone User Guide* (P0687154).

LCD indicators

LCD indicators support 4 key/LCD states:

Function	LCD state
idle	off
active	on (steady)
ringing (or “feature pending”)	flash (60 Hz)
hold	fast flash (120 Hz)

Figure 28
M2317 Telephone — key identification

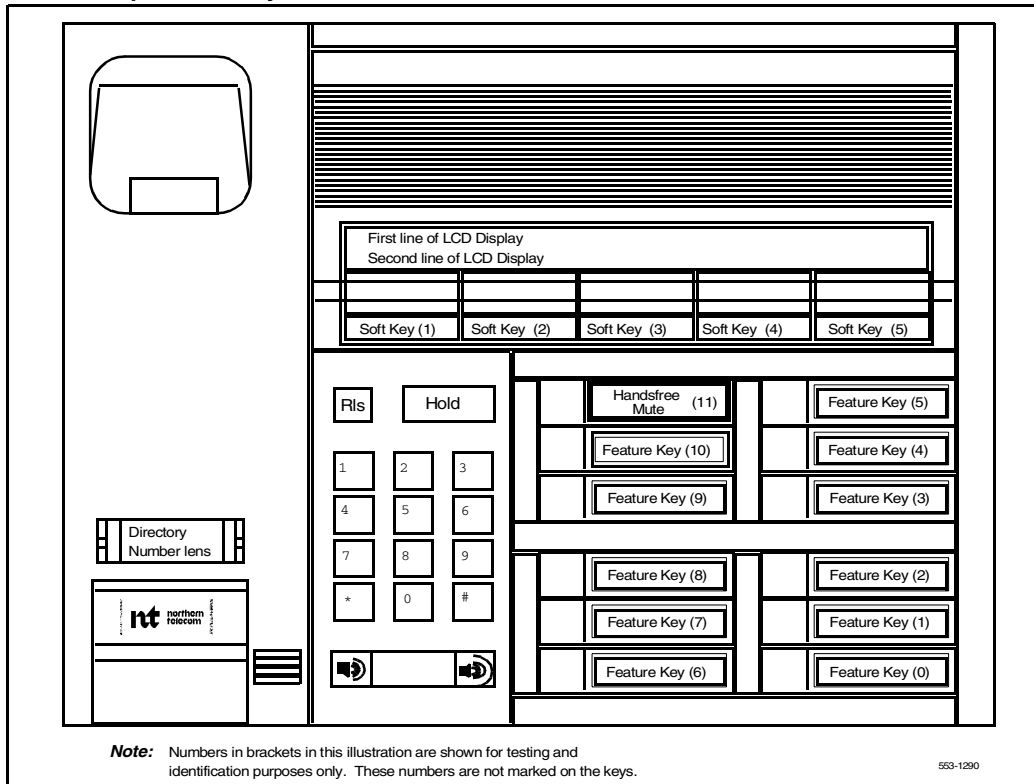

553-1250

Alphanumeric display

The M2317 Telephone is equipped with a two-line (40 characters per line capacity) Liquid Crystal Display (LCD) screen and five LCD-labeled “soft” keys located immediately beneath the display screen.

Handsfree operation

With the Handsfree on, you can talk to another party without lifting the handset. Handsfree can be activated by pressing the Handsfree/Mute key, or by pressing a DN key without lifting the handset. The Handsfree/Mute LCD indicator shows the status of the Handsfree. Once Handsfree is activated, it can be deactivated by picking up the handset or by pressing the Release (RLS) key.

Specifications

The following specifications govern the safety and performance of the Meridian M2317 Telephone, and outline the environmental conditions under which this performance is achieved.

Safety considerations

Shock and fire hazards

For protection against electrical shock, energy, or fire hazards, the telephone meets the following specifications:

CSA, C22.2 No. 0.7 —M1985

UL 1459, relevant sections (March 1984 draft)

Overvoltage protection

The M2317 Telephone meets the specifications detailed by CSA, C22.2 No.7, paragraph 6.9.3.

Environmental considerations

Temperature and humidity

Operating state:

Temperature range	0° to 50° C (32° to 122° F) 0° to 40° C (32° - 104° F) with Data Option
Relative humidity	5% to 95% from 4° to 29° C (39° to 84° F) non-condensing 5% to 34% from 29.5° to 49° C (85° to 120° F) non-condensing

Storage:

Temperature range	-20° to 70° C (-4° to 158° F)
Relative humidity	5% to 95% from -20° to 29° C (-4° to 84° F) non-condensing 5% to 15% from 29.5° C to 66° C (85° to 150° F)

Dimensions and weight

The M2317 Telephone has the following dimensions:

depth	226.5 mm (9 in.)
width	272.0 mm (10.1 in.)
height (front)	27.5 mm (1.1 in.)
height (rear)	73.5 mm (2.9 in.)

Excluding the power supply and the NT1F09AA Asynchronous Data Option board, the M2317 weighs approximately 1.4 Kg (3 lb). With the Data Option installed, the telephone, excluding power supply and data cable, weighs approximately 1.56 Kg (3.5 lb).

Line engineering

The maximum permissible loop length is 1067 m (3500 ft.) of 22 or 24 AWG or 760 m (2500 ft.) of 26 AWG standard twisted wire with no bridge taps or load coils. The 1067 m (3500 ft.) loop length requires the use of a Digital Line Card (DLC).

Powering requirements

The M2317 Telephone uses loop power for all circuits requiring +10V. In order to satisfy the power requirements for those circuits on a maximum loop 60 mA of 13.5 V DC must be available at the telephone. The line card must have compatible voltage and source resistance to meet these requirements.

The Logic circuits of the M2317 Telephone require + 5 V DC which must be supplied from an external, regulated DC supply which connects through a jack in the back of the telephone. If the telephone is equipped with a data option, the required 5 V DC is provided by the external data option power supply. The external power supply must meet the following specifications:

Input:	95 - 129 V AC, 60 Hz
Output:	+5 V DC, + or - 5%, 300 mA 10 mV maximum RMS ripple
Cord:	2.5 m (8 ft.) of 20 AWG wire mating to a Switchcraft 722A connector
Case:	Wall mounted, CSA and UL approved. Operational within 0° C (32°F) and 50°C (122°F) temperature limits
Impedance:	Greater than 10 M Ω to ground

The external power supply, in all cases where no asynchronous data option is installed, is connected to the mating connector mounted in the rear of the M2317 Telephone, covering the area where the RS-232-C interface connector would be located.

If the Asynchronous Data Option is installed, an external, multi-output data power supply NPS50220-03L5 is required. This power supply satisfies all powering requirements for the telephone and the data option.

The data option power supply connector plugs into the back of the telephone next to the RS-232-C interface connector. Data option installation requires the removal of the telephone power supply connector.

The NPS50220-03L5 power supply meets the following specifications:

AC input voltage: 105 - 132 V AC

Input line frequency: 57 - 63 Hz

Operating temperature: 0° to 50°C (32° to 122°F)

Operating humidity: 5% to 95% non-condensing

Storage temperature: -40° to 70°C (-40° to 158°F)

Output voltages:

+5 V DC at 1.0 A

-12 V DC at 200 mA

+12 V DC at 200 mA

Case dimensions: 178 x 102 x 76 mm (7 x 4 x 3 in.)

The NPS50220-03L5 is equipped with an internal thermal and short circuit protection.

Whenever the external power supply fails (due to failure of the power utility), the M2317 Telephone assumes Plain Ordinary Telephone Service (POTS) status. At this time the telephone is capable of receiving and originating calls on the prime DN, and of giving the usual alerting tones (ringing). It will not support the Display screen, softkeys, feature keys, Handsfree, or data facilities while in POTS status.

Figure 29
Block diagram of M2317

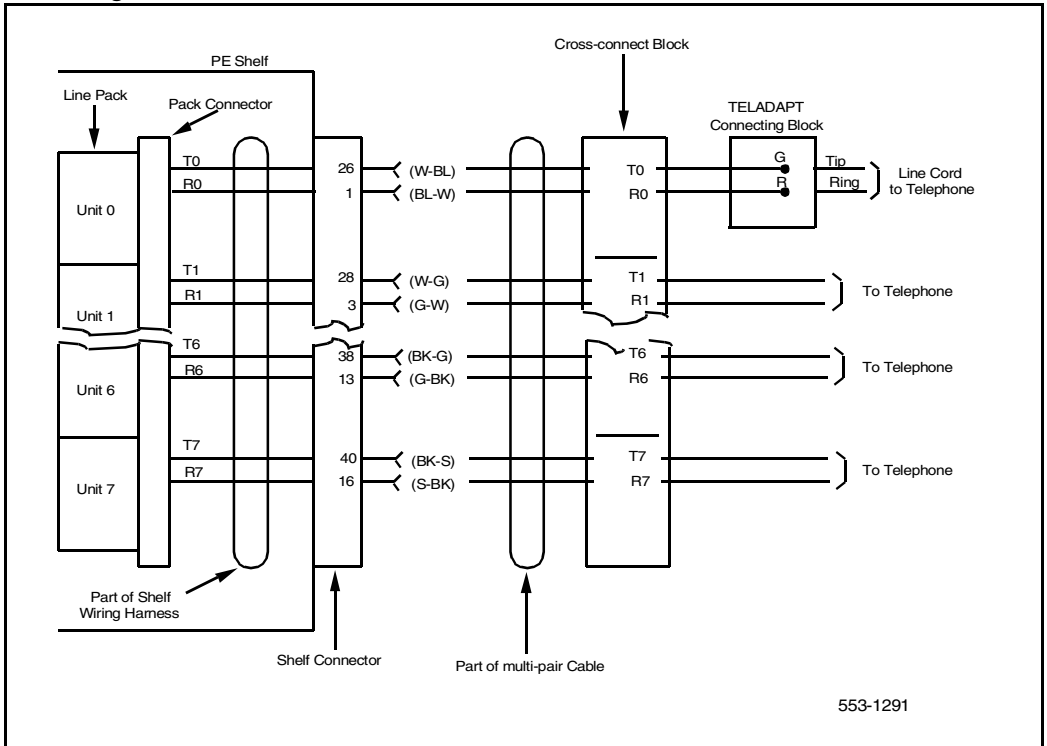

Data communication

The M2317 can be equipped with an Asynchronous Data Option which will permit the use of either the telephone's dial pad or the feature keys to place and terminate data calls in the asynchronous mode. The Data Option also supports keyboard dialing from the data terminal when that terminal operates in the asynchronous mode.

The Asynchronous Data Option is equipped with a dialing feature which enables the user to originate data calls to local and remote Data Terminal Equipment (DTE) directly from a data terminal keyboard or personal computer. The dialing feature, in conjunction with the communications firmware provided with the Data Option, supports most of the HAYES Smartmodem dialing features. Terminal emulation packages can also be used with the dialing feature.

Data characteristics

The M2317 Asynchronous Data Option communicates with Data Terminal Equipment (DTE) having characteristics as shown in Table 89.

Table 89
M2317 Asynchronous Data Option characteristics

Data type	ASCII
Synchronization	Asynchronous, Start-Stop
Number of Bits	8 bits
Parity	none (unchecked)
Data rate	300, 1200, 2400, 4800, 9600, 19200 bits per second (autobaud)
Stop bits	2 bits for 110 bits per second; 1 bit for all other speeds
Transmission	Full duplex

Features description

Firmware features

Firmware is chip-dependent and cannot be changed or altered on site. As a general rule, all firmware is on ROM microchips.

Firmware functions

The following functions are performed by firmware in the M2317 Telephone:

- Predial
- Last Number Redial
- Saved Number
- Redial Saved Number

- Timer
- Time and Date
- Call Processing

Software features

Downloading

All information related to the programmable keys must be downloaded into the M2317 RAM memory through the DLC.

Softkeys are automatically defined for the telephone based on COS, data base or package restrictions. Softkeys work only in conjunction with the LCD display screen.

Table 90
M2317 data features

Data features	M2317	DTE Keyboard
• Ring Again	• X	• X
• Speed Call	• X	• X
• System Speed Call	• X	• X
• Display	•	• X
• Call Forward	• X	•
• Call Transfer (Note)	•	• X
• Autodial	• X	• X
• Last Number Redial	• X	•
• Save Number	• X	•
• Redial Saved Number	• X	•
<ul style="list-style-type: none"> • Manual modem pooling using keyboard dialing requires only call transfer to be defined. • The Data DN must always be assigned to feature key 10. 		

Chapter 13 — Meridian Modular Telephones

Contents

This section contains information on the following topics:

Functional description	283
Software requirements	284
Peripheral equipment requirements	284
General description ..	284
Physical characteristics ..	289
Features and options matrix	292
Optional equipment ..	293
Specifications	297
Environmental and safety considerations	297
Line engineering	298
Local alerting tones ..	299
Power requirements ..	300
Meridian Programmable Data Adapter ..	306

Functional description

The Meridian Modular Telephones are designed to provide cost effective integrated voice and data communication capability. They interface with Option 11C using the Digital Line Card (DLC). No additional hardware is required at the line circuit to provide data communication.

Meridian Modular Telephones are connected to the system through a two-wire loop carrying two independent 64 Kb/s PCM Channels with associated signaling channels. One of the two PCM channels is dedicated to voice while the other is dedicated to data traffic. Line cords and handset cords on all Meridian Digital Telephones are equipped with snap-in TELADAPT connectors for easy and quick connecting procedures.

Software requirements

The option number for the Meridian Modular Telephones is 170. The mnemonic is ARIE. The DSET package (88) and the TSET package (89) are required.

Peripheral equipment requirements

The telephone interfaces with the Digital Line Card (DLC) in Option 11C. The digital line card supports eight Integrated Voice and Data ports; each port supports one data and one voice channel. A voice TN and a data TN are assigned in the software.

General description

This document describes the various features and capabilities of the following Meridian Modular Telephones.

M2006—a single line telephone with 6 programmable function keys. See Figure 30.

M2008—a multi-line telephone with 8 programmable function keys. See Figure 31.

M2616—a high performance multi-line telephone with 16 programmable function keys and integrated Handsfree unit. See Figure 32.

M2016S—a Telephone Security Group Class II approved telephone designed to provide on-hook security. It is similar to the M2616, with 16 programmable function keys, but has no handsfree capability. See Figure 32.

M2216ACD-1—a multi-line telephone for ACD operations. It has 15 programmable function keys, a special ACD Display Module and two RJ-32 jacks for modular electret headsets. See Figure 33.

M2216ACD-2—a multi-line telephone for ACD operations. It has 15 programmable function keys, and a special ACD Display. It is similar to model 1, but with one PJ-327 jack for a carbon agent headset and one RJ-32 jack for an electret supervisor headset. See Figure 33.

Figure 30
M2006 modular telephone

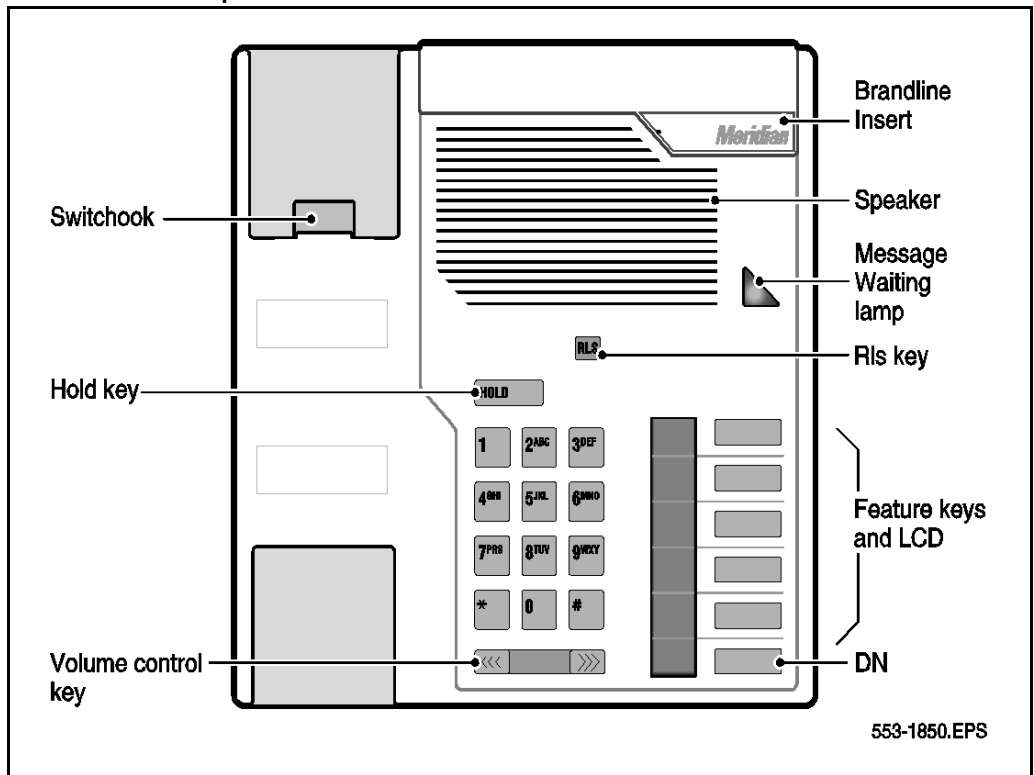

Dimensions:

Length: 8.42 in. (215 mm.)

Width: 8.42 in. (215 mm.)

Height: 3.61 in. (93mm.)

Weight: approximately 2 lbs. (1 kg.)

Figure 31
M2008 modular telephone

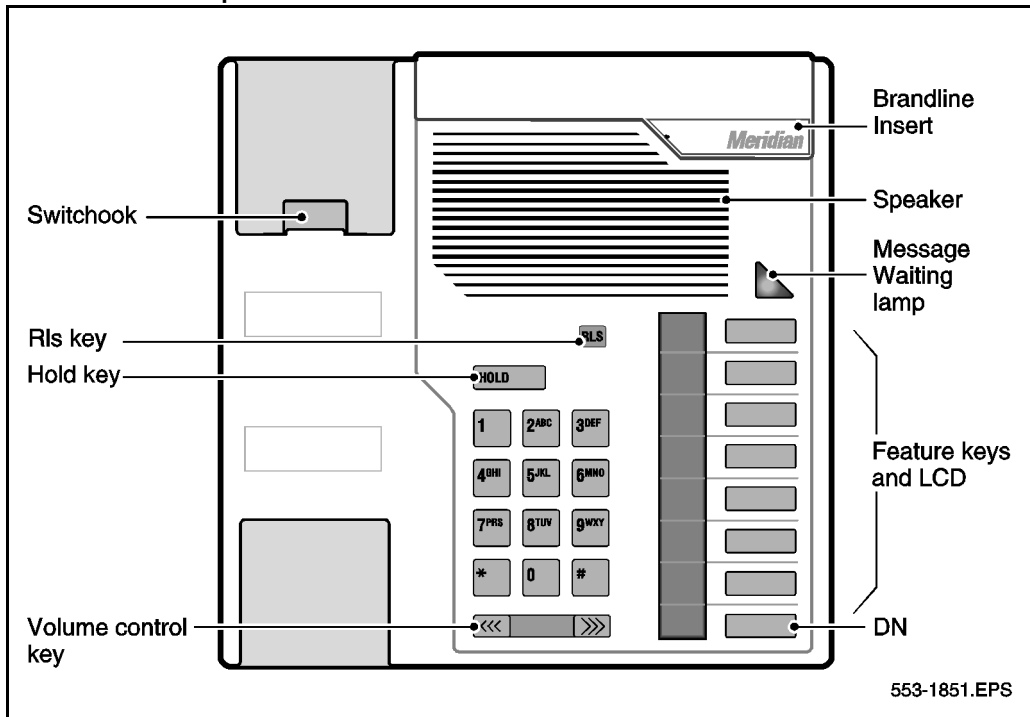

Dimensions:

Length: 8.42 in. (215 mm.)

Width: 8.42 in. (215 mm.)

Height: 3.61 in. (93 mm.)

Weight: approximately 2 lbs. (1 kg.)

Figure 32
M2016S and M2616 modular telephones

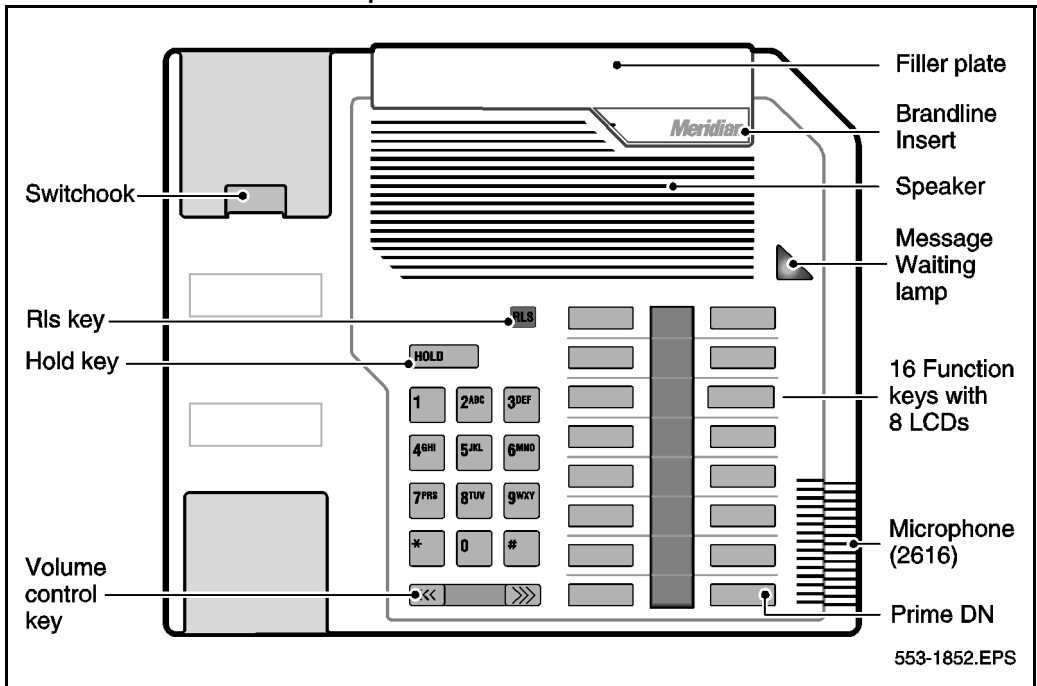

Dimensions:

Length: 9.75 in. (250 mm.)

Width: 9.45 in. (235 mm.)

Height: 3.64 in. (93 mm.)

Weight: approximately 2 lbs. (1 kg.)

Figure 33
M2216ACD-1 and -2 modular telephones

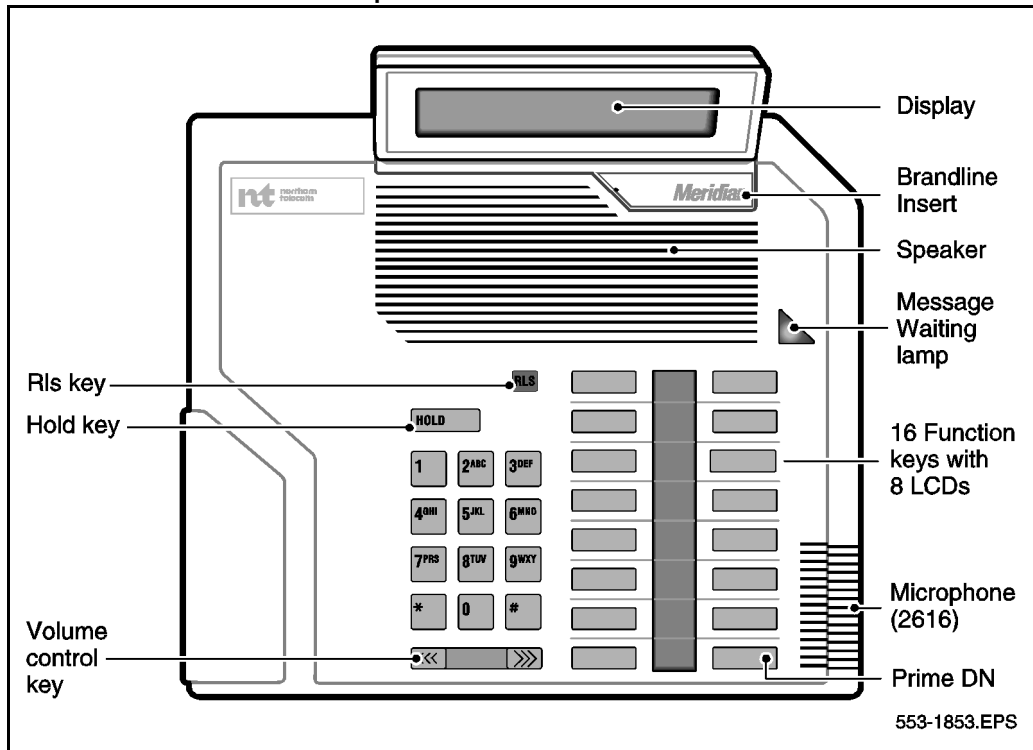

Dimensions:

Length: 9.75 in. (250 mm.)

Width: 9.45 in. (235 mm.)

Height: 3.64 in. (93 mm.)

Weight: approximately 2 lbs. (1 kg.)

Figure 34
M2216ACD-1 and -2 left side showing headset jacks

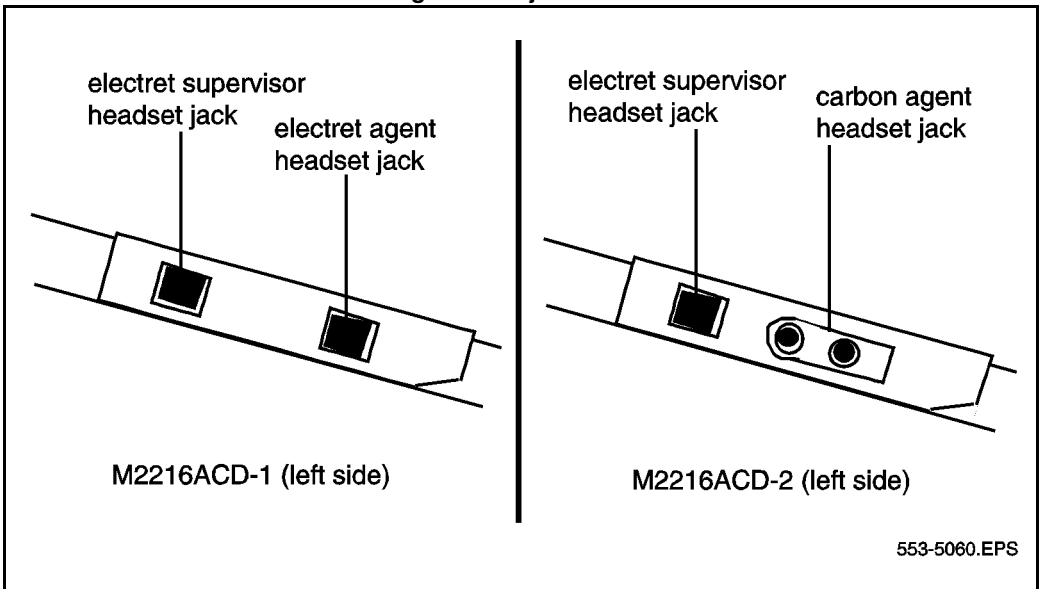

Physical characteristics

All of the Meridian Modular Telephones are equipped with:

- Hold key
- Release key
- Volume control
- Message Waiting lamp
- Speaker

Each modular telephone also has a number of programmable keys with LCD indicators that can be assigned to any combination of directory numbers and features (only one DN for the M2006). The lower right-hand key (key 0) is reserved for the Primary DN.

When equipped with a Display module or MPDA, key 07 is automatically assigned as the Program key and cannot be changed. Key 05 becomes the Program key on the M2006, if equipped with MPDA.

The M2006 is a single line telephone and accepts only one DN. The remaining five key/lamp pairs can be assigned any feature that is not considered a DN, such as Transfer, Call Forward, or Conference. Features that cannot be assigned are those that are considered DNs: Voice Call and 2-way Hotline, for example. Attempting to assign more than one DN to the M2006 causes the telephone to disable itself and all LCDs light steadily. It will return to its normal operating state when service change removes all secondary DNs.

LCD indicators support 4 key/LCD states:

Function	LCD state
idle	off
active	on (steady)
ringing	flash (60 Hz)
hold (or feature pending *)	fast flash (120Hz)

* An indicator fast-flashes when you have pressed a feature key but have not completed the procedure necessary to activate the feature.

Volume control

One key with two toggle positions controls volume. Pressing the right “volume up” or left “volume down” side of the key incrementally increases or decreases the volume for the tone or sound which is currently active. The volume settings are retained for subsequent calls until new volume adjustments are made. If the telephone is equipped with a Display Module, volume can be adjusted at any time with the setting displayed on the screen (in Program mode).

Handset volumes can be configured to return to nominal on a per call basis.

You can adjust the volume of the following tones, while they are audible:

- ringing
- handsfree (M2616)

- handset/headset
- buzz
- on-hook dialing

When the telephone is disconnected, all volume levels will return to default values upon reconnection.

When the telephone is operating on loop power alone, the highest (eighth) step in volume cannot be reached (as seen when using Display in Program mode).

Message Waiting lamp

Each Meridian Modular Telephone has a red triangle in the upper right-hand corner that lights brightly to indicate a message is waiting. This LED is the primary message waiting indicator and lets you know a message is waiting regardless of whether the telephone has a message waiting key/lamp pair. You must have Message Waiting CCOS configured.

If you do assign a message waiting key/lamp pair, there will be two indications of a message waiting:

- the red Message Waiting triangle lights, and
- the LCD associated with the Message Waiting key flashes.

You may assign an Autodial key that dials the message center (or voice mail system) to avoid the double indication, or have no key/lamp pair assigned to the message center.

The Message Waiting lamp is also used to indicate security of the M2016S. The red LED triangle lights steadily when the phone is not secure (handset is off-hook, phone is ringing or any time the handset/piezo relays are connected). The red LED triangle blinks when a message is waiting.

Handsfree (M2616 only)

Handsfree (if software assigned), allows the user to talk to another party without lifting the handset. Activate Handsfree by depressing the Handsfree/mute key (key 15, top left) or by selecting a DN without lifting the handset. Once Handsfree is activated, it can be deactivated by picking up the handset or by ending the call using the Release (RIs) key. If Handsfree is not software assigned, you can assign any other feature to key 15.

When the Handsfree/mute key is pressed during a Handsfree call, the microphone is deactivated while the speaker remains active, preventing the other party from overhearing local conversations. The Handsfree LCD indicator flashes while the microphone is muted. Pressing the Handsfree/mute key again reactivates the microphone and the Handsfree LCD lights steadily.

Features and options matrix

Table 91 lists the distinctive characteristics of each Meridian Modular Telephone and shows the optional hardware that you can add to each.

Table 91
Hardware features and options

	M2006	M2008	M2016S	M2616	M2216ACD-1	M2216ACD-2
Programmable keys	6	8	16	16	16	16
Handsfree microphone				standard		
Optional hardware available:						
Display		x	x	x	standard	standard
Key Expansion Module			x	x	x	x
Programmable Data Adapter	x	x	x	x	x	x
External alerter interface	x	x		x	x	x
Brandline insert	x	x	x	x	x	x
Note: In this table, x indicates available features for the set type listed along the top row.						

Note: If the set is equipped with a Display or Meridian Programmable Data Adapter, the number of programmable keys is reduced by one, as key 07 (key 05 on M2006) automatically becomes the Program key.

Optional equipment

The modular design of the digital telephones described in this document makes adding hardware options easy (see Figure 35). Below is a list of hardware you can add to Meridian Modular Telephones.

Display Module

A two line by 24 character Display Module provides system prompts, feedback on active features and valuable calling party information. In addition, you can modify various set features such as volume and screen contrast using the Program key (top right function key). You can enable a Call Timer which times calls made or received on the prime DN.

The Display Module requires a Power Supply Board on M2008 .

There are two types of Display Module available:

- North American Display—supports normal business features in two languages, English and Quebec French.
- Special Applications Display—supports the following features:
 - Automatic Call Distribution (ACD)
 - Hospitality
 - six languages (English, Quebec French, Parisian French, German, Spanish, Dutch)

A Special Applications Display Module comes as standard equipment on the M2216ACD telephones. M2008 or M2616 telephones used as ACD telephones require the Special Applications Display.

Note: It is possible to adjust the Display screen contrast so that it is too light or too dark to read. If you cannot read the Display, disconnect and then reconnect the line cord to return to the default settings.

Meridian Programmable Data Adapter

The Meridian Programmable Data Adapter (MPDA) mounts within the telephone (see Figure 36) and allows asynchronous ASCII terminals, personal computers and printers to be connected to the telephone using an RS-232-D (subminiature) interface. The MPDA has multilingual capability. It requires additional power. See “Power requirements” on page 300.

For more information, see “Meridian Programmable Data Adapter” on page 306

Program key

The Program key is automatically assigned to Meridian Modular Telephones with Display or MPDA added. It allows you to change a variety of display features such as screen format, contrast and language. It also lets you change data parameters such as transmission speed and parity.

The upper right-hand key (key 05 on M2006, key 07 on all others) automatically becomes the Program key when Display or MPDA is configured with the telephone. The Program key is local to the set and shows blank when you print key assignments in LD 20.

External Alerter Interface

The External Alerter Board provides an interface to standard remote ringing devices, such as a ringing unit installed in a location separate from the telephone. The External Alerter Interface is not the remote ringer itself, but provides access to standard, off-the-shelf remote ringing devices. The Alerter Board requires additional power (see “Power requirements” on page 300).

You can program the External Alerter Interface to activate a ringer (or light) when the telephone rings or when the telephone is in use (off-hook).

Key Expansion Module

A modular 22 key unit can be attached to any 16 key Meridian Modular Telephone. The extra keys can be assigned to any combination of lines and features. You can add up to two expansion modules to a single telephone. You will need a separate footstand for the module(s), one for a single module, one for a double (see “Ordering information”). The expansion module requires additional power (see “Power requirements”).

The Key Expansion Module connects to the telephone through a ribbon cable running from the base of the telephone. It is physically connected to the telephone by the footstand.

Brandline Insert

The filler plate on the telephone or Display Module contains a removable insert designed to accommodate custom labeling. You can order blank Brandline Inserts and have a printer silk screen your company logo on them. Brandline Inserts snap easily into and out of the filler plate.

Headset

The M2216ACD telephones are compatible with three electret headsets:

- Plantronics Polaris
- GN Netcom Profile
- NT Liberation

The M2216ACD-2 agent jack is compatible with any standard carbon headset.

The headset interface of the M2216ACD-1 is adjustable to allow you to tune the electrical characteristics to optimize performance, while the M2216ACD-2 headset interface is fixed.

Any recording device connected to the receive path of a Meridian Modular Telephone must meet these requirements:

- load impedance at least 8K ohms across the audio band
- connect in parallel across pins 3 and 4 of the handset/headset jack
- isolate power source from the handset/headset jack

M2006/M2008/M2616 You can use an electret headset in the handset port of the M2006, M2008 or M2616 telephone. Choose an amplified headset that draws power from a battery or AC transformer (power is not provided by the telephone). The amplifier must draw less than 400 micro amps from the telephone jack.

The headset should be designed to work with a telephone jack with these characteristics:

Transmit interface: +5 V through 10K DC bias resistance with maximum current of 500 micro amps. The differential input impedance is 10K ohms. Connects to pins 2 and 5 of the handset jack.

Receive interface: single ended output with output impedance of 180 ohms. Connects to pins 3 and 4 of the handset jack.

Figure 35
M2616 with Display Module and Key Expansion Module

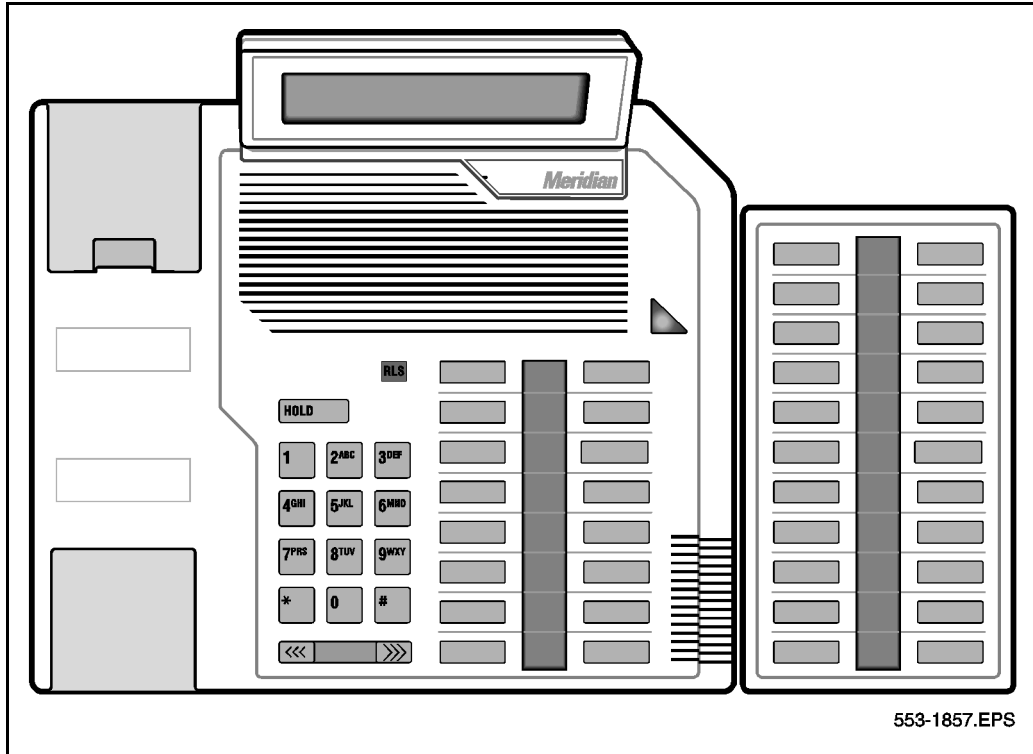
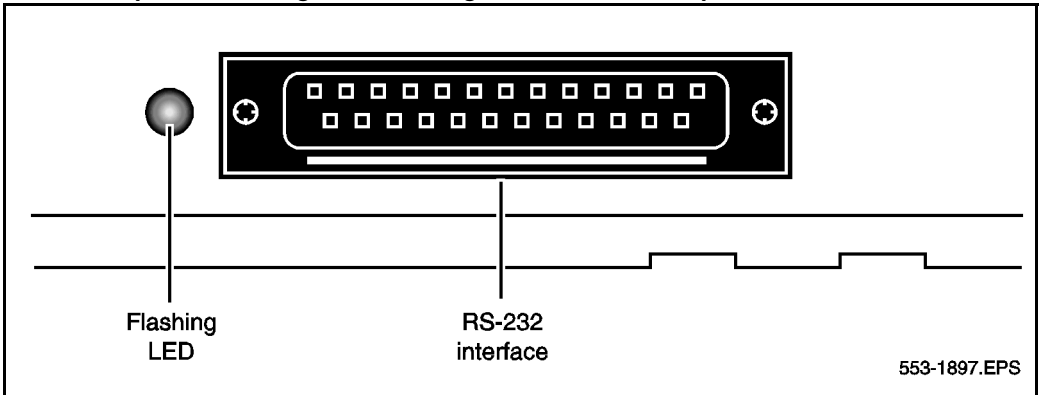

Figure 36
Back of telephone showing Meridian Programmable Data Adapter



Specifications

The following specifications govern the performance of the Meridian Modular Telephones under the environmental conditions described.

Environmental and safety considerations

All digital telephones and their associated options meet the requirements of Electronic Industries Association (EIA) specification PN-1361.

Temperature and humidity

Operating state:

Temperature range 0° to 50° C (32° to 104° F)

Relative humidity 5% to 95% (non-condensing). At temperatures above 34°C (93°F) relative humidity is limited to 53 mbar of water vapor pressure.

Storage:

Temperature range	-50° to 70° C (-58° to 158° F)
Relative humidity	5% to 95% (non-condensing). At temperatures above 34°C (93°F) relative humidity is limited to 53 mbar of water vapor pressure.

Electromagnetic interference

The radiated and conducted electromagnetic interference meets the requirements of Subpart J of Part 15 of the FCC rules for class A computing devices.

Line engineering

The maximum permissible loop length is 3500 ft. (915 m), assuming 24 AWG (0.5 mm) standard twisted wire with no bridge taps. A 15.5 dB loss at 256 KHz defines the loop length limit (longer lengths are possible, depending on the wire's gauge and insulation).

The Meridian Modular Telephones use a 6 conductor line cord (A0346862).

Note: Use only the line cord provided with the Meridian Modular Telephone. Using a cord designed for other digital telephones could result in damage to the cord.

Figure 37 shows a simplified block diagram of the Meridian Modular Telephone, MPDA and DLC in the Option 11C system.

Figure 37
Block diagram of MPDA and Meridian Modular Telephone

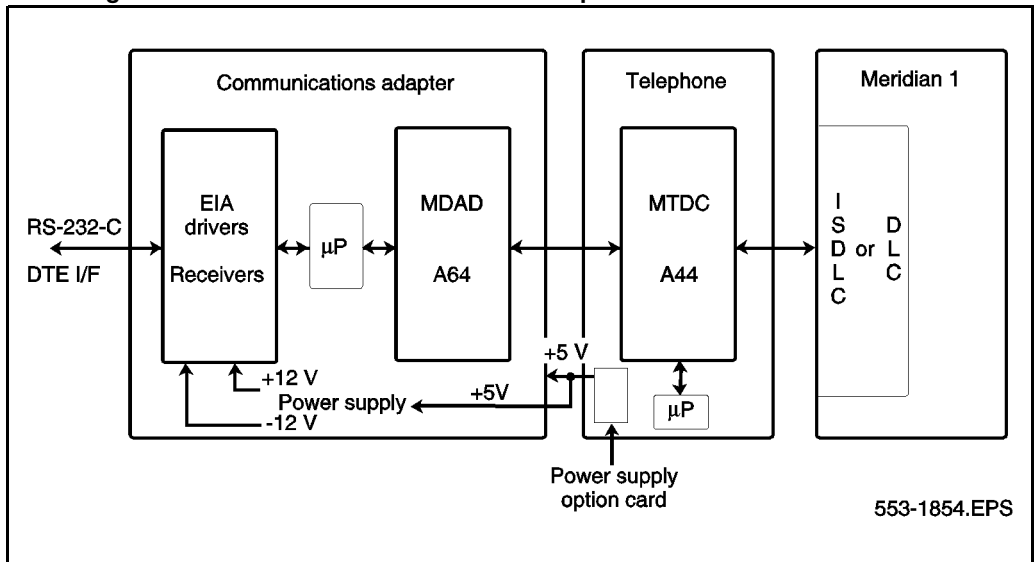

Local alerting tones

Each telephone provides four alerting tones and a buzz sound. The system controls the ringing cadence by sending tone-ON and tone-OFF messages to the telephone. The alerting tone cadences cannot be changed from the telephone, but can be altered for individual Meridian Modular Telephones by software controlled adjustments.

Alerting tone characteristics

The tone frequency combinations are:

Tone	Frequencies	Warble Rate (Hz)
1	667 Hz, 500 Hz	10.4
2	667 Hz, 500 Hz	2.6

M2006/M2008:

3	1600 Hz, 2000 Hz	10.4
4	1600 Hz, 2000 Hz	2.6

M2016S/M2616/M2216ACD:

3	333 Hz, 250 H	10.4
4	333 Hz, 250 Hz	2.6

A 500 Hz buzz signal is provided for incoming call notification while the receiver is off-hook.

Power requirements

The M2006, M2008, M2616 (basic configuration and with Display Module) and M2216ACD-1 are loop powered. Loop power consists of a -30 V AC power source and assumes a 3500 ft. (915 m) maximum loop length of 24 AWG wire and a minimum 15.5 V AC at the telephone terminals.

Note: The loop length limit is defined by a 15.5 dB loss at 256 KHz. Longer lengths can be determined using the wire's gauge and insulation.

The Handsfree feature, which is integrated into the M2616, requires no additional power.

Some configurations of telephones and options need more than basic loop power to operate. Table 92 lists the Meridian Modular Telephones and shows when additional power is needed to operate the telephone or its optional hardware. Power Supply Boards come installed in factory-assembled configurations which require additional power.

If a power failure occurs, configurations which require loop power only will continue to work if the Option 11C system has battery backup. Only those options which require additional power will cease to function.

During a power failure, the carbon agent headset on the M2216ACD-2 will fail and the electret supervisor's jack can be used as an agent jack. If no headset was plugged in to the electret jack at this time, the call is dropped, the agent logged off and must log in again once the electret headset is plugged in. When power is restored, the carbon jack returns automatically.

Table 92
Power requirements

Telephone type	Loop power	Additional power (Power Supply Board)
M2006	Basic configuration	Any option(s)
M2008	Basic configuration	Any option(s)
M2016S	No	All configurations
M2616	Basic configuration (with Hands-free) and Display	Programmable Data Adapter Key Expansion Module External alerter interface
M2216ACD-1	Basic configuration (with Display)	Any option(s)
M2216ACD-2	No	All configurations

Power Supply Board

The power supply option consists of a Power Supply Board which mounts inside the telephone, coupled with an external wall-mount transformer or closet power supply which provides power to the Power Supply Board. The Power Supply Board receives its power through pins 1 and 6 of the line cord.

The Power Supply Board connects to the telephone through a 14 pin bottom entry connector.

The Power Supply Board comes factory installed with any configuration of the M2016S and M2216ACD-2. The M2006 and M2008 require the Power Supply Board with the addition of any option. The M2616 requires the Power Supply Board with any option except the Display Module.

Local plug-in transformer

A single winding transformer equipped with a 10 ft. (3 m) cord of 22 AWG two-conductor stranded and twisted wire with a modular RJ-11 duplex adapter (refer to Figure 38) can provide the additional power needed to operate the telephone and its options.

CAUTION

Do not plug any equipment (computer, modem, LAN card) other than the Meridian Modular Telephone into the RJ-11 transformer adapter, as damage to equipment may result.

120 V transformer (AO367335 or equivalent). The following minimum specifications must be met by this transformer:

Input voltage: 120 V AC / 60 Hz

No load output voltage: 29 V AC maximum

Voltage at rated current: 26.7 V AC minimum

Rated load current: 700 mA

240 V transformer (AO367914 or equivalent). The following minimum specifications have to be met by this transformer:

Input voltage: 240 V AC / 50 Hz

No load output voltage: 29 V AC maximum

Voltage at rated current: 26.7 V AC minimum

Rated load current: 700 mA

Note: You cannot wall mount the telephone over the wall jack when using a transformer, due to the size of the RJ-11 adapter. Hang it above or to the side of the jack and run the line and power cords to it.

Figure 38
Configuration of local plug-in transformer

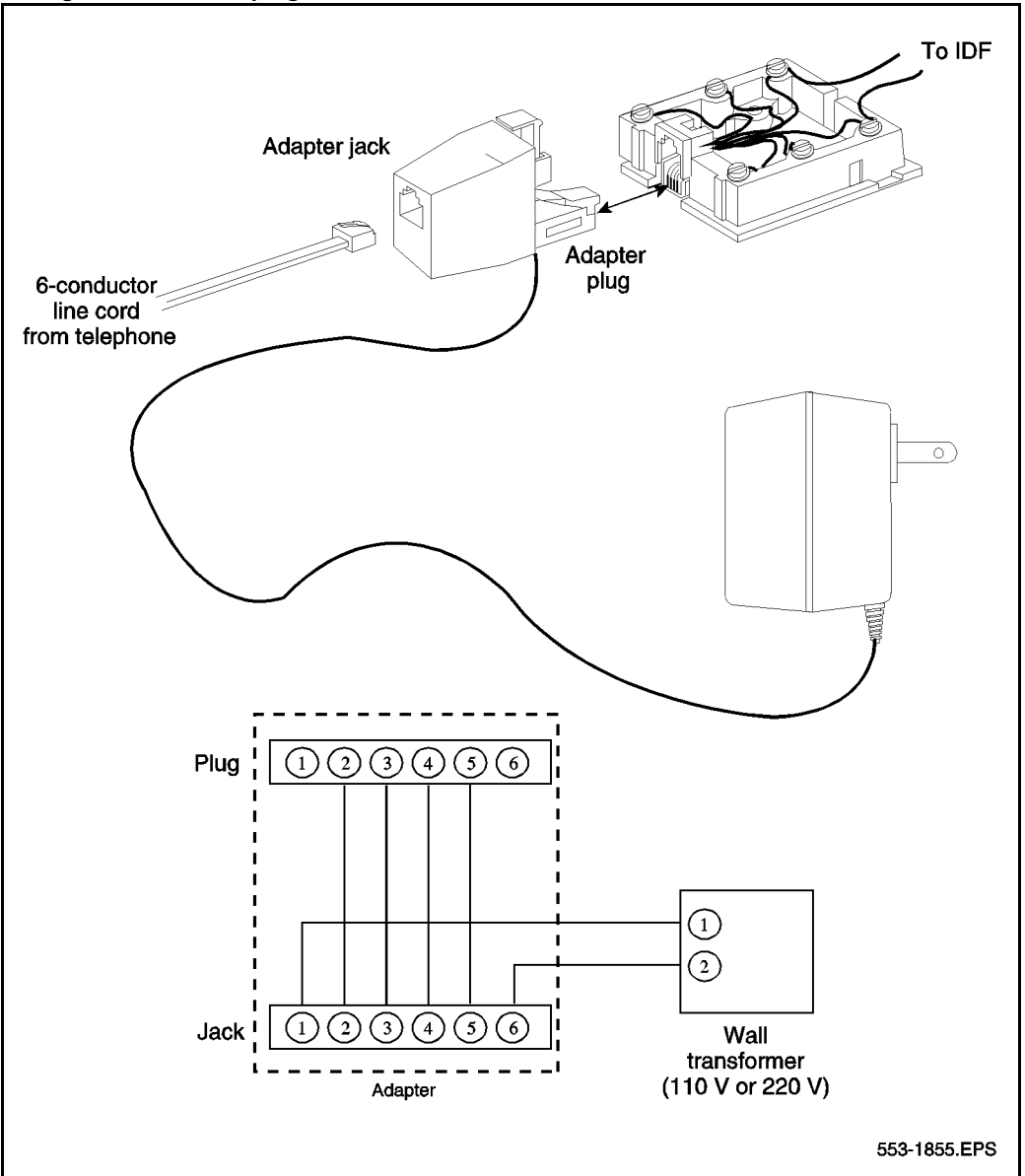

Closet power supply

Closet power can be obtained from an AC transformer for loops of 100 ft. (30 m) or less, or a DC transformer for loop lengths of 650 ft. (197 m) or less. An equivalent power source can be used but must maintain isolation of outputs to the terminal. (Refer to Figure 39).

CAUTION

When using closet power, do not plug the TELADAPT connector into any equipment (computer, modem, LAN card) other than the Meridian Modular Telephone, as damage to equipment may result.

All terminals must be isolated from the input winding and each terminal must be isolated from all other terminal windings. A separate winding is required for each terminal, and grounds should not be connected.

Note: The QUT1 closet power supply source is not compatible with Meridian Modular Telephones.

The AC source should be rated at 29 V AC, 700 mA isolated. The DC source should be rated at 42 V DC, 300 mA isolated, with current limiting output of 1 amp.

Figure 39
Closet power supply configuration

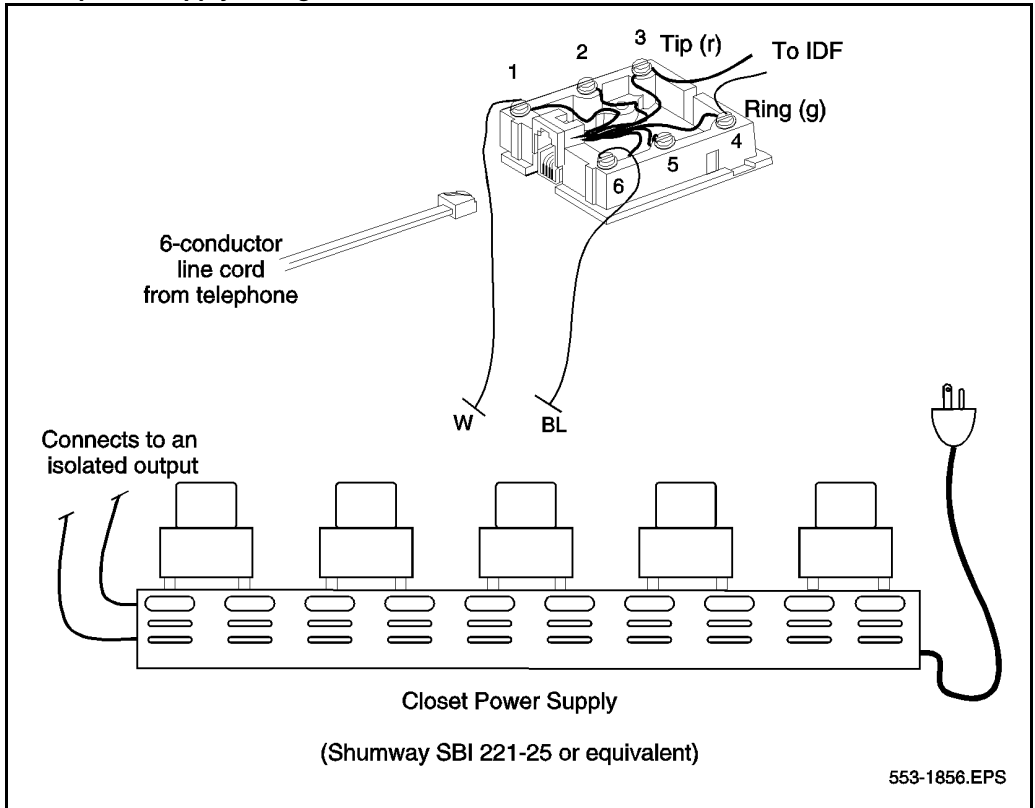

Meridian Programmable Data Adapter

When a Meridian Modular Telephone is equipped with the Meridian Programmable Data Adapter (MPDA), you can make a data call using keyboard dialing from your attached terminal. You can carry on voice and data communication simultaneously without causing any mutual interference.

The MPDA communicates with Data Terminal Equipment (DTE) having characteristics as shown in Table 93:

Table 93
MPDA data characteristics

Data type	ASCII
Synchronization	Asynchronous, Start-Stop
Number of Bits	8 bits
Parity	none (unchecked)
Data rate	110, 150, 300, 1200, 2400, 4800, 9600, 19200 bits per second (autobaud)
Stop bits	2 bits for 110 bits per second; 1 bit for all other speeds
Transmission	Full duplex

Note: The MPDA configuration of data parameters is stored locally (although you can set the configuration in the Option 11C system). You cannot set the data parameters in the system before installing the MPDA in the telephone (the configuration information will be lost).

The keyboard dialing routine may vary with the data equipment being used and reference to the user's data terminal manual may be necessary. For more detailed information, see *Meridian Programmable Data Adapter User Guide*.

The MPDA can establish either data calls or voice calls. You can make data calls using keyboard dialing, keypad dialing or the AT command dialing feature. The AT dialing features lets you originate data calls to local and remote Data Terminal Equipment (DTE) directly from a data terminal keyboard or personal computer. You can make voice calls using AT dialing from your terminal.

Users of personal computers already equipped with a Hayes Smartmodem or users who have a stand-alone Hayes Smartmodem can substitute the MPDA for data integration. The Hayes dialing feature, when used with third party communication software and the digital telephone, will support most of the Hayes Smartmodem features. Third party terminal emulation packages can also be used with Hayes dialing.

New features supported by the MPDA include:

- enhanced Hayes commands, including upper- and lower case dialing, voice call origination through AT dialing, hang up data call, and on-line disconnect of voice call
- script file capabilities allow you to program multiple data resources for automatic resource access
- Voice Call Origination (VCO)

Chapter 14 — M3900 telephone series

Contents

This section contains information on the following topics:

Reference List	310
Introduction	310
Prelabeled feature keys	314
Soft-labeled Programmable keys	314
Soft Programmable feature keys	314
Programmable feature keys	315
Physical description	315
Specifications	315
Software requirements	315
Hardware options	315
External Alerter interface	316
Brandline insert	316
Key-based Add-on Module (KBA)	316
Analogue Terminal Adapter (ATA)	316
Meridian Communications Adapter (MCA)	316
Accessory Keying	316
Environmental and safety considerations	318
Temperature and humidity	318
Line engineering	318

Reference List

The following are the references in this section:

- *Digital Telephone Line Engineering (553-2201-180)*

Introduction

The Meridian M3900 series of telephones consists of the following telephones:

- M3901: digital entry set for occasional use
- M3902: basic set for manufacturing floor, warehouse, and low telephone use
- M3903: enhanced set for office professionals and technical specialists
- M3904: professional set for Managers, Executives, Administrative Assistants
- M3905: call center set for Call Center Agents and Supervisors

These sets are digital, integrated voice/data telephone with the following features:

Table 94
M3900 features

	M3901 entry level	M3902 basic	M3903 enhanced	M3904 professional	M3905 call center
lines supported	1		2	6	8
Programmable feature keys	5	3	4		
fixed feature keys	no	Options/ Program, Mes- sage (with LED), Transfer (with LED)	Options/ Program, Message, Directory/ Log, Application, Shift		Supervisor, Emergency, Not Ready, Make Busy, In- calls

Table 94
M3900 features (Continued)

	M3901 entry level	M3902 basic	M3903 enhanced	M3904 professional	M3905 call center
fixed keys for call processing	no	Hold, Good-bye, Smart Mute (with LED), Handsfree (with LED)	Hold, Good-bye, Smart Mute (with LED), Head- set (with LED), Handsfree (with LED)		Hold, Good-bye, Smart Mute (with LED), Headset (with LED)
Supervisor Observe Key (with LED)	no				yes
fixed application keys	no	Up, Down, Left, Right	Up, Down, Left, Right, Quit, and Copy		
Display	no	(2 x 24): 1 Text Lines, 1 Label Line	(3 x 24): 1 Info Line, 1 Text Lines, 1 Label Line	(5 x 24): 1 Info Line, 3 Text Lines, 1 Label Line	(4 x 24): 1 Info Line, 2 Text Lines, 1 Label Line
Accessory Ports	no	1	2		
Accessories	no	ATA, MCA, External Alerter & Recorder Interface	ATA, MCA, External Alerter & Recorder Interface	ATA, MCA, External Alerter & Recorder Interface, Key-based Add-on	
Headset	through MPA jack		Direct Connect		

Note: All sets are desk or wall mountable, have message waiting LED with visual ringing, and have volume control.

The M3900 Series Meridian Digital Telephones support features through a variety of feature keys:

Figure 40
M3901



Figure 41
M3902



Figure 42
M3903



Figure 43
M3904



Figure 44
M3905



Prelabeled feature keys

The prelabeled feature keys are the feature keys on your M3900 Series Meridian Digital Telephone that are labeled at the factory.

Depending on your model of telephone the prelabeled feature keys include Hold, Good-bye, Dial Pad, Mute, and Volume Control Bar and also include unique prelabeled feature keys assigned to specific models of the M3900 Series Meridian Digital Telephone, such as: Feature, Option, shift, Navigation, Quit, Copy, Message, Transfer, Directory/Log, Headset, Directory/Log, Handsfree, InCalls, Not Ready, Make Busy, Call Supervisor.

Soft-labeled Programmable keys

The Soft-labeled line/feature keys are the keys located at the sides of the upper display area. The user can change the LCD label of these keys to fit their needs. The soft-labeled programmable line/feature keys are the two to eight keys (the number of keys depends on the M3900 model) located at the sides of the upper display area. The Soft-programmable key has two layers, giving the user access to two features per key. For example: the M3905 has eight soft-labeled line/feature keys, which gives the user 16 lines/features on those eight keys.

Soft Programmable feature keys

The Soft Programmable feature keys are the three to four keys located below the bottom display area on your M3903, M3904, and M3905 telephone. They have three layers of features.

Programmable feature keys

The programmable features for the M3901 model are not Soft Programmable feature keys. The M3901 can have five programmable features, they are accessed by pressing the Feature key and a keystroke.

Physical description Specifications

Software requirements

Release 24 or later supports the M3900 Meridian Digital telephones.

Hardware options

This section describes the options available for M3900 Series Meridian Digital Telephones. Table 95 lists the features and optional hardware available for each telephone.

Table 95
Hardware features

Optional hardware available	M3901	M3902	M3903	M3904	M3905
Accessory Connection Module (ACM)	NA	x	x	x	x
Key-based Add-on Module	NA	NA	NA	x	x
Meridian Communications Adapter (MCA)	NA	x	x	x	x
Analogue Terminal Adapter (ATA)	NA	x	x	x	x
External alerter interface	NA	x	x	x	x
Brandline insert	Hardware	Hardware	Electronic Hardware	Electronic Hardware	Electronic Hardware
Note: X indicates the hardware available for the M3900 Series Meridian Digital Telephone.					

External Alerter interface

The External Alerter provides an interface to a remote ringer device which is installed in a location separate from the telephone. The External Alerter interface is not a remote ringer, but provides access to standard, off-the-shelf remote ringer devices or visual indicator.

You can program the External Alerter interface to activate a ringer (or light) when the telephone rings or when the telephone is in use (off-hook).

Brandline insert

The M3901 Series Meridian Digital Telephone contains a removable insert made to accommodate your company logo. You can order blank Brandline Inserts with your company logo. The M3903, M3904 and M3905 supports electronic brandline.

Key-based Add-on Module (KBA)

The Key-based Add-on Module attaches to the M3904 and M3905 telephone. The module provides 22 extra line and/or feature keys. You can attach a maximum of two KBAs to the M3904 and M3905.

Analogue Terminal Adapter (ATA)

The Analogue Terminal Adapter lets you connect an analogue device such as a fax machine or modem to your telephone. You can then have simultaneous use of the telephone and the analogue device. The ATA can be used with the M3902, M3903, M3904, and M3905 models.

Meridian Communications Adapter (MCA)

The Meridian Communications Adapter lets the user connect the telephone to a personal computer or terminal. This allows the telephone to exchange data between your computer and other computers. The M3902, M3903, M3904, and M3905 models support the MCA.

Accessory Keying

A maximum of two cartridge accessories can plug into the slots at the rear of the terminal stand. The ports provide access to a SIDL/SDI ports, USART port, and GPIO0. Two accessories cannot access the same serial port. The mechanical keying prevents this situation from occurring. Refer to the figure below for a better understanding of mechanical keying.

Figure 45
M3900 Series mechanical keying

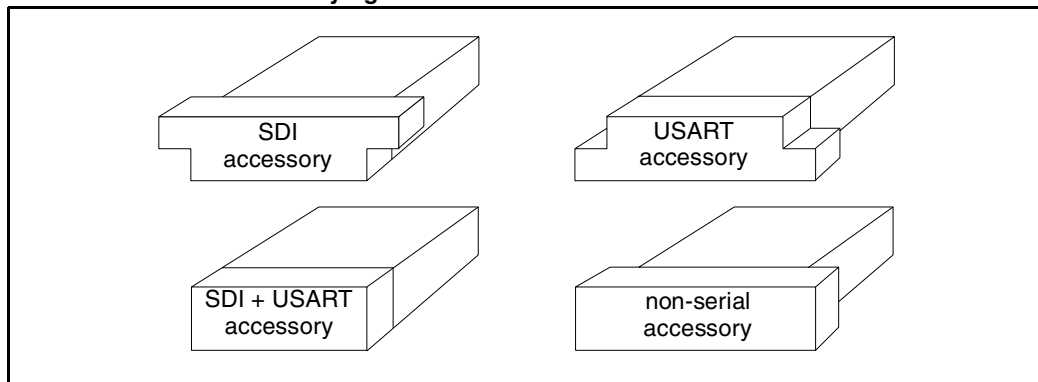

Table 96 shows accessory compatibility for the M3900 Series Meridian Digital Telephone.

Table 96
M3900 Series Meridian Digital Telephone accessory compatibility (Part 1 of 2)

	HW Port	SDI			SIDL+ USAR T	USAR T	UART		HEADSET		GPIO	
HW Port	Accessory	MC A	ATA	DTA	USB	CTIA	DB A	KB A	EXT. ART *	HD/ S	EXT. ART **	RCD R
SDI	MCA	N/A	X	X	X	OK	OK	OK	OK	OK	OK	OK
	ATA	X				OK	OK	OK	OK	OK	OK	OK
	DTA	X				OK	OK	OK	OK	OK	OK	OK
SIDL+ USAR T	USB	X				X	OK	OK	OK	OK	OK	OK
USAR T	CTIA	OK	OK	OK	X	N/A	OK	OK	OK	OK	OK	OK
UART	DBA	OK	OK	OK	OK	OK	N/A	X	OK	OK	OK	OK
	KBA	OK	OK	OK	OK	OK	X	OK	OK	OK	OK	OK

Table 96
M3900 Series Meridian Digital Telephone accessory compatibility (Part 2 of 2)

	HW Port	SDI			SIDL+ USAR T	USAR T	UART		HEADSET		GPIO	
HEAD SET	EXT.ATR*	OK	OK	OK	OK	OK	OK	OK	N/A	X	OK	X
	HD SET	OK	OK	OK	OK	OK	OK	OK	X	N/A	OK	OK
GPIO	EXT.ATR	OK	OK	OK	OK	OK	OK	OK	OK	OK	N/A	OK
	RCDR	OK	OK	OK	OK	OK	OK	OK	X	OK	OK	N/A

Environmental and safety considerations

Temperature and humidity

Operating state:

Temperature range 0° to 50°C (32° to 104°F)
 Relative humidity 5% to 95% (noncondensing). At temperatures above 34°C (93°F) relative humidity is limited to 53 mbar of water vapor pressure.

Storage:

Temperature range -50° to 70°C (-58° to 158°F)
 Relative humidity 5% to 95% (noncondensing). At temperatures above 34°C (93°F) relative humidity is limited to 53 mbar of water vapor pressure.

Line engineering

Meridian Digital telephones use twisted pair wiring on transmission lines selected by the rules given in *Digital Telephone Line Engineering* (553-2201-180). The maximum permissible loop length is 3500 ft. (1067 m), assuming 24 AWG (0.5 mm) standard twisted wire with no bridge taps. A 15.5 dB loss at 256 kHz defines the loop length limit. (Longer lengths are possible, depending on the wire’s gauge and insulation.).

Note: Use only the line cord provided with the telephone. Using a cord designed for another telephone could result in damage to the cord.

Chapter 15 — European Digital telephones: 3110, 3310, and 3820

Contents

This section contains information on the following topics:

Reference List	320
Introduction	320
Physical description	322
Fixed keys (same for all three models)	325
Additional feature keys	326
Software requirements	327
Hardware options	327
External Alerter interface	328
Brandline insert	328
Key Expansion Module	329
Meridian Communications Adapter (MCA)	329
Environmental and safety considerations	329
Environmental and safety considerations	329
Line engineering	330
Local alerting tones	330
Power requirements	331

Reference List

The following are the references in this section:

- *Telephone and Attendant Console: Installation* (553-3001-215)
- *Administration* (553-3001-311)
- *Maintenance* (553-3001-511)

This guide provides feature, add-on module, and specification information for Meridian European Digital telephones.

Note: These telephones are only available in Europe.

Introduction

The Meridian European Digital telephones series of telephones consists of the following telephones:

- M3110
- M3310
- M3820

Meridian digital telephones are designed to provide cost-effective integrated voice and data communication. These telephones communicate with the Meridian 1 using digital transmission over standard twisted-pair wiring. They interface with the Meridian 1 using the Integrated Services Digital Line Card (ISDLC) or the eXtended Digital Line Card (XDLC).

Meridian digital telephones are connected to the system through a two-wire loop carrying two independent 64 kbs PCM channels with associated signaling channels. One of the two PCM channels is dedicated to voice while the other is dedicated to data traffic.

The telephone interfaces with the Digital Line Card (XDLC) or ISDLC in the Peripheral Equipment shelf of the system. The XDLC supports 16 voice and 16 data ports. The ISDLC supports eight voice and eight data ports. A TN is assigned to each port in the system software.

Figure 46
M3110 Meridian digital telephone

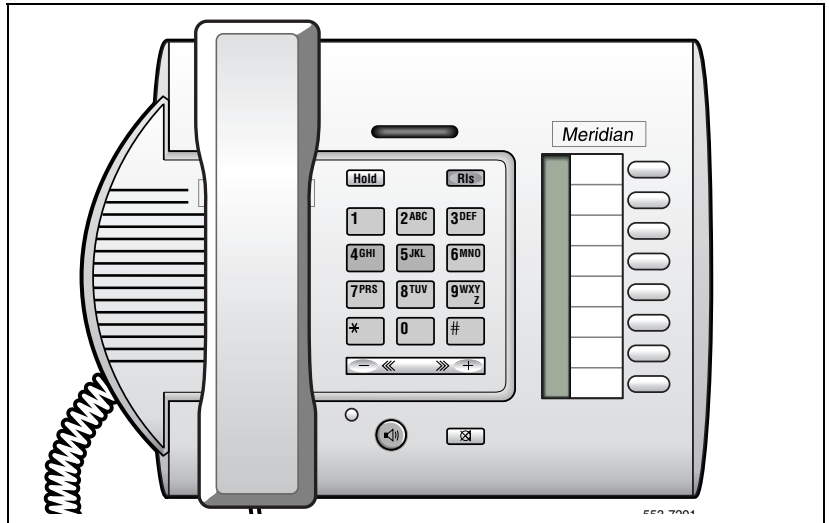

Figure 47
M3310 Meridian digital telephone

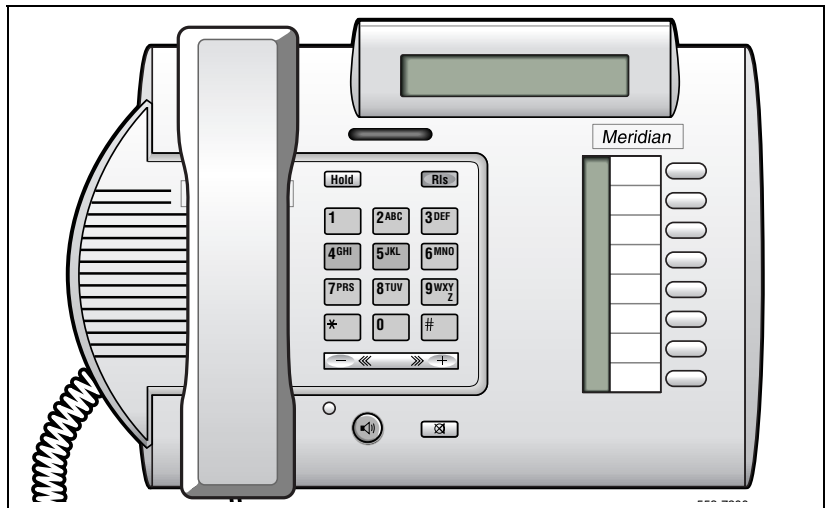

Figure 48
M3820 Meridian digital telephone



Physical description

Meridian digital telephones support many general features as illustrated in Table 97.

Table 97
Meridian digital telephone general features (Part 1 of 2)

Feature	M3820	M3310	M3110
Handsfree, On-Hook Dialling, and Group Listening	yes	yes	yes
Dedicated Release and Hold keys	yes	yes	yes
Message Waiting and Speaker/Mute Indicators	yes	yes	yes
Headset Socket	yes	yes	no
2 x 24 character display	yes	yes	no
Feature keys including:	20	10	10
• Store/program key	yes	yes	no
• system programmable keys	13	7	8

Table 97
Meridian digital telephone general features (Part 2 of 2)

Feature	M3820	M3310	M3110
• Handsfree/speaker key	yes	yes	yes
• Mute key	yes	yes	yes
• Directory key	yes	no	no
• Caller's List key	yes	no	no
• Edit key	yes	no	no
• Delete key	yes	no	no
Volume control for:			
• Handset/Headset, Ringing Tone, Buzz Tone, On-Hook dialling and Group Listening	yes	yes	yes
• Handsfree	yes	yes	no
Directory/Caller's List with dedicated keys for Directory, Callers, Edit, Delete, 4 cursor and Dial	yes	no	no
Terminal options:			
• MCA data option to provide integrated voice and data, External Alerter for high ambient noise environments, Wall mount ability	yes	yes	yes
• Add-on Key Expansion Modules (2 maximum)	yes	no	no
Brand line insert to provide for special company logos	yes	yes	yes
Note: The location of the buttons used to activate and interact with these features is shown in Figure 49.			

Figure 49
The location and function of buttons on the Meridian digital telephone

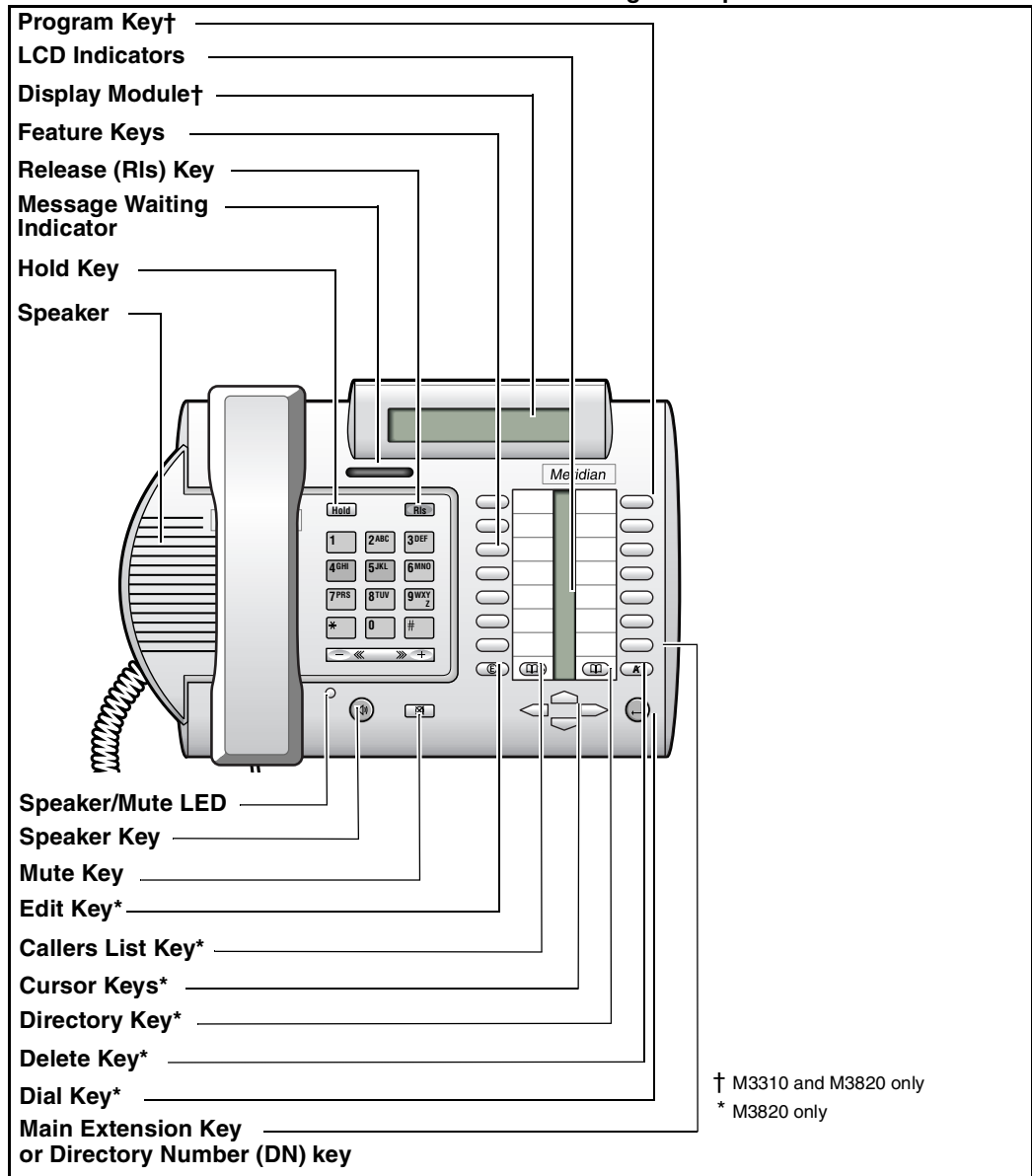

Fixed keys (same for all three models)

- **Hold:** By pressing the hold key, you can put an active call on hold. Return to the caller by pressing the extension key beside the flashing LCD indicator.
- **Release (RIs):** You can terminate an active call by pressing the RIs key or by hanging up the handset. The release key is especially useful for disconnecting handsfree and headset calls.
- **Volume control:** The volume key controls the volume of the handset, the speaker and the ringer. Raise the volume by pressing the right side of the bar. Lower it by pressing the left side.
- **Mute:** When engaged in a call, you can press the mute key. The party(ies) to whom you are speaking cannot hear you. This is especially useful when on a conference call and you are only listening. When you wish to return to the two-way conversation, you must push the mute key again. The mute key applies to handsfree, handset and headset microphones.
- **Speaker/Handsfree:** The speaker key allows you to activate handsfree and group listening features. Handsfree is only available on the M3310 and M3820 models and is enabled by the system administrator. If handsfree is not configured at the switch, the telephone can only be used to listen.

The table below indicates the mode the terminal is in when the speaker key is operated under the various switch and set operations.

Table 98
Speaker Key Function

MODEL	Handsfree not selected at the switch	Handsfree selected at the switch - Group listening off	Handsfree selected at the switch - Group listening On
M3820 and M3310	CPM ^a and primary DN key-Speaker LED is not illuminated	HF and Primary DN key - speaker LED is on when in Handsfree mode	HF, Group listening ^b and Primary DN key - speaker LED is on when in HF or Group Listening mode

Table 98
Speaker Key Function (Continued)

MODEL	Handsfree not selected at the switch	Handsfree selected at the switch - Group listening off	Handsfree selected at the switch - Group listening On
M3110	CPM and primary DN key-Speaker LED is not illuminated	N/A	Group listening and Primary DN key - speaker LED is on when in Group listening mode.

a. CPM is Call Process Monitor which enables the user to hear, for example, the dial tone in the speaker. Group listening enables the user to speak through the handset/headset microphone and one or more parties can listen through the speaker, thus hearing both sides of the conversation. In Handsfree mode, the user (or group of users) uses both the handsfree microphone and speaker.

b. Group listening is switched on or off under the program key option *1. (M3820 and M3310 only)

Additional feature keys

Message Waiting lamp key. Each telephone has a red message waiting LED just above the hold and RIs keys that lights to indicate a message is waiting. This LED is the primary message waiting indicator and lets you know that a message is waiting, regardless of whether the telephone has a message waiting key/lamp pair. You must have Message Waiting allowed Class of Service. See LD 11, *Administration* (553-3001-311) and *Maintenance* (553-3001-511)

If you do assign a message waiting key/lamp pair, there will be two indications of a message waiting:

- the red Message Waiting LED lights
- the LCD associated with the Message Waiting key blinks

Autodial key. You can assign an Autodial Key that dials the message center (or voice mail system) to avoid the double indication or have no key/lamp pair assigned to the message center.

Programmable Feature keys

Each Meridian digital telephone has a number of programmable keys with LCD indicators that can be assigned to any combination of directory numbers and features. The M3820 has 13 fully programmable feature keys; the M3310 has seven, and the M3110 has eight. The lower right-hand key (key 0) is reserved for the Primary DN.

LCD indicators support four key/LCD states:

Function	LCD state
idle	off
active	on (steady)
ringing	flash (60 Hz)
hold	fast flash (120 Hz)

Note: An indicator fast flashes when you have pressed a feature key but have not completed the procedure necessary to activate the feature.

Software requirements

Meridian digital telephones are supported by Release 16 and later software. The package number for the Meridian digital telephones is (170.) The mnemonic is ARIE. The DSET package (88) and the TSET package (89) are required.

Hardware options

This section describes the options available for M3900 Series Meridian Digital Telephones. Table 99 lists the features and optional hardware available for each telephone.

Table 99
Hardware features

Optional hardware available	M3901	M3902	M3903	M3904	M3905
Accessory Connection Module (ACM)	NA	x	x	x	x
Note: X indicates the hardware available for the M3900 Series Meridian Digital Telephone.					

Table 99
Hardware features (Continued)

Optional hardware available	M3901	M3902	M3903	M3904	M3905
Key-based Add-on Module	NA	NA	NA	x	x
Meridian Communications Adapter (MCA)	NA	x	x	x	x
Analogue Terminal Adapter (ATA)	NA	x	x	x	x
External alerter interface	NA	x	x	x	x
Brandline insert	Hardware	Hardware	Electronic Hardware	Electronic Hardware	Electronic Hardware

Note: X indicates the hardware available for the M3900 Series Meridian Digital Telephone.

External Alerter interface

The External Alerter Board provides an interface to standard remote ringing devices, such as a ringing unit, installed in a location separate from the telephone. The External Alerter interface is not the remote ringer itself, but provides access to standard, off-the-shelf remote ringing devices. The Alerter Board requires additional power. See “Power requirements” on page 331.

You can program the External Alerter interface to activate a ringer (or light) when the telephone rings or when the telephone is in use (off-hook).

For information on installing and setting up the External Alerter, see “Add-on modules” in *Telephone and Attendant Console: Installation* (553-3001-215).

Brandline insert

The telephone contains a removable insert designed to accommodate custom labeling. You can order blank Brandline Inserts and have a printer silk screen your company logo on them.

Key Expansion Module

A 22-key unit module can be attached to any M3820 terminal. The extra keys can be assigned to any combination of lines and features. You can add up to two expansion modules to a terminal. You will need a separate footstand for the module(s), one for a single module, one for a double.

Meridian Communications Adapter (MCA)

The MCA lets you connect your telephone to a personal computer or terminal. You can then use your telephone to exchange data between your computer and other computers. The MCA can be used with all three models.

Environmental and safety considerations

Environmental and safety considerations

All Meridian digital telephones are designed to comply with:

EN 60950:1992 - Safety of Information Technology Equipment including Electrical Business Equipment.

EN 41003:1993 - Particular Safety Requirements for Equipment to be connected to Telecommunication Network.

Temperature and humidity

Operating state:

Temperature range	0° to 50°C (32° to 104°F)
Relative humidity	5% to 95% (noncondensing). At temperatures above 34°C (93°F) relative humidity is limited to 53 mbar of water vapor pressure.

Storage:

Temperature range	-50° to 70°C (-58° to 158°F)
Relative humidity	5% to 95% (noncondensing). At temperatures above 34°C (93°F) relative humidity is limited to 53 mbar of water vapor pressure.

Electromagnetic interference

All the digital telephones are designed to comply with:

EN 50082-1:1992 - Electromagnetic Compatibility - Generic immunity standard Part 1: Residential, commercial and light industry.

EN 50081-1:1992 - Electromagnetic Compatibility - Generic emissions standard. Generic standard class: Residential, commercial and light industry.

Line engineering

Meridian digital telephones use twisted pair wiring on transmission lines selected by the rules. The maximum permissible loop length is 3500 ft. (1067 m), assuming 24 AWG (0.5 mm) standard twisted wire with no bridge taps. A 15.5 dB loss at 256 kHz defines the loop length limit. (Longer lengths are possible, depending on the wire's gauge and insulation.) Table 100 gives detailed information on loop lengths.

Table 100
Loop lengths for Meridian digital telephones

PVC insulated cable (polyvinyl chloride)	QPC578 A and B	QPC578 C +	NT8D02
22 or 24 AWG	100–3000 ft. (30.5–915 m)	0–3500 ft. (0–1067 m)	0–3500 ft. (0–1067 m)
26 AWG	100–2100 ft. (30.5–640 m)	0–2600 ft. (0–945 m)	0–2600 ft. (0–793 m)
<p>Note 1: No bridge taps or loading coils are allowed.</p> <p>Note 2: Effect of line protector at MDF reduces loop length by 500 ft.</p>			

Note: Use only the line cord provided with the telephone. Using a cord designed for another telephone could result in damage to the cord.

Local alerting tones

Each telephone provides four alerting tones and a buzz sound. The system controls the ringing cadence by sending tone-ON and tone-OFF messages to the telephone. The alerting tone cadences cannot be changed from the telephone but can be altered for individual terminals by software controlled adjustments in the system. See *Administration* (553-3001-311). All other telephone tones, such as dial tone or overflow, are provided by the Meridian 1 from a Tone and Digit Switch.

Alerting tone characteristics

The tone frequency combinations are as follows:

Tone	Frequencies	Warble Rate (Hz)
1	667 Hz, 500 Hz	5.2
2	667 Hz, 500 Hz	2.6
	:	
3	1600 Hz, 2000 Hz	5.2
4	1600 Hz, 2000 Hz	2.6
	:	
3	333 Hz, 250 Hz	5.2
4	333 Hz, 250 Hz	2.6

A 500 Hz buzz signal is provided for incoming call notification while the receiver is off-hook.

Power requirements

The Meridian digital telephones are loop powered. Loop power, originating in the ISDLC or the DLC, consists of a 30 Vdc power source and assumes a 3500 ft. (1219 m) maximum loop length of 24 AWG (0.5 mm) wire and a minimum 15.5 Vdc at the telephone terminals.

Note: The loop length limit is defined by a 15.5 dB loss at 256 KHz. Longer lengths can be determined using the wire's gauge and insulation.

Some configurations of telephones and options need more than basic loop power to operate. Table 101 lists the types of Meridian digital telephones and shows when additional power is needed to operate the telephone or its optional hardware. Power Supply Boards come installed in factory-assembled configurations that require additional power.

Note: If a power failure occurs, configurations that require loop power will continue to work only if the system has battery backup. Only those options that require additional power will cease to function.

Table 101
Power requirements, Meridian digital telephones

Telephone	Loop power	Additional power (Power Supply Board)
M3820	Terminal, handsfree, headset, key expansion	MCA, External Alerter Interface
M3310	Terminal, headset, handsfree	MCA, External Alerter Interface
M3110	Terminal	MCA, External Alerter Interface

Power supply board

The power supply option consists of a power supply board that mounts inside the telephone, coupled with an external wall-mount transformer or closet power supply that provides power to the power supply board. The power supply board receives its power through pins 1 and 6 of the line cord.

The power supply board connects to the telephone through a 14-pin bottom entry connector.

Local plug-in transformer

A single winding transformer equipped with a 10 ft. (3 m) cord of 22 AWG two-conductor stranded and twisted wire with a modular RJ-11 duplex adapter can provide the additional power needed to operate the telephone and its options. See “Configuration of local plug-in transformer” on page 303.

CAUTION

Do not plug any equipment other than the terminal into the RJ-11 transformer adapter, as damage to equipment can result.

120 V transformer The following minimum specifications must be met by this transformer:

Input voltage	120 Vac/60 Hz
No load output voltage	29 Vac maximum
Voltage at rated current	26.7 Vac minimum
Rated load current	700 mA

240 V transformer The following minimum specifications have to be met by this transformer:

Input voltage	240 Vac/50 Hz
No load output voltage	29 Vac maximum
Voltage at rated current	26.7 Vac minimum
Rated load current	700 mA

Note 1: You cannot wall mount the telephone over the wall jack when using a transformer because of the size of the RJ-11 adapter. Hang it above or to the side of the jack and run the line and power cords to it.

Note 2: The above-mentioned transformers can also be used with outlets identified as 110V or 220V.

Closet Power Supply

Closet power can be obtained from an AC transformer for loops of 100 ft. (30 m) or less, or a DC transformer for loop lengths of 650 ft. (198 m) or less. An equivalent power source can be used but must be UL listed to provide isolation of outputs to the terminal. See “Closet power supply configuration” on page 305.

CAUTION

When using closet power, do not plug the TELADAPT connector into any equipment other than the Meridian digital telephone, as damage to equipment may result.

Note 1: All terminals must be isolated from the input winding and each terminal must be isolated from all other terminal windings. A separate winding is required for each terminal, and grounds must not be connected.

Note 2: The QUT1 closet power supply source is not compatible with Meridian digital telephones.

The AC source must be rated at 29 Vac, 700 mA isolated. The DC source must be rated at 42 Vdc, 300 mA isolated, with current limiting output of 1 amp.

Chapter 16 — M5317 BRI Terminal

Contents

This section contains information on the following topics:

Introduction	337
Physical description	338
Dimensions	338
Weight	338
Environmental considerations	338
Temperature	338
Humidity	338
Electromagnetic emissions	339
Atmospheric pollution	339
Terminal powering	339
Line engineering	339
Powering alternatives	339
Restricted powering	340
Power consumption	340
Voltage range	340
Local power supply requirements	340
Features	341
Display	341
Softkeys	342
Designated function keys	342

Programmable function keys	343
Automatic dial keys	343
LCD Indicators	344
Handsfree/Mute	345
Data and headset option	346
Dial access	346
Power	346
Servicing	347
Telephone programming	347
Service Profile Management	347
Downloading	347
BootROM operation	347
Configuration mode	348
Setup mode	348
Self test	349
Error code displays	349
Data LTID	349
Local voice features	349
Auto PDN select	349
Autonumber	350
List incoming callers	350
Handset muting	350
Handsfree/Mute (speakerphone or headset)	350
Volume	351
Contrast	351
Predial	351
Number editing	351
Dual Tone Multifrequency (DTMF) generation	351
Local generation and cadencing of alerting tones	351
Call timers	352

Date and time-of-day clock	352
Data transmission	352

Introduction

The M5317TX and M5317TDX BRI Terminals are for use in North America. The CustomNet ISDN Handset is the same telephone without NI-1 Signaling or Meridian 1 voice operation, and is for use in Australia.

M5317TDX telephones and CustomNet ISDN Handsets are connected to the ISDN BRI (Basic Rate Interface) Service at the “S” (or “T”) interface. The M5317TX and M5317TDX are identical except the M5317TDX has the Data Option installed on it.

Meridian Feature Transparency (MFT), National ISDN-1 Signaling (NI-1), and Meridian 1 (Mer1) protocols are supported for voice. Circuit-switched data is only supported in NI-1 Signaling.

A-law or μ -law Pulse Code Modulation (PCM) voice capability is supported on either the B1 or the B2 channel.

Circuit-switched data calls are supported using T-link or V.120 protocol, and packet-switched data calls are supported using X.25 (D-channel) protocol.

Physical description

Dimensions

The M5317T telephones have these dimensions:

length	226.5 mm (9 in.)
width	272.0 mm (10.7 in.)
height (front)	27.5 mm (1.1 in.)
height (rear)	73.5 mm (2.9 in.)

Weight

Excluding the handset, cords, and any packaging, the M5317TX or the M5317TDX weigh approximately 1000 grams (2.2 lbs).

Environmental considerations

Temperature

in operation	in storage
0° to 50°C (32° to 122°F)	-20° to 66°C (-4° to 150°F)

Humidity

in operation	in storage
5% to 95% non-condensing, from 0° to 29°C (32° to 84°F)	-20° to 66°C (-4° to 150°F)
Equivalent to 34% at 50°C (122°F) non-condensing from 30°C to 50°C (86°F to 122°F)	Equivalent to 15% at 66°C (150°F) non-condensing from 29° to 66°C (84° to 150°F)

Electromagnetic emissions

The M5317T telephones are specified to comply with the limits for Class A, Subpart J of the Federal Communications Commission (FCC), Part 15 and Class B, CSA C108.8, CISPR22 Class B (AS 3548).

Atmospheric pollution

Each M5317T telephone is designed to withstand normal atmospheric conditions throughout its life and during shipment. It meets exposure tests for salt, mist, atmospheric dust, sulfur dioxide and hydrogen sulfide as defined in IEC document 50.

Terminal powering

Line engineering

The telephones will operate to their full potential through twisted pair wiring.

Powering alternatives

The telephones are powered through the RJ connectors and the line cord. They may be powered from one of the following sources:

- PS1, phantom power conducted over the “T” line card or the NT1
- PS2, auxiliary DC power conducted over a third pair in the line cord (may be provided independently of the NT1 or line card)
- Local DC power conducted over a third pair from a power pack (connected by means of an RJ-45 plug connector with the DC power terminated on its pin 7 (PS2-) and pin 8 (PS2+) inserted into one of the wall-mounted RJ sockets.

A dip switch (switch A), accessible through a small hatch in the base of the telephone housing, must be set to select between the phantom powering (PS1) or powering provided by a third pair (PS2 or local AC).

Restricted powering

A second dip switch (switch B), in the same location and accessible through the same access hatch as switch A must be set to determine whether the telephone accepts restricted powering from PS1 or PS2. As a rule, only one telephone on a loop is designated for restricted powering and is named the “designated” telephone. When an NT1 or line card reverses the polarity of the PS1 or PS2 power output while operating from backup batteries, only a “designated telephone” continues to operate.

Power consumption

The normal standby mode power consumption indicated below depends on deactivating the S/T-loop (not currently supported).

Operating Mode	M5317TX	M5317TDX
Normal active	1.2.2W	1.5W
Normal standby	200mW	250mW

Voltage range

The following are the operating limits when attached to an S/T-loop:

24 V - Minimum DC input voltage at the line cord when the loop is full loaded (PS2)

56.5 V - Maximum DC input voltage at the line cord when the loop is not loaded (PS2)

Local power supply requirements

The following values apply to sealed plug-in AC transformers with rectified DC output, used for local power supply from a wall-outlet directly at the working location of the telephone.

Australia

Minimum AC voltage at outlet: 200 V rms

Maximum AC voltage at outlet: 280 V rms

Average maximum AC current required: 50 mA

AC supply frequency: 50 Hz

Minimum transformer output voltage: 24 V DC

Maximum transformer output voltage: 34 V DC

North America

Minimum AC voltage at outlet: 97 V rms

Maximum AC voltage at outlet: 132 V rms

Average maximum AC current required: 100 mA

AC supply frequency: 60 Hz

Minimum transformer output voltage: 24 V DC

Maximum transformer output voltage: 34 V DC

Features

Display

The 155 x 15 mm (6 x 0.6 in.) alphanumeric LCD assembly has a display capacity of two 40-character lines. In NI-1 and Meridian 1 modes, the first line usually displays date and time (during the idle state only), incoming call identification, connection information, feature icons, user prompts, and messages.

Figure 50
Display icons (enlarged view)

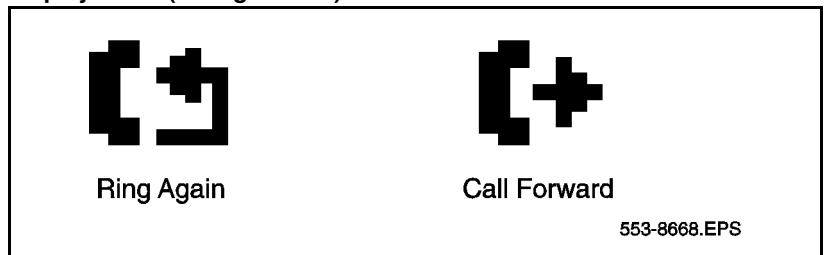

The second line displays the context-dependent softkey functions (8 characters per key, including spaces) in accordance with the state of the terminal, whenever applicable. If there are more than five choices available, a more... softkey is shown. The softkey labels always give the currently valid commands and features. Pressing that softkey displays additional labels available for the accessed telephony state.

If MFT mode is used, both lines of the LCD may be used for call information.

Displays are defined by the switch software, and may vary between software loads. In BCS34, the idle display is blank, and at other times call progress information is displayed on both lines.

Softkeys

In NI-1 mode, the softkey labels display functions only for local and network features that have been datafilled. The available functions may vary from telephone to telephone and, consequently, a softkey label may be displayed in different locations at different times on different sets. Refer to the User guides for examples and detailed explanations of the functioning of the various softkey features.

In NI-1 mode, the following features are supported on softkeys:

- Call Forward
- Call Park
- Call Pickup (group)
- Executive Busy Override
- Make Set Busy
- Privacy Release/Privacy
- Ring Again/Call Back Queuing
- Three-Way Call (Flexible Calling)
- Call Transfer

In Meridian 1 mode, this feature is supported on softkeys:

- Calling Line ID Presentation/Calling Line ID Restriction

Designated function keys

There are 15 designated function keys, each with a fixed function assigned. They consist of:

- 12 dial pad keys
- 1 Release (Rls) key
- 1 Hold key
- 1 Volume Control key (with 2 toggle positions and center press function)

The assignment of these keys is different depending on whether MFT, Meridian 1 or NI-1 is being used.

Programmable function keys

Keys 2 to 11 for NI-1 and Meridian 1, and keys 2 to 10 for MFT, may be assigned varying functions depending on the network datafill.

Figure 51
Key layout

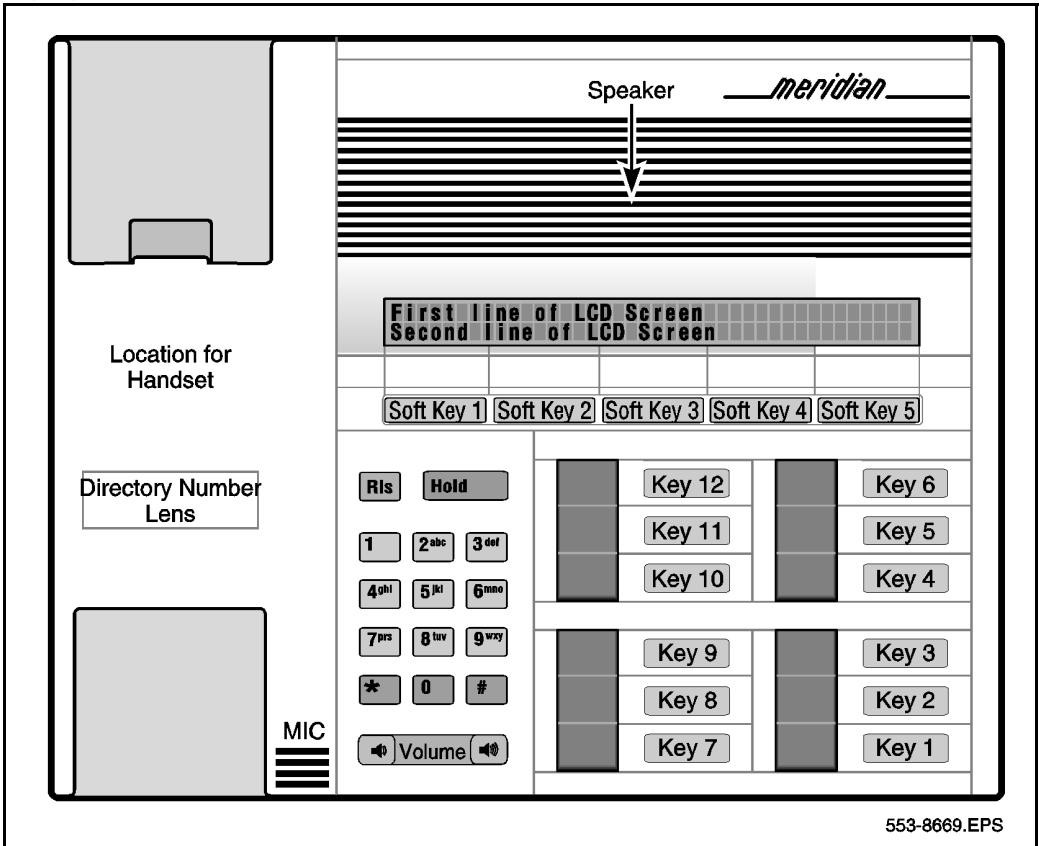

Automatic dial keys

In NI-1 and Meridian 1 modes, frequently-used numbers can be stored by programmable keys defined as local automatic dial keys. Any programmable function key that isn't programmed can be used as an automatic dial key.

Any number stored is retained, and the stored numbers are not affected by a power failure. The call to a stored directory number is made by pressing the programmed key.

LCD Indicators

All of the programmable function keys have liquid crystal display indicators beside them.

Table 102
Key status indicator

Indicator	Description
Off	Off
On	Off
Slow flashing	60 ipm*: 1/2 on, 1/2 off
Fast flashing	120 ipm*: 2/3 on, 1/3 off
* Impulses per minute	

Table 103
Normal DNs in all signaling modes

Indicator	Meaning
Off	Feature or line is not active
On	Feature or line is active
Slow flashing	Line is ringing
Fast flashing	Line is on hold or feature is being programmed
* Impulses per minute	

Table 104
Shared DNs

Indicator	Meaning
Slow flashing	Line is ringing
Fast flashing	On hold (retrieval allowed by other DN members)
Fast flashing	In "talking" state (bridging allowed by other DN members)
On	In "talking" state (no bridging or retrieval allowed by other DN members)
On	Feature or line is active
* In MFT mode, "talking" state (no bridging or retrieval allowed by other DN members) the state is On.	

Table 105
Features (such as Speed Call)

Indicator	Description
Off	Feature or line is not active
On	Feature or line is active
Fast flashing	Feature is being programmed

Handsfree/Mute

A microphone and speaker are built in to permit Handsfree/Mute operation.

Data and headset option

An optional feature card (factory or field installed) permits the use of circuit and packet switched data by way of an RS-232C connector at the rear of the telephone, which allows connection of a personal computer (PC) terminal; the card also allows an appropriate headset to be used instead of the built-in Handsfree/Mute speakerphone. Field installation requires opening the telephone, which should only be done by an experienced installer. The data option serves as a DCE (Data Communications Equipment), using either a subset of the Hayes Smartmodem protocol or an X.25 PAD using X.3, X.28, X.29 protocols. The RS-232C data port may also be configured to provide control of the telephone for system test purposes.

Dial access

Any available dialed code access features may be used. Special screens or softkeys are not associated with them. The following are examples of dialed code access features:

- Directed Call Pickup
- Directed Call Park
- Authorization Code Entry
- Call Request
- Loudspeaker Paging
- Dictation Access and Control

Power

Power for the M5317T telephones is always supplied through the line cord. The telephones can be configured for either designated (continued service during local power failures) or non-designated (no service during local power failures) operation.

Power may be provided from PS1 or PS2 source output of NT1 interface, or can be provided locally from a sealed alternating current (AC) plug-in transformer with direct current (DC) output.

Servicing

Except for the insertion or removal of the data and headset option circuit board, as noted above, it is not necessary to open the telephone case for field servicing purposes. The telephone line cord and the handset cord are both equipped with TELADAPT connectors at both ends, permitting quick replacement where required. A hatch is provided for access to the dip switches to permit the selection of the appropriate power supply and of the “designated” telephone status.

Telephone programming

Service Profile Management

In NI-1 mode, information related to the programmable keys may be loaded into the M5317T memory from the Integrated Services Digital Line Card (ISDC) at the switch. This feature loading process will be performed on request. Currently, only DMS central offices support this service.

Accessibility of features depends on subscription at the switch, and softkeys for features not subscribed are removed from the display. Not all features need be provided in every case. Service change routines permit addition or deletion of features. If no feature loading takes place, the telephone must be configured manually. *Do not confuse this feature loading with the overall firmware downloading.* The information is stored so that it is not lost when the power is removed.

In MFT mode, there is no equivalent process required because the protocol is much simpler. There is no such process for Meridian 1 mode because no optional features are provided.

Downloading

Firmware in the M5317TDX can be replaced by downloading from a server. This procedure is usually only required to customize the firmware, or to make additional features available.

BootROM operation

If downloading fails, or if the user selects it, control from the Main firmware is replaced by a simpler version called the Boot ROM firmware. This allows basic voice call operation until successful downloading is achieved.

Configuration mode

This feature is intended for installers and sophisticated users and is interlocked with power-on and a special key sequence. Some menus are:

- TEI assignment voice, circuit-switched data, and packet-switched X.25 data (no default, but retained if power lost). X.25 TEI can only be static; the others must be dynamic.
- Service Identifier Profile (SPID) assignment for voice and circuit-switched data, not required for packet-switching. (no default, but retained if power is lost.)
- DN assignment for circuit-switched and packet-switched data
- Test: analog and digital
- Selection of Codec coding law
- Selection of voice and circuit-switched data signaling protocol

Setup mode

Setup mode is intended for use by all M5317T digital telephone users. In NI-1 and Meridian 1 mode, press Setup to display the Setup menu. In MFT mode, press the center of the volume key to access Setup. The Setup menu includes:

- alerting tone style and cadence (NI-1 and Meridian 1 mode only)
- default volume for handset/headset, alerting tones, and speakerphone (NI-1 and Meridian 1 mode only)
- query features enabled and DNs (NI-1 and Meridian 1 mode only)
- Service Profile Management (SPM). Enter the four-digit password “5317” to display an SPM softkey.
- various data options (baud rate, parity, etc.)
- protocol version
- contrast adjustment
- language

Self test

During power-up, the M5317T tests many internal components and displays error codes if the test fails at any point. These codes are used in manufacturing testing only.

Error code displays

NI-1 and Meridian 1 modes only. (During startup, there are error codes in MFT too. During normal operation, there are no error codes on the idle display, but they can be accessed as described earlier for Setup mode.)

When errors are detected by the telephone, an error code replaces the normal date and time in the right-hand upper corner of the display.

Data LTID

For NI-1 and MFT mode, data LTID (Logical Terminal Identifier) must be BRAFS (Basic Rate Access: Functional Signaling). For MFT mode, you must set the bearer capability for the selected circuit. Voice may be BRAFS or BRAMFT (Basic Rate Access: Meridian Feature Transparency), depending on features and service required.

Note: Basic Rate Access is now called Basic Rate Interface (BRI).

Local voice features

Local features are provided by the phone internally with minor intervention by the switch. They are purely local in nature, or they deal with the switch on the basis of dialed digits and ringing lines, and hold and release keys. The following are brief descriptions of local features provided by the M5317T.

Auto PDN select

NI-1 and Meridian 1 modes only. This feature automatically selects the Prime Directory Number (PDN) when the user goes off-hook, dials using the Saved Number feature, or uses certain other features such as Call Pickup or Call Park Retrieve, in the idle state. The user is prompted with Select free line if the PDN is not idle.

Autonumber

NI-1 and Meridian 1 mode only. This feature accepts a telephone number if an autonumber is assigned to any definable key that is not already defined as a call activator or a feature key. After the number is assigned, pressing the key causes the stored number to be dialed as if it came from the dial pad.

Note: In NI-1 mode, this feature may be used to program any number, such as a call forward number. If the telephone is idle and the PDN is not in use, then the PDN is automatically selected when the autoline key is pressed.

List incoming callers

NI-1 and Meridian 1 modes only. This feature provides the following functions:

- Records the origination address of all incoming calls to the PDN, along with the date and time of the call.
- Multiple calls from the same caller ID will show only once.
- Ten (10) entries are saved, in chronological order, with the oldest entry being removed to make room for a new entry when the list is filled to capacity.
- The user may dial directly from the list.
- The user may edit numbers in the list to make them suitable, before dialing (for example, adding a “9” prefix).

Handset muting

With this feature, the handset is muted when on-hook.

Handsfree/Mute (speakerphone or headset)

This feature provides microphone muting, controlled by definable keys. Handsfree and mute functions are defined differently for NI-1, MFT, and Meridian 1. Speakerphone, handset, and headset operations, are also provided. The speakerphone is automatically disabled when a headset is plugged into the Teladapt connector at the rear of the telephone.

The headset and handset may be used simultaneously. When the speakerphone is being used, going off-hook transfers the speech path to the handset. When the handset is being used, operating the Handsfree key switches the speech path to the speakerphone.

Note: The Plantronics Supra (Model MH0530-1), ACS Ultralight with intra-concha earpiece (Model NWMP), and the Plantronics Starset (Model MH0230-1) are headsets which are compatible with either the M5317T telephone.

Volume

This feature provides independent adjustment for the speakerphone, alerting tones, and the headset and handset. Volume settings are retained during power failure.

Contrast

This feature provides display contrast adjustment. The setting is retained during power failure.

Predial

NI-1 and Meridian 1 modes only. This feature permits numbers to be entered and edited before selecting a line.

Number editing

NI-1 and Meridian 1 modes only. This feature permits the user, whenever applicable, to edit displayed numbers before completing an operation (for example, Call Forward programming).

Dual Tone Multifrequency (DTMF) generation

NI-1 and Meridian 1 modes only. This feature is provided whenever a B-channel is connected and used to control devices such as pagers and mechanized credit card systems. In MFT mode, DTMF is provided by the switch.

Local generation and cadencing of alerting tones

NI-1 and Meridian 1 modes only. This does not apply to MFT mode, because only the buzz is generated locally and the other tones are generated by the switch.

Call timers

NI-1 and Meridian 1 modes only. Call timers are provided as follows:

- There is one timer for each call appearance, including non-directory number (DN) call appearances.
- Timers run when associated call appearances are connected or held.
- Timers may be manually reset by the user.
- Timers start automatically after 10 seconds if a call-connect message is not received (non-ISDN or off-net calls).
- Timers start (or reset) when the called number answers.

Date and time-of-day clock

NI-1 and Meridian 1 modes only. This feature displays the time in 12-hour format. If power fails, the date and time must be reset.

Data transmission

The M5317T telephones support PCM voice on either B-channel. Circuit-switched data calls on the M5317TDX may be made using the other B-channel. The NT T-link or standard V.120 protocols are used to convert the serial data from the RS-232C port to the 64 Kbit/sec stream (rate adaptation) for transmission on the B-channel.

The M5317TDX Data Option is logically separate from voice calls. The Hayes protocol is used to control circuit-switched data calls, and X.25 packet-switched calls on D-channel are supported with X.3, X.28, X.29 control protocol.

Chapter 17 — M2250 Attendant Console

Contents

This section contains information on the following topics:

Reference List	353
Introduction	353
Description	354
Features	354
Physical details	355
Keyboard layout	355
Display screen messages	359
Connections	362
Local console controls	362
Busy Lamp Field/Console Graphics Module	362

Reference List

The following are the references in this section:

- *Busy Lamp Field/Console Graphics Module User Guide*

Introduction

Attendant consoles are designed to assist in placing and extending calls into and out of a telephone switching system. The console is operated by an attendant as the human interface between the system and the users.

Special attendant consoles are designed for telephone traffic control in the Option 11C. They provide attendants with a number of unique features which increase the speed and ease of call processing.

This document describes the M2250 attendant console. The M2250 is driven and powered by a digital line card.

Description

Features

The M2250 has the following features:

- A four-line, 40 character, liquid crystal display (LCD) with backlighting and adjustable viewing angle. Power, including backlighting, is maintained during building power failures through the system battery backup, if equipped.
- In shift mode, the M2250 can have up to 20 TGB keys.
- Up to 10 extra flexible feature keys (total of 20) in shift mode
- An optional supporting stand that can be adjusted to nine different positions.
- A handset and headset volume adjustment slider control, situated below the dial pad.
- A physical connection to a serial data port through a subminiature D-type female connector on the console back wall. This permits connection of the console to the serial port of a personal computer.
- An optional Busy Lamp Field/Console Graphics Module (BLF/CGM), which displays the status of up to 150 consecutive extensions (SBLF) or any group of 100 extensions within the system (EBLF), and has many text and graphics capabilities.
- The M2250 provides for transmission level adjustment to meet international requirements by accepting and processing downloaded information from the system (when this messaging is supported in software). The transmission level can be adjusted to one of 16 different levels.
- Angle adjustment of the display screen, which can be tilted through 90° from horizontal to fully vertical.
- Scrolling control of lines 2 and 3 of the display screen
- Multi-language selection

- Menus for local console features (options menu) and diagnostics (diagnostics menu)
- Code-blue or emergency relay (associated with ICI 0)
- Time and date system download
- Alert tone volume and frequency selection
- Electret or carbon transmitter support
- Power Fail Transfer switch
- Keyclick

Figure 53 on page 359 shows the top view of the layout of the attendant console with the user-accessible components labeled using a row/column grid arrangement. Figure 54 on page 361 shows rear, left-hand side, and bottom views of the console. These illustrations show you where to find the various components as you read this chapter.

Physical details

The attendant console dimensions are as follows:

Width	425 mm (16.75 in.)
Depth	245 mm (9.6 in.)
Height (front)	25 mm (1 in.)
Height (back)	65 mm (2.5 in.)
Height (with display screen panel up)	115 mm (4.5 in.)
Weight	approximately 2.75 kg (6 lbs)

Keyboard layout

Refer to Figure 53 on page 359 and Table 106 for the location of keys and switches.

Function keys

There are eight function keys on the attendant console, located directly below the display screen. Refer to Table 106 on page 357 for the positions, functions, and markings of these keys

Figure 52
M2250 attendant console, top view

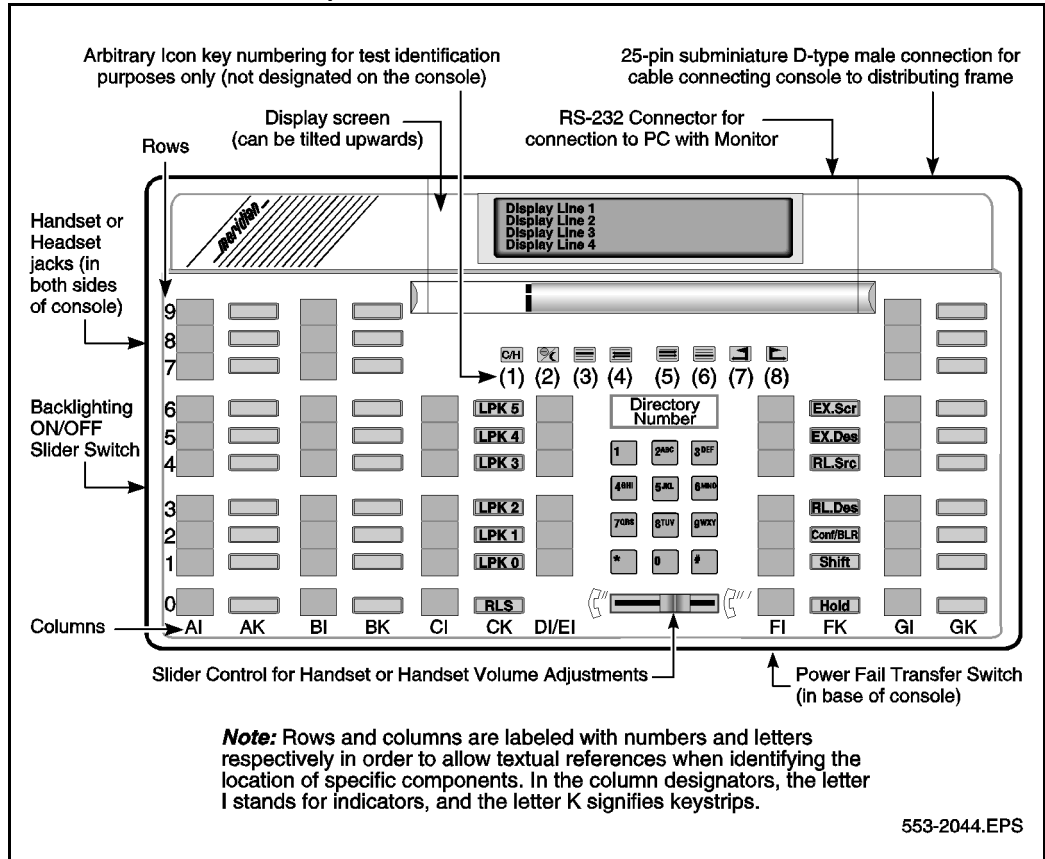

Table 106
Function key definitions and functions (Part 1 of 2)



Key number (as shown in Figure 53)	Key	Function of key
(1)		Centralized Attendant Service (CAS) or History Feature key (The History feature is not available in North America)
(2)		Prime function: Position Busy feature Level 1 function (normal): Night Service feature
(3)		Function key 1 (F1) Prime function (normal): Selects display screen line 2 for scrolling. Level 1 function (Shift): Selects the Options menu on the display screen.
(4)		Function key 2 (F2) Prime function (normal): Scrolls the currently selected line to the left Level 1 function (Shift): Decreases the alert speaker volume.

Table 106
Function key definitions and functions (Part 2 of 2)



Key number (as shown in Figure 53)	Key	Function of key
(5)		<p>Function key 3 (F3)</p> <p>Prime function (normal): Scrolls the currently selected line to the right</p> <p>Level 1 function (Shift): Increases the alert speaker volume.</p> <p>Refer also to Tables 37 and 38.</p>
(6)		<p>Function key 4 (F4)</p> <p>Prime function (normal): Selects display screen line 3 for scrolling.</p> <p>Level 1 function (Shift): Selects the Diagnostics menu on the display screen (On the M2250 console, the Diagnostics menu is password-protected. The user must first enter a 4-digit password and press * before the Diagnostics menu is displayed)</p>
(7)		<p>Prime function (normal): Signal Source feature key</p> <p>Level 1 function (Shift): Used with the Busy Lamp Field/Console Graphics Module, as CGM key.</p>
(8)		<p>Prime function (normal): Signal Destination feature key</p> <p>Level 1 function (Shift): Used with the Busy Lamp Field/Console Graphics Module, as the Mode key.</p>
<p>Note: Keys are numbered for identification purposes from 1 to 8 (left to right).</p>		

Figure 53
M2250 attendant console—top view

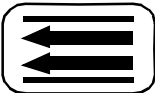
Switches

A slider switch, located in the bottom row of keys, between columns DI/EI and FI (see Figure 53), controls the handset and headset receive volume level.

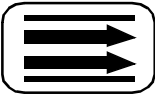
The Power Fail Transfer (PFT) switch is located in the baseplate. Both the line connector and the RS-232 connector for the PC port are located at the back of the attendant console.

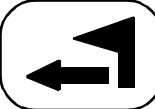
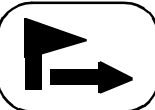
Shift key

The shift key, mentioned earlier, is positioned in column FK, row 1, just above the Hold key. It is used to access Level 1 mode functions.

Handset and headset jacks

Two jack-pairs are provided for plugging in handsets or headsets. The jacks are located on both sides of the console beneath the faceplate in the recessed area shown by the arrows. The console accepts both carbon and electret headsets and automatically adapts itself to each type.

Note: Electret headsets and handsets are polarity sensitive and must be correctly inserted into the jack.

LCD indicators

The LCD indicators used on the M2250 are half-diamond shaped symbols which normally point towards the key with which they are associated, except in the QMT2 mode of operation and the loop keys where there are two LCDs associated with each key.

Every LCD can flash at 30, 60, and 120 impulses per minute (ipm).

Display screen messages

The following messages may appear on the display screen:

- Source and destination information (line 2 and line 3 respectively)
- MN (minor alarm)
- MJ (major alarm)
- C/H (CAS/History File)

- CW (Call Waiting)
- BUSY(Position Busy)
- NIGHT(Night Service)
- IDLE(Idle)
- ACTIVE(lpk has been selected)
- S (Shift mode)

The first four status messages appear as MN, MJ, C/H, and CW on line 4 of the display screen panel. BUSY and NIGHT are combined with the status of the Release lamp to indicate the console status as shown in Table .

Table 107
Release lamp indicator status

QCW-type	Indicator	Status	Display screen status (line 4)
Night	Busy	Release	
ON	X	X	NIGHT
OFF	ON	X	BUSY
OFF	OFF	ON	IDLE
OFF	OFF	OFF	ACTIVE
X	X	X	EMERGENCY

If the emergency power fail transfer feature is activated, the console status will be displayed as EMERGENCY.

Figure 54
M2250 attendant console—rear, left side, and bottom views

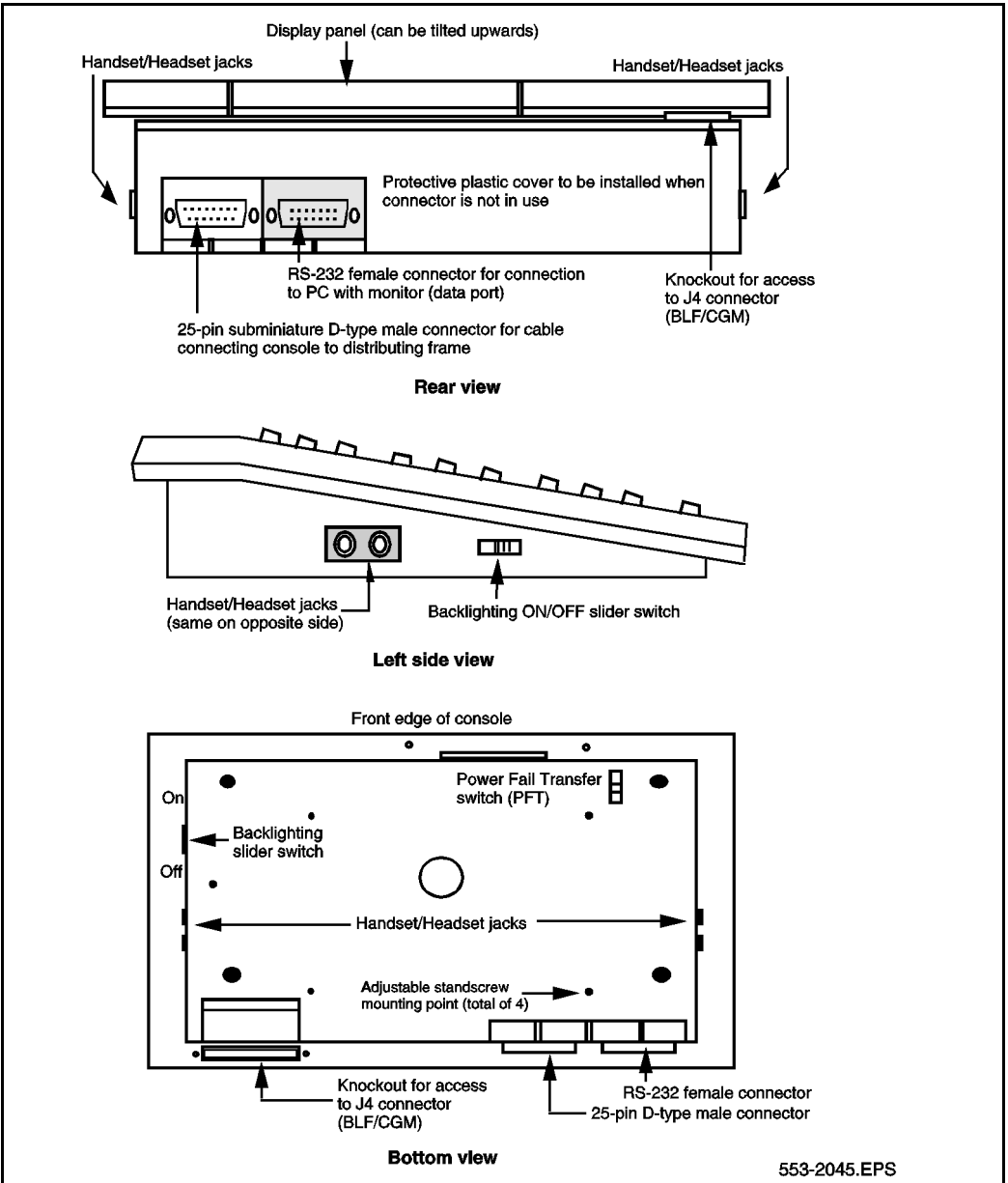

Connections

The line cord connects to the rear of the attendant console through a 25-pin subminiature D-type connector. The jack connector is attached to the line cord for user safety and equipment protection (pins are not exposed). Having the plug connector mounted in the console also prevents interchanges between the line cord and the serial data port connectors (the serial data port in the console has a jack connector).

A two-prong G3 type connector is provided on both sides of the console body to permit handset or headset connection at either side of the console. The attendant console is compatible with both carbon and electret handsets. The electret handset plug is orientation-dependent and is labeled accordingly.

The M2250 attendant console is connected to the system through two TCM loops (primary and secondary) with two additional units for powering. Two additional units may be used for long line loop powering.

The M2250 console requires a Digital Line Card (DLC).

Local console controls

The display screen contrast on the attendant console can be adjusted using the Contrast option on the Options menu.

The pitch and volume of the buzz tone on the console can be adjusted by the user.

You can choose any one of eight languages (English, French, Spanish, German, Italian, Norwegian, Gaelic, or Turkish) for the console screen displays.

The attendant console is equipped with a real time clock/calendar. The time of day (hours, minutes, and seconds) and the date (day, month, and year) are displayed on line 1 of the display screen.

The user can turn the sound of key click on or off. On the M2250, the user can adjust the pitch and volume of the key click.

Busy Lamp Field/Console Graphics Module

The Busy Lamp Field/Console Graphics Module (BLF/CGM) can be added to an M2250 attendant console.

The BLF/CGM can:

- display the status (busy or idle) of up to 150 consecutive extensions within the system (SBLF)
- display the status of any hundreds group of DN's within the system (EBLF)
- display which attendant console is the supervisory console, and which consoles are active
- display supplementary information about individual extensions, such as the reason the person is away (business, vacation, or illness), when the person is due to return, and an alternate extension where calls to the person should be directed
- display a company logo
- display graphics
- display text in any one of eight languages
- have its screen contrast adjusted for easy viewing

Installation

The BLF/CGM mounts on the back of the attendant console and is held on using snapfits and two screws. It is connected to the console using a 15-way connector that is located on the keyboard printed circuit board (PCB). This connector is accessed through a rectangular knockout section located underneath the casing overhang at the Meridian logo location (see Figure 54).

For more information on the features and operation of the BLF/CGM, refer to the *Busy Lamp Field/Console Graphics Module User Guide*.

Power requirements

The BLF/CGM obtains its power through the attendant console.

An external floating 16 V DC (300 mA) power supply (transformer—A0367601) must be cabled in at the local cross-connect terminal at a maximum of 115 ft. (35 m) from the attendant console when the BLF/CGM is installed. This provides backlighting for the BLF/CGM.

Chapter 18 — NT8D02 and NTDK16 Digital Line Cards

Contents

This section contains information on the following topics:

Description	365
Physical	366
Functional description of the NT8D02	366
Functional description of the NTDK16	367
Technical summary	369
Power requirements	370
Foreign and surge voltage protections	370

Description

The Digital Line Card is a voice and data communication link between the system and Meridian Digital Telephones. It supports voice only or simultaneous voice and data service over a single twisted pair of standard telephone wiring.

When a digital telephone is equipped with the data option, an asynchronous or synchronous terminal or personal computer can be connected to the system through the digital telephone.

In Option 11C systems the NT8D02 Digital Line Card is installed in slots 1 through 10 of the main cabinet, or in slots 11 through 50 in the Expansion cabinets. In Option 11C Mini, the NT8D02 DLC can be installed in slots 1 to 3 in the main chassis, or in slots 7 to 10 in the chassis expander.

The NTDK16 is a 48 port card supported only in the Option 11C Mini. It is based on the NT8D02 Digital Line Card, it is functionally equivalent to three NT8D02s, and configured as cards 4, 5, and 6 in the main chassis. It uses A94 Digital Line Interface chips (DLIC) to provide the interface between the Digital sets and the Option 11C Mini system.

In Option 11C Mini systems the NTDK16 Digital Line Card can only be installed in slot 4 of the main chassis which is slotted to prevent accidental insertion of other cards.

Physical

The digital line card circuitry is contained on a 320 mm (12.5 in.) by 254 mm (10 in.) printed circuit board (PCB). The NT8D02 is a double-sided PCB, whereas the NTDK16 is 4 layers, but standard thickness. Both cards connect to the backplane through a 120-pin or 160-pin edge connector.

The faceplate of the NTDK16BA digital line card is equipped with three light emitting diodes (LEDs). A red LED lights when the card is disabled. At power-up, this LED flashes as the digital line card runs a self-test. If the test completes successfully, the card is automatically enabled (if it is configured in software) and the LED goes out. This LED only shows the status of the NTDK16 in slot 4.

Note: The NTDK16AA has one LED. This LED shows the status of Card 4. The NTDK16BA has three LEDs. These LEDs show the status of Cards 4, 5, and 6 configured on the NTDK16.

Functional description of the NT8D02

The digital line card is equipped with 16 identical units. Each unit provides a multiplexed voice, data, and signaling path to and from digital apparatus over a 2-wire full duplex 512 kHz time compression multiplexed (TCM) digital link. Each digital telephone and associated data terminal is assigned a separate terminal number (TN) in the system database, for a total of 32 addressable ports per card.

The digital line card contains a microprocessor that provides the following functions:

- self-identification
- self-test

- control of card operation
- status report to the controller
- maintenance diagnostics

Functional description of the NTDK16

The NTDK16 digital line card is equipped with 48 identical units. Each unit provides a multiplexed voice, data, and signaling path to and from digital apparatus over a 2-wire full duplex 512 kHz time compression multiplexed (TCM) digital link. Each digital telephone and associated data terminal is assigned a separate terminal number (TN) in the system database, for a total of 96 addressable ports per card. Refer to Figure 55 on page 368.

The NTDK16 digital line card contains a microprocessor that provides the following functions:

- self-identification
- self-test
- control of card operation
- status report to the controller
- maintenance diagnostics

The card also provides

- Ability to support Digital sets and the Digital Console M2250
- Provides a serial link (Card LAN) for status report and maintenance.
- Supports loop lengths up to 3500 ft. (1.0 km) using 24 AWG wire.
- Interface between three DS30X loops and 48 TCM lines.

Figure 55
NTDK16 DLC

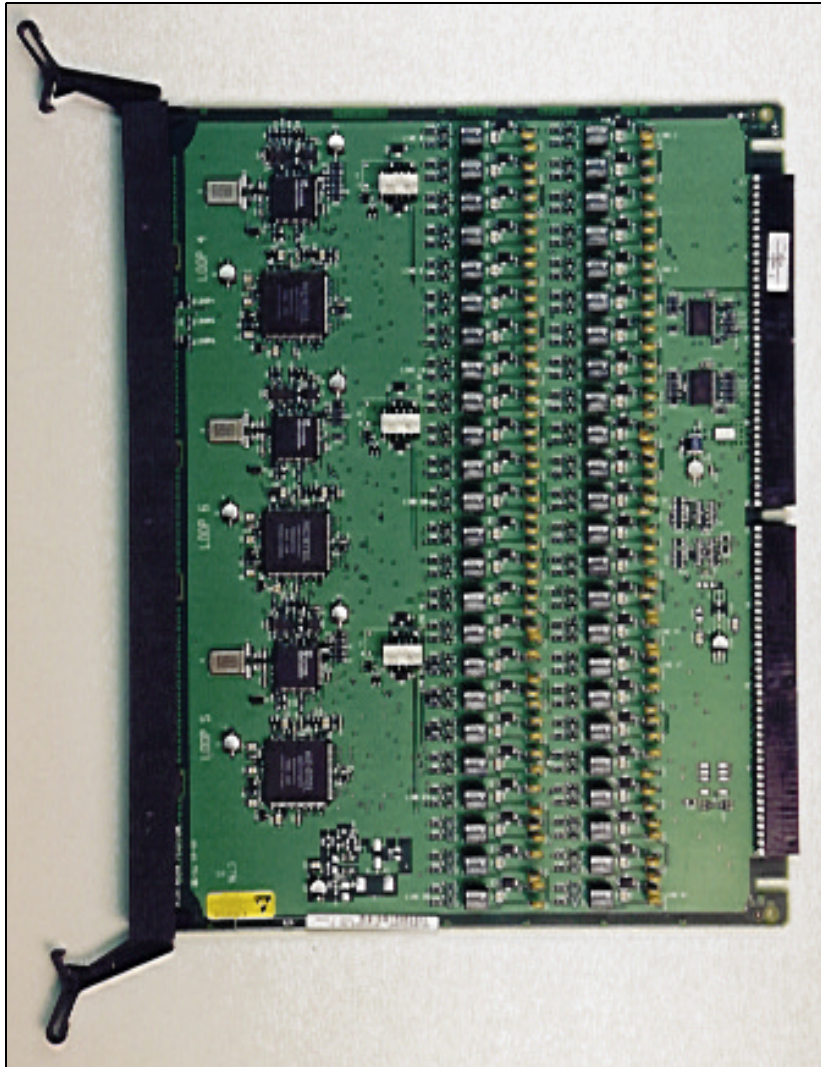

Technical summary

Table 108 provides a technical summary of the digital line cards.

Table 108
NT8D02/NTDK16 Digital Line Card technical summary

Characteristics	NT8D02 DLC description	NTDK16BA DLC description	NTDK16AA DLC description
Units per card	16 voice, 16 data	48 voice, 48 data	48 voice, 48 data
Impedance	100 Ohm j/b ohm	100 Ohm j/b ohm	100 Ohm j/b ohm
Loop limits	30 m (100 ft) to 915 m (3000 ft) with 24 AWG PVC cable (+15 V DC at 80 mA)	30 m (100 ft) to 915 m (3000 ft) with 24 AWG PVC cable (± 15 V DC at 80 mA)	30 m (100 ft) to 915 m (3000 ft) with 24 AWG PVC cable (± 15 V DC at 80 mA)
	0 to 1070 m (3500 ft) with 24 AWG PVC cable (± 15 V DC at 80 mA)	0 to 1070 m (3500 ft) with 24 AWG PVC cable (± 15 V DC at 80 mA)	0 to 1070 m (3500 ft) with 24 AWG PVC cable (± 15 V DC at 80 mA)
Line rate	512 kbps \pm 100 ppm	512 kbps \pm 100 ppm	512 kbps \pm 100 ppm
Power supply	+ 5 V DC ± 15 V DC +10 V DC	+ 5 V DC ± 15 V DC	+ 5 V DC ± 15 V DC +8 V DC
Transmitter output voltage:			
• successive "1" bits	+1.5 \pm 0.15 V and -1.5 \pm 0.15 V		
• "0" bits	0 \pm 50 mV		
Additional circuitry	Not applicable	Not applicable	Power Failure Transfer Control Ring Sync.

Power requirements

The digital line card needs $\pm 15\text{V}$ DC over each loop at a maximum current of 80 mA. It requires +15V, -15V, and +5V from the backplane. The line feed interface can supply power to one loop of varying length up to 1070 m (3500 ft) using 24 AWG wire with a maximum allowable AC signal loss of 15.5 dB at 256 kHz, and a maximum DC loop resistance of 210 ohms; 26 AWG wire is limited to 745 m (2450 ft).

Foreign and surge voltage protections

In-circuit protection against power line crosses or lightning is not provided on the Digital line card.

Chapter 19 — NT8D09 Analog Message Waiting Line Card

Contents

This section contains information on the following topics:

Description	371
Physical	372
Functional	373
Technical summary	374
Analog line interface	374
Power requirements	376
Foreign and surge voltage protections	376
Overload level	376

Description

The NT8D09 Analog Message Waiting Line Card (μ -Law) provides talk battery and signaling for regular 2-wire common battery 500-type (rotary dial) and 2500-type (Digitone dial) telephones and key telephone equipment.

The analog message waiting line card is functionally identical to the NT8D03 Analog Line Card, except that it can also connect a high-voltage, low-current feed to each line to light the message waiting lamp on telephones equipped with the Message Waiting feature.

The analog message waiting line card will support 56K modem operation.

The analog message waiting line card interfaces to and is compatible with the equipment listed in Table 109.

Table 109
NT8D09 Analog Message Waiting Line Card application and compatibility

Equipment	Specifications
500 type rotary dial sets (or equivalent): dial speed percent break interdigital time	8.0 to 12.5 pps 58 to 70% 150 ms
2500 type Digitone sets (or equivalent): frequency accuracy pulse duration interdigital time speed	± 1.5% 40 ms 40 ms 12.5 digits/s

Physical

In Meridian 1 Option 11C systems the NT8D09 Analog Message Waiting Line Card is installed in slots 1 through 10 of the Main cabinet, or in slots 11 through 50 in the Expansion cabinets. In Option 11C Mini, the card is installed in slots 1 to 3 in the main chassis, or 7 to 10 in the chassis expander.

The line card circuits connects to the backplane through a 160-pin connector. The backplane is cabled to a connector in the bottom of the cabinet which is cabled to the cross-connect terminal (main distribution frame) through 25-pair cables. Station apparatus then connects to the card at the cross-connect terminal.

The faceplate of the analog message waiting line card is equipped with a red light emitting diode (LED) which lights when the card is disabled. At power-up, the LED flashes as the analog line card runs a self-test. If the test completes successfully, the card is automatically enabled (if it is configured in software) and the LED goes out.

Functional

The analog message waiting line card contains a microprocessor that provides the following functions:

- self-identification
- self-test
- control of card operation
- status report to the controller
- maintenance diagnostics

The analog message waiting line card also provides:

- 600-ohm balanced terminating impedance
- analog-to-digital and digital-to-analog conversion of transmission and reception signals for 16 audio phone lines
- transmission and reception of scan and signaling device (SSD) signaling messages over a DS30X signaling channel in A10 format
- on-hook/off-hook status and switchhook flash detection
- 20-Hz ringing signal connection and automatic disconnection when the station goes off-hook
- synchronization for connecting and disconnecting the ringing signal to zero crossing of ringing voltage
- loopback of SSD messages and pulse code modulation (PCM) signals for diagnostic purposes
- correct initialization of all features at power-up
- direct reporting of digit dialed (500-type telephones) by collecting dial pulses
- connection of -150 V DC at 1 Hz to activate message waiting lamps
- lamp status detection
- disabling and enabling of selected units for maintenance

Technical summary

Analog line interface

Input impedance

The impedance at tip and ring is 600 ohms with a return loss of:

- 20 dB for 200-500 Hz
- 26 dB for 500-3400 Hz

Insertion loss

On a station line-to-line connection, the total insertion loss at 1 kHz is 6 dB \pm 1 dB. This is arranged as 3.5 dB loss for analog to PCM, and 2.5 dB loss for PCM to analog.

Frequency response

The loss values in Table 110 are measured relative to the loss at 1 kHz.

Table 110
NT8D09 Analog Message Waiting Line Card frequency response

Frequency	Minimum	Maximum
60 Hz	20.0 dB	--
200 Hz	0.0 dB	5.0 dB
300 Hz	-0.5 dB	1.0 dB
3000 Hz	-0.5 dB	1.0 dB
3200 Hz	-0.5 dB	1.5 dB
3400 Hz	0.0 dB	3.0 dB

Message channel noise

The message channel noise C-weighted (dBrnC) on 95 percent of the connections (line to line) with both ends terminated in 600 ohms does not exceed 20 dBrnC.

Table 111 provides a technical summary of the analog message waiting line card.

Table 111
NT8D09 Analog Message Waiting Line Card technical summary

Impedance	600 ohms
Loop limit (excluding set)	1000 ohms at nominal -48 V (excluding set)
Leakage resistance	30,000 ohms
Ring trip	During silent or ringing intervals
Ringing voltage	86 V AC
Signaling	Loop start
Supervision	Normal battery conditions are continuously applied (approximately -44.5 V on ring and -2.5 V on tip at nominal -48 V battery)
Power input from backplane	-48 (can be as low as -42 for DC-powered systems), +15, -15, +8.5 V and ringing voltage; also -150 V on analog message waiting line card.
Insertion loss	6 dB ± 1 dB at 1020 Hz 3.5 dB loss for analog to PCM, 2.5 dB loss for PCM to analog

Power requirements

Table provides the power requirements for the analog message waiting line card.

Table 112
Power requirements

Voltage (+/-)	Tolerance	Idle current	Active current	Max
+ 12.0 V DC	0.36 V DC	48 mA	0 mA	48 mA
+ 8.0 V DC	0.40 V DC	150 mA	8 mA	280 mA
- 48.0 V DC	2.00 V DC	48 mA	40 mA	688 mA
- 48.0 V DC	5.00 V DC	0 mA	10 mA (Note 1)	320 mA
86.0 V AC	5.00 V AC	0 mA	10 mA (Note 2)	160 mA
-150.0 V DC	3.00 V DC	0 mA	2 mA	32 mA

Note 1: Each active ringing relay requires 10 mA of battery voltage.

Note 2: Reflects the current for ringing a single station set. There may be as many as five ringers on each line.

Foreign and surge voltage protections

In-circuit protection against power line crosses or lightning is not provided on the Analog Message Waiting line card. When the Analog line card is used to service off-premise telephones, the NTAK92 Off-premise protection module must be used. Check local regulations before providing such service.

Overload level

Signal levels exceeding +7 dBm applied to the tip and ring cause distortion in speech transmission.

Chapter 20 — NT8D14 Universal Trunk Card

Contents

This section contains information on the following topics:

Functional description	378
Trunk types supported	378
Microprocessor	379
Signaling and control	380
Signaling interface	380
Electrical characteristics	381
Physical characteristics	381
Power requirements	382
Environmental specifications	383
Foreign and surge voltage protection	383
Release control	383
PAD switching	383
Application	385
Loop start operation	385
Ground start operation	385
Direct Inward Dial operation	385
Tie Two-way Dial Repeating operation	386
Tie Outgoing Automatic Incoming Dial operation	386

[Recorded Announcement operation](#) 386
[Paging operation](#) 387

Functional description

The Universal Trunk Card:

- allows trunk type to be configured on a per unit basis
- indicates status during an automatic or manual self-test
- provides card-identification for auto configuration, and to determine the serial number and firmware level of the card
- converts transmission signals from analog-to-digital/digital-to-analog
- operates in A-Law or μ -Law companding modes on a per unit basis
- provides software selected terminating impedance (600, 900, or 1200 ohm) on a per unit basis (1200 ohm supported for RAN trunks only)
- provides software selected balance impedance (600 ohm or complex impedance network) on a per unit basis
- interfaces eight PCM signals to one DS-30X timeslot in A10 format
- transmits and receives SSD signaling messages over a DS-30X signaling channel in A10 format
- supports PCM signal loopback to DS-30X for diagnostic purposes.

Trunk types supported

The Universal Trunk Card has eight identical units. You configure the trunk type of each unit independently in the Trunk Data Block (LD 14). The card supports the following types of trunks:

- Central Office (CO), Foreign Exchange (FX), and Wide Area Telephone Service (WATS)
- Direct Inward Dial (DID) and Direct Outward Dial (DOD)
- Tie Two-way Dial Repeating (DR) and Two-way Outgoing Automatic Incoming Dial (OAID)
- Paging (PAG)

Note: All-call zone paging is not supported.

- Recorded Announcement (RAN).

The Universal Trunk Card also supports Music, Automatic Wake Up, and Direct Inward System Access (DISA).

Table 113 is a matrix of the trunk types and signaling supported by the Universal Trunk Card.

Table 113
Supported trunk type and signaling matrix

	CO/FX WATS	DID/ DOD	Tie	PAG	RAN
Loop start	yes	no	no	no	no
Ground start	yes	no	no	no	no
Loop dial repeating	no	yes	yes	no	no
Loop OAID	no	no	yes	no	no

Microprocessor

The Universal Trunk Card is equipped with a microprocessor which controls card operation. The microprocessor also provides the communication function for the card.

The Universal Trunk Card communicates with the Controller Card through a serial communication link. Features provided through the link include:

- card-identification
- self-test status reporting
- status reporting to the Controller Card
- maintenance diagnostics

Signaling and control

The signaling and control portion of the Universal Trunk Card works with the CPU to operate the card hardware. The card receives messages from the CPU over a signaling channel in the DS-30X loop and returns status information to the CPU over the same channel. The signaling and control portion of the card provides the means for analog loop terminations to establish, supervise, and take down call connections.

Signaling interface

All trunk signaling messages are three bytes long. The messages are transmitted in channel zero of the DS-30X in A10 format.

Configuration information for the Universal Trunk Card is downloaded from the CPU at power-up or by command from maintenance programs. Eleven configuration messages are sent. Three messages are sent to the card to configure the make/break ratio and A-Law or μ -Law operation. One message is sent to each unit to configure the trunk characteristics.

Electrical characteristics

Electrical characteristics of the Universal Trunk Card are listed in Table 114.

Table 114
Universal Trunk Card electrical characteristics

Characteristic	DID trunk	CO trunk
Terminal impedance	600 or 900 ohms (selected by software)	600 or 900 ohms (selected by software)
Signaling range	2450 ohms	1700 ohms
Signaling type	Loop start	Ground or loop start
Far end battery	- 42 to - 52.5 V	- 42 to - 52.5 V
Near end battery	N/A	- 42.75 to - 52.5 V
Minimum loop current	N/A	20 mA
Ground potential difference	± 3 V	± 3 V
Low DC loop resistance during outpulsing	N/A	< 300 ohms
High DC loop resistance	N/A	Ground start equal to or greater than 30 kohms; loop start equal to or greater than 5 Mohms
Line leakage	Equal to or greater than 30 kohms (tip to ring, tip to ground, ring to ground)	Equal to or greater than 30 kohms (tip to ring, tip to ground, ring to ground)
Effective loss	See "PAD switching" on page 383	See "PAD switching" on page 383

Physical characteristics

In Meridian 1 Option 11C systems the NT8D14 Universal Trunk Card is installed in slots 1 through 10 of the Main cabinet, or in slots 11 through 50 in the Expansion cabinets.

In Option 11C systems equipped with Meridian Mail, the Universal Trunk card cannot be installed in slot 10 of the main cabinet.

When the card is installed, the red Light Emitting Diode (LED) on the faceplate flashes as the self-test runs. If the self-test completes successfully, the card is automatically enabled (if it is configured in software) and the LED goes out. If the self-test fails, the LED lights steadily and remains lit. The LED will also light and remain lit if one or more units on the card becomes disabled after the card is operating.

Each unit on the card connects to the backplane through an 80-pin connector, the backplane is cabled to the Input/Output (I/O) panel, and the I/O panel is cabled to the cross-connect terminal.

At the cross-connect terminal, each unit connects to external apparatus, such as Central Office facilities or recorded announcement equipment. Each unit connects to external apparatus by tip and ring leads which carry voice, ringing, tone signaling, and battery.

Power requirements

Power requirements for the Universal Trunk Card are specified in Table 115.

Table 115
Power requirements

Voltage	Tolerance	Idle current	Active current
± 15.0 V DC	± 5%	306 ma	306 ma
+ 8.5 V DC	± 2%	120 ma	120 ma
- 48.0 V DC	± 5%	346 ma	346 ma
+ 5.0 V DC	± 10%	350 ma	350 ma

Environmental specifications

Table 116 lists the environmental specifications for the Universal Trunk Card.

Table 116
Environmental specifications

Parameter	Specifications
Operating temperature	0 to 50 degrees C, ambient
Operating humidity	5 to 95% RH (non-condensing)
Storage temperature	- 40 to + 70 degrees C

Foreign and surge voltage protection

The Universal Trunk Card meets CS03 overvoltage (power cross) specifications.

Release control

Release control establishes which end of a call (near, far, either, joint, or originating) disconnects the call. Only incoming trunks in idle ground start configuration can provide disconnect supervision. You configure release control for each trunk independently in the Route Data Block (LD 16).

PAD switching

The transmission properties of each trunk are characterized by the class-of-service (COS) you assign in the Trunk Data Block (LD 14). Transmission properties may be via net loss (VNL) or non via net loss (non-VNL).

Non-VNL trunks are assigned either a Transmission Compensated (TRC) or Non-Transmission Compensated (NTC) class-of-service to ensure stability and minimize echo when connecting to long-haul trunks, such as Tie trunks. The class-of-service determines the operation of the switchable PADs contained in each unit. They are assigned as follows:

- Transmission Compensated
 - used for a two-wire non-VNL trunk facility with a loss of greater than 2 dB for which impedance compensation is provided

- or used for a four-wire non-VNL facility
- Non-Transmission Compensated
 - used for a two-wire non-VNL trunk facility with a loss of less than 2 dB
 - or used when impedance compensation is not provided

Table shows PAD settings and the resulting port-to-port loss for connections between the Universal Trunk Card (UTC) and any other Intelligent Peripheral Equipment (IPE) or Peripheral Equipment (PE) unit, denoted as Port B

In Option 11C systems, the insertion loss from IPE ports to IPE ports is as follows.

Table 117
Insertion Loss from IPE Ports to IPE Ports (measured in dB)

	IPE Ports									
	500/2500 Line		Digital Line		2/4 Wire E&M Trunk		4 Wire (ESN) E&M Trunk		CO/FX /WATS Loop Tie Trunk	
IPE Ports	↑	↓	↑	↓	↑	↓	↑	↓	↑	↓
CO/FX/ WATS Loop Tie Trunk										
→	2.5		0		0.5		0		0.5	
←	0		-3.5		0		-0.5		0.5	

Application

The optional applications, features, and signaling arrangements for each trunk are assigned through unique route and trunk data blocks.

Loop start operation

Loop start operation is configured in software and is implemented in the card through software download messages. When the Universal Trunk is idle, it provides a high impedance toward the CO for isolation and AC detection. The alerting signal is 20 Hz ringing sent by North American CO. When an incoming call is answered, ringing is tripped when the trunk places a low resistance DC loop towards the CO.

For outgoing calls from a telephone set or attendant console, software sends an outgoing seizure message to place a low resistance loop across the tip and ring leads towards the CO. When the CO is ready to receive digits, it returns dial tone. The outward address signaling is applied from the system in the form of DTMF tones or dial pulses.

Ground start operation

Ground start operation is configured in software and implemented through software download messages. In an idle state, the tip conductor from the CO is open and a high resistance negative battery is present on the tip of the trunk. This biases the tip ground detector OFF until the CO places ground on the tip at seizure. After the tip ground is detected, the Universal Trunk Card scans for a ringing detection signal before presenting the call to an attendant and tripping the ringing. A low resistance is placed across the tip and ring conductors and a speech path is established.

Direct Inward Dial operation

An incoming call from the CO places a low resistance loop across the tip and ring leads. Dial pulses or DTMF signals are then presented from the CO. When the call is presented and the terminating party answers, the Universal Trunk Card reverses battery and ground on the tip and ring leads to the CO. The trunk is arranged for first party release. The CO releases the trunk by removing the low resistance loop and normal battery and ground are restored at the system.

Tie Two-way Dial Repeating operation

In an incoming call configuration, the far end initiates a call by placing a low resistance loop across the tip and ring leads. This causes a current to flow through the battery feed resistors in the trunk circuit. Address signaling is then applied by the far end in the form of DTMF tones or dial pulses. When the called party answers, an answer supervision signal is sent by software, causing the trunk to reverse battery and ground signals to the far end. The far end then removes the low resistance loop and normal battery and ground are restored at the system.

In an outgoing call configuration, the Universal Trunk is connected to another PBX by a Tie trunk. An outgoing call from the system seizes the trunk facility by placing a low resistance loop across the tip and ring leads. Outward addressing is then applied from the system in the form of DTMF tones or dial pulses (battery/ground pulsing). If answer supervision is provided by the far end, reverse battery is received, which provides a disconnect supervision signal.

Tie Outgoing Automatic Incoming Dial operation

When the Universal Trunk is seized by the far end on an incoming call, a low resistance loop is placed across the tip and ring leads. Dial pulses are sent by the far end by interrupting the loop current. The trunk is released at the far end when the loop is opened. When it detects an open loop, the near end reverts to a normal state.

When seized as a dial-selected outgoing trunk, the Universal Trunk places battery on the tip and ground on the ring. This alerts the far end of the seizure. The far end responds with a low resistance across the tip and ring leads.

Recorded Announcement operation

In this mode of operation, the Universal Trunk is connected to a digital announcement machine. The announcer provides a number of channels and operates in a continuous mode, generating 150-300 ms common control pulses every 7 or 14 seconds (at the start of the announcement period). A number of trunks can be connected to one announcement machine.

The Universal Trunk Card does not support the Code-A-Phone 210DC announcement recorder.

Paging operation

In the Paging mode, the Universal Trunk is connected to a customer-provided paging amplifier system. When the trunk is accessed by dial-up or attendant key operation, it provides a loop closure across control leads A and B. In a typical application, this will transfer the input of the paging amplifier system to the transmission path of the trunk.

Chapter 21 — NT8D15 E&M Trunk Card

Contents

This section contains information on the following topics:

Reference List	390
General information	390
Functional description	391
Common features	391
Trunk circuit features	392
Signaling and control	392
Microprocessor	393
Signaling interface	393
Card-LAN	394
Electrical characteristics	394
Physical characteristics	395
Application	395
Release Control	396
PAD Switching	396
Paging trunk operation	397
Technical summary	398
Power requirements	398
Environmental specifications	398
Foreign and surge voltage protection	398

Reference List

The following are the references in this section:

- *Features and Services* (553-3001-306)
- *Administration* (553-3001-311)

General information

This chapter outlines the characteristics, application and operation of the NT8D15 E&M Trunk Card. The information is intended to be used as a guide when connecting customer-provided apparatus to the trunk circuit.

NT8D15 E&M Trunk Card has four identical trunk circuits. Each circuit can be configured independently by software control. The trunk circuits on the card support the following types of trunks:

- two-wire E & M type I signaling trunks (non-ESN)
- two-wire dial repeating trunks
- two or four wire tie trunks
- four-wire E & M type I and II signaling type II trunks (ESN and Non-ESN applications)
- Paging (PAG)

Type I signaling (as on the two-wire E & M trunk) utilizes two signaling wires plus ground. Type II signaling utilizes two pairs of signaling wires and is used by most electronic switching systems.

Table shows a matrix of the trunk types and signaling supported by the NT8D15 E&M Trunk Card.

Table 118
Supported trunk and signaling matrix

Signaling	RLM RLR	ATV	TIE	PAG	CSA CAA CAM
2-wire E & M	yes	yes	yes	yes	yes
4-wire E & M	yes	yes	yes	yes	yes

Functional description

The NT8D15 E&M Trunk Card serves various transmission requirements. The trunk circuits on the card can operate in either A or μ -Law companding modes. The mode of operation is set by service change entries.

Common features

The following features are common to all circuits on the NT8D15 E&M Trunk Card:

- Analog-to-digital and digital-to-analog conversion of transmission signals
- Interfaces each of the four PCM signals to one DS30X timeslot in A10 format
- Transmit and receive SSD signaling messages over a DS30X signaling channel in A10 format
- Ability to enable and disable individual ports or the entire card under software control
- Provides outpulsing on the card. Make break ratios are defined in software and down loaded at power up and by software commands.
- Provides indication of card status from self-test diagnostics on faceplate Light Emitting Diode (LED)
- Supports loopback of PCM signals to DS30X for diagnostic purposes
- Card ID provided for auto configuration and determining serial number and firmware level of card
- Software controlled terminating impedance (600, 900, or 1200 ohm) two and four-wire modes
- Allows trunk type to be configured on a per port basis in software
- Software controlled 600 ohm balance impedance is provided.
- isolation of foreign potentials from transmission and signaling circuit
- Software control of A/ μ law mode
- Software control of digit collection

Trunk circuit features

The following features in addition to those previously listed are provided by each circuit:

- Two-wire E & M type I signaling (Non-ESN)
 - Near-end seizure and outpulsing with M lead
 - Ground detection with E lead
 - Voice transmission through Tip and Ring for transmit and receive
- Four-wire E & M signaling type I and II, two-way dial repeating (ESN and Non-ESN)
 - echo suppression for type I
 - Switchable seven dB and 16 dB for carrier interface for ESN applications
 - Transmit and receive of voice through two separate paths
- Type I signaling through E & M leads
 - Type II signaling
 - Near-end seizure with MA/MB leads
 - Far-end detection with EA/EB leads
- Paging trunk loop OAID operation
 - Support access by low resistance path at the PA/PB lead.
 - All call zone paging is not supported.
- Two to four-wire conversion of the transmission path

Signaling and control

The signaling and control portion of the trunk card works with the CPU to operate the card hardware. The card receives messages from the CPU over a signaling channel in the DS30X loop and returns status information to the CPU over the same channel. The signaling and control portion of the card provides the means for analog loop terminations to establish, supervise and take down call connections.

The signaling and control operation of the card performs many functions which are handled by different functional units. Some of the functions of the signaling and control portion of the E & M card are:

- Communications between the card and the CPU
- Monitor signals from the trunk interface and generate a message when required for each state change
- Decode received messages and activate/deactivate configuration and interface relays PCM loopback for diagnostic purposes
- Disable and enable units for maintenance
- Drive Light Emitting Diode (LED) on faceplate
- Decode outpulsing messages (one per digit) from the CPU to drive outpulsing relays
 - Make break ratios (20pps, 10pp1, 10pps2) are downloaded by software.
- Control of A/mu-law operation

Microprocessor

The E & M trunk has a microprocessor which performs a number of operations. On power up a self test of the circuitry on the card is performed. The self-test can also be requested by a command entered in maintenance programs. The card faceplate Light-Emitting Diode (LED) is lit while the self test is performed. If the self test passes, the faceplate LED flashes three times and stays lit until the card is enabled in software. If the test fails, the LED stays lit (does not flash).

Signaling interface

All signaling messages for the trunk are three bytes long. The messages are transmitted in channel zero of the DS30X in A10 format.

Configuration information for the E & M trunk is downloaded from the CPU at power up and by command from maintenance programs. Seven configuration messages are sent. One message is sent to each unit (4) to configure trunk type, signaling type, balance impedance etc. Three messages are sent per card to configure the make/break ratio, A/mu-Law operation.

Card-LAN

The Card Lan interface supports maintenance functions. The following list of features are provided by the Card Lan:

- Polling form the Peripheral Controller
- Enable disable of the DS30X link
- Card status reporting
- Self-test status reporting
- Card ID
- Report configuration data
- Report of the firmware version

The Card Lan communicates through a serial communication link between the trunk card and the Peripheral Controller. The microprocessor provides the Card Lan function for the E & M Trunk.

Electrical characteristics

The electrical characteristics of all trunk circuits are provided in Table 119.

Table 119
Electrical characteristics (Part 1 of 2)

Characteristic	DID Trunk	CO trunk
Nominal impedance	600 or 900 ohms, (selected by software)	600 or 900 ohms, (selected by software)
Signaling range	2450 ohms	1700 ohms
Signaling type	Loop	Ground or loop start
Far-end battery	-42 to -52.5 V	-42 to -52.5 V
Near-end battery	N/A	-42.75 to -52.5 V
Minimum loop current	N/A	20 mA
Ground potential difference	+ 10 V	+ 3 V

Table 119
Electrical characteristics (Part 2 of 2)

Characteristic	DID Trunk	CO trunk
Low DC loop resistance during outpulsing	N/A	300 ohms
High DC loop resistance	N/A	Ground start equal to or greater than 30 kS. Loop start equal to or greater than 5 MS
Line leakage	Equal to or greater than 30 kS (Tip to Ring, Tip to GND, Ring to GND).	Equal to or greater than 30 kS (Tip to Ring, Tip to GND, Ring to GND)
Effective loss	See pad table	See pad table

Physical characteristics

In Option 11C systems the NT8D15 E&M Trunk Card is installed in slots 1 through 10 of the Main cabinet, or in slots 11 through 50 of the Expansion cabinets.

In Option 11C systems equipped with Meridian Mail, the Universal Trunk line card cannot be installed in slot 10 of the main cabinet.

Each card provides four circuits. Each circuit connects with the switching system and with the external apparatus by an 80-pin connector at the rear of the pack.

Each trunk circuit on the card connects to trunk facilities by tip and ring leads which carry voice, ringing, tone signaling and battery. Trunk option selection is determined by software control in LD 14.

Application

The optional applications, features and signaling arrangements for each trunk are assigned through unique route and trunk data blocks. Refer to the *Features and Services* (553-3001-306) for information about assigning features and services to trunks.

Release Control

Release control of a call made over a trunk is specified in the route data block (LD 16). Disconnect supervision is specified for each trunk group independently.

Only incoming trunks in idle ground start configuration can provide disconnect supervision. For a list of prompts and responses and default conditions see the *Administration* (553-3001-311).

PAD Switching

The transmission properties of each trunk are characterized by class-of-service (COS) assignments in the trunk data block (LD 14). The assignment may be non-Via Net Loss (non-VNL) or via Net Loss (VNL). To ensure stability and minimize echo when connecting to long-haul VNL (Tie) trunks, non-VNL trunks are assigned either Transmission Compensated (TRC) or Non-Transmission Compensated (NTC) class-of-service.

The TRC and NTC COS options determine the operation of the switchable pads contained in the trunk circuits. They are assigned as follows:

- TRC for a two-wire non-VNL trunk facility with a loss of greater than 2 dB or for which impedance compensation is provided, or for a four-wire non-VNL facility.
- NTC for a two-wire non-VNL trunk facility with a loss of less than 2 dB or when impedance compensation is not provided.

In Option 11C systems, Table 120 on page 397 shows the insertion loss from IPE port to IPE port.

Table 120
Insertion Loss from IPE Ports to IPE Ports (measured in dB)

	IPE Ports				
	500/2500 Line	Digital Line	2/4 Wire E&M Trunk	4 Wire (ESN) E&M Trunk	CO/FX /WATS Loop Tie Trunk
IPE Ports	↓ ↑	↓ ↑	↓ ↑	↓ ↑	↓ ↑
2/4 Wire E&M Trunk	→ 6 ← 3	→ 3.5 ← -0.5	→ 1 ← 1		
4 Wire (ESN) E&M Trunk	→ 5.5 ← 2.5	→ 3 ← -1	→ 0.5 ← 0.5	→ 0 ← 0	

Paging trunk operation

When used in the Paging mode the trunk circuit is connected to a customer-provided paging amplifier system. When the trunk is accessed by dial up or attendant key operation, it provides a loop closure across control leads A and B. In a typical application this will transfer the input of the paging amplifier system to the transmission path of the Trunk.

Technical summary

Power requirements

Power requirements for the NT8D15 E&M Trunk Card are specified in Table 121.

Table 121
Power requirements

Voltage	Tolerance	Idle Current	Active Current
+/- 15.0 V DC	+/- 5%	200mA	200 mA
+ 8.5 V DC	+/- 2%	200 mA	200 mA
- 48.0 V DC	+/- 5%	415 mA	415 mA
+5.0 V DC	N/A	N/A	N/A

Environmental specifications

Environmental specifications are provided in Table 122.

Table 122
Environmental specifications

Parameter	Specifications
Operating temperature	0-50 degrees C, ambient
Operating humidity	5 to 95% RH (non condensing)
Storage temperature	-40 to +70 degrees C

Foreign and surge voltage protection

The E & M trunk circuit meets CS03 over voltage (power cross) specifications.

Chapter 22 — NT5K21 XMFC/MFE card

Contents

This section contains information on the following topics:

Overview	399
MFC signaling	399
Signaling levels	400
Forward and backward signals	400
MFE signaling	402
Sender and receiver mode	403
XMFC sender and receiver specifications	404
XMFE sender and receiver specifications	406
Physical specifications	407

Overview

The XMFC/MFE (Extended Multi-frequency Compelled/Multi-frequency sender-receiver) card is used to set up calls between two trunks. Connections may be between a PBX and a CO or between two PBXs. When connection has been established, the XMFC/MFE card sends and receives pairs of frequencies and then drops out of the call.

The XMFC/MFE card can operate in systems using either A-law or μ -law companding by changing the setting in software.

MFC signaling

The MFC feature allows the Option 11C system to use the CCITT MFC R2 or L1 signaling protocols.

Signaling levels

MFC signaling uses pairs of frequencies to represent digits, and is divided into two levels:

Level 1: used when a call is first established and may be used to send the dialed digits.

Level 2: used after Level 1 signaling is completed and may contain such information as the status, capabilities, or classifications of both calling parties.

Forward and backward signals

When one NT5K21 XMFC/MFE card sends a pair of frequencies to a receiving XMFC/MFE card (forward signaling), the receiving XMFC/MFE card must respond by sending a different set of frequencies back to the originating XMFC/MFE card (backward signaling). In other words, the receiving card is always “compelled” to respond to the originating card.

In summary, the signaling works as follows:

- The first XMFC/MFE card sends a forward signal to the second card.
- The second card hears the forward signal and replies with a backward signal.
- The first card hears the backward signal and “turns off” its forward signal.
- The second card hears the forward signal being removed and removes its backward signal.
- The first XMFC/MFE can either send a second signal or drop out of the call.

MFC signaling involves two or more levels of forward signals and two or more levels of backward signals. Separate sets of frequencies are used for forward and backward signals:

- **Forward signals.** Level I forward signals are dialed address digits that identify the called party. Subsequent levels of forward signals describe the category (Class of Service) of the calling party, and may include the calling party status and identity.
- **Backward signals.** Level I backward signals (designated “A”) respond to Level I forward signals. Subsequent levels of backward signals (B, C, and so on) describe the status of the called party.

Table 123 on page 401 lists the frequency values used for forward and backward signals.

Table 123
MFC Frequency values (Part 1 of 2)

Digit	Forward direction DOD-Tx, DID-Rx	backward direction DOD-Rx, DID-Tx
1	1380 Hz + 1500 Hz	1140 Hz + 1020 Hz
2	1380 Hz + 1620 Hz	1140 Hz + 900 Hz
3	1500 Hz + 1620 Hz	1020 Hz + 900 Hz
4	1380 Hz + 1740 Hz	1140 Hz + 780 Hz
5	1500 Hz + 1740 Hz	1020 Hz + 780 Hz
6	1620 Hz + 1740 Hz	900 Hz + 780 Hz
7	1380 Hz + 1860 Hz	1140 Hz + 660 Hz
8	1500 Hz + 1860 Hz	1020 Hz + 660 Hz
9	1620 Hz + 1860 Hz	900 Hz + 660 Hz
10	1740 Hz + 1860 Hz	780 Hz + 660 Hz
11	1380 Hz + 1980 Hz	1140 Hz + 540 Hz
12	1500 Hz + 1980 Hz	1020 Hz + 540 Hz

Table 123
MFC Frequency values (Part 2 of 2)

13	1620 Hz + 1980 Hz	900 Hz + 540 Hz
14	1740 Hz + 1980 Hz	780 Hz + 540 Hz
15	1860 Hz + 1980 Hz	660 Hz + 540 Hz

The exact meaning of each MFC signal number (1-15) within each level can be programmed separately for each trunk route using MFC. This programming can be done by the customer and allows users to suit the needs of each MFC-equipped trunk route.

Each MFC-equipped trunk route is associated with a data block that contains the MFC signal functions supported for that route. Up to 127 such tables can be defined for an Option 11C system.

MFE signaling

The NT5K21 XMFC/MFE card can be programmed for MFE signaling which is used mainly in France. MFE is much the same as MFC except it has its own set of forward and backward signals.

Table 124 on page 403 lists the forward and backward frequencies for MFE. The one backward signal for MFE is referred to as the “control” frequency.

Table 124
MFE Frequency values

Digit	Forward direction OG-Tx, IC-Rx	Backward direction
1	700 Hz + 900 Hz	1900 Hz (Control Frequency)
2	700 Hz + 1100 Hz	—
3	900 Hz + 1100 Hz	—
4	700 Hz + 1300 Hz	—
5	900 Hz + 1300 Hz	—
6	1100 Hz + 1300 Hz	—
7	700 Hz + 1500 Hz	—
8	900 Hz + 1500 Hz	—
9	1100 Hz + 1500 Hz	—
10	1300 Hz + 1500 Hz	—

Sender and receiver mode

The XMFC/MFE circuit card provides the interface between the Option 11C CPU and the trunk circuit which uses MFC or MFE signaling.

The XMFC/MFE circuit card transmits and receives forward and backward signals simultaneously on two channels. Each channel is programmed like a peripheral circuit card unit, with its own sending and receiving timeslots in the Meridian network.

Receive mode

When in receive mode, the XMFC/MFE card is linked to the trunk card by a PCM speech path over the Meridian network cards. MFC signals coming in over the trunks are relayed to the XMFC/MFE card as though they were speech. The XMFC/MFC card interprets each tone pair and sends the information to the CPU through the CPU bus.

Send mode

When in send mode, the CPU sends data to the XMFC/MFE card through the CPU bus. The CPU tells the XMFC/MFE card which tone pairs to send and the XMFC/MFE card generates the required tones and sends them to the trunk over the PCM network speech path. The trunk transmits the tones to the far end.

XMFC sender and receiver specifications

Tables 125 and Table 126 provide the operating requirements for the NT5K21 XMFC/MFE card. These specifications conform to CCITT R2 recommendations: Q.441, Q.442, Q.451, Q.454, and Q.455.

Table 125
XMFC sender specifications

Forward frequencies in DOD mode:	1380, 1500, 1620, 1740, 1860, 1980 Hz
Backward frequencies in DOD mode:	1140, 1020, 900, 780, 660, 540 Hz
Frequency tolerance:	+/- 0.5 Hz from nominal
Power level at each frequency:	Selectable: 1 of 16 levels
Level difference between frequencies:	< 0.5 dB
Harmonic Distortion and Intermodulation	37 dB below level of 1 signaling frequency
Time interval between start of 2 tones:	125 usec.
Time interval between stop of 2 tones:	125 usec.

Table 126
XMFC receiver specifications

Input sensitivity:		
accepted:	-5 to -31.5 dBmO	New CCITT spec.
rejected:	-38.5 dBmO	Blue Book
Bandwidth twist:		
accepted:	fc +/- 10 Hz	
rejected:	fc +/- 60 Hz	
Amplitude twist:		
accepted:	difference of 5 dB between adjacent frequencies difference of 7 dB between non-adjacent frequencies	
Norwegian requirement	difference of 12 dB (for unloaded CO trunks)	
rejected:	difference of 20 dB between any two frequencies	
Operating time:	< 32 msec.	
Release time:	< 32 msec.	
Tone Interrupt no release:	< 8 msec.	Receiver on, while tone missing
Longest Input tone ignored:	< 8 msec.	Combination of valid frequencies
Noise rejection:	S/N > 18 dB S/N > 13 dB	No degradation, in band white noise Out-of-band disturbances for CCITT

XMFE sender and receiver specifications

Tables 127 and Table 128 provide the operating requirements for the XMFC/MFE card when it is configured as an XMFE card. These requirements conform to French Socotel specifications ST/PAA/CLC/CER/692.

Table 127
XMFE sender specifications

Forward frequencies in OG mode:	700, 900, 1100, 1300, 1500 Hz
Forward frequencies in IC mode:	1900 Hz
Frequency tolerance:	+/- 0.25% from nominal
Power level at each frequency:	Selectable: 1 of 16 levels
Level tolerance:	+/- 1.0 dB
Harmonic Distortion and Intermodulation:	35 dB below level of 1 signaling frequency
Time interval between start of 2 tones:	125 usec.
Time interval between stop of 2 tones:	125 usec.

Table 128
XMFE receiver specifications (Part 1 of 2)

Input sensitivity:	
accepted:	-4 dBm to -35 dBm +/- 10 Hz of nominal
rejected:	-42 dBm signals
rejected:	-4 dBm outside 500-1900 Hz
rejected:	-40 dBm single/multiple sine wave in 500-1900 Hz
Bandwidth:	
accepted:	fc +/- 20 Hz
Amplitude twist:	
accepted:	difference of 9 dB between frequency pair
Operating time:	< 64 msec.
Release time:	< 64 msec.
Tone Interrupt causing no release:	< 8 msec. Receiver on, tone missing

Table 128
XMFE receiver specifications (Part 2 of 2)

Longest Input tone ignored:	< 8 msec.	Combination of valid frequencies
Longest control tone ignored:	< 15 msec.	Control Frequency only
Noise rejection:	S/N > 18 dB	No degradation in-band white noise

Physical specifications

The following Table 129 outlines the physical specifications of the NT5K21 XMFC/MFE circuit card.

Table 129
Physical specifications

Dimensions	Height:12.5 in. (320 mm) Depth:10.0 in. (255 mm) Thickness:7/8 in. (22.25 mm)
Faceplate LED	Lit when the circuit card is disabled
Cabinet Location	Must be placed in the main cabinet (Slots 1-10)
Power requirements	1.1 Amps typical
Environmental considerations	Meets the environment of Meridian 1 systems

Chapter 23 — NTAG26 XMFR card

Contents

This section contains information on the following topics:

Overview	409
MF signaling	409
Signaling levels	410
XMFR receiver specifications	411
Physical specifications	413

Overview

The XMFR (Extended Multi-frequency receiver) card is used to receive MF digit information. Connections are made between a PBX and a CO. The XMFR card can only operate in systems using μ -law companding.

MF signaling

The MF feature allows the Option 11C system to receive digits for 911 or feature group D applications.

Signaling levels

MF signaling uses pairs of frequencies to represent digits.

The following table lists the frequency values used for received signals.

Table 130
MF frequency values

Digit	Backward direction DOD-Tx, DID-Rx
1	700 Hz + 900 Hz
2	700 HZ + 1100 Hz
3	900 Hz + 1100 Hz
4	700 Hz + 1300 Hz
5	900 Hz + 1300 Hz
6	1100 Hz + 1300 Hz
7	700 Hz + 1500 Hz
8	900 Hz +1500 Hz
9	1100 Hz + 1500 Hz
0	1300 Hz + 1500 Hz
KP	1100 Hz + 1700 Hz
ST	1500 Hz + 1700 Hz
STP(ST')	900 Hz + 1700 Hz
ST2P(ST'')	1300 Hz + 1700 Hz
ST3P(ST''')	700 Hz + 1700 Hz

XMFR receiver specifications

Table 131 provides the operating requirements for the NTAG26 circuit card.

Table 131
XMFR receiver specifications (Part 1 of 3)

Coding:	Mu-Law
Input sensitivity:	must accept: 0 to -25 dBmO must reject: -35 to dBmO
Frequency sensitivity:	must accept: $f \pm (1.5\% + 5\text{Hz})$
Amplitude Twist:	must accept: difference of 6dB between frequencies
Signal Duration:	must accept: > 30 ms must reject: < 10 ms
KP Signal Duration:	must accept: > 55 ms may accept: > 30 ms must reject: < 10 ms
Signal Interruption Bridge:	must ignore: < 10 ms
Time Shift between 2 frequencies: (Envelop for start/stop)	must accept: < 4 ms

Table 131
XMFR receiver specifications (Part 2 of 3)

Coincidence between 2 frequencies:	must reject: < 10 ms
Intersignal Pause:	must accept: > 25 ms
Maximum Dialling Speed:	must accept: 10 signals per second
Noise Rejection: Error Rate in White Noise	Better than: < 1/2500 calls Test: 10 digit calls nominal frequency @ -23 dBmO ON/OFF = 50 ms/50ms KP duration 100 ms SNR = -20 dB all digits
Immunity to Impulse Noise	Better than: < 1/2500 calls Test: 10 digit calls nominal frequency @ -23 dBmO ON/OFF = 50ms/50ms KP duration 100 ms SNR = -12 dBs all digits ATT Digit Simulation Test, Tape #201 from PUB 56201
Error Rate from Power Lines	Better than: < 1/2500 calls Test: 10 digit calls nominal frequency @ -23 dBmO ON/OFF = 50 ms/50ms KP duration 100 ms 60 Hz signal @ 81 dBrc0 (-9dBm) or 180 Hz signal @ 68 dBrc0 (-22dBm) all digits

Table 131
XMFR receiver specifications (Part 3 of 3)

Tolerate Intermodulation:	Must tolerate @A-B and @B-A modulation products with a power sum 28 dB below each frequency component level of the signals.
KP: KP activation	The receiver must not respond to signals prior to KP. Remain unlocked until ST, STP, ST2P or ST3P is received.
Multiple KP's	After the initial KP, subsequent KP's are ignored while in unlocked mode.
Excessive Components:	If more than two valid frequencies are detected, no digit is reported to the SL-1 CPU.

The XMFR receiver specifications conform to the following:

- TR-NPL-000258, Compatibility Information for F.G.D. switched access service, Bell Communication Research Technical Reference, Issue 1.0, October 1985.
- TR-NPL-000275, Notes on the BOC Intra-LATA Networks, Bell Communication Research Technical Reference, Chapter 6, 1986.

Physical specifications

The physical specifications required by the NTAG26 XMFR circuit card are shown in Table 132:

Table 132
Physical specifications

Dimensions	Height: 12.5 in. (320 mm) Depth: 10.0 in. (255 mm) Thickness: 7/8 in. (22.25 mm)
Faceplate LED	Lit when the circuit card is disabled
Power requirements	1.1 Amps typical
Environmental considerations	Meets the environment of Meridian 1 systems

Chapter 24 — NT6D70 SILC line card

Contents

This section contains information on the following topics:

Reference List	415
Overview	415
Functional description	416
Micro Controller Unit (MCU)	417
IPE interface logic	417
S/T interface logic	418
Physical description	418
Power consumption	418
Foreign and surge voltage protections	418

Reference List

The following are the references in this section:

- *Option 11C ISDN BRI Hardware Installation and Maintenance (553-3011-311)*

Overview

The S/T Interface Line Cards (SILC) (NT6D70AA-48V North America, NT6D70 BA -40 V International) provide eight S/T four-wire full duplex interfaces that are used to connect ISDN BRI compatible terminals over DSLs to the Meridian 1 system. A description of the ISDN BRI feature is contained in *Option 11C ISDN BRI Hardware Installation and Maintenance (553-3011-311)*.

Functional description

The SILC provides eight S/T four wire full duplex polarity sensitive interfaces that are used to connect ISDN BRI compatible terminals over Digital Subscriber Loops (DSL) to the Meridian 1. Each S/T interface provides two B-channels and one D-channel and supports a maximum of eight physical connections that can link up to 20 logical terminals on one DSL.

A logical terminal is any terminal that can communicate with the Meridian 1 over a DSL. It may be directly connected to the DSL through its own physical termination or be indirectly connected through a common physical termination.

The length of a DSL depends on the specific terminal configuration and the DSL wire gauge, however, it should not exceed 1 km (3,280 ft).

The SILC interface uses a 4 conductor cable that provides a differential Transmit and Receive pair for each DSL. The SILC has options to provide a total of 2 Watts of power on the Transmit or Receive leads, or no power at all. When this power is supplied from the S/T interface, the terminal devices must not draw more than the 2 Watts of power. Any power requirements beyond this limit must be locally powered.

Other functions of the SILC are:

- support point-to-point and multi-point DSL terminal connections
- execute instructions received from the MISP to configure and control the S/T interfaces
- provide channel mapping between ISDN BRI format (2B+D) and Meridian 1 system bus format
- multiplexes 4 D-channels onto one timeslot
- perform activation and deactivation of DSLs
- provide loopback control of DSLs
- provide a reference clock to the clock controller

Micro Controller Unit (MCU)

The MCU coordinates and controls the operation of the SILC. It has internal memory, a reset and sanity timer, and a serial control interface.

The memory consists of 32 K of EPROM which contains the SILC operating program and 8 K of RAM used to store interface selection and other functions connected with call activities.

The reset and sanity timer logic resets the MCU.

The serial control interface is an IPE bus used by the MPU to communicate with the S/T transceivers.

IPE interface logic

The IPE interface logic consists of a Card-LAN interface, an IPE bus interface, a maintenance signaling channel interface, a digital pad, and a clock controller and converter.

The Card-LAN interface is used for routine card maintenance, which includes polling the line cards to find in which card slot the SILC is installed. It also queries the status and identification of the card, and reports the configuration data and firmware version of the card.

The IPE bus interface connects one IPE bus loop that has 32 channels operating at 64 kbps and one additional validation and signaling bit.

The maintenance signaling channel (MSC) interface is used to communicate signaling and card identification information from the Meridian 1 CPU to the SILC MCU. The signaling information also contains maintenance instructions.

The digital pad provides gain or attenuation values to condition the level of the digitized transmission signal according to the network loss plan. This sets transmission levels for the B-channel circuit-switched voice calls.

The clock recovery circuit recovers the clock from the local exchange.

The clock converter converts the 5.12 MHz clock from the IPE backplane into a 2.56 MHz clock to time the IPE bus channels and an 8 kHz clock to provide PCM framing bits.

S/T interface logic

The S/T interface logic consists of a transceiver circuit and the DSL power source. This interface supports DSLs of different distances and different number and types of terminals.

The transceiver circuits provide four-wire full duplex S/T bus interface. This bus supports multiple physical terminations on one DSL where each physical termination supports multiple logical B-channel and D-channel ISDN BRI terminals. Idle circuit-switched B-channels can be allocated for voice or data transmission to terminals making calls on a DSL. When those terminals become idle, the channels are automatically made available to other terminals making calls on the same DSL.

The power on the DSL comes from the SILC, which accepts -48 V from the IPE backplane and provides 2 watts of power to physical terminations on each DSL. It provides -48 V for ANSI compliant ISDN BRI terminals and -40 V for CCITT (such as ETSI NET-3, INS NET-64) compliant terminals. The total power used by the terminals on each DSL must not exceed 2 watts.

Physical description

The NT6D70 SILC is a standard size circuit card designed to be inserted in peripheral equipment slots in the Meridian 1. Its faceplate is equipped with an LED to indicate its status.

Power consumption

Power consumption is +5V at 800 mA and -48V at 480 mA.

Foreign and surge voltage protections

In-circuit protection against power line crosses or lightning is not provided on the SILC card. When the SILC card is used in TIE trunk applications in which the cabling is exposed to outside plant conditions, an NT1 module certified for such applications must be used. Check local regulations before providing such service.

Chapter 25 — NT6D71 UILC line card

Contents

This section contains information on the following topics:

Reference List	419
Overview	419
Functional description	420
Micro Controller Unit (MCU)	420
IPE interface logic	420
U interface logic	421
Physical description	421
Power consumption	421

Reference List

The following are the references in this section:

- *Option 11C ISDN BRI Hardware Installation and Maintenance (553-3011-311)*

Overview

The NT6D71 U Interface Line Card (UILC) supports the OSI physical layer (layer 1) protocol. The UILC is an ANSI defined standard interface. The UILC provides eight two-wire full duplex (not polarity sensitive) U interfaces that are used to connect ISDN BRI compatible terminals over DSLs to the Meridian 1. A description of the ISDN BRI feature is contained in *Option 11C ISDN BRI Hardware Installation and Maintenance (553-3011-311)*.

Functional description

Each U interface provides two B-channels and one D-Channel and supports one physical termination. This termination may be to a Network Termination (NT1) or directly to a single U interface terminal. Normally this physical termination is to an NT1, which provides an S/T interface that allows up to 8 physical terminals to be connected. The length of a DSL depends on the specific terminal configuration and the DSL wire gauge, however, it should not exceed 5.5 km (3.3 mi).

The main functions of the UILC are:

- provide eight ISDN U interfaces conforming to ANSI standards
- support point-to-point DSL terminal connections
- provide channel mapping between ISDN BRI format (2B+D) and Meridian 1 bus format
- multiplex 4 D-channels onto one timeslot
- perform activation and deactivation of DSLs
- provide loopback control of DSLs

Micro Controller Unit (MCU)

The MCU coordinates and controls the operation of the UILC. It has internal memory, a reset and sanity timer, a serial control interface, a maintenance signaling channel, and a digital pad.

The memory consists of 32 K of EPROM that contains the UILC operating program and 8 K of RAM used to store interface selection and other functions connected with call activities.

The reset and sanity timer logic resets the MCU.

The serial control interface is an IPE bus used to communicate with the U transceivers.

IPE interface logic

The IPE interface logic consists of a Card-LAN interface, an IPE bus interface, a maintenance signaling channel interface, a digital pad, and a clock converter.

The CardLAN interface is used for routine card maintenance, which includes polling the line cards to find in which card slot the UILC is installed. It also queries the status and identification of the card, and reports the configuration data and firmware version of the card.

The IPE bus interface connects one IPE bus loop that has 32 channels operating at 64 kbps and one additional validation and signaling bit.

The Maintenance Signaling Channel (MSC) interface is used to communicate signaling and card identification information from the Meridian 1 CPU to the UILC MCU. The signaling information also contains maintenance instructions.

The digital pad provides gain or attenuation values to condition the level of the digitized transmission signal according to the network loss plan. This sets transmission levels for the B-channel circuit-switched voice calls.

The clock converter converts the 5.12 MHz clock from the IPE backplane into a 2.56 MHz clock to time the IPE bus channels and an 8 kHz clock to provide PCM framing bits.

U interface logic

The U interface logic consists of a transceiver circuit. It provides loop termination and high voltage protection to eliminate the external hazards on the DSL. The U interface supports circuit-switched voice and data terminals, D-channel packet data terminals, and NT1s. A UILC has eight transceivers to support eight DSLs for point-to-point operation.

Physical description

The NT6D71 UILC is a standard size circuit card designed to be inserted in peripheral equipment slots in the Meridian 1. Its faceplate is equipped with an LED to indicate its status.

Power consumption

Power consumption is +5V at 1900 mA.

Chapter 26 — NT1R20 Off Premise Station (OPS) analog line card

Contents

This section contains information on the following topics:

Reference List	423
Overview	424
Physical description	424
Self Test	424
Functional description	424
Card interfaces	425
Card functions	426
Operation	429
Incoming calls	429
Outgoing calls	431
Application	432
Off-premise station application	432
Other applications	434
Transmission considerations	434

Reference List

The following are the references in this section:

- *Option 11C Planning and Installation* (553-3021-210)
- *Maintenance* (553-3001-511)

Overview

The NT1R20 Off-Premise Station (OPS) Analog Line Card is an intelligent peripheral equipment (IPE) device that can be installed in any IPE slot in the main or expansion cabinets. The OPS analog line card connects eight analog telephone lines to the Option 11C with secondary hazard and surge protection.

Each unit is independently configured in software in the Single-line Telephone Administration program (LD 10).

Physical description

The OPS card measures 31.75 by 25.40 cm (12.5 by 10 in.) It connects to the IPE backplane through a 160-pin connector shroud. A 25-pair amphenol connector below the card is cabled to the cross connect terminal. Telephone lines from station equipment cross connect to the OPS analog line card at the cross connect using a wiring plan similar to trunk cards. (See the *Option 11C Planning and Installation* (553-3021-210) for cross connect terminations).

Self Test

The faceplate of the card is equipped with a red, light-emitting diode (LED). When an OPS analog line card is installed, the LED remains lit for two to five seconds while the self-test runs. If the self-test completes successfully, the LED flashes (off/on) three times and remains lit until the card is configured and enabled in software, then the LED goes out.

Functional description

This functional description of the NT1R20 Off-Premise Station Analog Line Card is divided into two parts. First, a description of the card's control, signaling, and power interfaces is given, followed by a description of how the card itself functions.

Card interfaces

Voice and signaling interfaces

The eight line interfaces provided by the OPS analog line card connect to conventional, 2-wire (tip and ring), analog line facilities. Incoming analog voice and signaling information from a line facility is converted by the OPS analog line card to digital form and routed to the CPU over DS-30 network loops. Conversely, digital voice and signaling information from the CPU is sent over DS-30 network loops to the OPS analog line card where it is converted to analog form and applied to the line facility.

The OPS analog line card uses only eight of the 30 available timeslots for its eight line interfaces. The OPS analog line card can be configured in software to format PCM data in the μ -law or A-law conventions.

Maintenance communications

Maintenance communications is the exchange of control and status data between line or trunk cards and the CPU. Maintenance data is transported via the card LAN link.

The card LAN link supports the following functions on the OPS analog line card:

- polling
- reporting of self-test status
- CPU initiated card reset
- reporting of card ID (card type and hardware vintage)
- reporting of firmware version
- reporting of line interface unit configuration
- enabling/disabling of the DS-30X network loop busy
- reporting of card status

Power interface

Power is provided to the OPS circuit card by the NTAK78 AC/DC or NTAK72 DC power supply.

Card functions

The following card functions are described in this section:

- Line interface units
- Card control functions
- Circuit power
- Software service changes
- Port-to-port loss configuration

Line interface units

The OPS analog line card contains eight independently configurable units. Relays are provided in each unit to apply ringing onto the line. Signal detection circuits monitor on-hook/off-hook signaling. Two codecs are provided for performing A/D and D/A conversion of analog voiceband signals to digital PCM signals.

Each codec supports four units and contains switchable pads for control of transmission loss on a per unit basis. The following features are common to all units on the card:

- OPS or ONS service configurable on a per unit basis
- terminating impedance (600 or 900 ohm) selectable on a per unit basis
- standard or complex balance impedance (600 or 900 ohm, 3COM1 or 3COM2) selectable on a per unit basis
- loopback of PCM signals over DS-30X network loop for diagnostic purposes

Card control functions

Control functions are provided by a microcontroller, a card LAN interface, and signaling and control circuits on the OPS analog line card.

Microcontroller—The microcontroller controls the following:

- reporting to the CPU via the card LAN link:
 - card identification (card type, vintage, and serial number)
 - firmware version

- self-test status
- programmed configuration status
- receipt and implementation of card configuration:
 - of the codecs
 - enabling/disabling of individual units or entire card
 - programming of input/output interface control circuits for administration of line interface unit operation
 - maintenance diagnostics
 - transmission loss levels

Signaling and control—This portion of the card provides circuits that establish, supervise, and take down call connections. These circuits work with the system CPU to operate line interface circuits during calls. The circuits receive outgoing call signaling messages from the CPU and return incoming call status information over the DS-30X network loop.

Circuit Power

The +8.5 V dc input is regulated down to + 5 V dc for use by the digital logic circuits. All other power to the card is used by the line interface circuits.

Foreign and surge voltage protection

The OPS analog line card meets UL-1489 and CS03 over-voltage (power cross) specifications and FCC Part 68 requirements for hazardous and surge voltage limits.

Software service changes

Individual line interface units on the OPS analog line card are configured to either OPS (for OPS application) or ONS (for ONS application) class-of-service (CLS) in the Single-line Telephone Administration program (LD10) (see Table 133). LD10 is also used to select unit terminating impedance and balance network impedance at the TIMP and BIMP prompts, respectively. See the *Maintenance* (553-3001-511) for LD 10 service change instructions.

Port-to-port loss configuration

The loss plan for the OPS analog line card determines port-to-port loss for connections between an OPS analog line card unit (port) and other Meridian 1 PE or IPE ports.

The transmission properties of each line unit are characterized by the OPS or ONS class-of-service assigned in the Single-line Telephone Administration program (LD10).

Table 133
OPS analog line card configuration

Application	On-premise station (ONS)			Off-premise station (OPS)												
Class of service	ONS			OPS												
Loop resistance	0 - 460 ohm			0 - 2300 ohm												
Jumper strap setting ^b	Both JX. 0 and JX 1 off			Both JX. 0 and JX. 1 off		Both JX. 0 and JX. 1 on										
Loop loss dB ^c	0-1.5	>1.5-2.5	>2.5-3.0	0-1.5	>1.5-2.5	>2.5-4.5	>4.5-15									
TIMP	600 ohm	600 ohm	600 ohm	600 ohm	600 ohm	600 ohm	600 ohm									
BIMP	600 ohm	3COM	3CM2	600 ohm	3COM	3CM2	3CM2									
Gain treatment ^e	No						Yes									
<p>a. Configured in the Single line Telephone Administration program (LD 10).</p> <p>b. Jumper strap settings JX 0 and JX. 1 apply to all eight units; "X" indicates the unit number, 0-7. "OFF" indicates that a jumper strap is not installed across both pins on a jumper block. Store unused straps on the OPS analog line card by installing them on a single jumper pin.</p> <p>c. Loss of untreated (no gain devices) metallic line facility. Upper loss limits correspond to loop resistance ranges for 26 AWG wire.</p> <p>d. Default software impedance settings are:</p> <table style="margin-left: 40px;"> <tr> <td></td> <td><u>ONS CLS</u></td> <td><u>OPS CLS</u></td> </tr> <tr> <td>TIMP:</td> <td>600 ohm</td> <td>600 ohm</td> </tr> <tr> <td>BIMP:</td> <td>600 ohm</td> <td>3COM2</td> </tr> </table> <p>e. Gain treatment, such as a voice frequency repeater (VFR) is required to limit the actual OPS loop loss to 4.5 dB, maximum. VFR treatment of metallic loops having untreated loss greater than 15dB (equivalent to a maximum signaling range of 2300 ohm on 26 AWG wire) is not recommended.</p>									<u>ONS CLS</u>	<u>OPS CLS</u>	TIMP:	600 ohm	600 ohm	BIMP:	600 ohm	3COM2
	<u>ONS CLS</u>	<u>OPS CLS</u>														
TIMP:	600 ohm	600 ohm														
BIMP:	600 ohm	3COM2														

Operation





The applications, features, and signaling arrangements for each unit on the OPS analog line card are assigned through the Single-line Telephone Administration program (LD10) and/or jumper strap settings on the card.

The operation of each unit is configured in software and is implemented in the card through software download messages. When the OPS analog line card unit is idle, it provides a ground on the tip lead and -48 V dc on the ring lead. The on-hook telephone presents a high impedance toward the line interface unit on the card.

Incoming calls

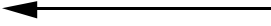
Incoming calls to a telephone connected to the OPS analog line card originate from stations that can be local (served by the Meridian 1 PBX) or remote (served through the public switched telephone network). The alerting signal to telephones is 20 Hz (nominal) ringing. When an incoming call is answered, ringing is tripped as the telephone goes off-hook, placing a low-resistance DC loop across the tip and ring leads towards the OPS analog line card (see Table 134 on page 430).

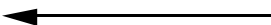





Table 134
Call connection sequence—near-end station receiving call

State	Signal/Direction Far-endNear-end	Remarks
<p>Line card unit idle</p> <p>Incoming call</p> <p>Near-end station off-hook</p> <p>Two-way voice connection</p>	<p>Group on tip, battery on ring High resistance loop</p> <p>Ringing</p>  <p>Low resistance loop</p>  <p>Two-way voice connection</p> 	<p>No battery current drawn.</p> <p>Far-end station goes off-hook and addresses (dials-up) the near-end station. The Option 11C receives the incoming call on a trunk and determines the TN.</p> <p>Option 11C applies 20 Hz ringing to ring lead.</p> <p>Option 11C detects increase in loop current, tips ringing, and puts call through to near-end station.</p>
<p>Near end station hangs up first</p> <p>Line card unit idle</p>	<p>High-resistance loop</p>  <p>Group on tip, battery on ring High resistance loop</p>	<p>If near end station hangs-up first, the line card detects the drop in loop current.</p> <p>Line card unit is ready for the next call.</p>
<p>Far end station hangs up first</p> <p>Line card unit idle</p>	<p>High resistance loop</p>  <p>Ground on tip/battery on ring High resistance loop</p>	<p>If the far-end hangs-up first, Option 11C detects disconnect signalling from the trunk. The person at the near-end recognizes the end of the call and hangs-up.</p> <p>Line card unit is ready for the next call.</p>

Outgoing calls

For outgoing calls from a telephone, a line unit is seized when the telephone goes off-hook, placing a low-resistance loop across the tip and ring leads towards the OPS analog line card (see Table 135 on page 431). When the card detects the low-resistance loop, it prepares to receive digits. When the Meridian 1 is ready to receive digits, it returns dial tone. Outward address signaling is then applied from the telephone in the form of loop (interrupting) dial pulses or DTMF tones.

Table 135
Call connection sequence—near-end station receiving call (Part 1 of 2)

State	Signal/Direction Far-endNear-end	Remarks
Line card unit idle	Group on tip, battery on ring High resistance loop	No battery current drawn.
Call request	Low resistance loop 	Near-end station goes off-hook. Battery current is drawn, causing detection of off-hook state.
Outpulsing	Dial Tone 	Dial tone is applied to the near end station from the Option 11C.
	Addressing signals 	Near-end station dials number (loop pulsing or DTMF tones).
	Ringback (or busy) 	Option 11C detects start of dialing and removes dial tone Option 11C decodes addressing, routes call, and supplies ringback tone to near-end station if far-end is on-hook. (Busy tone is supplied if far-end is off-hook).
Two-way voice connection		When call is answered, ringback tone is removed, and call is put through to far-end station.
Near-end station hangs-up first	High resistance loop 	If near end station hangs-up first, the line card detects the drop in loop current.
Line card unit idle	Group on tip, battery on ring High resistance loop	Line card unit is ready for the next call.

Call connection sequence—near-end station receiving call (Part 2 of 2)

Far end station hangs up first	High resistance loop 	If the far-end hangs-up first, Option 11C detects disconnect signalling from the trunk. The person at the near-end recognizes the end of the call and hangs-up.
Line card unit idle	Ground on tip/battery on ring High resistance loop	Line card unit is ready for the next call.

Application

Off-premise station application

The NT1R20 Off-Premise Station (OPS) Analog Line Card is designed primarily to provide an interface for Meridian 1 off-premise station lines. An OPS line serves a terminal—typically, but not exclusively, a telephone set—remote from the PBX either within the same serving area as the local office or through a distant office. The line is not switched at these offices; however, depending on the facilities used, the local office serving the OPS station may provide line functions such as battery and ringing. Facilities are generally provided by the local exchange carrier (usually, OPS pairs are in the same cable as the PBX-CO trunks). The traditional OPS scenario configuration is shown in Figure 56.

Figure 56
Traditional OPS application configuration

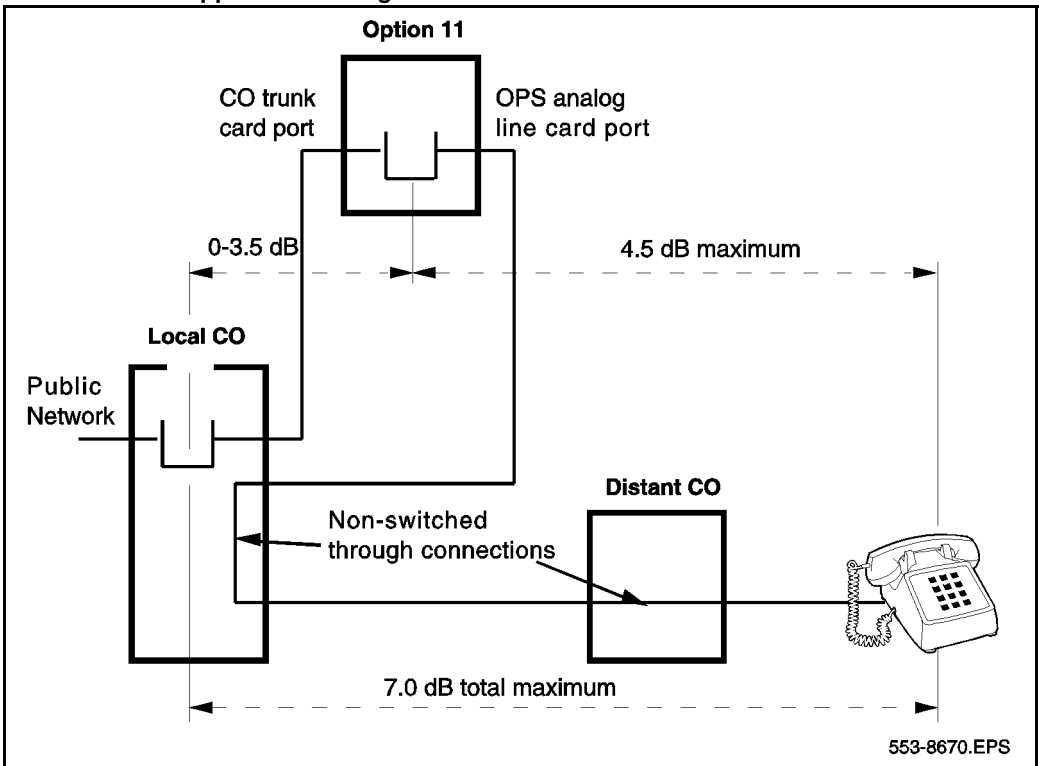

Note: OPS service should not be confused with off-premise extension (OPS) service. OPS service is the provision of an extension to a main subscriber loop bridged onto the loop at the serving CO or PBX. Additionally, OPS as used to denote off-premise extension service should not be confused with the OPS class-of-service assigned in the Single-line Telephone Administration program (LD10).

Other applications

The operating range and built-in protection provisions of the OPS analog line card make it suitable for applications which are variants on the traditional configuration shown in Figure 56. Examples of such applications are:

- a PBX in a central building serving stations in other buildings in the vicinity, such as in an industrial park, often called a campus environment. Facilities may be provided by the local exchange carrier or may be privately owned. Protection may or may not be a requirement.
- Termination to other than a telephone set, such as to a key telephone system.
- Individual circuits on the OPS analog line card may also be configured as ONS ports in LD10:
 - to have ONS service with hazardous and surge voltage protection (not available on other Meridian 1 analog line cards).
 - to use otherwise idle OPS analog line card ports.

Transmission considerations

The transmission performance of OPS lines is dependent on a number of factors.

- The Meridian 1 port-to-port loss for connections between OPS ports and other Meridian 1 ports.
- The transmission parameters of the facilities between the Meridian 1 OPS port and the off-premise station or termination.
- The electrical and acoustic transmission characteristics of the termination.

These factors must be considered when planning applications using the OPS analog line card. They are of particular importance when considering configurations other than the traditional OPS application as shown in Figure 56. The discussion which follows is intended to provide basic transmission planning guidelines for various OPS applications.

Port-to-port loss

Loss is inserted between OPS analog line card ports and other Meridian 1 ports in accordance with the Meridian 1 loss plan. This plan determines the port-to-port loss for each call. When a port is configured for OPS class-of-service, loss is programmed into the OPS analog line card on a call-by-call basis. When configured for ONS class-of-service, an OPS analog line card port is programmed to a value that is fixed for all calls, although the loss in the other port involved in the call may vary on a call-by-call basis to achieve the total loss scheduled by the plan.

For satisfactory transmission performance, particularly on connections between the public network and an OPS termination, it is recommended that facilities conform to the following:

- Total 1 kHz loss from the local serving CO to the OPS terminal should not exceed 7.0 dB. Of that total, the loss in the facility between the PBX and the terminal should not exceed 4.5 dB (see Figure 56).

The following requirements are based on historic inserted connection loss (ICL) objectives:

- PBX–CO trunk: 5 dB with gain; 0–4.0 dB without gain
- OPS line: 4.0 dB with gain; 0–4.5 dB without gain

In recent times, economic and technological consideration has led to modifications of these historic objectives. However, the loss provisions in the PBX for OPS are constrained by regulatory requirements as well as industry standards; thus, they are not designed to compensate for modified ICL designs in the connecting facilities.

- The attenuation distortion (frequency response) of the OPS facility should be within ± 3.0 dB over the frequency range from 300 to 3000 Hz. It is desirable that this bandwidth extend from 200 to 3200 Hz.
- The terminating impedance of the facility at the OPS port should approximate that of 600 ohm cable.

If the OPS line facility loss is greater than 4.5 dB but does not exceed 15 dB, line treatment using a switched-gain voice frequency repeater (VFR) will extend the voice range.

The overall range achievable on an OPS line facility is limited by the signaling range (2300 ohm loop including telephone set resistance). Signaling range is unaffected by gain treatment; thus, gain treatment can be used to extend the voice range to the limit of the signaling range. For example, on 26 AWG wire, the signaling range of 2300 ohms corresponds to an untreated metallic loop loss of 15 dB. Gain treatment (such as a VFR) with 10.5 dB of gain would maintain the OPS service loss objective of 4.5 dB while extending the voice range to the full limit of the signaling range:

- 15 dB (loss corresponding to the maximum signaling range)
- – 4.5 dB (OPS service loss objective)
- = 10.5 dB (required gain treatment)

The use of dial long line units to extend signaling range of OPS analog line cards beyond 15 dB is not recommended.

Termination transmission characteristics

The loss plan for OPS connections is designed so that a connection with an OPS termination will provide satisfactory end-to-end listener volume when the OPS termination is a standard telephone set. The listener volume at the distant end depends on the OPS termination transmit loudness characteristics; that at the OPS termination end depends on the OPS termination receive loudness characteristics. With standard telephone sets, these characteristics are such that satisfactory—if not optimum—performance is achievable within the above noted objectives for connecting facilities.

A feature of many (though not all) standard telephone sets is that the loudness increases with decreased current. Thus, as the line (Meridian 1 to OPS termination) facility gets longer and loss increases, the increased loudness of the set somewhat compensates for the higher loss, assuming direct current feed from the PBX with constant voltage at the feeding bridge. However, this compensation is not available when:

- the termination is a non-compensating telephone set
- the OPS port is served by a line card using a constant-current feeding bridge
- the OPS termination is to telephone sets behind a local switch providing local current feed, such as a key telephone system

OPS line terminations with loudness characteristics designed for other applications may also impact transmission performance. For example, wireless portables loudness characteristics are selected for connections to switching systems for wireless communication systems; if deployed in an OPS arrangement without due consideration for these characteristics, the result could be a significant deviation from optimum loudness performance.

Chapter 27 — Cable specifications and interfaces

Contents

This section contains information on the following topics:

Overview	439
Option 11C fiber optic cable interfaces	440
Fiber Expansion daughterboards	440
Fiber Receiver cards	442
Expansion Daughterboards for IP connectivity	443
Fiber Optic cable	443
IP connector cables	446
Environment	446

This chapter describes the fiber optic cable interface equipment used with the Option 11C.

Overview

Through the use of fiber optic cable and fiber optic cable interfaces, the expansion cabinets may be located at various distances from the main cabinet. With Option 11C, the expansion cabinets can be located up to 3 km (1.8 mi) from the main cabinet.

With the use of Dual Port Fiber Expansion Daughterboards, up to four expansion cabinets can be supported with Option 11C. These Dual Port Fiber Expansion Daughterboards are also available in two versions for local and IP Expansion configurations.

Note 1: The distance between cabinets is determined by the length of the fiber optic cable.

Note 2: The fiber optic cable interface equipment used with Option 11E is unique to that system, and cannot be used with Option 11C. Similarly, the fiber optic cable interface used with Option 11C cannot be used with Option 11E.

Note 3: With 100baseF Expansion Daughterboards and third party converters, the distance can be extended to more than 20km.

Option 11C fiber optic cable interfaces

Fiber optic interface hardware used with Option 11C consists of Fiber Expansion daughterboards mounted on the NTDK20 small system controller card in the main cabinet and Fiber Receiver cards mounted in the expansion cabinets.

Note 1: Any reference to Option 11C cabinets in this section equally applies to Option 11C Mini chassis if you are using them in your IP Expansion system.

Note 2: The MFI and EFI units used with Option 11E to interface with fiber optic cable cannot be used with Option 11C.

Fiber Expansion daughterboards

Fiber Expansion daughterboards mounted on the NTDK20 SSC card allow the connection of fiber optic cables from the main cabinet to expansion cabinets in multi cabinet Option 11C systems. Each daughterboard also provides an additional 16-channel conference loop and one SDI port at the expansion cabinet. There are five types:

- The NTDK22 Fiber Expansion Daughterboard
- The NTDK24 Fiber Expansion Daughterboard
- The NTDK79 Fiber Expansion Daughterboard
- The NTDK84 Fiber Expansion Daughterboard
- The NTDK85 Fiber Expansion Daughterboard

NTDK22 Fiber Expansion Daughterboard

The NTDK22 Fiber Expansion Daughterboard is used when the expansion cabinet is within 10 m (33 ft) of the main cabinet. It connects to one A0632902 Fiber Optic cable (multimode).

One of these boards is required for each expansion cabinet located within 10 m (33 ft) of the main cabinet.

NTDK24 Fiber Expansion Daughterboard

The NTDK24 Fiber Expansion Daughterboard is used when the expansion cabinet is up to 3 km (1.8 mi) of the main cabinet. It connects to one glass multimode fiber optic cable which is dedicated to the Option 11C system. One of these boards is required for each expansion cabinet located up to 3 km (1.8 mi) of the main cabinet. The NTDK24 Fiber Expansion Daughterboard works in conjunction with an NTDK25 Fiber Receiver card in the expansion cabinet.

Note: The NTDK24 supports only Multimode glass fiber optic cable.

NTDK79 Fiber Expansion Daughterboard

The NTDK79 Fiber Expansion Daughterboard has the same features as the NTDK24 except that:

- it requires Single Mode glass fiber optic cable
- it works in conjunction with an NTDK80 Fiber Receiver card in the expansion cabinet instead of an NTDK25 card.

Note: The NTDK79 supports only Single Mode glass fiber optic cable.

NTDK84 Fiber Expansion Daughterboard

The NTDK84 Fiber Expansion Daughterboard has the same features as the NTDK22 except that it can interface with two expansion cabinets.

NTDK85 Fiber Expansion Daughterboard

The NTDK85 Fiber Expansion Daughterboard has the same features as the NTDK24 except that it can interface with two expansion cabinets.

Fiber Receiver cards

Fiber Receiver cards installed in the Fbr Rx slot (slot 0) of expansion cabinets allow the connection of fiber optic cables from the main cabinet. There are three types:

- The NTDK23 Fiber Receiver card
- The NTDK25 Fiber Receiver card
- The NTDK80 Fiber Receiver card

NTDK23 Fiber Receiver card

The NTDK23 Fiber Receiver card is used when the expansion cabinet is within 10 m (33 ft) of the main cabinet. It connects to one A0618443 Fiber Optic cable.

One of these cards is required for each expansion cabinet located within 10 m (33 ft) of the main cabinet. The NTDK23 Fiber Receiver card works in conjunction with either an NTDK22 or an NTDK84 Fiber Expansion Daughterboard in the main cabinet.

NTDK25 Fiber Receiver card

The NTDK25 Fiber Receiver card is used when the expansion cabinet is located up to 3 km (1.8 mi) of the main cabinet. It connects to one multimode glass fiber optic cable which is dedicated to the Option 11C system. One of these cards is required for each expansion cabinet located up to 3 km (1.8 mi) of the main cabinet, connected by multimode fiber optic cable. The NTDK25 Fiber Receiver card works in conjunction with either an NTDK24 or an NTDK85 Fiber Expansion Daughterboard in the main cabinet.

Note: The NTDK24 supports only Multimode glass fiber optic cable.

NTDK80 Fiber Receiver card

The NTDK80 Fiber Receiver card has the same features as the NTDK25 except that:

- it requires Single Mode glass fiber optic cable
- it works in conjunction with an NTDK79 Fiber Expansion Daughterboard in the main cabinet instead of an NTDK24 card.

Note: The NTDK80 supports only Single Mode glass fiber optic cable.

SDI Port

Each Fiber Receiver card supports one Serial Data Interface (SDI) port allowing remote TTY access. See “SDI ports” on page 227 for further details.

Expansion Daughterboards for IP connectivity

- The NTDK83 dual port 100baseT IP daughterboard
- The NTDK99 single port 100baseT IP daughterboard
- The NTTK01 single port 100baseF IP daughterboard
- The NTTK02 dual port 100baseF IP daughterboard

NTDK83 dual port 100baseT IP daughterboard

The NTDK83 dual port 100baseT IP daughterboard has two 100BaseT IP ports, and can be used to connect Point To Point or to a campus data network.

NTDK99 single port 100baseT IP daughterboard

The NTDK99 single port 100baseT IP daughterboard has one 100BaseT IP port, and can be used to connect Point To Point or to a campus data network.

NTTK01 single port 100baseF IP daughterboard

The NTTK01 single port 100baseF IP daughterboard has one 100BaseF IP port, and can be used to connect Point To Point or to a campus data network with glass fiber optic cable. This is the glass fiber optic cable version of the NTDK99 described above.

NTTK02 dual port 100baseF IP daughterboard

The NTTK02 dual port 100baseF IP daughterboard has two 100BaseF IP ports, and can be used to connect Point To Point or to the campus data network with glass multimode optic cable. This is the glass fiber optic cable version of the NTDK83 described above.

Fiber Optic cable

The Option 11C cabinets can be located up to 3 km (1.8 mi) from the main cabinet by using fiber optic cable. There are two types of connections:

- Plastic Fiber Optic cable
- Glass Fiber Optic cable
- IP connector cables

Plastic Fiber Optic cable (Multi-mode)

The A0632902 Fiber Optic cable is a 10 m (33 ft) plastic fiber cable which is used when the expansion cabinet is located 10 m (33 ft) or less from the main cabinet. This cable comes equipped with a connector on each end which connect to either the NTDK22 or NTDK84 Daughterboard in the main cabinet and to the NTDK23 Fiber Receiver card in the expansion cabinet. Excess cable is stored by means of cable management devices in the cabinets. This cable, which is the only cable that can be used for this purpose, is not intended to be cut or altered in the field.

Glass Fiber Optic cable

Glass fiber optic cable (Multimode or Single Mode, depending on interface cards) is required when the cable length between the main cabinet and an expansion cabinet is up to 3 km (1.8 mi).

Note: The distance between the main cabinet and expansion cabinet is determined by the length of the fiber optic cable — not by linear distance.

This glass fiber cable, which is supplied by a local telephone company or other facilities provider, must be dedicated to the Option 11C (it cannot be shared with other services).

A connector is required on each end of the cable to connect to the NTDK24 (Multimode), NTDK85 (Multimode), or NTDK79 (Single Mode) Daughterboard in the main cabinet and to the NTDK25 (Multimode) or NTDK80 (Single Mode) Receiver card in the expansion cabinet. Excess cable is stored by means of cable management devices in the cabinets.

Note: The Option 11 C fiber optic link for distances up to 3 km (1.8 mi) uses the industry standard 62.5/125 μm glass multimode duplex cable with ST-type connectors.

The type of cable used depends on the type of installation and any local building codes.

Table 136 lists the minimum optical requirements for Multimode and Single Mode glass fiber optic cable used with the Option 11C.

Table 136
Multimode and Single Mode glass optical cable requirements

Parameter	Minimum	Typical	Maximum	Units
Glass Fiber Cable Length			3.0	km
Cable Attenuation @ 1300 nm		1.5	2.0	dB/km
Modal Bandwidth @ 1300 nm	200	500		MHz * km
Chromatic Dispersion @ 1300 nm		6		ps / nm * km
Typical 3dB Optical Bandwidth		180		MHz * km

Note: The typical power budget for the glass fiber link is typically 8 dB. The fiber link is limited to a maximum length of 3 km, even though with many optical cables the optical power budget of 8 dB could support greater lengths. To guarantee reliable operation a bandwidth of 150% should be maintained. If the link is increased beyond the 3 km length the 150% margin is deteriorated possibly resulting in link malfunction under some conditions.

IP connector cables

The Option 11C IP Expansion system requires the following cables:

Table 137
IP connector cables

Daughterboards	Cable	Cable description
NTDK83 and NTDK99 100baseT IP	NTTK34AA / AO793725	10m RJ45 CAT 5 cable
	NTDK8305 / AO781621	2m STP CAT 5 extension cable
NTTK01 and NTKK02 100baseF IP	AO817052	5 m MT-RJ to ST cable.
	A0346816	ST fibre coupler
	AO817055	10m MT-RJ to MT-RJ fibre extension cable

Environment

The Daughterboards and Receiver cards are subject to the environmental conditions shown in Table 138.

Table 138
Environmental conditions

	Operating	Storage
Ambient temperature	0° C to 50° C (32° F to 122° F)	-45° C to 70 ° C (-49° F to 158° F)
Relative Humidity	5% to 95%	0% to 95%

Chapter 28 — NTAK09 1.5 Mb DTI/PRI card

Contents

This section contains information on the following topics:

Overview	447
Functional description	448
Physical description	448
Power requirements	449
Foreign and surge voltage protection	449
Architecture	450
Signaling interface	450
Interconnection	450
Microprocessor	450
Digital pad	451
D-channel interface	452
DS-1 Carrier interface	453
Clock controller interface	454
Clock rate converter	454

Overview

The NTAK09 is a standard-size intelligent peripheral equipment circuit card in the Option 11C main and IP expansion cabinets. It provides 1.5Mb ISDN primary rate interface and digital trunk interface capability. The NTAK09 can be equipped with two daughterboards: the NTAK20 clock controller and the NTAK93/NTBK51 D-Channel handler interface.

The NTAk09 is being replaced by the NTRB21 - TMDI (DTI/PRI/DCH) which is described in "NTRB21 DTI/PRI/DCH TMDI card" on page 461.

Functional description

NTAk09 provides the following features and functions:

- configurable parameters, including A/ μ -Law operation, digital pads on a per channel basis, and Superframe or Extended Superframe formats
- AMI or B8ZS line coding
- 1.5 Mb Clock recovery and distribution of reference clocks
- DG2 or FDL yellow alarm methods
- card status and alarm indication with faceplate-mounted LEDs
- automatic alarm monitoring and handling
- Card-LAN for maintenance communications
- loopback capabilities for both near end and far end
- echo canceler interface
- integrated trunk access (both D-channel and in-band A/B signaling can be mixed on the same PRI)
- faceplate monitor jacks for T-1 interface
- configurable D-channel data rate with 64 Kbps, 56 Kbps or 64 Kbps inverted.
- self-test

Physical description

The DTI/PRI card uses a standard IPESized (9.5" by 12.5"), multilayer printed circuit board with buried power and ground layers. It is keyed to prevent insertion in slot 10. The clock controller and D-channel daughterboards are fastened by standoffs and connectors.

The NTAk09 DTI/PRI card has seven faceplate LEDs. The first five LEDs are associated with the NTAk09 card, the remaining two LEDs are associated with the clock controller and DCHI daughterboards.

In general, the first five LEDs operate as follows:

- During system power up, the LEDs are on.
- When the self-test is in progress, the LEDs flash on and off three times, then go into their appropriate states, as shown in Table 139.

Table 139
NTAK09 LED states

LED	State	Definition
DIS	On (Red)	The NTAK09 circuit card is disabled.
	Off	The NTAK09 is not in a disabled state.
ACT	On (Green)	The NTAK09 circuit card is in an active state. No alarm states exist, the card is not disabled, nor is it in a loopback state.
	Off	An alarm state or loopback state exists, or the card has been disabled. See the other faceplate LEDs for more information.
RED	On (Red)	A red-alarm state has been detected.
	Off	No red alarm.
YEL	On (Yellow)	A yellow alarm state has been detected.
	Off	No yellow alarm.
LBK	On (Green)	NTAK09 is in loop-back mode.
	Off	NTAK09 is not in loop-back mode.

Power requirements

The DTI/PRI obtains its power from the backplane, and draws less than 2 amps on +5 V, 50 mA on +12 V and 50 mA on -12 V.

Foreign and surge voltage protection

Lightning protectors must be installed between an external T-1 carrier facility and the Option 11C cabinet. For public T-1 facilities, this protection is provided by the local operating company. In a private T-1 facility environment (a campus, for example), the NTAK92 protection assembly may be used.

The NTAk09 circuit card conforms to safety and performance standards for foreign and surge voltage protection in an internal environment.

Architecture

Signaling interface

The signaling interface performs an 8 Kbps signaling for all 24 channels and interfaces directly to the DS-30X link. Messages in both directions of transmission are three bytes long.

Interconnection

The interconnection to the carrier is by NTBk04 1.5Mb carrier cable (A0394216).

The NTBk04 is twenty feet long. The NT8D97AX, a fifty-foot extension, is also available if required.

Microprocessor

The NTAk09 is equipped with bit-slice microprocessors that handle the following major tasks:

- Task handler: also referred to as an executive, the task handler provides orderly per-channel task execution to maintain real-time task ordering constraints.
- Transmit voice: inserts digital pads, manipulates transmit AB bits for DS1, and provides graceful entry into T-Link data mode when the data module connected to the DTI/PRI trunk is answering the call.
- Receive voice: inserts digital pads and provides graceful entry into T-Link data mode when the data module connected to the DTI/PRI trunk is originating the call.
- T-Link data: a set of transmit and receive vectored subroutines which provides T-Link protocol conversion to/from the DM-DM protocol.
- Receive ABCD filtering: filters and debounces the receive ABCD bits and provides change of state information to the system.
- Diagnostics
- Self-test

Digital pad

The digital pad is an EPROM whose address-input to data-output transfer function meets the characteristics of a digital attenuator. The digital pad accommodates both μ 255-law and A-law coding. There are 32 combinations each for μ 255 to μ 255, μ 255 to A-law, A-law to μ 255, and A-law to A-law. These values are selected to meet the EIA loss and level plan.

Table 140
Digital pad values and offset allocations

Offset	PAD set 0	PAD set 1
0	0dB	-7db
1	2dB	-8db
2	3dB	-9db
3	4dB	-10db
4	5dB	0.6db
5	6.1dB	7db
6	8dB	9db
7	-1dB	10db
8	-3dB	11db
9	-4dB	12db
A	idle code, 7F	3db
B	unassigned code, FF	14db
C	1dB	spare
D	-2dB	spare
E	-5db	spare
F	-6db	spare

D-channel interface

The D-channel interface is a 64 Kbps, full-duplex, serial bit-stream configured as a DCE device. The data signals include receive data output, transmit data input, receive clock output, and transmit clock output. The receive and transmit clocks can be of slightly different bit rate from each other as determined by the transmit and receive carrier clocks.

Feature selection through software configuration for the D-channel includes:

- 56 Kbps
- 64 Kbps clear
- 64 Kbps inverted (64 Kbps restricted)

DCHI can be enabled and disabled independent of the PRI card, as long as the PRI card is inserted in its cabinet slot. The D-channel data link cannot be established however, unless the PRI loop is enabled.

On the NTAK09 use switch 1, position 1 to select either the D-channel feature or the DPNSS feature, as follows:

OFF = D-channel

ON = DPNSS (U.K.).

DS-1 Carrier interface

Transmitter

The transmitter takes the binary data (dual unipolar) from the PCM transceiver and produces bipolar pulses for transmission to the external digital facility. The DS1 transmit equalizer allows the cabling distance to be extended from the card to the DSX-1 or LD-1. Equalizers are switch selectable through dip-switches and the settings are as shown below.

Table 141
NTAK09 switch settings

Distance to Digital Cross-Connect	Switch Setting			
	1 DCH F/W	2 (LEN 0)	3 (LEN 1)	4 (LEN 2)
0 - 133 feet	Off	Off	Off	On
133 - 266 feet	Off	On	On	Off
266 - 399 feet	Off	Off	On	Off
399 - 533 feet	Off	On	Off	Off
533 - 655 feet	Off	Off	Off	Off

Receiver

The receiver extracts data and clock from an incoming data stream and outputs clock and synchronized data. At worst case DSX-1 signal levels, the line receiver will operate correctly with up to 655 feet of ABAM cable between the card and the external DS1 signal source.

Connector pinout

The connection to the external digital carrier is via a 15 position Male D type connector.

Table 142
DS-1 line interface pinout for NTBk04 cable

From 50-pin MDF connector	to DB-15	signal name	description
pin 48	pin 1	T	transmit tip to network
pin 23	pin 9	R	transmit ring to network
pin 25	pin 2	FGND	frame ground
pin 49	pin 3	T1	receive tip from network
pin 24	pin 11	R1	receive ring from network

Clock controller interface

The purpose of the clock controller interface is to provide the recovered clock from the external digital facility to the clock controller daughterboard via the backplane. Depending on the equipped state of the clock controller, the clock controller interface enables or disables the appropriate reference clock source, in conjunction with software.

Clock rate converter

The 1.5 Mb clock is generated by a phase-locked loop (PLL). The PLL synchronizes the 1.5 Mb DS1 clock to the 2.56 Mb system clock through the common multiple of 8 kHz by using the main frame synchronization signal.

Chapter 29 — NTRB21 DTI/PRI/DCH TMDI card

Contents

This section contains information on the following topics:

Overview	456
Functional description	456
Software description	457
Hardware description	457
NTRB21 TMDI card	457
Shelf slot assignment	459
Physical description	459
Power requirements	460
Foreign and surge voltage protection	460
Architecture	461
Signaling interface	461
Interconnection	461
Microprocessor	461
Digital pad	462
D-channel interface	463
DS-1 Carrier interface	464
NTAK20 Clock Controller (CC) daughterboard	465

Overview

The NTRB21 TMDI (DTI/PRI/DCH) card is required to implement PRI on the Meridian 1 Option 11C system. It is supported in the Main and IP expansion cabinets.

The TMDI feature introduces the software changes required for an Option 11C system to support the new TDMI pack. These changes include the introduction of a new prompt to replace a function that was handled by a dip switch on the NTAK09, as well as an extra loadware application to handle Layer 1, and changes to make the existing loadware files into 32 bit format instead of the original 16 bit format. To provide CEMUX communication with the card, changes are also required to create an I/O entry for the card. In addition the NTRB21 has a built-in downloadable D-channel.

This card requires that the Option 11C be equipped with at least Release 24 software.

This card replaces the NTAK09 described in “NTAK09 1.5 Mb DTI/PRI card” on page 447. This feature does not affect the NTAK09 functionality, configuration, or maintenance in any way. Aside from changes to the configuration and maintenance of the pack, there are no other changes seen by the users, and call processing is not affected.

Functional description

NTRB21 provides the following features and functions:

- configurable parameters, including A/μ-Law operation, digital pads on a per channel basis, and Superframe or Extended Superframe formats
- AMI or B8ZS line coding
- 1.5 Mb Digital Trunk Interface and 1.5 Mb Primary Rate Interface
- 1.5 Mb Clock recovery and distribution of reference clocks
- DG2 or FDL yellow alarm methods
- card status and alarm indication with faceplate-mounted LED
- automatic alarm monitoring and handling
- Card-LAN for maintenance communications
- loopback capabilities for both near end and far end

- echo canceler interface
- integrated trunk access (both D-channel and in-band A/B signaling can be mixed on the same PRI)
- faceplate monitor jacks for T-1 interface
- configurable D-channel data rate with 64 Kbps, 56 Kbps or 64 Kbps inverted.
- self-test

Software description

Changes from the NTAK09 are required for the new trunk card and ISM parameters are n service change and maintenance overlays. There is a change to CardLAN to introduce a new CardLAN ID. The download of PSDL data is also changed to handle a 32 bit download as well as existing 16 bit.

Hardware description

NTRB21 TMDI card

The NTRB21 TMDI card provides 1.5 MBits Digital Trunk Interface or Primary Rate Interface functionality on the Option 11C. The NTRB21 has a built-in downloadable D-channel, and may occupy card slots 1-9 on the Option 11C main cabinet.

Note 1: For CISPR B group cabinets, the active Clock Controller (NTAK20) can only occupy slots 1-3. For FCC and/or CISPR A group cabinets, this limitation does not exist - the Clock Controller can occupy any available slot 1-9.

Note 2: The NTRB21 TMDI card requires that the Option 11C be loaded with at least Release 24 software. If an Option 11C switch is loaded with Release 24 (or later) software, the NTRB21 can be equipped together with the NTAK09 DTI/PRI card (with the NTBK51 downloadable D-channel daughterboard).

Figure 57 on page 458 shows a faceplate of the NTRB21 TMDI card.

Figure 57
NTRB21 TMDI card faceplate

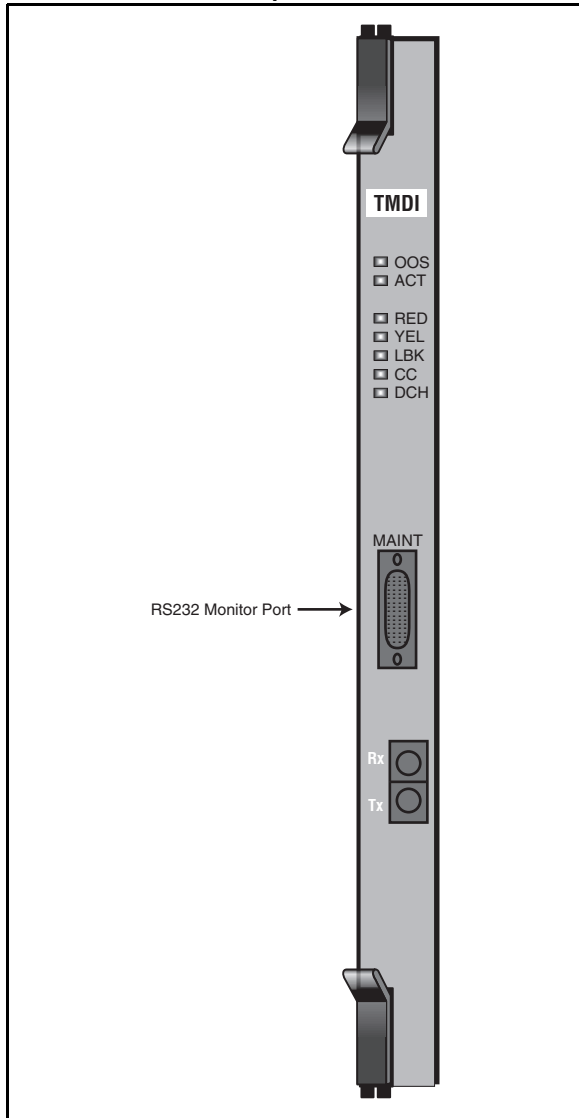

Shelf slot assignment

On non-ECM system cabinets, the NTAk20 may be placed in slots 1-9. On cabinets NTAk11Dx and NTAk11Fx, the active NTAk20 must be placed in slots 1-3 (slots 4-10 may not be used).

Physical description

The NTRB21 card uses a standard IPE-sized (9.5" by 12.5"), multi-layer printed circuit board with buried power and ground layers. It is keyed to prevent insertion in slot 10. The clock controller daughterboard is fastened by standoffs and connectors.

The NTRB21 card has seven faceplate LEDs. The first five LEDs are associated with the NTRB21 card, the remaining two LEDs are associated with the clock controller and DCHI daughterboards.

In general, the first five LEDs operate as follows:

- During system power up, the LEDs are on.
- When the self-test is in progress, the LEDs flash on and off three times, then go into their appropriate states, as shown in Table 143

Table 143
NTRB21 LED states

LED	State	Definition
DIS	On (Red)	The NTRB21 circuit card is disabled.
	Off	The NTRB21 is not in a disabled state.
ACT	On (Green)	The NTRB21 circuit card is in an active state. No alarm states exist, the card is not disabled, nor is it in a loopback state.
	Off	An alarm state or loopback state exists, or the card has been disabled. See the other faceplate LEDs for more information.
RED	On (Red)	A red-alarm state has been detected.
	Off	No red alarm.
YEL	On (Yellow)	A yellow alarm state has been detected.
	Off	No yellow alarm.
LBK	On (Green)	NTRB21 is in loop-back mode.
	Off	NTRB21 is not in loop-back mode.

Power requirements

The DTI/PRI obtains its power from the backplane, and draws less than 2 mA on +5 V, 50 mA on +12 V, and 50 mA on -12 V.

Foreign and surge voltage protection

Lightning protectors must be installed between an external T-1 carrier facility and the Option 11C cabinet. For public T-1 facilities, this protection is provided by the local operating company. In a private T-1 facility environment (a campus, for example), the NTAK92 protection assembly may be used.

The NTRB21 circuit card conforms to safety and performance standards for foreign and surge voltage protection in an internal environment.

Architecture

Signaling interface

The signaling interface performs an 8 Kbps signaling for all 24 channels and interfaces directly to the DS-30X link. Messages in both directions of transmission are three bytes long.

Interconnection

The interconnection to the carrier is by NTBK04 1.5Mb carrier cable (A0394216).

The NTBK04 is twenty feet long. The NT8D97AX, a fifty-foot extension, is also available if required.

Microprocessor

The NTRB21 is equipped with bit-slice microprocessors that handle the following major tasks:

- Task handler: also referred to as an executive, the task handler provides orderly per-channel task execution to maintain real-time task ordering constraints.
- Transmit voice: inserts digital pads, manipulates transmit AB bits for DS1, and provides graceful entry into T-Link data mode when the data module connected to the DTI/PRI trunk is answering the call.
- Receive voice: inserts digital pads and provides graceful entry into T-Link data mode when the data module connected to the DTI/PRI trunk is originating the call.
- T-Link data: a set of transmit and receive vectored subroutines which provides T-Link protocol conversion to/from the DM-DM protocol.
- Receive ABCD filtering: filters and debounces the receive ABCD bits and provides change of state information to the system.
- Diagnostics
- Self-test

Digital pad

The digital pad is an EPROM whose address-input to data-output transfer function meets the characteristics of a digital attenuator. The digital pad accommodates both μ 255-law and A-law coding. There are 32 combinations each for μ 255 to μ 255, μ 255 to A-law, A-law to μ 255, and A-law to A-law. These values are selected to meet the EIA loss and level plan.

Table 144
Digital pad values and offset allocations

Offset	PAD set 0	PAD set 1
0	0dB	-7db
1	2dB	-8db
2	3dB	-9db
3	4dB	-10db
4	5dB	0.6db
5	6.1dB	7db
6	8dB	9db
7	-1dB	10db
8	-3dB	11db
9	-4dB	12db
A	idle code, 7F	3db
B	unassigned code, FF	14db
C	1dB	spare
D	-2dB	spare
E	-5db	spare
F	-6db	spare

D-channel interface

The D-channel interface is a 64 Kbps, full-duplex, serial bit-stream configured as a DCE device. The data signals include receive data output, transmit data input, receive clock output, and transmit clock output. The receive and transmit clocks can be of slightly different bit rate from each other as determined by the transmit and receive carrier clocks.

Feature selection through software configuration for the D-channel includes:

- 56 Kbps
- 64 Kbps clear
- 64 Kbps inverted (64 Kbps restricted)

DCHI can be enabled and disabled independent of the PRI card, as long as the PRI card is inserted in its cabinet slot. The D-channel data link cannot be established however, unless the PRI loop is enabled.

On the NTRB21 use switch 1, position 1 to select either the D-channel feature or the DPNSS feature, as follows:

OFF = D-channel

ON = DPNSS (U.K.).

DS-1 Carrier interface

Transmitter

The transmitter takes the binary data (dual unipolar) from the PCM transceiver and produces bipolar pulses for transmission to the external digital facility. The DS1 transmit equalizer allows the cabling distance to be extended from the card to the DSX-1 or LD-1. Equalizers are switch selectable through dip-switches and the settings are as shown below.

Table 145
NTRB21 switch settings

Distance to Digital Cross-Connect	Switch Setting			
	1 DCH F/W	2 (LEN 0)	3 (LEN 1)	4 (LEN 2)
0 - 133 feet	Off	Off	Off	On
133 - 266 feet	Off	On	On	Off
266 - 399 feet	Off	Off	On	Off
399 - 533 feet	Off	On	Off	Off
533 - 655 feet	Off	Off	Off	Off

Receiver

The receiver extracts data and clock from an incoming data stream and outputs clock and synchronized data. At worst case DSX-1 signal levels, the line receiver will operate correctly with up to 655 feet of ABAM cable between the card and the external DS1 signal source.

Connector pinout

The connection to the external digital carrier is via a 15 position Male D type connector.

Table 146
DS-1 line interface pinout for NTB04 cable

From 50-pin MDF connector	To DB-15	Signal name	Description
pin 48	pin 1	T	transmit tip to network
pin 23	pin 9	R	transmit ring to network
pin 25	pin 2	FGND	frame ground
pin 49	pin 3	T1	receive tip from network
pin 24	pin 11	R1	receive ring from network

NTAK20 Clock Controller (CC) daughterboard

Digital Trunking requires synchronized clocking so that a shift in one clock source will result in an equivalent shift of the same size and direction in all parts of the network. On Option 11C systems, synchronization is accomplished with the NTAK20 clock controller circuit card. The Clock Controller circuitry synchronizes the Option 11C to an external reference clock, and generates and distributes the clock to the system. Option 11C can function either as a slave to an external clock or as a clocking master. The NTAK20AA version of the clock controller meets AT&T Stratum 3 and Bell Canada Node Category D specifications. The NTAK20BA version meets CCITT stratum 4 specifications. See "NTAK20 clock controller" on page 503.

IMPORTANT

If an IP Expansion multi-cabinet system is equipped with digital trunk cards, it is mandatory that at least one trunk card is placed in the Main Option 11C cabinet. A cabinet that has a digital trunk must have a clock controller.

Clock rate converter

The 1.5 Mb clock is generated by a phase-locked loop (PLL). The PLL synchronizes the 1.5 Mb DS1 clock to the 2.56 Mb system clock through the common multiple of 8 kHz by using the main frame synchronization signal.

Chapter 30 — NTAk10 2.0 Mb DTI card

Contents

This section contains information on the following topics:

Overview	467
Functional description	467
Physical description	468
Power requirements	470
Environment	470
Architecture	470
DS-30X interface	470
Signaling interface	472
Carrier interface	473
Clock controller interface	474
Switch settings	477

Overview

The NTAk10, which can be located in the main cabinet and IP expansion cabinets, provides an IPE-compatible 2.0 Mb DTI interface for the Option 11C system. This circuit card includes on-board clock controller circuitry that can be manually switched in or out of service.

Functional description

The NTAk10 provides the following features and functions:

- a clock controller that can be switched in as an option
- software-selectable A/ μ law operation

- software-selectable digital pads on a per channel basis
- frame alignment and multiframe alignment detection
- frame and multiframe pattern generation
- CRC-4 transmission and reception (software selectable)
- card status and alarm indication with faceplate-mounted LEDs
- Periodic Pulse Metering (PPM) counting
- outpulsing of digits on any of the abcd bits
- Card-LAN for maintenance communications
- per-channel and all-channel loopback capabilities for near-end and far-end
- self-test
- download of incoming abcd validation times from software
- warm SYSLOAD (TS16 AS16 transmitted)

Applicability to France

Features specific to DTI requirements for France are implemented in firmware, and are switch-accessed. The requirements met are as follows:

- transmission and reception of alarm indication signaling (AIS) in TS16 (card disabled, warm SYSLOAD, etc.)
- France-specific PPM counting
- decadic dialing
- France-specific alarm report and error handling

Physical description

The 2Mb DTI pack uses a standard IPE-sized (9.5" by 12.5"), multilayer printed circuit board. The faceplate is 7/8" wide and contain six LEDs.

In general, the LEDs operate as follows:

- after the card is plugged in, the LEDs (a-e) are turned on by the power-up circuit. The clock controller LED is independently controlled by its own microprocessor
- after initialization, the LEDs (a-e) flash three times (0.5 seconds on, 0.5 seconds off) and then individual LEDs will go into appropriate states, as shown in Table •.

Table 147
NTAK10 LED states

LED	State	Definition
DIS	On (Red)	The NTAK10 circuit card is disabled.
	Off	The NTAK10 is not in a disabled state.
OOS	On (Yellow)	The NTAK10 is in an out of service state
	Off	The NTAK10 is not in an out of service state
NEA	On (Yellow)	A near end alarm state has been detected
	Off	No near end alarm
FEA	On (Yellow)	A far end alarm state has been detected
	Off	No far end alarm
LBK	On (Yellow)	NTAK10 is in loop-back mode
	Off	NTAK10 is not in loop-back mode
CC	On (Red)	The clock controller is switched on and disabled
	On (Green)	The clock controller is switched on and is either locked to a reference or is in free-run mode
	Flashing (Green)	The clock controller is switched on and locking onto the primary reference
	Off	The clock controller is switched off Note: See "Clock controller interface" on page 474 in this chapter for more on tracking and free-run operation.

Power requirements

The 2MB DTI obtains its power from the backplane. It draws less than 2A on +5V, 50mA on +15V and 50mA on -15V.

Environment

The NTAK10 meets all applicable Nortel Networks operating specifications.

Architecture

The main functional blocks of the NTAK10 architecture include:

- DS-30X interface
- signaling interface
- three microprocessors
- digital pad.
- Card-LAN interface.
- carrier interface.
- clock controller interface.

A description of each block follows.

DS-30X interface

The NTAK10 interfaces to one DS-30X bus which contains 32 byte-interleaved timeslots operating at 2.56 Mb. Each timeslot contains 10 bits in A10 message format, 8 are assigned to voice/data (64 Kbps), one to signaling (8 Kbps), and one is a data valid bit (8 Kbps).

Transmit data

To transmit data on the carrier, the incoming serial bit stream from the NTAK02 circuit card is converted to 8-bit parallel bytes. The signaling bits are extracted by the signaling interface circuitry.

Digital Pad: The parallel data is presented to the pad PROM. The PROM contains pad values, idle code, and A/ μ -law conversion. They can be set independently for incoming and outgoing voice on a per channel basis. Four conversion formats are provided: A-law to A-law, A-law to μ -law, μ -law to A-law, μ -law to μ -law.

Each of these four formats has up to 32 unique pad values. The NTAK10 card provides the pad values of -10, -9, -8, -7, -6, -5, -4, -3, -2, -1, 0, 0.6, 1, 2, 3, 4, 5, 6, 7, 8, 9, 10, 11, 12, 13, and 14 dB (also idle and unassigned code). A negative pad is a positive gain.

The pad PROM output is converted from parallel to serial format and passed on to a multiplexer, which passes PCM/data, TS0, and TS16 information. The FAS pattern is sent in even TS0s, while in odd TS0s alarm information is sent. The multiplexer output is fed to the carrier interface which can forward it to the carrier or perform per channel loopback.

Receive data

To receive data, PCM/Data from the carrier interface is converted from serial to parallel, is buffered, and is fed to the pad prom. It then sent onto the DS-30X interface, where signaling information from the signaling interface circuitry is multiplexed.

DS-30X microprocessor

The DS-30X is a utility processor, responsible for the following tasks:

- controlling the DS-30X interface
- receiving and decoding of messages and taking appropriate action
- transmitting TS16 messages to the TS16 microprocessor
- receiving TS16 messages from the TS16 microprocessor and passing these messages to the A07
- providing the 19.2 Kbps serial interface to the Card-LAN
- controlling LEDs
- downloading LCAs
- monitoring errors and alarms
- detecting the change of state in TS0, and outputting TS0 data
- counting bipolar violations, slips, PLL alarms, frame-alignment errors, and CRC-4 errors
- monitoring the status of frame alignment and multiframe alignment
- detecting and reporting of alarm indication signals (AIS)

- updating of per channel loopback registers
- controlling the far-end loopback and digroup loopback functions

Signaling interface

Interconnections

The external interconnection is through a 50-pin MDF connector with a NTBk05 carrier cable A0394217.

CEPT interface

For the Conference of European Postal Communications (CEPT) interface, the connection to the external digital carrier is through NT5K85 DTI cable assembly A0392021. It converts the 120ohm D-connector to 75ohm coax. The impedance is switch set. See the switch-settings table at the end of this chapter for options.

If a coax interface is required, use NT5K85 in conjunction with the NTBk05.

Channel associated signaling

Channel associated signaling implies that each traffic carrying channel has its own signaling channel permanently associated with it. Timeslot 16 is used to transmit two types of signaling: supervisory and address.

Incoming signal

Functions of the NTAk10 with regard to incoming signaling include:

- recognizing valid changes.
- determining which channels made the changes.
- collecting PPM.
- reporting changes to software.

Outgoing supervisory signals

The desired abcd bit pattern for a channel is output by the NTAk10, under the control of the System Core card. The bit pattern to be transmitted is held on the line for a minimum period of time. This time is specified in the same message and ensures that the signal is detected correctly at the far end.

With the exception of the outpulsing signals and special signals, such as Denmark's Flash signal and Sweden's Parking signal, the minimum duration of any signal state is 100 msec. Some signal states may have a minimum duration time that is longer than 100 msec.

Periodic Pulse Metering (PPM)

PPM is used to collect toll charges on outgoing CO trunk calls.

TS16 microprocessor

The functions of this microprocessor include:

- receiving signaling messages supplied by the DS-30X microprocessor, decoding these messages, and taking subsequent actions
- transmitting messages to the DS-30X microprocessor
- handling PPM
- updating the TS16 select RAM and TS16 data RAM
- providing outpulsing
- receive data from the change-of-state microprocessor
- transmitting AIS for CNET (France) application

Change-of-state microprocessor

The functions of this processor are:

- detecting valid change of state in TS16.
- when a valid change has been found, passing the new abcd bits to the TS16 microprocessor, along with five bits to indicate the associated channel.

Carrier interface

Tx Direction

The HDB3 encoded multiplexer output is fed to the output selector, which selects the PCM/Data output or the looped around far end data. The HDB3 is converted from digital to AMI and fed to the carrier. A transformer provides isolation and impedance matching (75 ohms or 120 ohms).

Rx Direction

The AMI data of the carrier is converted to digital and fed to the input selector as well as the output selector for far end loopback. Clock recovery circuitry within the receiving device extracts the 2.0 MHz clock. This clock is used to generate the frame and multiframe count and is sent to the clock controller as a reference.

Clock controller interface

The recovered clock from the external digital facility is provided to the clock controller through the backplane-to-clock controller interface. Depending upon the state of the clock controller (switched on or off), the clock controller interface will, in conjunction with software, enable or disable the appropriate reference clock source.

The clock-controller circuitry on NTAk10 is identical to that of the NTAk20. Note that while several DTI/PRI packs may exist in one system, only one clock controller may be activated (all other DTI/PRI clock controllers must be switched off).

Locking modes

The clock controller can operate in one of two modes: tracking or non-tracking (also known as free-run).

Tracking mode

There are two stages to clock controller tracking:

- tracking a reference, and
- locked onto a reference.

When tracking a reference, the clock controller uses an algorithm to match its frequency to the frequency of the incoming clock. When the frequencies are very near to being matched, the clock controller is locked onto the reference. The clock controller will make small adjustments to its own frequency until both the incoming and system frequencies correspond.

If the incoming clock reference is stable, the internal clock controller will track it, lock onto it, and match frequencies exactly. Occasionally, however, environmental circumstances will cause the external or internal clocks to drift. When this happens, the internal clock controller will briefly enter the tracking stage. The green LED will flash momentarily until the clock controller is locked onto the reference once again.

If the incoming reference is unstable, the internal clock controller will continuously be in the tracking stage, with the LED flashing green all the time. This condition does not present a problem, rather, it shows that the clock controller is continually attempting to lock onto the signal. If slips are occurring, however, it means that there is a problem with the clock controller or the incoming line.

Free-run (non-tracking)

In free-run mode, the clock controller does not synchronize on any source, it provides its own internal clock to the system. This mode can be used when the Option 11C is used as a master clock source for other systems in the network. Free-run mode is undesirable if the Option 11C is intended to be a slave. It can occur, however, when both the primary and secondary clock sources are lost due to hardware faults or when invoked by using software commands.

Clock controller functions and features

The NTAK10 2MB DTI clock controller functions and features include:

- phase-locking to a reference, generating the 10.24 Mhz system clock, and distributing it to the CPU through the backplane. Up to two references at a time may be accepted.
- providing primary to secondary switchover and auto-recovery
- preventing chatter
- providing error burst detection and correction, holdover, and free running capabilities
- complying with 2.0Mb CCITT specifications.
- communicating with software.

- providing jitter filtering.
- making use of an algorithm to aid in detecting crystal aging and to qualify clocking information.

Reference switchover

Switchover may occur in the case of reference degradation or reference failure. When performance of the reference degrades to a point where the system clock is no longer allowed to follow the timing signal, then the reference will be said to be out of specification. If the reference being used is out of specification and the other reference is still within specification, an automatic switchover is initiated without software intervention. If both references are out of specification, the clock controller provides holdover.

Autorecovery and chatter

If the software command “track to primary” is given, the clock controller tracks to the primary reference and continuously monitors the quality of both primary and secondary references. If the primary becomes out of specification, the clock controller automatically tracks to secondary provided that it is within specifications. On failure (both out of specification), the clock controller enters the HOLDOVER mode and continuously monitors both references. An automatic switchover is initiated to the reference that recovers first. If the secondary recovers first, then the clock controller tracks to the secondary, but switches over to the primary whenever the primary recovers. If the primary recovers first, then the clock controller tracks to the primary.

If the software command “track to secondary” is given, the clock controller tracks to the secondary reference and continuously monitors the quality of both primary and secondary references. If the secondary becomes out of specification, the clock controller automatically tracks to primary provided that it is within specifications. On failure (both out of specification), the clock controller enters the HOLDOVER mode and continuously monitors both references. An automatic switchover is initiated to the reference that recovers first. If the primary recovers first, then the clock controller tracks to the primary, but switches over to the secondary whenever the secondary recovers. If the secondary recovers first, then the clock controller tracks to the secondary.

A time-out mechanism prevents chatter due to repeated automatic switching between primary and secondary reference sources.

Reference clock selection via software

The 2MB DTI card has the necessary hardware for routing its reference to the appropriate line on the backplane

Software is responsible for the distribution of the secondary references and ensures that no contention is present on the REFCLK1 backplane line.

Software designates the 2MB DTI Card as a primary reference source to the clock controller. The secondary reference is obtained from another 2 Mbps DTI card, which is designated by a craft person. No other clocks originating from other 2MB DTI packs are used.

The clock controller provides an external timing interface and is capable of accepting two signals as timing references. In this case, an external reference refers to an auxiliary timing source which is bridged from a traffic carrying signal. This is not intended to be a dedicated non-traffic bearing timing signal. The clock controller uses either the two external/auxiliary references or the 2MB DTI references.

Reference clock interface

The recovered clock derived from the facility is available on the MDF connector. The signals at these connectors conform to the electrical characteristics of the EIA RS-422 standard.

Switch settings

Various 2MB DTI switchable options exist on the NTAk10. These are:

Switch	Off (Switch Open)	On (Switch Closed)
S1-1	-	-
S1-2	CC Enabled	CC Disabled
S2-1	120 ohm	75 ohm
S2-2	75 ohm	120 ohm
S3-1	non-French Firmware	French Firmware
S3-2	-	-

Note: The ON position for all the switches is towards the bottom of the card. This is indicated by a white dot printed on the board adjacent to the bottom left corner of each individual switch.

Chapter 31 — NTAk79 2.0 Mb PRI card

Contents

This section contains information on the following topics:

Overview	479
Functional description	480
Physical description	480
Power requirements	481
Environment	482
Architecture	482
DS-30X interface	482
Signaling interface	484
Carrier interface	484
Carrier grounding	485
CEPT transceiver	486
Slip control	486
D-channel support interface	486
Card-LAN interface	487
Clock controller interface	487

Overview

The NTAk79, which can be located in the main and IP expansion cabinets, provides a 2.0 Mb PRI interface and an onboard D-channel handler (DCH) for the Option 11C system. This circuit card also includes onboard circuitry equivalent to the NTAk20 Clock Controller that can be manually switched in or out of service.

Functional description

NTAK79 provides the following features and functions:

- recovery of the 2.048 kbps data by the CEPT receiver, at signal levels which have been attenuated by up 10 dB
- control of CEPT line density using HDB3 which provides 64 kbps clear channel
- performance monitoring of the receive carrier by means of Bipolar Violations (BPV), Slips, CRC-4 (CRC), and Frame Bit Errors (FBER)
- monitoring of receive carrier alarms including AIS, LOS, and RAI
- transmission of remote alarm when instructed
- slip-buffering receive messages
- supporting National and International bits in time slot 0
- on-board clock controller
- onboard D-channel interface
- 32 software-selectable Tx & Rx Pad values
- conversion of PCM commanding Laws (A-A, u-u, A-u, u-A)
- Card-LAN for maintenance communications

Physical description

The NTAk79 uses a standard IPE-sized (9.5" by 12.5"), multilayer printed circuit board. The faceplate is 7/8" wide and contains seven LEDs.

In general, the LEDs operate as shown in Table 148.

Table 148
NTAK79 LEDs (Part 1 of 2)

LED	State	Definition
OOS	On (Red)	The NTAk79 2MB PRI circuit card is either disabled or out-of-service.
	Off	The NTAk79 2MB PRI is not in a disabled state.
ACT	On (Green)	The NTAk79 2MB PRI circuit card is in an active state.

Table 148
NTAK79 LEDs (Part 2 of 2)

LED	State	Definition
	Off	The NTA79 2MB PRI is not in a disabled state. The OOS LED will be red.
RED	On (Red)	A red alarm state has been detected. This represents a local alarm state of: Loss of Carrier (LOS) Loss of Frame (LFAS), or Loss of CRC Multiframe (LMAS).
	Off	No red (local) alarm.
YEL	On (Yellow)	A yellow alarm state has been detected. This represents a remote alarm indication from the far end. The alarm may be either Alarm Indication (AIS) or Remote Alarm (RAI).
	Off	No yellow (remote) alarm.
LBK	On (Green)	2MB PRI is in loop-back mode.
	Off	2MB PRI is not in loop-back mode.
CC	On (Red)	The clock controller is switched on and disabled.
	On (Green)	The clock controller is switched on and is either locked to a reference or is in free run mode.
	Flashing (Green)	The clock controller is switched on and is attempting to lock (tracking mode) to a reference. If the LED flashes continuously over an extended period of time, check the CC STAT in LD60. If the CC is tracking this may be an acceptable state. Check for slips and related clock controller error conditions. If none exist, then this state is acceptable, and the flashing is identifying jitter on the reference.
DCH	On (Red)	DCH is equipped and disabled.
	On (Green)	DCH is equipped and enabled, but not necessarily established.
	Off	DCH is switched off.

Power requirements

The NTA79 obtains its power from the backplane, drawing maximums of 2 amps on +5 V, 50 mA on +12 V and 50 mA on -12 V.

Environment

The NTAk79 meets all applicable Nortel Network's operating specifications.

Architecture

The main functional blocks of the NTAk79 architecture include:

- DS-30X interface
- A07 signaling interface
- digital pad
- carrier interface
- CEPT transceiver
- SLIP control
- D-Channel support interface
- 8031 microcontroller
- Card-LAN / echo / test port interface

A description of each block follows.

DS-30X interface

The NTAk79 interfaces to one DS-30X bus which contains 32 byte-interleaved timeslots operating at 2.56 Mb. Each timeslot contains 10 bits in A10 message format; 8 are assigned to voice/data (64 Kbps), one to signaling (8 Kbps), and one is a data valid bit (8 Kbps).

The incoming serial bit stream is converted to 8-bit parallel bytes to be directed to padding control.

The signaling bits are extracted and inserted by the A07 signaling interface circuitry. Following is the mapping of the DS-30X timeslot number to the PCM-30 channel number. Timeslots 0 and 16 are currently unused for PCM.

Digital PAD

Software selects A-law or Mu-Law and one of 32 possible PAD values for each channel. These values are provided in a PROM through which the data is routed. The idle code for A-law is 54H and for Mu-law is 7FH. The unequipped code is FFH for both A-law and Mu-law. As the idle code and unequipped code may be country dependent, the software instructs the NTAK79 to use different codes for each direction. The 32 digital pads available are illustrated below. The values shown are attenuation levels, i.e. 1.0dB is 1dB of loss and -1.0dB is 1db of gain.

Table 149
Digital Pad - values and offset allocations

PAD SET 0		PAD SET 1	
Offset	PAD	Offset	PAD
0	0.6 dB	0	0.0 dB
1	1.0 dB	1	-1.0 dB
2	2.0 dB	2	-2.0 dB
3	3.0 dB	3	-3.0 dB
4	4.0 dB	4	-4.0 dB
5	5.0 dB	5	-5.0 dB
6	6.1 dB	6	-6.0 dB
7	7.0 dB	7	-7.0 dB
8	8.0 dB	8	-8.0 dB
9	9.0 dB	9	-9.0 dB
10	10.0 dB	10	-10.0 dB
11	11.0 dB	11	spare
12	12.0 dB	12	spare
13	13.0 dB	13	spare
14	14.0 dB	14	Idle Code
15	spare	15	Unassigned Code

Signaling interface

The Meridian 1 signaling interface consists of the A07 DS-30X signaling controller. This interface provides an 8 Kbps signaling link via the DS-30X timeslot zero data bit zero. Messages are 3 bytes in length.

Carrier interface

For the E-1 interface, the connection to the external digital carrier is provided by the line interface chip. This device provides accurate pulse shaping to meet the CCITT pulse mask requirements. It provides clock recovery functions on the receive side as well as tolerance to jitter and wander in the received bit stream.

Impedance matching

The line interface provides for the use of either 75ohm coaxial or 120ohm twisted pair cable. The impedance is selected by a switch, as shown in the settings table below.

Table 150
Impedance matching switch selection

Cable	On	Off
75 Ohm	S2	S1
120 Ohm	S1	S2

Note: The ON position for all the switches is towards the bottom of the card. This is indicated by a white dot printed on the board adjacent to the bottom left corner of each individual switch.

Carrier grounding

NTAK79 provides for the capability of selectively grounding the shield of the Tx and/or Rx pairs of the carrier. Closing (down) the on-board switch will apply FGND to the appropriate carrier cable shield. The switch settings are shown below.

Table 151
Carrier shield grounding switch settings

Switch	Carrier Pair	On	Off
S4-1	Rx shield	Open	GND
S4-2	Tx shield	Open	GND

Receiver functions

The receiver extracts data and clock from an AMI (Alternate Mark Inversion) coded signal and outputs clock and synchronized data. The receiver is sensitive to signals over the entire range of cable lengths and requires no equalization. The clock and data recovery meets or exceeds the jitter specifications of the CCITT recommendation G.823 and the jitter attenuation requirements of CCITT recommendation G.742. This provides jitter attenuation increasing from 0 dB to 60 dB over the frequency range from about 6 Hz to 6 KHz.

Transmitter functions

The transmitter takes the binary (dual unipolar) data from the PCM transceiver and produces bipolar pulses which conform to CCITT recommendation G.703 pulse shape.

Loopbacks

The remote loopback function causes the device to transmit the same data that it receives using the jitter attenuated receive clock. The data is additionally available at the receive data outputs. Local loopback causes the transmit data and clock to appear at the receive clock and data outputs. This data is also transmitted on the line unless transmit AIS is selected.

CEPT transceiver

The transmitter and receiver functions are used for synchronization, channel, and signal extraction. The functions meet applicable specifications of the CCITT recommendation G.703 & G.732.

The transceiver provides transmit framing based on the 2.048 MHz clock derived from the DS-30X system clock and 1KHZ framing pulse.

Slip control

Slip control provides organized recovery of PCM when the clock recovered from the external facility is at a different frequency with respect to the local clock.

D-channel support interface

The D-channel support interface is a 64 kbps, full-duplex serial bit stream configured as a DCE device. The data signals include: (1) Receive data output, (2) transmit data input, (3) receive clock output, and (4) transmit clock output. The receive and transmit clocks can be of slightly different bit rates from each other as determined by the transmit and receive carrier clocks.

The NTAK79 has an onboard D-channel handler interface (DCHI). It is the equivalent to a single port of an NTAK02 SDI/DCH pack. This allows for a completely operational ISDN PRA link with clock synchronization and D-channel on a single circuit card.

The onboard D-channel has one status LED on the NTAK79 faceplate to indicate enabled/disabled states. (See Table 148).

The on-board DCHI can be operated in two separate modes as defined by an on-board dip switch. It can operate in a standard DCHI mode common to most ISDN standard countries. It can also operate in an U.K. specific mode using the DPNSS format.

Table 152
Settings for the DCHI dip switch (SW1)

Switch	Function	On	Off
S1-1	En/Dis	Enabled	Disabled
S1-2	F/W Mode	DPNSS	DCHI

DCHI special applications connection

The connection between the PRI2 and the on-board D-Channel Handler Interface card is also available at the MDF connector. The signals conform to the EIA RS-422 standard. Connections would not be made to these pins for normal on-board DCHI operation. They are available for future or special applications.

Card-LAN interface

A Dual Port UART handles the functions of the serial ports for the Card-LAN serial link and the echo canceller/test port interface. The echo/test interface is an asynchronous 4800 bps 8-bit connected to port A of the UART. The card-LAN interface is an asynchronous 19.2 kbps 9 bit start/stop connected to port B of the UART.

The connection to the echo canceler/test port is available at the backplane/MDF connector. The signals at this port conform to the EIA RS-232C.

Clock controller interface

The clock controller circuitry on the NTAK79 is identical to that of the NTAK20 clock controller.

Note that while several DTI/PRI packs may exist in one system, only one clock controller may be activated (all other DTI/PRI clock controllers must be switched off).

Clocking modes

The clock controller can operate in one of two modes: tracking or non-tracking (also known as free-run).

Tracking mode

There are two stages to clock controller tracking:

- tracking a reference, and
- locked onto a reference.

When tracking a reference, the clock controller uses an algorithm to match its frequency to the frequency of the incoming clock. When the frequencies are very near to being matched, the clock controller is locked onto the reference. The clock controller will make small adjustments to its own frequency until both the incoming and system frequencies correspond.

If the incoming clock reference is stable, the internal clock controller will track it, lock onto it, and match frequencies exactly. Occasionally, however, environmental circumstances will cause the external or internal clocks to drift. When this happens, the internal clock controller will briefly enter the tracking stage. The green LED will flash momentarily until the clock controller is locked onto the reference once again.

If the incoming reference is unstable, the internal clock controller will continuously be in the tracking stage, with the LED flashing green all the time. This condition does not present a problem, rather, it shows that the clock controller is continually attempting to lock onto the signal. If slips are occurring, however, it means that there is a problem with the clock controller or the incoming line.

Free-run (non-tracking)

In free-run mode, the clock controller does not synchronize on any source, it provides its own internal clock to the system. This mode can be used when the Option 11C is used as a master clock source for other systems in the network. Free-run mode is undesirable if the Option 11C is intended to be a slave. It can occur, however, when both the primary and secondary clock sources are lost due to hardware faults or when invoked by using software commands.

Clock controller functions and features

The NTAK79 clock controller functions and features include:

- phase lock to a reference, generate the 10.24 Mhz system clock, and distribute it to the CPU through the backplane. Up to two references at a time may be accepted.
- provide primary to secondary switchover (auto-recovery is provided)
- prevent chatter
- provide error burst detection and correction, holdover, and free running capabilities
- comply with 2.0Mb CCITT specifications
- communicate with software
- provide jitter filtering
- make use of an algorithm to aid in detecting crystal aging and to qualify clocking information

Reference switchover

Switchover may occur in the case of reference degradation or reference failure. When performance of the reference degrades to a point where the system clock is no longer allowed to follow the timing signal, then the reference will be said to be out of specification. If the reference being used is out of specification and the other reference is still within specification, an automatic switchover is initiated without software intervention. If both references are out of specification, the clock controller provides holdover.

Autorecovery and chatter

If the software command “track to primary” is given, the clock controller tracks to the primary reference and continuously monitors the quality of both primary and secondary references. If the primary becomes out of specification, the clock controller automatically tracks to secondary provided that it is within specifications. On failure (both out of specification), the clock controller enters the HOLDOVER mode and continuously monitors both references. An automatic switchover is initiated to the reference that recovers first. If the secondary recovers first, then the clock controller tracks to the secondary, but switches over to the primary when the primary recovers. If the primary recovers first, the clock controller tracks to the primary.

If the software command “track to secondary” is given, the clock controller tracks to the secondary reference and continuously monitors the quality of both primary and secondary references. If the secondary becomes out of specification, the clock controller automatically tracks to primary provided that it is within specifications. On failure (both out of spec.), the clock controller enters the HOLDOVER mode and continuously monitors both references. An automatic switchover is initiated to the reference that recovers first. If the primary recovers first, then the clock controller tracks to the primary, but switches over to the secondary whenever the secondary recovers. If the secondary recovers first, then the clock controller tracks to the secondary.

A time-out mechanism prevents chatter due to repeated automatic switching between primary and secondary reference sources.

Holdover and free-run

In the temporary absence of a synchronization reference signal, or when sudden changes occur on the incoming reference due to error bursts, the clock controller provides a stable holdover. The free-run mode is initiated when the clock controller has no record of the quality of the incoming reference clock.

If the software command “free run” is given, the clock controller enters the free-run mode and remains there until a new command is received. Note that the free-run mode of operation is automatically initiated after the clock controller is enabled.

Reference clock selection via software

The NTAK79 has the necessary hardware for routing its reference to the appropriate line on the backplane

Software is responsible for the distribution of the secondary references and ensures that no contention is present on the REFCLK1 backplane line. Software designates the NTAK79 as a primary reference source to the clock controller. The secondary reference is obtained from another NTAK79 card, which is designated by a craft person. No other clocks originating from other NTAK79 circuit cards are used.

The clock controller provides an external timing interface and is capable of accepting two signals as timing references. In this case, an external reference refers to an auxiliary timing source which is bridged from a traffic carrying signal. This is not intended to be a dedicated non-traffic bearing timing signal. The clock controller uses either the two external/auxiliary references or the NTAk79 references.

Chapter 32 — NTBK50 2.0 Mb PRI card

Contents

This section contains information on the following topics:

Overview	494
Functional description	494
Physical description	494
Power requirements	496
Environment	496
Architecture	496
DS-30X interface	497
Signaling interface	498
Carrier interface	499
Carrier grounding	499
CEPT transceiver	501
Slip control	501
D-channel support interface	501
Card-LAN interface	502

Overview

The NTBK50 card provides a 2Mb PRI interface and is installed in the main and IP expansion cabinets. The NTBK50 supports the NTAk20 clock controller daughterboard and either the NTAk93 D-Channel interface or the NTBK51 Downloadable D-Channel handler. The NTAk93 DCHI daughterboard provides identical performance to the on-board NTAk79 DCHI. The NTBK51 DDCH daughterboard provides support for protocols based on the MSDL platform.

Functional description

NTBK50 provides the following features and functions:

- recovery of the 2.048 kbps data by the CEPT receiver, at signal levels which have been attenuated by up to 10 dB
- control of CEPT line density using HDB3 which provides 64 kbps clear channel
- performance monitoring of the receive carrier by means of Bipolar Violations (BPV), Slips, CRC-4 (CRC), and Frame Bit Errors (FBER)
- monitoring of receive carrier alarms including AIS, LOS, and RAI
- transmission of remote alarm when instructed
- slip-buffering receive messages
- support of National and International bits in time slot 0
- clock controller daughterboard
- D-channel interface daughterboard
- Downloadable D-channel handler daughterboard
- 32 software-selectable Tx and Rx Pad values
- conversion of PCM commanding Laws (A-A, u-u, A-u, u-A)
- Card-LAN for maintenance communications

Physical description

The NTBK50 uses a standard IPE-sized (9.5" by 12.5"), multilayer printed circuit board. The faceplate is 7/8" wide and contains seven LEDs.

In general, the LEDs operate as shown in Table 153.

Table 153
NTBK50 faceplate LEDs (Part 1 of 2)

LED	State	Definition
OOS	On (Red)	The NTBK50 2.0 Mb PRI circuit card is either disabled or out-of-service. Also, the state of the card after power-up, completion of self test, and exiting remote loopback.
	Off	The NTBK50 2.0 Mb PRI is not in a disabled state.
ACT	On (Green)	The NTBK50 2.0 Mb PRI circuit card is in an active state.
	Off	The NTBK50 2.0 Mb PRI is in a disabled state. The OOS LED is red.
RED	On (Red)	A red alarm state has been detected. This represents a local alarm state of Loss of Carrier (LOS), Loss of Frame (LFAS) or Loss of CRC Multiframe (LMAS).
	Off	No red (local) alarm.
YEL	On (Yellow)	A yellow alarm state has been detected. This represents a remote alarm indication from the far end. The alarm may be either Alarm Indication (AIS) or Remote Alarm (RAI).
	Off	No yellow (remote) alarm.
LBK	On (Green)	2.0 Mb PRI is in loop-back mode.
	Off	2.0 Mb PRI is not in loop-back mode
CC	On (Red)	The clock controller is software disabled
	On (Green)	The clock controller is enabled and is either locked to a reference or is in free run mode

Table 153
NTBK50 faceplate LEDs (Part 2 of 2)

LED	State	Definition
	Flashing (Green)	NTAK20 is equipped and is attempting to lock (tracking mode) to a reference. If the LED flashes continuously over an extended period of time, check the CC STAT in LD60. If the CC is tracking this may be an acceptable state. Check for slips and related clock controller error conditions. If none exist, then this state is acceptable, and the flashing is identifying jitter on the reference.
	Off	The clock controller is not equipped.
DCH	On (Red)	DCH is disabled.
	On (Green)	DCH is enabled, but not necessarily established.
	Off	DCH is not equipped.

Power requirements

The NTBK50 obtains its power from the backplane, drawing maximums of 2 amps on +5 V, 35 mA on +15 V and 20 mA on -15 V.

Environment

The NTBK50 meets all applicable Nortel Networks operating specifications.

Architecture

The main functional blocks of the NTBK50 architecture include:

- DS-30X interface
- A07 signaling interface
- digital pad
- carrier interface
- CEPT transceiver
- SLIP control
- D-channel support interface

- clock controller interface
- Card-LAN / echo / test port interface
- 80C51FA Microcontroller

A description of each block follows.

DS-30X interface

NTBK50 interfaces to one DS-30X bus which contains 32 byte-interleaved timeslots operating at 2.56 Mb. Each timeslot contains 10 bits in A10 message format; 8 are assigned to voice/data (64 Kbps), one to signaling (8 Kbps), and one is a data valid bit (8 Kbps).

The incoming serial bit stream is converted to 8-bit parallel bytes to be directed to padding control. The signaling bits are extracted and inserted by the A07 signaling interface circuitry. Timeslots 0 and 16 are currently unused for PCM.

Digital PAD

Software selects A-law or Mu-Law and one of 32 possible PAD values for each channel. These values are provided in a PROM through which the data is routed. The idle code for A-law is 54H and for Mu-law is 7FH. The unequipped code is FFH for both A-law and Mu-law.

As the idle code and unequipped code may be country dependent, the software instructs the NTBK50 to use different codes for each direction. The 32 digital pads available are illustrated in Table 154 on page 498. The values shown are attenuation levels (1.0dB is 1dB of loss and -1.0dB is 1db of gain).

Table 154
Digital Pad - values and offset allocations

PAD SET 0		PAD SET 1	
Offset	PAD	Offset	PAD
0	0.6 dB	0	0.0 dB
1	1.0 dB	1	-1.0 dB
2	2.0 dB	2	-2.0 dB
3	3.0 dB	3	-3.0 dB
4	4.0 dB	4	-4.0 dB
5	5.0 dB	5	-5.0 dB
6	6.1 dB	6	-6.0 dB
7	7.0 dB	7	-7.0 dB
8	8.0 dB	8	-8.0 dB
9	9.0 dB	9	-9.0 dB
10	10.0 dB	10	-10.0 dB
11	11.0 dB	11	spare
12	12.0 dB	12	spare
13	13.0 dB	13	spare
14	14.0 dB	14	Idle Code
15	spare	15	Unassigned Code

Signaling interface

The Meridian 1 signaling interface consists of the A07 DS-30X signaling controller. This interface provides an 8 Kbps signaling link via the DS-30X timeslot zero data bit zero. Messages are 3 bytes in length.

Carrier interface

For the E-1 interface, the connection to the external digital carrier is provided by the line interface chip. This device provides accurate pulse shaping to meet the CCITT pulse mask requirements. It provides clock recovery functions on the receive side as well as tolerance to jitter and wander in the received bit stream.

Impedance matching (Switch SW2)

The line interface provides for the use of either 75ohm coaxial or 120ohm twisted pair cable. The impedance is selected by SW2, as shown in the settings table below.

Table 155
Impedance matching switch settings

Cable Type	SW 2-1
75 $\frac{3}{4}$	Down (On)
120 $\frac{3}{4}$	Up (Off)

Note: The ON position for all the switches is towards the bottom of the card. This is indicated by a white dot printed on the board adjacent to the bottom left corner of each individual switch.

Carrier grounding

NTBK50 provides for the capability of selectively grounding the shield of the Tx and/or Rx pairs of the carrier. Closing (down) the on-board switch will apply FGND to the appropriate carrier cable shield. The switch settings are shown below.

Carrier Shield grounding (Switch SW4)

Settings are shown in the Table below.

Table 156
Carrier shield grounding switch settings

Switch	Down (On)	Up (Off)
SW 4-1	Rx—FGND	Rx—OPEN
SW 4-2	Tx—FGND	Tx—OPEN

Note: The usual method is to ground the outer conductor of the receive coax signal.

Receiver functions

The receiver extracts data and clock from an AMI (Alternate Mark Inversion) coded signal and outputs clock and synchronized data. The receiver is sensitive to signals over the entire range of cable lengths and requires no equalization. The clock and data recovery meets or exceeds the jitter specifications of the CCITT recommendation G.823 and the jitter attenuation requirements of CCITT recommendation G.742. This provides jitter attenuation increasing from 0 dB to 60 dB over the frequency range from about 6 Hz to 6 KHz.

Transmitter functions

The transmitter takes the binary (dual unipolar) data from the PCM transceiver and produces bipolar pulses which conform to CCITT recommendation G.703 pulse shape.

Loopbacks

The remote loopback function causes the device to transmit the same data that it receives using the jitter attenuated receive clock. The data is additionally available at the receive data outputs. Local loopback causes the transmit data and clock to appear at the receive clock and data outputs. This data is also transmitted on the line unless transmit AIS is selected.

CEPT transceiver

The transmitter and receiver functions are used for synchronization, channel, and signal extraction. The functions meet applicable specifications of the CCITT recommendation G.703 & G.732.

The transceiver provides transmit framing based on the 2.048 MHz clock derived from the DS-30X system clock and 1KHZ framing pulse.

Slip control

Slip control provides organized recovery of PCM when the clock recovered from the external facility is at a different frequency with respect to the local clock.

D-channel support interface

The D-channel support interface is a 64 kbps, full-duplex serial bit stream configured as a DCE device. The data signals include: (1) Receive data output, (2) transmit data input, (3) receive clock output, and (4) transmit clock output. The receive and transmit clocks can be of slightly different bit rates from each other as determined by the transmit and receive carrier clocks.

The NTBK50 supports a daughterboard D-channel handler interface (DCHI). It is the equivalent to a single port of an NTAK02 SDI/DCH card. As well, the NTBK50 supports a Downloadable D-channel handler interface (DDCH). It will bring the MSDL D-channel capability into the Option 11C system.

DCHI Configuration for NTAK93 only (SW1)

The NTAK93 DCHI daughterboard can be operated in two separate modes as defined by an on-board dip switch. It can operate in a standard DCHI mode common to most ISDN standard countries. It can also operate in a U.K. specific mode using the DPNSS format. The DDCH will support only a single port which will directly interface to the PRI motherboard.

Table 157
Settings for the DCHI dip switch (SW1)

Switch	Function	On	Off
S1-1	—	—	—
S1-2	F/W Mode	DPNSS	DCHI

Card-LAN interface

A Dual Port UART handles the functions of the serial ports for the Card-LAN serial link test port interface. The test interface is an asynchronous 4800 bps 8 bit connected to port A of the UART. The card-LAN interface is an asynchronous 19.2 kbps 9 bit start/stop connected to port B of the UART.

The connection to the test port is available at the backplane/MDF connector.

The signals at this port conform to the EIA RS-232C standard.

Chapter 33 — NTAk20 clock controller

Contents

This section contains information on the following topics:

Overview	503
Clocking modes	504
Physical description	506
Faceplate LEDs	506
Functional description	506
Phase difference detector circuit	507
Digital phase lock loops	507
Digital to analog converter	509
CPU-MUX bus interface	510
Signal conditioning	510
Sanity timer	510
Microprocessor	510
External timing interface	511
Hardware integrity and regulatory environment	511

Overview

The NTAk20 clock controller daughterboard mounts directly on the following cards:

- NTAk09 1.5 Mb DTI/PRI card (page 447)
- NTBk50 2.0 Mb PRI card (page 493)

- NTBk22 MISP card (page 261)
- NTRB21 DTI/PRI/DCH TMDI card (page 461)

It is consequently located in slots 1 to 9 of the main and IP expansion cabinets and can support 1.5 Mb, 2.0 Mb, and 2.56 Mb clock recovery rates

Note: The card is restricted to slots 1 through 3 in EMC- type cabinets (such as NAK11Dx and NTAk11Fx cabinets). It will not work in slots 4 through 10 in these cabinets.

IMPORTANT

If an IP Expansion multi-cabinet system is equipped with digital trunk cards, it is mandatory that at least one trunk card is placed in the Main Option 11C cabinet. A cabinet that has a digital trunk must have a clock controller.

NTAk20 provides the following features and functions:

- phase lock to a reference, generation of the 10.24 Mhz system clock, and distribution of the clock to the CPU through the backplane
- accepts one primary and one secondary reference
- primary-to-secondary switchover and auto-recovery
- chatter prevention due to repeated switching
- error-burst detection and correction, holdover, and free running capabilities
- communication with software
- jitter filtering
- use of an algorithm to aid in detecting crystal aging and to qualify clocking information

Clocking modes

The clock controller can operate in one of two modes: tracking or non-tracking (also known as free-run).

Tracking mode

There are two stages to clock controller tracking:

- tracking a reference
- locking on to a reference.

When tracking a reference, the clock controller uses an algorithm to match its frequency to the frequency of the incoming clock. When the frequencies are very near to being matched, the clock controller is locked on to the reference. The clock controller will make small adjustments to its own frequency until both the incoming and system frequencies correspond.

If the incoming clock reference is stable, the internal clock controller will track it, lock on to it, and match frequencies exactly. Occasionally, however, environmental circumstances will cause the external or internal clocks to drift. When this happens, the internal clock controller will briefly enter the tracking stage. The green LED will flash momentarily until the clock controller is locked on to the reference once again.

If the incoming reference is unstable, the internal clock controller will continuously be in the tracking stage, with the LED flashing green all the time. This condition does not present a problem, rather, it shows that the clock controller is continually attempting to lock onto the signal. If slips are occurring, however, it means that there is a problem with the clock controller or the incoming line.

Free-run (non-tracking)

In free-run mode, the clock controller does not synchronize on any source, it provides its own internal clock to the system. This mode can be used when the Option 11C is used as a master clock source for other systems in the network. Free-run mode is undesirable if the Option 11C is intended to be a slave. It can occur, however, when both the primary and secondary clock sources are lost due to hardware faults or when invoked by using software commands.

Physical description

Faceplate LEDs

Each of the motherboards have 5 DTI/PRI LEDs and one clock controller LED. The CC LED is dual-color (red and green), with states represented as follows:

Table 158
Faceplate LEDs

State	Definition
On (Red)	NTAK20 is equipped and disabled.
On (Green)	NTAK20 is equipped, enabled, and is either locked to a reference or is in free run mode.
Flashing (Green)	NTAK20 is equipped and is attempting to lock (tracking mode) to a reference. If the LED flashes continuously over an extended period of time, check the CC STAT in LD60. If the CC is tracking this may be an acceptable state. Check for slips and related clock controller error conditions. If none exist, then this state is acceptable, and the flashing is identifying jitter on the reference.
Off	NTAK20 is not equipped.

Functional description

The main functional blocks of the NTAk20 architecture include:

- phase difference detector circuit
- digital phase-lock loop
- clock detection circuit
- digital-to-analog converter
- CPU MUX bus interface
- signal conditioning drivers and buffers
- sanity timer
- microprocessor

- CPU interface
- external timing interface

A description of each block follows.

Phase difference detector circuit

This circuit, under firmware control, allows a phase difference measurement to be taken between the reference entering the PLL and the system clock.

The phase difference is used for making frequency measurements, and evaluating input jitter and PLL performance.

Digital phase lock loops

The main digital PLL enables the clock controller. to provide a system clock to the CPU. This clock is both phase and frequency locked to a known incoming reference.

The hardware has a locking range of ± 4.6 ppm for Stratum 3ND and ± 50 ppm for Stratum 4 (CCITT).

A second PLL on board the clock controller provides the means for monitoring another reference. Note that the error signal of this PLL is routed to the phase difference detector circuit so the microprocessor can process it.

System clock specification and characteristics

Since the accuracy requirements for CCITT and EIA Stratum 3ND are so different, it is necessary to have two TCVCXO which feature different values of frequency tuning sensitivity.

Table 159
System clock specification and characteristics

Specifications	CCITT	EIA
Base Frequency	20.48 MHz	20.48 MHz
Accuracy	± 3 ppm	± 1 ppm
Operating Temperature	0 to 70 C ± 1 ppm	0 to 70 C ± 1 ppm
Drift Rate (Aging)	± 1 ppm per year	± 4 ppm in 20 years
Tuning Range (minimum)	± 60 ppm min. ± 90 ppm max.	± 10 ppm min. ± 15 ppm max.
Input Voltage Range	0 to 10 volts, 5V center	0 to 10 volts, 5V center

EIA/CCITT compliance

The clock controller complies with 1.5 Mb EIA Stratum 3ND, 2.0 Mb CCITT or 2.56 basic rate. The differences between these requirements mainly affect PLL pull in range. Stratum 4 conforms to international markets (2.0Mb) while stratum 3 conforms to North American market. (1.5 Mb).

Monitoring references

The primary and secondary synchronization references are continuously monitored in order to provide autorecovery.

Reference switchover

Switchover may occur in the case of reference degradation or loss of signal. When performance of the reference degrades to a point where the system clock is no longer allowed to follow the timing signal, then the reference is out of specification. If the reference being used is out of specification and the other reference is still within specification, an automatic switchover is initiated without software intervention. If both references are out of specification, the clock controller provides holdover.

Autorecovery and chatter

If the command “track to primary” is given, the clock controller tracks to the primary reference and continuously monitors the quality of both primary and secondary references. If the primary goes out of specification, the clock controller automatically tracks to secondary if that is within specifications. On failure (both out of specification), the clock controller enters the HOLDOVER mode and continuously monitors both references. An automatic switchover is initiated to the reference that recovers first. If the secondary recovers first, then the clock controller tracks to the secondary, but will switch over to the primary when the primary recovers. If the primary recovers first, the clock controller tracks to the primary and continues to do so even if the secondary recovers.

If the command “track to secondary” is given, the clock controller tracks to the secondary reference and continuously monitors the quality of both primary and secondary references. If the secondary goes out of specification, the clock controller automatically tracks to primary provided that is within specifications. On failure (both out of specification), the clock controller enters the HOLDOVER mode and continuously monitors both references. An automatic switchover is initiated to the reference that recovers first. If the primary recovers first, the clock controller tracks to the primary, but switches over to the secondary when the secondary recovers. If the secondary recovers first, the clock controller tracks to the secondary and continues to do so even if the primary recovers.

To prevent chatter due to repeated automatic switching between primary and secondary reference sources, a time-out mechanism of at least 10 seconds is implemented.

Digital to analog converter

The DAC (digital to analog converter) allows the microprocessor to track, hold, and modify the error signal generated in the digital PLL.

The firmware uses the available memory on board the clock controller to provide error-burst detection and correction. Temporary holdover occurs in the momentary absence of the reference clock.

Holdover and free-run

In the temporary absence of a synchronization reference signal, or when sudden changes occur on the incoming reference due to error bursts, the clock controller provides a stable holdover. The free-run mode is initiated when the clock controller has no record of the quality of the incoming reference clock

If the command “free run” is given, the clock controller enters the free-run mode and remains there until a new command is received. Note that the free-run mode of operation automatically initiates after the clock controller has been enabled.

CPU-MUX bus interface

A parallel I/O port on the clock controller. provides a communication channel between the clock controller and the CPU.

Signal conditioning

Drivers and buffers are provided for all outgoing and incoming lines.

Sanity timer

The sanity timer resets the microprocessor in the event of system hang-up.

Microprocessor

The microprocessor does the following:

- communicates with software
- monitors 2 references
- provides a self-test during initialization
- minimizes the propagation of impairments on the system clock due to errors on the primary or secondary reference clocks

Reference Clock Selection

The DTI/PRI card routes its reference to the appropriate line on the backplane. The clock controller distributes the primary and secondary references and ensures that no contention is present on the REFCLK1 backplane line. It designates the DTI/PRI mother board as a primary reference source. The secondary reference is obtained from another DTI/PRI card, which is designated by a craft person. No other clock sources are used.

External timing interface

The clock controller provides an external timing interface and can accept two signals as timing references. An external reference is an auxiliary timing clock which is bridged from a traffic carrying signal and is not intended to be a dedicated non-traffic-bearing timing signal. The clock controller uses either the external/auxiliary references or the DTI/PRI references.

Hardware integrity and regulatory environment

The clock controller complies with the following hardware integrity and regulatory specifications:

EMI FCC part 15 sub- part J

CSA C108.8

CISPR publication 22

ESD IEC 801-2

Temperature IEC 68-2-1

IEC 68-2-2

IEC 68-2-14

Humidity IEC 68-2-3

Vibration/Shock IEC 68-2-6

IEC 68-2-7

IEC 68-2-29

IEC 68-2-31

IEC 68-2-32

Chapter 34 — NTA93 D-channel handler interface

Contents

This section contains information on the following topics:

Overview	514
Features and functions	514
Physical description	514
Faceplate LEDs	515
Power consumption	515
Functional description	515
Microprocessors	515
DMA controller	515
Random Access Memory (RAM)	515
Read Only Memory (ROM)	516
LAPD Data Link/Asynchronous Controller	516
Counter/Timer controller	516
Software interface circuit	516
DPNSS/DCHI Port	516
D-Port — SDTI/PRI interface	517

Overview

The NTAk93 provides D-channel handler interfaces required by the ISDN PRI trunk. It performs D-channel layer 2 message processing and layer 3 preprocessing. It is a daughterboard that mounts to the NTAk09 1.5 Mb DTI/PRI card or NTBk50 2.0 Mb PRI card using standoff reference pins and connectors.

Features and functions

NTAk93 provides the following features and functions:

- D-channel or DPNSS interface
- special features included for LAPD implementation at DCH:
 - system parameters are service changeable (system parameters are downloaded from software)
 - incoming Layer 3 message validation procedures are implemented in the D-PORT firmware
 - supported message units and information elements may be service changed
 - translation of the CCITT message types information elements into a proprietary coding scheme for faster CPU operation
 - convention of IA5-encoded digits to BCD-encoded digits for incoming layer 3 messages for faster CPU operation
 - self-test
 - loopback

Physical description

The DCH function can be located in the main and IP expansion cabinets. The DTI/PRI card which carries a DCH daughterboard resides in the main and IP expansion cabinets.

Faceplate LEDs

NTAK09 1.5 Mb PRI and NTBK50 2.0 MB PRI cards

LEDs are located on the faceplate of the NTAK09 and NTBK50 cards. The DCH LED is dual-color (red and green), with states represented as follows:

Table 160
Faceplate LEDs

State	Definition
On (Red)	NTAK93 is equipped and disabled.
On (Green)	NTAK93 is equipped and enabled, but not necessarily established.
Off	NTAK93 is not equipped.

Power consumption

Power consumption is +5V at 750mA; +12V at 5mA; and -12V at 5mA.

Functional description

The main functional blocks of the NTAK93 architecture include the following.

Microprocessors

One microprocessor handles data transfer between each pair of serial ports and software, reports the status of each port and takes commands from software to control the activities of the ports. The microprocessors also do some of D-channel data processing in DCHI mode.

DMA controller

A Z80A-DMA chip controls the data transfer between local RAM memory and communication ports. Note that the DMA channels will only be used in the receive direction (from line to CPU), not in the transmit direction.

Random Access Memory (RAM)

A total of 32K bytes of RAM space for each pair of ports is used as the communication buffer and firmware data storage.

Read Only Memory (ROM)

A total of 32K bytes of ROM space for each pair of ports is reserved as a code section of the DCH-PORT firmware.

LAPD Data Link/Asynchronous Controller

One chip controls each pair of independent communication ports. It performs the functions of serial-to-parallel and parallel-to-serial conversions, error detection, frame recognition (in HDLC) function. The parameters of these functions are supplied by the DCH-PORT firmware.

Counter/Timer controller

Two chips are used as real-time timers and baud-rate generators for each pair of communication ports.

Software interface circuit

This portion of the circuit handles address/data bus multiplexing, the interchange of data, commands, and status between the on board processors and software. It includes transmit buffer, receive buffer, command register, and status register for each communication channel.

DPNSS/DCHI Port

The mode of operation of the DCH-PORT is controlled by a switch setting on the NTAk09/NTBK50. For DPNSS the switch is ON; for DCHI it is OFF.

The port will operate at:

Data Rate	56kbps, 64kbps
Duplex	Full
Clock	Internal / External
Interface	RS422

The address of ports is selected by hardwired backplane card address. Port characteristics and LAPD parameters are downloaded from software.

D-Port — SDTI/PRI interface

Below is a brief description of signals. When connected to SDTI/PRI, DCH-PORT is to be DTE.

- SDA, SDB: Transmit Clock provided by SDTI/PRI
- RTA, RTB: Receive Clock provided by SDTI/PRI
- RR, CS: SPDC ready signal provided by DCH-PORT
- TR: D-PORT ready signal provided by DCH-PORT
- RDA, RDB: Incoming serial data bit stream, driven by SDTI/PRI
- SDA, SDB: Transmit serial data bit stream driven by DCH-PORT

Chapter 35 — NTBK51 Downloadable D-channel handler

Contents

This section contains information on the following topics:

Overview	520
Features and functions	520
Physical description	520
Functional description	521
Microprocessors	521
Main Memory	522
Shared Memory	522
EPROM Memory	522
Flash EPROM Memory	522
EEPROM Memory	522
Serial Communication Controller	523
Sanity Timer	523
Bus Timer	523
Download Operation	523
System Initialization	523
Card enabling or application enabling	524
Card reset	524
Background audit	524

Overview

The NTBK51 provides Downloadable D-channel handler (DDCH) interfaces based on the Multipurpose Serial Data Link (MSDL). The DDCH provides a single purpose full-duplex serial port capable of downloading the D-channel application and base software into the card.

Features and functions

The NTBK51 provides the following features and functions:

- ISDN D-channel related protocol
- Selftest
- Loopback
- D-channel loadware including:
 - management and maintenance
 - LAPD- software for data link layer processing
 - Meridian 1 DCH interface
 - layer 3 preprocessor
 - traffic reporting including link capacity

Physical description

The Downloadable D-channel (NTBK51) is a daughterboard that mounts on either the NTAK09 1.5 DTI/PRI or the NTBK50 2 Mb PRI card. The DDCH, in conjunction with the NTAK09/NTBK50 circuit card, can reside in any physical slot 1-9 of the main cabinet and 11-19, 21-29, 31-39, or 41-49 of an IP Expansion cabinet.

LEDs are located on the faceplate of the NTAK09/NTBK50 card. The DCH LED is a dual-color (red/green), with the states represented as follows:

Table 161
Faceplate LEDs

State	Definition
On (Red)	NTBK51 is disabled.
On (Green)	NTBK51 is enabled, but not necessarily established
Off	NTBK51 is not equipped.

Functional description

The main functional blocks of the NTBK51 architecture include the following:

- Microprocessors
- Main memory
- Shared memory
- EPROM memory
- Flash EPROM memory
- EEPROM memory
- Serial communication controller
- Sanity timer
- Bus timer

Microprocessors

One microprocessor handles data transfer between each serial interface and software, reports the status of each port and takes commands from software to control the activities of the ports. A high performance MPU supports the D-channel from the PRI card and other software applications running simultaneously on other ports of the DDCH card.

The microprocessor performs the following functions:

- Sanity check and self tests
- Message handling between the Option 11C and the card
- Four port serial communication controller handling with DMA
- Program download from Option 11C CPU

Main Memory

The main 68EC020 system memory is comprised of 1 Mbyte of SRAM and may be accessed in either 8 or 16 bits. The software, base code and application, resides in main RAM and is downloaded from software through the shared memory.

Shared Memory

The shared memory is the interface between the Option 11C CPU and the 68EC020 MPU. This memory is a 16 Kbyte RAM, expandable to 64 Kbytes and accessible in either 8 or 16 bits.

EPROM Memory

The Bootstrap code resides in this 27C1000 EPROM and is executed on power up or reset.

Flash EPROM Memory

Flash EPROM provides non volatile storage for the DDCH loadware which will minimize the impact to sysload. The Flash EPROM, in reference to current devices, provides an increase in system service with a reduced delay after a brown-out and faster testing of a hardware pack after it is plugged in.

EEPROM Memory

The DDCH uses a 1,024 bit serial EEPROM for storing the NT product code and a revision level. This information can be queried by software.

Serial Communication Controller

The serial controller is the Zilog Z16C35 and is referenced as the Integrated Controller (ISCC). The ISCC includes a flexible Bus Interface Unit (BIU) and four Direct Memory Access (DMA) channels, one for each receive and transmit. The DMA core of the ISCC controls the data transfer between local RAM and the communication ports.

Sanity Timer

A sanity timer is incorporated on the DDCH to prevent the MPU from getting tied-up as the result of a hardware or software fault. The sanity timer permits the DDCH to reset itself should it enter into an infinite loop.

Bus Timer

The bus timer presents an error signal to the MPU if an attempt to access a device did not receive acknowledgment within the bus time-out period of 120 microseconds.

Download Operation

Downloading may be performed in either of two modes: background or maintenance. Before any downloading can take place, a D-channel link must be configured. The following situations may lead to software downloading:

- during initialization when new software is installed
- when enabling the card or application
- during card reset (due to loss of software, corruption)
- during a background audit

System Initialization

When new base or application software is installed on an Option 11C, the downloading decision is made during system initialization. Actual MSDL base software downloading is done in background mode which may take several minutes to complete, depending on the traffic of the switch and the size of the MSDL base software.

Card enabling or application enabling

If a normal download enable command is executed, the MSDL base code and application will be conditionally downloaded to the DDCH card. This conditional download will depend on the result of the check made by the Option 11C CPU on the MSDL base code and application software.

If a forced download enable command is executed in maintenance LD 96, the MSDL base code and application are forced down to the DDCH card, even if the base and application software is already resident on the DDCH card. In order to complete a forced download, the following conditions must be met:

- The DDCH card must be enabled
- The D-channel port must be disabled

Card reset

Following a card reset, the MSDL base code and the D-channel application software will be validated by the Option 11C CPU. Because software is stored in flash EPROM on the DDCH card it does not have to be downloaded. However, if the software is missing (due to new installation, corruption loadware version mismatch), the CPU will automatically download the base/application into the DDCH card.

Background audit

If during background audit of the card and associated applications it is found that downloading is required, the card is queued in the PSDL tree. Downloading is performed in background mode based on the entries in the PSDL tree.

Chapter 36 — NT5D14 Line Side T-1 card

Contents

This section contains information on the following topics:

Reference List	525
Overview	525
Physical description	526
Power requirements	527
Functional description	527
Architecture	528
Card interfaces	528
T-1 interface circuit	528
Signaling and control	528
Card control functions	528

Reference List

The following are the references in this section:

- *Line Cards: Description (553-3001-105)*

Overview

The line side T-1 card is an Intelligent Peripheral Equipment (IPE) line card that interfaces one T-1 line, carrying 24 channels to the Option 11C. This card occupies two card slots in the main or expansion cabinets. The line side T-1 card can be installed in the system's main cabinet or one of the expansion cabinets (there are no limitations on the number of cards that can be installed in the Option 11C system).

The line side T-1 card emulates an analog line card to the Option 11C system software; therefore, each channel is independently configurable by software control in the Single-line Telephone Administration program (LD 10). The line side T-1 card also comes equipped with a Man-Machine Interface (MMI) maintenance program. This feature provides diagnostic information regarding the status of the T-1 link.

Physical description

The line side T-1 card mounts into any two consecutive IPE slots. The card consists of a motherboard and a daughterboard; both are printed on standard circuit board.

In general, the LEDs operate as shown in Table .

Table 162
NT5D14AA Line Side T-1 Faceplate LEDs (Part 1 of 2)

LED	State	Definition
STATUS	On (Red)	The NT5D14AA card either failed its self-test or it hasn't yet been configured in software.
	Off	The card is in an active state
RED	On (Red)	A red alarm has been detected from the T-1 link. (This includes, but is not limited to: not receiving a signal, the signal has exceeded bit error thresholds or frame slip thresholds.)
	Off	No red alarm exists.
YEL	On (Yellow)	A yellow alarm state has been detected from the terminal equipment side of the T-1 link. If the terminal equipment detects a red alarm condition, it may send a yellow alarm signal to the line side T-1 card (this depends on whether or not your terminal equipment supports this feature).
	Off	No yellow alarm.

Table 162
NT5D14AA Line Side T-1 Faceplate LEDs (Part 2 of 2)

LED	State	Definition
MAINT	On (Red)	The card detects whether tests are being run or that alarms have been disabled through the Man-Machine Interface. The LED will remain lit until these conditions are no longer detected.
	Off	The line side T-1 card is fully operational

Power requirements

The line side T-1 card obtains its power from the Option 11C's backplane.

Line side T-1 card: power required

Table 163
Power requirements

Voltage	Current (max.)
5.0 V dc	150 mA.
+15.0 V dc	1.6 Amp
-15.0 V dc	1.3 Amp

Functional description

The NT5D14AA provides the following features and functions:

- Card interfaces
- T-1 interface circuit
- Signaling and control
- Card control functions
- Microcontroller
- Card LAN interface
- Sanity Timer
- Man-Machine Interface (MMI)

Architecture

Card interfaces

The line side T-1 card passes voice and signaling data over DS-30X loops through the DS-30X Interfaces circuits and maintenance data over the card LAN link.

T-1 interface circuit

The line side T-1 card contains one T-1 line interface circuit which provides 24 individually configurable voice interfaces to one T-1 link in 24 different time slots. The circuit demultiplexes the 2.56 Mbps DS-30X Tx signaling bitstreams from the DS-30X network loop and converts it into 1.544 MHz T-1 Tx signaling bitstreams onto the T-1 link. It also does the opposite, receiving Rx signaling bitstreams from the T-1 link and transmitting Rx signaling bitstreams onto the DS-30X network loop.

The T-1 interface circuit performs the following:

- Provides an industry standard DSX-1 (0 to 655 ft/200 meters) interface.
- Converts DS-30X signaling protocol into FXO A and B robbed bit signaling protocol.
- Provides switch-selectable transmission and reception of T-1 signaling messages over a T-1 link in either loop or ground start mode.

Signaling and control

The line side T-1 card also contains signaling and control circuits that establish, supervise, and take down call connections. These circuits work with the system controller to operate the T-1 line interface circuit during calls. The circuits receive outgoing call signaling messages from the controller and return incoming call status information to the controller over the DS-30X network loop.

Card control functions

Control functions are provided by a microcontroller and a Card LAN link on the line side T-1 card. A sanity timer is provided to automatically reset the card if the microcontroller stops functioning for any reason.

Microcontroller

The line side T-1 card contains a microcontroller that controls the internal operation of the card and the serial card LAN link to the controller card. The microcontroller controls the following:

- reporting to the CPU via the card LAN link:
 - card identification (card type, vintage, serial number)
 - firmware version
 - self-test results
 - programmed unit parameter status
- receipt and implementation of card configuration:
 - control of the T-1 line interface
 - enabling/disabling of individual units or entire card
 - programming of loop interface control circuits for administration of channel operation
 - maintenance diagnostics
- interface with the line card circuit:
 - converts on/off-hook, and ringer control messages from the DS-30X loop into A/B bit manipulations for each time slot in the T-1 data stream, using robbed bit signaling.
- the front panel LED when the card is enabled or disabled by instructions from the NT8D01 controller card.

Card LAN interface

Maintenance data is exchanged with the CPU over a dedicated asynchronous serial network called the Card LAN link.

Sanity Timer

The line side T-1 card also contains a sanity timer that resets the microcontroller in the event of a loss of program control. The microcontroller must service the sanity timer every 1.2 seconds. If the timer is not properly serviced, it times out and causes the microcontroller to be hardware reset.

Man-Machine Interface (MMI)

The line side T-1 card provides an optional man-machine interface that is primarily used for T-1 link performance monitoring and problem diagnosis. The MMI provides alarm notification, T-1 link performance reporting and fault isolation testing. The interface is accessed through connections from the I/O panel to a terminal or modem.

The MMI is an optional feature since all T-1 configuration settings are performed through dip switch settings or preconfigured factory default settings.

For more information on the Line Side T-1 card, refer to the *Line Cards: Description* (553-3001-105).

List of terms

This chapter lists, in alphabetical order, the acronyms and abbreviations used in this guide.

AC	Alternating Current
ACD	Automatic Call Distribution
ACD-C	ACD Management Reports
AHR	Ampere hour
AML	Application Module Link
APL	Auxiliary Processor Link
ATM	Automatic Trunk Maintenance
ATTN	Attendant Console
AUD	Audicron
AUX	Auxiliary
AWU	Automatic Wakeup
BARS	Basic Automatic Route Selection
BGD	Background Terminal
BIMP	Balance Impedance
BIU	Bus Interface Unit
BKO	LD 43 data dump command to copy the customer records in the Primary Flash drive to the PCMCIA device
BTU	British Thermal Unit
BUG	Software error
CAP	Central Answering Position
CAS	Centralized Attendant Service

CCBR	Customer Configuration Backup and Restore
CCITT	Comité Consultatif International Télégraphe et Téléphone
CCOS	Controlled Class of Service
CDP	Coordinated Dialing Plan
CDR	Call Detail Recording
CD-ROM	Compact Disk Read Only Memory
CEC	Canadian Electrical Code
CFCT	Call Forward by Call Type
CFNA	Call Forward No Answer
CMAC	ESN Communication Management Center
CMS	Command and status link
CO	Central Office
COM	Component
Conf	Conference
COS	Class of Service
CPG	Console Presentation Group
CPND	Call Party Name Display
CPU	Central Processing Unit
CSL	Command Status Link
CTY	CDR TTY port
CUST	Multi-Customer
DC	Direct Current
DCH	D-channel Handler
DDCH	Downloadable D-channel handler
DGT	Digital
DISA	Direct Inward System Access
DIG	Dial Intercom Group
DIP	Dial Pulse
DLC	Digital Line Card

DLI	Digital Line Interface
DN	Directory Number
DND	Do Not Disturb
DOD	Direct Outward Dialing
DPNSS	Digital Private Network Signalling System
DS	Data Service
DTE	Data Terminal equipment
DTI	Digital trunk Interface
DTMF	Dual Tone Multi Frequency
DTN	Digitone
DTR	Digitone Receiver
EAM	E&M 2 Wire
EBLF	Enhanced Busy Lamp Field
EDD	LD 43 data dump command to write the customer data in DRAM to the Primary and Backup flash drives on the NTDK20 SSC card
EFD	External Flexible DN
EFTC	Enhanced Flexible Tones and Cadences
EHOT	Enhanced Hot Line
EHT	External Hunt DN
EM4	E&M 4 Wire
EMI	Electromagnetic Interference
ESDI	Enhanced Serial Data Interface
ESN	Electronic Switched Network
EX4	4 Wire Duplex
FCA	Forced Charge Account
FCBQ	Flexible Call Back Queuing
FCC	Federal Communications Commission
FFC	Flexible Feature Code
FTC	Flexible Tones and Cadences
FX	Foreign Exchange

GRD	Ground Start
HDLC	High-Level Data Link Controller
HOT	Hot Line Services
HPIB	High Priority Input Buffers
ICT	Incoming Trunk
IMS	Integrated Messaging System
IPE	Intelligent Peripheral Equipment
ISA	Integrated Services Access
ISL	ISDN Signalling Link
ISDN	Integrated Services Digital Network
KLS	Key Lamp Strings
LAPD	Link Access Protocol D-channel
LAPW	Limited Access to Overlays
LCD	Liquid Crystal Display
LDR	Loop Dial Repeating
LED	Light Emitting Diode (lamp)
LLC	Line Load Control
LOP	Loop Start
LPIB	Low Priority Input Buffers
LSL	Low Speed Link
MF	Multi Frequency
MFC	Multifrequency Compelled Signaling
MFR	Multifrequency Receiver
MISP	Multi-Purpose ISDN Signaling Processor
MMI	Man-Machine Interface
MPDA	Meridian Programmable Data Adapter
MPU	Micro Processing Unit
MSDL	Multipurpose Serial Data Link
MTBF	Mean Time Between Failures

MTC	Maintenance
NARS	Network Automatic Route Selection
NCOS	Network Class of Service
NFCR	New Flexible Code Restriction
NTP	Nortel Networks technical publication
NTRF	Network Traffic
OAD	Outgoing Automatic Incoming Dial
ODAS	Office Data Administration System
OGT	Outgoing Trunk
OHQ	Off Hook Queuing
OPS	Off-Premise Station
OPTF	Advanced Features
PBX	Private Branch Exchange
PCM	Pulse Code Modulation
PFTU	Power Fail Transfer Unit
PMSI	Property Management System Interface
PPM	Periodic Pulse Metering
PRA	Primary Rate Access
PRI	Primary Rate Interface
RAN	Recorded Announcement
RAM	Random Access Memory
RMS	Room Status
ROM	Read Only Memory
SCC	Special Common Carrier
SCH	Service Change
SCI	Station Category Indication
SDI	Serial Data Interface
SILC	S/T Interface Line Cards
SR	Set Relocation

SWP	LD 43 data dump command to swap or exchange database records between the Primary Flash drive's main and secondary databases
TDS	Tone and Digit Switch
TIMP	Termination Impedance
TN	Terminal Number
TSET	Digital Set M3000 (Touchphone)
TTY	Teletype
UILC	U Interface Line Card
UPS	Uninterrupted Power Supply
VAS	Value Added Server
WATS	Wide Area Telephone Service
XEM	NT8D15 E&M Trunk Card
XMFC/MFE	Extended Multi-frequency Compelled/Multi-frequency sender-receiver
XMFR	Extended Multi-frequency receiver
XUT	NTD14 Universal Trunk Card

Index

Symbols

μ-Law, 158

Numerics

10baseT port, 219

A

ABCD

protected data store, 73

ACD

data store, 35

protected data store, 62, 72

ACD Enhancement

data store, 39

active state

M3820, M3310, M3110, 327

A-Law, 158

alerting tones

M3820, M3310, M3110, 330

AML

data store, 47

protected data store, 82

Analog (500/2500 type) telephones

protected data store, 53

Analogue Terminal Adapter (ATA), 316

ATM

protected data store, 67

Authorization Code

protected data store, 63

B

Balance

longitudinal, 174

BARS

protected data store, 59

battery backup time calculation, 110

BGD Automatic Timed Job

protected data store, 80

BLF/Console Graphics Module, 362

Brandline Inserts, 316, 328

Bus interface

CPU to MISP, 263

MISP network, 263

C

Call Park

data store, 39

Call Registers

data store, 37

Card slot assignments, 103

CardLAN, 457

cards

DLC (Digital Line Card), 320

ISDLC (Integrated Services Digital Line Card), 320

Circuit Card Power Consumption, 144

closet power supplies, 332, 333

Commands

CCBR, 16

data dump, 14

PRT PDV, 179

Communications software, 24

Coordinated Dialing Plan (CDP)

protected data store, 61, 79

cords

and TELADAPT snap-in connectors, 333

CPND
protected data store, 68

CPU capacity
real time, 25

Crosstalk, 174

custom labeling (logos) with Brandline Inserts, 316,
328

Customer Configuration Backup and Restore
(CCBR), 23

commands, 16

Customer data
protected data store, 70

D

Data

dump commands, 14
pre-programmed, 18
restoring, 18
storage, 14
trunk route, 20

Data store requirements, 30

ACD, 35
ACD Enhancement, 39
AML, 47
Call Park, 39
Call Registers, 37
DCH, 46
DCHI, 41
digital phone ports, 40
EBLF, 42
IMS, 39
Input/Output buffers, 41
ISDN, 42
juncture groups, 47
MFR, 47
NTRF, 36
trunk block, 34, 44
TTY block, 35
virtual terminal, 40

DCH

data store, 46
protected data store, 81, 82

DCHI

data store, 41

Dial intercom
protected data store, 58

Digital Line Card (DLC), 266

Digital telephone ports
data store, 40

Digitone receiver (DTR)
load capacity, 121
requirements, 99, 117

Direct Inward Dial, 385

Directory Number (DN)
protected data store, 56

DISA

protected data store, 63

DLC (Digital Line Card), 320

Downloadable D-channel handler, 520

DPNSS/DCHI Port, 516

DTI2

protected data store, 82

DTI/DLI

protected data store, 66, 81

E

EBLF

data store, 42

electromagnetic interference specifications
M3820, M3310, M3110 telephones, 329

EMC grounding clip, 213

Enhanced Flexible Tones and Cadences
protected data store, 72

environmental and safety considerations
M3820, M3310, M3110, 318, 329

ESDI settings, 240

European Digital telephones, 319

External Alerter interface, 316, 328

F

Failure rate, 191

FFC

protected data store, 73

FGD ANI

protected data store, 84

Fiber Expansion daughter boards, 210, 440

- NTDK22, 441
 - NTDK24, 441
 - NTDK79, 441
 - NTDK84, 441
 - NTDK85, 441
 - Fiber optic cable and interfaces, 439–446
 - Fiber Receiver cards, 216, 442
 - NTDK23, 442
 - NTDK25, 442
 - NTDK80, 442
 - Flexible Tones and Cadences (FTC)
 - protected data store, 72
 - Forecasting growth, 91
- G**
- Gain versus level variation, 169
 - Ground start, 385
 - Group delay and distortion, 173
 - Group DND
 - protected data store, 63
- H**
- High-Level Data Link Controller, 263
 - History file buffer
 - protected data store, 64
 - hold state
 - M3820, M3310, M3110, 327
- I**
- idle state
 - M3820, M3310, M3110 telephones, 327
 - IMS
 - data store, 39
 - protected data store, 65
 - Input and balance impedances, 166
 - Input/Output buffers
 - data store, 41
 - Intelligent Peripheral Equipment (IPE), 525
 - Intermodulation, 172
 - IP Expansion
 - Security device, 217
 - Storage and CPU capacity, 13
 - Transmission losses, 177
 - ISA_SID_MTHPTR fixed memory pointer, 70
 - ISDLC (Integrated Services Digital Line Card), 320
 - ISDN
 - BRI - protected data store, 74
 - data store, 42
 - PRA - protected data store, 69
 - PRI trunk, 514
 - ISL trunk TN table
 - protected data store, 70
- J**
- jacks
 - and TELADAPT snap-in connectors, 333
 - Junctor groups
 - data store, 47
- K**
- Key Expansion Module, 316
- L**
- LAPD Data Link/Asynchronous Controller, 516
 - LCD indicators
 - M3820, M3310, M3110, 327
 - Limited Access to Overlays (LAPW)
 - protected data store, 83
 - logos with Brandline Inserts, 328
 - Loop start, 385
 - Loss plan
 - insertion loss, 159
 - insertion loss limits, 164
- M**
- M2006, 284
 - M2008, 284
 - M2016S, 284
 - M2112
 - handsfree operation, 266
 - M2216ACD, 284
 - M2250 Attendant Console, 353–363
 - M2317, 271–281
 - M2616, 284
 - handsfree, 291
 - M3000 Touchphone, 309–318

- M3820, M3310, M3110, 319–334
 - environmental and safety considerations, 318, 329
 - line engineering, 318, 330
 - local alerting tones, 330
 - M3820, M3310, M3110 telephones, 331
 - M5317 BRI Terminal, 335–352
 - M5317TX, M5317TDX, 337
 - Memory requirement calculations, 110
 - Memory requirements, 14
 - Meridian Communications Adapter (MCA), 316
 - Meridian Digital Telephones, 265
 - Meridian digital telephones M3820, M3310, M3110, 327
 - Meridian Modular Telephones, 283–307
 - display module, 293
 - Key Expansion Module, 294
 - Meridian Programmable Data Adapter, 294, 306
 - message waiting feature, 326
 - MFC, 399
 - MFE, 402
 - MFR
 - data store, 47
 - protected data store, 80
 - Micro Processing Unit (MPU), 263
 - MISP, 261
 - Model telephones, 19
 - protected data store, 73
 - Model trunks
 - protected data store, 73
 - Multiple office code screening line
 - protected data store, 66
 - Multipurpose Serial Data Link (MSDL), 520
 - Multi-Tenant Service feature
 - protected data store, 67
- N**
- Name Display DMS feature
 - protected data store, 84
 - NARS
 - protected data store, 60
 - NAS
 - protected data store, 73
 - NFCR
 - protected data store, 65
 - Noise
 - Idle Channel, 168
 - Impulse, 169
 - NT1R20 Off Premise Station (OPS) analog line card, 423–??
 - NT5D14 Line Side T-1 card, 525–530
 - NT5K21 XMFC/MFE card, 399–407
 - NT6D70 SILC line card, 415–418
 - NT6D71 UILC line card, 419–421
 - NT8D02 Digital Line Card, 365–370
 - NT8D09 Analog Message Waiting Line Card, 371–376
 - NT8D14 Universal Trunk Card, 377–387
 - NT8D15 E&M Trunk Card, 389–398
 - NTAG26 XMFR card, 409–413
 - NTAK02 SDI/DCH card, 234
 - NTAK03, 244
 - NTAK03 TDS/DTR card, 231
 - NTAK09 1.5 DTI/PRI card, 447–454, 514, 520
 - NTAK09 1.5 Mb DTI/PRI card, 503
 - NTAK10 2.0 DTI card, 467–478
 - NTAK20 clock controller, 503–511
 - NTAK20 Clock Controller (CC) daughterboard, 465
 - NTAK75
 - dimensions, 195
 - spares planning, 195
 - NTAK75/QBL24A1
 - back-up time, 156
 - NTAK76
 - back-up time, 155
 - dimensions, 195
 - spares planning, 194
 - NTAK79 2.0 Mb PRI card, 479–491
 - NTAK93 DCH interface, 513–517
 - NTBK22 MISP card, 261, 504
 - NTBK45, 243
 - NTBK50 2.0 Mb PRI card, 503
 - NTBK50 2.0 PRI card, 493–502, 514, 520
 - NTDK01, 443
 - NTDK02, 443

-
- NTDK16 Digital Line Card, 365–370
 - NTDK20 SSC card, 15, 208–221
 - Conferencing, 219
 - Ethernet Interface, 219
 - Network Switching and signaling, 220
 - PCMCIA interface, 217
 - SDI ports, 218
 - Tone services, 221
 - NTDK20 System Core card, 243
 - NTDK22, 441
 - NTDK23, 241, 442
 - NTDK24, 441
 - NTDK25, 241, 442
 - NTDK79, 441
 - NTDK80, 241, 442
 - NTDK83, 443
 - NTDK84, 441
 - NTDK85, 441
 - NTDK97, 243
 - NTDK97 MSC card, 221–225
 - Conferencing, 224
 - Ethernet Interface, 224
 - Network Switching and signaling, 224
 - PCMCIA interface, 223
 - SDI ports, 223
 - NTDK99, 443
 - NTRB21 DTI/PRI/DCH TMDI card, 504
 - NTRB21 TMDI card, 455–466
 - NTRF
 - data store, 36
 - Numbering plan, 20

 - O**
 - ODAS
 - protected data store, 66
 - Off-Premise Station, 423

 - P**
 - Paging, 387
 - PCM channels, 265
 - Peripheral Equipment shelf, 320
 - Physical I/O table
 - protected data store, 82
 - Power Consumption, 144
 - Power Fail Transfer Unit (PFTU), 202
 - power requirements
 - for headsets, 331
 - M3820, M3310, M3110 telephones, 331
 - Power supplies, 197–204
 - Pre-programmed data, 18
 - benefits, 21
 - Model telephones, 19
 - Numbering plan, 20
 - removing, 23
 - SDI ports, 21
 - Tone and Digit Switch (TDS), 21
 - Trunk route data and model trunks, 20
 - PREXL_SCLN
 - protected data store, 71
 - PRI(2)
 - protected data store, 81
 - programmable keys
 - M3820, M3310, M3110, 327
 - Protected data store requirements, 48
 - ABCD, 73
 - ACD, 62, 72
 - AML, 82
 - Analog (500/2500 type) telephones, 53
 - ATM, 67
 - Authorization Code, 63
 - BARS, 59
 - BGD Automatic Timed Job, 80
 - Coordinated Dialing Plan (CDP), 61, 79
 - CPND, 68
 - customer data, 70
 - DCH, 81, 82
 - dial intercom, 58
 - Directory Number (DN), 56
 - DISA, 63
 - DTI2, 82
 - DTI/DLI, 66, 81
 - Enhanced Flexible Tones and Cadences, 72
 - FFC, 73
 - FGD ANI, 84
 - Flexible Tones and Cadences (FTC), 72
 - group DND, 63
-

- History file buffer, 64
- IMS, 65
- ISDN BRI, 74
- ISDN PRA, 69
- ISL trunk TN table, 70
- LAPW, 83
- MFR, 80
- model telephones, 73
- model trunks, 73
- multiple office code screening line, 66
- Multi-Tenant Service feature, 67
- Name Display DMS feature, 84
- NARS, 60
- NAS, 73
- NFCR, 65
- ODAS, 66
- physical I/O table, 82
- PREXL_SCLN, 71
- PRI(2), 81
- SDI, 82
- SL-1 sets, 76
- Speed Call
 - list, 58
 - package, 71
- System Speed Call List Head Table, 64
- template, 79
- tone detectors, 80
- TRUNK BARRING, 72
- trunk routes, 69
- VAS Data Services, 67
- virtual terminal, 85
- voice/data port, 66
- Provisioning, 87
 - comparative method, 93
 - conference/TDS loops, 108
 - default method, 96
 - line, trunk, and console load, 98
 - manual calculation, 95
 - number of IPE cards required, 103
 - number of loops required, 102
 - number of trunks, 97
 - total system load, 102
- Provisioning worksheets, 90

- A - Growth forecast, 135
- B - Total load, 137
- battery current and ac line calculation, 153
- battery current calculation, 154
- C - system cabinet requirements, 138
- D - unprotected memory calculations, 141
- E - protected memory calculations, 142
- F - equipment summary, 143
- G - system power consumption, 144
- total system power consumption, 151, 152
- PSDL, 457
- PVC cable, 330

R

- Receiver cards
 - NTDK23, NTDK25, and NTDK80, 241
- Recorded Announcement, 386
- Remote computer access, 25
- remote ringers, 316, 328
- Removing pre-programmed data, 23
- Reserve power, 203
- ringing state
 - on M3820, M3310, M3110, 327

S

- SDI
 - ports, 21, 227
 - protected data store, 82
- SL-1 sets
 - protected data store, 76
- Software delivery, see Pre-programmed data
- Spares planning, 187
 - definitions and assumptions, 188
 - failure rates, 191
 - NFT values, 193
 - NTAK75, 195
 - NTAK76, 194
- Speed Call list
 - protected data store, 58
- Speed Call package
 - protected data store, 71
- Spurious signal, 172
- SSC card, see NTDK20 SSC card

S/T Interface Line Cards (SILC), 415
SYSLOAD, 16
System Core and Controller cards, 207
System Power Consumption, 144
System Speed Call List Head Table
protected data store, 64

T

T-1, 525
TDS/DTR card, 243
TELADAPT connectors, 265
TELADAPT snap-in connectors, 333
temperature and humidity ranges for operations
Meridian digital telephones, 318, 329
Template
protected data store, 79
Tie Outgoing Automatic Incoming Dial, 386
Tie Two-way Dial Repeating, 386
Tone and Digit Switch (TDS), 21
Tone Detectors
protected data store, 80
transformers
local plug-in, 332
Transmission parameters, 157
distortion, 170
frequency response, 165
input and balance impedances, 166
loss plan, 159
return loss, 166
transhybrid loss, 167
TRUNK BARRING
protected data store, 72
Trunk block
data store, 34, 44
Trunk routes
protected data store, 69
TTY block
data store, 35

U

U Interface Line Card (UILC), 419

V

VAS Data Services
protected data store, 67
Virtual terminal
data store, 40
protected data store, 85
Voice/data port
protected data store, 66
volume control
M3820, M3310, M3110, 326

W

wiring and loop lengths
M3820, M3310, M3110, 333
M3820, M3310, M3110 telephones, 330, 331

Meridian 1
Option 11C and 11C Mini
Technical Reference Guide

Copyright © 1991–2002 Nortel Networks
All Rights Reserved

Information is subject to change without notice. Nortel Networks reserves the right to make changes in design or components as progress in engineering and manufacturing may warrant. This equipment has been tested and found to comply with the limits for a Class A digital device pursuant to Part 15 of the FCC rules, and the radio interference regulations of Industry Canada. These limits are designed to provide reasonable protection against harmful interference when the equipment is operated in a commercial environment. This equipment generates, uses and can radiate radio frequency energy, and if not installed and used in accordance with the instruction manual, may cause harmful interference to radio communications. Operation of this equipment in a residential area is likely to cause harmful interference in which case the user will be required to correct the interference at their own expense.

SL-1 and Meridian 1 are trademarks of Nortel Networks.

Publication number: 553-3011-100

Document release: Standard 14.00

Date: January 2002

Printed in Canada



Free Manuals Download Website

<http://myh66.com>

<http://usermanuals.us>

<http://www.somanuals.com>

<http://www.4manuals.cc>

<http://www.manual-lib.com>

<http://www.404manual.com>

<http://www.luxmanual.com>

<http://aubethermostatmanual.com>

Golf course search by state

<http://golfingnear.com>

Email search by domain

<http://emailbydomain.com>

Auto manuals search

<http://auto.somanuals.com>

TV manuals search

<http://tv.somanuals.com>