



Nortel Communication Server 1000

# Nortel Converged Office Fundamentals — Microsoft Office Communications Server 2007

---

NN43001-121

Document status: Standard  
Document version: 01.03  
Document date: 30 April 2008

Copyright © 2005–2008, Nortel Networks  
All Rights Reserved.

#### LEGAL NOTICE

While the information in this document is believed to be accurate and reliable, except as otherwise expressly agreed to in writing. NORTEL PROVIDES THIS DOCUMENT "AS IS" WITHOUT WARRANTY OR CONDITION OF ANY KIND, EITHER EXPRESS OR IMPLIED. The information and/or products described in this document are subject to change without notice.

Nortel, the Nortel logo, the Globemark, Meridian 1, and Succession are trademarks of Nortel Networks.

All other trademarks are the property of their respective owners.

Sourced in Canada

---

# Contents

---

<b>New in this release</b>	<b>9</b>
Office Communications Server 2007 features	9
Other changes	9
Revision History	10
<b>How to get help</b>	<b>11</b>
Getting help from the Nortel web site	11
Getting help over the telephone from a Nortel Solutions Center	11
Getting help from a specialist by using an Express Routing Code	11
Getting help through a Nortel distributor or reseller	12
<b>Introduction</b>	<b>13</b>
<b>Converged Office component overview</b>	<b>15</b>
Converged Office	15
Enterprise Voice	17
OCS 2007 Voice components	18
Media Gateways	19
Mediation Server	20
Remote Call Control with SIP CTI (TR/87)	22
Telephony Gateway and Services	23
Personal Call Assistant	25
Access Edge Server	27
OCS 2007 snap-in	27
Multimedia Convergence Manager	28
CDR data collection	28
SIP CTI (TR/87) Protocol	29
Hardware Load Balancer	31
Office Communicator 2007	32
Documentation References	32
<b>Planning and engineering</b>	<b>35</b>
Planning process	35
Network configuration	36
Multiple customer network	40
Multiple location network	42

Load Balancer planning	43
Load Balancer requirements	44
Redundancy with Load Balancers	45
Nortel Application Switch	46
Capacity planning	46
OC 2007 client requirements	47
Load Balancer capacity requirements	47
SIP CTI (TR/87) services requirements	47
Mediation server requirements	49
Signaling Server requirements	49
Call Server requirements	50
OCS Proxy and MCM capacity requirements	50
General requirements	51
Server topology	52
Operating System Requirements	52
Hardware Requirements	53
Virtual Server 2005	54
Storage	55
Trunks	55
Basic Client Configuration	58
Port use	58
Security	59
Dial Plan considerations	61
Number formats supported by Office Communicator	63
E.164 international format numbers for SIP Gateway and SIP CTI	66
Telephony Gateway and Services planning	66
Systems, platforms, and applications	66
Remote Call Control with SIP CTI	73
LCS 2005 and OCS 2007 coexistence	82
Client considerations	82
Converged Office functionality	82
MCM 2.0 to MCM 3.0	84
Load balancer considerations	84
Migration planning from LCS 2005 to OCS 2007	84
Determine your deployment options	86
Migration process	86
Description of Migration Phases	88
Unified Messaging	90
OCS 2007 users using CallPilot	90
OCS 2007 users using UM 2007—integrated	92
OCS 2007 users using UM 2007—non-integrated	95
Signaling with integrated Voice Mail	97
Signaling with non-integrated Voice Mail	98

<b>Installation</b>	<b>101</b>
OCS 2007 installation preparation and deployment	103
CS 1000 and Signaling Server installation	105
OCS 2007 component installation	105
OCS Proxy server installation	107
Load Balancer installation	108
MCM installation	109
<b>Configuration</b>	<b>111</b>
Active Directory configuration	112
Office Communications Server configuration	119
Load Balancer configuration	120
Voice Properties configuration	120
OCS configuration procedures	122
Configuration of Static Routes	122
Host Authorization and Routing configuration	122
Mediation Server configuration	133
MCM 3.0 configuration	134
MCM architecture	135
MCM Direct configuration	137
MCM management console	137
Telephony Gateway and Services configuration	150
Call Server configuration	151
Configuring the Codec	151
Loss Plan configuration	152
Dialing Plan configuration to route to MCM	153
Configuring the Personal Call Assistant	154
Caller ID table configuration	157
Home LOC and Home NPA configuration	159
DNS Server configuration	159
SIP Trunk configuration	160
Domain naming	163
URI Mapping	165
SIP Gateway CLID Parameters configuration	167
SPS configuration	168
NRS configuration	169
CDR configuration	170
E.164 International Format Numbers from Office Communicator - Computer Calls (SIP Gateway)	170
Phone number normalization	171
Remote Call Control configuration	171
Remote Call Control and PBX integration	171
RCC and PBX integration on OC client	172

- CS 1000 configuration 173
- Signaling Server configuration 177
- SIP CTI Services configuration settings 181
- SIP CTI CLID configuration parameters 185
- Configuring the SIP URI Map 189
- Configuring CDR 190
- Dialing E.164 International Format Numbers from Office Communicator - Phone Calls (SIP CTI) 190
- Normalizing phone numbers 192
- SIP Routing and Redundancy configuration 198
- OCS 2007 users using UM 2007 in integrated mode 198
  - Option 1 adding user Alias as Exchange UM 198
  - Option 2 adding CS 1000 DN as Exchange UM 203

---

**Maintenance** **209**

- Introduction 209
- Communication Server 1000 209
- MCM 3.0 209
- Remote Call Control 210
  - Operational Measurements for SIP CTI 212

---

**Troubleshooting** **215**

- Checking Telephony Gateway (SIP Gateway) configuration 215
- Checking Remote Call Control (SIP CTI) configuration 216
- Lack of memory on Signaling Server 216
- SIP CTI services does not come up 217
  - SIP Dialog not established 217
  - Solution 1: Check configuration parameters in AD 218
  - Solution 2: Confirm FQDN and the IP address are correct 218
  - SIP CTI service is down 218
- MCM not synchronizing new users in AD Cache mode 220
  - Solution 1: Check the Global Catalog content manually 220
  - Solution 2: Access permissions for the AD object properties 221
  - Solution 3: Enable propagation of the AD to the Global Catalog 222
- OC client not registered 223
- Pop-up not displayed 223
- Two pop-ups are displayed 224
- Delay for a SIP Gateway call 224
- Call Forward is cancelled by Office Communicator 224
- Office Communicator disconnecting from the network 225
- Capturing traces and logs 225
  - Communication Server 1000 traces 225
  - AML traces on the Call Server (SIP CTI only) 226
  - SIP CTI traces on the Signaling Server 226
  - SIP Gateway traces on the Signaling Server 227

---

MCM logs	228
Activating MCM logging	229
OCS logs	231
Case checklists	234
<b>Appendix A Call Flow and protocol details</b>	<b>237</b>
Contents	237
Overview	237
Message sequence	238
Call flow	239
Telephony Gateway and Services call flow	239
Supported features	246
<b>Appendix B Configuration Examples</b>	<b>249</b>
Contents	249
Introduction	249
Standard Edition	249
Setting up the lab	250
Collecting required data	251
Configuring the Call Server	252
Signaling Server checklist	262
Active Directory user configuration	269
Checking the MCM installation and configuration	272
Enterprise Edition	275
Overview of general lab set-up	275
OCS Management Console	278
Security/Certificates	282
Host Authorization	283
Routing	284
Configuring DNS	286
Active Directory configuration	288
Installing and configuring MCM	289
Signaling Server checklist	292
Configuring NRS	293
Normalizing Phone Numbers	295
<b>Appendix C Abbreviations</b>	<b>297</b>
<b>Procedures</b>	
Procedure	Migrating users from LCS to OCS 89
Procedure	Installing the OCS Proxy server 108
Procedure	Installing the Load Balancer 108
Procedure	Installing MCM 3.0 109
Procedure	Defining users 114
Procedure	Configuring the Host Authorization and Routing for the OCS Front End server 123
Procedure	Configuring host authorization for the OCS Proxy 126

Procedure	Configuring a Mediation Server	133
Procedure	Enabling replication to the Global Catalog	146
Procedure	Configuring the SIP Trunk Domain name	164
Procedure	Enabling Remote Call Control and PBX integration	171
Procedure	Adding a new normalization rule	195
Procedure	Configuring a basic mailbox for the UM user	199
Procedure	Adding user Alias as Exchange UM	199
Procedure	Configuring a basic mailbox for the UM user	203
Procedure	Adding Exchange UM	204
Procedure	Checking Telephony Gateway configuration	215
Procedure	Checking Remote Call Control configuration	216
Procedure	Reconfigure SIP CTI service	219
Procedure	Checking the Global Catalog content manually	221
Procedure	Accessing permissions for the AD object properties	222
Procedure	Enabling propagation of the Active Directory field to the Global Catalog	223
Procedure	Resetting MCM debug trace	231
Procedure	Activating OCS logs	232
Procedure	Enabling OC logs	232
Procedure	Setting up the lab	250
Procedure	Checking the Call Server configuration	252
Procedure	Checking the configuration of the Signaling Server	262
Procedure	Checking NRS configuration	266
Procedure	Checking the settings of Active Directory user configuration	269
Procedure	Checking the MCM installation and configuration	273
Procedure	Identifying the active default applications	280
Procedure	Checking the configuration of Certificates	282
Procedure	Checking the configuration of Host Authorization	283
Procedure	Checking that Routing is correctly configured	284
Procedure	Checking that DNS is correctly configured	286
Procedure	Checking that MCM is correctly installed and configured.	290
Procedure	Checking that the Signaling Server is correctly configured	293
Procedure	Checking that NRS is correctly configured	293



---

## New in this release

---

### Office Communications Server 2007 features

Signaling traffic between Communication Server 1000 and Office Communications Server 2007 is supported by Multimedia Convergence Manager (MCM) 3.0 . Media traffic is supported through the Mediation Server.

The following list shows new Office Communicator 2007 client features for Voice over IP (VoIP) mode:

- Conference Call
- Announced (Consulted) Call Transfer
- Call Forward
- Call Redirect (Deflect)
- Dual Forking
- DoNotDisturb (DND)
- Federated calls

### Other changes

- The Mediation Server is introduced in OCS 2007 as a new component. For more information about the Mediation Server, see "[Mediation Server](#)" ([page 20](#)). Due to the introduction of the Mediation Server, the following changes occur:
  - Transport Layer Security (TLS) and Secure Real-Time Transport Protocol (SRTP) are not supported.
  - OCS 2007 can talk to the Communication Server 1000 over a Transport Control Protocol (TCP) or Transport Layer Security (TLS) link. TLS transport is supported between MCM/OCS Proxy and CS 1000/SPS.
  - Video support for Session Initiation Protocol (SIP) gateway calls is not supported. Direct VOIP to VOIP and RCC to RCC calls can use video. For more information, see "[Feature Interactions](#)" ([page 68](#)).

- SIP UPDATE method is not supported by Mediation Server. This method enables SIP Gateways and Endpoints to update the call information during a call. Because the OCS 2007 Mediation Server does not support UPDATE, re-INVITE's need to be sent to the Mediation Server for every change in the call information during a call. This has not changed since LCS 2005. There were no interoperability issues.
- G.711 codec for the short leg (Mediation Server to Communication Server 1000) and RT audio for the long leg of a call (Mediation Server to OCS) is supported.
- The Nortel Multimedia Convergence Manager (MCM) 3.0 is introduced in Converged Office. For more information, see "[Multimedia Convergence Manager \(MCM\)](#)" (page 28).
- OCS 2007 snap-in for MMC. For more information, see "[OCS 2007 snap-in](#)" (page 27).
- The 8540 OCS desk phone can register as an OC 2007 client, however, Microsoft does not support using a CS 1000 twin phone with them.

### Revision History

**April 2008** Standard 01.03. This document is up-issued to correct the syntax in the Installing the OCS Proxy section.

**January 2008**

Standard 01.02. This document is up-issued for new content to address CRs, Unified Messaging, and LCS to OCS migration.

**December 2007**

Standard 01.01. This is a new document for Converged Office with Microsoft Office Communications Server 2007.

---

## How to get help

---

This chapter explains how to get help for Nortel products and services.

### Getting help from the Nortel web site

The best way to get technical support for Nortel products is from the Nortel Technical Support web site:

[www.nortel.com/support](http://www.nortel.com/support)

This site provides quick access to software, documentation, bulletins, and tools to address issues with Nortel products. From this site, you can:

- download software, documentation, and product bulletins
- search the Technical Support Web site and the Nortel Knowledge Base for answers to technical issues
- sign up for automatic notification of new software and documentation for Nortel equipment
- open and manage technical support cases

### Getting help over the telephone from a Nortel Solutions Center

If you do not find the information you require on the Nortel Technical Support web site, and you have a Nortel support contract, you can also get help over the telephone from a Nortel Solutions Center.

In North America, call 1-800-4NORTEL (1-800-466-7835).

Outside North America, go to the following web site to obtain the telephone number for your region:

[www.nortel.com/callus](http://www.nortel.com/callus)

### Getting help from a specialist by using an Express Routing Code

To access some Nortel Technical Solutions Centers, you can use an Express Routing Code (ERC) to quickly route your call to a specialist in your Nortel product or service. To locate the ERC for your product or service, go to:

[www.nortel.com/erc](http://www.nortel.com/erc)

## **Getting help through a Nortel distributor or reseller**

If you purchased a service contract for your Nortel product from a distributor or authorized reseller, contact the technical support staff for that distributor or reseller.

---

# Introduction

---

This document describes the elements and processes necessary to integrate Nortel Communication Server 1000 (CS 1000) with the Office Communications Server 2007 (OCS 2007) in the Nortel Converged Office.

## Prerequisites

- Ensure CS 1000 Release 5.0 and the Product Enhancement Package is installed.
- Microsoft supports the coexistence of LCS 2005 SP1 Standard Edition or Enterprise Edition with OCS 2007 Standard Edition or Enterprise pools. For more information, see "[LCS 2005 and OCS 2007 coexistence](#)" ([page 82](#)).

## Introduction navigation

- "[Converged Office component overview](#)" ([page 15](#))
- "[Planning and Engineering](#)" ([page 35](#))
- "[Installation](#)" ([page 111](#))
- "[Configuration](#)" ([page 119](#))
- "[Maintenance](#)" ([page 209](#))
- "[Troubleshooting](#)" ([page 215](#))
- [Appendix "Call Flow and protocol details"](#) ([page 237](#))
- [Appendix "Configuration Examples"](#) ([page 249](#))
- [Appendix "Abbreviations"](#) ([page 297](#))



---

# Converged Office component overview

---

This chapter provides a brief technical description of all the components associated with Nortel Converged Office.

## Component overview navigation

- ["Converged Office " \(page 15\)](#)
- ["Enterprise Voice " \(page 17\)](#)
- ["OCS 2007 Voice components" \(page 18\)](#)
- ["Media Gateways" \(page 19\)](#)
- ["Mediation Server" \(page 20\)](#)
- ["Remote Call Control with SIP CTI \(TR/87\)" \(page 22\)](#)
- ["Telephony Gateway and Services" \(page 23\)](#)
- ["Personal Call Assistant \(PCA\)" \(page 25\)](#)
- ["Access Edge Server" \(page 27\)](#)
- ["OCS 2007 snap-in" \(page 27\)](#)
- ["Multimedia Convergence Manager \(MCM\)" \(page 28\)](#)
- ["CDR data collection" \(page 28\)](#)
- ["SIP CTI \(TR/87\) Protocol" \(page 29\)](#)
- ["Hardware Load Balancer" \(page 31\)](#)
- ["Office Communicator 2007" \(page 32\)](#)
- ["Documentation References" \(page 32\)](#)

## Converged Office

Many Nortel CS 1000 customers base their multimedia strategy on deploying Office Communications Server (OCS) 2007 and the Office Communicator (OC) 2007 soft clients.

The Nortel Converged Office feature combines the business-grade telephony of the CS 1000 with the OCS 2007 Enterprise Voice solution to offer a powerful converged office solution set that improves worker productivity. Telepresence and Multimodal (business set Voice over Internet Protocol (VoIP), Instant Messaging (IM), and e-mail) communications bundles, with applications such as Click-to-call and Access mobility, allow workers to stay connected when not at their desks.

Nortel Converged Office comprises the following components:

- Remote Call Control (RCC) with Session Initiation Protocol Computer Telephony Integration (SIP CTI) (TR/87) provides full Microsoft Office telephony integration to control business-grade telephony phones from within Microsoft Office applications, as well as support for a standards-based CTI interface defined by the TR/87 protocol.
- Telephony Gateway and Services provides a basic SIP Telephony Gateway to connect between Private and Public Telephony networks and OC 2007 clients.

Nortel offers unique value with the two components that provide its telephony services to OC 2007 clients and connectivity between the Office Communications Server 2007 and the Nortel telephony network.

Nortel Converged Office provides the following benefits:

- federated IM with industry name instant messaging
- Microsoft application integration
- click-to-call commands and missed call log
- easy-to-use single soft client for IM, telepresence, and VoIP telephony presence integration with Microsoft desktop and applications
- a powerful suite of Nortel applications which include:
  - Nortel Unified Messaging
  - Contact Center
  - Interactive Voice Response (IVR)
  - conferencing
  - click-to-call

Leveraging the CS 1000 and Microsoft desktop software allows end users to access business-grade telephony services on the Nortel CS 1000 from the Microsoft Office Communicator desktop client. End users can:

- originate and receive telephone calls over existing CS 1000 phones from an Office Communicator (OC) 2007 desktop client.



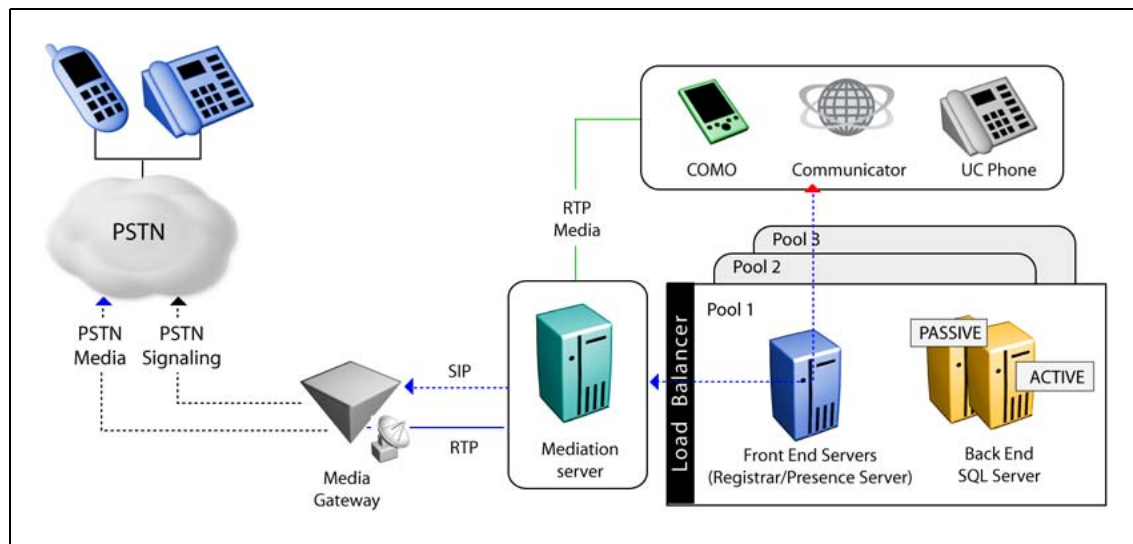
- originate and receive Public Switched Telephone Network (PSTN) calls from the Office Communicator (OC) 2007 soft client when away from the office.
- take advantage of existing business telephony features on the CS 1000.

## Enterprise Voice

This section describes the Office Communications Server (OCS) 2007 Enterprise Voice solution. The Nortel Converged Office feature integrates the OCS 2007 with the CS 1000. For a description of the integrated network from the CS 1000 perspective, see "[Network configuration](#)" (page 36). Enterprise Voice is Microsoft's software-powered VoIP solution, a SIP-based implementation of IP telephony for the enterprise that does not rely on proprietary hardware investments. Enterprise Voice is a full-featured VoIP solution that includes connectivity to the PSTN gateways and interoperability with the CS 1000. Enterprise Voice, IM, group IM, enhanced presence, and audio-video conferencing together constitute the Microsoft Unified Communications solution.

The following figure shows the OCS 2007 Enterprise Voice components extracted from the overall OCS 2007 architecture. COMO refers to Communicator Mobile.

**Figure 1**  
**Enterprise Voice components - OCS 2007**



When a user calls from an Enterprise Voice client by dialing or clicking on a contact name or number in OC 2007 or Outlook:

- the OCS Front End server normalizes the number to the E.164 format, and invokes routing rules based on the location profile and user policy, and directs the call to the appropriate Mediation Server

- the Mediation Server performs all necessary media transcoding and routes the call to the IP-PSTN gateway.
- the IP-PSTN gateway, based on topology, applies local or PBX dialing rules and passes the call to the PSTN or PBX

Enterprise Voice uses Real-Time Transport Protocol (RTP) for media. Like SIP, RTP is an Internet Engineering Task Force (IETF) standard. It defines a packet format to carry audio and video over IP networks.

Enterprise Voice uses SIP for signaling and RTP for media. In the OCS, SIP is used for IM, conferencing, presence subscriptions, video, and voice enabling Enterprise Voice clients to provide a common user experience across the communication modes.

Enterprise Voice is the Microsoft SIP-based implementation of IP telephony for the Enterprise.

SIP sessions can include the sharing of real-time media. However, SIP itself does not handle the actual media data, such as audio, video, and application sharing. This separation means that SIP and various media protocols can evolve independently.

## OCS 2007 Voice components

The core routing components for Enterprise Voice reside on the following:

- Standard Edition Server (in the role of Front End Server or Director)
- Enterprise Edition Front End Server

Other core routing server components include

- Translation Service—translates a dialed number into E.164 format based on the normalization rules defined by the administrator.
- Inbound Router—handles incoming calls according to user-specified preferences.
- Outbound Router—routes calls to CS 1000 or PSTN destinations after it applies authorization rules to callers and determines the optimal media gateway to route each call.

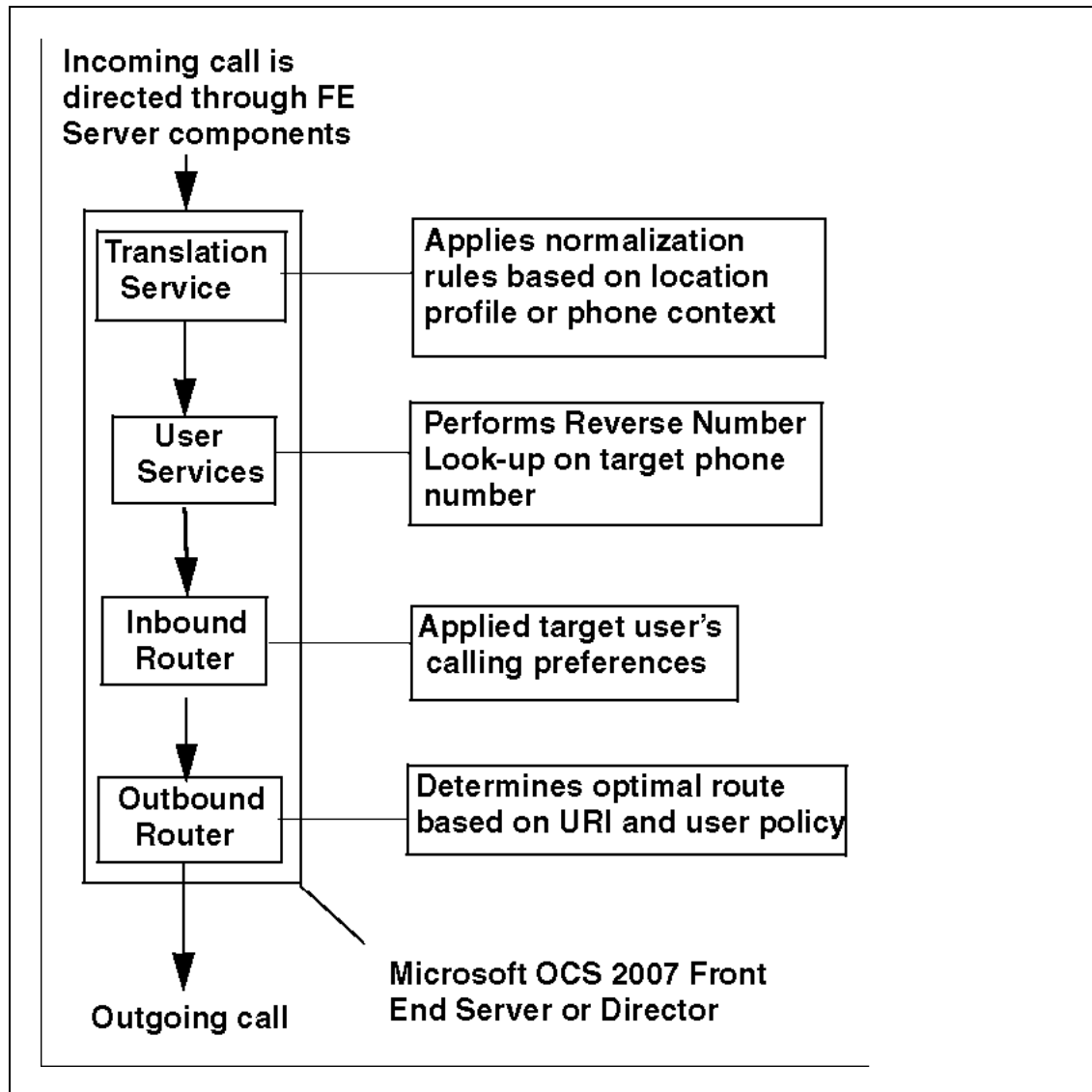
OCS 2007 Front End or Director components essential for voice support, but are not voice components include

- User Services—performs Reverse Number Look-up on the target phone number for incoming phone calls.
- User Replicator—extracts user phone numbers from the Active Directory for use by User Services and the Address Book Service.

- Address Book Service—normalizes enterprise user phone numbers to E.164 format to provision user Contacts in Office Communicator.

The following figure shows the components essential for voice support.

**Figure 2**  
Core routing server components



## Media Gateways

Media gateways are third-party hardware components that provide a common interface between the Enterprise Voice infrastructure and the PSTN. Media gateways translate signaling and media between the PSTN and Enterprise Voice infrastructure.

Media gateways translate the following protocols between the circuit-switched PSTN network and the packet-switched Enterprise Voice infrastructure:

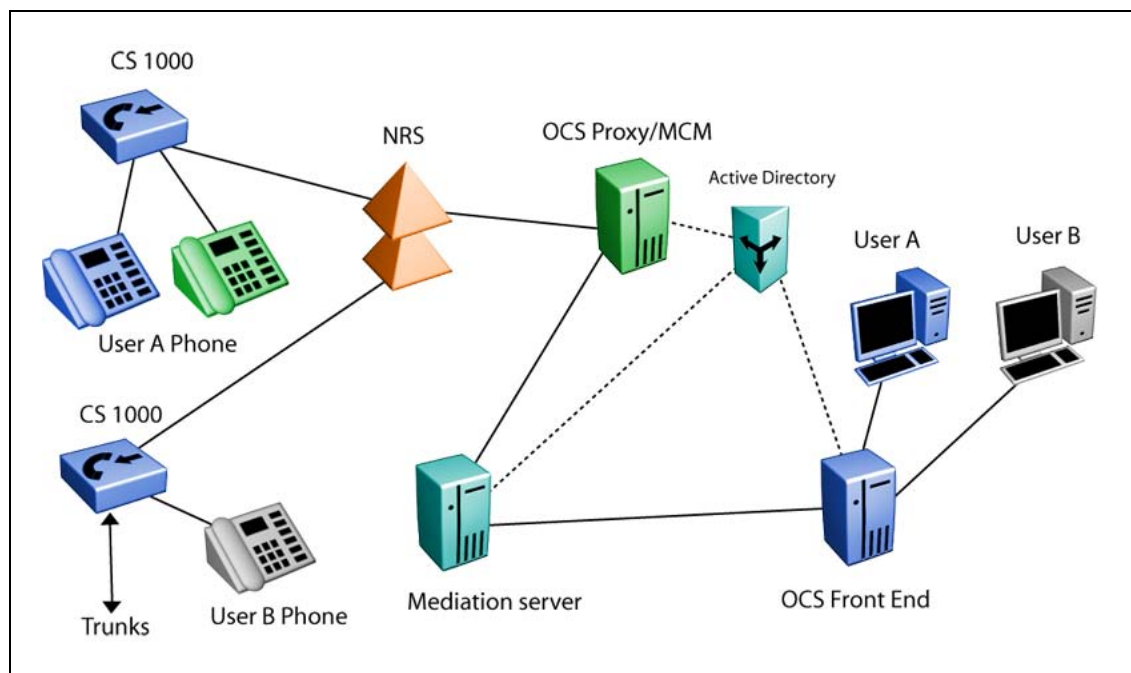
- Signaling protocol—SS7 and other protocols on the PSTN translate to SIP for Enterprise Voice
- Transport protocol—T-Carrier or E-Carrier on the PSTN convert to RTP or Secure Real-Time Transport Protocol (SRTP) for Enterprise Voice

From the Nortel perspective, the CS 1000 functions as a media gateway for the clients of the OCS 2007 server.

## Mediation Server

The Mediation Server provides signaling and media translation between the Enterprise Voice infrastructure and a CS 1000 gateway.

**Figure 3**  
CS 1000 and OCS 2007 logical network elements



The Mediation Server provides the following functions:

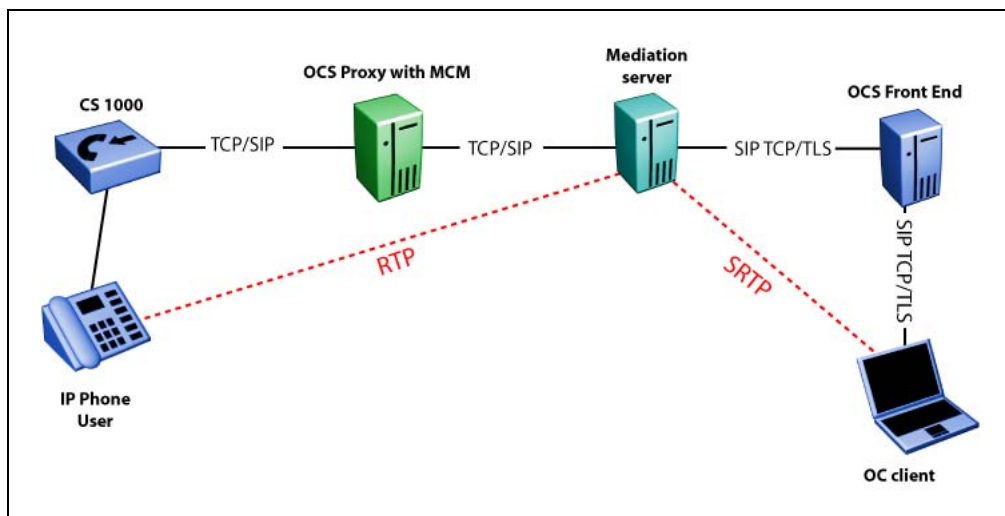
- translates SIP over Transport Control Protocol (TCP) (on the CS 1000 gateway side) to SIP over mutual Transport Layer Security (TLS) on the Office Communications Server side
- encrypts and decrypts SRTP on the Office Communications Server side
- translates media streams (G.711) on the CS 1000 gateway side and RT Audio on the Office Communication Server side

- connects clients outside the network to internal Interactive Connectivity Establishment (ICE) components, to enable media traversal of NAT and firewalls
- acts as an intermediary for call flows that a gateway does not support (such as calls from remote workers on an Enterprise Voice client)

The Mediation Server uses the following types of signaling:

- For an inbound call from the CS 1000, the `ms-call-source:non-ms-rtc` SIP header is inserted by the Mediation Server.
- For an inbound call from the CS 1000, the Mediation Server Back 2 Back User Agent (B2BUA) generates a Session Description Protocol (SDP) offer based on its capabilities in the OCS 2007.
- For an inbound call from the CS 1000, the Mediation Server adds a phone-context attribute to a number that is not in E.164 format.
- For an outbound call from an OC 2007 client, the Mediation Server Back 2 Back (B2B) terminates the dialog and originates a new dialog with the CS 1000. The From header is replaced with a phone number derived from the `p-asserted-identity` header.
- OC 2007 single step transfer. The Mediation Server terminates the REFER message and returns the response code 202. The Mediation server sends an INVITE message. The Mediation Server does not forward the REFER message to the CS 1000.

**Figure 4**  
**Signaling and Media path between the OC client and CS 1000**



## Remote Call Control with SIP CTI (TR/87)

The CS 1000 and OCS 2007 integration feature allows clients of the two systems (Microsoft OCS 2007 and Nortel CS 1000) to communicate with each other. You can associate an OC Client, which connects to the OCS, with a CS 1000 line. You can perform operations on the CS 1000 line through the OC Client using Remote Call Control (RCC) often referred to as Phone-Mode. This feature allows for consistent access to RCC, service control and configuration and telepresence functions across different endpoints supported by the CS 1000.

The Nortel Converged Office Solution is implemented through an open interface to ensure that any CS 1000 feature supported through OC 2007 is also accessible to applications from other vendors and application developers who support these interfaces.

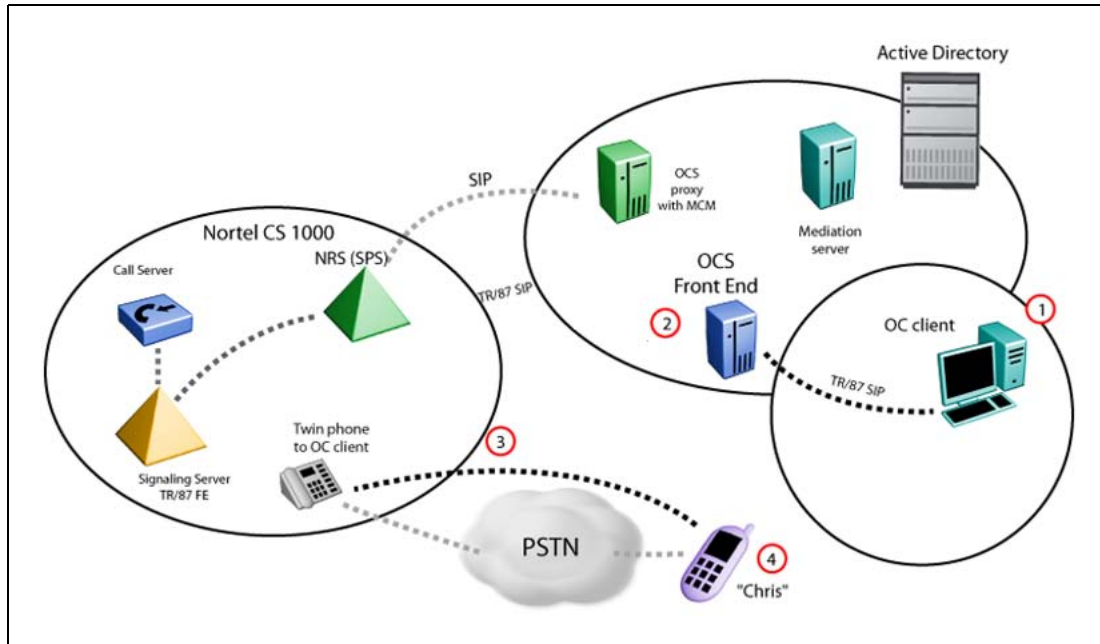
The SIP CTI (TR/87) protocol is on the CS 1000 Signaling Server. OC 2007 uses the TR/87 specification to implement phone integration throughout the suite of Microsoft Office applications. You cannot use Office Communicator to invoke a feature that is not supported by the phone.

### Example of RCC with SIP CTI (TR/87)

[Figure 5 "Remote Call Control with SIP CTI \(TR/87\)" \(page 23\)](#) shows an example of a CS 1000 call to a mobile client. The following steps correspond to the numbers in the figure:

1. A user selects Call to Chris' mobile phone number from the CS 1000 telephone.
2. The Office Communications Server 2007 sends a call request to the CS 1000.
3. The CS 1000 sets up a call from the user's phone to Chris' mobile phone number.
4. Chris answers his mobile phone and a media path is established between the two phones.

**Figure 5**  
**Remote Call Control**



The full set of business-grade telephony features available with CS 1000 telephones is integrated with the OC 2007 client and can also be operated from a CS 1000 IP Phone, even when the client is unavailable. This integration ensures that telephony service reliability is preserved during interruptions in soft client operation.

With the convergence of the CS 1000 with the OCS 2007, the OC 2007 client complements the voice communications between two users by allowing other media types, such as IM, file, and application sharing to an existing voice call without the need to establish an independent session between the users.

## Telephony Gateway and Services

With the Telephony Gateway and Services component, users can choose how to make and receive calls. For outgoing calls, users can make a call from their Office Communicator soft client instead of their CS 1000 phone. You can handle incoming calls in one of two ways: through the computer with OC 2007 or through a phone. This feature provides users with computer-to-phone and phone-to-computer connectivity, leveraging the Nortel provided dial plan, telephony infrastructure, and telephony features to make and receive calls using Office Communicator (OC) 2007 Client as a soft client.

With this solution, you can configure Personal Call Assistant (PCA) on the CS 1000 for each user with this functionality. The CS 1000 configured with the PCA provides number plan translations, Call Detail Recording (CDR) for outgoing calls, and enables telephony features, such as Call forward No Answer to Voice Mail, Attendant Recall, and participation as a client in a Group Call for incoming calls.

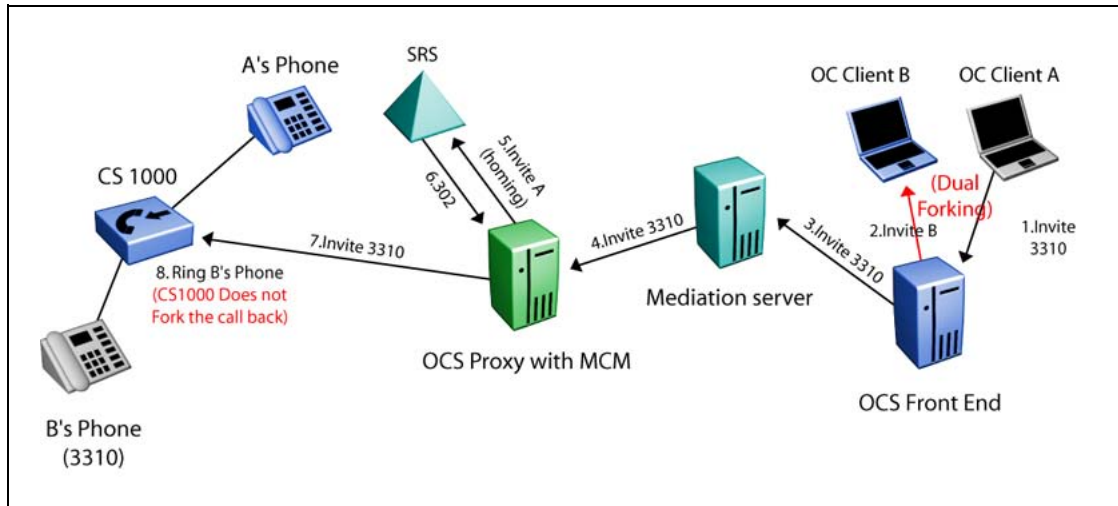
With the Telephony Gateway and Services component, you can configure the OC 2007 as a Multiple Appearance Directory Number (MADN) member for users with PCA on the CS 1000. With PCA, calls to a user's phone number can be presented to both the desktop phone and to the OC 2007 client simultaneously. The user can then choose to answer on the most convenient device.

The ability to connect between computers and phones is not natively provided by Office Communications Server 2007; however, the Telephony Gateway and Services component enables this functionality using the SIP Gateway and Multimedia Convergence Manager (MCM) application. MCM directs calls from an Office Communicator user to the CS 1000 connected to their twinned telephone. Telephony Gateway and Services allows you to originate and receive SIP calls (for example, VoIP and Computer calls) from Office Communicator.

In [Figure 6 "Dual forking example" \(page 25\)](#), OCS Front End (FE) forks the call to the CS 1000. The twin phone rings once and does not send another invite. The same scenario applies to calls originating from the CS 1000, the OCS does not get informed to perform another fork. A new setting is introduced on OCS 2007 server that enables or disables dual forking for each user. Remote Call Control (SIP CTI) is available when dual forking is enabled.



**Figure 6**  
Dual forking example



## Personal Call Assistant

Many of the features provided by CS 1000 to traditional telephones are extended to Office Communicator clients configured with the Personal Call Assistant (PCA). For example, calls that remain unanswered can be forwarded using the Call Forward No Answer feature.

To use the Office Communicator soft client for voice calls using the Telephony Gateway and Services, a PCA must be configured with the same DN as the user in a MADN arrangement. This offers incoming voice calls to the user's DN on their Office Communicator, as well as any phones that they have been configured with the same DN.

For incoming calls to be extended to the "twinned" Office Communicator client, a PCA Terminal Number (TN) must be defined for that DN. A new PCAM Class of Service prompt has been introduced so a distinction is made between PCA associated with the OCS 2007 client and PCA associated with other types of clients. Class is configured using BCC. For more information on BCC, see Basic Client Configuration (BCC). PCA associated with the OCS 2007 client, the class is set to PCAM. Other types of clients use the default class PCAG. During call processing, the class is checked to determine whether an incoming call should be extended to the PCA target DN or not. For more information on configuring PCA, see *Features and Services* (NN43001-106).

For outgoing calls from the Office Communicator, the user must have at least one TN configured on the CS 1000 Call Server. The MCM locates the Call Server associated with a user by their numbering plan entry in the NRS. This generates calls from Office Communicator clients on Telephony

Gateway and Services to always tandem through the user's active Call Server. Note that with Geographic Redundancy features, a user's active Call Server may change during failure scenarios.

The Network Class of Service (NCOS) setting for outgoing calls from Office Communicator clients is determined by the configuration of the MARP TN when in a MADN group, or by the configuration of the PCA when it is the only TN for the user.

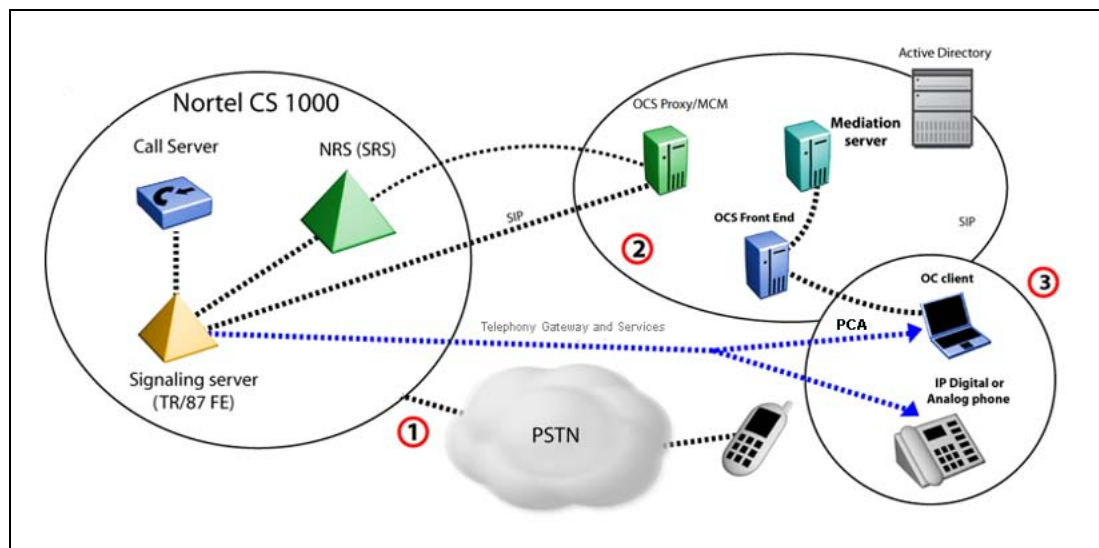
With PCA and Remote Call Control configured, users receive one pop-up window for the incoming call to the phone or computer. Users can choose the most convenient way to answer an incoming call.

#### Personal Call Assistant (PCA) service

While at the office, a user may decide to use a desktop phone to answer calls. However, the user can still accept calls through the OC 2007 while they travel to locations that have network connectivity (for example, at hotels).

The following steps correspond to the numbers in the figure:

1. The CS 1000 system receives a PSTN call to the user's phone number.
2. The CS 1000 uses the PCA feature to provide simultaneous ringing to both the user's phone and the Office Communicator voice client.
3. The user can answer the call through the CS 1000 phone or the Office Communicator voice client.



Users can be reached anywhere on the network and significant cost savings are incurred by using IP telephony through Virtual Private Network (VPN) access to their private network.

As part of the telephony services, many incoming call features are available even when using the OC 2007 as a telephony device or more

specifically in Computer mode. Features such as Call Forward No Answer, Unified Messaging, Call Detail Recording, and Attendant Recall are maintained within the CS 1000 system for calls presented to the OC 2007.

Telephony Gateway and Services can access all of the telephony network resources using the OC 2007 client. Calls can originate from the OC 2007 client to the PSTN, phones, or services within the telephony network. Users can access all of their telephony network resources as long as they have the soft client and a high-quality connection to their private network. Telephony Gateway and Services is enabled by the interworking of the CS 1000 SIP Gateway with the OCS 2007 SIP gateway software.

## Access Edge Server

Access Edge Servers allow internal and external users to communicate across corporate firewalls. Access Edge Servers enable IM and presence, as well as Web conferencing and audio/video (A/V) collaboration between internal and external users.

Access Edge Servers include the following server roles deployed on one or more computers in the perimeter network:

- The Access Edge Server handles the SIP traffic necessary to establish and validate connections between internal and external users.
- The Web Conferencing Edge Server enables external users to participate in internal conference meetings. The Web Conferencing Edge Server handles the exchange of meeting content between internal and external users.
- The Audio/Video (A/V) Edge Server enables A/V conferencing between internal and external users to allow for the sharing of audio and video with external users.

Microsoft recommends that you use the OCS 2007 Director, although it is not required.

### ATTENTION

Office Communicator video is supported only for Remote Call Control between two Office Communicator clients. Office Communicator video is not supported if one of the clients goes through the SIP Gateway.

## OCS 2007 snap-in

The Office Communications Server 2007 snap-in for MMC is redesigned. The Status pane of the Office Communications Server 2007 snap-in provides configuration settings at-a-glance for your forest, domains, pools,

servers, and users. The Status pane also features a new Database tab, which can be used to query a pool's back-end databases. Each query is displayed as an expandable item in a list.

Microsoft Management Console (MMC) is automatically installed on each server in the domain that is running Office Communications Server 2007 or any computer on which Office Communications Server 2007 administrative tools are installed. It is not used to administer Edge Servers or Proxy Servers.

#### **ATTENTION**

Enhanced presence must be enabled prior to Converged Office telephony integration. You can enable enhanced presence from the Office Communications Server Users Wizard in the Configure Users Settings window.

## **Multimedia Convergence Manager**

MCM 3.0 is a software component that ensures interoperability between the Nortel CS 1000 and the Microsoft Office Communicator Server (OCS) 2007. The MCM ensures CS 1000 and OCS interoperability of protocols, users, and phone numbers are managed within the Microsoft Active Directory. It also allows the system to block calls where the client is not in the Active Directory (AD). The MCM performs a number of functions that include:

- translation between telephony phone numbers and user IDs within the Active Directory
- authentication of user phone numbers for RCC
- Numbering Plan normalization
- protocol interworking
- redundant connections to the CS 1000 network components (SIP Redirect Service (SRS), Sip Proxy Server (SPS), and redundant Signaling Servers)

## **CDR data collection**

OCS 2007 supports CDR capability. OCS 2007 CDRs collect different kinds of data that include user logon and logoff, IM and audio call details, Conferencing start and join. You must install the Archiving and CDR Server to support these features. The outgoing calls from the OC 2007 to CS 1000 telephone are captured by this server, as well as OC to OC calls. Thus a call accountant can retrieve CDRs from both the CS 1000 and Archiving server to obtain a consolidated report. In RCC mode, CDRs are captured only on the CS 1000 side. For more information, see *Microsoft Office Communications Server 2007 Archiving and CDR Server Deployment Guide* Download Microsoft technical documentation from the Download Center at [www.microsoft.com](http://www.microsoft.com).

## SIP CTI (TR/87) Protocol

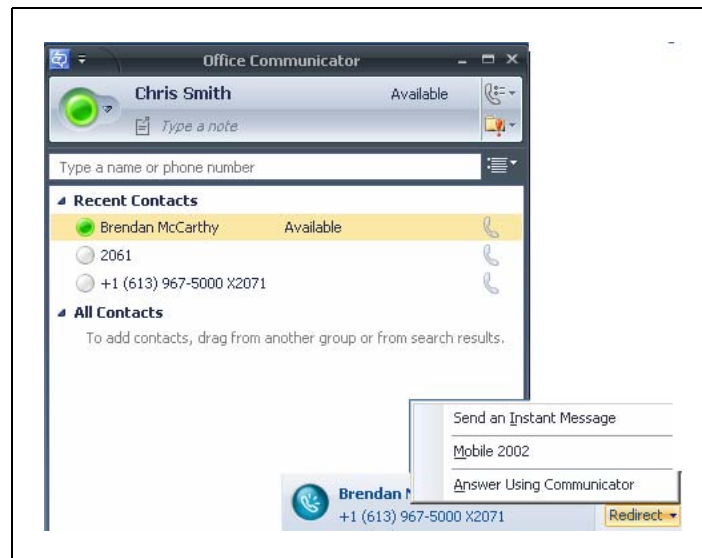
The SIP CTI (TR/87) FE application introduced with this package is not limited to Microsoft applications. Through support of the ECMA TR/87 standard, Nortel partners can use this interface to develop SIP CTI capabilities for use with any specification-compliant application.

If Preferred Calling Device is configured as Phone, a user receives one pop-up notification with an incoming call, as depicted in [Figure 7 "Call Appearance pop-up window"](#) (page 29). The OC user can click Redirect to choose the client as the answering device.

Certain portions of the protocol are not supported at this time. Additional information about the SIP CTI (TR/87) protocol is available to Nortel partners upon request.

[Figure 7 "Call Appearance pop-up window"](#) (page 29) shows an example of an incoming call pop-up window.

**Figure 7**  
**Call Appearance pop-up window**



[Figure 8 "SIP diagram"](#) (page 30) depicts the SIP protocol information.

**Figure 8**  
**SIP diagram**

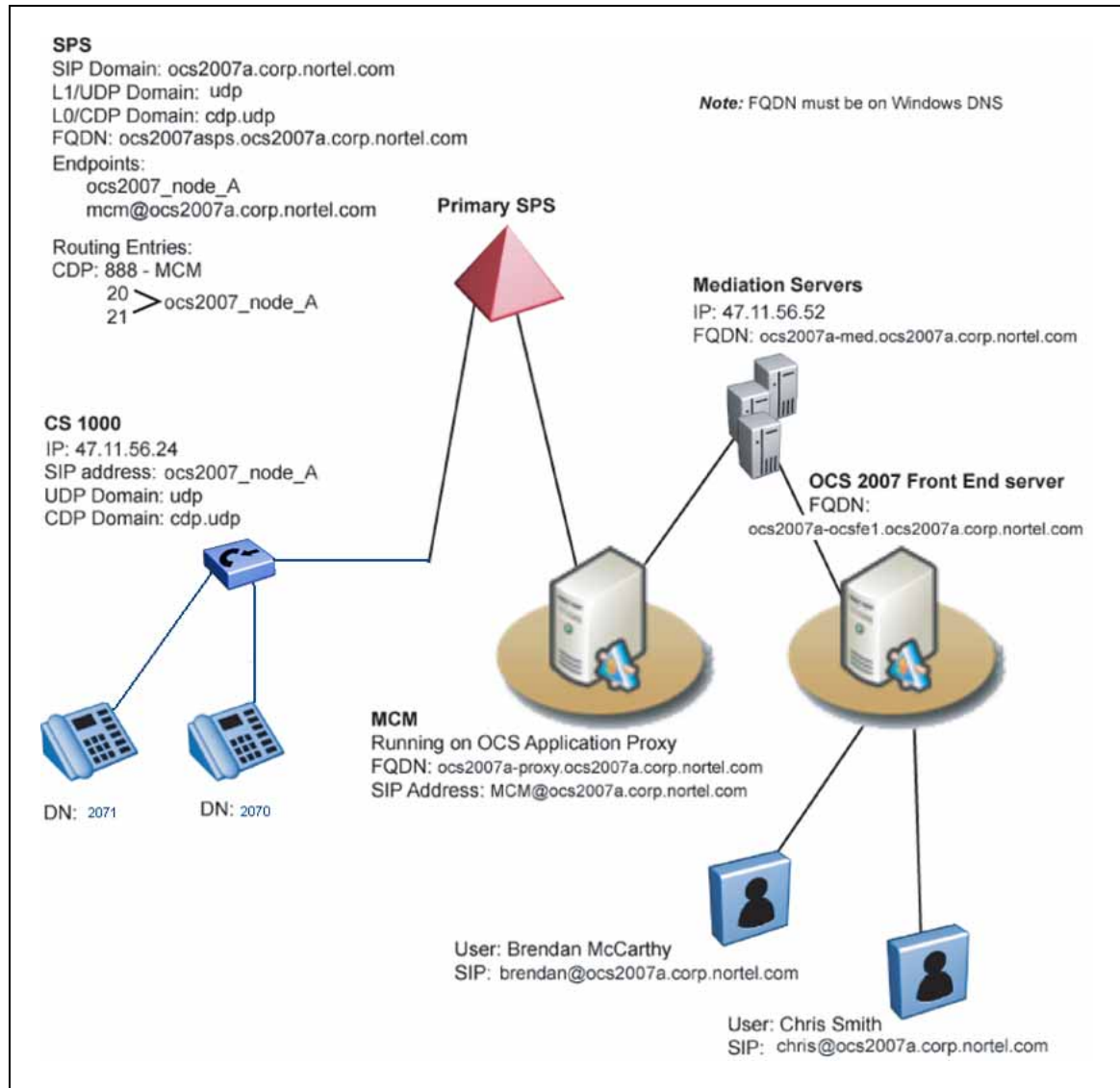
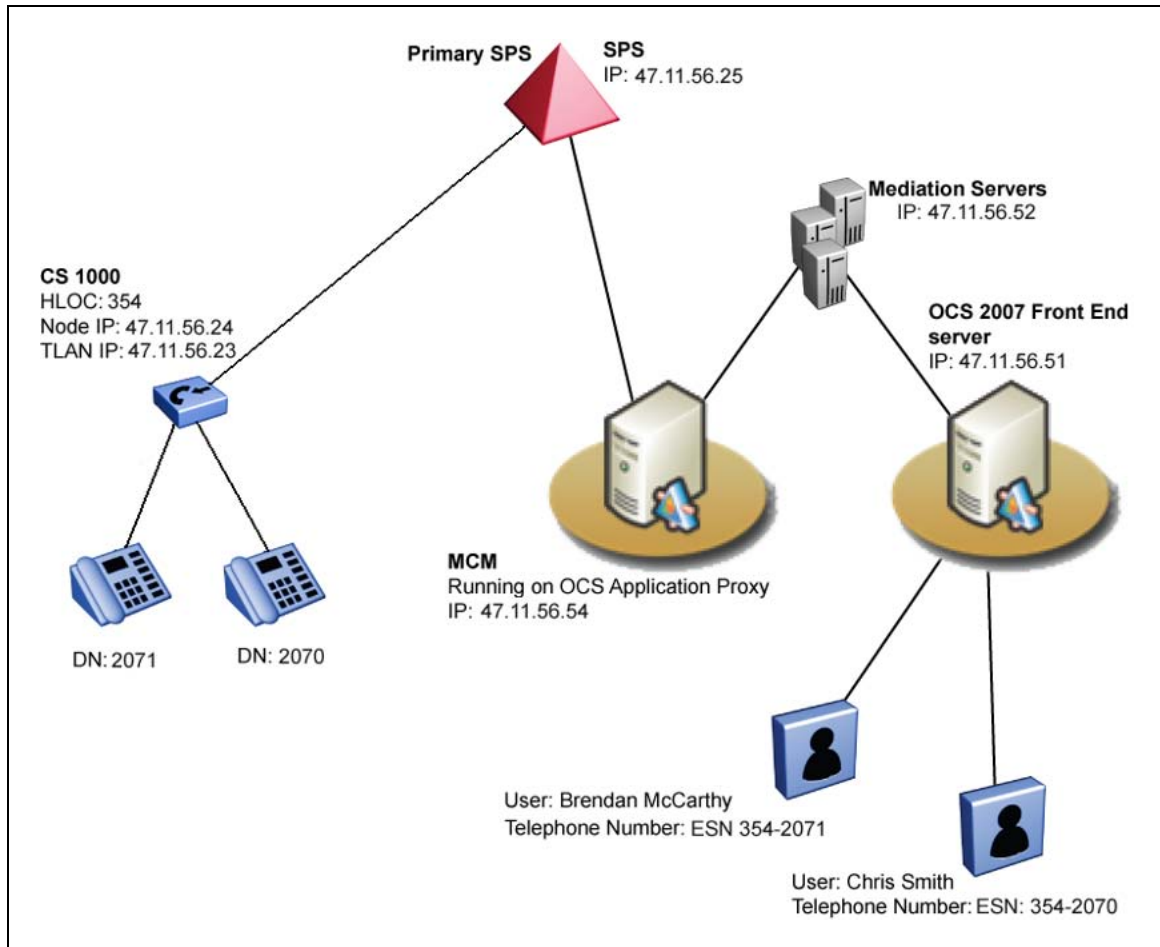


Figure 9 "IP diagram" (page 31) depicts the IP protocol information.

**Figure 9**  
IP diagram



### ATTENTION

Customers must not use their Office Communicator client to call Emergency numbers (for example, 911). To ensure that emergency service organizations can accurately trace the source of the call, always use a desktop phone to place an emergency call.

## Hardware Load Balancer

Hardware IP Load Balancers (for example, Nortel Application Switches) are required for multiple Office Communications Server 2007 Enterprise Edition deployment. The Load Balancer presents a single virtual IP (VIP) address to clients to prevent direct access to individual OCS 2007 Enterprise Edition servers. The Load Balancer uses an algorithm (for example, round-robin, or fewest connections) to route new client requests to the Office Communications Servers.

Hardware Load Balancers deliver load distribution to avoid a single point of failure. Other benefits include increased performance and added redundancy. The CS 1000 uses Load Balancers for the signaling path of VoIP calls and Remote Call Control.

A Load Balancer is not required if you deploy:

- a Standard Edition server
- a single Enterprise Edition Front End server

A load balancer is required if you deploy:

- multiple OCS 2007 Enterprise Edition Front End servers
- an Array of Edge Servers
- an Array of Directors in OCS 2007

Microsoft recommends deploying a hardware load balancer for arrays of Office Communications Server 2007, Edge Servers, and Directors but it is not a requirement. Office Communications Server 2007 does not support the use of Windows Server 2003 Network Load Balancer in production or lab deployments. The CS 1000 is only concerned with the load balancers for the signaling path for VoIP and Remote Call Control (RCC).

### Office Communicator 2007

For detailed information about using Office Communicator 2007 and its components, see *Converged Office User Guide — Microsoft Office Communications Server 2007* (NN43001-123).

### Documentation References

A list of Nortel and Microsoft documentation is available for reference from the following Web sites.

- You can download Nortel documentation from the Nortel technical documentation Web site at [www.nortel.com](http://www.nortel.com).
- Download Microsoft technical documentation from the Download Center at [www.microsoft.com](http://www.microsoft.com).

The following Nortel technical documents are relevant to Nortel Converged Office.



**Table 1**  
**Nortel technical documentation**

Technical document	Content	Primary audience
<i>Converged Office User Guide — Microsoft Office Communications Server 2007</i> (NN43001-123)	Contains information about using the OC client.	General users
<i>Communication Server 1000E Planning and Engineering</i> (NN43041-220)	Contains instructions about calculating the anticipated call traffic for the CS 1000.	Administrators
<i>Features and Services</i> (NN43001-106)	Contains information about the Multiple Customer environment, Multiple Appearance DN , Call Forward On feature, and defining and configuring a PCA TN.	Administrators
<i>CallPilot Network Planning Guide</i> (NN44200-201 )	Contains information about configuring CallPilot for Telephony Gateway (Computer mode) calls.	Administrators
<i>Communication Server 1000M and Meridian 1 Small System Installation and Commissioning</i> (NN43011-310)	Contains information about CS 1000 Installation and Commissioning	Administrators
<i>Communication Server 1000M and Meridian 1 Large System Installation and Commissioning</i> (NN43021-310)	Contains information about CS 1000 Installation and Commissioning	Administrators
<i>Communication Server 1000E Installation and Commissioning</i> (NN43041-310)	Contains information about CS 1000 Installation and Commissioning	Administrators
<i>Signaling Server Installation and Commissioning</i> (NN43001-312)	Contains information about CS 1000 Installation and Commissioning	Administrators
<i>IP Peer Networking Installation and Commissioning</i> (NN43001-313)	Contains information about creating the required components on a Call Server, dialing plans, configuring codecs, configuring HLOC and HNPA, configuring SIP trunks, configuring NRS, and alternate routing logic (for Geographic Redundancy).	Administrators

Technical document	Content	Primary audience
<i>Transmission Parameters (NN43001-282)</i>	Contains information about configuring the loss plan and DTI Data Bock.	Administrators
<i>Element Manager System Administration (NN43001-632)</i>	Contains information about how to access Operational Measurements through Element Manager.	Administrators
<i>NRS Installation and Commissioning (NN43001-564)</i>	Contains procedural information.	Administrators
<i>Communication Server 1000 with Microsoft Exchange Server 2007 Unified Messaging Fundamentals NN43001-122</i>	Contains information about how to setup Unified Messaging on Microsoft Exchange.	Administrators

**Table 2**  
**Microsoft OCS 2007 and OC 2007 documentation**

Guide	Contents	Primary audience
<i>Microsoft Office Communications Server 2007 Documentation Roadmap</i>	Guide to the contents and uses of the documentation.	Administrators
<i>Office Communications Server 2007 Technical Overview</i>	Contains a high-level survey and summary of the features, architecture, and protocols of Office Communications Server 2007.	Administrators
<i>Microsoft Office Communications Server 2007 Planning Guide</i>	Contains step-by-step information about planning your deployment.	Senior Administrators responsible for planning deployment
<i>Microsoft Office Communications Server 2007 Enterprise Voice Planning and Deployment Guide</i>	Contains information on how to plan, deploy, and manage the new Enterprise Voice capabilities in Office Communications Server 2007.	Administrators and Telephony Engineers responsible for planning an IP telephony infrastructure and deploying Enterprise Voice
<i>Microsoft Office Communicator 2007 Getting Started Guide</i>	Contains information on how to get started with Office Communicator 2007.	End-users and Administrators
<i>Office Communicator 2007 Quick Reference Cards</i>	Contains a summary of information for Office Communicator 2007.	End-users and Administrators
<i>Migrating to Microsoft Office Communications Server 2007</i>	Contains information on migrating from LCS 2005 to OCS 2007.	Administrators

---

# Planning and engineering

---

This chapter contains information about topics you must consider before you implement Converged Office.

## Planning and engineering navigation

- "Introduction" (page 35)
- "Network Design" (page 36)
  - "Small network" (page 37)
  - "Medium network" (page 38)
  - "Large network" (page 39)
  - "Multiple customer network" (page 40)
  - Figure 14 "Multiple location network" (page 42)
- "Load Balancer planning information" (page 43)
- "Capacity Planning" (page 46)
- "General Requirements" (page 51)
- "Telephony Gateway and Services planning" (page 66)
- "Remote Call Control with SIP CTI" (page 73)
- "LCS 2005 and OCS 2007 coexistence" (page 82)
- "Migration planning from LCS 2005 to OCS 2007" (page 84)

## Planning process

Before you install and configure Nortel Converged Office, you must consider the network size and its impact on the type of software and hardware required.

Nortel recommends that you implement the Telephony Gateway and Services component to provide basic connectivity (which you can more readily debug), followed by the Remote Call Control (RCC) for more complex feature operation. Configure both Telephony Gateway and Services and RCC only in situations where both components are required.

Consider the following during the planning process.

- Consider the size of your network. See "[Network Design](#)" (page 36) for detailed information about determining your network architecture.
- Determine the type of users (internal and external users) and anticipated call traffic. For more information about type of users, see [Table 5 "Maximum supported users for each topology"](#) (page 52). For information about calculating the anticipated call traffic for the Communication Server 1000, see *Communication Server 1000E Planning and Engineering* (NN43041-220).
- Determine that the software and hardware components required for the CS 1000 are installed and have the latest software versions. For more information, see "[CS 1000 and Signaling Server installation](#)" (page 105).
- Determine that the software and hardware components required for Office Communications Server (OCS) 2007 have the latest software versions. For more information, see "[OCS 2007 component installation](#)" (page 105).
- Determine the system requirements for the OC 2007 client. For more information, see "[OC 2007 client requirements](#)" (page 47).
- Determine capacity requirements for all components. For more information, see "[Capacity Planning](#)" (page 46).
- Prepare your infrastructure.
- Plan for external user setup. For more information, see "[Access Edge Server](#)" (page 27).
- Plan your implementation strategy.

For more information on deploying OCS 2007, see the *Microsoft Office Communications Server 2007 Planning Guide*. Download Microsoft documentation from the Download Center at [www.microsoft.com](http://www.microsoft.com).

## Network configuration

The main consideration when you plan and engineer the Converged Office desktop is the size of the network. Networks are divided into three main categories: small, medium, and large. Each type requires specific configuration.

The following sections describe typical network topologies to assist in determining capacity and robustness requirements.

---

**Note:** The descriptions and graphical representations of the three network types are for illustration only, and are not actual configurations. The number of CS 1000 systems and Office Communications Server 2007 servers will be based on the engineering guidelines found in this document and those provided by Microsoft.

### Small network

If you have a small network that requires ease of management, you can choose a basic configuration. Microsoft recommends the following configuration for small organizations that do not require high availability for OCS 2007.

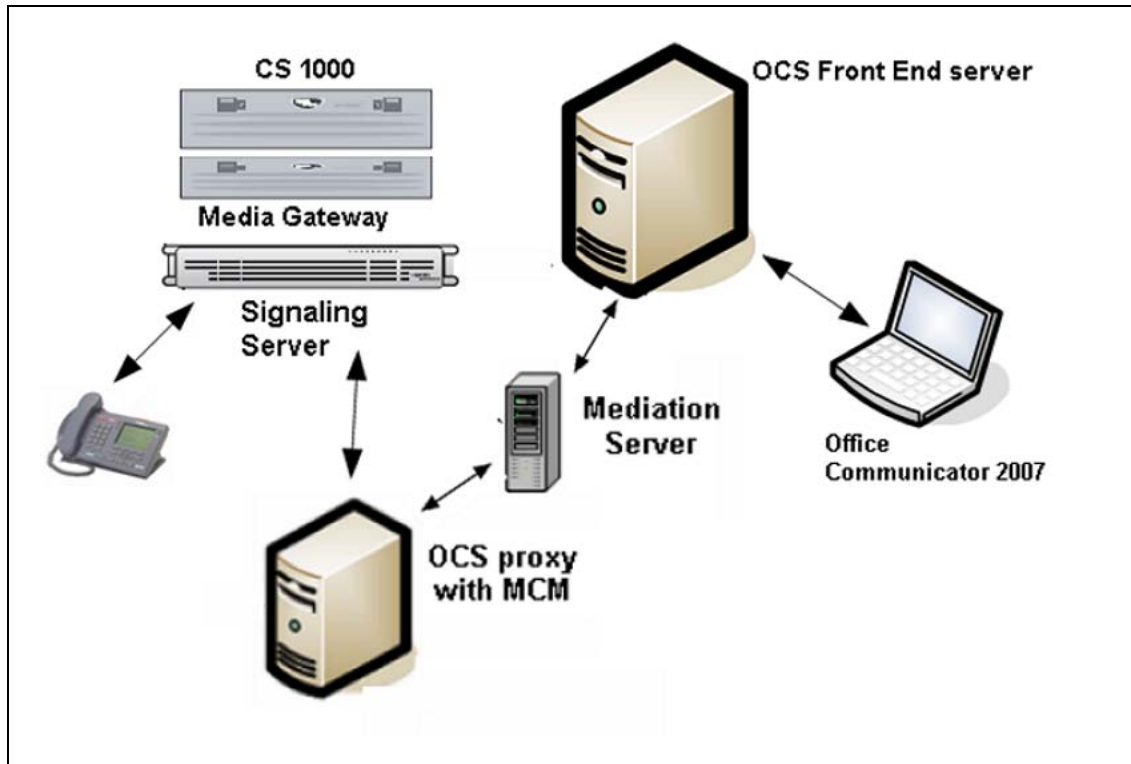
A small network can include the following components:

- a CS 1000 system with Media Gateway and Signaling Server
- support for IM and conferencing for internal users and can include external users
- up to 5000 users

You will need:

- An Office Communications Server 2007 Standard Edition server
- a single Edge Server deployed in the perimeter network for external user access
- An OCS Proxy server that runs MCM 3.0
- a Mediation server

**Figure 10**  
**Small network configuration**



### Medium network

A medium network can include the following components:

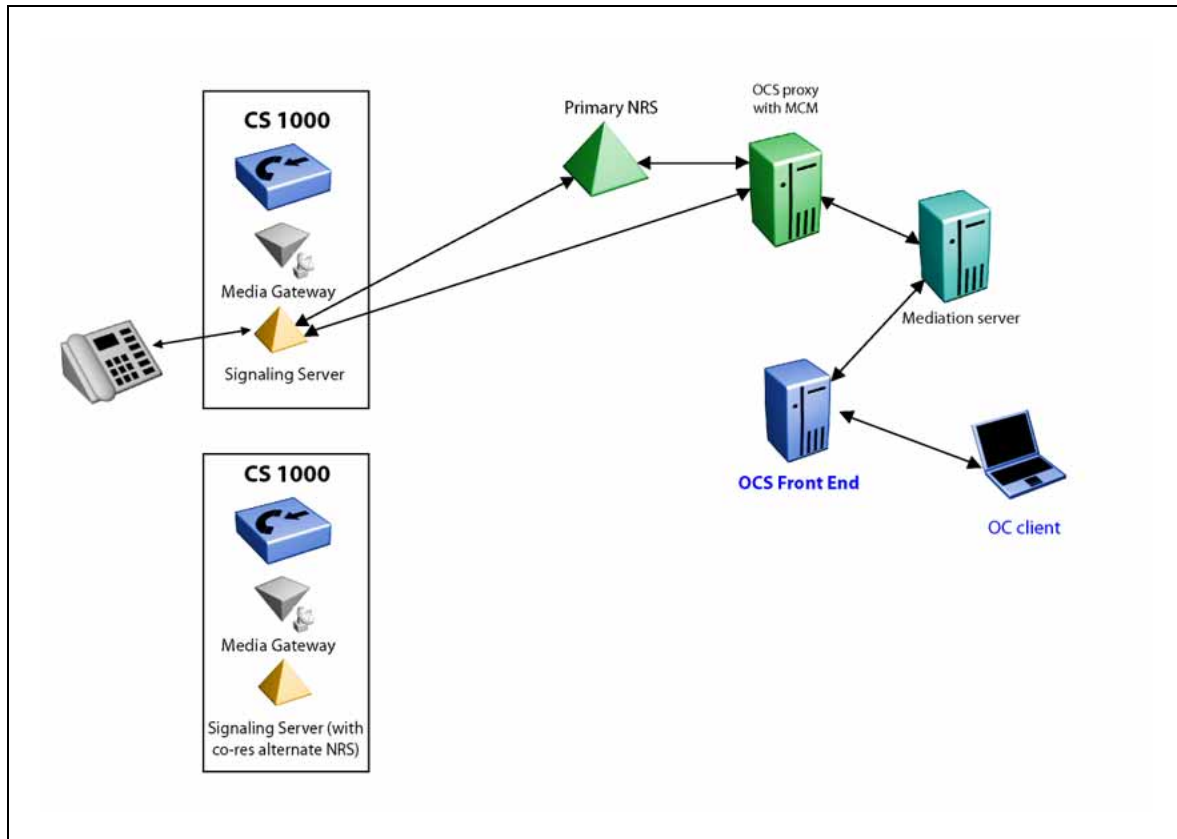
- one or multiple CS 1000 systems with Media Gateway and Signaling Server
- a Primary NRS with an Alternate Network Routing Service (NRS) that co-reside on one of the Signaling Servers
- up to 5000 users
- high availability with system redundancy for OCS 2007

You will need:

- an Office Communications Server 2007 Enterprise Edition
- an OCS Proxy server that runs MCM 3.0
- a Mediation Server

If you install only one OCS 2007 Enterprise Edition server, a Load Balancer is not required. SPS (Linux-based NRS) does not support co-residency.

**Figure 11**  
**Medium network configuration**



### Large network

A large network can include the following components:

- multiple CS 1000 systems with Media Gateway and Signaling Server
- configured collaborative NRS
- redundant Primary and Alternate NRS
- more than 5000 users
- high availability with system redundancy for OCS 2007

You will need:

- an OCS 2007 Enterprise Edition server with Load Balancers to Front End the pool of Enterprise Edition servers
- a redundant OCS Proxy servers that run MCM 3.0 (the recommended deployment requires that MCM reside on a separate OCS Proxy server)
- Mediation servers
- Load Balancers

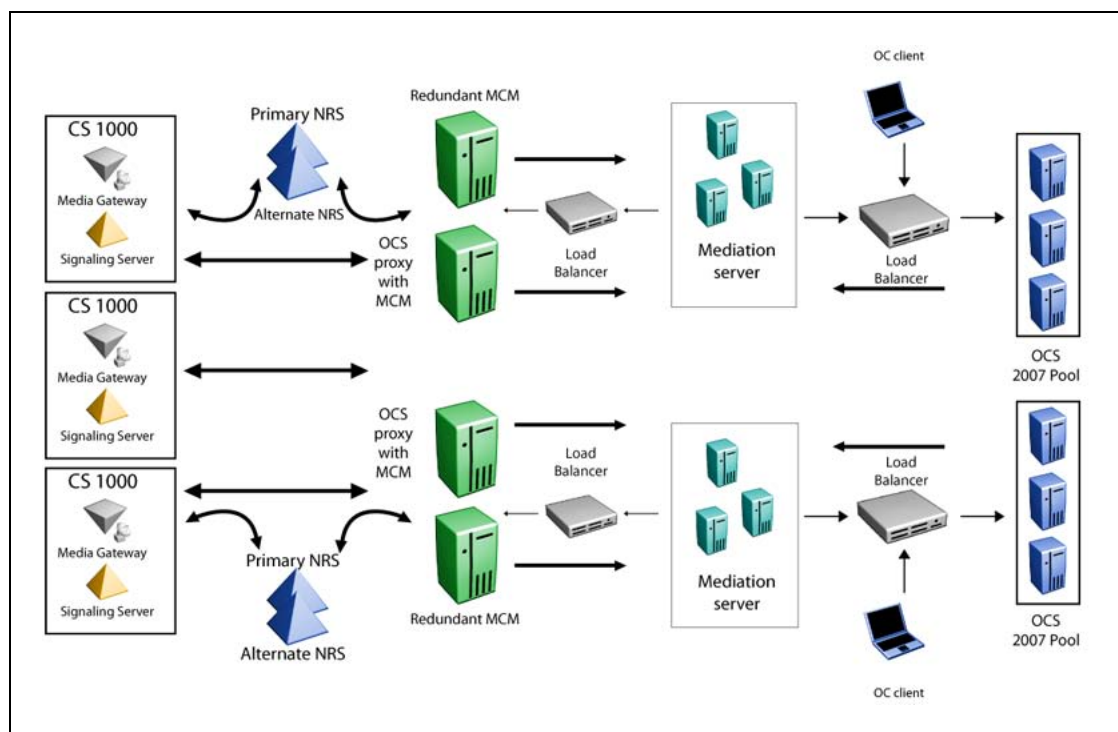
The redundant, primary, and alternate NRS can be either the VxWorks NRS or the Linux-based NRS (SPS/SRS). For the OCS 2007 Enterprise Edition server, a SQL back end database server is a requirement.

### ATTENTION

If you set up more than one server that runs the Enterprise Edition of Microsoft Office Communications Server 2007, you must use a Load Balancer in accordance with the Unified Communications Engineering Rules and Guidelines.

The Load Balancer ensures that the Fully Qualified Domain Name (FQDN) of the pool is not equal to the FQDN of any Front End server in the pool.

**Figure 12**  
Large network configuration



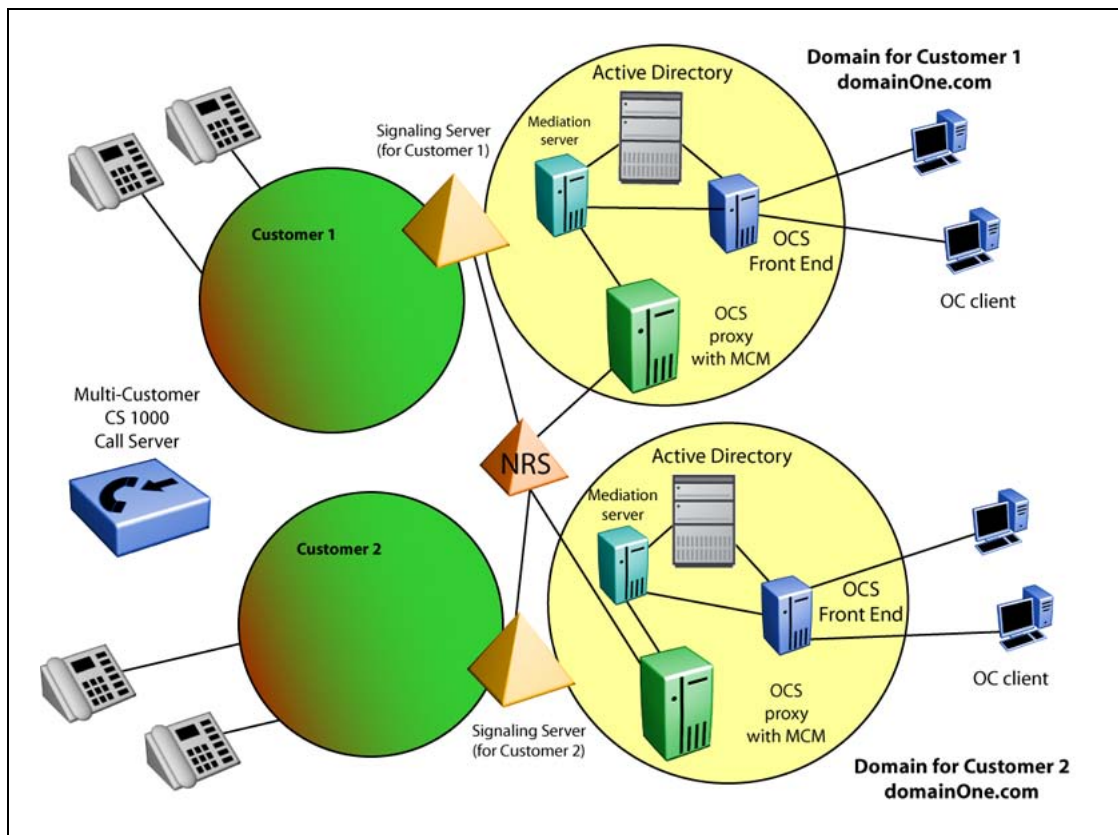
### Multiple customer network

You can configure the CS 1000 with a number of customers that have their own set of telephones, trunks, features, restrictions, and numbering plans. In the Converged Office environment, each customer is treated as a separate machine. Each customer shares one OCS deployment, but has their own Node Number, MCM, Signalling Server, and SIP domain in the forest. For more information about the Multiple Customer environment, see *Features and Services* (NN43001-106).



Figure 13 "Multiple customer network" (page 41) provides an example of a multiple customer network. The figure shows two customers: Customer 1 (Ottawa) and Customer 2 (Belleville), each with their own set of associated phones and Signalling Servers. This type of configuration is required for any deployment that uses the Telephony Gateway and Services functionality, or in scenarios where both Telephony Gateway and Services and Remote Call Control functionality is deployed.

**Figure 13**  
**Multiple customer network**



The Signaling Server for Customer 1 is in the domainOne.com domain. For each customer, you must configure a separate Office Communications Server domain. The Office Communications Server domain used by Customer 1 is in the same domain as the Signaling Server domainOne.com. Each OCS domain requires a separate Active Directory.

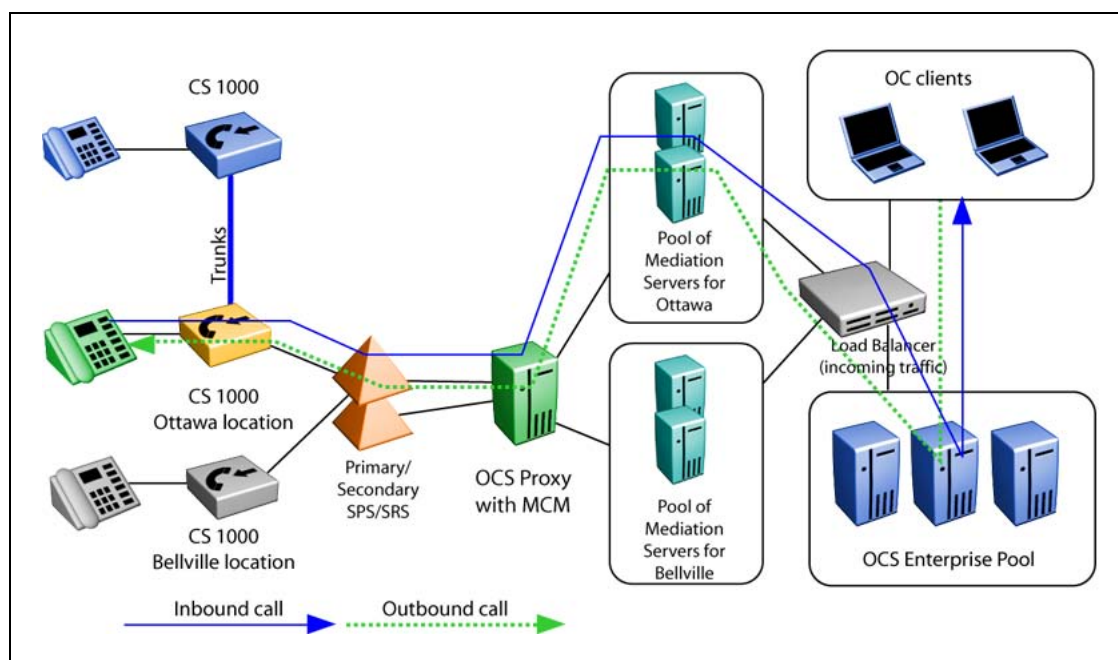
The only equipment that Customer 1 and Customer 2 share is the CS 1000 and the NRS. The NRS can only be shared by the two customers if it is configured with both domainOne.com and domainTwo.com.

The Signaling Server, OCS Proxy server (which runs MCM), OCS 2007 Front End server, and Active Directory are separate. The number of Signalling Server(s), OCS 2007 Proxies, and OCS 2007 Front End servers required for each customer are the same as if each customer were part of a single system. However, the total number of users allowed for the CS 1000 is the total number of users for all customers.

### Multiple location network

The following diagram shows the path of an inbound and outbound call in a multiple location network configuration in a single forest deployment. The MCM routes inbound calls from the Signaling Server to the appropriate Mediation Server within the Mediation Server pool. When the current Mediation Server does not answer, MCM jumps to the next Mediation Server.

**Figure 14**  
**Multiple location network**



For regional or multiple location deployments, it is required to install SPS/SRS. Two Primary/Secondary SPS/SRS may co-exist within one configuration to improve the system's robustness. In the previous versions of the program, the MCM performs polling by sending SIP OPTION request to determine which SPS/SRS is active. The active SPS/SRS becomes the last one to send an OK response. The SIP Proxy Server (SPS) sits between MCM and the TR\87 FE application that reside on CS 1000. This SIP proxy allows communication between the CS 1000 and OCS when different transport protocols (TLS and TCP) are used. An OCS configuration with

Mediation servers supports only TCP. However, it can interact with TLS gateway through SPS. SPS can act as a redirect server for SIP messages so the link between CS 1000 and the SPS can be TLS.

## Load Balancer planning

This section provide information on the Load Balancer requirements.

### Load balancer navigation

- ["Load Balancer prerequisites" \(page 43\)](#)
- ["Load Balancer requirements" \(page 44\)](#)
- ["Redundancy with Load Balancers" \(page 45\)](#)
- ["High scale and high availability configuration" \(page 45\)](#)
- ["Nortel Application Switch \(NAS\)" \(page 46\)](#)

### Load Balancer prerequisites

- Before you configure a Load Balancer to connect to the Office Communications Server Enterprise pool, ensure you configure the following:
  - The Load Balancer must meet the Microsoft criteria for a Load Balancer. See ["Load Balancer requirements" \(page 44\)](#)
  - Configure a static IP address for servers within your pool.
  - For each server within the pool a certificate, include for both user and server authentication issued by a certification authority in the pool's local domain.
  - Configure a VIP address and a DNS record for the load balancer.
  - Test users created and SIP-enabled in the pool.
  - Install root certificate from CA in the domain (or trusted CA) on client computers.
  - Log on to all servers in the pool using TLS to ensure server and client certificates work.
  - Configure Port 135 on Load Balancers to enable server-side block and allow functionality for users and move user scenarios to pools through DCOM. For example, perform remote DCOM-based database operations. Nortel recommends the minimum configuration.

**Table 3**  
**Load balancer minimum configuration**

Service	Protocol	Port (range)	Description
TLS pool	TCP	5061	The client listens over the same connection that is open to the server. By default, the server listens on port 5061 (TCP). The server sends packets to the client only over the client TLS session.
DCOM	TCP	135	Installation and management.

— Optionally, configure the TCP pool on port 5060 for clients to connect to the Load balancer through TCP.

### Load Balancer requirements

A Load Balancer for the Office Communications Server (OCS) Enterprise pool must meet the following requirements:

- The Load Balancer must expose a VIP Address through Address Resolution Protocol (ARP).
- The VIP must have a single DNS entry, called the pool FQDN.
- The VIP must be a static IP address.
- The Load Balancer must allow multiple open ports on the same VIP. Specifically, it must expose the ports 5060, 5061, 135, 80, 443, and 444.
- The Load Balancer must provide TCP-level affinity. This means that the Load Balancer must ensure that it can establish TCP connections with one Office Communications Server in the pool and all traffic on that connection is destined for that same Office Communications Server.
- The Load Balancer must provide a configurable TCP idle-timeout interval with a maximum value greater than or equal to the minimum of the REGISTER refresh or SIP Keep-Alive interval.
- The Load Balancer must support a rich set of metrics (round robin, least connections, and weighted). Nortel recommends a weighted least connections-based load balancing mechanism for the Load Balancer. This means that the load balancer ranks all Office Communications Servers based on the weight assigned to them and the number of outstanding connections. The Load Balancer use the rank to pick the Office Communications Server to use for the next connection request.
- The Load Balancer must detect Office Communications Server availability by establishing TCP connections to ports 5060, 5061, or both (often called a heartbeat or monitor). The polling interval must be a configurable value with a minimum value of at least five seconds. The load balancer must not select an Office Communications Server that shuts down until it can establish a successful TCP connection (heartbeat) again.

- Every Office Communications Server must have exactly one network adapter. Multihoming an Office Communications Server is not supported. If a 10/100 network adapter does not meet the required bandwidth constraints, a gigabit network adapter must be used.
- The network adapter must have at least one static IP address. This IP address will be used for the incoming load-balanced traffic.
- The computer must have a registered FQDN. The IP address registered for this FQDN must be publicly accessible from within the enterprise.
- The Load Balancer must include less than one gigabit capacity for up to 50 000 concurrent client connections. One gigabit of capacity is required to support more than 50 000 concurrent client connections.

For more information about Load Balancer requirements, see *Microsoft Office Communications Server 2007 Document: Planning Guide*. Download Microsoft technical documentation from the Download Center at [www.microsoft.com](http://www.microsoft.com).

### Redundancy with Load Balancers

You can add redundancy to your network by placing Load Balancers, such as a Nortel Application Switch, between the OCS 2007 Front End servers and Mediation Servers, and between the Mediation Servers and the OCS 2007 Proxy Servers.

The outgoing Load Balancer balances SIP invites from the Mediation Server to the OCS Proxy server. The Mediation Server sends all SIP Invites to the Virtual IP (VIP) of the outgoing Load Balancer. The Load Balancer then sends the SIP Invite to the least busy Office Communications Server 2007 OCS Proxy.

The incoming Load Balancer balances SIP invites from the Mediation Server to the least busy Front End server. This is the same load balancer that is used when the Office Communicator addresses the pool for registration. The OCS Proxy sends all SIP invites to the Virtual IP (VIP) of the incoming Load Balancer.

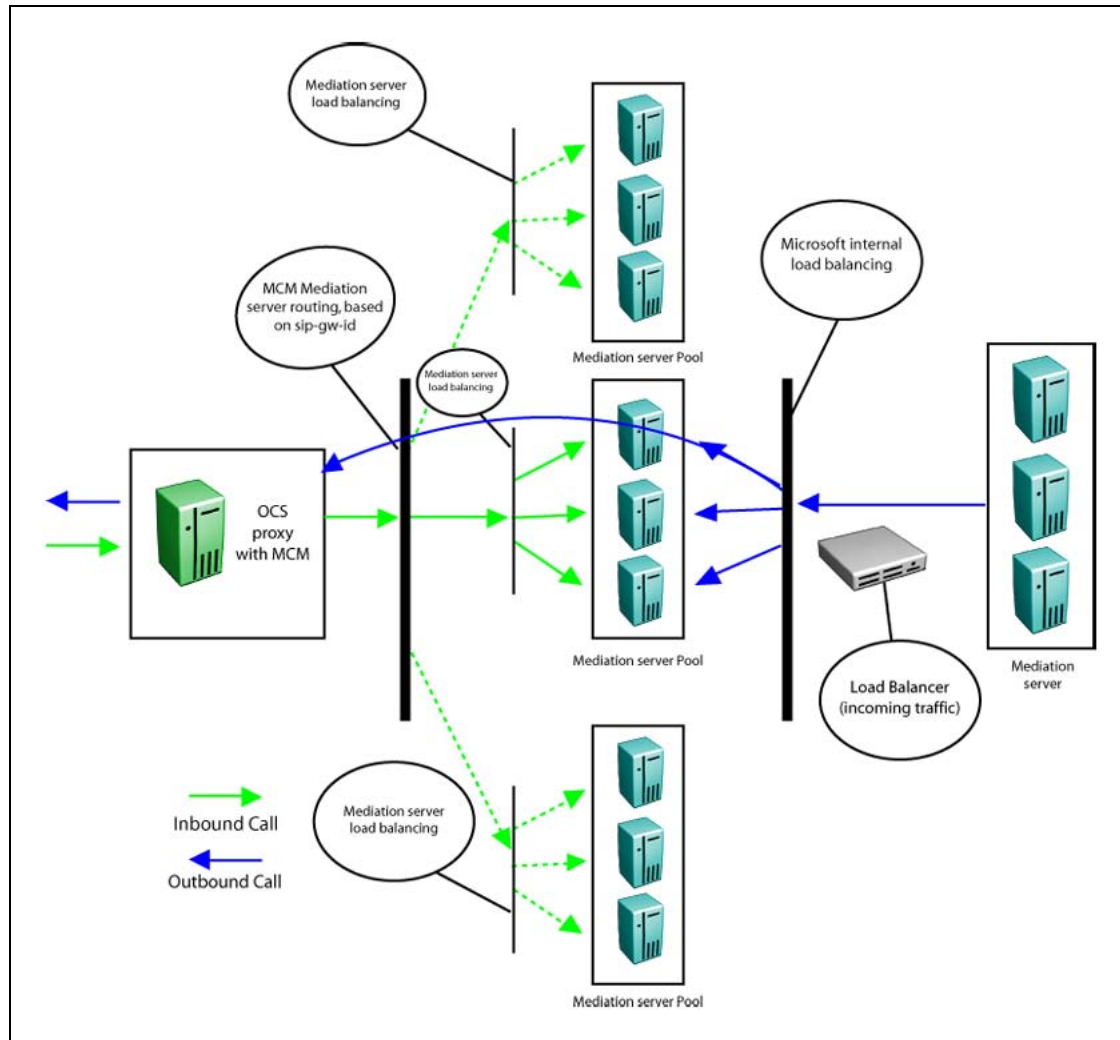
Redundancy is also ensured for calls to an Office Communicator user by having each OCS Proxy server register to the MCM and the Mediation Server to the NRS with a unique registration ID and different cost factor. Therefore, if one of the OCS Proxy servers is unavailable, the next one is selected.

### High-scale and high availability configuration

The pool of Front End servers processes inbound and outbound traffic. In this example, the Load Balancer routes incoming SIP messages to the less busy server based on a configured algorithm. The Load Balancer VIP

address is used by clients as a single point of connection to the pool. This address is listed in DNS and has an FQDN. Internal OCS clients require the DNS server to establish a connection with the Enterprise Edition Pool.

**Figure 15**  
**Incoming Load Balancer**



### Nortel Application Switch

Nortel recommends that you use the Nortel Application Switch (NAS) for Load Balancing.

### Capacity planning

This section provides the capacity requirements for the various components.

---

## Capacity planning navigation

- "OC 2007 client requirements" (page 47)
- "Load Balancer capacity requirements" (page 47)
- "SIP CTI (TR/87) services requirements" (page 47)
- "Mediation server requirements" (page 49)
- "Signaling Server requirements" (page 49)
- "Call Server requirements" (page 50)
- "OCS Proxy and MCM capacity requirements" (page 50)

## OC 2007 client requirements

The PC that runs the OC 2007 must be registered to the domain in which the OCS 2007 server runs. The OC 2007 client can be installed on a PC that runs most versions of Microsoft Windows with the hardware device driver API DirectX 9 or later. For more information on the OC client requirements, see [Table 11 "Office Communicator client requirements" \(page 54\)](#).

For more information about deploying the OC client, see *Microsoft Office Communicator 2007 Deployment Guide*. Download Microsoft technical documentation from the Download Center at [www.microsoft.com](http://www.microsoft.com).

## Load Balancer capacity requirements

Capacity planning for OCS 2007 is measured in terms of the number of clients. However, this becomes difficult to measure because of the enhanced capabilities and services for a pool and the variety of components that can be enabled in OCS 2007. Components can reside on separate servers, which adds to the complexity of capacity planning. A single client user can have multiple connection instances that depend on the features enabled. Each feature has different bandwidth requirements that can differ from one enterprise to another.

For more information on capacity guidelines, see [Table 5 "Maximum supported users for each topology" \(page 52\)](#).

For more information about capacity planning, see the *Microsoft Office Communications Server 2007 Planning Guide*. Download Microsoft technical documentation from the Download Center at [www.microsoft.com](http://www.microsoft.com).

## SIP CTI (TR/87) services requirements

When you plan for capacity with Session Initiation Protocol Computer Telephony Integration (SIP CTI) services, observe the following restriction: For a single CS 1000 that supports multiple nodes, (each with SIP CTI services enabled), you can establish multiple SIP CTI (TR/87) sessions for a DN through the same node—but not through different nodes.

To illustrate this, consider the following high-level example:

Client A sends a TR/87 SIP INVITE to Node 1 to monitor DN 1000. The TR/87 association is established. Client B then sends a TR/87 SIP INVITE to Node 1 (the same node) to monitor DN 1000. Both sessions are established successfully. As a result of this sequence, two TR/87 sessions exist for DN 1000 through Node 1.

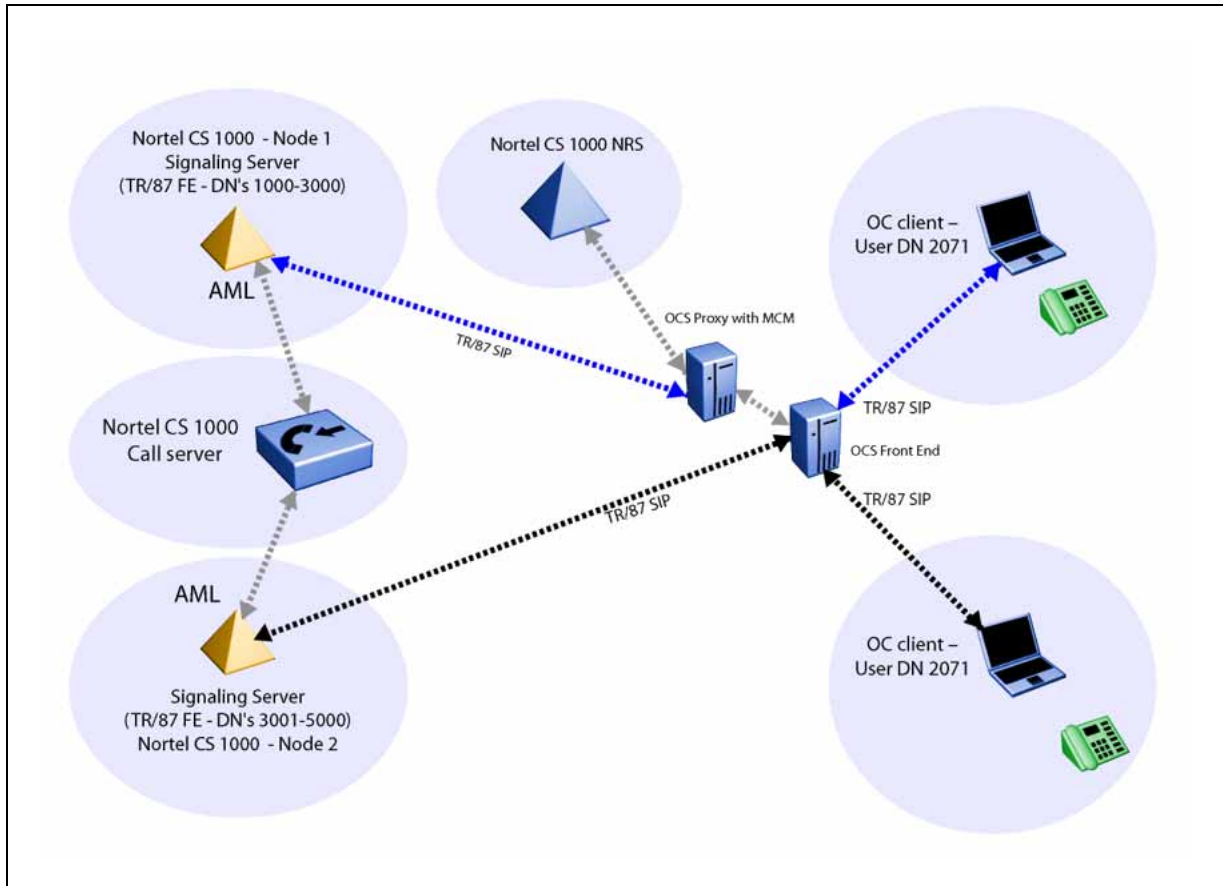
However, if Client B attempts to send a TR/87 SIP INVITE to Node 2 (which has an AML link to the same call server as Node 1), the attempt to establish the TR/87 session fails because the DN is already in use by Client A's session through Node 1.

To solve this issue when you plan for capacity, SIP routing must ensure that all TR/87 sessions for a DN always terminate on the same node when there are multiple nodes for a single CS 1000 call server, as depicted in [Figure 16 "SIP CTI \(TR/87\) example" \(page 49\)](#).

This issue can arise in cases where a single user has multiple clients logged on simultaneously (for example, a client at home, a client in the office, and a mobile client; each with TR/87 capability).



**Figure 16**  
**SIP CTI (TR/87) example**



### Mediation server requirements

The CS 1000 can process up to 13 000 simultaneous calls. Therefore, you may require several Mediation servers for one CS 1000. To correctly deploy OCS 2007 to interwork with the CS 1000, you must correctly engineer the network to handle the anticipated call traffic. Calculate the anticipated call traffic for the CS 1000 using the instructions in *Communication Server 1000E Planning and Engineering* (NN43041-220). For more information on hardware requirements, see [Table 7 "Mediation Server hardware requirements"](#) (page 53).

### Signaling Server requirements

The maximum number of SIP CTI (TR/87) users on a single Signaling Server is 5000. One Signaling server can support up to 1800 SIP trunks; therefore, you require up to two Mediation servers for a single Signaling Server. To increase the system capacity, associate a pool of Mediation Servers with each Call Server. MCM routes inbound calls from the Signaling Server to the appropriate Mediation Server within the Mediation Server pool.

For example, MCM works as a software load balancer in addition to a router. MCM uses a round-robin algorithm for load balancing. When the current Mediation Server does not answer, MCM jumps to the next Mediation Server. You can use load balancing for direct mode and with SPS or SRS.

For Release 5.0, 1 GB of memory is required for a standard Signaling Server. All signaling servers must run the latest software version. For information on geographic redundancy, see "[Geographic redundancy](#)" (page 78).

### Call Server requirements

The CS 1000 must run Release 5.0 with the Product Enhancement Package or later.

For different CPUs, the number of supported users are:

- CP PII: 7000 users
- CP PIV: 13 000 users
- CP PM: 13 000 users

### OCS Proxy and MCM capacity requirements

The MCM is required to reside on a separate OCS Proxy server and the capacity of the OCS Proxy server with MCM depends on the hardware platform and the usage. For example, VoIP calls only, SIP CTI calls only or a combination of both. Because capacity characterization cannot be conducted on all server platforms, Nortel recommends using standardized sets of relevant benchmarks available from the Standard Performance Evaluation Corporation (SPEC). SPEC is a non-profit corporation formed to establish, maintain, and endorse benchmarks that can be applied to the newest generation of high-performance computers. A comprehensive list of benchmarks is available at [www.spec.org](http://www.spec.org).

The server used for capacity characterization had a SPECint\_rate2000 value of 18.6. See [Table 4 "Maximum call rate"](#) (page 50) for the maximum call rate of this server for the three different configurations.

**Table 4**  
**Maximum call rate**

Usage	Maximum call rate
VoIP calls	15 000
SIP CTI (TR/87) calls	10 000
Combined	12 500*
* Depends on the ratio of either call scenarios assumed 50% of each. For example: Worst case—all SIP CTI calls, Best case—all VoIP calls.	

The number of users the OCS Proxy server with MCM can handle depends on the usage and the number of calls per hour per user. For example, assuming 5 cph/user for VoIP calls would give 3000 users (15 000 cph/5 cph/user = 3000 users).

The following are the formulas (based on SPECint\_rate2000) to calculate the maximum call rate for different platforms:

- VoIP calls only. Number of calls per hour supported =  $(15\,000 \times \text{SPECint of HW}) / 29.8$ .
- SIP CTI (TR/87) RCC calls only. Number of calls per hour supported =  $(10000 \times \text{SPECint of HW}) / 29.8$ .
- Both VoIP and SIP CTI (TR/87) RCC calls combined. Number of calls per hour supported =  $[(15\,000 \times \text{SPECint of HW}) \times (\text{VoIP\_call\%}) + (10\,000 \times \text{SPECint of HW}) \times (\text{SIPCTI\_call\%})] / 29.8$ .

#### **ATTENTION**

VoIP\_call% or SIPCTI\_call% must be less than 100%.

#### **ATTENTION**

An OCS Proxy is not an Access Proxy. For more information on OCS proxy hardware requirements, see [Table 8 "OCS Proxy server hardware requirements" \(page 53\)](#).

## General requirements

This section provides general guidelines and requirements to follow when you deploy the Office Communications Server 2007.

### General requirements navigation

- ["Server topology" \(page 52\)](#)
- ["Operating System Requirements" \(page 52\)](#)
- ["Hardware Requirements" \(page 53\)](#)
- ["Virtual Server 2005" \(page 54\)](#)
- ["Storage" \(page 55\)](#)
- ["Trunks" \(page 55\)](#)
- ["SIP access port " \(page 55\)](#)
- ["Basic Client Configuration" \(page 58\)](#)
- ["Port use" \(page 58\)](#)
- ["Security " \(page 59\)](#)

- "OC client authentication" (page 59)
- "Authorization of TR/87 (Remote Call Control) Service Requests" (page 59)
- "Signaling and Media Encryption" (page 59)
- "Dial Plan considerations" (page 61)
- "Computer (SIP) Calls" (page 61)
- "Phone (RCC or TR/87) Calls" (page 62)
- "Number formats supported by Office Communicator" (page 63)
- "E.164 international format numbers for SIP Gateway and SIP CTI" (page 66)

### Server topology

Use the following table to determine the maximum supported users for your topology.

**Table 5**  
**Maximum supported users for each topology**

Topology	Servers required	Maximum clients
Standard Edition Server	1 Standard Edition server, (Optional) Archiving Server collocated	5000
Enterprise pool: Consolidated Configuration	4 Enterprise Edition Front End servers running all server roles, 1 back end SQL server (Optional), 1 Archiving server	4 servers X 5000 users per server = 25 000 maximum clients
Enterprise pool: Expanded configuration with Mid-Range Performance SQL back end	4 Front End servers, 2 Web Conferencing servers, 2 A/V Conferencing servers, 2 IIS servers, 1 back end SQL server (Optional), 1 Archiving server	10 000 users per access edge server and 50 000 maximum clients
Enterprise pool: Expanded configuration With High Performance SQL back end	8 Front End servers, 4 Web Conferencing servers, 4 A/V Conferencing servers, 2 IIS servers, 1 back end SQL server (Optional), 2 Archiving servers	125 000

### Operating System Requirements

The operating system platform requirements for all Office Communications Server 2007 server roles are:

- Minimum: Microsoft Windows Server 2003 SP1.
- Recommended: Windows Server 2003 R2 with SP2.

## Hardware Requirements

Use the following table to determine hardware requirements for the OCS 2007 Standard and Enterprise Edition server.

**Table 6**  
**Office Communications Server 2007 Standard and Enterprise Edition hardware requirements**

Hardware	Requirements
CPU	Dual processor, dual core 2.6 GHz +
Disk	2 x 18 GB For collocated Standard Edition Server, add: 2 x 36 GB, 15K RPM, RAID 0, for database log files 2 x 36 GB, 15K RPM, RAID 0, for database data
Cache	1 MB L2 per core
Memory	2 GB (4 GB for Standard Edition server or Consolidated Enterprise Edition server)
Network	Gbit NIC

**Table 7**  
**Mediation Server hardware requirements**

Hardware
Single processor, dual core, 2 GHz, Memory: 2GB RAM 2 x 1 Gbit NIC
Single processor, dual core, 3 GHz Memory: 2GB RAM 2 x 1 Gbit NIC
Dual processor, dual core, 3 GHz Memory: 2GB RAM 2 x 1 Gbit NIC
Dual processor, quad core, 2.66 GHz, Memory: 2GB RAM 2 x 1 Gbit NIC

**Table 8**  
**OCS Proxy server hardware requirements**

CPU	Dual processor 3.2 GHz or equivalent for up to 120 concurrent calls Dual processor, dual core 3.0 GHz or equivalent for more than 120 concurrent calls
Disk	1 x 30 GB, 15K rpm SCSI
Cache	1 MB
Memory	2 GB
Network	1 x Gbit NIC

**Table 9**  
**Back end database for a small to medium Enterprise pool**

CPU	Dual processor, dual-core 2.6 GHz +
Disk	Drive 1 (2 x 18 GB) for OS and Page File Drive 2 (36 GB, 15K RPM) for database log file Drive 3 (36 GB, 15K RPM) for database log file Drive 4 (8 x 36 GB, 15K RPM, RAID 0+1) for database files
Cache	2 MB L2 per core
Memory	8 GB
Network	Gbit NIC

**Table 10**  
**Back end database for a large Enterprise pool**

CPU	Quad processor, dual-core 2.6 GHz +
Disk	Drive 1 (2 x 18 GB) for OS and Page File Drive 2 (4 x 36 GB, 15K RPM, RAID 0+1) for database log file Drive 3 (4 x 36 GB, 15K RPM, RAID 0+1) for database log file Drive 4 (8 x 36 GB, 15K RPM, RAID 0+1) for database files
Cache	2 MB L2 per core
Memory	16 GB
Network	Gbit NIC

**Table 11**  
**Office Communicator client requirements**

Operating System	<ul style="list-style-type: none"> <li>Windows Vista 32-bit (RTM) operating system</li> <li>Microsoft Windows XP Professional with Service Pack 2</li> <li>Windows 2000 Professional with Service Pack 4 (requires Microsoft Windows Media technologies player, version 9, and Microsoft Windows Installer, version 3.0 or later)</li> </ul> <p>Hardware device driver must be API DirectX 9 or higher.</p>
Computer/Processor	<ul style="list-style-type: none"> <li>Data and Voice: 500-megahertz (MHz) or higher processor. Intel Pentium-compatible</li> <li>For video: 1 GHz or higher</li> </ul>
Memory	512 megabytes (MB) of RAM
Install Space	1.5 MB

### Virtual Server 2005

Microsoft Virtual Server 2005 is not supported as part of the Nortel Converged Office feature. The Nortel software component Multimedia Convergence Manager (MCM) must not be installed on Office

Communications Server that runs Microsoft Virtual Server 2005. For additional information about Virtual Server 2005, see the Virtual Server Web site at [www.microsoft.com/windowsserversystem/virtualserver/default.mspx](http://www.microsoft.com/windowsserversystem/virtualserver/default.mspx).

## Storage

Store internal hard disks used for operating system and executable software, data, and transaction files separately. The following lists shows storage options:

- Direct access storage device (DASD)
- Storage Area Network (SAN)
- Redundant Array of Independent Disks (RAID)

Onboard storage:

- 2 SCSI Channels (split backplane)
- Five 18-GB hard disks, 15 000 rpm SCSI disk drives

Optional SAN:

- One Fibre Channel Host Bus Adapter (HBA)
- SAN unit

## Trunks

To handle the traffic between the CS 1000 and the Office Communications Server 2007, you must configure sufficient SIP trunks and PCAs . The number of additional SIP trunks needed is determined by:

Determine the number of SIP trunks required by multiplying the number of OC 2007 clients that use the SIP Gateway feature by the percentage of users you expect on the phone at any time.

For example, 100 Office Communicator SIP Gateway users x 10% on the phone at a time = 10 additional SIP trunks.

The percentage of users on the phone is decided by standard practice and the environment involved (For example, Call Center or Normal Office).

PCA trunks are required for each Office Communicator user that uses the Twinning (for SIP Gateway) feature.

### **SIP access port**

[Table 12 "Inputs" \(page 56\)](#) defines the inputs used to calculate SIP access ports and PCA requirements.

**Table 12**  
**Inputs**

Input	Description
TN_MO_Users	Total number of Office Communicator users that use the SIP Access Ports for voice services.
PCA_MO_Users	Number of Office Communicator users that use Personal Call Assistant (PCA). The PCAs required here are additional to the number of PCAs provided in the Enterprise Configurator (EC) tool Software screen.
P_PCA_SIP	Percentage of PCA calls that use the soft client to answer a call.

**Calculations** Use the following formulas to calculate traffic requirements (MO indicates Microsoft Office Communicator):

- Traffic for PCAs = (PCA\_MO\_Users) x (CCS per user) x (1 - P\_PCA\_SIP) x 10%
- Traffic for SIP ports = (TN\_MO\_Users - PCA\_MO\_Users) x (CCS per user) + (PCA\_MO\_Users x P\_PCA\_SIP) x (CCS per user)
- Total SIP Traffic = (Traffic for PCAs) + (Traffic for SIP ports)
- Number of MO SIP ports = Poisson (Total SIP Traffic) at P.01 Grade of Service

Table 13 "Traffic figures" (page 56) shows traffic in CCS and number of ports calculated based on the Poisson formula at P.01 Grade of Service.

**Table 13**  
**Traffic figures**

Traffic (CCS)	Traffic (Erlang)	Number of ports
5	0.14	2
10	0.28	3
15	0.42	3
20	0.56	4
25	0.69	4
30	0.83	4
35	0.97	5
40	1.11	5
45	1.25	5
50	1.39	6
55	1.53	6
60	1.67	6
65	1.81	6



Traffic (CCS)	Traffic (Erlang)	Number of ports
70	1.94	7
75	2.08	7
80	2.22	7
85	2.36	7
90	2.5	8
95	2.64	8
100	2.78	8
125	3.47	9
150	4.17	10
175	4.86	12
200	5.56	13
225	6.25	14
250	6.94	15
275	7.64	16
300	8.33	17
325	9.03	18
350	9.72	19
375	10.42	19
400	11.11	20
425	11.81	21
450	12.5	22
475	13.19	23
500	13.89	24
550	15.28	26
600	16.67	28
650	18.06	29
700	19.44	31
750	20.83	33
800	22.22	35
850	23.61	36
900	25	38
950	26.39	40
1000	27.78	42
1500	41.67	58

Traffic (CCS)	Traffic (Erlang)	Number of ports
2000	55.56	74
2500	69.44	90
3000	83.33	106
3500	97.22	121
4000	111.11	137
4500	125	152
5000	138.89	168
6000	166.67	198
7000	194.44	228
8000	222.22	258
9000	250	288
10 000	277.78	318
20 000	555.56	611
30 000	833.33	908
40 000	1111.11	1205
50 000	1388.89	1502
60 000	1666.67	1799
70 000	1944.44	2096

### Basic Client Configuration

The PCAG and PCAM Class of Service (CLS) have been introduced. Basic Client Configuration (BCC) can program the new Class of Service (CLS) parameters PCAG or PCAM for PCA TNs. The CLS parameter PCAG will be the default for all PCA TNs and PCAM will be the required value for all PCAs associated with OCS 2007.

LD 11 supports the administration of telephones. BCC uses REQ commands, such as NEW, CHG, and OUT. In LD 20, BCC uses the PRT command to retrieve phones from the Call Server.

### Port use

The CS 1000 uses the following ports related to TCP and TLS.

- 5060: TCP
- 5061: TLS

The dynamic port range used by Office Communicator for SIP/RTP is 1024 - 65535.

The port range can be controlled (restricted) to a smaller range using the group policy settings as described on the Microsoft Web site: [support.microsoft.com/default.aspx?scid=KB;EN-US;903056](http://support.microsoft.com/default.aspx?scid=KB;EN-US;903056)

Port ranges must not overlap.

## Security

When you consider a Converged Office deployment, ensure you understand the following security concepts and integrate them into your deployment planning.

### OC client authentication

Authentication of Office Communicator clients is provided by the Office Communications Server. For more information about authentication, see *Microsoft Office Communications Server 2007 Planning Guide*. Download Microsoft documentation from the Download Center at [www.microsoft.com](http://www.microsoft.com).

### Authorization of TR/87 (Remote Call Control) service requests

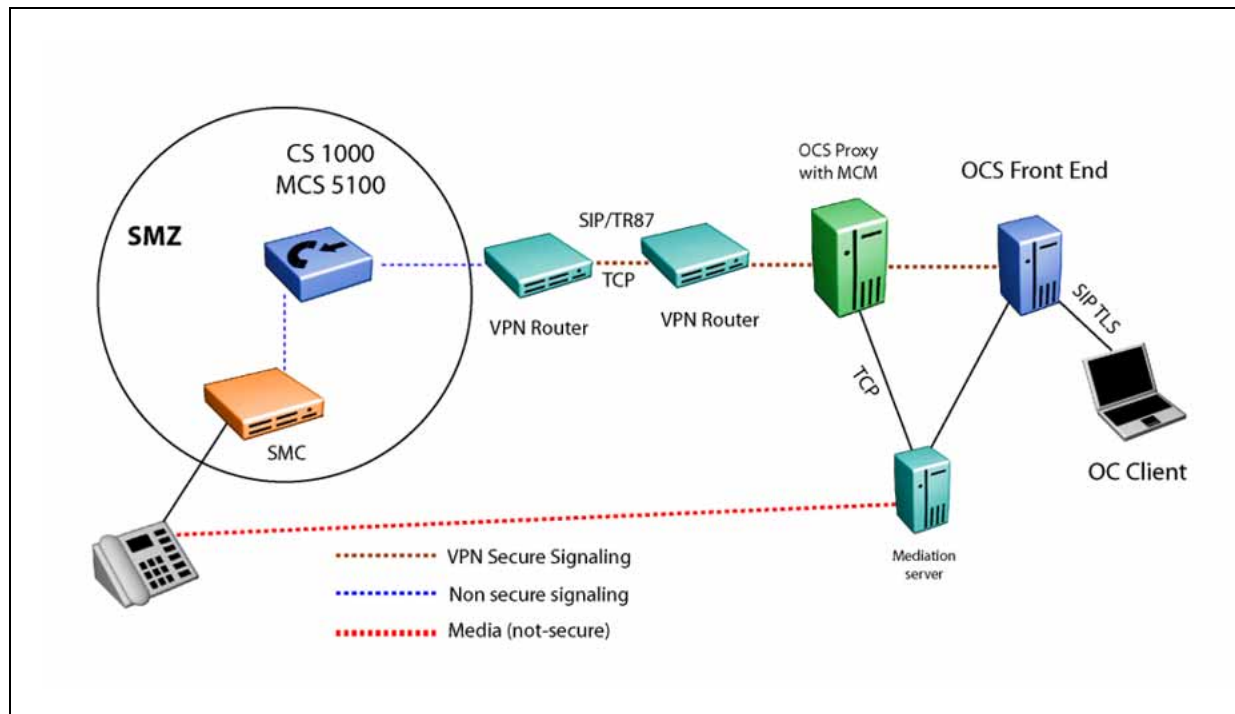
Authorization of TR/87 (Remote Call Control) service requests within a Converged Office deployment is handled by the Nortel MCM. The main requirement for authorization of service requests arises from Office Communicator users who can manually override the Phone Integration settings in Active Directory provisioned by an administrator. To ensure that each Office Communications Server user is restricted to the Active Directory configuration provisioned by an administrator for Remote Call Control, MCM provides an option to enable or disable authorization of TR/87 service requests. For details about the authorization process and MCM configuration requirements, see "[Configuring MCM for Remote Call Control](#)" (page 149).

### Signaling and media encryption

IP connectivity between the Office Communications Server and the CS 1000 is provided by TCP and TLS. Similarly, Office Communications Server server-to-server traffic can also be TCP or TLS. The MCM 3.0 supports TCP only, therefore, the connections between the Mediation Server and the OCS Proxy server and the Proxy server and the NRS/SIP Gateway are TCP.

To provide signaling security between the Office Communications Server and the CS 1000 (see [Figure 17 "Signaling Security" \(page 60\)](#)), Nortel Contivity VPN routers can be used to tunnel SIP signaling between the Office Communications Server and the CS 1000. A single VPN router that supports the Office Communications Server can service multiple individual VPN routers from multiple CS 1000 deployments.

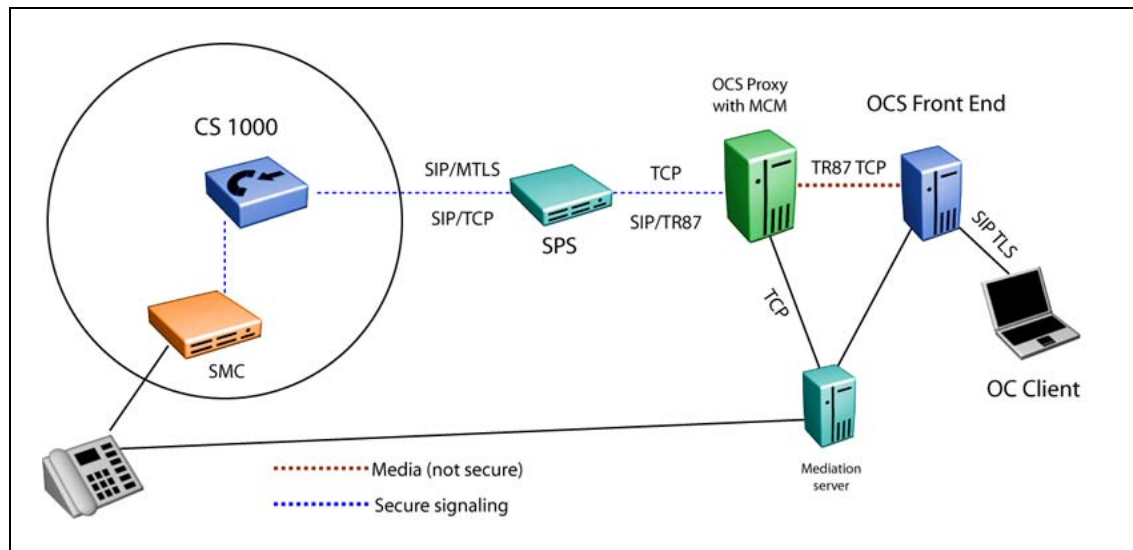
**Figure 17**  
**Signaling security**



- Secure Management Zone (SMZ) provides management access to local and remote devices over a secure connection. SMZ documents the LAN and WAN configurations required for secure management.
- Virtual Private Network (VPN) enables secure communications through Secure Internet Protocol (IPSec) encryption.
- Transport Layer Security (TLS) ensures that third-parties cannot eavesdrop or tamper with messages when a server and client communicate. MCM 3.0 does not support TLS.

Secure end-to-end policy is not supported with this application.

**Figure 18**  
**Signaling security with TLS**



### Dial Plan considerations

Nortel Converged Office is comprised of the following two components:

- SIP CTI Services provides CS 1000 native TR/87 support to enable the Remote Call Control functionality available with Office Communicator.
- Telephony Gateway and Services allows you to originate and receive SIP calls (for example, VoIP and Computer calls) from Office Communicator.

Whether you choose one or both components for deployment, an Office Communicator is essential. This allows the existing dial plan (that users have become accustomed to with their existing telephony interfaces) to extend seamlessly to the Office Communicator client for either call type. This includes all existing CS 1000 dial plan features such as Coordinated Dial Plan (CDP) and Uniform Dial Plan (UDP), and Group Dial Plan.

The following lists summarize the features that contribute to the dial plan configuration for the Converged Office feature from the perspective of calls originated and received from Office Communicator.

### Computer (SIP) Calls

- Number format entered in Active Directory or Office Communicator
- Office Communications Server Address Book Service Normalization rules
- Network Redirect Service (NRS)
- CS 1000 SIP Gateway configuration

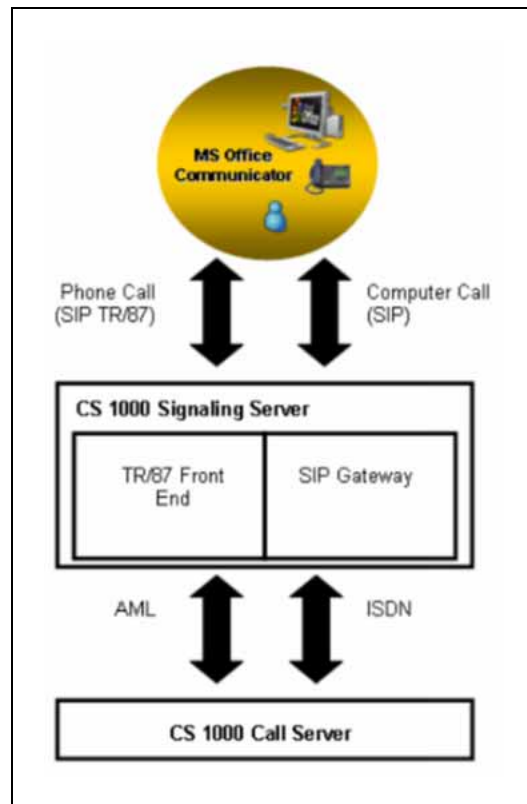
- CS 1000 Call Server configuration relating to the SIP Gateway
- OCS Location Profile, Policy, Phone Usage, and Route configuration.
- OC client configuration in the Active Directory

### **Phone (RCC or TR/87) Calls**

- The format of the number itself entered in Active Directory or entered in Office Communicator
- Office Communications Server Address Book Service Normalization rules
- CS 1000 SIP CTI Services Configuration
- CS 1000 Call Server Configuration relating to PBX telephones
- OC Client configuration in the Active Directory

The number format and normalization support provided by Office Communications Server is used to format numbers for both Remote Call Control and computer calls. However, the interface from which they originate and receive calls from the CS 1000 is the TR/87 Front End and SIP Gateway respectively (as illustrated in [Figure 19 "Signaling and media paths"](#) (page 63)).

**Figure 19**  
**Signaling and media paths**



### Number formats supported by Office Communicator

Dialstrings and E.164 International number format are the two types of numbers used by Office Communicator. Both number formats apply to computer and phone calls with Office Communicator.

#### Dialstrings

By default, digits dialed from Office Communicator that are not fully qualified are sent as dialstrings. The sequence of digits entered in Office Communicator are sent directly to the Call Server to be dialed. This allows a user to dial all numbers that you would typically expect to dial from a phone local to the CS 1000. Normalization rules should be defined in the Location Profile to convert the dialstrings to the E.164 International format for all types of PSTN calls. For example, NXX, NPA and International.

#### E.164 International Format Numbers

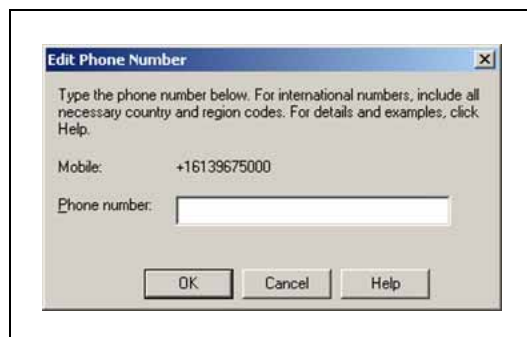
The recommended format of numbers stored in Microsoft applications is the E.164 International number format. This is a variable length number that consists of a plus sign (+) followed by a 1 to 3 digit country code and a national number 15-n digits long—where n is the length of the country code.

All E.164 numbers presented to the CS 1000, computer, or phone are expected in the following format:

+<country code><national number>

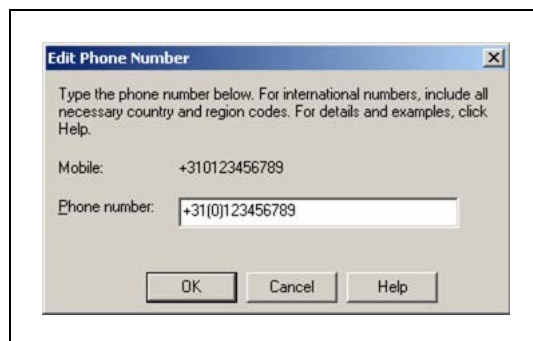
For example, in North America, the Office Communicator Phone Number configuration input dialog box would have an entry similar to [Figure 20](#) "North American format" (page 64).

**Figure 20**  
**North American format**



Outside North America, the Office Communicator Phone Number configuration input dialog box would have an entry similar to [Figure 21](#) "Outside North America format" (page 64).

**Figure 21**  
**Outside North America format**



The Normalization feature, provided by the Office Communications Server Address Book Service, can be used to ensure that formats used within a local deployment that do not conform to the convention can be converted without changes to the original numbers.

For example, in the Netherlands, numbers in Active Directory can be entered in the following format: +31(0)123456789



A normalization rule can be used to strip the digit in brackets to conform to the expected format for E.164 numbers when using the Converged Office feature: +31123456789

For more information about Normalization rules, see ["Creating Normalization rules" \(page 193\)](#).

Handling numbers called from Office Communicator in E.164 format requires that the Call Server be configured to ensure that the number requested is within the defined dial plans:

### **Within North America**

Various types of numbers can be recognized, including international, national, local (for example, NPA, NXX, and Free Calling Area Screening), or private, that use one or two access codes and number translators (AC1 and AC2). The E.164 number that enters the Call Server for Converged Office calls must be recognizable by the Call Server so that the call can be routed appropriately. The number is interpreted based upon the access code used within the called number as it enters the Call Server (AC1 or AC2).

If calls that enter the Call Server are identified as international and outside of North America (for example, the country code is not 1), the translator must contain entries that recognize the international numbers and route the call to the appropriate route list. These entries are generally within the existing AC1/AC2 translator, as they are used to route international calls that are dialed directly from telephones.

If calls that enter the Call Server are national or local, the translation used must recognize numbers with the national dialing prefix (for example, Converged Office calls) and numbers without the national prefix (for example, local calls dialed by users). To enable this recognition without duplication of number plan entries, a Home NPA (HNPA) entry can be added to the AC1 translator to recognize calls within the local NPA that include the North American national dialing prefix (for example, 1613 within NPA 613). After matching the HNPA entry within AC1, the translation software automatically uses the AC2 translator to recognize the rest of the digits received.

### **Outside North America**

Various types of numbers are recognized, including international, national, local, or private that use one of two access codes and number translators (For example, AC1 and AC2) and SPN entries. The E.164 number that enters the Call Server for Converged Office calls must be recognizable so that the call can be routed appropriately. The number is interpreted based upon the access code used within the called number as it enters the Call Server (AC1 or AC2).

If calls that enter the Call Server are international and outside of the country of the caller, the translator must contain entries that recognize the international numbers and route the call to the appropriate route list. These entries are generally within the existing AC1/AC2 translator, as they are used to route international calls that are dialed directly from telephones.

### **E.164 international format numbers for SIP Gateway and SIP CTI**

For information about E.164 international format numbers for SIP Gateway (Computer) calls, see "[E.164 International Format Numbers from Office Communicator - Computer Calls \(SIP Gateway\)](#)" (page 170).

For information about E.164 international format numbers for SIP CTI (Phone) calls, see "[Dialing E.164 International Format Numbers from Office Communicator - Phone Calls \(SIP CTI\)](#)" (page 190).

## **Telephony Gateway and Services planning**

This section describes the planning and engineering issues associated with the Telephony Gateway and Services component.

[Table 14 "Systems, platforms, and applications"](#) (page 66) identifies the systems, platforms, and applications supported by the Telephony Gateway and Services component.

### **Telephony Gateway and Services navigation**

- "[Systems, platforms, and applications](#)" (page 66)
- "[Capacity](#)" (page 67)
- "[Redundancy](#)" (page 67)
- "[SIP routing](#)" (page 67)
- "[Feature Interactions](#)" (page 68)

### **Systems, platforms, and applications**

**Table 14**  
**Systems, platforms, and applications**

<b>System, platform, or application</b>	<b>Supported</b>
<b>M1/CS 1000 Systems</b>	
CS 1000M Cabinet	Yes
CS 1000M Chassis	Yes
CS 1000M Small	Yes
CS 1000M HG	Yes
CS 1000M SG (CP3/4)	Yes

System, platform, or application	Supported
<b>M1/CS 1000 Systems</b>	
CS 1000M SG (CP PIV)	Yes
CS 1000M MG (CP3/4)	Yes
CS 1000M MG (CP PIV)	Yes
CS 1000E	Yes
MG 1000B	Yes

### Capacity

For more information relating to the Telephony Gateway and Services and Remote Call Control components, see ["Capacity planning" \(page 46\)](#).

### Redundancy

Office Communications Server 2007 redundancy model is supported, with limitations, using Load Balancers.

**NRS redundancy** NRS redundancy is similar to Converged Office redundancy; a heartbeat mechanism between MCM 3.0 and NRS servers is implemented. When a heartbeat failure from the primary NRS server is detected, all messages are redirected to the secondary NRS server.

### SIP routing

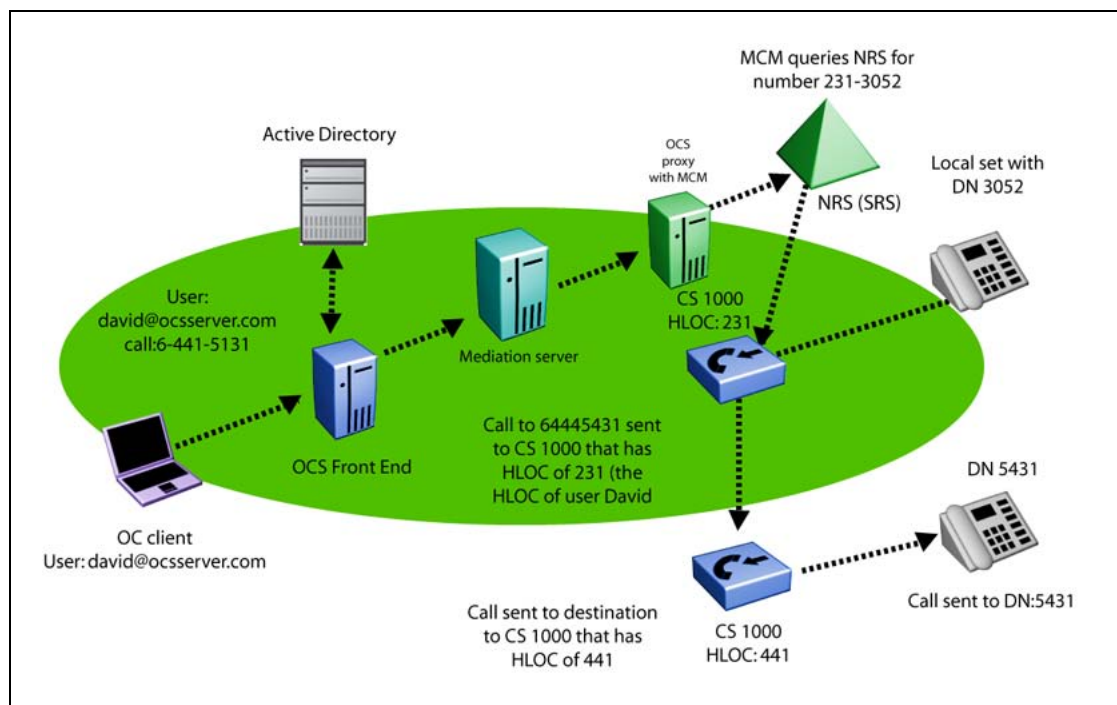
MCM directs calls from an Office Communicator user to the CS 1000 connected to their twinned telephone. A user can have a telephone number in Active Directory associated with their account as depicted in [Figure 22 "SIP Routing" \(page 68\)](#), the number is 231-3052. Calls made from a user to any endpoint (Public or Private) are directed to their CS 1000. The CS 1000 tandems the call to the other CS 1000 (if necessary).

SIP routing ensures the following:

- Outgoing Office Communicator calls made by a twinned client can be tracked by Call Detail Recordings (CDR).
- Calls from an Office Communicator to incompatible systems can be made.

In [Figure 22 "SIP Routing" \(page 68\)](#) the user david@ocsserver.com calls 6-441-5431 (AC1-LOC-DN). The From header in the INVITE has David's Line URI in the format of E.164;ext=2313051. The MCM gets the extension number 2313051 and uses the NRS to find the CS 1000 associated with the number 231-3052 and directs the call. This CS 1000 directs the call to the CS 1000 that has the destination number of 441-5431, which then directs the call to the appropriate end user device.

**Figure 22**  
SIP routing



Calls made to a CS 1000 that is different from the twinned telephone base uses two SIP trunks: one incoming and one outgoing.

Additional SIP trunks are needed, if users commonly call between CS 1000 systems.

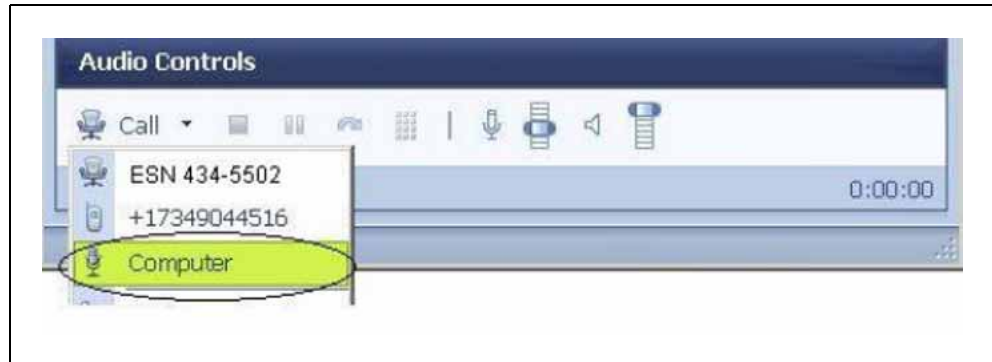
For more information about the number of required SIP trunks, see the calculations described in "Trunking" (page 55) and the platform-specific Planning and Engineering document.

### Feature Interactions

This section describes the interactions of the Telephony Gateway (VoIP) component.

**Call transfers for Office Communicator direct PC-to-PC call** If an Office Communicator user sets up a call in Computer mode to another Office Communicator user directly, the call is sent to a Computer instead of a telephone number as depicted in Figure 23 "Computer call" (page 69). As a result, the CS 1000 is not involved in the call and cannot transfer it to a telephone number.

**Figure 23**  
**Computer call**



**LG-Nortel IP Phone 8540 OCS desk phone** An Enterprise Voice only client (no PBX integration enabled) that is configured for an OC 2007 client or 8540 OCS desk phone, will be able to make PSTN calls using the CS 1000 as the gateway. You are required to configure a TN and twinned PCA on the CS 1000 even if there is no actual phone present for this client. This is because the MCM will perform homing on each OC client that makes an outgoing call before allowing it to proceed with the call.

**Mixed network with SPS and SRS servers** On a mixed network where both SPS and SRS servers are present, MCM must be configured in SRS mode for collaboration server routing to work properly.

**RCC only mode** Nortel recommends you do not define users with RCC only mode since certain restrictions apply to this functionality. For example, a PCAM class of service should not be defined for these users.

**Bandwidth usage direct OC-to-OC audio call** The bandwidth usage of a Mediation Server direct OC-to-OC audio call is not calculated on the CS 1000. This portion of the required bandwidth should be calculated with Microsoft consultation and added to the Nortel bandwidth recommendations for Converged Office users. Failure to do so might impact the quality of the Converged Office calls in case bandwidth usage exceeds the planned limits.

**Microsoft CFAC** Microsoft does not support Call Forward All Calls (CFAC) to voice mail on the OC client when users have Call Forward No Answer (CFNA) configured to voice mail and not Office Communicator. In order to have this functionality for an Enterprise Voice user with PBX integration, voice mail should be configured on the user's phone. If the user is in VoIP only mode (no phone) then the only option is for the administrator to configure the PCA with Call Forward No Answer (CFNA). In this case, the calls will ring 4 times before being redirected to voice mail.

**Office Communicator-initiated Call Transfer in Computer and PBX Integration Enabled** If the Office Communicator transfers a call, the SIP stack of the CS 1000 must handle the request to transfer the call. As such, the number a user is transferred to is not subject to the Class of Service associated with either user (the transferred party or the party performing the transfer). The Class of Service and Call Restriction that control the transfer is that of the SIP trunk itself.

**Multiple customer operation** Multiple customer operation is not supported within a single Signaling Server; a separate Signaling Server is required for each customer. Each customer configured on the Call Server requires a separate node number and domain. For more information about how to configure a multiple customer environment, see "[Multiple customer network](#)" (page 40).

**Deployment** You can find all of the information required to support Office Communications Server 2007 and Microsoft Office Communicator deployment on the Microsoft Web site. Download Microsoft technical documentation from the Download Center at [www.microsoft.com](http://www.microsoft.com).

MCM 3.0 uses LDAP queries to the Active Directory server for some OC user's attributes. You must engineer the Active Directory server properly to provide the expected performance for the LDAP queries (less than 25 milliseconds). Office Communications Server and Active Directory APIs are used for queries and mapping.

**Office Communications Server 2007 availability** The Office Communications Server 2007 delivers an availability of up to 99.99% as described on the Microsoft Web site at [www.microsoft.com](http://www.microsoft.com). This is a Microsoft limitation.

**Office Communications Server 2007 redundancy** The Office Communications Server 2007 redundancy model is supported, with limitations, using Load Balancers. For more information, see Load Balancer.

**Office Communicator Web Access** Converged Office requires the client support SIP Gateway functionality. The Web version of Office Communicator, called Office Communicator Web Access, does not support SIP Gateway. Therefore, Office Communicator Web Access does not work with Converged Office.

**Office Communicator Mobile** Converged Office requires the client to support Telephony Gateway. The Mobile version of Office Communicator, called Office Communicator Mobile (COMO), has limited support for Telephony Gateway. Telephony Gateway is only supported when the device runs Windows Mobile 5.0. VoIP calls work for incoming calls, but outgoing

VoIP calls can only be placed to other Office Communicator users (computer to computer calls). Outgoing VoIP calls to telephone numbers for Microsoft Office Communicator Mobile are not supported.

**Microsoft Virtual Server 2005** Microsoft Virtual Server 2005 is not supported as part of Nortel Converged Office.

**DTMF** CS 1000 supports in-band DTMF digits and out-of-band DTMF digits for SIP calls through RFC2833. RFC2833 is an out-of-band mechanism for DTMF signaling. DTMF digit handling using RFC2833 enables Nortel CS 1000 products to work with other SIP products that support out-of-band DTMF signaling.

With RFC2833, a key press on a telephone translates to a signaling packet (or packets) that flow with the VoIP stream to the far end. These signaling packets are RFC packets which contain the DTMF key that was pressed. The same principle applies to TDM devices that are involved in a VoIP call. The Voice Gateway (VGW) TN that converts the TDM stream to VoIP also detects a tone on the TDM side and translates it to RFC2833 packets on the VoIP side. The VGW TN can receive an RFC2833 packet on the VoIP side and generates a tone on the TDM side.

Configure the correct Loss Values for in-band DTMF. For more information about configuring the CS 1000 to support in-band DTMF tones, see ["Configuring the Call Server" \(page 151\)](#).

**2050 Soft phones** Due to RFC2833 not being supported, 2050 soft phones are not recommended to be deployed in a network with OCS 2007 components.

**ITG-Pentium cards** ITG-Pentium cards are not supported (regardless of load) due to RFC2833 not being supported.

**Multimedia Communicator Server MeetMe Conference support** In Release 5.0, there are no limitations for Office Communicator calls to the Multimedia Communicator Server (MCS) MeetMe bridge provided that all tandem nodes run Release 5.0 software.

**Codecs** G.711 A/MU law is supported for the Mediation Server. The G.711 codec must use a 20-ms payload at this time, due to the Microsoft Office limitation. The Mediation Server does not support G.723 and G.729.

**Video support** Office Communicator video is supported for Remote Call Control between two Office Communicator clients and VoIP calls directly between two OC clients without going through the Mediation Server. Office Communicator video is not supported if one of the clients goes through the Mediation Server.

**Video Call Transfer** Office Communicator calls made in Computer mode that have established video can transfer to another Office Communicator user in Computer mode—although the new call is audio only. The transferred Office Communicator user experiences the call becoming audio only. After the transferred call is answered by the new endpoint, video can be established. As with all Call Transfers in Computer mode, it is a Blind Call Transfer, where the call is immediately transferred to the new party.

**Local Tones** Office Communicator supports the generation of local tones (for example, Ringback), but the tones that the Office Communicator generates are unique tones that are not specific to any country. Ringback is generated only for a configured number of cycles; after which the other end continues to ring, but there is no audible ringback.

**Quality of Service** Office Communicator does not support Quality of Service (QoS) (L2: 802.1p/q or L3: diffserv).

**Voice mail** Voice mail is not supported for direct Office Communicator calls. Voice mail is supported only with PCA , SimRing, and CD1 Call Forward No Answer and MCS 5100 Advanced Screening calls.

**Long distance/overseas control** Long distance or overseas calls from Office Communicator are allowed based on the Network Class of Service (NCOS) for the MARP TN of the number and extension associated with the Office Communicator user. For example, if user david@ocsuser.com has a number and extension of 3052, david@ocsuser.com can call the same long distance and overseas numbers that the number and extension 3052 can on the CS 1000. For more information, see "[Configuring the Call Server](#)" (page 151).

**MCS 5100** MCS 5100 interoperability and federation with Office Communications Server requires that a CS 1000 reside between the two servers, and is limited to voice.

**SIP Trunks** TCP or TLS-based SIP trunks are supported. SIP trunks and gateways must be enabled with enough trunks to handle the traffic between the CS 1000 and Office Communications Server. For more information, see "[Trunking](#)" (page 55).

**Phone mode** Office Communicator supports phone mode where it controls the desktop telephone to originate or answer calls and the VoIP mode where voice calls can originate or be answered from the client.

**Hold and Transfer** Office Communicator supports Hold and Transfer in stand-alone or VoIP mode.



**ipDialog Ethernet Phone** Office Communicator clients can work with the ipDialog Ethernet Phone only if it is tandemed through a CS 1000.

**Country or region tone configuration** Country or region tone configuration is not supported by Office Communications Server or Office Communicator.

**Conference** Incorrect participants are displayed on the conference conversation window in the following scenario. For example, User A makes a call by SIP alias in Office Communicator–Computer mode to User B in Office Communicator–VoIP mode. User B answers the call and conferences in User C in Office Communicator–VoIP mode. User C is invited to the conference by phone number. User C joins the conference. This results in four participants being displayed in the conversation window instead of three. This is a Microsoft limitation and can be reproduced when the CS 1000 system, Mediation Server outbound routing, and static Front End routes are disabled.

**Active Directory configuration** A record in the Active Directory must be created for all CS 1000 phones whether there is an Office Communicator client associated with it or not. If a CS 1000 phone is not in the Active Directory, an OC client user will notice the following:

- Cannot add the telephone number to the Office Communicator Contact List.
- Will receive two toasts when calls are made from these telephones.

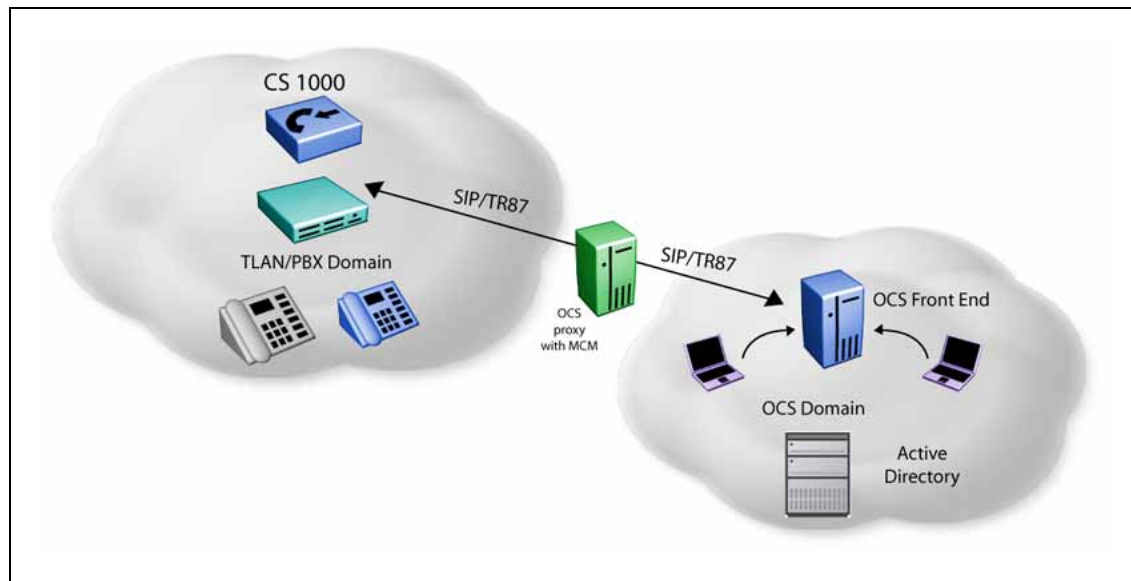
**DTMF detection** In order to handle DTMF detection properly with OCS 2007, all network components must support RFC 2833 which means all Branch or Main offices need to be running a Release. 5.0 software as a minimum. Otherwise there will be problems interacting with Interactive Voice Response (IVR) systems, collect calls, using meet-me conference bridges, and so on.

## Remote Call Control with SIP CTI

The Remote Call Control component works in all configurations that include a Signaling Server and is supported for IP, digital, and analog telephone types.

Office Communicator client uses the ECMA TR/87 specification. [Figure 24 "Simple network diagram" \(page 74\)](#) shows a sample customer network that deploys Active Directory, the OCS 2007 Front End, OCS proxy server with MCM, and CS 1000.

**Figure 24**  
Simple network diagram



The TR/87 FE is the application that resides on the CS 1000 Signaling Server to support the telephony control requests and responses received from the Office Communicator 2007 client within an Office Communications Server 2007 deployment.

CS 1000 is supported in both the Office Communications Server 2007 Standard Edition and Enterprise Edition network configurations. For more information about restrictions, see "[Capacity planning](#)" (page 46).

[Table 15 "Supported systems, platforms, and applications"](#) (page 74) identifies the systems, platforms, or applications that are interoperable or supported by the Remote Call Control component. Interoperable means that this feature will not negatively impact any existing functionality (regardless of whether this feature actually interacts with the system, platform, or application).

**Table 15**  
Supported systems, platforms, and applications

Systems, platforms, and applications	Interoperable	Supported
<b>M1/CS 1000 systems</b>		
Option 11C Cabinet	Y	N
Option 11C Chassis	Y	N
Option 61C (CP-P11 and -P1V)	Y	N
Option 81C (CP-P11 and -P1V)	Y	N

<b>Systems, platforms, and applications</b>	<b>Interoperable</b>	<b>Supported</b>
CS 1000M SG (CP-P11 and -PIV)	Y	Y
CS 1000M SG (CP PIV)	Y	Y
CS 1000M MG (CP-P11 and -PIV)	Y	Y
CS 1000E SA/HA (CP-P11, -PIV, and -PM)	Y	Y
MG 1000T (SSC)	Y	N
MG 1000B (MGC and CP-PM)	Y	Y*
MG 1000E (MGC)	Y	Y*
* Digital and analog telephones in Branch Offices are supported when access to the proxy/redirect server and OCS 2007 is available.		
<b>Other systems, call servers and gateways</b>		
CS 2000	Y	Y
CS 2100	Y	Y
MCS 5100/CD	Y	N
SRG 1.0	Y	Partial*
SRG 50	Y	Partial*
BCM 50	Y	Partial*
BCM 200/400	Y	Partial**
Norstar VoIP Gateway (NT9B10AA)	Y	N
NetRIO Service Management Center (SMC)	Y	N
* Telephones in normal mode (network connection to the main office up) are supported. No RFC 2833 support. Tandem calls out of a BCM/SRG from OCS with DTMF do not work.		
<b>Nortel applications</b>		
IP Phone 2001	Y	Y
IP Phone 2002 Phase I	Y	Y
IP Phone 2002 Phase II	Y	Y
IP Phone 2004 Phase 0/I	Y	Y
IP Phone 2006	Y	Y
IP Audio Conference Phone 2033	Y	Y
IP Softphone 2050	Y	N
Mobile Voice Client 2050	Y	N
WLAN Handset 2210	Y	Y
WLAN Handset 2211	Y	Y

<b>Systems, platforms, and applications</b>	<b>Interoperable</b>	<b>Supported</b>
WLAN Handset 2212	Y	Y
IP Phone 1110	Y	Y
IP Phone 2007	Y	Y
IP Phone 1120E	Y	Y
IP Phone 1140E	Y	Y
IP Phone 1150E	Y	Y
TDM Phones M3900 series	Y	Y
M3000	Y	Y
M2317	Y	Y
M2006	Y	Y
M2008	Y	Y
M2316	Y	Y
M2016S	Y	Y
PC Console Interface Unit	Y	Y
CDR	Y	N
Telephony Manager (TM)	Y	Y
Element Manager (EM)	Y	Y
Element Subscriber Manager (ESM)	Y	N
Call Pilot	Y	N
Call Pilot Mini	Y	N
Meridian Mail	Y	N
Meridian Mail Card Option	Y	N
Meridian/Succession Companion DECT (DMC8 version)	Y	N
VoIP-802.11 Wireless IP Gateway	Y	N
Remote Gateway 9150	Y	N
Meridian Home Office MHO-II – MD'ed	Y	N
Remote Office 9115/ IP Adaptor	Y	N
Carrier Remote	Y	N
Fiber I and Fiber II	Y	N
Symposium Desktop TAPI Service Provider for MCA	Y	N
Meridian Link Services [MLS]	Y	N
Symposium TAPI Service Provider	Y	N

<b>Systems, platforms, and applications</b>	<b>Interoperable</b>	<b>Supported</b>
Symposium Agent	Y	N
Symposium Agent Greeting	Y	N
Symposium Express Call Center (SECC)	Y	N
Symposium Call Center Server [SCCS]	Y	N
Symposium Web Centre Portal (SWCP)	Y	N
Periphonics Open IVR (VPS/is)	Y	N
Periphonics Integrated Package for Meridian Link (IPML) – VPS	Y	N
Periphonics Multimedia Processing Server (MPS) 100	Y	N
Periphonics Multimedia Processing Server (MPS) 500	Y	N
Integrated Call Assistant	Y	N
Integrated Conference Bridge	Y	N
Integrated Recorded Announcer	Y	N
Integrated Call Director	Y	N
Hospitality Integrated Voice Services (HIVS)	Y	N
Enterprise Data Networking	Y	N
UM2000	Y	N
Multimedia Application Server MAS	Y	N
Nortel Multimedia Conference	Y	N
<b>Third party applications</b>		
Application gateway 1000	Y	N
Microsoft Office Communication Server	Y	N
MS Exchange Server	Y	N
MS Virtual Server 2005	Y	N
Audio Code Mediant 2000 SIP-PRI Gateway	Y	N
<b>Competitors</b>		
Cisco H.323 GW	Y	N
Avaya H.323 GW	Y	N
Cisco SIP GW	Y	N
Avaya SIP GW	Y	N
Verizon SIP Trunk	Y	N

Systems, platforms, and applications	Interoperable	Supported
AT&T SIP trunk	Y	N
Broadsoft	Y	N
ACME SBC	Y	N
3100 Mobile Communication Gateway	Y	N

## Redundancy

Remote Call Control (RCC) services are supported (with limitations) in the following scenarios:

- Single node redundancy
- Campus redundancy
- Geographic redundancy

### Single node Redundancy

The same master and follower mechanism used for Virtual Trunk (VTRK) and TPS applications is used to support redundancy within a node for RCC. After the master of the node fails, one of the followers takes over the node IP and continues to deliver service. VoIP mode session state is preserved when a new master is elected.

Redundancy across multiple nodes is possible using the Least Cost Routing feature of NRS. When considering a multinode redundant configuration, see the restrictions on establishing TR/87 sessions from multiple nodes that have AML links to a single Call Server. For more information, see "[Capacity planning](#)" (page 46) .

### Campus redundancy

Campus Redundancy increases the distance between the two CPU cores of CS 1000E.

The CS 1000E is the only large system that supports this feature.

### Geographic redundancy

Geographic Redundancy can be supported with the limitations that currently exist for SIP gateway SIP traffic. The main impacts are.

- During transition periods, situations can arise where IP phones are registered to a Call Server that is different from the call server that provides support for the TR/87 FE. In this situation, TR/87 support is undefined. TR/87 clients can register successfully; however, the status of the IP Phone is impacted by any actions performed on the telephone or the TR/87 client, as the FE and IP Phone interface different Call Servers. NRS is required to support redundancy.

- After an event occurs that causes the IP Phones to register to a server other than the Front End server (and then to return to the Front End server), the Office Communicator 2007 client does not automatically follow the IP Phone registration. To direct the TR/87 sessions back to the TR/87 FE that corresponds to the home TPS, take one of the following actions:
  - Users must log out and log back onto the TR/87 client (for example, Office Communicator 2007) to force the previous SIP dialog to terminate so that a new dialog can be established, which NRS redirects to the correct TR/87 FE.
  - An administrator issues the SIPCTIStop all command on the Signaling Server on which the TR/87 sessions currently reside to terminate the SIP dialogs. This forces the clients to send another association request (for example, SIP INVITE), which the NRS redirects to the correct TR/87 FE, as depicted in [Table 16 "SIPCTIStop all command"](#) (page 79).

**Table 16**  
**SIPCTIStop all command**

Command	Description
SIPCTIStop all	De-acquire all AST DNs and terminate all TR/87 SIP sessions.

### **Branch Office redundancy (MG 1000B/SRG)**

Branch Office scenarios can be supported; however, SIP CTI support and Telephony Gateway and Services are available for Branch User IP Phones in Local mode (registered in the Branch Office) only when the following conditions are met:

- The Branch Office has SIP CTI and Telephony Gateway and Services enabled and has a Signaling Server dedicated to each branch.
- The network dialing plan is a Coordinated Dialing Plan (CDP).
- The IP Phone (Branch User) has the same domain name configured in both the Main Office and Branch Office.
- The Branch Office has access to the NRS and Office Communications Server (OCS). If access is disrupted, failure cases may not be supported if the NRS and OCS are located in close proximity to the Main Office, which is no longer available. For example, when the WAN link to the Main Office is down, the NRS and OCS are out-of-service.
- The SIP Gateway in the Main Office is out -of-service (in which case the SIP Gateway in the Branch Office is used).


The Microsoft Office Communicator client has no automated mechanism to register to the branch. Users must wait for the existing dialog to time out (30 minutes) or manually log out and log on again after the IP phones change to local mode.

Digital and analog telephones in the Branch Office can have Remote Call Control (RCC) and PBX Integration Enabled support when the Branch Office has access to the NRS and OCS.

### Feature Interactions

This section describes the interactions of the Remote Call Control with SIP CTI component.

**Table 17**  
**Feature Interactions of RCC**

Feature Operation	Description
Call Forwarding	<p>Office Communicator does not reflect call forward state changes made to the CS 1000 telephone itself.</p> <div style="border: 1px solid black; padding: 10px; margin: 10px 0;">  <p><b>WARNING</b> <b>Call Forward state changes</b></p> <p>Office Communicator does not reflect Call Forward state changes made to the CS 1000 telephone. When Office Communicator is active and controls a DN, make Call Forward changes through Office Communicator to ensure that it is in the correct state.</p> <p>When a user logs on to the OCS 2007 from their Office Communicator client, the forwarding status saved within Office Communicator overrides the forwarding status configured from the telephone. For example, if forwarding is off within Office Communicator, it is turned off following log on, regardless of the phone forwarding status at the time.</p> </div>
Analog telephone usage	<p>As a general rule, Office Communicator in phone mode can only control and invoke telephony features supported by the telephone. If a feature is not supported or configured on a particular telephone (either Analog, IP, or Digital), it is not supported by Office Communicator. An Office Communicator in phone mode that supervises an analog phone (2500) has the following limitations:</p> <ul style="list-style-type: none"> <li>• Make Call - cannot be made through Office Communicator if the analog phone (2500) phone does not go off-hook prior to placing the call.</li> <li>• Answer Call - cannot be performed through Office Communicator. Answer Call must be performed through the analog phone (2500).</li> </ul>



Feature Operation	Description
	<ul style="list-style-type: none"> <li>• Conference Call - cannot be performed through Office Communicator .</li> <li>• Call Hold - can be performed through Office Communicator.</li> <li>• Call Transfer - Analog telephones do not support the Conference and Transfer key features. As a result, Call Conference and Call Transfer (Announced and Blind) cannot be performed through Office Communicator. Flexible Feature Code (FFC) is not supported by AML and RCC.</li> <li>• Send DTMF digits - DTMF digits work with both Voice Mail and Conferencing.</li> </ul>
Multiple Customer operation	Multiiple Customer operation is not supported within a single Signaling Server; a separate Signaling Server is required for each customer. Multi-customer support is a consideration for future releases. For more information about how to configure a Multi-Customer environment, see " <a href="#">Multiple customer network</a> " (page 40).
TR/87 Front End application	The TR/87 FE application on a Signaling Server can support only a single Call Server.
UDP Location Code	Only one UDP Location Code can be associated with each Signaling Server TR/87 interface.
AML interaction	CS 1000 has an Application Module Link (AML) limitation where only one application can acquire a DN or TN at any time. For example, the TR/87 FE application and IP Call Recording feature cannot coexist on the same DN or TN. This also applies to the interaction between Symposium and Office Communicator Remote Call Control. Symposium uses the AML to acquire and control telephones on the CS 1000 Call Server.
Office Communicator Web Access	Converged Office requires that the client support RCC. The Web version of Office Communicator, called Office Communicator Web Access, does not support RCC.
Office Communicator Mobile (COMO)	Converged Office requires the client to support Remote Call Control, but the Mobile version of Office Communicator, called Office Communicator Mobile, has limited support for Remote Call Control. Outgoing VoIP calls to telephone numbers for Office Communicator Mobile are not supported. Remote Call Control only permits telephone status updates (for example, on a call or not) when you use Office Communicator Mobile. Remote Call Control supports Call Forward with COMO.
Virtual Server 2005	Virtual Server 2005 is not supported as part of Nortel Converged Office.
Office Communicator 2007 Call Forward All Calls	When the CS 1000 Call Forward All Calls feature is enabled, only calls to the Prime DN or any single-appearance DN on the telephone are forwarded. Therefore, if an Office Communicator 2007 acquires a MADN, and it is not the Multiple Appearance Redirection Prime (MARP), the call is not forwarded even if the Call Forward feature is enabled. For more information, see <i>Features and Services</i> (NN43001-106).

Feature Operation	Description
Office Communications Server and MCS coexistence	<p style="text-align: center;"><b>ATTENTION</b></p> <p>All Converged Office users must have their extension configured as CLS CDMR.</p> <p>A user cannot have both Office Communications Server and MCS enabled for their extension (all TN's that have a particular number and extension). If any of the TN's have CLS CDMV or CLS CDMO configured, the extension is treated as having MCS enabled. When MCS (SIP CD) is enabled on an extension, Office Communications Server Converged Office is not supported for that extension in Release 4.5B and 5.0.</p>
CallPilot configuration	For PBX Integration Enabled (Computer Mode) calls to access the CallPilot mailbox, the Pound key (#) is pressed. Every mailbox must have the optional messaging network configured. In a normal CS 1000 - CallPilot scenario, this configuration is optional. For PBX Integration Enabled (Computer Mode) calls to CallPilot to work properly, this extra configuration is required. For more information about the configuration of CallPilot, see <i>CallPilot Network Planning Guide</i> (NN44200-201).
Conference Call and Do Not Disturb (DND) features	Conference Call and DND features in RCC mode are not supported by Microsoft.

## LCS 2005 and OCS 2007 coexistence

This section describes the coexistence limitations of LCS 2005 and OCS 2007.

### Client considerations

Features hosted on Office Communications Server 2007 are not supported by the OC 2005 client. After a user is configured for enhanced presence, the account can no longer use previous versions of OC 2005, Communicator Web Access 2005, or Communicator Mobile 2005. Microsoft recommends that you upgrade all client computers for a particular user at the same time. Communicator 2007 clients cannot log on to Live Communications Server 2005. Verify that any user whose client is upgraded to Communicator 2007 is already provisioned on an Office Communications Server.

### Converged Office functionality

An upgrade from the LCS Application Proxy to the OCS Proxy Server and MCS 2.0 to MCM 3.0 is required to manage CS 1000 telephones by the OC 2007 client in either VOIP or RCC mode. Inter-working of MCM 2.0 with OCS Proxy Server or MCM 3.0 with LCS Application Proxy is not a

supported configuration because of incompatible underlying libraries. The same CS 1000 can be connected to two or more different communication servers (LCS 2005 or OCS 2007).

The following must be considered for coexistence of LCS 2005 and OCS 2007:

- The CS 1000 must be upgraded to Release 5.0 with the required Product Enhancement Packages (PEPs) .
- OCS 2007 patches from Microsoft must be in service. For more information, see the Attention box under "[OCS 2007 component installation](#)" (page 105).
- NRS is required to appropriately route a call to the Communication Server.
- Different server DNs (Hot Ps) are assigned for each Communications Server (LCS or OCS). The PCA for each user is configured with the corresponding server DN as a target DN
- LCS 2005 and OCS 2007 can share the same Active Directory but you can only have one OC client user account on either LCS 2005 or OCS 2007.
- For Remote Call Control (RCC) support , a single Signaling Server cannot be used for both LCS 2005 and OCS 2007 as the configuration of the SIP CTI FE is different for both. In this case, the following options can be considered:
  - RCC supported for both LCS 2005 and OCS 2007. Upgrade the existing Communication Server 1000 to support OCS 2007 RCC users. Configure an additional SIP CTI FE Signaling Server for LCS 2005 RCC users. An additional AML ELANs is defined on the Call Server. Change the static routing rule on the LCS 2005 Home server to route RCC traffic directly to the SIP CTI FE for LCS 2005. Geographic Redundancy is not supported for LCS 2005 RCC users in this case.
  - RCC supported for only LCS 2005 users. Enable RCC only for LCS users in the Active Directory, on the OC clients, or both. The SIP CTI FE should be configured according to the document *Nortel Converged Office Fundamentals* (NN43001-525) for LCS 2005. For example, the Phone context=dialstring configuration on the Signaling Server is used.
  - RCC supported only for OCS 2007 users. Enable RCC only for OCS users in the Active Directory, on the OC clients, or both. The SIP CTI FE should be configured according to this document. For example, the Phone-context=<SIP URI Map Entries> configuration on the Signaling Server is used.

### MCM 2.0 to MCM 3.0

There is no direct upgrade path from MCM 1.0 or 2.0 to MCM 3.0 . MCM 3.0 must be installed on the OCS Proxy server. The OCS Proxy install is done from command line and not from the install wizard. It is still possible to preserve the configuration data from a previous installation by first performing a backup operation on MCM 2.0 and restore the data to MCM 3.0 on the OCS Proxy server. However, this will cause the new configuration parameters to be set to default values as follows:

**Table 18**  
Default configuration parameters

Parameter	Default value
Call Server	CS1000
MediationServer	enabled
RoutingTable	empty
DialPlan	CDP
AccessCode	empty

For more information on MCM 3.0 configuration, see "[MCM configuration](#)" (page 134)

### Load balancer considerations

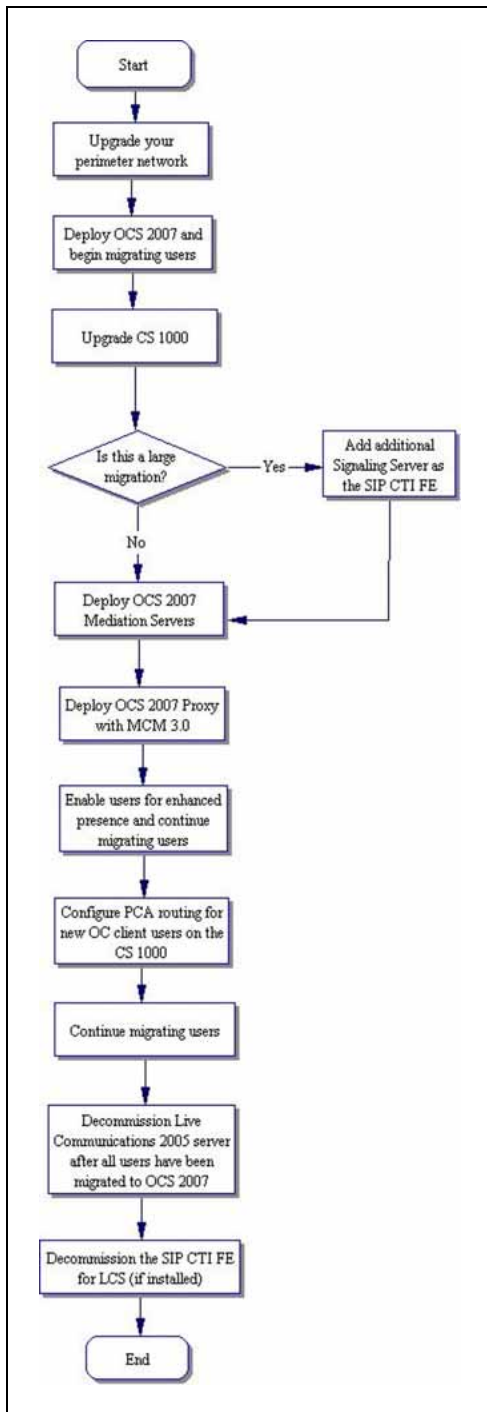
You cannot use a single logical load balancer for LCS 2005 and OCS 2007. For example, if you have an LCS 2005 application proxy with MCM 2.0 attached to a logical load balancer, you cannot simultaneously attach an OCS Proxy server with MCM 3.0 to the same one. This same restriction applies to all other server roles.

### Migration planning from LCS 2005 to OCS 2007

Live Communications Server 2005 with SP1 can only be upgraded to Office Communications Server 2007 by using a side-by-side migration. This involves deploying an Office Communications Server 2007 Standard Edition or Enterprise pool alongside existing Live Communications Server 2005 with SP1 Standard Edition or Enterprise pool thus allowing the two environments to coexist with minimal service disruption.

When migrating servers, Office Communications Server 2007 servers should be deployed using a phased, outside-in approach. This involves replacing the Access Proxies with Office Communications Server 2007 Access Edge Servers before you migrate to Office Communications Server 2007 in your internal environment. Upgrading all the servers of a particular type at one time will help to minimize service disruptions.

The following flow chart depicts the migration phases:



### Prerequisites

Upgrading to Office Communications Server 2007 assumes the following:

- An understanding of the basic migration process.

- An understanding of the coexistence interactions. For more information, see "[LCS 2005 and OCS 2007 coexistence](#)" (page 82).
- An understanding of CS 1000, Signaling Server, and networks.
- An understanding of the user migration process.

### Determine your deployment options

There are two deployment options depending on whether you are migrating a small or large client base.

For a small client base, Office Communicator client users can be migrated from LCS to OCS inside a set maintenance window. No extra servers are required.

For a large client base, Office Communicator client users need to be migrated over multiple maintenance windows using a phased approach. The following choices must be made:

1. If using one SIP CTI FE Signaling Server
  - Only LCS users have RCC

**OR**

  - OCS users have RCC
2. If deploying an additional SIP CTI FE Signaling Server
  - RCC is supported for both LCS and OCS. One Signaling Server for LCS RCC and the other for OCS RCC

#### ATTENTION

Before migrating to Office Communications Server 2007, existing Live Communications Servers must have Live Communications Server 2005 SP1 installed.

### Migration process

The following table breaks down the migration process using a phased, outside-in approach and defines the impact for the user at each phase.

**Table 19**  
**User experience**

Phase	Description	User experience
1. Upgrade your perimeter network.	Introduce a new Office Communications Server (OCS) 2007 Access Edge Servers and Directors into your Live Communications Server (LCS) 2005 SP1 environment.	No changes. Users continue to use the Microsoft Office Communicator (OC) 2005 client and have the same IM and presence functionality.

Phase	Description	User experience
2. Deploy OCS 2007 and begin moving users to the new server or pool.	Deploy a new Office Communications Server 2007 Enterprise pool or Standard Edition server. If required, deploy an Archiving and CDR Server. Users are moved to the new server or pool but will continue to use OC 2005 .	No changes. OC 2007 client is not rolled out at this phase so users continue to use OC 2005 and have the same IM and presence functionality.
3. Upgrade CS 1000 and if determined for your migration, add an additional Signaling Server as the SIP CTI FE.	Upgrade Call Server and Signaling Server. The feature is provided as a Product Enhancement Package (PEP) for Release 5.0 Call Server and Signaling Server. If you have a large client base, add an additional Signaling Server as the SIP CTI FE so both LCS 2005 and OCS 2007 can have RCC.	No changes. Users continue to use OC 2005 and have the same IM and presence functionality.
4. Deploy OCS 2007 Mediation Server.	Deploy OCS 2007 Mediation Servers.	No changes. Users continue to use OC 2005 and have the same IM and presence functionality
5. Deploy OCS Proxy server with MCM 3.0 .	Deploy OCS Proxy Server with MCM 3.0 .	No changes. Users continue to use OC 2005 and have the same IM and presence functionality
6. Enable enhanced presence, roll out OC 2007 client, and continue migrating users	Enable users for enhanced presence, roll out the OC 2007 client, and the Live Meeting 2007 client to the users.	<ul style="list-style-type: none"> <li>The migrated users can use the full functionality of OC 2007 when communicating with other migrated users.</li> <li>Once enabled for enhanced presence, these users can no longer sign in to a OC 2005 client or previous Communicator Web Access or Communicator Mobile Access clients.</li> </ul>
7. Configure PCA routing for new OC 2007 client users on the CS 1000.	Configure PCA on the CS 1000. Change NRS and SPS routing.	Migrated users are able to use Telephony Gateway and Services functionality (VoIP) and RCC.

Phase	Description	User experience
8. Continue migrating users.	Migrate remaining users. Enable users for enhanced presence. Roll out the OC 2007 client and the Live Meeting 2007 client to the users.	<ul style="list-style-type: none"> <li>• OC 2007 users can use the full functionality of OC 2007 when communicating with other OC 2007 users.</li> <li>• When OC 2007 client users are communicating with OC 2005 users, they cannot use the new features in OC 2007.</li> <li>• After Live Meeting 2007 is rolled out to your users, they can participate in on-premise conferences internally and connect to these conferences remotely by using the Web Conferencing Edge Server.</li> <li>• RCC is only available to either OCS 2007 or LCS 2005 users when one SIP CTI FE Signaling Server is deployed. For more information, see "<a href="#">Converged Office functionality</a>" (page 82).</li> </ul>
9. Decommission all Live Communications 2005 servers and MCM 2.0 after all users have been migrated to OCS 2007	Remove Live Communications Server 2005 and MCM 2.0 from your environment.	All users are on OC 2007, enabled for enhanced presence and have full functionality of OC 2007. If Live Meeting is deployed, users can participate in on-premise conferences internally and connect to these conferences remotely by using the Web Conferencing Edge Server.
10. Decommission the SIP CTI FE for LCS (if installed)	Remove the SIP CTI FE for LCS (if an additional Signaling Server was deployed).	None.

### Description of Migration Phases

To deploy OCS 2007 in an existing Live Communications Server 2005 topology, Nortel recommends the following phases:



---

## Migrating users from LCS to OCS

---

Step	Action
------	--------

---

- 1 Upgrade your perimeter network by deploying an Access Edge Server that communicates with Live Communications Server 2005 Director. When Director is not deployed, the edge server communicates directly with your internal Live Communications Server 2005 Standard Edition servers or Enterprise pool and the new Access Edge Server is configured as the next hop server to which existing pools and Standard Edition Servers will route external traffic. Next, an Office Communications Server 2007 Director is deployed to replace Live Communications Server 2005 Director. Incoming and outgoing traffic is configured to go through the new Director (if a Director was previously not used and you do not want to use one now, this step can be skipped). For more information, download Microsoft technical documentation from the Download Center at [www.microsoft.com](http://www.microsoft.com).
- 2 In this phase, an internal Office Communications Server 2007 Standard Edition Server or Enterprise pool is deployed. Move an initial group of users to the new server or pool but they will continue to use OC 2005 as their client. If required, deploy an Archiving and CDR Server. DNS update is required next. For more details, see "[LCS 2005 and OCS 2007 coexistence](#)" (page 82).
- 3 Upgrade CS 1000 and if determined for your migration, add an additional Signaling Server as the SIP CTI FE. Upgrading Call Sever and Signaling Server according to standard procedures. For more information, see "[LCS 2005 and OCS 2007 coexistence](#)" (page 82).
- 4 Deploy OCS 2007 Mediation Server. For more information on deploying Mediation Server, download Microsoft technical documentation from the Download Center at [www.microsoft.com](http://www.microsoft.com).
- 5 Deploy OCS Proxy server with MCM 3.0 . For more information, see "[OCS Proxy server installation](#)" (page 107) and "[MCM installation](#)" (page 109).
- 6 Enable enhanced presence and continue migrating users. Start to move users from Live Communications Server 2005 to Office Communications Server 2007. By enabling enhanced presence, users are allowed to use Office Communicator 2007 and the new functionality that it provides. After enabling the users for enhanced presence, roll out OC 2007 client to each computer for these users. Once a user is enabled for enhanced presence, they can no longer use any previous client versions. For more information on enhanced presence, download Microsoft technical documentation from the Download Center at [www.microsoft.com](http://www.microsoft.com).

- 7 Configure PCA routing for new OC client users on the CS 1000. After configuration of PCA routing, users will be allowed to use Telephony Gateway and Services (VoIP) and RCC functionality. A Server URI field should be changed for migrated users to enable SIP CTI functionality. Change NRS and SPS routing.
- 8 Continue migrating users. Enable users for enhanced presence. Roll out the OC 2007 client and the Live Meeting 2007 client to the users. For more information on enhanced presence, download Microsoft technical documentation from the Download Center at [www.microsoft.com](http://www.microsoft.com).
- 9 Decommission all Live Communications 2005 servers and MCM 2.0 after all users have been migrated to OCS 2007.
- 10 Decommission the SIP CTI FE for LCS (if installed).

---

—End—

---

## Unified Messaging

This section describes the interactions and inter-workings of Unified Messaging (UM) with Converged Office. Office Communications Server (OCS) 2007 users can access Unified Messaging capabilities using CallPilot or Exchange Server 2007. Features that are accessible to the OCS 2007 users from CallPilot or Exchange depend on how the deployment is performed. The following sections describe the user experience based on deployments when using CallPilot, Exchange integrated with OCS, and Exchange non-integrated with OCS. For more information on the signaling that takes place in an integrated or non-integrated configuration, see "[Signaling with integrated Voice Mail](#)" (page 97) and "[Signaling with non-integrated Voice Mail](#)" (page 98).

### Unified Messaging navigation

- "[OCS 2007 users using CallPilot](#)" (page 90)
- "[OCS 2007 users using UM 2007—integrated](#)" (page 92)
- "[OCS 2007 users using UM 2007—non-integrated](#)" (page 95)
- "[Signaling with integrated Voice Mail](#)" (page 97)
- "[Signaling with non-integrated Voice Mail](#)" (page 98)

### OCS 2007 users using CallPilot

The table depicts Voice Mail access for OCS 2007 users using CallPilot in the following configurations.

**Table 20**  
**CallPilot configurations**

	OC User (VoIP) with RCC and CS 1000 Phone	OC User (VoIP) with no RCC and CS 1000 Phone	OC User (VoIP) with no RCC and no CS 1000 Phone	LG-Nortel 8540 (VoIP) with no RCC and no CS 1000 Phone	OC User RCC only, with CS 1000 Phone
CS 1000 configuration	PCA + SIP CTI	PCA	PCA	PCA	SIP CTI
VM access from phone	Dial CP DN	Dial CP DN	N/A	N/A	Dial CP DN
Login from phone	p/w only	p/w only	N/A	N/A	p/w only
MWI on phone	Yes	Yes	N/A	N/A	Yes
VM access from OC	Dial CP DN	Dial CP DN	Dial CP DN	Dial CP DN	N/A
Login from OC	p/w only	p/w only	p/w only	p/w only	N/A
MWI on OC	No	No	No	No	No
Outlook	New msg on CP Mailbox	New msg on CP Mailbox	New msg on CP Mailbox	New msg on CP Mailbox	New msg on CP Mailbox
Phone CFNA	CP DN	CP DN	PCA CFNA	PCA CFNA	CP DN
Phone CFB	CP DN	CP DN	PCA CFB	PCA CFB	CP DN
Phone CFAC	CP DN	CP DN	N/A	N/A	CP DN
OC client FC	On Phone (RCC to CP DN)	CP DN	Not recommended	Not recommended	Not recommended
OC client Re-direct	N/A	Not recommended	Not recommended	Not recommended	N/A
OC client sim-ring	N/A	Not recommended	Not recommended	Not recommended	N/A
OC fwd to UM	N/A	N/A	N/A	N/A	N/A

**ATTENTION**

**For Converged Office users using a Nortel telephone**

Deploying Converged Office without configuring Remote Call Control (RCC) is not recommended. If RCC is not deployed for these users, the Office Communicator (OC) 2007 client provides call forwarding and call redirection options that can result in undesirable behaviors. For example, calls forwarded or redirected to the CallPilot DN, will be answered by the CallPilot logon prompt of "CallPilot from Nortel Networks. Mailbox ?", instead of receiving the user's mailbox greeting.

**ATTENTION****For Converged Office users not using a Nortel telephone**

For Converged Office users who use voice communications through the OC client or from an LG-Nortel 8540 telephone (or both) and are configured with a Personal Call Assistant (PCA) , the following cautions apply:

- Ensure that the Call Forward No Answer and Call Forward Busy settings for the PCA are properly set to the CallPilot DN.
- Advise users not to use the Office Communicator 2007 settings for forwarding or redirecting calls to Voice Mail. For example, calls forwarded or redirected to the CallPilot DN, will be answered by the CallPilot logon prompt of "CallPilot from Nortel Networks. Mailbox ?", instead of receiving the user's mailbox greeting.
- Callers experience different call-answering behavior depending upon the state of the user's PCA . If the PCA is in a ringing state such as a call waiting to be answered by the user, a second caller will be forwarded immediately to the user's Voice Mail. If the user has already answered a call, a second caller will be forwarded to the user's Voice Mail only after the number of rings specified by the PCA's Call Forward No Answer setting.

**OCS 2007 users using UM 2007—integrated**

The following tables depict Voice Mail access for OCS 2007 users using UM 2007 in integrated mode for Option 1 and 2.

**Table 21**  
**Unified Messaging 2007 integrated Option 1**

	OC User (VoIP) with RCC and CS 1000 Phone	OC User (VoIP) with no RCC and CS 1000 Phone	OC User (VoIP) with no RCC and no CS 1000 Phone	LG-Nortel 8540 (VoIP) with no RCC and no CS 1000 Phone	OC User RCC only, with CS 1000 Phone
CS 1000 configuration	PCA + SIP CTI	PCA	PCA	PCA	SIP CTI
VM access from phone	Dial SA DN	Dial SA DN	N/A	N/A	Dial SA DN
Logon from phone	Logon and password	Logon and password	N/A	N/A	Logon and password
MWI on phone	No	No	N/A	N/A	No
VM access from OC	Dial SA DN	Use Voice Mail option	Use Voice Mail option	Use Voice Mail option	N/A

Logon from OC	Logon and password	direct	direct	direct	N/A
MWI on OC	Yes	Yes	Yes	Yes	Yes
Outlook	New msg in inbox	New msg in inbox	New msg in inbox	New msg in inbox	New msg in inbox
Phone CFNA	SA DN	SA DN	Not Required	Not Required	SA DN
Phone CFB	SA DN	SA DN	Not Required	Not Required	SA DN
Phone CFAC	SA DN	SA DN	N/A	N/A	SA DN
OC client FC	On Phone (RCC to SA DN)	No	No	No	On Phone (RCC to SA DN)
OC client Re-direct	N/A	No	No	No	N/A
OC client sim-ring	N/A	N/A	N/A	N/A	N/A
OC fwd to UM	N/A	Yes	Yes	Yes	N/A

**ATTENTION**

**For Converged Office users using a Nortel telephone**

Deploying Converged Office without configuring Remote Call Control (RCC) is not supported. If RCC is not deployed for these users, the Office Communicator (OC) 2007 client provides call forwarding and call redirection options that if selected by the end user, will result in forward or redirected calls being answered by the Exchange logon prompt instead of the user's mailbox greeting. For example, using Call Forward or redirect to the Exchange Unified Messaging System Access number, will result in calls being answered by the Exchange logon prompt, "Welcome, you are connected to Microsoft Exchange", instead of receiving the user's mailbox greeting.

**ATTENTION**

**For Converged Office users not using a Nortel telephone**

For Converged Office users who use voice communications through the OC client, an 8540 telephone, or both and are configured with a Personal Call Assistant (PCA), the following cautions apply:

The Voice Mail option is not available. Users cannot use the Office Communicator 2007 Voice Mail setting for forwarding or redirecting calls to Voice Mail. Calls Forwarded or redirected to the Exchange Unified Messaging System by the OC client are answered by the Exchange Unified Messaging logon prompt instead of the user's mailbox greeting. For example, using Call Forward or redirect to the Exchange Unified Messaging, results in calls being answered by the Exchange Unified Messaging logon prompt, "What is the prompt?", instead of receiving the user's mailbox greeting. The Exchange UM Call Sender feature will not work properly.

**Table 22**  
**Unified Messaging 2007 integrated Option 2**

	OC User (VoIP) with RCC and CS 1000 Phone	OC User (VoIP) with no RCC and CS 1000 Phone	OC User (VoIP) with no RCC and no CS 1000 Phone	LG-Nortel 8540 (VoIP) with no RCC and no CS 1000 Phone	OC User RCC only, with CS 1000 Phone
CS 1000 configuration	PCA + SIP CTI	PCA	PCA	PCA	SIP CTI
VM access from phone	Dial SA DN	Dial SA DN	N/A	N/A	Dial SA DN
Login from phone	p/w	p/w	N/A	N/A	p/w
MWI on phone	No	No	N/A	N/A	No
VM access from OC	Dial SA DN	User Voice Mail option	Use Voice Mail option	Use Voice Mail option	N/A
Login from OC	p/w	direct	direct	direct	N/A
MWI on OC	Yes	Yes	Yes	Yes	Yes
Outlook	New msg in inbox	New msg in inbox	New msg in inbox	New msg in inbox	New msg in inbox
Phone CFNA	SA DN	SA DN	Not required	Not required	SA DN
Phone CFB	SA DN	SA DN	Not required	Not required	SA DN
Phone CFAC	SA DN	SA DN	N/A	N/A	SA DN
OC client FC	On Phone (RCC to SA DN)	Voice Mail option only DN not recommended	Voice Mail option only DN not recommended	Voice Mail option only DN not recommended	On Phone (RCC to SA DN)
OC client Re-direct	N/A	Voice Mail option only DN not recommended	Voice Mail option only DN not recommended	By default set to Voice Mail after 20 seconds	N/A
OC client sim-ring	N/A	N/A	N/A	N/A	N/A
OC fwd to UM	N/A	Yes	Yes	Yes	N/A

### ATTENTION

#### For Converged Office users using a Nortel telephone

Converged Office users who internally access the Exchange Unified Messaging Auto Attendant or use the Call Sender feature, are unable to use the Auto Attendant to call other users. Any attempts to call another user will result in the caller being disconnected.

**ATTENTION**

**For Converged Office users not using a Nortel telephone**

For Converged Office users who use voice communications through the OC client, an 8540 telephone, or both and are configured with a Personal Call Assistant (PCA) , the following cautions apply:

- Ensure users only use the OC 2007 client Voice Mail settings for forwarding or redirecting calls to Voice Mail. For example, calls forwarded or redirected to the Voice Mail option are answered with the user’s personal greeting.
- Calls should not be forwarded or redirected to the Unified Messaging System Access number. Calls forward or redirected to the Exchange Unified Messaging by the OC client 2007 are answered by the Exchange Unified Messaging logon prompt instead of the user’s mailbox greeting. For example, using Call Forward or redirect to the Exchange Unified Messaging System Access number, results in calls being answered by the Exchange Unified Messaging logon prompt, "What is the prompt?", instead of receiving the user’s mailbox greeting.
- Users using the Play on Phone feature are required to update the Play on Phone destination with their telephone number for the first time they use the Play on Phone option. The default SIP URI will not work.

**OCS 2007 users using UM 2007—non-integrated**

The table depicts Voice Mail access for OCS 2007 users using UM 2007 in non-integrated mode for the following configurations.

**Table 23**  
**Unified Messaging 2007 non-integrated**

	OC User (VoIP) with RCC and CS 1000 Phone	OC User (VoIP) with no RCC and CS 1000 Phone	OC User (VoIP) with no RCC and no CS 1000 Phone	LG-Nortel 8540 (VoIP) with no RCC and no CS 1000 Phone	OC User RCC only, with CS 1000 Phone
CS 1000 configuration	PCA + SIP CTI	PCA	PCA	PCA	SIP CTI
VM access from phone	Dial SA DN	Dial SA DN	N/A	N/A	Dial SA DN
Login from phone	p/w only	p/w only	N/A	N/A	p/w only
MWI on phone	Yes	Yes	N/A	N/A	Yes

VM access from OC	Dial SA DN	Dial SA DN	Dial SA DN	Dial SA DN	N/A
Login from OC	p/w only	p/w only	p/w only	p/w only	N/A
MWI on OC	Yes	Yes	Yes	Yes	Yes
Outlook	New msg in inbox	New msg in inbox	New msg in inbox	New msg in inbox	New msg in inbox
Phone CFNA	SA DN	SA DN	PCA CFNA	PCA CFNA	SA DN
Phone CFB	SA DN	SA DN	PCA CFB	PCA CFB	SA DN
Phone CFAC	SA DN	SA DN	N/A	N/A	SA DN
OC client FC	On Phone (RCC to SA DN)	Not recommended	Not recommended	Not recommended	On Phone (RCC to SA DN)
OC client Re-direct	N/A	Not recommended	Not recommended	Not recommended	N/A
OC client sim-ring	N/A	Not recommended	Not recommended	Not recommended	N/A
OC fwd to UM	N/A	N/A	N/A	N/A	N/A

### ATTENTION

#### **For Converged Office users using a Nortel telephone**

Deploying Converged Office without configuring Remote Call Control (RCC) is not recommended. If RCC is not deployed for these users, the Office Communicator (OC) 2007 client provides call forwarding and call redirection options that can result in undesirable behaviors. For example, using Call Forward or redirect to the Exchange Unified Messaging System Access number, will result in calls being answered by the Exchange logon prompt, "Welcome, you are connected to Microsoft Exchange", instead of receiving the user's mailbox greeting.



**ATTENTION****For Converged Office users not using a Nortel telephone**

For Converged Office users who use voice communications through the OC client, an 8540 telephone, or both and are configured with a , the following cautions apply:

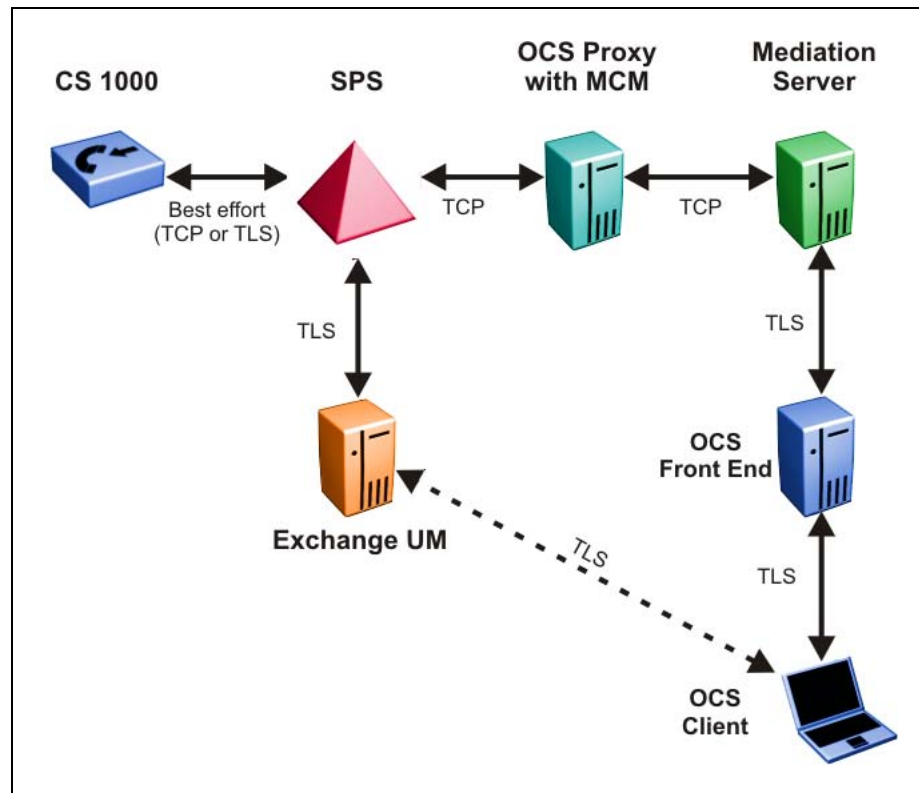
- Ensure that the Call Forward No Answer and Call Forward Busy settings for the PCA are properly set to the Exchange Unified Messaging System Access number.
- Ensure users do not use the Office Communicator 2007 settings for forwarding or redirecting calls to Voice Mail. For example, using Call Forward or redirect to the Exchange Unified Messaging System Access number, results in calls being answered by the Exchange Unified Messaging logon prompt, "What is the prompt?", instead of receiving the user's mailbox greeting.
- Callers can experience different call-answering behavior depending upon the state of the user's PCA . If the PCA is in a ringing state such as a call waiting to be answered by the user, a second caller will be forwarded immediately to the user's Voice Mail. If the user has already answered a call, a second caller will be forwarded to the user's Voice Mail only after the number of rings specified by the PCA's Call Forward No Answer setting.

For more information on configuring Voice Mail access for OCS 2007 users using UM 2007, see "[OCS 2007 users using UM 2007](#)" (page 198).

**Signaling with integrated Voice Mail**

In an integrated configuration, the Office Communicator (OC) client has the capability of selecting a Voice Mail option and the dialing plan is TLS secure. The following diagram depicts the signaling between OCS 2007, Exchange, and the CS 1000 components in an integrated configuration.

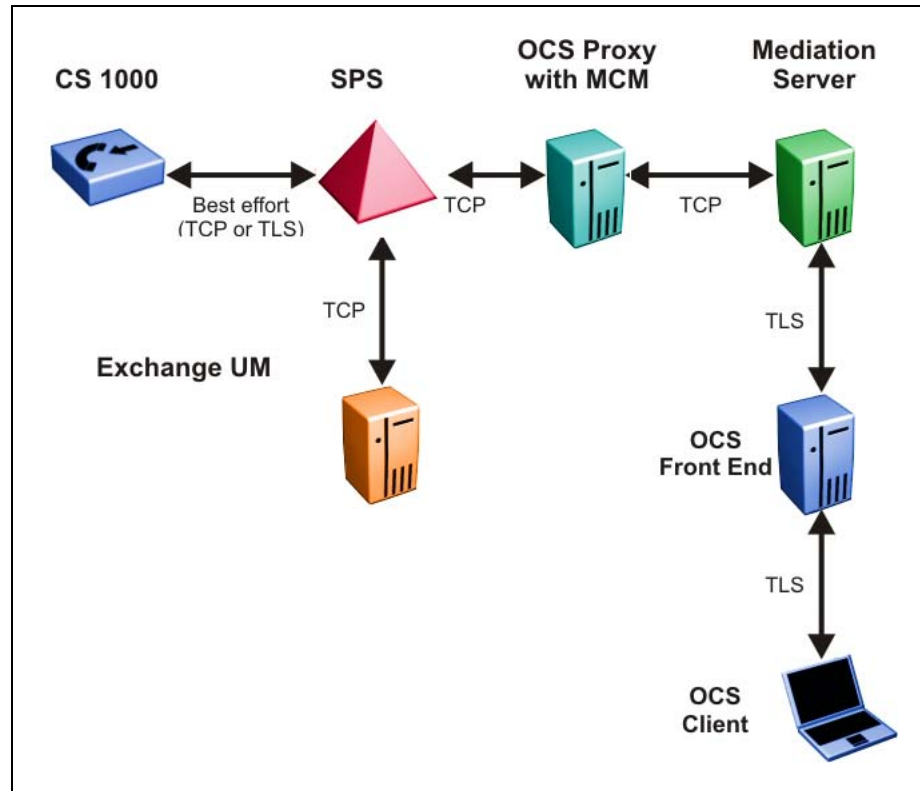
**Figure 25**  
**Signaling integrated**



### Signaling with non-integrated Voice Mail

In a non-integrated configuration, the Office Communicator (OC) client does not have the capability of selecting a Voice Mail option, the signaling between Exchange and the OC client is not defined. The following diagram depicts the signaling between OCS 2007, Exchange, and the CS 1000 components in a non-integrated configuration.

**Figure 26**  
**Signaling non-integrated**





---

# Installation

---

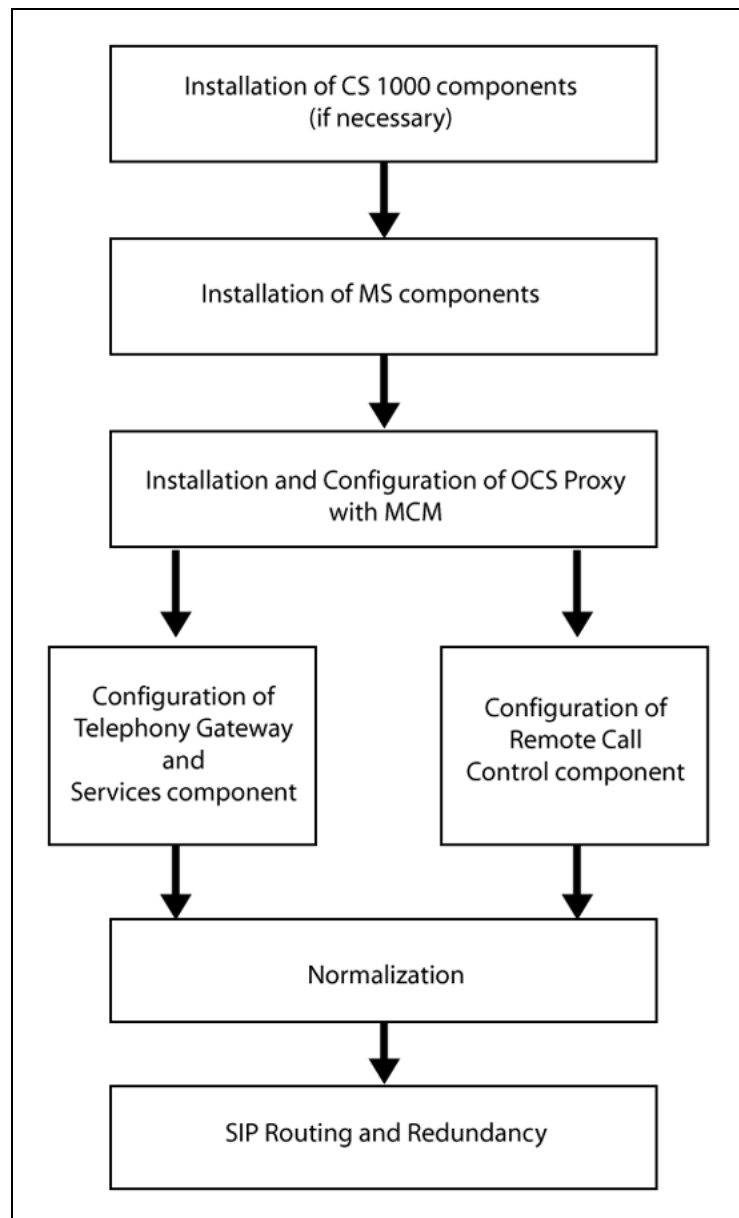
This chapter contains the procedures necessary to install CS 1000 components and Office Communications Server (OCS) 2007 on a CS 1000 system.

The first step is to install the necessary CS 1000 components (if you do not already have a working CS 1000 system in place), and then install the Microsoft server components. After all hardware and software is installed, you can then configure the Telephony Gateway and Services or Remote Call Control components.

After configuration is complete, normalization of telephone numbers, SIP routing, and redundancy help you integrate the Nortel and Office Communications Server 2007 domains. [Figure 27 "Installation and configuration process"](#) (page 102) illustrates this process.

## Installation navigation

Figure 27  
Installation and configuration flow

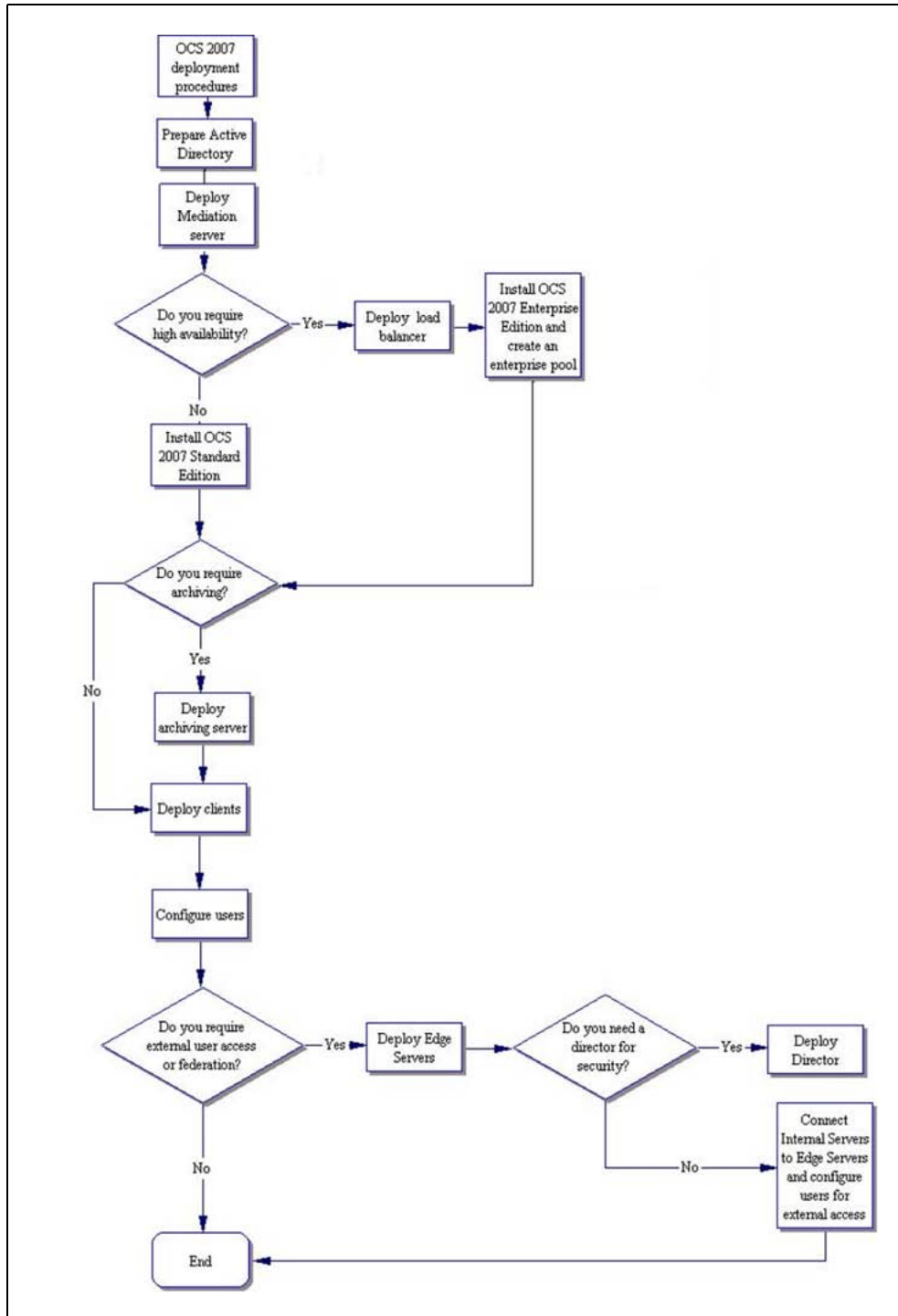


- ["CS 1000 and Signaling Server installation"](#) (page 105)
- ["OCS 2007 component installation"](#) (page 105)
- ["OCS Proxy server installation"](#) (page 107)
- ["Load Balancer installation"](#) (page 108)
- ["MCM installation"](#) (page 109)

## OCS 2007 installation preparation and deployment

The following figure [Figure 28 "OCS 2007 installation preparation and deployment flow chart"](#) (page 104) depicts the high-level topics required to deploy OCS 2007. After your internal deployment is complete, you can then deploy Edge Servers for external user access.

**Figure 28**  
**OCS 2007 installation preparation and deployment flow chart**





## CS 1000 and Signaling Server installation

The first step in the installation and configuration process is to install the CS 1000 and Signaling Server.

### Installing the CS 1000 system

To install and configure a CS 1000 system, see the following documents:

- *Communication Server 1000M and Meridian 1 Small System Installation and Commissioning* (NN43011-310)
- *Communication Server 1000M and Meridian 1 Large System Installation and Commissioning* (NN43021-310)
- *Communication Server 1000E Installation and Commissioning* (NN43041-310)

### ATTENTION

#### IMPORTANT!

Converged Office requires the Call Server and Signaling Server to have Release 5.0 software and with the Product Enhancement Packages (PEP) installed.

See the Nortel Converged Office Product Bulletin to ensure that you are using the most current versions of the Call Server and Signaling Server PEPs.

### Installing the Signaling Server

The Signaling Server must be installed. If it is not installed, see *Signaling Server Installation and Commissioning* (NN43001-312).

For information about configuring the Signaling Server, see "[Signaling Server checklist](#)" (page 262).

## OCS 2007 component installation

After all CS 1000 components are installed, go to the Microsoft Web site [www.microsoft.com](http://www.microsoft.com) for information about installing the OCS components, beginning with the Active Directory.

**ATTENTION**

The following is a list of the required patches for the Microsoft OCS 2007 installation:

- OCS 2007 – Standard Edition RTM  
KB 942872  
Version 6362.0 plus hotfix
- Description of the Office Communicator 2007 hotfix package:  
December 17, 2007  
KB 943083  
Version 2.0.6362.36
- Description of Office Communications Server 2007, Unified Communications Managed API v1.0 Redist: December 17, 2007  
KB 944285  
Version 3.0.6362.36
- Description of the Update for Office Communication Server 2007, Mediation Server: December 17, 2007  
KB 943086  
Version 3.0.6362.36
- OCS Application Proxy Server: OCS 2007 – Standard Edition RTM  
KB 942872  
Version 6362.0 plus hotfix

Microsoft SR1 RTM documentation can be obtained from the Microsoft Web site. Go to [www.microsoft.com](http://www.microsoft.com).

**Prerequisite OCS 2007 information**

The following section describes the prerequisite information.

**Active Directory**

The Office Communications Server 2007 and Office Communicator 2007 environment have a strong dependency on Active Directory to authenticate, authorize, provision, and configure Office Communications Server 2007.

With the OC 2007 client, Active Directory supplies the enterprise address list to facilitate search-based lookups.

Ensure that you install Active Directory in accordance with Microsoft documentation. For more information about Active Directory planning, see *Office Communications Server 2007 Document: Active Directory Guide*. Download Microsoft technical documentation from the Download Center at [www.microsoft.com](http://www.microsoft.com).

## Office Communications Server (OCS ) 2007 Enterprise Pool

OCS 2007 Enterprise Edition is designed for large-scale deployment where multiple Office Communications Server Enterprise Edition servers are deployed as a pool, typically behind a load balancer. Servers in the pool share a central SQL back end database server that stores user data.

If your pool consists of more than one server, a Load Balancer is required. If your pool consists of only one server, which is connected to a separate SQL back end database server, a Load Balancer is not required.

OC clients register on an Enterprise pool. The client user is directed to a specific server within the pool by a hardware load balancer that distributes the load to these servers. Static data, such as contact lists and access control lists (ACLs), are stored as persistent data on the back end database server.

A client can have multiple concurrent connection instances and can register on multiple servers at the same time. Each device to which the client is logged on (called an endpoint) can be connected through a different server at the same time.

The load balancer exposes a single Virtual Internet Protocol (VIP) address that is used by the clients to access the pool. Each Enterprise Edition server within the pool is responsible for connection processing, security and authentication, protocol processing, and server applications. The user data resides in the back end database server. The database contains records that hold static data and dynamic user data (such as endpoints and active descriptions for a user). The database runs a set of stored procedure calls that form the core of the operational software. Office Communications Servers within the pool are networked to the back end database server using a high-speed network. These Office Communications Servers also run User Replicator (UR) software to provide a connection to the Microsoft Active Directory service so that user account information can be synchronized between the back end database server and the Active Directory.

For more information about Office Communications Server 2007 Enterprise Edition, see the *Office Communications Server 2007 Document: Enterprise Edition Deployment Guide*. Download Microsoft technical documentation from the Download Center at [www.microsoft.com](http://www.microsoft.com).

## OCS Proxy server installation

The following section describes the OCS Proxy server installation procedures.

## Installing the OCS Proxy server

Step	Action
1	On the Windows <b>Start</b> menu, choose <b>Run</b> .
2	Navigate to the C:\Office Communications Server_Eval\se_eval\setup\i386\ folder.
3	For OCS Standard Edition: server.msi SERVER=PROXY SKU=SE OR For OCS Enterprise Edition: server.msi SERVER=PROXY SKU=EE A new Windows wizard opens prompting you to install the Forwarding Proxy. You must complete all the steps in the wizard before continuing.
4	Activate the proxy server using command line (from Office Communications Server_Eval\StandardEdition\setup\i386 folder). Activate on domain: <code>lcscmd /server /password: &lt;password&gt; /action: activate /role:proxy</code> Activate on workgroup: <code>lcscmd /server /password: &lt;password&gt; /action: activate /role:workgroupproxy</code>
5	Type: <b>Exit</b> on the command line.
6	Run the Installation wizard and select the defaults.
7	To get Proxy to appear in OCS, navigate to Admin tools/Computer Management and select <b>Services and applications</b> .
8	Select Microsoft Office Communications 2007 and then Proxy (for example, ocs2007a-proxy.ocs2007a.corp.nortel.com).

—End—

## Load Balancer installation

The following section describes the Load Balancer installation procedures.

### Installing the Load Balancer

Step	Action
1	Go to the <b>Start</b> menu and select <b>Settings</b> .
2	Select <b>Network Connections</b> .

- 3 Select **TCP/IP properties** and add DNS server IP. For example, 47.11.108.50.
- 4 Go to **My Computer**, right-click and select **System Properties**.
- 5 Enter the Computer Name of each FE server. For example, ocs-fe-1.
- 6 Click domain. For example, ocs2007a.corp.nortel.com.
- 7 Restart server.

---

—End—

---

## MCM installation

### Prerequisite MCM information

- Ensure MS Windows Server 2003 operating system is installed with SP1 or R2.
- Ensure the OCS Proxy server is installed.
- Uninstall previous versions of MCM (if any previous versions exist).
  - Stop MCM service. On the MCM management console window and from the **Actions** menu, select **Stop**.
  - Use the Windows Add/Remove Programs utility to uninstall MCM.
- Deploy MCM 3.0
  - Run the MCM installer.
- To use the Use an existing account option, you require a domain user account and password to install the MCM. The domain user account is a member of the local groups RTC Server Applications and Group. The user account must also have full control permissions on the MCM folder. For example, c:\program files\Nortel\MCM.
- To use the Create a new account option, you can log on to the server with a user ID and permissions to create users in the Active Directory
- To create a new account during the MCM installation, the new user is added to all the necessary groups automatically by the MCM.

### Installing MCM 3.0

Step	Action
------	--------

- |   |   |
|---|---|
| 1 | To install the MCM 3.0 software, run the MCM Installation wizard. |
|---|---|

- 2 Select **Use an existing account** and enter your user ID and password  
**OR**  
select **Create a new account**.
- 3 Open the MCM Console window and select the **Actions** menu.
- 4 On the **Actions** menu, choose **Start** to start the MCM service.

---

—End—

---

MCM must be installed on the OCS Proxy Server. See "[MCM menu options](#)" ([page 139](#)) for more information about using the MCM menu options.

MCM has two main components: **MCM Service**, which handles call processing, and **MCM Management Console**, which interfaces with the MCM Service component for configuration, administration, and maintenance.

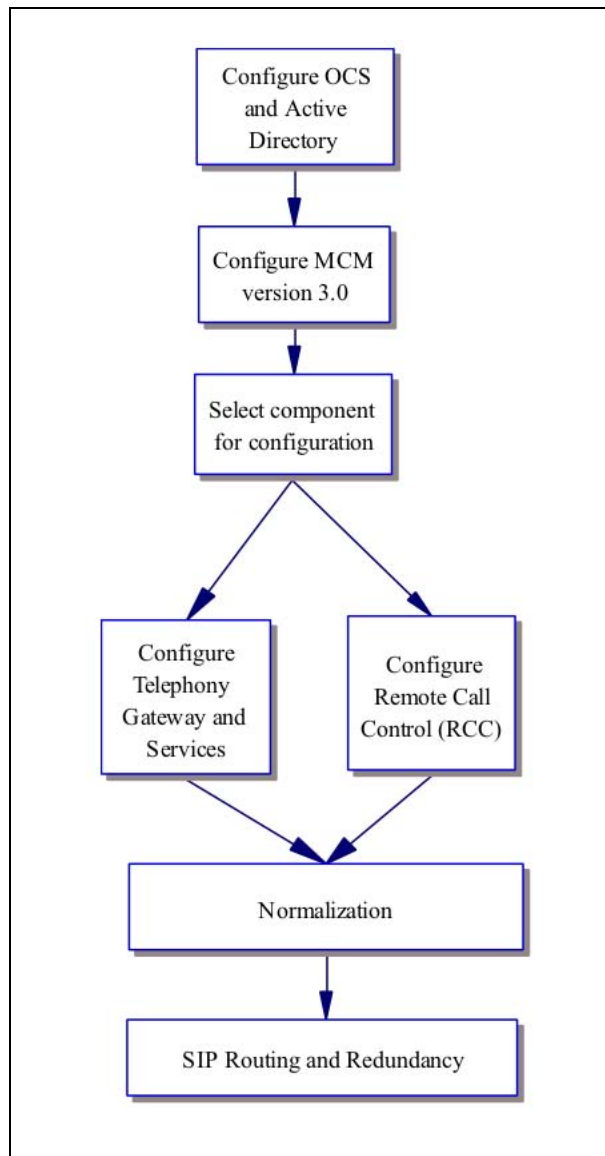
---

# Configuration

---

The following flow chart depicts the configuration order of the components.

**Figure 29**  
**Configuration flow chart**



## Active Directory configuration

Active Directory configuration takes place in the Active Directory Users and the Computers (ADUC) window. Selecting the Users folder reveals the list of users as depicted in [Figure 30 "Active Directory \(Microsoft LDAP server\)"](#) (page 113). All users are defined in this folder.

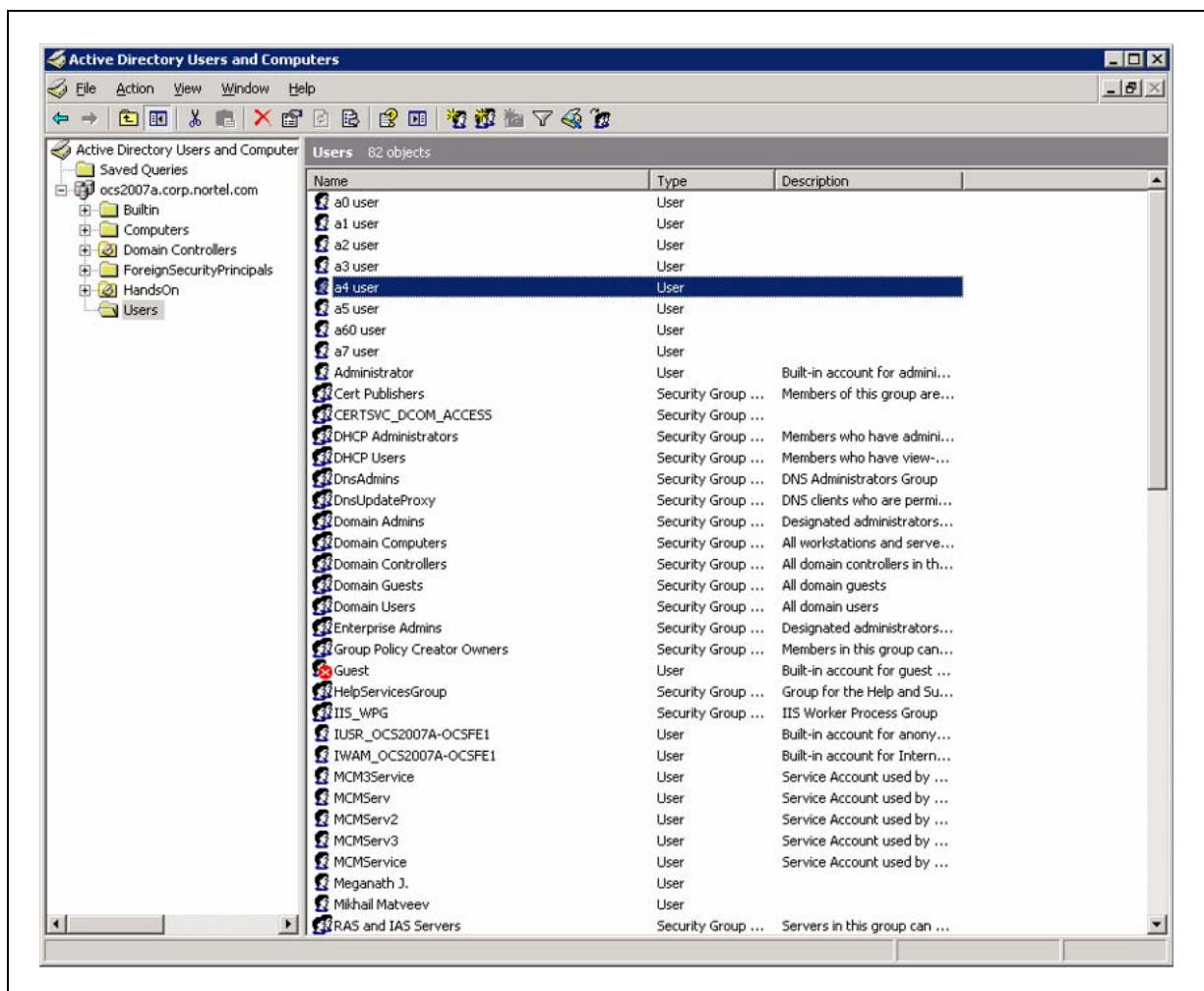


By default MCM uses GC LDAP server which contains partial information about all objects in the Active Directory domain forest. It requires replication from all Domain controllers to the GC domain controller to be performed after changes made in the Active Directory User's configuration "Active Directory Sites and Services" snap-in.

### ATTENTION

All CS 1000 phones must be added in the Active Directory even when there is no Office Communicator user associated with the CS 1000 phone. The administrator can create a user account with the Enterprise Voice and PBX Integration enabled in the Active Directory for every CS 1000 phone. For example, a lab phone or a lobby phone. Some feature interactions will apply. See "[Active Directory configuration](#)" (page 73) in the Feature Interactions section.

**Figure 30**  
**Active Directory (Microsoft LDAP server)**



## Defining users

- | Step | Action   |
|------|--|
| 1    | Select a user from the list in the Users folder.   |
| 2    | Right-click the user, and select <b>Properties</b> .   |
| 3    | The Properties window opens as depicted in <a href="#">Figure 31 "User properties"</a> (page 114). |

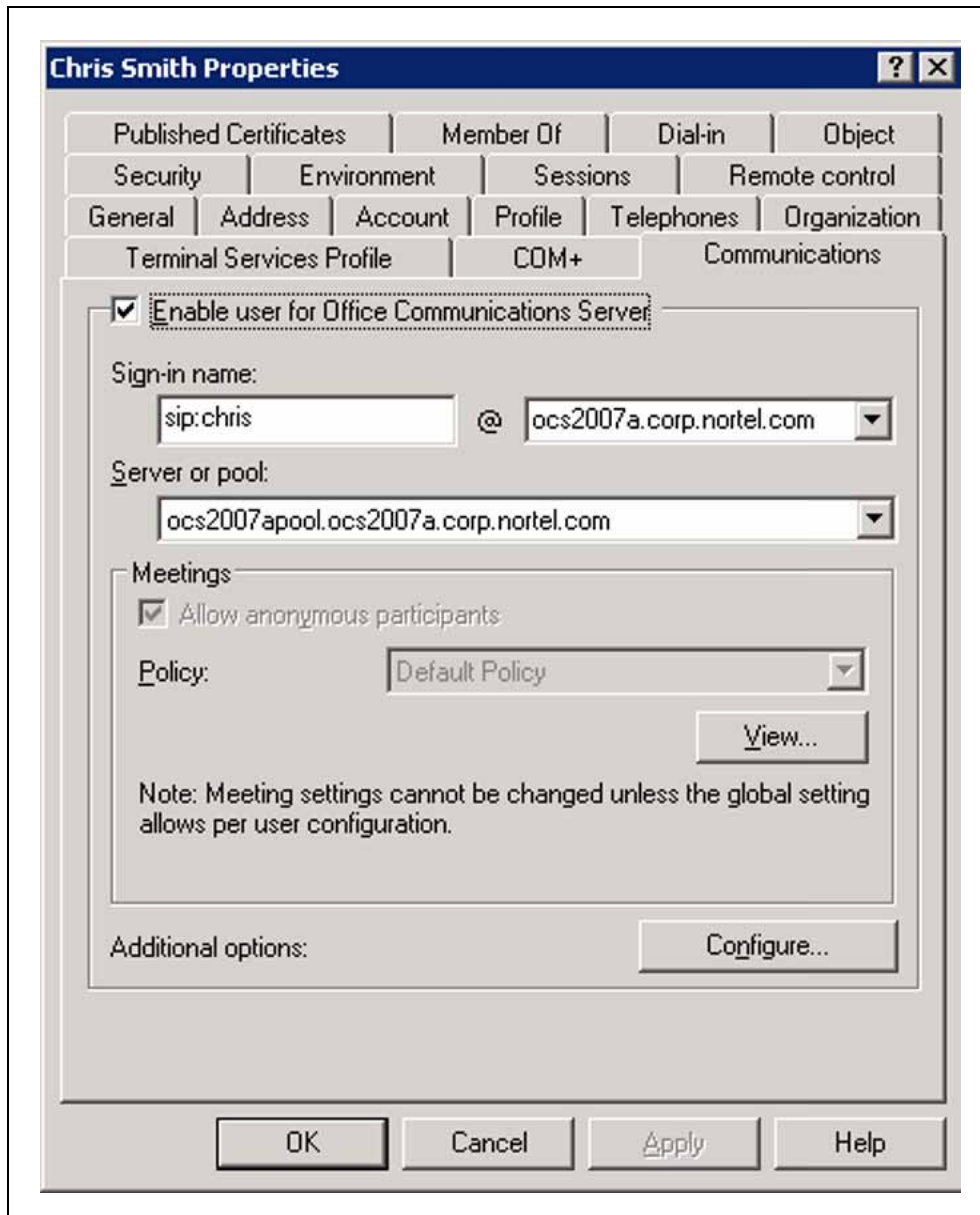
**Figure 31**  
User properties

The screenshot shows the 'Chris Smith Properties' dialog box with the 'General' tab selected. The dialog has a title bar with a question mark and a close button. Below the title bar are several tabs: Member Of, Dial-in, Environment, Sessions, Remote control, Terminal Services Profile, COM+, Communications, General (selected), Address, Account, Profile, Telephones, and Organization. The main area contains a user icon and the name 'Chris Smith'. Below this are several input fields: 'First name:' with 'Chris' entered, 'Initials:' (empty), 'Last name:' with 'Smith' entered, 'Display name:' with 'Chris Smith' entered, 'Description:' (empty), and 'Office:' (empty). At the bottom are fields for 'Telephone number:' with '2070' entered and an 'Other...' button, 'E-mail:' with 'chris@ocs2007a.corp.nortel.com' entered, and 'Web page:' (empty) with an 'Other...' button. At the very bottom are 'OK', 'Cancel', 'Apply', and 'Help' buttons.

- 4 Enter the user's information (first name, last name, telephone number, and so on) in the appropriate fields in the **General** tab.
- 5 Select the **Communications** tab.

- 6 Click the check box next to **Enable user for Office Communications Server**.
- 7 In the fields provided, define the user **Sign-in name** and the **Server or pool** ). Office Communicator 2007 uses these addresses to place calls.

**Figure 32**  
Enable Office Communications Server connectivity for a user in Active Directory



- 8 Click the **Configure** button.

- 9 For enabling Remote Call Control only, select **Enable Remote Call Control** and configure the Server URI and Line URI. See [Figure 33 "Enable Remote call control"](#) (page 117).
- 10 For enabling Enterprise Voice and PBX integration only (without RCC), select **Enable Enterprise Voice** and the **Enable PBX integration** check box. See [Figure 34 "Enable Enterprise Voice and PBX integration"](#) (page 118).
- 11 For enabling both Remote call control and Enterprise Voice, you must select **Enable Enterprise Voice** and the **Enable PBX integration** check box and specify the Server URI. See [Figure 35 "Enable both RCC and Enterprise Voice"](#) (page 119).
- 12 Specify the MCM/App Proxy FQDN in the Server URI field. This must be in the format of sip:CDP or UDP;phone-context=CDP domain or UDP domain@MCM/APP Proxy FQDN. For example:
  - Sip:5001;phone-context=cdp.udp@proxy.ocs2007.corp.nortel.com – CDP format
  - Sip:3435001;phone-context=udp@proxy.ocs2007.corp.nortel.com – UDP format

Specify the URI of the user's telephone in the Line URI field. The Line URI must be in the format tel:E164;ext=CDP or UDP. For example:

- tel:+16139675000;ext=5001 – CDP format
- tel:+16139675000;ext=3435001– UDP format.

#### **ATTENTION**

It is important to note that the chosen numbering plan must be applied to the PCA and MCM configurations.

---

—End—

---

**Figure 33**  
**Enable Remote call control**

**User Options**

**Telephony**  
Select a telephony option. These settings affect only those calls that are routed through IP-PSTN or remote call control gateways.

Enable PC-to-PC communication only

Enable Remote call control

Enable Enterprise Voice

Enable PBX integration

Note: To enable both remote call control and PBX integration, you must specify a Server URI below.

Policy:

Server URI:

Line URI:

**Federation**

Enable federation

Enable remote user access

Enable public IM connectivity

**Archiving**

Archive internal IM conversations

Archive federated IM conversations

Note: Archiving settings cannot be changed unless the global setting allows per user configuration.

Enable enhanced presence

Note: Enhanced presence cannot be changed once it has been set.

**Figure 34**  
**Enable Enterprise Voice and PBX integration**

**User Options**

Telephony

Select a telephony option. These settings affect only those calls that are routed through IP-PSTN or remote call control gateways.

Enable PC-to-PC communication only

Enable Remote call control

Enable Enterprise Voice

Enable PBX integration

Note: To enable both remote call control and PBX integration, you must specify a Server URI below.

Policy:

Server URI:

Line URI:

Federation

Enable federation

Enable remote user access

Enable public IM connectivity

Archiving

Archive internal IM conversations

Archive federated IM conversations

Note: Archiving settings cannot be changed unless the global setting allows per user configuration.

Enable enhanced presence

Note: Enhanced presence cannot be changed once it has been set.

**Figure 35**  
**Enable both RCC and Enterprise Voice**

**User Options**

Telephony

Select a telephony option. These settings affect only those calls that are routed through IP-PSTN or remote call control gateways.

Enable PC-to-PC communication only

Enable Remote call control

**Enable Enterprise Voice**

Enable PBX integration

Note: To enable both remote call control and PBX integration, you must specify a Server URI below.

Policy: Default Policy View...

Server URI: sip: 2070 ;phone-context=cdp.udp@test.com

Line URI: tel:+16139675000;ext= 2070

Federation

Enable federation

Enable remote user access

Enable public IM connectivity

Archiving

Archive internal IM conversations

Archive federated IM conversations

Note: Archiving settings cannot be changed unless the global setting allows per user configuration.

Enable enhanced presence

Note: Enhanced presence cannot be changed once it has been set.

OK Cancel Help

## Office Communications Server configuration

The starting point for Telephony Gateway and Services configuration is the Office Communications Server 2007 component.

## Load Balancer configuration

The pool of Front End servers is organized to process inbound and outbound traffic. The role of the Load Balancer in this architecture is to route incoming SIP-messages to the less busy server on the base of configured algorithm. Load Balancer's VIP-address is used by clients as a single point of connection to the pool. This address is listed in DNS and has a FQDN. Internal OCS clients require a DNS server to establish connection with an Enterprise Edition Pool.

## Voice Properties configuration

When introducing telephony support to an OCS 2007 the following OCS FE entities must be configured:

Step	Action
1	Location profiles. A location profile defines all phone numbers that can be dialed from a named location. A location contains one or, typically, more normalization rules. Normalization rules should be defined in the Location Profile to convert the dialstrings to the E.164 International format for all types of PSTN calls. For example, NXX, NPA and International. For all calls using private dialing plan (CDP or UDP), normalization rules must be defined in the Location Profile to convert the dialstrings to the Line URI format. For example, E.164;ext=xxxxxxx format.
2	Normalization rules. Normalization rules are .NET regular expressions that define a phone number pattern. A set of normalization rules associated with a particular location constitute a location profile.
3	Phone usage records. A phone usage record specifies a class of call (internal, local, long distance, or whatever) that can be made by various users, or groups of users, in an organization.
4	Voice policy. A voice policy associates one or more phone-usage records with one or a group of users.
5	Route. A voice route associates target phone numbers with particular IP-PSTN gateways and phone usage records. Source-based routing must be used for CS 1000 and OCS 2007 integration.
6	Define users and enable their Voice and RCC capabilities.

—End—



Voice mail must always be configured on the CS 1000 and not Office Communicator. Configuring communication to the CS 1000 gateway is performed at the Mediation Server.

Dual forking is configured based on OCS Voice Policies, which in turn may be applied globally or on a per user basis. For more information on configuring Voice Policies, see *Microsoft Office Communications Server 2007 Enterprise Voice Planning and Deployment Guide*. Download Microsoft technical documentation from the Download Center at [www.microsoft.com](http://www.microsoft.com).

### Enabling dual forking—globally

Step	Action
1	Click <b>Forest</b> and then <b>Properties</b> .
2	Select <b>Voice Properties</b> in the OCS management console.
3	Under <b>Global Policy</b> , select the desired policy and click <b>Edit</b> . This policy will be applied for all users.
4	In the <b>Edit Policy</b> window, click the <b>Allow simultaneous ringing of phones</b> box.

—End—

### Enabling dual forking—by user

When applying voice policies on a per user basis, dual forking can be enabled for the user by selecting an appropriate policy.

Step	Action
1	Click <b>Forest</b> and then <b>Properties</b> .
2	Select <b>Voice Properties</b> in the OCS management console.
3	Under <b>Use per user policy</b> , select the desired policy and click <b>Edit</b> . This policy will be applied on a user basis.
4	In the <b>Edit Policy</b> window, click the <b>Allow simultaneous ringing of phones</b> box.
5	Go to Users in the OCS configuration console.
6	Select a user and click <b>Properties</b> .
7	In the properties window, click <b>Additional Options configure</b> .
8	Select the desired policy.

---

—End—

---

### Applying policy

---

Step	Action
------	--------

---

- |   |   |
|---|---|
| 1 | In the <b>User Options</b> window, click <b>Enable Enterprise Voice</b> .   |
| 2 | Select <b>Another Policy</b> . The policy can be assigned simultaneously to several users using the Configure Users wizard. |
- 

—End—

---

### OCS configuration procedures

Download Microsoft technical documentation from the Download Center at [www.microsoft.com](http://www.microsoft.com).

### Configuration of Static Routes

Configuration of the Office Communications Server involves the configuration of static routes and host authorization.

You must configure static routes between the client and server. For information about configuring static routes (Enterprise Edition pool behind a Load Balancer), see *Office Communications Server 2007 Administration Guide*, and the *Microsoft Office Communications Server 2007 Enterprise Edition Deployment Guide*. Download Microsoft technical documentation from the Download Center at [www.microsoft.com](http://www.microsoft.com).

### Host Authorization and Routing configuration

For one Office Communications Server to communicate with another Office Communications Server, each server must have authorization to speak to the other. The Host Authorization tab as depicted in Front Ends Properties is where you establish this authorization.

The Host Authorization tab, located in the OCS Proxy with MCM is where all the CS 1000 endpoints are configured. These endpoints must be configured as authorized endpoints in the OCS Proxy with MCM. Configure the CS 1000 IP addresses which, in turn, talk to the Office Communications Server. The same authorization must take place for both OCS to OCS authorization and OCS to CS 1000 authorization.

**Note:** Adding the FQDN of the CS 1000 to the Authorized Host list will only work when a TLS connection is used. The MCM 3.0 with the Mediation Server configured, must use a TCP connection to the CS

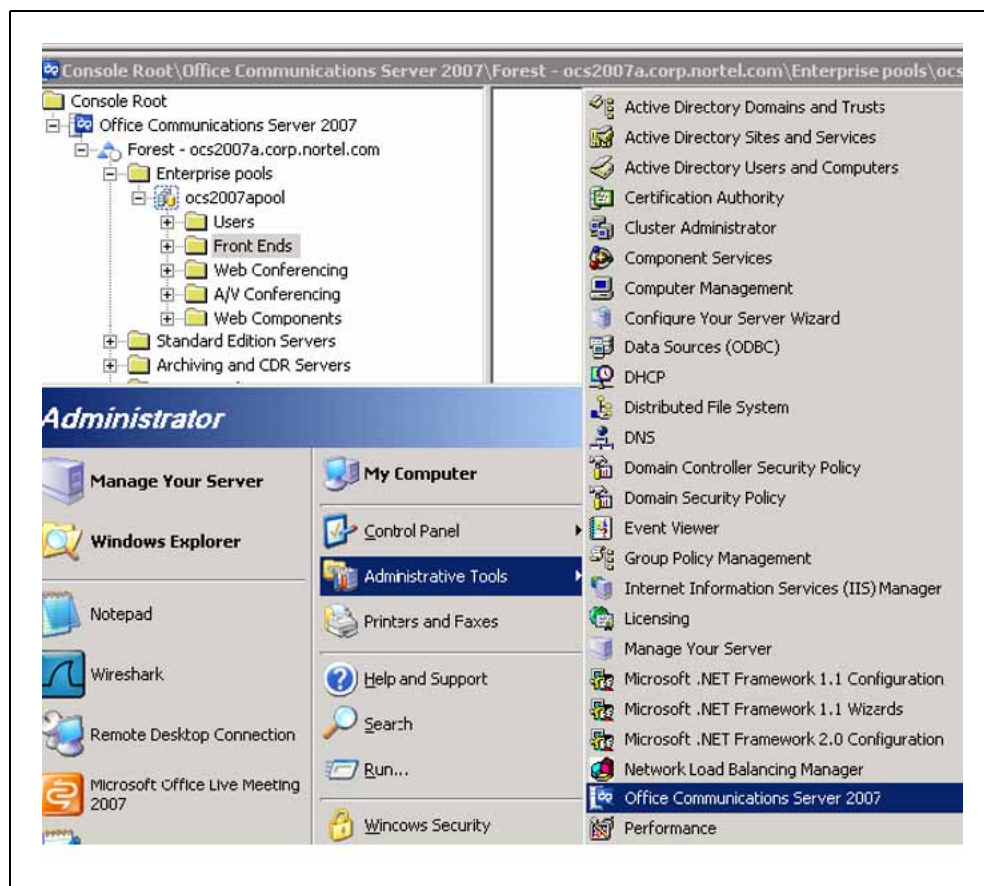
1000. In this situation, the IP address of the CS 1000 must be added to the Authorized Host list.

## Configuring the Host Authorization and Routing for the OCS Front End server

### Step Action

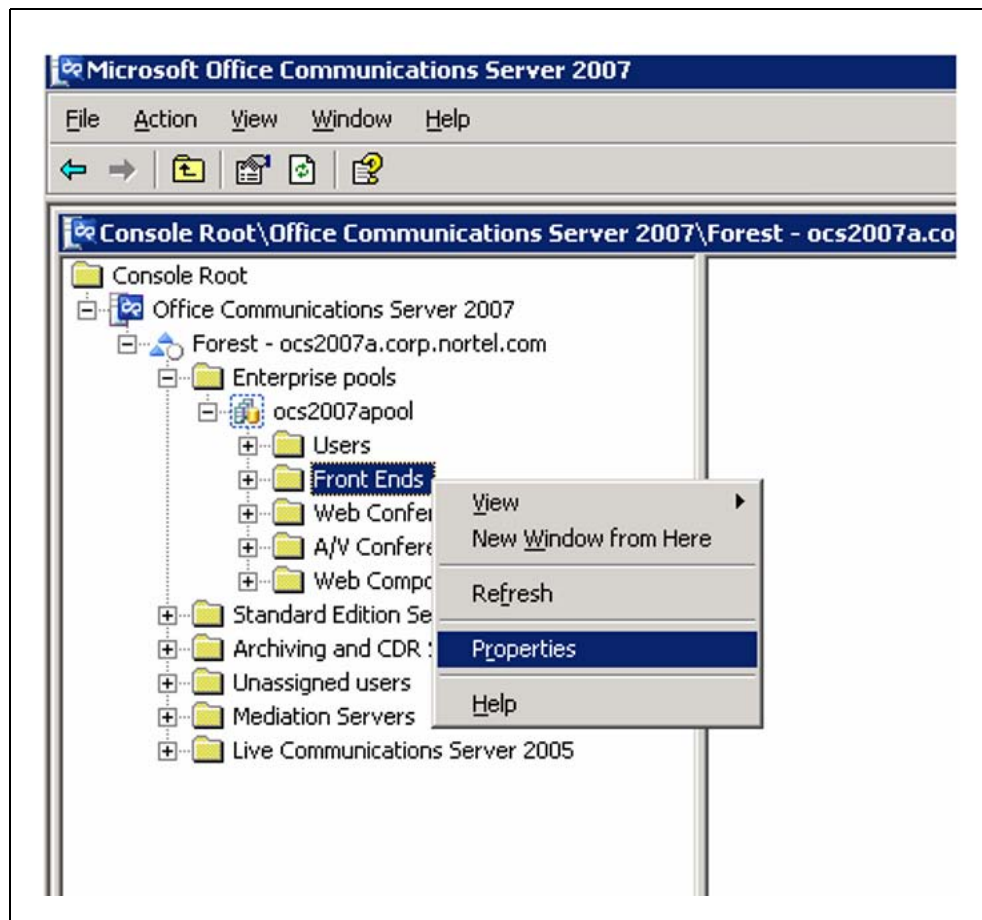
- 1 Open Office Communications Server (accessed from the Windows server that runs the OCS server) as shown in [Figure 36 "Opening Office Communications Server"](#) (page 123). Click on the **Start** menu and then select **Administrative Tools, Office Communications Server 2007**.

**Figure 36**  
Opening Office Communications Server



- 2 Click on the Office Communications Server (the server to which you want to add Host Authorization and change the Routing), right-click on **Front Ends** and choose **Properties**. See [Figure 37 "Office Communications Server Front Ends"](#) (page 124).

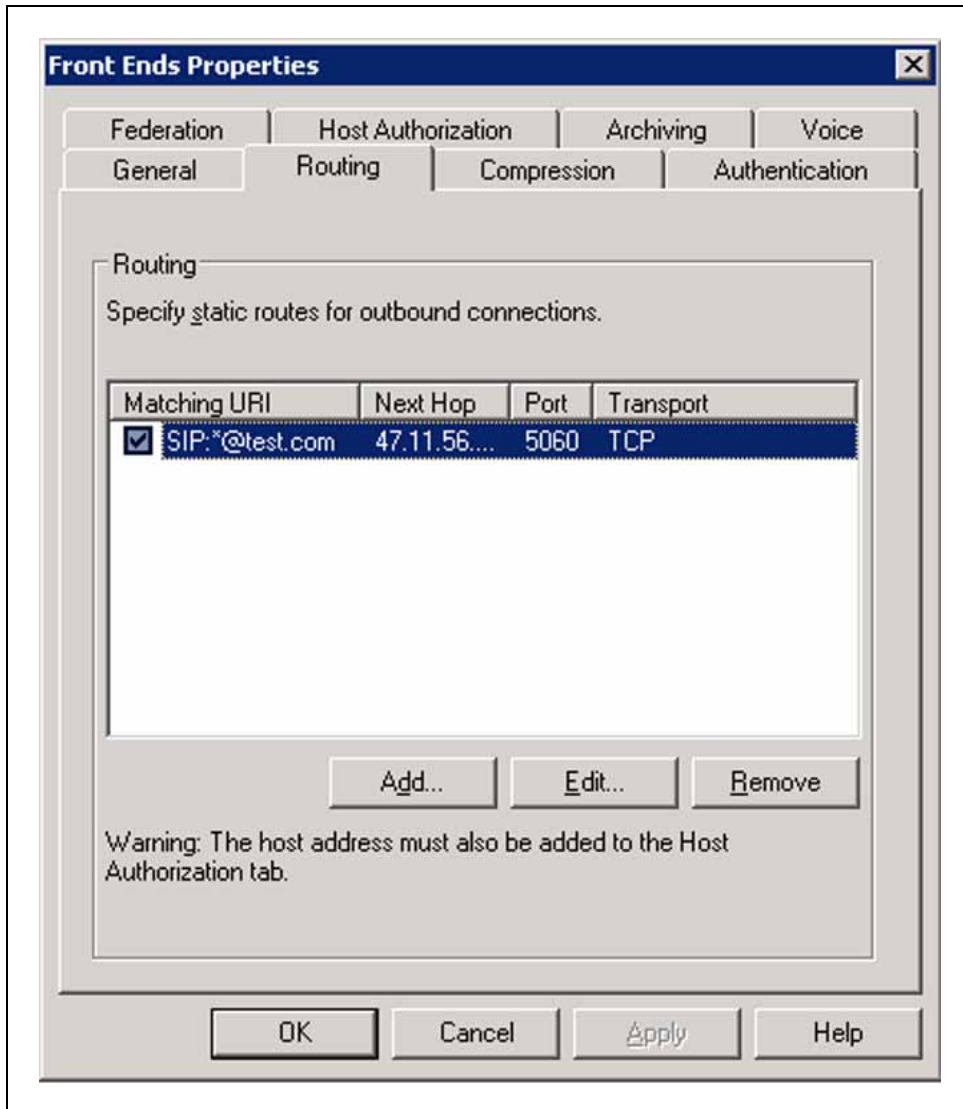
**Figure 37**  
Office Communications Server Front Ends



- 3 Click on the **Host Authorization** tab and select the **Edit** button.
- 4 In the Server section, click on the **IP Address** button and enter the IP address of the OCS Proxy server. For details, see [Table 25 "Routing rules"](#) (page 130).
- 5 In the Settings section, select **Throttle As Server** and the **Treat as Authenticated** check boxes.
- 6 Click **OK**.
- 7 On the Routing tab of the Front End server, a Routing rule is defined to route the SIP message in which the Request URI matches the Server URI as defined in the Active Directory for each user to the OCS Proxy server where MCM is running.

For an example, see [Figure 38 "Routing tab"](#) (page 125).

**Figure 38**  
**Routing tab**



- 8** In the Add Static Route window, For Domain: enter the domain defined in the Server URI. For Next Hop: enter the IP address of the OCS Proxy.

---

—End—

---

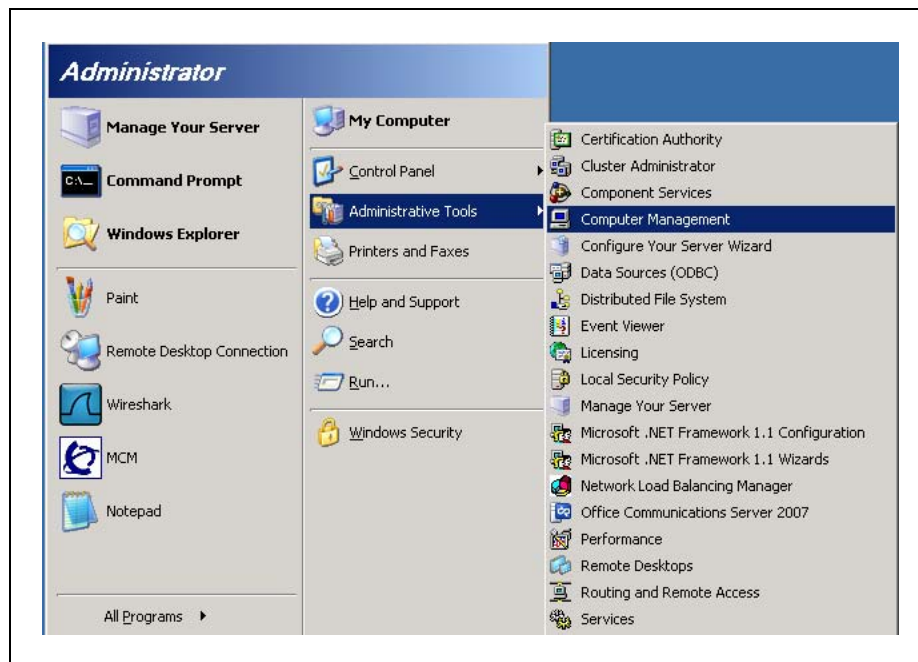
For each OCS Proxy with MCM, Host Authorization is required for the Node IP address of all CS 1000 servers that the Office Communications Server interacts with, as well as the TLAN IP address of the Primary, Secondary, and all possible collaborative NRS.

## Configuring host authorization for the OCS Proxy

Step	Action
------	--------

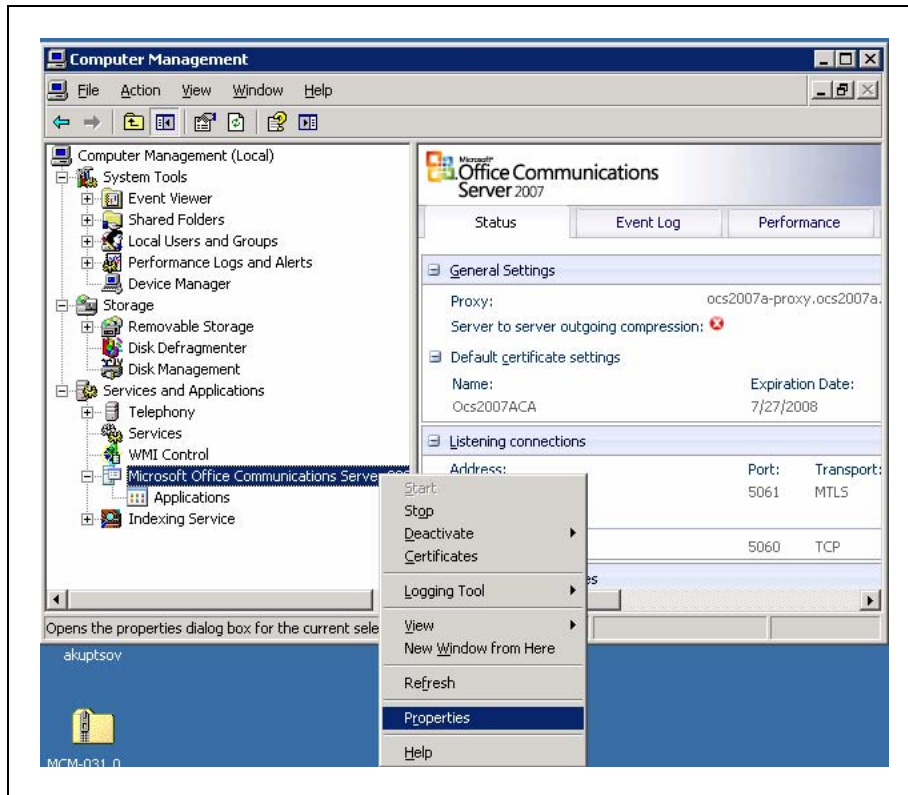
- |   |  |
|---|--|
| 1 | Open the OCS Proxy server, click the Windows <b>Start</b> button, point to <b>Administrative Tools</b> , and then click <b>Computer Management</b> . |
|---|--|

**Figure 39**  
Opening the Computer Management console



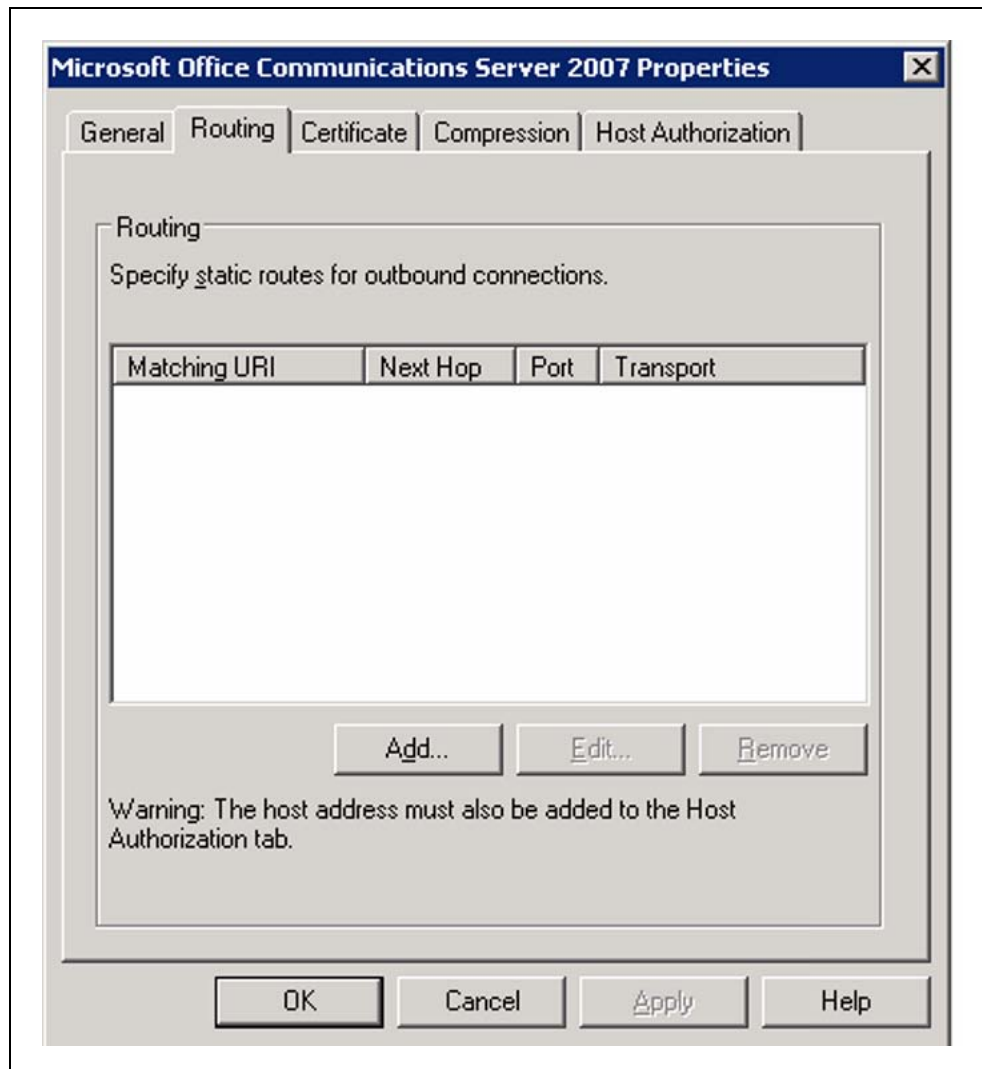
- |   |   |
|---|---|
| 2 | Choose Microsoft Office Communications Server and right-click to select <b>Properties</b> . |
|---|---|

**Figure 40**  
Office Communications Server Management Console



- 3 For the OCS Proxy, no static route is required. MCM routes inbound calls to the proper Mediation Server based on the Routing Table settings on the MCM.
- 4 Click the **Routing** tab to confirm no route is configured.

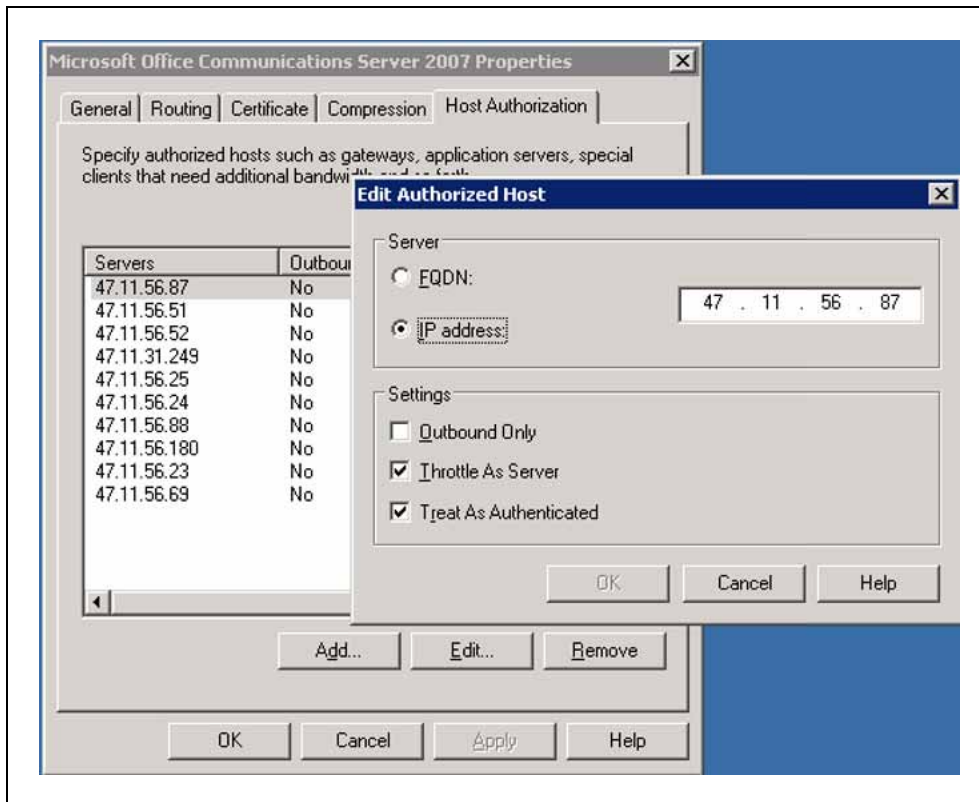
**Figure 41**  
**Routing tab**



- 5 Click the **Host Authorization** tab.
- 6 Click **Edit** to open the Edit Authorized Host window.
- 7 In the Edit Authorized Host window, enter the **IP address**, select both the **Throttle As Server** and **Treat As Authenticated** check boxes, and then click **OK**. The IP addresses that require authorization on the OCS Proxy are the Node IP addresses of all the CS 1000s in the network, IP address of the NRS (SRS or SPS), all the IP addresses of the OCS Front End servers, IP addresses of the Mediation Servers, and the IP addresses of all Front End Servers. For more details, see [Table 25 "Routing rules" \(page 130\)](#).



**Figure 42**  
**Edit Authorized Host**



—End—

The following table shows a number of possible configurations of OCS 2007 and the required entries for each. The transport to CS 1000 is TCP for all configuration types.

**Table 24**  
**OCS Servers Routing and Host Authorization Summary**

	<b>OCS Front End Servers Pool</b>	<b>OCS Mediation Server</b>	<b>OCS Application Server</b>
<b>Routing</b>	Domain: Application Proxy Server's FQDN Next hop IP: IP Address of the Application Proxy Server Transport: TCP	None	None

	OCS Front End Servers Pool	OCS Mediation Server	OCS Application Server
	Port: 5060 Phone URI: No Replace host in request URI: No		
<b>Host Authorization</b>	<ul style="list-style-type: none"> <li>IP Address of the OCS Application Proxy Server</li> </ul> Outbound Only: No Throttle as Server: Yes Treat as Authenticated: Yes	None	<ul style="list-style-type: none"> <li>NRS/SPS IP Address</li> <li>Signaling Server Node IP Address</li> <li>All IP Addresses of Mediation Servers</li> <li>IP Address of all Front End Servers</li> </ul>

**Table 25**  
**Routing rules**

Configuration Type	Component	Host Authorization	Destination	User / Domain	Phone URI	Transport	Port
1. Single Front End server and single OCS Proxy. All TCP	Front End server	OCS Proxy IP	OCS Proxy IP	<domain name>	No	TCP	5060
	OCS Proxy	Front End server IP					
		SPS/SRS IP					
		Node IP					
		Mediation Servers IP					
2. Single Front End server and single OCS Proxy. SIP CTI TLS	Front End server		OCS Proxy FQDN	<domain name>	No	TLS	5061
	OCS Proxy	Front End server FQDN					
		SPS/SRS					
		Node IP					
		Mediation Servers IP					

Configuration Type	Component	Host Authorization	Destination	User / Domain	Phone URI	Transport	Port
3. Pool of Front End servers and Single OCS Proxy. All TCP	Front End servers Pool	OCS Proxy IP	OCS Proxy IP	<domain name>	No	TLS	5061
		Load Balancer IP					
	OCS Proxy	Front End servers IP					
		Load Balancer IP					
		SPS/SRS IP					
		Node IP					
		Mediation Servers IP					
4. Pool of Front End servers and Single OCS Proxy. SIP CTI TLS	Front End server Pool		OCS Proxy FQDN	<domain name>	No	TLS	5061
	OCS Proxy	Pool FQDN					
		SPS/SRS IP					
		Node IP					
		Mediation Servers IP					
5. Single Front End server and Pool of OCS Proxies, All TCP	Front End server	Proxy Load Balancer IP	Proxy Load Balancer IP	<domain name>	No	TCP	5060
		OCS Proxies IP	Load Balancer IP	CS 1000 SIP address	NO	TCP	5060
	OCS Proxies	Front End server IP					
		Proxy Load Balancer IP					
		SPS/ SRS IP					
		Node IP					

Configuration Type	Component	Host Authorization	Destination	User / Domain	Phone URI	Transport	Port
		Mediation Servers IP					
6. Single Front End server and Pool of OCS Proxies, SIP CTI TLS	Front End server	Proxy Load Balancer FQDN	Proxy Load Balancer FQDN	<domain name>	No	TLS	5061
	OCS Proxies	Front End server FQDN					
		Proxy Load Balancer FQDN					
		SPS/SRS IP					
		Node IP					
		Mediation Servers IP					
7. Pool of Front End servers and Pool of OCS Proxies. All TCP	Front End server Pool	Proxy Load Balancer IP	Proxy Load Balancer IP	<domain name>	No	TCP	5060
		Front End Load Balancer IP					
		OCS Proxies IP					
	OCS Proxies IP	Front End servers IP					
		Proxy Load Balancer IP					
		Front End Load Balancer IP					
		SPS/SRS IP					
		Node IP					
		Mediation Servers IP					

Configuration Type	Component	Host Authorization	Destination	User / Domain	Phone URI	Transport	Port
8. Pool of Front End servers and Pool of OCS Proxies. SIP CTI TLS	Front End servers Pool	Proxy Load Balancer FQDN	Proxy Load Balancer FQDN	<domain name>	No	TLS	5061
	OCS Proxies	Proxy Load Balancer FQDN					
		Front End Load Balancer FQDN (Pool FQDN)					
		SPS/SRS IP					
		Node IP					
		Mediation Servers IP					

### Mediation Server configuration

Use the following procedures for configuring a Mediation Server.



#### WARNING

The Microsoft configuration procedures in this document are provided for your convenience and are based on Microsoft OCS technical documentation. For more information about configuring OCS and the most recent configuration instructions, go to [www.microsoft.com](http://www.microsoft.com).

### Configuring a Mediation Server

Step	Action
------	--------

- |   |   |
|---|---|
| 1 | Log on to a Communications Server 2007 Mediation Server.  |
| 2 | Click <b>Start</b> , point to Administrative Tools, and then click <b>Office Communications Server 2007</b> .   |
| 3 | Expand the appropriate forest node.   |
| 4 | Expand the Mediation Servers node, right-click on the Mediation Server to be configured, click <b>Properties</b> , and then click the <b>General</b> tab. |

- 5 In the FQDN box, make sure the FQDN listed matches that of the Mediation Server you have selected.
- 6 Open a command prompt, change to the root directory, and type `nslookup` and (FQDN of the server) using the FQDN displayed on the Mediation Server General tab, and then press Enter.
- 7 From the list of IP addresses displayed in the Communications Server listening IP address list, select the IP address returned in [Step 6](#). If the IP address selected, does not match the IP address in [Step 6](#), Communications Server traffic will be directed toward an interface that is not listening for such traffic and away from the one that is.
- 8 From the list of two IP addresses displayed in the Gateway listening IP address list, select the other IP address (can be a media gateway or the Communication Server 1000).
- 9 From the A/V Edge Server list, select the A/V Edge Server that hosts the A/V Authentication Service for this Mediation Server.
- 10 In the Default location profile list, select the default location profile for this Mediation Server
- 11 In Media port range accept the default range of 60,000 to 64,000.
- 12 Click the **Next Hop Connections** tab.
- 13 On the Next Hop Connections tab under Office Communications Server next hop. In the FQDN list, select the FQDN of the next-hop internal server. This server could be a Director or pool. In the Port box, accept the default of 5061 for TLS.
- 14 On the Next Hop Connections tab under PSTN Gateway next hop. In the IP address box, specify the IP address of the OCS Proxy where the MCM runs. In the Port box, accept the default of 5060 for TCP.
- 15 Click OK.

---

—End—

---

## MCM 3.0 configuration

The Multimedia Convergence Manager (MCM) is a software component that Nortel provides to enable voice connectivity between CS 1000 clients and the Office Communications Server (OCS) 2007 clients. MCM consists of the following modules:

- Call Processing Service

- Management Console

The MCM Call Processing Service handles the Session Initiation Protocol (SIP) telephony traffic between the CS 1000 and the Office Communications Server. The Management Console provides real-time status of the MCM, Office Communications Server, Primary Network Routing Service (NRS), and Secondary NRS. It also provides Administrative, Maintenance, and Configuration tools.

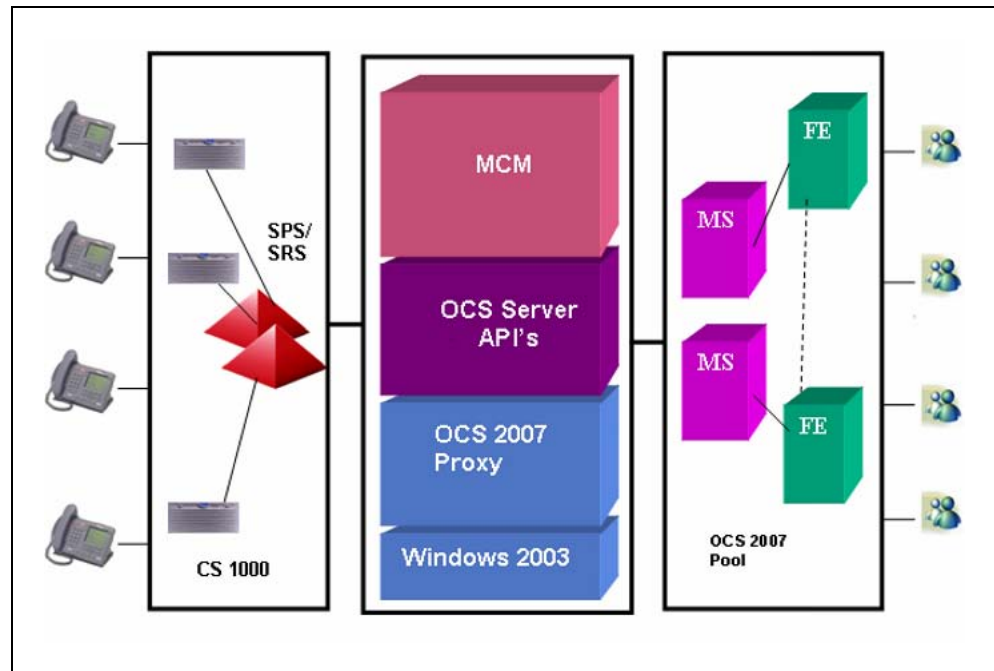
Office Communications Server 2007 provides multimedia and collaboration features such as Video, Internet Messaging (IM), Presence, White Board, Application Sharing, and Voice over Internet Protocol (VoIP) capability. MCM enables SIP VoIP connectivity between the CS 1000 and the Office Communications Server 2007 and TR/87 authorization functionality required for the Office Communicator (OC) 2007 Remote Call Control capability.

Telephones in a CS 1000 system can make direct SIP calls to OCS clients when the dialed number maps to a corresponding user's Line URI using LDAP queries to the corporate Active Directory. MCM also allows Office Communications Server clients to originate ESN and trunk calls to corporate and external users.

### **MCM architecture**

MCM 3.0 is situated between the Mediation Server and the CS 1000. 3.0 must run on top of the OCS Proxy server with Windows 2003 as depicted in [Figure 43 "MCM architecture" \(page 136\)](#).

**Figure 43**  
**MCM architecture**



The following examples illustrate how MCM handles call information. Understanding the role of MCM in the Telephony Gateway and Services component helps you to determine the configuration.

#### **Example 1: Outgoing calls from Office Communicator**

In this example, an invite travels from the client to the OCS Front End server, and then to the Office Communications Server MCM Proxy through the Mediation Server. MCM checks which NRS is active, and then sends an invite to that SIP Redirect Service (SRS). In this case, the invite is qualified. To return from the SRS, 302 is used. The invite is then sent unqualified to the CS 1000 associated with the originator's location code and DN.

#### **Example 2: Incoming calls to Office Communicator**

In this example, the user has a desktop telephone and a Personal Call Assistant (PCA) that points to an Office Communications Server 2007 server. The PCA sends a DN or Routing DN. The call was originally made to 6 231 3052, but the PCA hot key is configured with 6 344 5000. This is a "dummy" routing DN; it can be configured with all hot keys in the network.

In a CDP network, the dummy routing DN (for example, 6 231 3052) must also be configured by a DSC (for example, 8200). The DSC is configured on the NRS as a routing entry for the MCM Gateway endpoint.



The call is routed to the NRS. The invite is sent to the NRS, which returns a 302, and the CS 1000 sends an invite to the MCM Proxy. At this stage, the invite includes a special header called x-nt-ocn that contains the actual number called. Use this header to compare against the Active Directory map for the user's Line URI. This method is used to prevent you from having to program the for each user to determine the correct DN upon which to terminate the call. The MCM then routes this call to the proper Mediation Server based on the SIP GW ID provided in the INVITE and the Routing Table configured on the MCM.

You need not configure each user. Configure only the routing DN, and the header is automatically injected to identify the called party.

### **MCM Direct configuration**

For small CS 1000 deployments (without NRS), MCM supports Direct configuration. In this mode, MCM sends an invite from the client directly to the CS 1000 node IP address specified in the MCM configuration. MCM does not check CS 1000 availability in Direct mode configuration.

For more information about the various MCM configuration fields, see [Figure 45 "MCM configuration window" \(page 140\)](#).

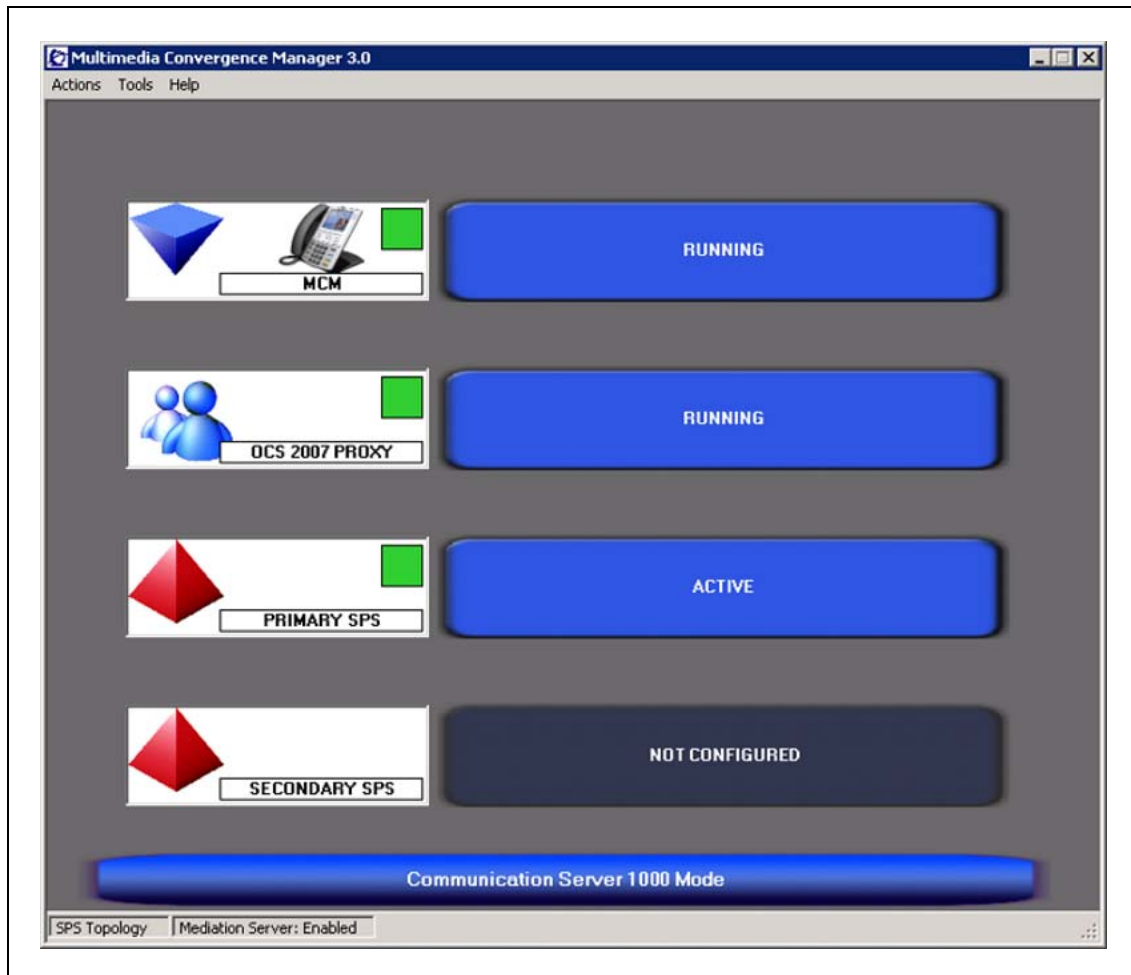
### **MCM management console**

The following list contains possible statuses for the various MCM components:

- MCM
  - Running
  - Pending
  - Stopped
- OCS
  - Running
  - Pending
  - Stopped
- Primary SRS/SPS (the IP address of the Primary SRS/SPS server)
  - Active - Primary SRS/SPS is active. All messages are sent through the Primary NRS.
  - Standby - Primary SRS/SPS is alive. The Secondary SRS/SPS is active.

- Not responding - Primary SRS/SPS is not responding. For normal processing, the Secondary SRS/SPS must be switched to an Active state.
- Unknown - An unknown response is received by the SRS or SPS.
- Secondary SRS/SPS (the IP address of the Secondary SRS/SPS server)
  - Active - Secondary SRS/SPS is active, which is possible only if the Primary SRS/SPS is down.
  - Standby - Secondary SRS/SPS is alive, which is the normal state if the Primary SRS/SPS is active.
  - Not responding - Secondary SRS/SPS is not responding. You cannot switch to it.
  - Unknown - An unknown response is received by the Secondary SRS or SPS.

**Figure 44**  
**MCM**



### MCM menu options

The following list describes the function of each MCM menu command:

- Actions
  - Start - start MCM service
  - Stop - stop MCM service
  - Restart - stop and start MCM service
  - Exit - close current GUI for MCM service
- Tools
  - Configuration
  - Active Calls Count

- Active Directory Query
- Backup
- Restore
- Set Log Level
- Help
  - Get help and general information about MCM

**MCM Configuration** To access the MCM Configuration window, go to the MCM console window, select the **Tools** menu and then select **Configuration**.

**Figure 45**  
**MCM configuration window**

The screenshot shows the 'Configuration' window with the following sections and settings:

- Network Topology:**
  - Call Server: CS 1000
  - SRS:  (Selected)
  - SPS:  (Selected)
  - Direct Connect:  (Selected)
  - Primary IP: 47 . 11 . 56 . 25
  - Secondary IP: 0 . 0 . 0 . 0
  - Registration ID: MCM@ocs2007a.corp.nortel.co
  - Registration IP: 47.11.56.54
  - Mode: Proxy All
  - CS1000 SIP GW IP: 47 . 11 . 56 . 24
  - Transport: TCP
  - Port: 5060
  - Mediation Server
  - Routing Table
- Active Directory Configuration:**
  - Query Server Synchronize at: 03:00
  - Local Cache Synchronize Now
  - Local Cache then Query Server
  - Non Default AD/LDAP Server
  - Server IP: 0 . 0 . 0 . 0 Port: [ ]
- Network Dial Plan:**
  - Dial Plan: CDP
  - Access Code: [ ]
- SIP-CTI Authorization:**
  - Enable RCC Authorization
- Incoming Call Processing Parameters:**
  - Called Phone Context: cdp.udp
  - Called Phone Prefix Delete: 0
  - Called Phone Prefix Insert: [ ]
  - Caller Phone Prefix Delete: 0
  - Caller Phone Prefix Insert: [ ]
- Outgoing CLID Number Parameters:**
  - Prefix Delete: 0
  - Prefix Insert: [ ]
- Outgoing CLID Name Parameters:**
  - "FirstName LastName"
  - "LastName, FirstName"
  - "LastName FirstName"
  - AD Display Name

Buttons: Ok, Cancel, Help

**Network Topology section** The following is a description of some of the configuration fields in the Network Topology section of the MCM configuration window.

**Table 26**  
**Network topology fields**

Configuration field	Description
Call Server	Type of call server CS 1000, CS 2000, CS 2100
SRS	Outgoing SIP messages from the MCM will use the SIP Redirect Server for routing.
SPS	Outgoing SIP messages from the MCM will go through the SIP Proxy Server.
Direct	Outgoing SIP messages from the MCM will terminate directly to a CS 1000 SIP GW.
Primary IP	IP address of primary SRS/SPS. Not used in the case of Direct SIP Routing.
Secondary IP	IP address of secondary SRS/SPS. Not used in the case of Direct SIP Routing.
Registration ID	MCM endpoint ID. This ID is in the format of host@domain. The host must match the endpoint name as defined in the NRS/SPS for MCM.
Registration IP	Select the MCM proxy IP to register with the SRS/SPS.
Mode	Proxy mode for SPS. The SIP Proxy Server (SPS) acts as a redirect server as well as a proxy server: <ul style="list-style-type: none"> <li>• Proxy All—SPS will proxy/route all messages from the MCM.</li> <li>• Proxy SIP and Re-direct SIP-CTI—SPS will proxy/route SIP calls and redirect SIP-CTI calls. In this mode, traffic going through the SPS is reduced. This can also be useful for administration purposes.</li> <li>• Redirect All—SPS will redirect all messages. In this mode, SPS will work in the same way as SRS</li> </ul>
CS 1000 SIP GW IP	IP address of the CS 1000 Node. Used only for Direct SIP routing with the CS 1000.
Transport	Only TCP is supported.
Port	SIP Port on SRS, SPS, and CS 1000. Default values are 5060 for TCP and 5061 for TLS connections.
Mediation Server	Select the check box to use Mediation Server.
Routing table	Click the Routing Table button when using Mediation Server.

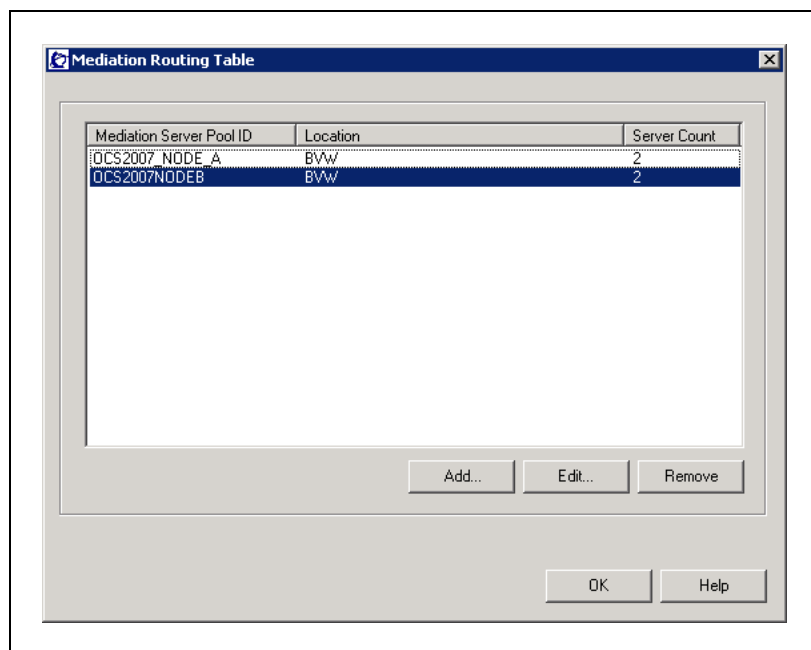
**Mediation Server routing table** Several Call Servers from different geographic locations may be connected to one MCM with one SIP Gateway. For each geographic location, one or several Mediation Servers forming Mediation Servers pool can be used. The sip-gw-id parameter is passed as

an INVITE request providing information about which dedicated Mediation Server or Mediation Server pool to process this message. The parameter value for SIP Gateway Endpoint Name is configured in Element Manager under **System, IP Network, Nodes: Servers, Media Cards, Signaling Server Properties**. The MCM contains a predefined list of Mediation Server addresses associated with a given sip-gw-id . The MCM is then able to determine what pool is used.

### ATTENTION

The SIP Gateway Endpoint Name must match the Mediation Server Pool ID, for example, OCS2007\_NODE\_A. See [Figure 46 "Mediation routing table"](#) (page 142) and [Figure 57 "Element Manager Signaling Server Properties"](#) (page 165).

**Figure 46**  
**Mediation routing table**



Click the **Add** button to configure the Mediation Server pool's IP address.

Click **OK**.

**Incoming Call Processing Parameters** This option refers to incoming CS 1000 calls to MCM that terminate on Office Communicator. You must specify the phone context. When the telephone context is defined, mapping is performed (using CDP or UDP). In the case of a large network, the telephone context used is UDP, while CDP is used for small networks. You can use Called Phone Prefix Delete and Insert fields to manipulate digits received from the CS 1000 prior to mapping.

**Table 27**  
**Incoming Call Processing parameters**

Configuration field	Description
Called Phone Context	Phone Context of calls to be processed by MCM. This entry depends on the dial-plan (CDP or UDP) and should be the same as Private/CDP domain name entries in the Signaling Server Element Manager.
Called Phone Prefix Delete	Number of prefix digits to be deleted from the called number for mapping to the user ID by MCM
Called Phone Prefix Insert	Prefix digits to be inserted in the called number for mapping to User ID by MCM.
Caller Phone Prefix Delete	Number of Prefix digits to be deleted from the caller number for mapping to a user ID by the Office Communicator client.
Caller Phone Prefix Insert	Prefix digits to be inserted in the caller number for mapping to a User ID by the Office Communicator client.

The Caller Phone Prefix Delete and Insert is used to manipulate the digits in the From header of the INVITE received from the CS 1000. These two kinds of manipulation are generally not necessary, but are available in case a scenario requires this type of manipulation.

**Incoming Call Processing Parameters section** The MCM requires access rights to certain directories (for example: "Program Files/ MCM..."). Ensure that the user has the Administrators rights to these directories.

The following [Figure 47 "Element Manager SIP URI MAP"](#) (page 144) depicts the Called Phone Context entry in the MCM Configuration screen and the entries for UDP and CDP in the Signalling Server Element Manager. These entries must match.

**Figure 47**  
**Element Manager SIP URI MAP**

The screenshot displays the configuration interface for SIP URI Mapping. It is divided into two main sections:

- Incoming Call Processing Parameters:**
  - Called Phone Context:  (circled in red)
  - Called Phone Prefix Delete:
  - Called Phone Prefix Insert:
  - Caller Phone Prefix Delete:
  - Caller Phone Prefix Insert:
- SIP URI Map:**
  - Public E.164/National domain name:  \*
  - Public E.164/Subscriber domain name:  \*
  - Public E.164/Unknown domain name:
  - Public E.164/Special Number domain name:
  - Private/UDP domain name:
  - Private/CDP domain name:  (circled in red)
  - Private/Special Number domain name:
  - Private/Unknown (vacant number routing) domain name:
  - Unknown/Unknown domain name:

**Active Directory configuration section** There are two modes for Active Directory (AD) Configuration: Realtime or Local Cache. Realtime mode is used for end-user ID mapping, which requires a Lightweight Directory Access Protocol (LDAP) query. Local Cache mode involves caching the Active Directory on the MCM server and using that cache information for queries.

**Table 28**  
**Active Directory configuration**

Configuration Field	Description
Query server	Use this field for real-time LDAP AD queries.
Local Cache	AD queries are done to a local cache of the AD. The cache is synchronized daily at a preconfigured time. You can force it to synchronize by clicking the <b>Synchronize Now</b> button to start
Local Cache then Query Server	AD queries are done to a local cached of the AD. If the entry is not found in the local cache then the MCM queries the LDAP AD in real-time.
Non default AD/LDAP Server	IP address and port of the LDAP server to be used if different from the default AD/LDAP server.



**Active Directory query** The Active Directory Query tool is used to check Active Directory mapping configuration. It searches for a user-id (SIP URI) by a given telephone number, and vice versa. This tool is only used for maintenance, and emulates the same algorithm that is used by the MCM service in run-time.

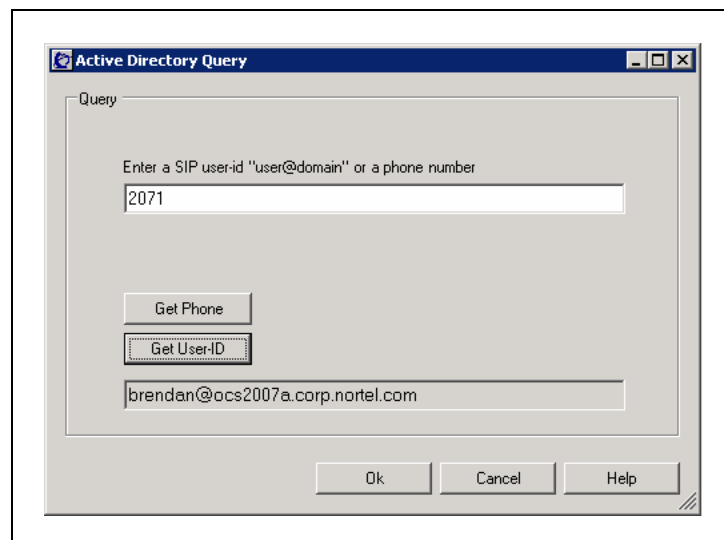
For example: user Brendan McCarthy is defined in the Active Directory as:

SIP URI: sip:brendan@ocs2007a.corp.nortel.com

Line URI: +16239675000;ext=2071

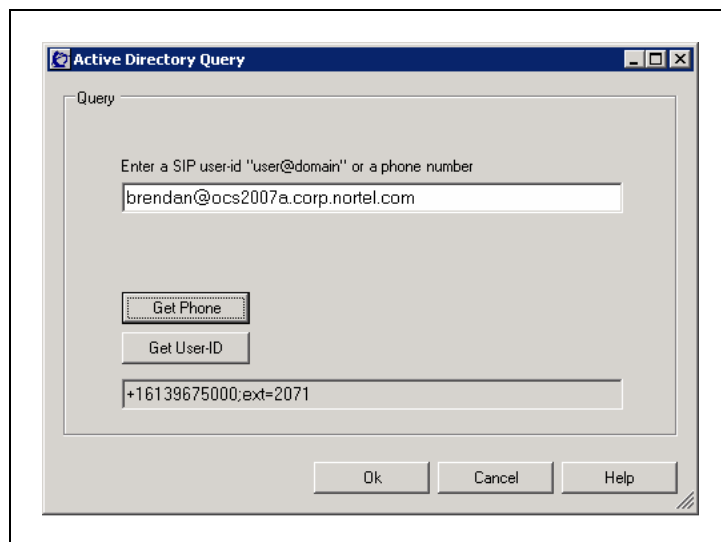
If you type the telephone number in the Query field and click the **Get User-ID** button, the SIP URI appears in the Result field (as shown in [Figure 48 "Get SIP URI" \(page 145\)](#)).

**Figure 48**  
**Get SIP URI**



If you type the SIP URI in the Query field and press the Get Phone button, the Telephone number appears in the Result field (see [Figure 49 "Get phone" \(page 146\)](#)).

**Figure 49**  
**Get phone**



**Field propagations to the Global Catalog** MCM uses the Active Directory Global Catalog to search for necessary user information. However, by default, this Global Catalog contains few Active Directory fields that can be used for MCM (for example, otherTelephone).

To enable a field, for propagation to the Global Catalog, the current schema used by Active Directory must be updated. The `isMemberOfPartialAttributeSet` field of the attribute is responsible for propagation. If configured to true, the attribute is propagated to Global Catalog during replication.

**The Active Directory Schema snap-in** The Active Directory Schema snap-in is not a default MMC (Microsoft Management Console) snap-in provided with Windows Server 2003. To make it appear in the list of available snap-ins, install the Windows Server 2003 Administration Tools Pack (Adminpak.msi). To register the Active Directory Schema snap-in, run `Regsvr32 Schmmgmt.dll` from the command prompt or from the **Run** command on the **Start** menu.

Another option is to execute the command mentioned above, “`Regsvr32 Schmmgmt.dll`”, then run “`mmc`” and select the **File, Add/Remove snap-in** menu item. Click **Add**, then select **Active Directory Schema**. Click **Add**, then **Close, OK**.

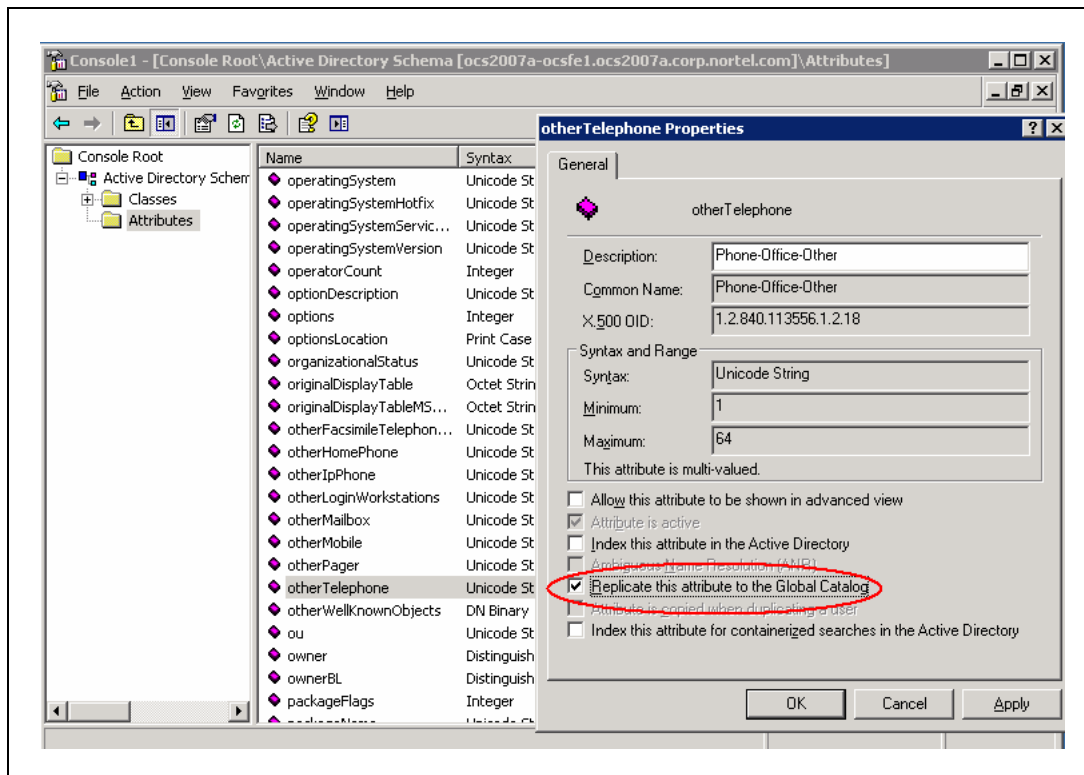
To enable the replication of an attribute to the Global Catalog, use the following procedure:

### Enabling replication to the Global Catalog

Step	Action
1	Open the <b>Active Directory Schema snap-in</b> as depicted in the example <a href="#">Figure 50 "Replicating attributes to the Global Catalog"</a> (page 147).
2	Select <b>Attributes</b> on the left pane.
3	In the <b>Name</b> pane, select the required field. For example <b>otherTelephone</b> .
4	Right-click and select <b>Properties</b> .
5	Select the <b>Replicate this attribute to the Global Catalog</b> check box.
6	Click <b>OK</b> .

—End—

**Figure 50**  
Replicating attributes to the Global Catalog



**Network dial plan section** The following table describes the fields for Dial plan and Access code.

**Table 29**  
**Network dial plan**

Configuration field	Description
Dial plan	Use the dial plan to make calls between the CS 1000 and OCS (CDP or UDP). If the Line URI is configured as UDP, the dial plan will also be UDP.
Access code	Access code for the UDP plan. This code is added to the phone number stored in the OC user's Line URI.

**Outgoing CLID Number Parameters section** The following table describes the fields for Prefix Delete and Prefix Insert.

**Table 30**  
**Outgoing CLID Number Parameters**

Configuration field	Description
Prefix Delete	Number of prefix digits to be deleted from the CLID number sent by MCM to the CS 1000.
Prefix Insert	Prefix digits to be inserted in the CLID number sent by MCM to the CS 1000.

**Outgoing CLID Name Parameters section** Outgoing CLID Name Parameters manipulate the name string to display the name on a CS 1000 configured in the desired format. The name must be defined in the Active Directory in the format Last, First [additional info].

**Table 31**  
**Outgoing CLID Name Parameters**

Configuration field	Description
FirstName LastName	First name Last name—display name format.
LastName, FirstName	Last name, First name—display name format.
LastName FirstName	Last name First name—display name format.
AD Display Name	Click the check box to use the Display Name value from AD for the calling user name.

**SIP CTI Authorization section** Click the Enable RCC Authorization check box to enable the authorization of SIP CTI INVITES from Office Communicator (OC). Only the OC user's phone that is configured in the Active Directory is controlled.

**Configuring MCM for Remote Call Control** For Remote Call Control, the Nortel MCM application that resides within the Office Communications Server domain provides support for authorizing TR/87 service requests and redundancy.

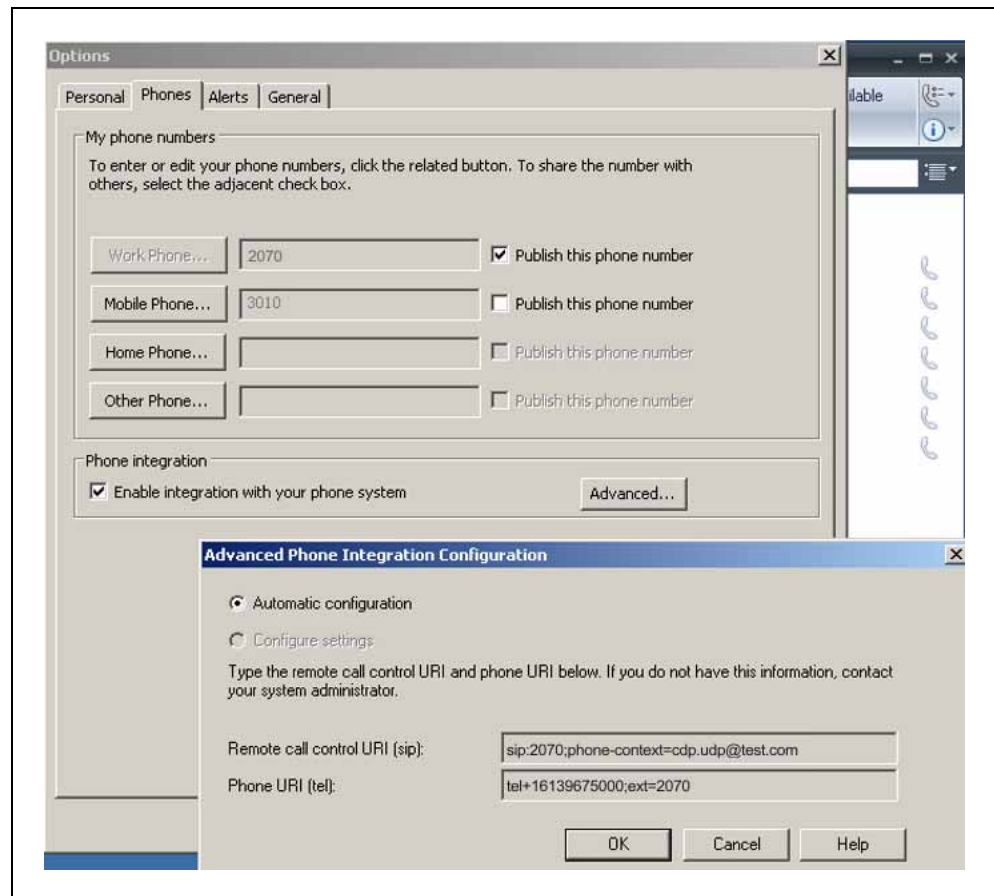
**Authorization of TR/87 service** MCM supports authorization of Remote Call Control service requests from Office Communicator clients. The following is a summary of the authorization algorithm:

1. The SIP INVITE "from" header provides the **Requestor Identity** (for example, the Office Communications Server user identity).
2. The CSTA XML message provides the **Controlled Device Identity** (for example, the phone URI).
3. The **Owner Identity** is found by a reverse lookup using the Controlled Device Identity found in [Item 2](#) as a query to Active Directory (Search Active Directory, Find the User whose msRTCSIP-Line equals "Controlled Device ID", then find the msRTCSIP-PrimaryUserAddress of that User).
4. If a result is found in [Item 3](#), the Owner Identity is equal to the Requestor Identity, and msRTCSIP-OptionFlags has RCC enabled, then approve the request. Otherwise, reject the request.

The primary function of MCM when authorization is enabled, is to ensure that an Office Communicator user can use Remote Call Control only for the phone URI, and that Remote Call Control SIP URI as configured in Active Directory for that user by the System Administrator as depicted in [Figure 51 "Enable phone integration on the client" \(page 150\)](#). Placing control in the hands of the System Administrator is necessary in environments where users must not override their phone integration configuration through the manual phone integration option in Office Communicator.

**Note:** Disabling TR/87 authorization on the MCM is strongly discouraged. When this functionality is disabled, users can override their active directory configuration and control any DN in the system that is provisioned to support SIP CTI.

**Figure 51**  
**Enable phone integration on the client**



**Redundancy** Redundancy of the TR/87 interface is not provided natively with Office Communications Server 2007. Office Communicator does not support multiple Remote Call Control SIP URIs or SIP 300/302 redirection messages. To provide for redundancy of the TR/87 interface, the Nortel MCM application uses the redundancy of NRS and multiple FE endpoints.

## Telephony Gateway and Services configuration

This section describes the process to configure Telephony Gateway and Services.

Office Communications Server, Active Directory and 3.0 must be configured properly prior to configuring the Telephony Gateway and Services component.

## Call Server configuration

CS 1000 configuration involves two separate functions: Signaling Server configuration and Call Server Configuration. All of the Signaling Server configuration is performed in Element Manager. Most of the Call Server configuration can also be done in Element Manager, although some can be done at the Call Server prompt. This document assumes that you are already familiar with how to configure a CS 1000.

In ESN networks, you must configure the correct HLOC in both LD 90 (required for ESN calls to work) and LD 15. If not, basic calling functionality does not work. Also, the Caller ID table, Home NPA, and LOC are required for outgoing calls to the Public network (PSTN) to correctly display the outgoing Caller Line ID (CLID) in North America.

Package 408 is required for both Telephony Gateway and Services and Remote Call Control. Phones need not be configured as "AST," or have "T87A" enabled as a class of service; however, Package 408 must be added in order for Telephony Gateway and Services to work properly.

## Configuring the Codec

The Mediation Server supports the G.711 (20 milliseconds) codec. The G.711 codec must be enforced in the network by defining only the G.711 codec on the CS 1000. If G.711 is not the only codec used, calls to voice mail (such as CallPilot) or call conferencing bridges (such as MCS MeetMe) do not work. The only codec supported for the short leg of a call (Mediation Server to Call Server) is G.711 and for the long leg (Mediation Server to Office Communications Server) is RT audio.

Other codecs cannot be configured on the CS 1000, as Office Communicator calls that tandem through the CS 1000 to other endpoints cannot be allowed to select a codec other than G.711.

The codec is configured as described in *IP Peer Networking Installation and Commissioning* (NN43001-313). [Figure 52 "Codec configuration" \(page 152\)](#) demonstrates the correct location of Element Manager in which to configure the codec.

**Figure 52**  
**Codec configuration**

The screenshot displays the 'CS 1000 ELEMENT MANAGER' interface. On the left is a navigation tree with categories like Home, Links, System, and IP Network. The main area shows the configuration for an 'IP Telephony Node' under the heading '- VGW and IP phone codec profile'. Key settings include:

- Enable Echo canceller:**
- Echo canceller tail delay:** 128 (milliseconds)
- Voice activity detection threshold:** -17 (-20 - +10 DBM)
- Idle noise level:** -65 (-327 - +327 DBM)
- DTMF Tone detection:**
- Enable Modem/Fax pass through mode:**
- Enable V.21 FAX tone detection:**
- FAX maximum rate:** 14400 (bps)
- FAX playback nominal delay:** 100 (0 - 300 milliseconds)
- FAX no activity timeout:** 20 (10 - 32000 milliseconds)
- FAX packet size:** 30
- Codec:** G711 (Selected)
- Codec Name:** G711
- Voice payload size:** 20 (ms/frame)
- Voice playback (jitter buffer) nominal delay:** 40
- Voice playback (jitter buffer) maximum delay:** 80

Buttons for 'Save and Transfer' and 'Cancel' are visible at the top. A note at the bottom right states: 'Modifications may cause changes to maximal delay settings'.

### Loss Plan configuration

In order for DTMF digits to be transmitted at the correct volume, especially for Office Communicator 2007 to PSTN communications, the Loss Plan for the CS 1000 must be correctly configured. Calls from Office Communicator 2007 to a residential Voice Mail system (VoIP to PSTN) is an example of the necessity of Loss Plan configuration.

The DTI Data Block (DDB) must also be configured for the Loss and Level Plans to be configured correctly. For information on how to configure the Loss Plan and the DTI Data Block, see *Transmission Parameters* (NN43001-282).



### ATTENTION

When any kind of in-band signaling is to be used as payload audio packets (for example, DTMF tones) in the egress direction (IP to TDM), the Signal Limiter functionality must be disabled. If problems are encountered with DTMF tones from Office Communicator contact Nortel support to ensure the Signal Limiter functionality is disabled.

### Dialing Plan configuration to route to MCM

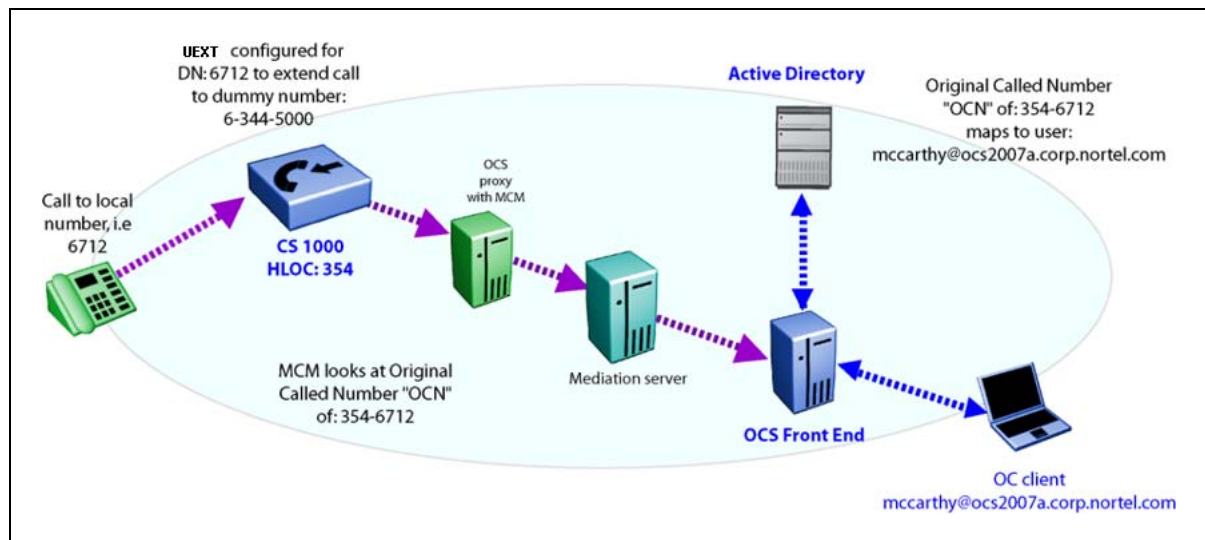
In order for calls to be extended using PCA to the Office Communications Server, a dialing plan entry must be entered on the Call Server to send the call to the SIP trunk. This dialing plan entry does not correspond with any number that is dialable within a network, but rather is used to route the call to the MCM. The MCM service running on the OCS Proxy server handles the incoming call and directs the call to the correct Office Communicator client.

The reason for this is that the SIP Invite generated by PCA has two fields:

- **To:** this field is used for the sole purpose of routing the invite to MCM.
- **Original Called Number (OCN):** this field is used to determine the original number called. The OCN maps to stored information on the Active Directory and sends the call to the correct Office Communicator client.

For example, the CS 1000 network can be configured as shown in [Figure 53 "Dialing plan to route to MCM"](#) (page 153).

**Figure 53**  
**Dialing plan to route to MCM**



In this figure, the CS 1000 has a HLOC of 354 and an LOC dialing plan entry of 344. The LOC dialing plan 344 is not dialable, however, calls to the DN: 6712 extend the call to the number 6-344-5000. By PCA extending the call to 6-344-5000, a SIP Invite is sent to the OCS Proxy server.

The OCS Proxy server runs MCM, which handles the Invite and reads the Original Called Number as 354-6712. The call is sent to the Mediation server and To and RequestURI are mapped to the Line URI. In this diagram the user is mccarthy@ocs2007a.corp.nortel.com

The purpose of configuring is to ensure that the Office Communicator has the same phone number for both incoming and outgoing calls.

For more information about Dialing Plans, see *IP Peer Networking Installation and Commissioning* (NN43001-313).

### Configuring the Personal Call Assistant

Personal Call Assistant (PCA) is used to "twin" incoming calls so users can answer the calls on either their desktop phone or Office Communicator 2007.

For incoming calls to be extended to the "twinned" Office Communicator client, a PCA Terminal Number (TN) must be defined for that DN. A new PCAM Class of Service prompt has been introduced so a distinction is made between PCA associated with the OCS 2007 client and PCA associated with other types of clients. Class is configured using BCC. For more information on BCC, see Basic Client Configuration. PCA associated with the OCS 2007 client, the class is set to PCAM. Other types of clients use the default class PCAG. During call processing, the class is checked to determine whether an incoming call should be extended to the PCA target DN or not. For more information about configuring PCA, see *Features and Services* (NN43001-106).

The PCA TN is configured to send the call to another number. In the case of "twinning" to Office Communicator, the call is sent to a number that is not dialable but routes the invite to the Office Communications Server. For more information, see *Configuring the Dialing Plan to route to MCM*.

#### ATTENTION

##### IMPORTANT!

If SIP CTI control is also enabled for that telephone, the PCA TN cannot be MARP 0.

When you use a PCA, the MARP must be on the DN key of the phone itself, not the PCA. If the MARP is on the PCA, CTI clients (such as Office Communicator) do not receive Remote Call Control call pop-ups for incoming calls (in addition to other problems). This is an unsupported configuration.

Note that MARP is assigned to the first DN key created, so if you create the PCA first and assign a DN key, it becomes the MARP by default. If you add a phone later with the same DN (to twin the phone with Office Communicator) the MARP stays on the PCA and you encounter this exact situation. The following is an example of an unsupported configuration:

**Table 32**  
**LD 22**

Prompt	Response	Description
REQ	prt	
TYPE	dnb	
CUST	0	
DN	2070	
DATE		
PAGE		
DES		

### Screen output

```
DN 2070TYPE SL1
TN > t T 061 0 00 00 V t y KEY 00 MARP DES I2002 i F m
> 28 AUG 2007
(I2002 )
TN 061 0 00 00 V KEY 00 DES I2002 28 AUG 2007
(PCA)
```

**Table 33**  
**LD 20**

Prompt	Response	Description
REQ	PRT	
TYPE	tnb	
TN	096 0 08 15	

### Screen output

```
DES PCA
TN 096 0 08 15 VIRTUALTYPE PCA
CDEN 8D
CTYP XDLC
CUST 0
NUID
NHTN
CFG_ZONE 000
CUR_ZONE 000
ERL 0
ECL 0
FDN
TGAR 1
LDN NO
NCOS 0
SGRP 0
RNPG 0
SCI 0
SSU
XLST
SFLT NO
CAC_CIS 0
CAC_MFC 0
CLS_CTD FBD WTA LPR MTD FND HTD TDD HFD CRPD
MWD LMPN RMMD SMWD AAD IMD XHD IRD NID OLD VCE DRG1
POD DSX VMD SLKD CCSD SWD LND CNDD
CFTD SFD MRD DDV CNID CDCA MSID DAPA BFED RCBD
ICDD CDMD LLCN MCTD CLBD AUTU
GPUD DPUD DNDD CFXD ARHD CLTD ASCD
CPFA CPTA ABDD CFHD FICD NAID DNAA BUZZ
UDI RCC HBTB AHA IPND DDGA NAMA MIND PRSD NRWD NRCD NROD
UDI RCC HBTB AHA IPND DDGA NAMA MIND PRSD NRWD NRCD NROD
DRDD EXR0
USMD USRD ULAD CCBD RTDD RBDD RBHD PGND FLXD FTTC DNDY FDSD
NOVD VOLA VOUD CDMR ICRD MCDD T87D MSNV FRA PKCH PCAM
CPND_LANG ENG
HUNT
PLEV 02
DANI NO
AST
IAPG 0
AACS NO
ITNA NO
DGRP
MLWU_LANG 0
DNDR 0
MLWU_LANG 0
KEY 00 SCR 2070 0
ANIE 0
01 HOT P 4 8888
```

```
ANIE 0
02
03
04
05
06
07
08
09
10
11
12
13
14
15
16
17 TRN
18 AO6
19 CFW 16
20 RGA
21 PRK
22 RNP
23
24 PRS
25 CHG
26 CPN
27
28
29
30
31
DATE 30 AUG 2007
```

For more information about PCA, see *Features and Services* (NN43001-106).

### **Caller ID table configuration**

The Caller ID table is used to correctly build the Caller ID (CLID) for both Private network and Public network calls from a number/extension. The Caller ID table is used by all CS 1000 telephones and is required for Office Communicator calls to work.

In Private network calls where the Uniform Dialing Plan (UDP) is used, the Location Code (LOC) is normally prefixed to the Called and Calling number. Therefore, the Active Directory for all users must include the LOC for their number. A telephone number of ESN 354-6712, has an LOC of 354 and an extension of 6712.

For PCA twinning to work correctly in a UDP environment, the full Original Called Number (OCN) must be sent by the CS 1000 to the Office Communications Server. To have the full OCN sent, the CLID table must be configured with the Home Location (HLOC) of the CS 1000.

Outgoing Office Communicator calls to the Public network must have the Call ID table used by the associated MARP TN (a TN with the same extension used by Office Communicator marked as MARP) correctly configured. The associated MARP TN must point to a Call ID table that has the International Country Code configured. The International Country Code is the prompt INTL (in North America the value is 1). In North America the associated MARP TN must point to a Call ID table that also has the Home Exchange configured. The Home Exchange is the prompt HLCL and is the '967' in 1-800-967-2070.

For example, a phone with an extension of 2070, an ESN number of 231-2070, and a Public Number of 967-2070 in North America is configured in the following manner:

**Table 34**  
**LD 11**

Prompt	Response	Description
REQ	prt	
TYPE	i2002	
TN	061 0 00 00	
DATE		
PAGE		

The following is a portion of the screen output:

```
DNDR 0
KEY 00 SCR 2070 0 MARP
DPND_LANG ROMAN
NAME Chris Smith
```

This user is configured to use the default CLID table entry of 0 (the CLID table number is always next to the extension). The CLID table entry 0 must have the correct HLOC of 354, HLCL of 967, and INTL of 1.

The CLID table entry of 0 with an HLOC of 354 is configured in the following manner:

**Table 35**  
**LD 15**

Prompt	Response	Description
REQ	chg	
TYPE	net	
TYPE NET_DATA		
CUST	0	
OPT		
AC2		
FNP		
CLID	yes	
SIZE	5	
INTL	1	
ENTRY	0	
HNTN		
HLCL	967	
HLOC	354	
...		

The response to SIZE must be a number greater than 0. The response to ENTRY must match the CLID table entry for the target telephones. Generally the default is 0.

### Home LOC and Home NPA configuration

In order for the correct Caller Line ID (CLID) to be correctly displayed for Office Communicator calls to the Public network, both the HLOC and HNPA can require configuration. All Office Communicators that are part of an ESN network require HLOC configuration. All Office Communicators that make calls to the Public network in North America require that the Area Code be configured.

For more information on the HLOC and HNPA, see *IP Peer Networking Installation and Commissioning* (NN43001-313).

### DNS Server configuration

Host Table configuration is replaced in Release 5.0 with DNS configuration. In Element Manager, under LAN configuration (see DNS configuration), you can enter up to three DNS server IP addresses. The DNS server must be correctly configured with the Fully Qualified Domain Name (FQDN) of

all OCS and Enterprise Edition Pools. Also, the FQDN must resolve to the IP address of the OCS for all types of DNS queries (not just for the SIP service type).

DNS server must respond with the correct IP for a generic DNS query. There are a number of different types of DNS queries that can be performed.

### ATTENTION

The Signaling Server must be rebooted to ensure that all DNS server configurations take effect.

**Figure 54**  
DNS configuration

The screenshot shows the 'CS 1000 ELEMENT MANAGER' interface. On the left is a navigation tree with 'DNS Servers' circled in red. The main content area shows configuration sections: '+VGW and IP phone codec profile', '+QoS', 'LAN configuration', 'Embedded LAN (ELAN) configuration' (Call server IP address: 47.11.56.7, Unistim Signaling port: 15000, Broadcast port: 15001), 'Telephony LAN (TLAN) configuration' (Unistim Signaling port: 5000, RTP/RTCP Starting port: 5200), 'Embedded LAN (ELAN) Routes' (Add button), 'Host Table' (Add button), 'DNS Servers' (Primary DNS Server IP address: 47.11.56.51, Alternate DNS Server1 IP address: 0.0.0.0, Alternate DNS Server2 IP address: 0.0.0.0), '+SNTP', and '+Virtual Trunk Network Health Monitor configuration'.

### SIP Trunk configuration

For an Office Communications Server to use a CS 1000 as a SIP Gateway, SIP Trunks must be configured on the CS 1000. The configuration of the SIP Trunk requires that configuration be done on both the Call Server and the Signaling Server. For more information on how to configure SIP trunks, see *IP Peer Networking Installation and Commissioning* (NN43001-313).



A CS 1000 with existing SIP trunks requires a configuration change to be compatible with Office Communications Server. In order for a SIP Trunk to communicate with Office Communications Server, the SIP Transport Protocol must be configured as TCP, not UDP (see SIP Gateway configuration). However, this is not valid when SPS in Proxy All mode is used, since everything goes through SPS.

The default Local SIP Port of 5060 is required.

**Figure 55**  
SIP Gateway configuration window

The screenshot displays the 'SIP GW Settings' configuration window in the Nortel CS 1000 Element Manager. The interface includes a left-hand navigation menu and a main configuration area. The configuration area is divided into several sections:

- TLS Security:**
  - Security Policy: Security Disabled
  - TLS Security Port: 5061 (1 - 65535)
  - Client Authentication:
  - Re-negotiation:
  - X.509 Certificate Authentication:
- Primary Proxy or Re-direct Server:**
  - Primary Proxy or Redirect (TLAN) IP address: 47.11.56.25
  - Port: 5060
  - Supports Registration:
  - Primary CDS Proxy or Re-direct server flag:
  - Transport Protocol: TCP
- Secondary Proxy or Re-direct Server:**
  - Secondary Proxy or Redirect (TLAN) IP address: 0.0.0.0
  - Port: 5060
  - Supports Registration:
  - Secondary CDS Proxy or Re-direct server flag:
  - Transport Protocol: TCP
- CLID Parameters:**
  - Country Code (CCC): 1

### ATTENTION

The Route Data Block (RDB) must have the prompts NCNA and NCRD configured to Yes. Otherwise, calls that are "Twinned" to Office Communicator using PCA do not work.

**ATTENTION**

The Route Data Block (RDB) must not have a value configured for the prompt INST. Otherwise, incoming calls from Office Communicator to the CS 1000 do not work.

**ATTENTION**

When configuring the D Channel used by the SIP Trunk for Converged Office Telephony Gateway and Services, configure the NASA prompt to Yes. Failure to do so can result in limited call transfers through Office Communicator.

The CS 1000 SIP trunk that receives Office Communicator calls must be configured to ESN5, and all associated Virtual trunks must be configured to WNK/WNK. These settings are required so that Office Communicator calls to the Public Network display the correct CLID and have the same Network Class of Service (NCOS) as a call from the associated CS 1000 IP Phone.

The Virtual trunk is WNK/WNK if the output from Element Manager, or a terminal window, is:

```
DES IPTIE
TN 081 0 00 02 VIRTUAL
TYPE IPTI
CDEN 8D
CUST 0
XTRK VTRK
ZONE 000
TRK ANLG
NCOS 0
RTMB 10 3
CHID 3
TGAR 0
STRI/STRO WNK WNK
SUPN YES
AST NO
IAPG 0 *
CLS UNR DIP WTA LPR APN THFD XREP P10 NTC MID
TKID *
AACR NO
```

**ATTENTION**

All of the SIP Virtual Trunks must be configured to WNK WNK.

The Route Data Block is ESN5 if the output from Element Manager, or a terminal window, is:

```
TYPE RDB
CUST 00
DMOD
ROUT 10
DES IPRUTE
TKTP TIE
VTRK YES
ZONE 100
PCID SIP
... ANTK
SIGO ESN5
STYP SDAT
```

#### ATTENTION

If the Route Data Block (RDB) already has associated Virtual Trunks and is configured to SIGO STD, all Virtual Trunks must be removed before the RDB can be changed to ESN5.

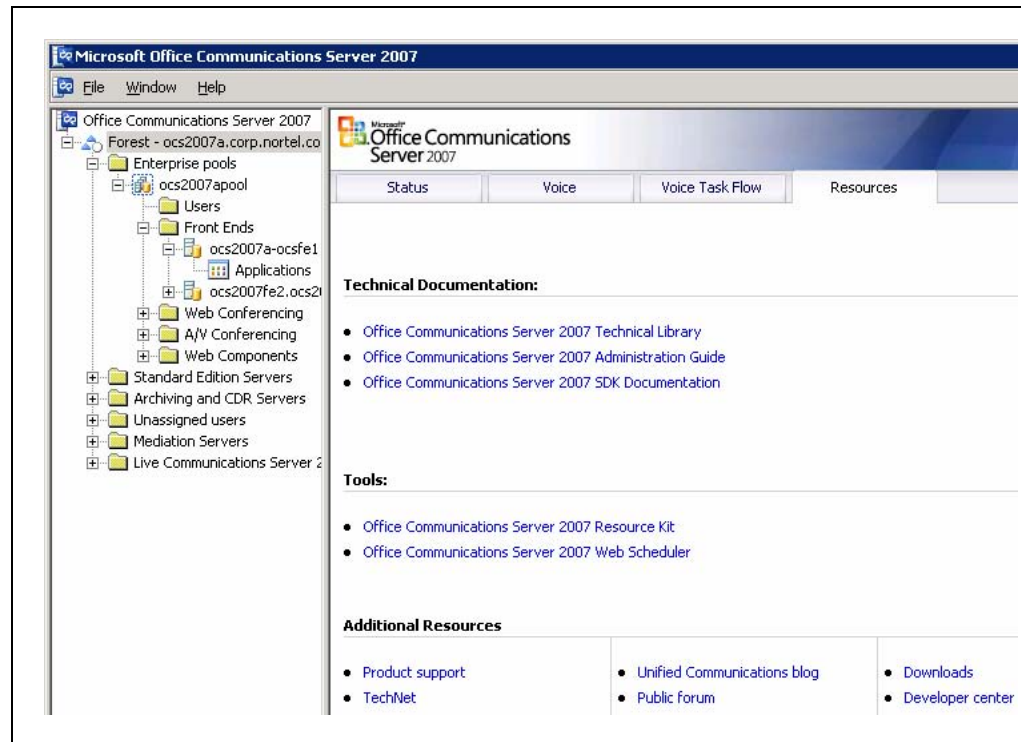
### Domain naming

In most configurations where the CS 1000 acts as a SIP Gateway for a Office Communications Server, it is recommended that the SIP Trunk Domain name and the Office Communications Server Domain name be an exact match.

In situations where both the OCS and the CS 1000 have already both been assigned a domain name, and the domain names do not match, there is an alternative. MCM can be configured to register to the NRS using an End\_Point\_Name@Service\_Domain\_Name. For more information, see Registration

The domain is listed under the Domains folder in the Management console for Office Communications Server. For example, in the next figure, the Office Communications Server Domain is ocs2007a-ocsfe1.ocs2007a.corp.nortel.com.

**Figure 56**  
SIP Trunk Domain name



Configuring the SIP Trunk Domain name describes how to configure the SIP Trunk domain name to match the Office Communications Server domain name.

## Configuring the SIP Trunk Domain name

Step	Action
------	--------

- |   |   |
|---|---|
| 1 | Log into the Element Manager page for the Signaling Server.   |
| 2 | Go to <b>IP Telephony</b> .   |
| 3 | Click <b>Nodes, Servers, Media Cards</b> .  |
| 4 | Select <b>Configuration</b> .   |
| 5 | Click <b>Edit</b> next to the correct node.   |
| 6 | Open the <b>Signaling Server Properties</b> as shown in <a href="#">Figure 57</a> "Element Manager Signaling Server Properties" (page 165). |

**Figure 57**  
**Element Manager Signaling Server Properties**

The screenshot displays the 'Signaling Server 47.11.56.6 Properties' configuration window in the Nortel Element Manager. The interface includes a left-hand navigation tree and a main configuration area. The configuration area contains the following fields and options:

- Role:** Leader
- Type:** HPDL320G4
- Embedded LAN (ELAN) IP address:** 47.11.56.6
- Embedded LAN (ELAN) MAC address:** 00:18:fe:86:49:71
- Telephony LAN (TLAN) IP address:** 47.11.56.23
- Telephony LAN (TLAN) gateway IP address:** 47.11.56.17
- Hostname:** OCS2007\_NODE\_A
- H323 ID:** OCS2007\_NODE\_A
- Enable Line TPS:**
- Enable IP Peer Gateway (Virtual Trunk TPS):** H.323 and SIP (dropdown menu)
- If Telephony LAN(TLAN) IP address and not in the same subnet as Telephony LAN Peer Gateway is enabled, then the TPS is
- Enable SIP Proxy / Redirect Server:**
- Local SIP TCP/UDP Port to Listen to:** 5060
- SIP Domain name:** ocs2007a.corp.nortel.com
- SIP Gateway Endpoint Name:** OCS2007\_NODE\_A
- SIP Gateway Authentication Password:** ●●●●
- Enable Gatekeeper:**
- Network Routing Service Role:** Alternate (dropdown menu)

- 7 In most cases, the value for the field SIP Domain Name must match the domain of the Office Communications Server. In [Figure 57 "Element Manager Signaling Server Properties"](#) (page 165), the SIP Domain name is ocs2007a.corp.nortel.com. Only in situations where the MCM is configured to register to the NRS using End\_Point\_Name@Service\_Domain\_Name can the two SIP Domain Names not match.

—End—

### URI Mapping

The SIP URI Map must be configured in order to correctly register with the NRS. The Private/UDP domain name or Private/CDP domain name is used by MCM to obtain the correct context of the Calling Number.

The SIP URI Map (see SIP URI Map) is also configured in Element Manager under Node Configuration.

**Figure 58**  
**SIP URI Map**

**CS 1000 ELEMENT MANAGER**

- + LAN configuration
- + SNTP
- + Virtual Trunk Network Health Monitor configuration
- + H323 GW Settings
- + Firmware
- + SIP GW Settings
- SIP URI Map**

Public E.164/National domain name	<input type="text" value="+1"/>	*
Public E.164/Subscriber domain name	<input type="text" value="+613"/>	*
Public E.164/Unknown domain name	<input type="text" value="PublicUnknown"/>	
Public E.164/Special Number domain name	<input type="text" value="PublicSpecial"/>	
Private/UDP domain name	<input type="text" value="udp"/>	
Private/CDP domain name	<input type="text" value="cdp.udp"/>	
Private/Special Number domain name	<input type="text" value="PrivateSpecial"/>	
Private/Unknown (vacant number routing) domain name	<input type="text" value="PrivateUnknown"/>	
Unknown/Unknown domain name	<input type="text" value="UnknownUnknown"/>	

- + SIP CD Services
- + SIP CTI Services
- + Microsoft Unified Messaging
- + Cards
- Signaling Servers

The SIP URI Map must match the NRS server configuration in the following manner:

- The Private/UDP domain name maps to the L0 Domain on the NRS
- The Private/CDP domain name maps to the L1 Domain on the NRS

MCM must be configured to match one of the domain names. For example, in a UDP network, the configured domain name is OCS2007\_UDP in MCM. Mediation server supports Mediation server routing and Mediation server load balancing. MCM 3.0 manipulates the SIP URI for VoIP and Device URI for RCC to seamlessly integrate with OCS 2007 and the CS 1000. The mapping phone number into SIP URI user id is not required because it is processed internally by the Mediation server. MCM 3.0 should only process “x-nt-ocn-id” header of incoming messages in the same manner as before.

## SIP Gateway CLID Parameters configuration

The SIP Gateway CLID parameters are used to adjust the format of telephone numbers for incoming call appearances. For Office Communicator, these settings impact the format of numbers that appear on the incoming call pop-up for Telephony Gateway and Services (the SIP call leg for Office Communicator clients that are twinned with a CS 1000 DN through a PCA ).

**Figure 59**  
SIP GW CLID Parameters

The screenshot shows the 'CS 1000 ELEMENT MANAGER' interface. The 'CLID Parameters' section is highlighted with a red circle. The configuration includes the following fields and options:

- Port: 5060
- Supports Registration:
- Secondary CDS Proxy or Re-direct server flag:
- Transport Protocol: TCP
- Country Code (CCC): 1
- Area Code (AreaCode):  (Note: The NPA in North America)
- # Digits to Strip:
- Prefix to Insert:
- Format of CLID:
  - Subscriber Number (SN):  +<CCC><AreaCode><SN>
  - National Number (NN):  +<CCC><NN>
  - International number: +<International number>

**Note:** These settings are independent of the similar SIP CTI CLID parameters to allow independent control of the format of numbers on the incoming call pop-up for telephony gateway and services.

For all public calls (subscriber (for example, NXX in North America), national (for example, NPA in North America), or international) E.164 fully qualified numbers are used to represent the caller. This is made possible through the use of the following parameters:

- Country Code
- Area Code
- Subscriber/Number of Digits to strip
- Subscriber/Prefix to insert
- National/Number of Digits to strip
- National/Prefix to insert

The E.164 format of subscriber calls (for example, NXX in North America) is:

+<countrycode><area code><subscriber number>.

The parameters Subscriber/Number of digits to strip and prefix to insert are used to modify the format of subscriber numbers presented from the PSTN due to region specific requirements.

The E.164 format of national calls (for example, NPA in North America) is:

- +<countrycode><national number>.

The parameters National / Number of digits to strip and prefix to insert are used to modify the format of national numbers presented from the PSTN due to region specific requirements.

**Parameter: Country Code**

This parameter defines the country code to be used in CLID generation.

**Parameter: Area Code**

This parameter defines the area code to be used in CLID generation.

**Parameter: Subscriber / Number of Digits to strip**

For incoming subscriber (NXX) calls this parameter defines the number of digits to strip from the incoming phone number prior to conversion to E.164 format.

**Parameter: Subscriber / Prefix to insert**

For incoming subscriber (NXX) calls this parameter defines the prefix to insert after stripping any digits necessary from the incoming phone number prior to conversion to E.164 format.

**Parameter: National / Number of Digits to strip**

For incoming national (NPA) calls this parameter defines the number of digits to strip from the incoming phone number prior to conversion to E.164 format.

**Parameter: National / Prefix to insert**

For incoming national (NPA) calls this parameter defines the prefix to insert after stripping any digits necessary from the incoming phone number prior to conversion to E.164 format.

## SPS configuration

SIP Proxy Server (SPS) is configured through MCM (see [Figure 45 "MCM Configuration" \(page 140\)](#)). In Release 4.5, the SIP Routing section of the MCM configuration screen had two main options: NRS and Direct. In Release 5.0, Direct is still supported in addition to SPS.

SPS options include:

- **Primary and Secondary IP addresses**



- **Three different modes:** Proxy All, Redirect, and Proxy SIP Gateway Calls
- **Transport:** TLS (5061) and TCP (5060)

For information on configuring the SPS, see NRS configuration.

### NRS configuration

The Server IP running the MCM application (generally an Office Communications Server 2007 Proxy) must be configured on the NRS as a dynamic SIP endpoint, or gateway, and not as a collaboration server.

An Office Communications Server Service Domain must be created for the Signaling Server and MCM. The Signaling Server and MCM register to the Office Communications Server Service Domain on the NRS. The Service Domain between the NRS and the Office Communication Server may or may not match the domain name of the Office Communications Server.

The MCM is configured to register with End\_Point\_Name@Service\_Domain\_Name, where the 'Service Domain Name' matches the Service Domain configured on the NRS

**Figure 60**  
**Office Communications Server Service Domain**

The screenshot shows the Nortel Network Routing Service Manager (NRS) web interface. The main header is "NORTEL NETWORK ROUTING SERVICE MANAGER". The navigation menu includes Home, Configuration, Tools, Reports, Administration, Active DB view (set Standby DB view), Help, and Logout. The current page is "Service Domains" under "Configuration > Service Domains". A sidebar on the left lists various configuration options: Service Domains, L1 Domains (UDP), L0 Domains (CDP), Gateway Endpoints, User Endpoints, Routing Entries, Default Routes, and Collaborative Servers. The main content area displays a table titled "Service Domains" with the following data:

#	ID	Description	# of L1 domains	# of L0 domains	# of gateway endpoints
1	Test	Not available	0	0	0
2	ocs2007a.corp.nortel.com	NRS_SPS	1	1	4

In Office Communications Server Service Domain, the NRS is configured with the matching Service Domain of ocs2007a.corp.nortel.com.

The L1 and L0 Domains must also be configured and match what the CS 1000 is configured under SIP URI Map. Dynamic Gateway endpoints must be configured for the CS 1000 and the MCM with appropriate dialing plan entries.

The NRS must have the same UDP or CDP dialing plan prefix to route calls to the MCM endpoint. This UDP or CDP dialing plan prefix is the same one configured for the PCA calls.

For example, the Location Code (LOC) 354 from the PCA example appears as:

```
01 HOT P 8 63545000
```

The NRS must be configured to analyze and qualify numbers dialed from the Office Communications Server (for example, if you configure prefixes to identify the call type, then you might use 6011 for International, 61 for National, and 6 for UDP).

For more information on how to configure the NRS, see *IP Peer Networking Installation and Commissioning* (NN43001-313).

### **CDR configuration**

Call Detail Recording (CDR) is supported for outgoing calls from Office Communicator. Office Communicator CLID is included in the CDR record. From Office Communicator, when a call is made, the Office Communicator CLID (extracted from the Active Directory) is identified.

The following is an example of an outgoing call:

```
N 024 00 A030 001 T012 023 09/12 10:48:23 00:00:02.0  
614165558888&2452070XXXXXXXXXX
```

The dialed number appears at the end (XXXXXXXXXX) and the Office Communicator CLID and the CDR records appear after the ampersand (&); a location code of 245 is followed by 2070 (a location code of 245 followed by 2070). Again, MCM supports redundant NRS configurations.

### **E.164 International Format Numbers from Office Communicator - Computer Calls (SIP Gateway)**

The dialed number sent from Office Communicator to the CS 1000 for SIP GW calls follows the same format as those dialed on the station. As such, there is no distinction within or outside North America for the handling of computer (SIP Gateway) calls.

Calls to International format numbers are handled by the SIP Gateway and arrive with a request URI in the SIP INVITE for the following call:

```
sip: +CCCXXXXXXXX@domain; user=phone
```

In order to support these calls, placed through the SIP Gateway, you must configure the parameters CNTC, NATC, and INTC in LD 15. These parameters ensure that fully qualified numbers within the same country are dialed as national numbers by stripping the country code and adding the national dial prefix.

### Example 1 (Outside of North America)

AC1=0, CNTC=31, NATC=0, INTC=00

The URI incoming for the SIP INVITE for the call is:

sip:+31123456789@domain.com;user=phone

The digits sent to the outgoing trunk are: 00123456789

The digits seen on the DCH for the outgoing trunk are: 0123456789

### Example 2 (North America)

AC1=8, CNTC=1, NATC=1, INTC=011

The URI incoming for the SIP INVITE for the call is:

sip: +12125551212@domain.com;user=phone

The digits sent to the outgoing trunk are: 812125551212

The digits seen on the DCH for the outgoing trunk are: 12125551212

## Phone number normalization

Now that you have completed the installation and configuration of Telephony Gateway and Services, proceed directly to the next step in the process:

["Normalizing phone numbers" \(page 192\).](#)

## Remote Call Control configuration

This section describes the process to configure the Remote Call Control with the SIP CTI component.

Office Communications Server, Active Directory and MCM 3.0 must be configured properly prior to configuring the Remote Call Control component.

## Remote Call Control and PBX integration

By default users are configured for PC-to-PC communications. Configuring Remote Call Control and PBX integration is done from the User properties in Active Directory and on the Office Communicator client.

### Enabling Remote Call Control and PBX integration

Step	Action
1	On the OCS configuration console, go to Users.
2	Choose a user, right-click and select <b>Properties</b> .
3	In the properties window, in the <b>Advanced Options</b> section, click the <b>configure</b> button.

- 4 Choose **Enable Remote call control** to enable clients control of the PBX phone or **Enable Enterprise Voice** and click the **Enable PBX integration** box to enable both Remote Call Control and Enterprise Voice.

---

—End—

---

### RCC and PBX integration on OC client

After phone integration options are enabled for a user on the server, they are enabled on the OC client.

---

Step	Action
------	--------

---

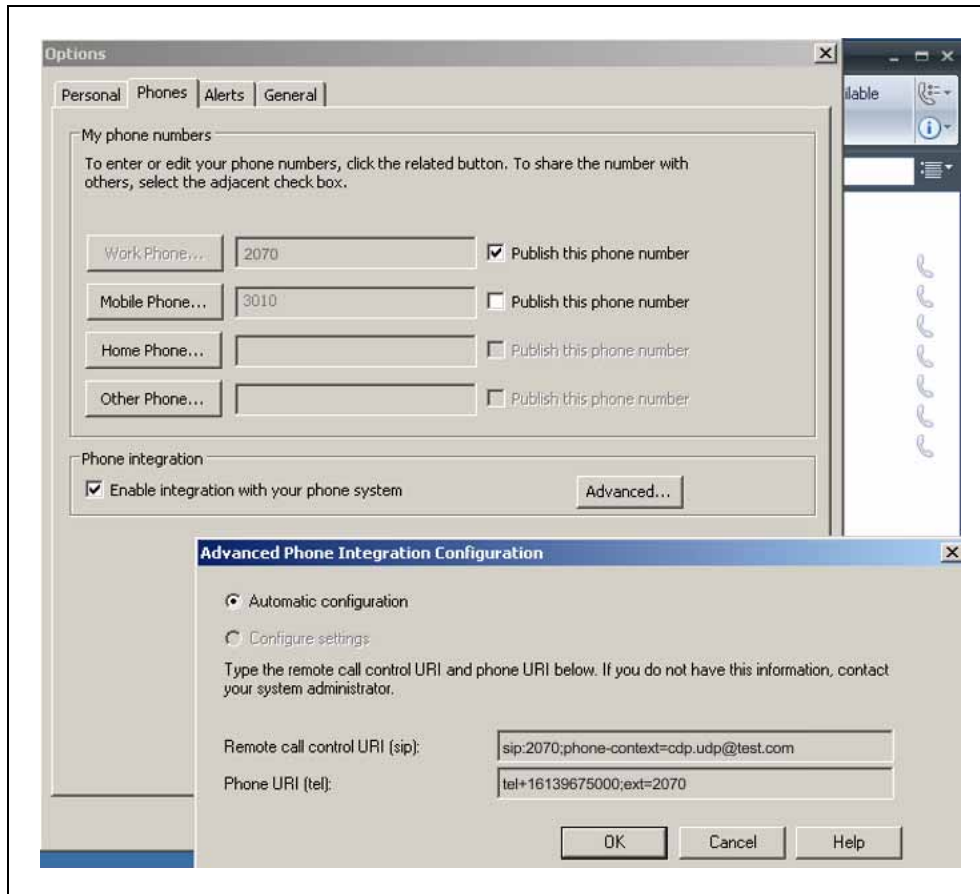
- 1 Go to the **Office Communicator** menu.
- 2 Choose **Tools** and then select **Options**.
- 3 Go to the **Phones** tab.
- 4 Click **Enable integration with your phone system** box to integrate Communicator to control your desktop phone. See [Figure 61 "Enable integration with your phone system"](#) (page 173).
- 5 Click on the **Advanced** button and select **Automatic configuration**. Click **OK**.

---

—End—

---

**Figure 61**  
**Enable integration with your phone system**



## CS 1000 configuration

Application Module Link (AML) is the main interface used to support call control requests from SIP CTI clients between the SS TR/87 FE application and the CS 1000.

Incremental Software Management (ISM) defines the number of TNs that can be accessed through SIP CTI by the Class of Service (CLS) T87A.

Per-TN configuration is required to define which TNs are used for SIP CTI and to define the specific DN keys on each TN that are available for control by SIP CTI applications.

## Configuring the AML

The following tables ("[LD 17: Configure AML Link](#)" (page 174) and "[LD 17: Configure VAS \(Value Added Server\)](#)" (page 174)) display the prompts used for AML link configuration:

**LD 17: Configure AML Link**

Prompt	Response	Description
REQ	CHG	Change existing data.
TYPE	ADAN	
ADAN	<new ELAN #>	A new AML link; the link is an ELAN type. The link number can be from 32 to 47 on a small system and from 32 and 127 on a large system. An AML link number within the above range implies that the transport is over a TCP link.
CTYP	ELAN	Card Type: ELAN

To verify that the AML link is up and running, use the STAT ELAN command from LD 48:

```
LD 48
STAT ELAN
ELAN #: 032 DES: CDLCS
APPL_IP_ID: 47 .164 .116 .43 : 0000F600 LYR7: ACTIVE EMPTY
APPL ACTIVE
```

For more information on the STAT ELAN command, see *Software Input Output Reference — Maintenance* (NN43001-711).

**ATTENTION**

For redundancy, one AML link is required for each Front End within the node, regardless of whether the Front End is a leader or a follower.

**LD 17: Configure VAS (Value Added Server)**

Prompt	Response	Description
REQ	CHG	Change existing data
TYPE	VAS	Value Added Server
VAS	NEW	
VSID	<VAS#>	VAS ID, ranges from 32 to 47 on a small system and from 32 to 127 on a large system
ELAN	<LINK #>	AML ELAN link number provisioned when the AML link was created
SECU	YES	Security For Meridian Link Applications. Enable this for the TR/87 FE application on the Signaling Server to acquire DNs

### Configuring the SIP CTI TR/87 ISM limit

Incremental Software Management (ISM) (SIP CTI TR/87) is used to define the number of TNs that can be configured with the T87A class of service. The TR/87 configuration for a given TN requires that in addition to the existence of the CLS T87A, the controlled line itself must also be identified as an AST DN. This implies that AST ISMs are also required.

As part of the ordering process, a corresponding AST license is provided for each SIP CTI TR/87 license. This ISM limit is prompted only if package 408 (MS\_CONV) is unrestricted (requires level 2 packages).

The SIP CTI TR87 ISM is an instant ISM and does not require a cold start of the Call Server to take effect (see [Figure 62 "LD 22: ISM Limit printout" \(page 175\)](#)).

Prompt	Response	Description
REQ	prt	
TYPE	slt	

**Figure 62**  
**LD 22: ISM Limit printout**

TYPE	slt	Print System Limits		
<...>				
PCA	32767	LEFT 32767	USED	0
ITG ISDN TRUNKS	32767	LEFT 32767	USED	0
H.323 ACCESS PORTS	32767	LEFT 32767	USED	0
<b>AST</b>	<b>32767</b>	<b>LEFT 32767</b>	<b>USED</b>	<b>0</b>
SIPCONVERGED DESKTOPS	32767	LEFT 32767	USED	0
<b>SIP CTI TR_87</b>	<b>32767</b>	<b>LEFT 32767</b>	<b>USED</b>	<b>11</b>
RAN CON	32767	LEFT 32767	USED	0
MUS CON	32767	LEFT 32767	USED	0
SURVIVABILITY	0	LEFT 0	USED	0
<...>				

### Configuring a station

SIP CTI control of a DN key can be supported on IP, digital, and analog stations.

#### ATTENTION

Features such as Make Call and Answer Call depend on the hands-free capability of the station and the on-hook default path configuration on the station. Therefore the use of certain features on stations without hands-free support is limited.

A new CLS (T87A) is introduced to allow a TN to support the SIP CTI application.

The AST prompt is used to configure which DN key on the TN is controlled or monitored by the SIP CTI application. A maximum of two keys per TN can be configured as AST keys.

CLID information is sent, or suppressed, to Office Communicator based on the CLS CNDA/CNDD consistent with the presentation of the CLID information on the station display itself.

This affects whether CLID information (that can be available for calls that do not map to Active Directory users) appears on the Office Communicator call toast (for example, PSTN calls).

### Considering MADN (Multiple Appearance DN)

When you configure a station, you must consider certain issues if Office Communicator is used in a MADN environment:

- When multiple TNs exist in a MADN group, the T87A CLS and AST configuration are configured only on the MARP TN
- When "twinning" a station with Office Communicator using a PCA, the MARP TN within the MADN group must be on a station and not on the PCA. For more information, see [Table 36 "LD 11–Twinning a station" \(page 176\)](#).

**Table 36**  
**LD 11–Twinning a station**

Prompt	Response	Description
REQ	prt	
TYPE	dnb	
CUST	0	
dn	2070	

### Screen Output

```
DN 2070
CPND
XPLN 15
DISPLAY_FMT FIRST,LAST
TYPE SL1
TN 100 0 03 04 V KEY 00 MARP DES DLOCS2 3 DEC 2007 (2004P2)
TN 100 0 03 05 V KEY 00 DES PCA 16 APR 2008 (PCA)
NACT
```



- Any Remote Call Control service request sent by Office Communicator, such as Make Call or Answer Call, always apply to the device defined as the MARP TN.
- For SCR keys telephony, presence updates (for example, on the phone) are supported for all TNs within a MADN group  
*Example:* Answering a call on a wireless station SCR key on a non-MARP TN shows the Office Communications Server user as "On the Phone".
- For MCR keys telephony, presence is supported only for the MARP TN within a MADN group.  
*Example:* Answering a call on a wireless station MCR key on a non-MARP TN does not show the Office Communications Server user as "On the Phone". Only calls answered on the MARP TN affect the presence status of that user.

### NRS configuration

Using NRS is optional. If NRS is used, MCM and TR/87 FE must be configured on the NRS as the Gateway Endpoints.

The corresponding Routing Entries must be defined to support SIP gateway calls.

### Signaling Server configuration

The TR/87 FE application shares the TPS master/follower mechanism to provide redundancy within a node. The TR/87 FE application shares one instance of the SIP stack with the SIP GW and correspondingly uses some of the existing SIP GW configuration parameters:

- SIP Transport Protocol, Local SIP Port, SIP Domain Name
- The SIP URI map

The IP address and domain name of any Office Communications Server proxy responsible for forwarding TR/87 traffic to the Signaling Server must be added to the Signaling Server Host Table in Element Manager. Configure SIP CTI-specific parameters in Element Manager.

#### ATTENTION

When the SIP CTI service is enabled and any dependent configuration parameter is modified in Element Manager, all active SIP CTI sessions are terminated so the configuration data can be updated.

## Node parameter configuration

The node IP is the IP address of the TR/87 FE:

- You can configure multiple nodes to support TR/87 applications for additional capacity. The Remote Call Control SIP URI of users determines which node they use.
- An AML restriction dictates that only one application can acquire a given DN on a Call Server.

### ATTENTION

When you add additional nodes to balance TR/87 load, SIP routing must be configured so that all clients that attempt to control a DN terminate on the same node.

The TR/87 FE application can run within a TPS node as well as a non-TPS node as shown in [Figure 63 "TR/87 Node configuration"](#) (page 178).

**Figure 63**  
TR/87 Node configuration

The screenshot displays the 'NORTEL CS 1000 ELEMENT MANAGER' interface. On the left is a navigation tree with categories like Home, Links, System, Interfaces, Customers, Routes and Trunks, and Dialing and Numbering Plans. The main area shows a list of services: SIP CD Services, SIP CTI Services, Microsoft Unified Messaging, Cards, and Signaling Servers. The 'Signaling Server 47.11.56.69 Properties' window is open, showing various configuration fields. The 'Enable Line TPS' checkbox is checked and circled in red. Other fields include Embedded LAN (ELAN) IP address (47.11.56.69), Embedded LAN (ELAN) MAC address (00:14:5e:83:93:24), Telephony LAN (TLAN) IP address (47.11.56.87), Telephony LAN (TLAN) gateway IP address (47.11.56.81), Hostname (OCS2007NODEB), H323 ID (OCS2007NODEB), Enable IP Peer Gateway (Virtual Trunk TPS) (H.323 and SIP), Enable SIP Proxy / Redirect Server (checked), Local SIP TCP/UDP Port to Listen to (5060), SIP Domain name (ocs2007a.corp.nortel.co), and SIP Gateway Endpoint Name (OCS2007NODEB).

## SIP Gateway parameter configuration

The SIP Gateway application must be enabled. To enable the SIP Gateway, TR/87 FE uses the following SIP Gateway configuration parameters (see Figure 64 "SIP Gateway configuration" (page 179)):

- SIP Transport Protocol (must be TCP for Office Communications Server 2007 deployments)
- Local SIP Port (default 5060)
- SIP Domain Name

**Figure 64**  
SIP Gateway configuration

## DNS Server configuration

Host Table configuration is replaced in Release 5.0 with DNS configuration. The DNS server must be correctly configured with the Fully Qualified Domain Name (FQDN) of all OCS servers and Enterprise Edition Pools.

Also, the FQDN must resolve to the IP address of the OCS server for all types of DNS queries (not just for the SIP service type). (see [Figure 65 "DNS configuration"](#) (page 180))

DNS server must respond with the correct IP for a generic DNS query. There are a number of different types of DNS queries that can be performed.

Step	Action
1	Log on to Element Manager and navigate to LAN configuration.
2	Enter the FQDN of up to three DNS servers.

—End—

**Figure 65**  
**DNS configuration**

The screenshot displays the 'LAN configuration' page in the Nortel CS 1000 Element Manager. The left sidebar contains a navigation menu with categories like Home, Links, System, Interfaces, Customers, and Routes and Trunks. The main content area is titled 'LAN configuration' and includes several configuration sections:

- Embedded LAN (ELAN) configuration:** Call server IP address (47.11.56.66), Unistern Signaling port (15000), Broadcast port (15001).
- Telephony LAN (TLAN) configuration:** Unistern Signaling port (5000), RTP/RTCP Starting port (5200).
- Embedded LAN (ELAN) Routes:** Add button.
- Host Table:** Add button.
- DNS Servers:** Primary DNS Server IP address (47.11.56.114), Alternate DNS Server 1 IP address (0.0.0.0), Alternate DNS Server 2 IP address (0.0.0.0).
- +SNTP**
- + Virtual Trunk Network Health Monitor configuration**
- + H323 GW Settings**
- + Firmware**
- + SIP GW Settings**
- + SIP URI Map**
- + SIP CD Services**

## SIP CTI Services configuration settings

In Element Manager, under SIP CTI services, the Calling Device URI Format must be configured as **phone-context=<SIP URI Map Entries>** to support OCS 2007 RCC. Ensure the **Dial Plan prefix** section values under SIP CTI Services are configured. Click **Save and Transfer** the configuration and then reboot the Signaling Server.

For each of the SIP CTI settings, if a configuration change is made and a save and transfer is performed, all active SIP CTI sessions are terminated to apply the change. Office Communicator automatically reestablishes the session without user intervention.

There is a limitation where you cannot configure SIP CTI for two or more customers on a single node.

See [Figure 66 "SIP CTI Services" \(page 182\)](#) for the settings in Element Manager.

### ATTENTION

Do not choose **support TLS endpoints only** with Mediation Server present because TLS cannot be configured for the entire path as it is not supported (between SPS and MCM).

**Figure 66**  
SIP CTI Services settings

The screenshot shows the 'SIP CTI Services' configuration page in the Nortel CS 1000 Element Manager. The interface includes a left-hand navigation menu and a main configuration area. The 'SIP CTI Services' section is expanded, showing various settings. The 'Service Enabled' checkbox is checked. The 'Support TLS Endpoints Only' checkbox is unchecked. The 'CTI Settings' section includes 'Customer Number' (0), 'Maximum Associations per DN' (10), and 'Place International Calls Within This Country As National Calls' (checked). The 'Dial Plan Prefix' section includes 'National Prefix' (61), 'International Prefix' (6011), 'Location Code Call Prefix' (6), 'Special Number Prefix' (6), and 'Subscriber Prefix' (9). The 'CLID Parameters' section includes 'Dialing Plan' (CDP), 'Calling Device URI Format' (phone-context=<SIP URI Map Entries>), 'Home Location Code' (501), 'Country Code (CCC)' (1), and 'Area Code (AreaCode)' (613). The 'Calling Device URI Format' dropdown is highlighted with a red circle.

### Parameter: Service Enabled

The default state of the SIP CTI service is disabled. To enforce the change of state for this parameter, you must reboot. The SIP CTI service consumes approximately 140 MB of RAM on the Signaling Server when enabled.

### ATTENTION

The configuration change to enable or disable the SIP CTI service is propagated to all Signaling Servers within the node. Ensure that engineering guidelines are considered for all Signaling Servers within the node before you enable this feature.

### Parameter: Customer Number

The customer number parameter defines the customer on the Call Server to which SIP CTI service requests apply. Each TR/87 FE can support one customer number. Additional customers can be supported by adding additional Signaling Servers.

**Parameter: Maximum Associations Per DN**

This parameter defines the maximum number of simultaneous TR/87 SIP dialogs that can be active for a single DN. Multiple instances of Office Communicator (for example, home, office, laptop) are active and each of them can have its own active TR/87 session. This parameter limits the number of simultaneous client sessions for a single DN.

**Parameter: International Calls As National**

This parameter is used in combination with the following parameters:

- SIP CTI Dial Plan Prefix - National Prefix
- SIP CTI Dial Plan Prefix - International Prefix
- SIP CTI CLID Parameters - Country Code

When enabled this feature monitors all SIP CTI calls made using the E.164 international number format. For E.164 called numbers that are within the local country the SIP CTI national dial prefix is used to originate the call from the Call Server. For E.164 called numbers that are outside the local country the international dial prefix is used to originate the call from the Call Server.

When this feature is disabled all SIP CTI calls made using the E.164 number format uses the international dial prefix when originating the call from the Call Server.

Two scenarios are provided using the following example parameters:

- SIP CTI Settings - International Calls As National = Enabled
- SIP CTI Dial Plan Prefix - National Prefix = 61
- SIP CTI Dial Plan Prefix - International Prefix = 6011
- SIP CTI CLID Parameters - Country Code - 1
- AC1 = 6

**Scenario 1** A call is placed from Office Communicator to +14167008000. The TR/87 Front End application on the Signaling Server uses the above SIP CTI settings to determine that the E.164 destination is within the local country. The call originates through AML from the Call Server using the national dial string 614167008000.

**Scenario 2** A call is placed from Office Communicator to +31123456789. The TR/87 Front End application on the Signaling Server uses the preceding SIP CTI settings to determine that the E.164 destination is not within the local country. The call originates through AML from the Call Server using the international dial string 601131123456789.

### SIP CTI Dial Plan prefixes

The SIP CTI dial plan prefixes configuration settings are used to prefix phone numbers sent to the Call Server as a result of SIP CTI call attempts.

**Parameter: National Prefix** When calls are made to E.164 fully qualified numbers this parameter is used in combination with the “International Calls as National” setting in the CTI IP settings section. When a call to an E.164 destination contains the same country code as the local country the call is placed from the Call Server as a national call using this prefix rather than the international call prefix.

This parameter is also used to prefix calls that are made with a URI that contains a phone-context equal to the Public E.164/National domain in the SIP URI map.

Refer to "[Parameter: International Calls As National](#)" (page 183) for an example of the use of this parameter.

**Parameter: International Prefix** When calls are made to E.164 fully qualified numbers this parameter is used in combination with the “International Calls as National” setting in the CTI settings section. If the “International Calls as National” feature is disabled, all calls to any E.164 number are prefixed with this prefix. If the “International Calls as National” feature is enabled, only calls to E.164 destinations outside of the local country are dialed with this prefix.

Refer to the section "[Parameter: International Calls As National](#)" (page 183) for an example of the use of this parameter.

**Parameter: Location Code Call Prefix** This parameter is used to prefix calls that are made with IRAs with a phone-context equal to the Private/UDP domain in the SIP URI map.

This parameter is also used in conjunction with the Calling Device URI Format setting. Refer to the section "[Parameter: Calling Device URI Format](#)" (page 186) for an example of the use of this parameter.

**Parameter: Special Number Prefix** This parameter is used to prefix calls that are made with a URI that contains a phone-context equal to the Public/E.164 Special Number domain in the SIP URI map.

**Parameter: Subscriber Prefix** This parameter is used to prefix calls that are made with a URI that contains a phone-context equal to the Public E.164/Subscriber domain in the SIP URI map.



## SIP CTI CLID configuration parameters

The SIP CTI CLID parameters are used to adjust the format of phone numbers for incoming call appearances. For Office Communicator these settings impact the format of numbers that appear on the incoming call pop-up for Remote Call Control.

### ATTENTION

These settings are independent of the similar SIP GW CLID parameters to allow independent control of the format of numbers on the incoming call pop-up for Remote Call Control.

For all public calls (subscriber (for example, NXX in North America), national (for example, NPA in North America), or international) E.164 fully qualified numbers are used to represent the caller. This is made possible through the use of the following parameters:

- Country Code
- Area Code
- Subscriber/Number of Digits to strip
- Subscriber/Prefix to insert
- National/Number of Digits to strip
- National/Prefix to insert

The E.164 format of subscriber calls (NXX) is:

+<countrycode><area code><subscriber number>.

The parameters Subscriber/Number of digits to strip and prefix to insert are used to modify the format of subscriber numbers presented from the PSTN due to region specific requirements.

The E.164 format of national calls (NPA) is:

+<countrycode><national number>.

The parameters National/Number of digits to strip and prefix to insert are used to modify the format of national numbers presented from the PSTN due to region specific requirements.

### Parameter: Dialing Plan

When configured to CDP, no changes are made to CDP numbers from the Call Server. However, when configured to UDP, the location code prefix and location code are added as a prefix to CDP numbers to aid in normalization. When this setting is enabled all user phone numbers in the active directory

can be entered using the home location code to ensure a consistent unique format throughout the enterprise. Two scenarios are provided using the following example parameters:

- SIP CTI Dial Plan Prefix - Location Code Call Prefix = 6
- SIP CTI CLID Parameters - Home Location Code = 343

### Scenario 1 - SIP STI Dial Plan = CDP

A call is placed to the DN controlled by Office Communicator for RCC from DN 3000 on the same Call Server. The call pop-up that appears on the users desktop shows call from 3000.

### Scenario 2 - SIP CTI Dial Plan = UDP

A call is placed to the DN controlled by Office Communicator for RCC from DN 5000 on the same Call Server. The call pop-up that appears on the users desktop shows call from 634353000.

### Parameter: Calling Device URI Format

This configuration setting defines the phone-context=<SIP URI Map Entries>.

#### ATTENTION

For Office Communications Server installations, phone-context=<SIP URI Map Entries> must be used to ensure compatibility with Office Communicator.

The combination of the URIs generated by the TR/87 FE and the normalization rules available to Office Communicator 2007 define the ability for Office Communicator to match incoming phone numbers to Office Communications Server user identities (for example, on the incoming call pop-up window).

The CSTA-delivered event contains a parameter called callingDevice that notifies the Office Communicator when a call is presented to the Remote Call Control controlled line. This field contains a TEL URI that is generated based on the combination of the SIP CTI dialing plan and Calling Device URI format parameters. Four scenarios are provided where a call is placed to the DN controlled by Office Communicator for RCC from DN 5000 using the following example parameters:

- SIP CTI Dial Plan Prefix - Location Code Call Prefix = 6
- SIP CTI CLID Parameters - Home Location Code = 343

### Scenario 1, Dial Plan = UDP, Calling Device URI Format = phone-context= SIP GW URI map entries:

The TEL URI generated for the caller is:

"tel:3435000;phone-context=udp.nortel.com"

**Scenario 2, Dial Plan = CDP, Calling Device URI Format = phone-context= SIP GW URI map entries:**

The TEL URI generated for the caller is:  
"tel:3000;phone-context=cdp.nortel.com"

**Parameter: Home Location Code**

This parameter defines the home location code to be used in CLID generation in combination with the SIP CTI dial plan setting.

See section "Parameter: Dial Plan" for an example of the use of this parameter.

**Parameter: Country Code**

This parameter defines the country code to be used in CLID generation.

**Parameter: Area Code**

This parameter defines the area code to be used in CLID generation.

**Parameter: Subscriber/Number of Digits to strip**

For incoming subscriber (for example, NXX in North America) calls this parameter defines the number of digits to strip from the incoming phone number prior to conversion to E.164 format.

**Parameter: Subscriber/Prefix to insert**

For incoming subscriber (for example, NXX in North America) calls this parameter defines the prefix to insert after stripping any digits necessary from the incoming phone number prior to conversion to E.164 format.

**Parameter: National/Number of Digits to strip**

For incoming national (for example, NPA in North America) calls this parameter defines the number of digits to strip from the incoming phone number prior to conversion to E.164 format.

**Parameter: National/Prefix to insert**

For incoming national (for example, NPA in North America) calls this parameter defines the prefix to insert after stripping any digits necessary from the incoming phone number prior to conversion to E.164 format.

**North American SIP CTI configuration example**

With the configuration defined as in [Figure 67 "North American CLID Manipulation"](#) (page 188), the following occurs:

- An incoming Subscriber Call with phone number 4005000 produces tel:+16134005000 on the Office Communicator incoming call pop-up.
- An incoming National Call with phone number 4169008000 produces tel:+14169008000 on the Office Communicator incoming call pop-up.

- An RCC call from Office Communicator to the E.164 number +16135006000 produces a call from the controlled DN to 616135006000.

An RCC call from Office Communicator to the E.164 number +33123456789 produces a call from the controlled DN to 601133123456789.

**Figure 67**  
North American CLID manipulation

The screenshot shows the configuration interface for SIP CTI Services. The main title is "CS 1000 ELEMENT MANAGER" with a "Help" link. The configuration is organized into several sections:

- SIP CTI Services:**
  - Service Enabled:
  - Support TLS Endpoints Only:
- CTI Settings:**
  - Customer Number:  (0 - 99)
  - Maximum Associations per DN:
  - Place International Calls Within This Country As National Calls:
- Dial Plan Prefix:**
  - National Prefix:
  - International Prefix:
  - Location Code Call Prefix:
  - Special Number Prefix:
  - Subscriber Prefix:
- CLID Parameters:**
  - Dialing Plan:
  - Calling Device URI Format:
  - Home Location Code:
  - Country Code (CCC):
  - Area Code (AreaCode):  *Note: The NPA in North America*
  - #Digits to Strip:
  - Prefix to Insert:
  - Format of CLID:
  - Subscriber Number (SN):
  - National Number (NN):

### Non-North American SIP CTI configuration example

With the configuration defined as in [Figure 68 "Non-North American CLID Manipulation"](#) (page 189) the following occurs:

- An incoming Subscriber Call with phone number 4005000 produces +311234005000 on the Office Communicator incoming call pop-up.
- An incoming National Call with phone number 00123456789 produces +31123456789 on the Office Communicator incoming call pop-up.

- An RCC call from Office Communicator to the E.164 number +31123456789 produces a call from the controlled DN to 00123456789.
- An RCC call from Office Communicator to the E.164 number +33123456789 produces a call from the controlled DN to 00033123456789.

**Figure 68**  
**Non-North American CLID Manipulation**

The screenshot shows the configuration interface for SIP CTI Services. The main title is "CS 1000 ELEMENT MANAGER". The configuration is organized into several sections:

- SIP CTI Services**:
  - Service Enabled:
  - Support TLS Endpoints Only:
- CTI Settings**:
  - Customer Number:  (0 - 99)
  - Maximum Associations per DN:
  - Place International Calls Within This Country As National Calls:
- Dial Plan Prefix**:
  - National Prefix:
  - International Prefix:
  - Location Code Call Prefix:
  - Special Number Prefix:
  - Subscriber Prefix:
- CLID Parameters**:
  - Dialing Plan:
  - Calling Device URI Format:
  - Home Location Code:
  - Country Code (CCC):
  - Area Code (AreaCode):  *Note: The NPA in North America*
  - #Digits to Strip:
  - Prefix to Insert:
  - Format of CLID:
  - Subscriber Number (SN):
  - National Number (NN):

### Configuring the SIP URI Map

The existing SIP URI map (see [Figure 69 "SIP URI Map" \(page 190\)](#)) configured for SIP GW application is also used by the TR/87 FE application to parse incoming URIs within SIP CTI service requests.

**Figure 69**  
**SIP URI Map**

The screenshot shows the 'SIP URI Map' configuration page in the CS 1000 Element Manager. The page is titled 'CS 1000 ELEMENT MANAGER' and has a purple header. Below the header, there is a navigation menu with '+ SIP URI Settings' and 'SIP URI Map'. The main content area contains several configuration items, each with a label and a text input field:

- Public E.164/National domain name: +1
- Public E.164/Subscriber domain name: +613
- Public E.164/Unknown domain name: PublicUnknown
- Public E.164/Special Number domain name: PublicSpecial
- Private/UDP domain name: udp
- Private/CDP domain name: cdp.udp
- Private/Special Number domain name: PrivateSpecial
- Private/Unknown (vacant number routing) domain name: PrivateUnknown
- Unknown/Unknown domain name: UnknownUnknown

At the bottom of the page, there is a navigation menu with '+ SIP CD Services'.

## Configuring CDR

Call Detail Recording (CDR) records are produced for calls controlled using the Remote Call Control feature. The format of these CDR records is the same as those of calls dialed directly from a telephone's keypad.

## Dialing E.164 International Format Numbers from Office Communicator - Phone Calls (SIP CTI)

When a call is originated from Office Communicator to an E.164 number (such as +14163005000) through Remote Call Control, the make call service request arrives at the TR/87 FE within a SIP INFO message as per the TR/87 specification. See [Figure 70 "SIP INFO message"](#) (page 191).

**Figure 70**  
**SIP INFO message**

```

<?xml version="1.0" encoding="UTF-8"?><DeliveredEvent
xmlns="http://www.ecma-international.org/standards/ecma-323/csta/ed3">
<monitorCrossRefID>37</monitorCrossRefID>

<connection>
  <callID>19806</callID>
  <deviceID>tel:+16139675000;ext=3050</deviceID>
</connection>

<alertingDevice>
  <deviceIdentifier>tel:+16139675000;ext=3050</deviceIdentifier>
</alertingDevice>

<callingDevice>
  <deviceIdentifier>tel:+16139675000;ext=2014</deviceIdentifier>
</callingDevice>

<calledDevice>
  <deviceIdentifier>tel:+16139675000;ext=3050</deviceIdentifier>
</calledDevice>

<lastRedirectionDevice>
  <notRequired />
</lastRedirectionDevice>

<localConnectionInfo>alerting</localConnectionInfo>

<cause>normal</cause>

</DeliveredEvent>
01/21/2008|15:02:18.898 1E498:1E494 INFO :: End of Data Received -
47.11.56.51:5061 (To Local Address: 47.11.56.165:2968) 2113 bytes

```

The TR/87 FE that resides on the Signaling Server contains a feature to insert the appropriate dial plan prefix, either national or international, depending on the location of the Call Server and destination of the call. This ensures calls within the country use the national dial format and calls outside the country use the international dial format. This feature is enabled or disabled in Element Manager in the SIP CTI Settings section. When "All International Calls As National" is enabled, any calls within the local country have the country code stripped from the E.164 number and the national dial prefix applied. The format of the number presented by the TR/87 FE to the Call Server through AML in this scenario is:

<SIP CTI national prefix><national subscriber number>.

Any calls outside the country have only the international dial prefix applied to the E.164 phone number. The format of the number presented by the TR/87 FE to the Call Server through AML in this scenario is:

<SIP CTI international prefix><international number>.

When "All International Calls As National" is disabled, all calls to any E.164 destination use the international dial format. See section "[Parameter: International Calls As National](#)" (page 183) for additional detail on the configuration of this feature and an illustrative example.

## Normalizing phone numbers

Office Communicator 2007 requires that all phone numbers be in standard TEL URI format as defined in RFC 3966 for dialing and for reverse number lookup.

Office Communicator 2007 uses phone numbers that are provisioned (Active Directory and Outlook) and that are adhoc from the user through the user interface. All sources can be free format—a convention that is not in compliance with TEL URI.

The phone numbers configured for the Office Communicator user in the Active Directory are normalized. The PBX private dialing plan phone number is normalized to the Line URI format. For example, E.164;ext=CDP number or UDP number, based on the dialing plan.

The following lists some examples of normalization:

- The number ESN 343-5555 would be normalized to +16139620100;ext=3435555.
- The number +1 (425) 7066340 would be normalized to +14257066340.
- A number 1-800-368-3908 would be normalized to +18003683908.

Phone numbers are normalized in Active Directory. Each user can have multiple phone numbers such as Office, Mobile, and Home. Two options are available to normalize these numbers: **Offline** and **Address Book Service**. See *Microsoft Office Communications Server 2007 Planning Guide* for more information on normalization.

### ATTENTION

All normalization rules must be in Generic script.

## Normalizing Offline (Recommended)

The user's phone number is read from the Active Directory user object, original fields. These numbers are normalized offline to TEL URI format and stored in Active Directory in a different field named proxy address (multi value). Microsoft provides a reference on how to build a tool for this task.

If you use this option, then Address Book Service must not normalize the phone numbers and must instead publish only normalized phone numbers in the proxy address.

Each number in the proxy address is attached with an attribute that describes the phone number (for example: Office, Home, and so on).

For example:



```
tel:+14255551212;ext=5551212;ad-rdn=telephoneNumber;display-Name=(425)555-1212
```

The ad-rdn = telephoneNumber is a proprietary parameter describes the type of the phone number and displayName, which is a proprietary parameter that holds the display format of this phone number (by default, the original phone number before normalization).

By default, the msRTCSIP-RCC Line is copied from the proxy address (attribute ad-rdn=telephoneNumber). The phone number is copied without ad-rdn and display name parameters.

For example:

```
tel:+14257771234;ext=1234;ad-rdn=telephoneNumber;display-name="(425) 7771234 * 1234"
```

is shown as:

```
tel:+14257771234;ext=1234
```

### Normalizing using the Address Book Service

The Run time: Address Book service normalizes the original phone numbers in Active Directory. In this case, the normalized phone numbers are not stored in Active Directory and the output cannot be analyzed before it is used by Office Communicator. Having Address Book Service properly setup for an OC client is essential in receiving correct CLID info on call pop-ups.

### Creating Normalization rules

Matching incoming calling numbers to the phone numbers for a Office Communications Server user, and transforming free-form dialstrings to URIs that can be called through TR/87, is performed by Office Communications Server 2007 and Office Communicator 2007 through a process called Normalization.

Normalization rules, according to Microsoft guidelines, must be defined to make use of the integration of Office Communicator 2007 Remote Call Control and Office Communications Server 2007 Multimedia functionality.

Each Office Communications Server user that uses Office Communicator Remote Call Control capability must have appropriate Office Communications configuration (in addition to the per-TN configuration discussed previously).

You must consider and define SIP routing for TR/87 sessions for each Office Communications Server user.

MCM provides authorization of Remote Call Control service requests based on the configuration defined in Active Directory for each Office Communications Server user.

Office Communicator requires that all phone numbers be in the standardized TEL URI format (RFC 3966) for reverse number lookup (matching the phone number of an incoming call to a known Office Communications Server user) and for dialing (either through an adhoc interface or through a menu from a user object).

Matching an incoming phone number to a Office Communications Server user identity is used to establish multimedia sessions. If the Office Communications Server user identity cannot be determined from a phone number, then Office Communications Server multimedia sessions cannot be established with the calling or called party.

See the *Microsoft Office Communicator Planning and Deployment Guide*. Download Microsoft technical documentation from the Download Center at [www.microsoft.com](http://www.microsoft.com).

For more in-depth information about deploying the Address Book Service, see the *Address Book Service Planning and Deployment Guide*. Microsoft documentation can be found at the Download Center, [www.microsoft.com](http://www.microsoft.com).

### Example

A Office Communications Server user accesses an Active Directory phone number for Jim (in Outlook, for example) to make a Remote Call Control phone call. Office Communicator uses normalization to map the free-form phone number to a TEL URI prior to sending the TR/87 Make Call service request. You can assume the following points for normalizing phone numbers:

- The normalization method chosen is Address Book Service – Run time as opposed to using the offline method
- An Active Directory entry exists for Jim with business phone number ESN 343-2356
- A normalization rule exists that defines a regular expression (as defined in [Figure 71 "Normalization rule example for UDP dial plan" \(page 195\)](#)) to map ESN 343-2356 to +16239675000;ext=3432356.

**Figure 71**  
**Normalization rule example for UDP dial plan**

```
#
# ESN ddd-dddd
#

.*ESN\s* (\d\d\d) [\s () \-\. /] * (\d\d\d\d)
+16139675000;ext=$1$2
```

### Result

- The normalized version (tel:+16139675000;ext=\$1\$2) of the business number in Active Directory entries is stored in the Global Address List (GAL) and downloaded at login by the Office Communicator 2007 client from the Address Book Service.

When you use a contact in a buddy list for Jim, or any other Microsoft Office Application that makes use of Active Directory phone numbers, the URI sent to the TR/87 FE for a TR/87 Make Call service request is:

```
tel:+16139675000;ext=$1$2
```

### Adding a new Normalization rule

The procedure, "[Adding a new Normalization rule](#)" (page 195) describes the process of adding a new normalization rule.

### Adding a new normalization rule

Step	Action
------	--------

- |   |   |
|---|---|
| 1 | Add an appropriate rule to the beginning of the "%ProgramFiles%\Microsoft OC 2007\Address Book Service"\Company_Phone_Number_Normalization_Rules.txt" file. This ensures that the email notification provides the correct link. |
|---|---|

**Figure 72**  
**Company phone number normalization rules for CDP**

```

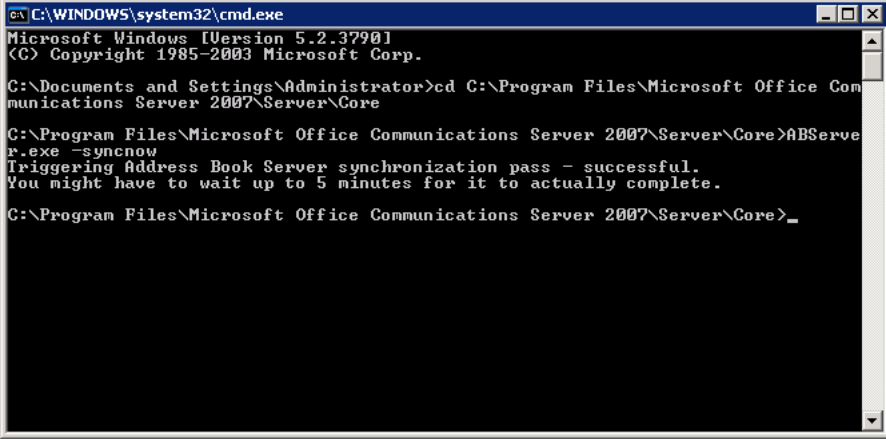
Company_Phone_Number_Normalization_Rules.txt - Notepad
File Edit Format View Help
#+1527053; ext=$3
#
# 70d-dddd xdddd
#
#(\d)([s()\-\.\/]*\d\d\d\d)\s*[xx]+(\d\d\d\d\d\d)
#+1425705152; ext=$3
#
# ddd-dddd xdddd
#
#(\d\d\d\d)([s()\-\.\/]*\d\d\d\d)\s*[xx]+(\d\d\d\d\d\d)
#+14255152; ext=$3
#
# ddd-dddd
#
#(\d\d\d\d)([s()\-\.\/]*\d\d\d\d)
#+14255152
#
# xdddd
#
#[xx]\s*(\d\d\d\d\d\d)
#$1; phone-context=microsoft.com
#
# dddd
#
(\d\d\d\d)
+16139675000; ext=$1
#
# (dd)xxxxxx
#
#(?(\d\d)\s*)?\s*[xx]+\s*(\d\d\d\d\d\d)
#+14255152; ext=$2
#
# 011 dd dddd... xdddd
#
#011(\d+)([s()\-\.\/]+(\d+))?(([s()\-\.\/]+(\d+))?(([s()\-\.\/]+(\d+))?(([s()\-\.\/]+(\d+))?(([s()\-\.\/]+(\d+))?(([s()\-\.\/]+(\d+))?(([s()\-\.\/]+(\d+))?)?)?)?)?)?)?)?)?)?)?
#+15355575911513515517519521; ext=$22

```

- 2 Refresh the Address Book on the server by issuing the following command on the server running ABService as shown in the example [Figure 73 "Refresh Address Book on the server"](#) (page 197):

```
%ProgramFiles%\Microsoft Office Communications
2007\Server\Core\ABServer.exe -syncNow
```

**Figure 73**  
Refresh Address Book on the server



```

C:\WINDOWS\system32\cmd.exe
Microsoft Windows [Version 5.2.3790]
(C) Copyright 1985-2003 Microsoft Corp.

C:\Documents and Settings\Administrator>cd C:\Program Files\Microsoft Office Communications Server 2007\Server\Core

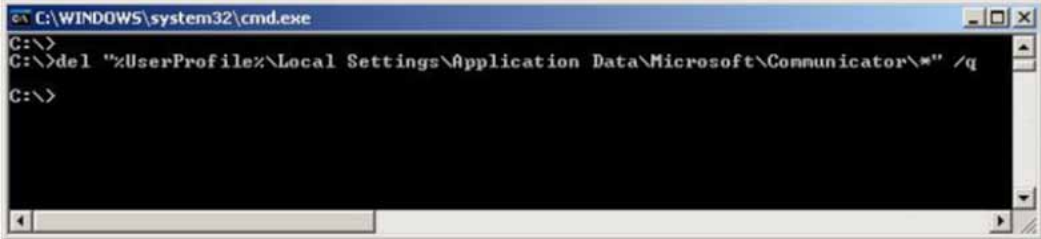
C:\Program Files\Microsoft Office Communications Server 2007\Server\Core>ABServer.exe -syncnow
Triggering Address Book Server synchronization pass - successful.
You might have to wait up to 5 minutes for it to actually complete.

C:\Program Files\Microsoft Office Communications Server 2007\Server\Core>_

```

- 3 Exit from Office Communicator 2007.
- 4 Refresh Address Book on the client as shown in [Figure 74 "Refresh Address Book on the client"](#) (page 197). Issue the following command on the PC running Office Communicator 2007:  
`Del "%UserProfile%\Local Settings\Application Data\Microsoft\Communicator\*" /q`

**Figure 74**  
Refresh Address Book on the client



```

C:\WINDOWS\system32\cmd.exe
C:\>
C:\>del "%UserProfile%\Local Settings\Application Data\Microsoft\Communicator\*" /q
C:\>

```

- 5 Launch Office Communicator 2007.

---

—End—

---

## SIP Routing and Redundancy configuration

Office Communicator is a soft phone application as well as a SIP User Agent (UA). Office Communications Server Front End server (Standard Edition Server or Enterprise Edition Server) hosts Office Communicator .

The TR/87 FE within the Communication Server 1000 is also a SIP UA. Office Communicator 2007 establishes a SIP dialog in one direction only: from the application to the TR/87 FE. The Office Communications Server Front End, which functions as a SIP Proxy, is a required component. The Nortel Multimedia Convergence Manager (MCM) is also required to provide support for authorization and the use of an NRS.

### ATTENTION

Due to the inability of the Office Communicator client to support the SIP 302 redirect message (a fundamental requirement for the basic operation of the NRS), the MCM application installed on the Office Communications Server to support Telephony Gateway and Services functionality is also a required component for Remote Call Control support when using Office Communicator. The MCM application handles the 302 redirect message on behalf of Office Communicator clients.

### Configuring Remote Call Control SIP Routing Using Phone Addressing

When an NRS is used with SIP addressing, based on the phone address format, the Communication Server 1000 TR/87 FE used to support a Remote Call Control session for a user must be co-resident with the SIP GW. This is essential, as the URI that is present in the INVITE to establish a TR/87 session is identical to the URI used to place a SIP call to the user. Thus, the NRS redirects the INVITE based on the request URI only (and not the mime content type within the INVITE).

The TR/87 FE recognizes the TR/87 mime type within an INVITE and intercepts the TR/87 INVITE if it is co-resident with the SIP Gateway. This ensures that both TR/87 sessions and phone calls with the same request URI are handled appropriately — either by the TR/87 FE or SIP Gateway, on the same Signaling Server.

### Redundancy configuration

For information about Redundancy, see "[Redundancy](#)" (page 78).

## OCS 2007 users using UM 2007 in integrated mode

### Option 1 adding user Alias as Exchange UM

These procedures assume the installation procedures for Exchange UM have already been completed. Download Microsoft documentation from the Download Center at [www.microsoft.com](http://www.microsoft.com).

---

### Configuring a basic mailbox for the UM user

---

Step	Action
1	Configure the OCS user mailbox in Exchange UM.
2	Configure SIP URI. For example, ocs2007a.corp.nortel.com
3	Add the Exchange UM Address (Extension) for every Exchange UM user.
4	Select Manually enter mailbox extension and enter the CS 1000 DN xxxx.

---

—End—

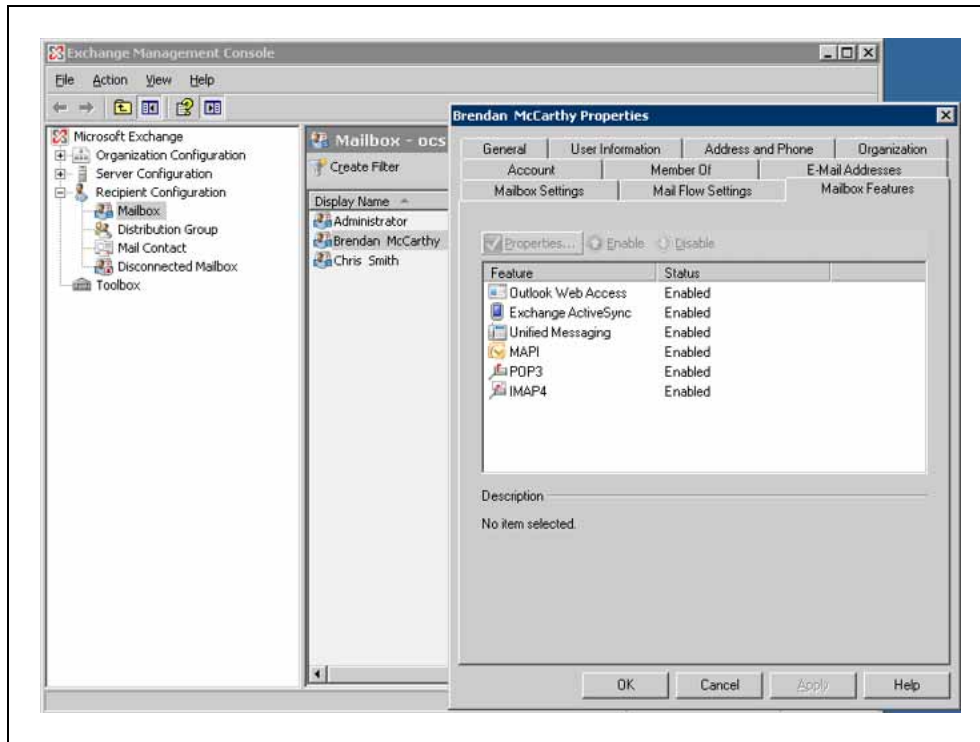
---

### Adding user Alias as Exchange UM

---

Step	Action
1	From the Exchange Management Console, click on <b>Recipient Configuration</b> , and select <b>Mailbox</b> .
2	Select a user. For example, Brendan McCarthy
3	Right-click on the user and select <b>Properties</b> .

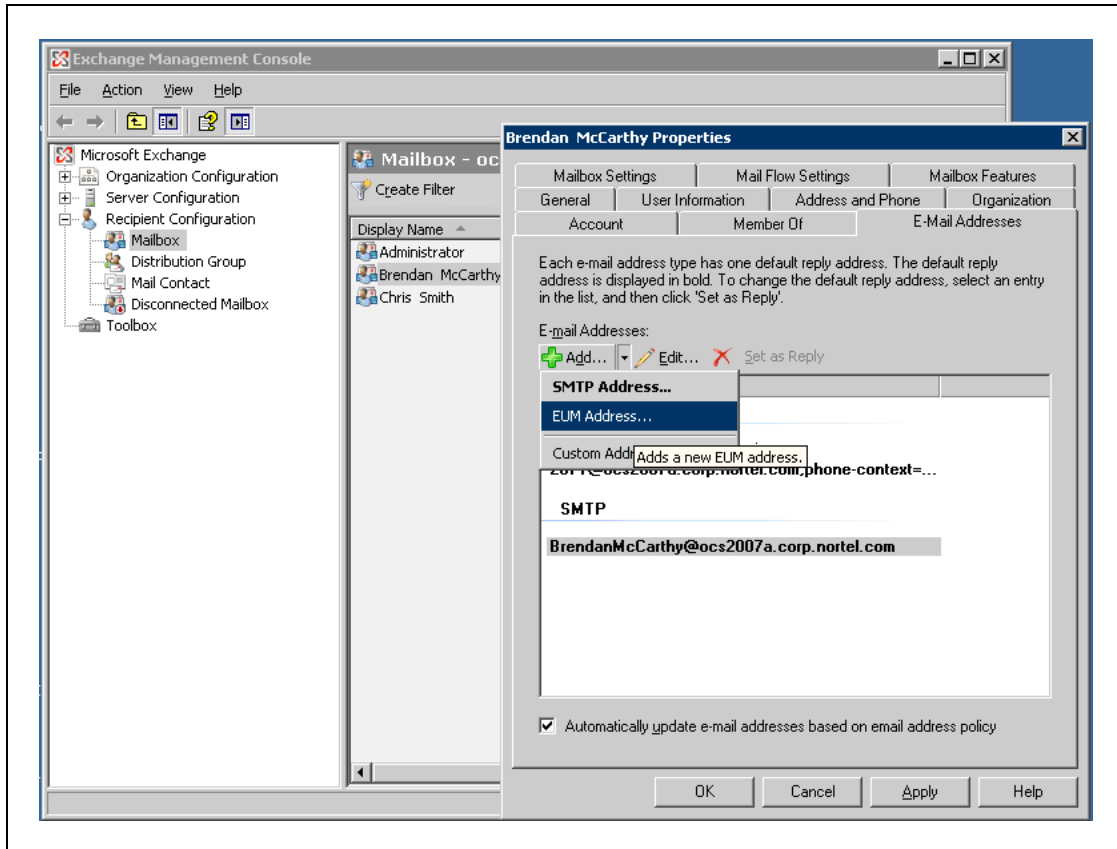
**Figure 75**  
**User Properties window for Exchange UM**



- 4 Click on the **E-mail Addresses** tab.
- 5 Click on the **Add** menu and select **EUM Address**.
- 6 In the UM Address (Extension) window, enter the useralias@domain of the user in the Address/Extension field . For example, brendanmccarthy@ocs2007a.corp.nortel.com

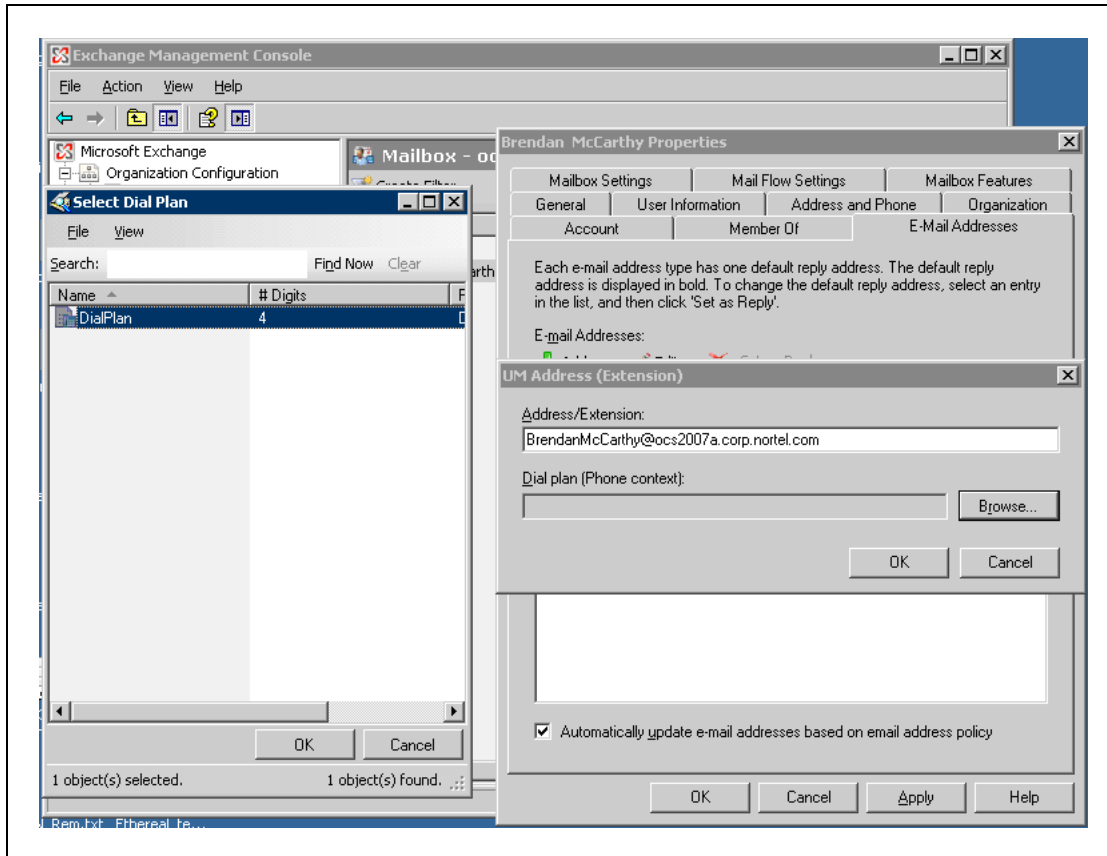


**Figure 76**  
**UM Address**



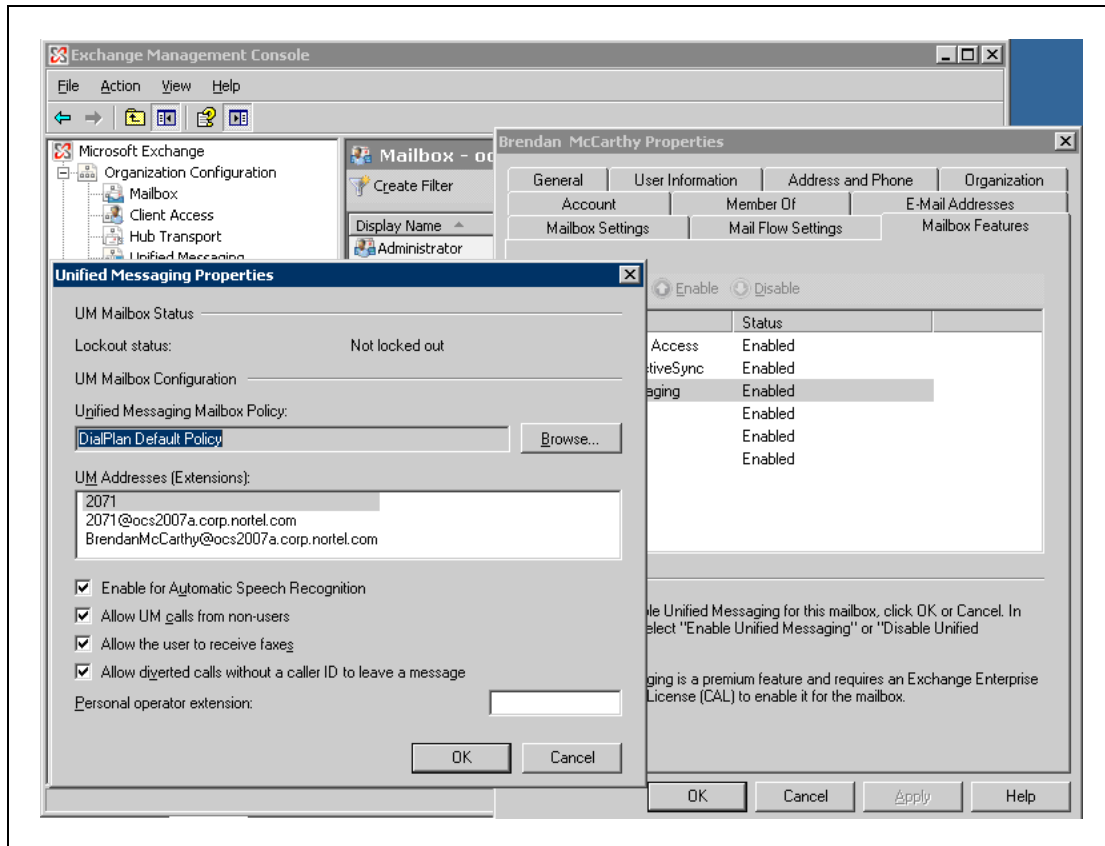
- 7 Click on the **Browse** button to find the associated Dial plan for the user. Click **OK** and then click **Apply** from the E-Mail Addresses tab of the Properties window.

**Figure 77**  
Dial plan window



- 8 The new EUM address is added. To find the new UM Extension, click on the **Mailbox Features** tab, right-click on **Unified Messaging**, and select **Unified Messaging Properties**. In the **UM Addresses (Extensions)** field, there are three addresses.
- CS 1000 DN
  - CS 1000 DN@domain
  - useralias@domain

**Figure 78**  
**Unified Messaging Properties window**



—End—

### Option 2 adding CS 1000 DN as Exchange UM

These procedures assume the installation procedures for Exchange UM have already been completed. Download Microsoft documentation from the Download Center at [www.microsoft.com](http://www.microsoft.com).

### Configuring a basic mailbox for the UM user

Step	Action
1	Configure the OCS user mailbox in Exchange UM.
2	Add the Exchange UM Address (Extension) as CS1000DN@domain for every Exchange UM user.
3	Select Manually enter mailbox extension and the CS 1000 DN xxxx.

4

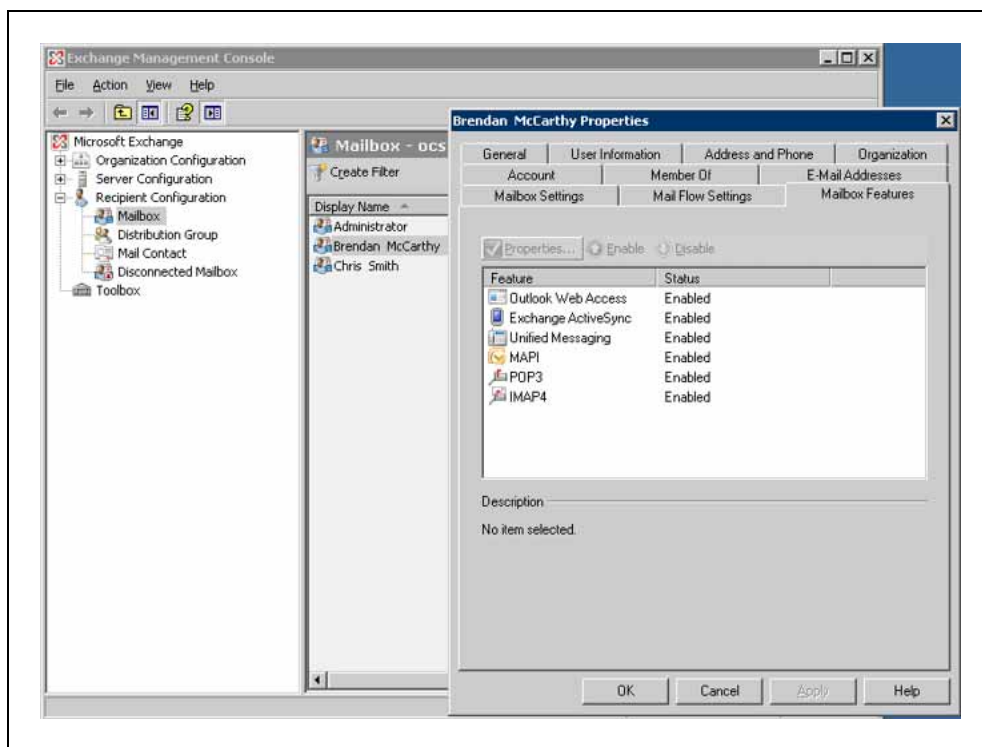
—End—

## Adding Exchange UM

### Step Action

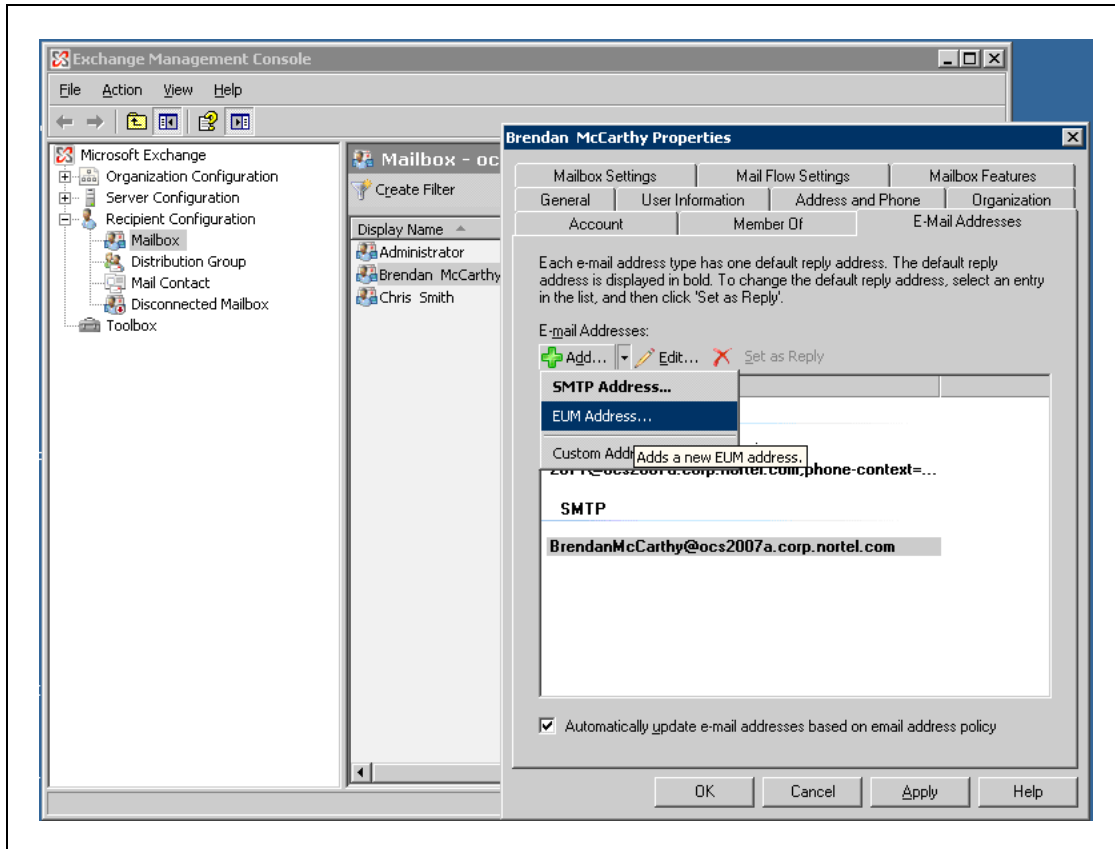
- 1 From the Exchange Management Console window, click on **Recipient Configuration**, and select **Mailbox**.
- 2 Select a user. For example, Brendan McCarthy
- 3 Right-click on the user and select **Properties**.

**Figure 79**  
User Properties window for Exchange UM



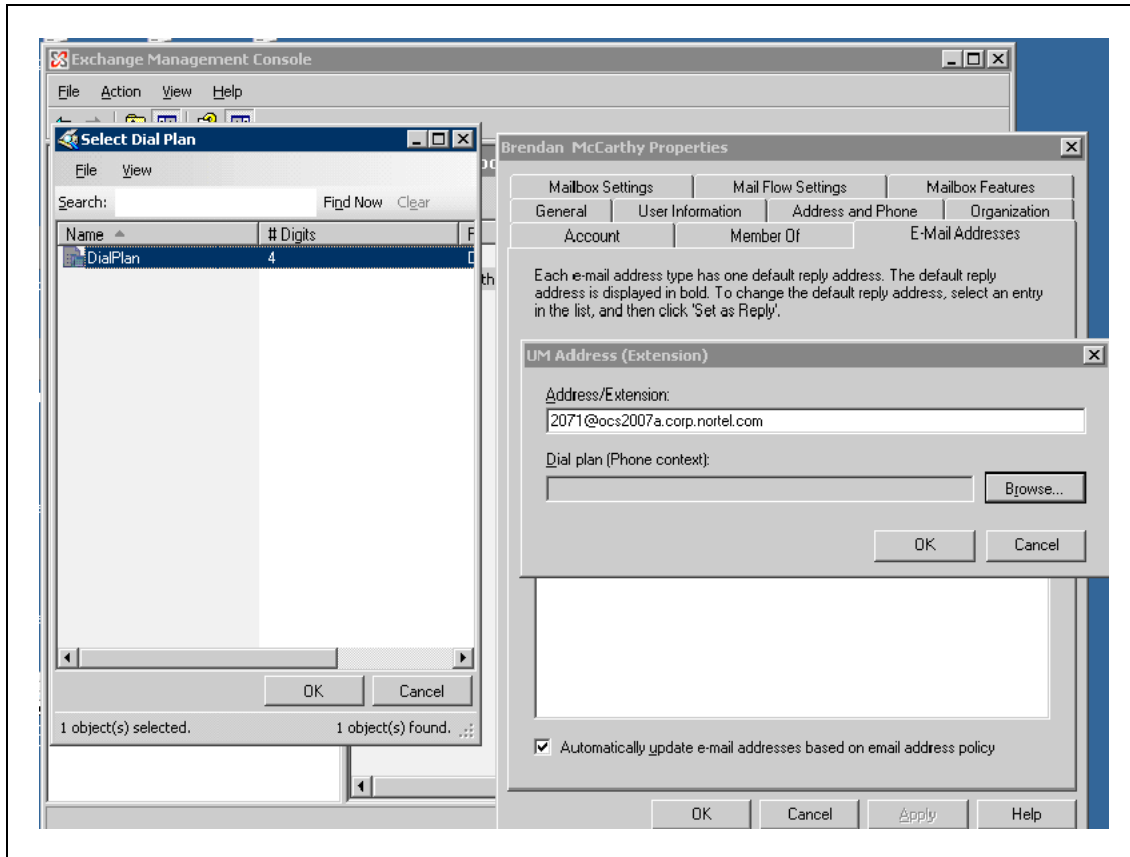
- 4 Click on the **E-mail Addresses** tab.
- 5 Click on the **Add** menu and select **EUM Address**.
- 6 In the UM Address (Extension) window, enter the CS1000DN@domain of the user in the **Address/Extension** field . For example, 2071@ocs2007a.corp.nortel.com

**Figure 80**  
**UM Address**



- 7 Click on the **Browse** button to find the associated Dial plan for the user. Click **OK** and then click **Apply** from the E-Mail Addresses tab of the Properties window.

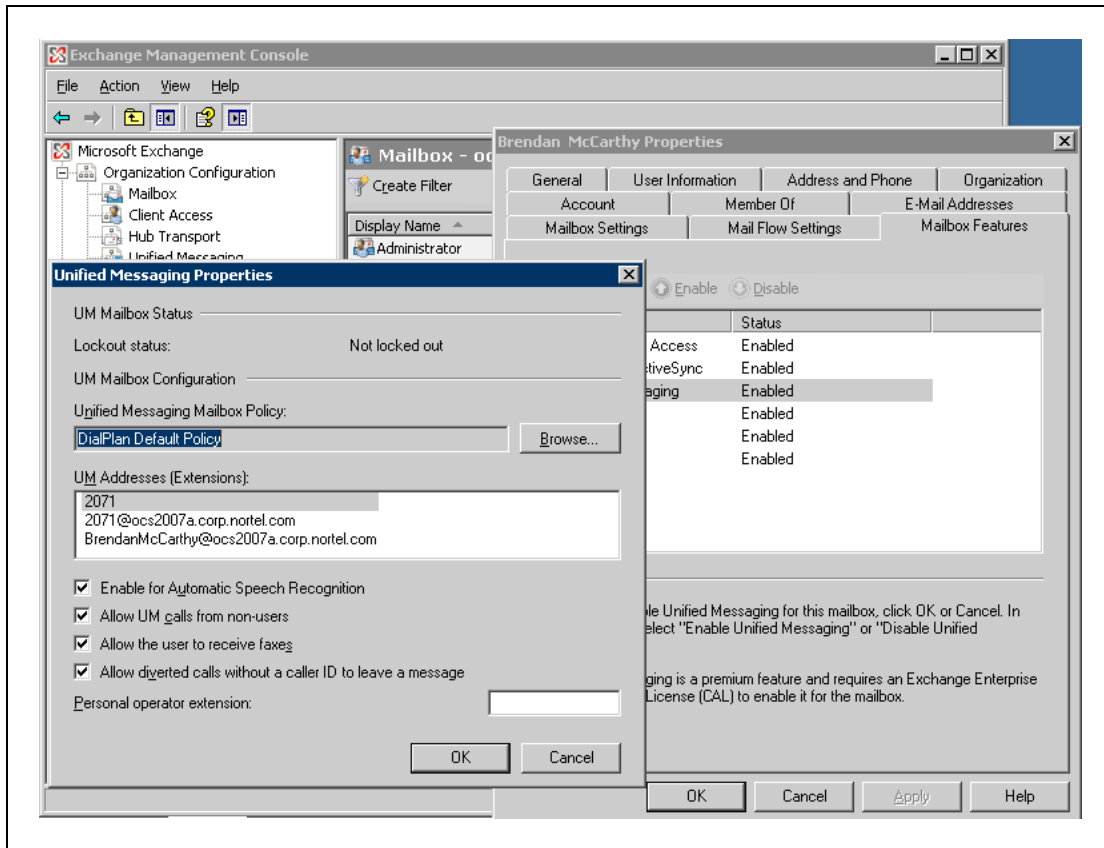
**Figure 81**  
**Dial Plan window**



- 8 The new EUM address is added. To find the new UM Extension, click on the **Mailbox Features** tab, right-click on **Unified Messaging**, and select **Unified Messaging Properties**. In the **UM Addresses (Extensions)** field, there are three addresses.

- CS 1000 DN
- CS 1000 DN@domain
- useralias@domain

**Figure 82**  
**Unified Messaging Properties window**



—End—





---

# Maintenance

---

## Introduction

The following are maintenance tips for MCM 3.0 . For more information on troubleshooting tips, see "[Troubleshooting](#)" (page 215) section.

## Communication Server 1000

No new SIP tracing capabilities are available on the Communication Server 1000. Existing SIP Trunk and Gateway tracing capabilities are used.

## MCM 3.0

MCM 3.0 provides the following maintenance features:

### Tools

MCM provides the following commands on the Tools menu:

- Active Directory Query: Check phone to user-id mapping. DNs can be entered, and found user-ids are displayed
- Backup Data: Back up a configuration file to the user specified location.
- Restore Data: Restore configuration files from user specified location.
- Set Log Level: Determine (configure) which information is logged in the MCM log file. For more information about logging, refer to Log files.
- Get Active Calls Count: Show how many calls are connected through Office Communications Server. You can use the Traffic tool to capture SIP and SIP CTI calls and transactions per hour.
  - The Multimedia Convergence Manager 3.0 service provides a test capability to retrieve user ID by phone number.
  - The Primary and Secondary NRS status utility is available from the application main window.
  - You can deploy Ethereal software on the OCS Proxy to provide call traces. MCM also provides full SIP-tracing capability. MCM SIP tracing is important particularly when MTLs (Mutual Transport Layer Security) is enabled in future Communication Server 1000 releases-where SIP traces cannot be captured by a tool like Ethereal. MCM

SIP tracing can be filtered by DN number. MCM SIP tracing is implemented as part of the application logging functionality. Special commands are not required. For more information on tracing, see [Capturing traces and logs](#)

- You can remotely access the Office Communications Server application using the Windows 2003 server remote access capability.
- Task Manager is supported in Windows 2003 Server for MCM.

### Patches and upgrades

Patching is not supported in MCM 3.0 .. Fixes are provided in up-issues and maintenance releases.

Software upgrades install the new application and use or upgrade the existing configuration file. MCM 3.0 is delivered on a CD and available for download from the Nortel Web site [www.nortel.com](http://www.nortel.com).

#### ATTENTION

All customer configured MCM application data is retained during an MCM application upgrade.

## Remote Call Control

### Signaling Server OAM Level CLI Commands

The Signaling Server OAM Level CLI commands are used to query active TR/87 sessions to turn on tracing at the SIP level. You can use these commands to terminate either a session for a specific DN or to terminate all TR/87 sessions that are currently active on the server.

**Table 37**  
**Signaling Server OAM Level CLI commands**

Prompt	Response	Description
>	SIPCTISessionShow	Show the total number of TR87 SIP sessions.
>	SIPCTITraceShow	Display the trace settings for SIP CTI application, including the trace filter setting and output setting.
>	SIPCTIShow	Show SIP CTI application status and configuration.
>	SIPCTIClientShow	Show information about the all the soft clients associated.

Prompt	Response	Description
>	SIPCTITraceLevel <level>	Configure the TR87 SIP message Trace Level. The level can be one of the following:  0 –TR87 SIP message body (ECMA 323) only  1 – TR87 SIP message body (ECMA 323) and message headers
>	SIPCTITrace on	Turn on SIP CTI trace for all soft clients in both incoming and outgoing directions.
>	SIPCTITrace off	Turn off SIP CTI trace for all soft clients in both incoming and outgoing directions.
>	SIPCTITrace <MsgRcv> <MsgSend>	Turn on SIP CTI trace for all soft clients in incoming and/or outgoing. The parameter is either on or off.
>	SIPCTITrace sc <soft client SIP/Tel URI/DN> <MsgRcv ><MsgSend>	Turn on SIP CTI trace for a specific soft client in incoming and/or outgoing direction(s). This may result in a number of sessions as a single URI could be used for multiple active sessions.
>	SIPCTIOutput <Dest> <"fileName">	Redirecting the SIP CTI trace to a specific output destination.  The destination can be one of the following:  1. TTY 2. RPTLOG 3. File  If File is selected as the output destination, the filename must be given.

Prompt	Response	Description
>	SIPCTIStop all	De-acquire all AST DNs and terminate all the TR87 SIP sessions.
>	SIPCTIStop <dn>	De-acquire one specific AST DN and terminate all the TR87 SIP sessions associated with this AST DN.

### Operational Measurements for SIP CTI

The following Operational Measurements (OM) details are collected for SIP CTI:

- SIPCTITotalSoftClientLoginAttempts
- SIPCTITotalSoftClientLoginSuccesses
- SIPCTITotalAnswerCallRequests
- SIPCTITotalAnswerCallSuccesses
- SIPCTITotalClearConnectionRequests
- SIPCTITotalClearConnectionSuccesses
- SIPCTITotalConsultationCallRequests
- SIPCTITotalConsultationCallSuccesses
- SIPCTITotalDeflectCallRequests
- SIPCTITotalDeflectCallSuccesses
- SIPCTITotalHoldCallRequests
- SIPCTITotalHoldCallSuccesses
- SIPCTITotalMakeCallRequests
- SIPCTITotalMakeCallSuccesses
- SIPCTITotalRetrieveCallRequests
- SIPCTITotalRetrieveCallSuccesses
- SIPCTITotalSingleStepTransferRequests
- SIPCTITotalSingleStepTransferSuccesses
- SIPCTITotalTransferCallRequests
- SIPCTITotalTransferCallSuccesses
- SIPCTITotalMonitorStartRequests
- SIPCTITotalMonitorStartSuccesses
- SIPCTITotalMonitorStopRequests

- SIPCTITotalMonitorStopSuccesses
- SIPCTITotalConferenceCallRequests
- SIPCTITotalConferenceCallSuccesses
- SIPCTITotalSetForwardingRequests
- SIPCTITotalSetForwardingSuccesses
- SIPCTITotalGetForwardingRequests
- SIPCTITotalGetForwardingSuccesses
- SIPCTITotalSessionTerminated

For information on how to access these OM's through Element Manager, see *Element Manager System Administration* (NN43001-632).

### Signaling Server Expert Level CLI Commands

Using Signaling Server Expert Level CLI commands, as shown in [Table 38 "Signaling Server Expert Level CLI commands" \(page 213\)](#), you can trace AML commands that are sent by the TR/87 FE to the Call Server on behalf of the Office Communicator clients that may be active.

**Table 38**  
**Signaling Server Expert Level CLI commands**

Prompt	Response	Description
	SIPCTIAmiTrace level	Configure AML Trace level for SIP CTI application.
		The level can be one of the following:
		0—Turn off trace.
		1—Print all input and output AML data buffer.
		2—Print all input and output AML data buffer except POLLING message.
		3—Print all input and output AML data buffer except POLLING message, with IE type decoding.

Prompt	Response	Description
		4—Print all input and output AML data buffer except POLLING message with IE type and data decoding.
		<p style="text-align: center;"><b>ATTENTION</b></p> <p>This trace prints out AML messages to and from CS at the transport layer. Because sending and receiving AML messages are per AML link instead of per DN or TN, no good solution exists to filter on this AML trace tool. Nortel recommends that you do not turn on the trace in a busy system.</p>

---

# Troubleshooting

---

Use the following procedures to assist in troubleshooting general Converged Office problems.

## Checking Telephony Gateway (SIP Gateway) configuration

### Checking Telephony Gateway configuration

---

Step	Action
1	Check all required Communication Server 1000 resources (packages, license, and Communication Server 1000 patches).
2	Check the DN, telephone TN and PCA configuration.
3	Check the DNS on the Signaling Server.
4	Verify the Signaling Server SIP and the MCM endpoint registration on the NRS.
5	Ensure that MCM is registered to the NRS.
6	Verify the Host Authorization and Certificates for Office Communications Servers and Pool.

**ATTENTION**

Improper configuration of Host Authorization and Certificates for Office Communications Servers and Pool is the primary reason Converged Office does not function properly in the Enterprise Edition configuration.

---

—End—

---

## Checking Remote Call Control (SIP CTI) configuration

### Checking Remote Call Control configuration

Step	Action
1	Check all required Communication Server 1000 resources (packages, license, and Communication Server 1000 patches).
2	Check the DN, telephone TN, and PCA configuration.
3	Verify that AST, IAPG, and CLS (CDMR/TR87A) are configured correctly (SIP CTI only).
4	Verify that the AML Link status is up. Make sure that the ELAN ID is greater or equal to 32 (SIP CTI only).
5	Check the SIP CTI status (on the Signaling Server, under PDT, issue the command SIPCTIShow). Make sure the SIP CTI status reads <b>Application status: Active</b> (SIP CTI only).
6	Check the DNS on the Signaling Server.
7	Verify the Signaling Server SIP and the MCM endpoint registration on the NRS.
8	Ensure that MCM is registered to the NRS.
9	Verify the MCM configuration for the Called Phone Context and check it against the Signaling Server configuration for the SIP URI map and Private/CDP domain name parameter (SIP CTI only).
10	Verify the Routing, Host Authorization, and Certificates inside OCS servers and Pool.  <b>Note:</b> Improper configuration of Routing, Host Authorization, and Certificates on OCS Servers and Pool is the primary reason Converged Office does not function properly in the Enterprise Edition configuration.
11	If the problem still exists, go to the section Capturing traces and logsto assist further.

—End—

## Lack of memory on Signaling Server

### Problem:

Lack of memory on Signaling Server.



**Symptom:**

After SIP CTI services are activated, you are unable to log on to the Signaling Server through Element Manager. When rebooting, some HTTP tasks are not up.

**Possible cause:**

Insufficient memory.

**Solution:**

Check the memory and upgrade the memory to 1 gigabyte (GB), if required. The Signaling Server (running Converged Office) requires 1 GB of memory. Release 4.5 only required 512 megabytes (MB).

## SIP CTI services does not come up

### SIP Dialog not established

**Problem:**

Phone integration is enabled in Office Communicator and a SIP dialog for TR/87 was attempted and not established successfully.

**Symptom:**

When logged into the Office Communicator, the phone icon is not displayed.

**Possible cause 1:**

The Server URI or the Line URI is incorrect.

**Possible cause 2:**

Use Microsoft's nslookup tool to verify the DNS configuration on the Signaling Server and the Host Name resolution for each IP address. For more information on the nslookup tool, see [Figure 83 "nslookup tool" \(page 218\)](#), or visit the Microsoft Web site at <http://support.microsoft.com/kb/200525>.

**Figure 83**  
nslookup tool

```

c:\windows\system32\cmd.exe - nslookup
Microsoft Windows [Version 5.2.3790]
(C) Copyright 1985-2003 Microsoft Corp.

C:\windows\system32>nslookup
Default Server: ocs2007a-ocsfe1.ocs2007a.corp.nortel.com
Address: 47.11.56.51

> 47.11.56.51
Server: ocs2007a-ocsfe1.ocs2007a.corp.nortel.com
Address: 47.11.56.51

Name: ocs2007a-ocsfe1.ocs2007a.corp.nortel.com
Address: 47.11.56.51

>

```

### **Solution 1: Check configuration parameters in AD**

Check the configuration parameters in Active Directory for this user. Run a SIPCTITrace on the Signaling Server and check the MCM logs. For more information on activating the trace, see ["SIP CTI traces on the Signaling Server"](#) (page 226) and Activating MCM debug trace

### **Solution 2: Confirm FQDN and the IP address are correct**

#### **Solution 2:**

Confirm that the FQDN (case sensitive) and the IP address are correct.

For causes (not mentioned), the following actions may help identify the problem:

- Activate AML traces on the Call Server to check if the IACR/IACS (TN acquire) is correct. For more information on capturing traces, see ["AML traces on the Call Server \(SIP CTI only\)"](#) (page 226)
- Activate SIPCTITrace. For more information on capturing traces, see [Table 42 "SIP CTI trace in PDT"](#) (page 226)
- Activate OCS Front End server and Proxy server traces
- Activate MCM logs
- Capture Ethereal traces

### **SIP CTI service is down**

#### **Problem:**

SIP CTI service down.

#### **Symptom:**

After SIP CTI services are activated, SIP CTI services does not come up.

**Possible cause:**

VSID or ELAN ID is lower than 32.

**Solution:**

Follow the procedure ["Reconfigure SIP CTI service"](#) (page 219) to solve this issue.

**Reconfigure SIP CTI service**

Step	Action
1	Reconfigure the VSID and ELAN IDs so both are greater than 32. Confirm that the SIP CTI service is up.
2	Check the SIP CTI status on the Signaling Server.

**Table 39**  
**Check the SIP CTI status**

Prompt	Response	Description
pd>	SIPCTIShow	show SIP CTI status and settings

See [Figure 84 "Screen output example for SIP CTI status"](#) (page 219).

**Figure 84**  
**Screen output example for SIP CTI status**

```

pd> SIPCTIShow
SIP CTI Status and Settings:
-----
Application status: Active
Customer number: 0
Dialing plan: CDP
SIP URI format: FQDN
Maximum number of associations per DN: 10
Support TLS Endpoints Only: FALSE
-----
CTI Dial Plan Information
-----
Home Location Code: "Not Configured"
Country Code: "Not Configured"
NPA Prefix: "6"
INTL Prefix: "6"
LOC Prefix: "9"
SPN Prefix: "6"
NXX Prefix: "6"
-----
CTI CLID Information
-----
International Calls As National: TRUE
Subscriber / Number of digits to strip: 0
National / Number of digits to strip: 0
Area Code: "Not Configured"
Subscriber / Prefix to insert: "Not Configured"
National / Prefix to insert: "Not Configured"
pd>

```

### 3 In LD 48, check the ELAN status on the Call Server

**Table 40**  
**LD 48**

Prompt	Response	Description
.stat	elan	Check the ELAN status on the Call Server

**Screen output:**

```
SERVER TASK: ENABLED
ELAN #: 032 DES: CDLCS
APPL_IP_ID: 47.11.157.112 : 0000F600 LYR7: ACTIVE EMPTY
APPL ACTIVE
```

---

—End—

---

## MCM not synchronizing new users in AD Cache mode

**Problem:**

MCM cannot synchronize new users in AD Cache Mode.

**Symptom:**

Several new users are configured in AD, but MCM did not download them to its AD Cache during synchronization and cannot find them.

**Possible cause 1:**

The changes made to those users in AD is not replicated to the Global Catalog (GC) server used by MCM.

**Possible cause 2:**

MCM Service credentials are not sufficient to view the msRTCSIP properties.

**Possible cause 3:**

The Active Directory field is not enabled for propagation to the Global Catalog.

### **Solution 1: Check the Global Catalog content manually**

Consult with the Network Administrator about the schedule of replications between Domain Controllers (DCs).

Alternatively, check the GC content. Follow the steps in "[Checking the Global Catalog content manually](#)" (page 221).

---

## Checking the Global Catalog content manually

---

Step	Action
1	Install the Operating System Support Tools on the server (usually the Tools setup is on the MS Windows 2003 Server setup disk).
2	Run the LDP tool (%ProgramFiles%\Support Tools\ldap.exe).
3	Connect to the GC server IP address at the port 3268 (Connection -> Connect ...).
4	Bind with the MCM service account credentials (Connection -> Bind ...).
5	Download the AD structure tree (View -> Tree).
6	Navigate to the object of one of those just configured users.
7	Confirm that the object contains the properties: <ul style="list-style-type: none"> <li>• msRTCSIP-UserEnabled and it is configured to TRUE</li> <li>• msRTCSIP-PrimaryUserAddress and it is configured with correct User</li> <li>• SIP URI</li> <li>• with correct phone number</li> <li>• msRTCSIP-OptionFlags</li> <li>• msRTCSIP-Line</li> <li>• msRTCSIP-LineServer</li> </ul>

If some of those properties are not presented, or configured with old values, then the GC server is not replicated. The user must wait for the next automatic replication or run the replication manually.

If you are unsure that the replication is complete, or that the properties msRTCSIPUserEnabled and/or msRTCSIP-OptionFlags are not presented, see Possible cause 2 and "[Solution 2: Access permissions for the AD object properties](#)" (page 221).

---

—End—

---

## Solution 2: Access permissions for the AD object properties

### Solution 2:

Check the access permissions for the AD object properties by following the steps in "[Accessing permissions for the AD object properties](#)" (page 222) .

---

### Accessing permissions for the AD object properties

---

Step	Action
1	Install the Operating System Support Tools on the server (usually the Tools setup is on the MS Windows 2003 Server setup disk).
2	Run the ADSIEdit tool (%ProgramFiles%\Support Tools\adsiedit.msc).
3	Navigate to the users object container or the specific user's object.
4	Right-click the item and open <b>Properties</b> .
5	Go to the <b>Security</b> tab and click the <b>Advanced</b> button.
6	Search for the permission entry specific for the msRTCSIP properties group or RTCPropetySet. If there is a specific user group that has access rights to that property group, then the best solution is to add the MCM service account to this user group. Otherwise, you have to allow MCM Service account to read the properties <b>msRTCSIP-UserEnabled</b> , <b>msRTCSIP-PrimaryUserAddress</b> , <b>msRTCSIPOptionFlags</b> , <b>msRTCSIP-Line</b> , and <b>msRTCSIP-LineServer</b> .
7	Click <b>Add</b> .
8	Choose the <b>MCM service account</b> and click <b>OK</b> .
9	Go to the <b>Properties</b> tab.
10	Select <b>User objects</b> in the field <b>Apply onto</b> .
11	In the <b>Permissions</b> list box select the Allow check boxes across the Read permission of necessary properties and RTCPropetySet.
12	Click <b>OK</b> .

---

—End—

---

### Solution 3: Enable propagation of the AD to the Global Catalog

Enable propagation of the Active Directory field to the Global Catalog. Be sure to specify a Domain Controller LDAP server (port 389) to reduce the search scope to only one domain. Follow the procedure in "[Enabling propagation of the Active Directory field to the Global Catalog](#)" (page 223).

## Enabling propagation of the Active Directory field to the Global Catalog

Step	Action
1	Open the Active Directory Schema snap-in.
2	Select the Attributes folder on the left pane.
3	Find and the right-click the necessary field ( <b>otherTelephone</b> ).
4	Click the <b>Property</b> menu item.
5	Enable <b>Replicate this attribute to the Global Catalog</b> .
6	Click <b>OK</b> .

---

—End—

## OC client not registered

The following is a list of areas to troubleshoot when only one client is unable to register:

- Check to ensure that all clients are registered.
- Look in the client options for Active Directory for a mistake in SIP URI or Line URI.
- For RCC enabled user, ensure that the T87A class of service is configured for this client and a session is established.
- Remove RCC to see if VOIP functionality is present.

The following is a list of areas to troubleshoot when all clients are unable to register:

- Ensure all component configuration information is correct on the Front End server, Mediation Server, MCM, Signaling Server, SPS, Call Server, and DNS.
- Capture logs starting with the client logs. SIP messages between the Mediation Server and the Front End server cannot be seen as this is a secure leg.

## Pop-up not displayed

### Problem:

Pop-up not displayed.

### Symptom:

When a Office Communicator user receives a call, the called telephone rings, but no pop-up appears for the user to click on to answer the call.

**Possible causes:**

The Phone Context may be not correct. Address Book Service may not be properly setup. Phone integration is not activated.

**Solutions:**

- Ensure that the user's name is in Active Directory, the MCM, and the Signaling Server (L1 parameter) have the correct Phone Context.
- Ensure Address Book Service properly setup for an OC client is essential in receiving correct CLID info on call pop-ups
- Ensure PBX Integration is marked for an OC client in Active Directory and Server URI line is filled with valid info
- Ensure User has activated Phone integration on OC client
- Ensure PCA is configured properly for the called user.

## Two pop-ups are displayed

**Problem:**

Two toasts appear.

**Symptom:**

In some transfer and conference scenarios, the user receives two toasts instead of a merged one. One is with CLID information of the transferring telephone and the other is with CLID information of the original caller.

**Solution:**

The Route List Data Block must have the prompt DORG configured to No. The default value for DORG is No. For more information, see Route list data block.

## Delay for a SIP Gateway call

**Problem:**

Delay for a SIP Gateway call.

**Symptom:**

Office Communicator users observe a delay at the beginning of a call.

**Possible cause:**

Missing Office Communicator patch.

**Solution:**

Ensure that the Office Communicator patch is up-to-date.

## Call Forward is cancelled by Office Communicator

**Problem:**

Office Communicator cancels the Call Forward configured on the telephone.



**Symptom:**

The telephone is on Call Forward to another number. When the Office Communicator user who is associated to this telephone logs in (this telephone is controlled by the Office Communicator user through SIP CTI), the Office Communicator cancels the Call Forward.

**Possible cause:**

This is a Microsoft issue that Nortel has escalated to Microsoft.

**Solution:**

No solution yet.

## Office Communicator disconnecting from the network

**Problem:**

Office Communicator user cannot control the telephone after having been disconnected several times.

**Symptom:**

Customers using smart telephones or Mobile Communicators cannot take control of the telephone after having been disconnected abruptly three or more times. This disconnection could be due to your network (for example, GPRS or WLAN).

**Possible cause:**

This problem occurs because the SIP CTI link is disconnected abnormally and the Association is out of service for 30 minutes (1800 seconds). This timer is hard-coded by Office Communicator and cannot be changed.

**Solution:**

Increase the **Maximum Associations per DN** on the Signaling Server through Element Manager. This field is configured to 3 by default. Increase this parameter to allow more network disconnections.

## Capturing traces and logs

Use the following procedures to capture traces and logs to assist in troubleshooting Converged Office problems. When a problem is encountered, traces and logs can be activated on different components.

- Communication Server 1000 traces
- MCM logs
- OCS logs
- OC logs

### Communication Server 1000 traces

Use the following procedures for capturing traces.

**AML traces on the Call Server (SIP CTI only)**

In LD 48, activate AML traces on the Call Server (SIP CTI only):

**Table 41**  
**LD 48**

Prompt	Response	Description
EDD000	enl msgi 32	Enable incoming AML traces for ELAN 32
EDD000	enl msgo 32	Enable outgoing AML traces for ELAN 32

**Screen output:**

```
ELAN32 I MTYP=3B IACR TN=0 TIME=18:07:34
ELAN32 IN B1B1BE7A OUT B1B1BE7C QSIZE 00000000
ELAN32 03 20 00 00 00 00 1E 3B 00 0B 00 00 95 01 05 36 02 72 14 E6
ELAN32 0C BF EE 01 FF FF FF 00 00 0F FF 00 00
```

```
ELAN32 O MTYP=3C IACS TN=0 TIME=18:07:34
ELAN32 IN B1B1BE8B OUT 00000000 QSIZE 00000000
ELAN32 03 27 00 00 00 00 1E 3C 00 0B 00 00 95 01 05 36 02 72 14 E6
ELAN32 0C BF EE 01 FF FF FF 00 00 0F FF 00 00 37 02 98 C2 AA 01 00
```

```
ELAN32 I MTYP=1D SETFTR TN=0 TIME=18:07:34
ELAN32 IN B1B1C6E8 OUT B1B1C6EA QSIZE 00000000
ELAN32 03 16 00 00 00 00 16 1D 00 0B 00 00 46 01 08 36 02 72 14 3F
ELAN32 02 00 00
```

```
ELAN32 O MTYP=1D SETFTR TN=0 TIME=18:07:34
ELAN32 IN B1B1C6EE OUT 00000000 QSIZE 00000000
ELAN32 03 1D 00 00 00 00 16 1D 00 0B 00 00 3F 02 98 C2 46 01 08 36
ELAN32 02 72 14 71 01 01 78 02 20 0E
```

**SIP CTI traces on the Signaling Server**

In PDT, activate **SIP CTI** traces on the Signaling Server.

**Table 42**  
**SIP CTI trace in PDT**

Prompt	Response	Description
pdT	SIPCTITrace on	activate SIP CTI trace
pdT	SIPCTITraceLevel 1	

**Figure 85**  
**Example of screen output for SIP CTI Traces on the Signaling Server**

```

===== PUTTY log 2008.01.23 22:37:58
=====
[SIPCTITrace:] (23/01/08 23:39:39) <?xml version="1.0" encoding="UTF-8" ?>
[SIPCTITrace:] (23/01/08 23:39:39) <deliveredEvent xmlns="http://www.ecma-international.org/standards/ecma-323/csta/ed3">
[SIPCTITrace:] (23/01/08 23:39:39) <monitorCrossRefID>37</monitorCrossRefID>
[SIPCTITrace:] (23/01/08 23:39:39) <connection><callID>19797</callID><deviceID>tel:+16139675000;ext=3050</deviceID></connection>
[SIPCTITrace:] (23/01/08 23:39:39) <alertingDevice><deviceIdentifier>tel:+16139675000;ext=3050</deviceIdentifier></alertingDevice>
[SIPCTITrace:] (23/01/08 23:39:39) <callingDevice><deviceIdentifier>tel:2014;phone-context=cdp.udp</deviceIdentifier></callingDevice>
[SIPCTITrace:] (23/01/08 23:39:39) <calledDevice><deviceIdentifier>tel:+16139675000;ext=3050</deviceIdentifier></calledDevice>
[SIPCTITrace:] (23/01/08 23:39:39) <lastRedirectionDevice><notRequired/></lastRedirectionDevice>
[SIPCTITrace:] (23/01/08 23:39:39) <localConnectionInfo>alerting</localConnectionInfo><cause>normal</cause></deliveredEvent>
[SIPCTITrace:] (23/01/08 23:39:46) <?xml version="1.0" encoding="UTF-8" ?>
[SIPCTITrace:] (23/01/08 23:39:46) <ConnectionClearedEvent xmlns="http://www.ecma-international.org/standards/ecma-323/csta/ed3">
[SIPCTITrace:] (23/01/08 23:39:46) <monitorCrossRefID>37</monitorCrossRefID>
[SIPCTITrace:] (23/01/08 23:39:46) <droppedConnection><callID>19797</callID><deviceID>tel:+16139675000;ext=3050</deviceID></droppedConnection>
[SIPCTITrace:] (23/01/08 23:39:46) <releasingDevice><deviceIdentifier>tel:+16139675000;ext=3050</deviceIdentifier></releasingDevice>
[SIPCTITrace:] (23/01/08 23:39:46) <localConnectionInfo>null</localConnectionInfo><cause>normal</cause></ConnectionClearedEvent>

```

**SIP Gateway traces on the Signaling Server**

In PDT, activate **Gateway** traces on the Signaling Server.

**Table 43**  
**SIP Gateway trace in PDT**

Prompt	Response	Description
pdT	SIPCallTrace on	
pdT	SIPTraceLevel 1	

**Figure 86**  
**Example of screen output for SIP Gateway trace**

```

===== PUTTY log 2008.01.23 22:45:59
=====
24/01/2008 03:41:16 LOG0006 SIPNPM: ->Content-Type:
application/sdp;charset=utf-8
24/01/2008 03:41:16 LOG0006 SIPNPM: ->Content-Length: 299
24/01/2008 03:41:16 LOG0006 SIPNPM: ->
24/01/2008 03:41:16 LOG0006 SIPNPM: ->v=0
24/01/2008 03:41:16 LOG0006 SIPNPM: ->o=- 0 0 IN IP4 47.11.56.52
24/01/2008 03:41:16 LOG0006 SIPNPM: ->s=session
24/01/2008 03:41:16 LOG0006 SIPNPM: ->c=IN IP4 47.11.56.52
24/01/2008 03:41:16 LOG0006 SIPNPM: ->b=CT:1000
24/01/2008 03:41:16 LOG0006 SIPNPM: ->t=0 0
24/01/2008 03:41:16 LOG0006 SIPNPM: ->m=audio 60094 RTP/AVP 97 101 0 8
24/01/2008 03:41:16 LOG0006 SIPNPM: ->c=IN IP4 47.11.56.52
24/01/2008 03:41:16 LOG0006 SIPNPM: ->a=rtcp:60095
24/01/2008 03:41:16 LOG0006 SIPNPM: ->a=label:Audio
24/01/2008 03:41:16 LOG0006 SIPNPM: ->a=rtpmap:97 RED/8000
24/01/2008 03:41:16 LOG0006 SIPNPM: ->a=rtpmap:101 telephone-event/8000
24/01/2008 03:41:16 LOG0006 SIPNPM: ->a=fmtp:101 0-16
24/01/2008 03:41:16 LOG0006 SIPNPM: ->a=rtpmap:0 PCMU/8000
24/01/2008 03:41:16 LOG0006 SIPNPM: ->a=rtpmap:8 PCMA/8000
24/01/2008 03:41:16 LOG0006 SIPNPM: ->aptime:20
24/01/2008 03:41:16 LOG0006 SIPNPM: ->
24/01/2008 03:41:16 LOG0006 SIPNPM: This message is OUTGOING ---
24/01/2008 03:41:16 LOG0006 SIPNPM: ->SIP/2.0 100 Trying
24/01/2008 03:41:16 LOG0006 SIPNPM: ->From: <sip:2014;phone-
context=cdp.udp@ocs2007a-
med.ocs2007a.corp.nortel.com;user=phone>;tag=c0d6342d
24/01/2008 03:41:16 LOG0006 SIPNPM: ->>ec;epid=93883CDE01
24/01/2008 03:41:16 LOG0006 SIPNPM: ->To: <sip:3050;phone-
context=cdp.udp@47.11.56.54;user=phone>
24/01/2008 03:41:16 LOG0006 SIPNPM: ->Call-ID: 178c6ba6-817e-4415-8619
-555b6699d90b
24/01/2008 03:41:16 LOG0006 SIPNPM: ->CSeq: 260 INVITE
24/01/2008 03:41:16 LOG0006 SIPNPM: ->via: SIP/2.0/TCP
47.11.56.25:5060;branch=z9hg4bk6374d2a8716e971b8129ba3b.6
24/01/2008 03:41:16 LOG0006 SIPNPM: ->via: SIP/2.0/TCP
47.11.56.54:1904;received=47.11.56.54;branch=z9hg4bkD4DB5B54.5F8572DF;b
ranched=TRUE
24/01/2008 03:41:16 LOG0006 SIPNPM: ->via: SIP/2.0/TCP
47.11.56.52:2778;branch=z9hg4bk7f583134;ms-received-port=2778;ms-
received-cid=2FD00
24/01/2008 03:41:16 LOG0006 SIPNPM: ->Supported: 100rel,x-nortel-
sipvc,replaces,timer
24/01/2008 03:41:16 LOG0006 SIPNPM: ->User-Agent: Nortel CS1000 SIP Gw
release_5.0 version_sse-5.00.31
24/01/2008 03:41:16 LOG0006 SIPNPM: ->Contact:
<sip:3050@ocs2007a.corp.nortel.com;user=phone;x-nt-net-feature=x-nt-
home>
24/01/2008 03:41:16 LOG0006 SIPNPM: ->Allow:
INVITE, ACK, BYE, REGISTER, REFER, NOTIFY, CANCEL, PRACK, OPTIONS, INFO, SUBSCRIB
E, UPDATE
24/01/2008 03:41:16 LOG0006 SIPNPM: ->Content-Length: 0

```

## MCM logs

MCM 3.0 generates a daily log file with no maximum size restrictions and no cleanup procedures are implemented. The contents of the existing log file remain in all cases.

SNMP is not supported on the MCM 3.0 application. Alarms are logged to an MCM log file in addition to the Windows 2003 Event Viewer.

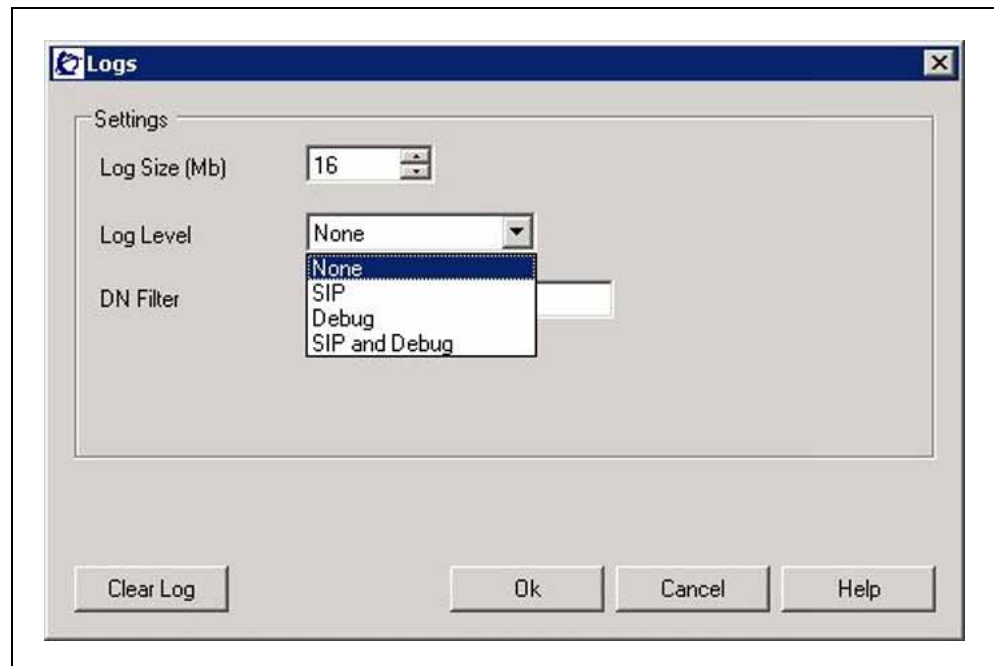
MCM 3.0 logging has the following levels:

- **None:** No messages or alarms are logged to the file. (Alarms are still logged to Windows Event Viewer).

- **SIP:** SIP messages (filtered by distinct DN) are logged further to alarms. Only one DN can be specified at the same time in MCM.
- **Debug:** Debug information is logged to the MCM log file.
- **SIP and Debug**

To clear a log, click on the **Clear Log** button. The backup file is stored as MCMlog.bak. See [Figure 87 "MCM logs" \(page 229\)](#) for an example of the Logs window.

**Figure 87**  
**MCM logs**



### Activating MCM logging

The following section details how to turn on MCM logging. MCM Logs can be enabled from MCM Console. Log files are stored in MCM.log file which is located in the MCM application installation directory (?:\Program Files\Nortel\MCM\MCM.log).

Step	Action
------	--------

- |   |  |
|---|--|
| 1 | On the MCM console interface, to activate MCM logs, select <b>Tools</b> and then choose <b>Logs</b> from the menu. |
| 2 | Go to <b>Log Level</b> and choose <b>Debug</b> .   |

—End—

To turn off MCM logging, see ["Resetting MCM debug trace"](#) (page 231).

### **MCM log file output**

The following shows a snippet from the log output file:

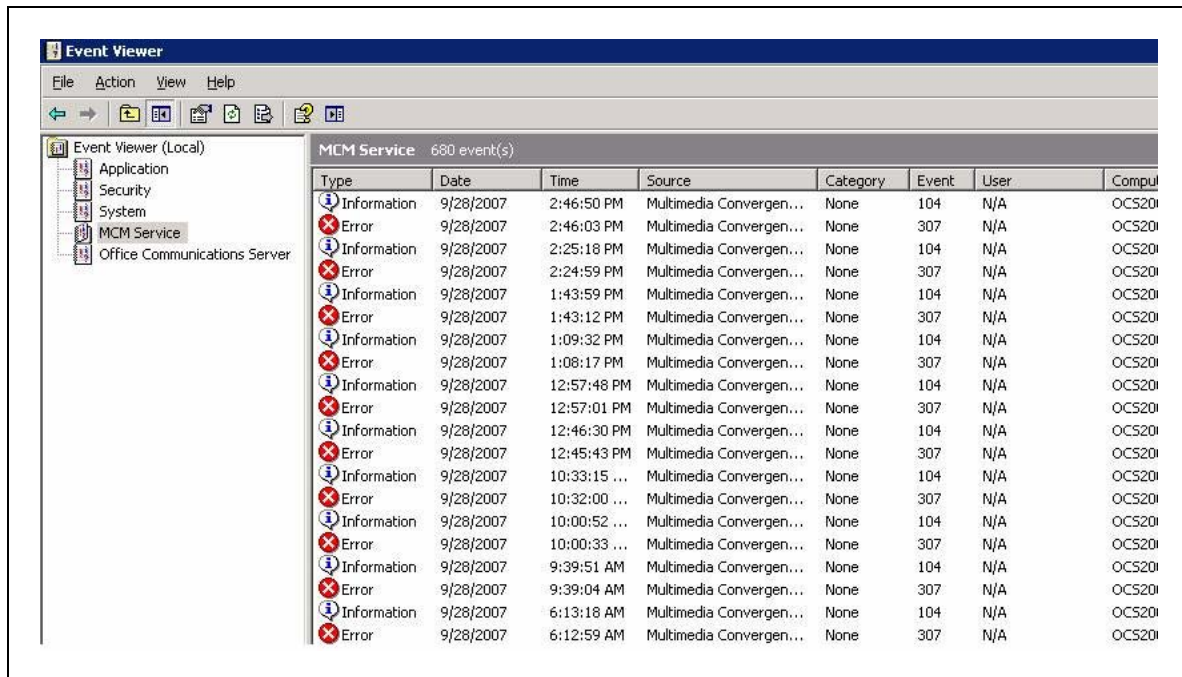
```
12/14/2007 11:11:37 AM: 3.0.1.76: Debug: OnCustomCom-
mand: got command:
update config data
12/14/2007 11:11:38 AM: 3.0.1.76: Debug: Configura-
tionData:
ReadConfigFile: Invalid secondary NRS address:
0.0.0.0
12/14/2007 11:11:38 AM: 3.0.1.76: Debug: Configura-
tionData:
ReadConfigFile: Invalid LDAP server IP address:
0.0.0.0
12/14/2007 11:11:38 AM: 3.0.1.76: Debug: ServerEven-
tHandler: got Event #2
12/14/2007 11:11:38 AM: 3.0.1.76: SIP and Debug:
NRSPolling:
sendPolling: request sent to the Primary NRS
12/14/2007 11:11:38 AM: 3.0.1.76: Debug: AD Cache:
turning off
12/14/2007 11:11:38 AM: 3.0.1.76: Debug: AD Cache:
it has been turned off
12/14/2007 11:11:38 AM: 3.0.1.76: Debug: ServerEven-
tHandler: got Event #3
12/14/2007 11:11:38 AM: 3.0.1.76: SIP and Debug:
NRSPolling: pollingResponseHandler
SIP/2.0 200
via: SIP/2.0/TCP 47.11.56.54:4616;branch=z9hG4bK-
422726df-8d69b1-2ac0;received=47.11.56.54
from: <sip:MCM@ocs2007a.corp.nortel.com>;tag=a7fdb8be-
c10b-44ef-9bf8-b9f6233cecb5
to: <sip:MCM@ocs2007a.corp.nortel.com>;tag=18892
call-id: 0000000-00000000-0000-00000000-000002-0000
cseq: 6 REGISTER
contact: < sip:MCM@ocs2007a.corp.nortel.com:5060>;ex-
pires=300;maddr=47.11.56.54;Transport=TCP
expires: 300
content-length: 0
```

### **MCM Event log**

MCM Exceptions and failures are reported in System Event Log. The following shows an example event log:

---

**Figure 88**  
Event Viewer window



### Resetting MCM debug trace

Use the following procedures to reset the MCM debug trace.

#### Resetting MCM debug trace

Step	Action
------	--------

- |   |  |
|---|--|
| 1 | On the MCM interface, select <b>Tools</b> and then choose <b>Logs</b> from the menu. |
| 2 | Go to <b>Log Level</b> and choose <b>None</b> .                                      |
| 3 | Delete the MCM.log file from the directory where MCM is installed.                   |

—End—

### OCS logs

Use the following procedures to activate an OCS log.

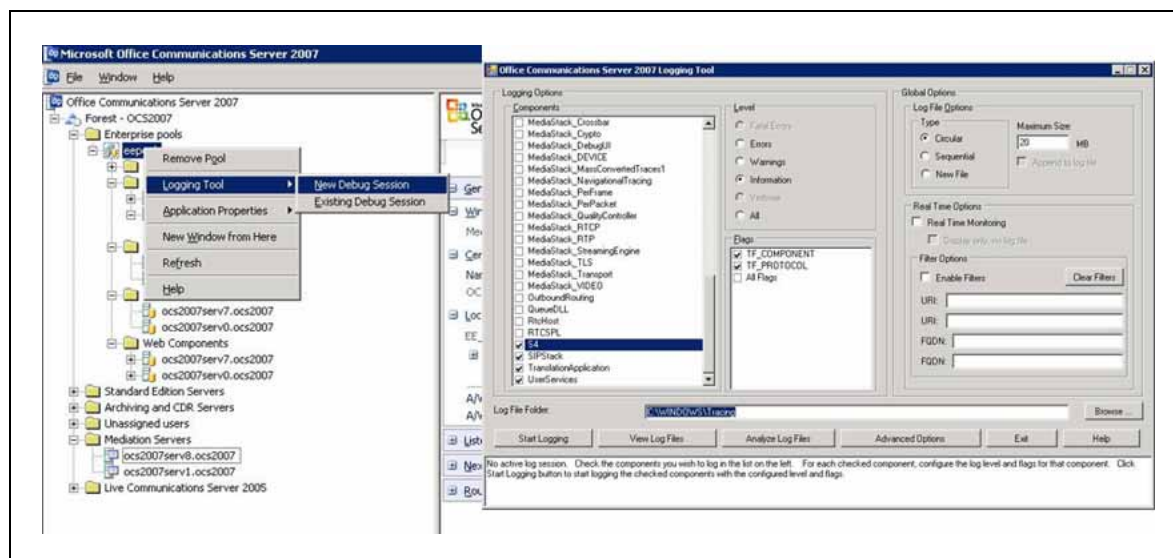
## Activating OCS logs

Step	Action
------	--------

- |   |  |
|---|--|
| 1 | Right-click on the OCS pool and select <b>Logging Tool</b> and then choose <b>New Debug Session</b> .  |
| 2 | In the OCS 2007 Logging Tool window, specify the Components to trace, Severity level, and other log file options. See example <a href="#">Figure 89 "OCS debugging tool"</a> (page 232). |
| 3 | Click the <b>Start Logging</b> button.   |
| 4 | To view the log file, click the <b>Analyze Log Files</b> button. The log file is stored as a .txt file in c:\WINDOWS\Tracing folder.   |

—End—

**Figure 89**  
OCS debugging tool



## OC logs

The following procedures describe how to enable logs for OC client. The tracing log folder is stored in the user's Documents and Settings sub folder with the .uccplog extension.

## Enabling OC logs

Step	Action
------	--------

- |   |   |
|---|---|
| 1 | From the OC client, select the <b>Options</b> menu. |
|---|---|



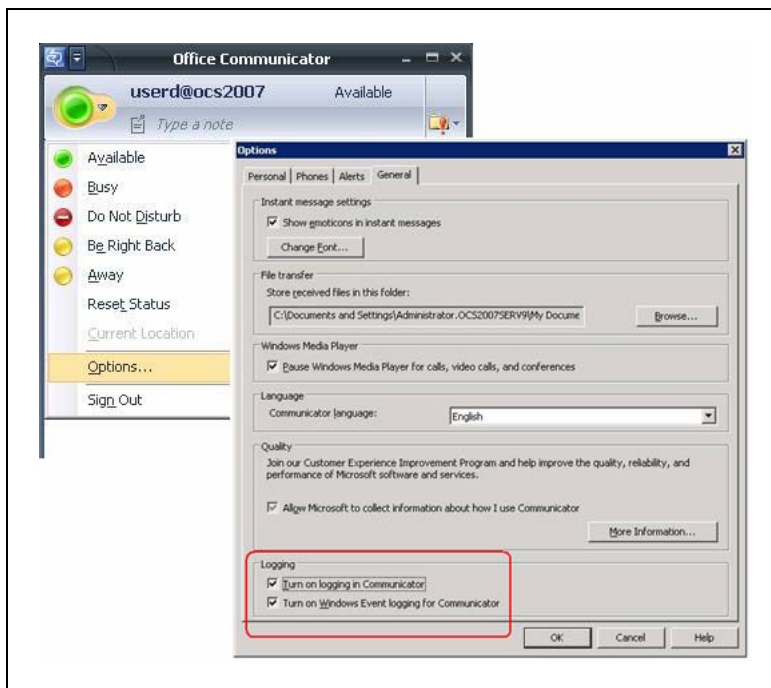
- 2 Choose the **General** tab.
- 3 Select the **Turn on logging in Communicator** and the **Turn on Windows Event Logging for Communicator** checkboxes. See [Figure 90 "Turn on Logging and Windows Event Logging"](#) (page 233).
- 4 Click OK.

---

—End—

---

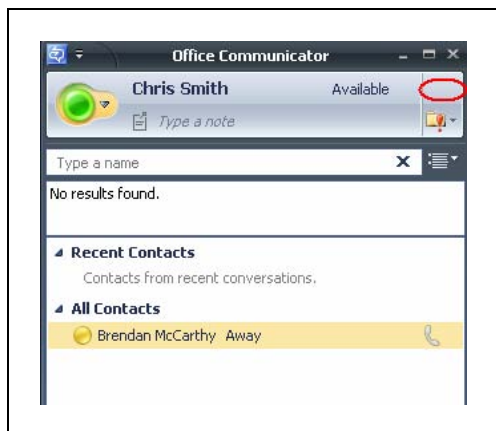
**Figure 90**  
**Turn on Logging and Windows Event Logging**



### OC client start-up debugging

To determine if there is a PBX connection, a handset icon will be present in the upper right of the OC client window. The example in [Figure 91 "No PBX connection for OC client"](#) (page 234) shows an OC client window where the handset icon is not present. For more information on troubleshooting an OC client registration, see ["OC client not registered"](#) (page 223).

**Figure 91**  
**No PBX connection for OC client**



## Case checklists

Use the following checklists prior to opening a case to ensure that all relevant information is collected:

**Table 44**  
**Signaling Server information**

	Check
The patches list installed on the Signaling Server: pdt>mdp issp	
The configuration on the Signaling Server: <ul style="list-style-type: none"> <li>pdt&gt;cd /u/config</li> <li>pdt&gt;copy config.ini</li> </ul>	
Are you connected to the Signaling Server with Telnet and under pdt? <ul style="list-style-type: none"> <li>pdt&gt;SIPCTIShow</li> </ul>	

**Table 45**  
**Call Server information**

	Check
Provide the patches list installed on the Call Server <ul style="list-style-type: none"> <li>LD 22</li> <li>issp</li> </ul>	
Capture the print out for the user DN in LD 11	
Capture the print out for the TN configured for this DN (do both for all TNs, including the PCA )	
Capture the DSC configuration for the PCA (configured for the Hot P 1)	

	Check
In LD 48, perform the command stat elan	
Provide the print out for the SIP Route and all related RLI/DMI	

**Table 46**  
**NRS configuration information**

	Check
NRS configuration	
Print capture of the Signaling Server endpoint configuration	
Print capture of the MCM endpoint configuration	
Print capture of the Routing Entries for the MCM endpoint	

**Table 47**  
**MCM configuration information**

	Check
Send the MCM.ini file	

**Table 48**  
**OCS configuration information**

	Check
The FQDN name of the Proxy server and the IP address	
The FQDN name of the Pool and the IP name	
The VIP of the Load Balancer	
On the Proxy Server capture Routing and for each route, Edit it and capture the screen	
On the Pool, capture <b>Routing</b> for each route, Edit it and get a screen capture	
On the Proxy Server, get a screen capture of <b>Host Authorization</b>	
On the Pool, get a screen capture of <b>Host Authorization</b>	
Front End server Properties, General tab, Mutual TLS/TLS row, Edit	
Front End server Properties, Security tab	
OCS Proxy Properties, General tab, Mutual TLS/TLS row, Edit	
OCS Proxy Properties, Security tab	

**Table 49**  
**Active Directory configuration information**

	Check
Print Capture of the OCS user for the General Tab	

	Check
Print Capture of the OCS user for the Office Communications Server	
Print Capture of the OCS user for the Office Communication, Advanced Settings	

**Table 50**  
**Tracing information**

	Check
An example AML trace on the Call Server (if it is a problem regarding the RCC feature not able to control the telephone)	
An example Signaling Server trace: SIPCallTrace (For problem related to SIP Gateway)	
An example Signaling Server trace: SIPCallTrace (For problem related to SIP Gateway)	
An example Signaling Server trace: SIPCTITrace (For problem related to SIP CTI)	
An example MCM.log with the log level = SIP + Debug for the failed call scenario (to reset the trace: put the trace level to none, delete the MCM.log file and put back the level to Debug)	

---

# Appendix A

## Call Flow and protocol details

---

### Contents

This section contains information about the following topics:

"Overview" (page 237)

"Message sequence" (page 238)

"Call flow" (page 239)

### Overview

The Converged Office feature provides interworking between Nortel and Microsoft products. It addresses the market need of our customers who want to use Microsoft client software for their multimedia needs while continuing to use the Business Grade Telephony of the Nortel IP PBX.

The software component introduced to implement this functionality is the TR/87 Front End application that resides on the Signaling Server.

The same TR/87 FE that supports the Office Communicator client also serves as a core component of the SIP Contact Center architecture.

From the perspective of the TR/87 FE, all client types are transparent, whether Office Communicator, a TR/87 session initiated by the Contact Center Manager server (CCMS), or some other SIP UA.

Within the scope of Communication Server 1000 TR/87 supported services and events noted in this document, all operations performed on the telephone are directly reflected in the client and vice versa. Similarly, all phone restrictions applicable to a physical TN also apply to the soft client that is issuing commands on behalf of a controlled DN.

## Message sequence

TR/87(4) is an ECMA Technical Report that describes the use of SIP as a transport of service requests and events defined by the ECMA-269(5) specification as XML bodies within SIP messages. The ECMA-323(6) specification defines the XML format of ECMA-269 services and events.

The Front End (FE) application conforms to the minimum subset of the TR/87 specification defined for Office Communications Server 2007 interworking and those components necessary to support the next generation SIP Contact Center requirements.

Figure 92 "Message sequence diagram - CSTA Session Establishment and Monitor Start" (page 238) shows the expected message flow for establishing and monitoring a CSTA session as defined by TR/87.

**Figure 92**  
**Message sequence diagram - CSTA Session Establishment and Monitor Start**

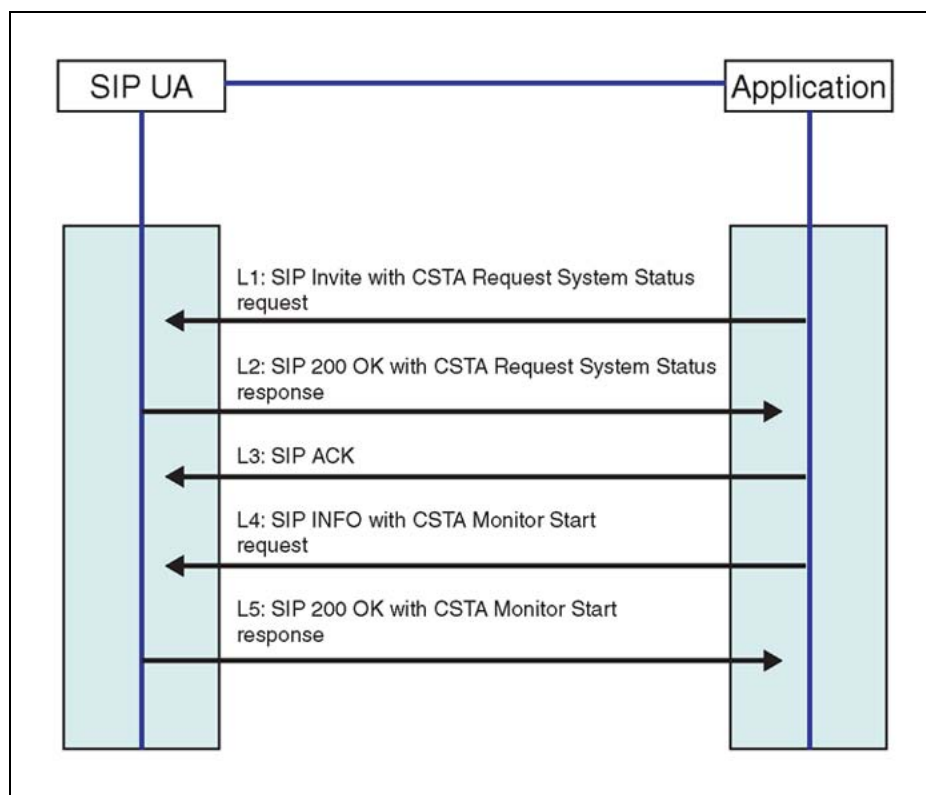


Figure 93 "SIP INFO message with ECMA-323 content" (page 239) is an example of a SIP INFO message with ECMA-323 content.

**Figure 93**  
**SIP INFO message with ECMA-323 content**

```

INFO fe1_cs1000@lcs2005s.corp.nortel.com
Via: SIP/2.0/TCP 157.56.66.156:16714
Max-Forwards: 70
From:<sip:alice@microsoft.com>;tag=0d9280080ada4a1ea504f7d78d434336;epid=5fc88
0096d
To:<sip:fe1_cs1000@lcs2005s.corp.nortel.com>;tag=3f181801fc9d4fab27ef7d8
9bd28f9f
Call-ID: fdbcb6a6184a4e92a5f001865f84a2c6@157.56.66.156
CSeq: 2 INFO
Contact: <sip:alice@microsoft.com:16714
Contact:<sip:alice@microsoft.com:9609;maddr=47.130.16.136;transport=tcp>;proxy
=replace
User-Agent: RTC/1.2
Content-Type: application/csta+xml
Content-Disposition: signal; handling=required
Content-Length: 189
<?xml version="1.0" encoding="UTF-8"?>
<MakeCall
xmlns="http://www.ecma-international.org/standards/ecma-323/csta/ed3.">
<callingDevice>tel:+14257777777</callingDevice>
<calledDirectoryNumber>tel:65000;phone
context=microsoft.com</calledDirectoryNumber>
</MakeCall>

```

## Call flow

This section illustrates the call flow sequence for the Telephony Gateway and Services and Remote Call Control with Mediation Server present.

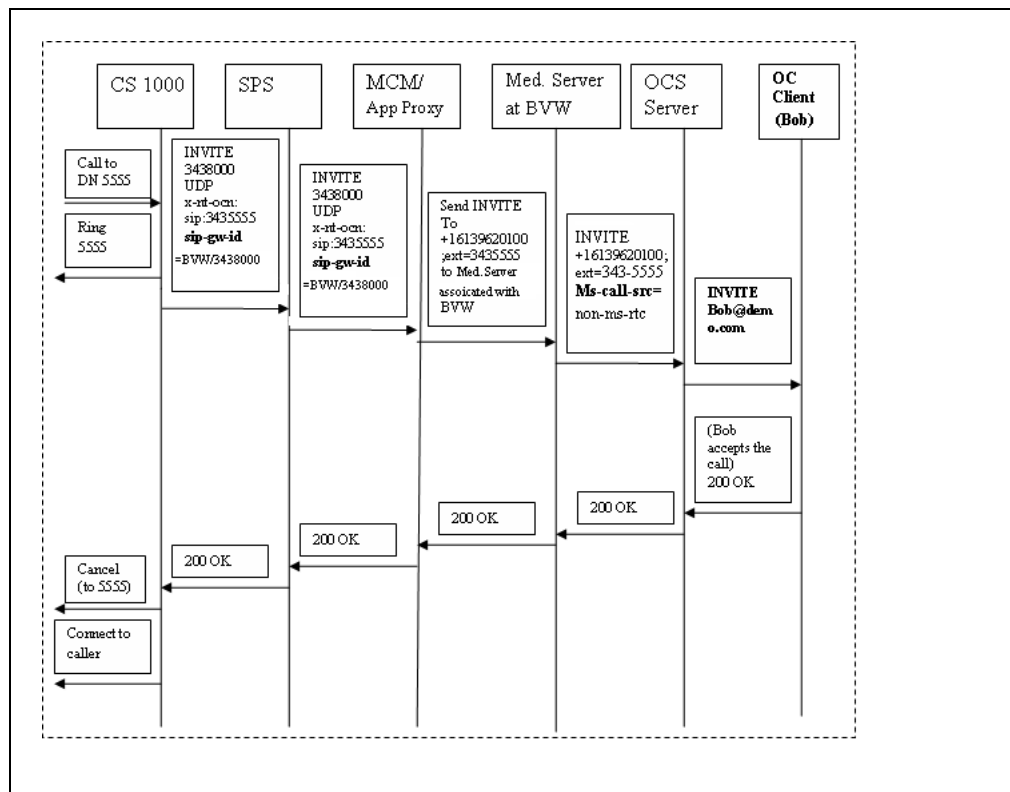
### Telephony Gateway and Services call flow

This section explores dual forking call flows in different scenarios when Mediation Server is present.

This scenario as illustrated in [Figure 94 "Inbound call to OC client with SPS, OC client answers"](#) (page 240) depicts a configuration of a UDP dialing plan on the Communication Server 1000 and the presence of an SPS component on the network. A Communication Server 1000 user dials 5555 which is the phone belonging to user Bob in the demo.com domain. Bob accepts the call from his OC client.

**Note:** This scenario would also apply if the inbound call originated from the PSTN.

**Figure 94**  
**Inbound call to OC client with SPS, OC client answers**



Incoming calls to OC 2007 can originate directly from a phone behind the Communication Server 1000 where the request URI represents the destination.

Incoming calls can also come from a PCA, where the Request URI is a service DN used to route the call to OCS 2007, and the actual destination is determined by a special header (x-nt-ocn) that contains the destination DN. MCM checks for the x-nt-ocn and routes the call accordingly.

Personal Call Assistant (PCA) configuration provides additional Office Communicator features such as forwarding to voice mail, and so on. Configuration of PCA is performed through station administration tools.

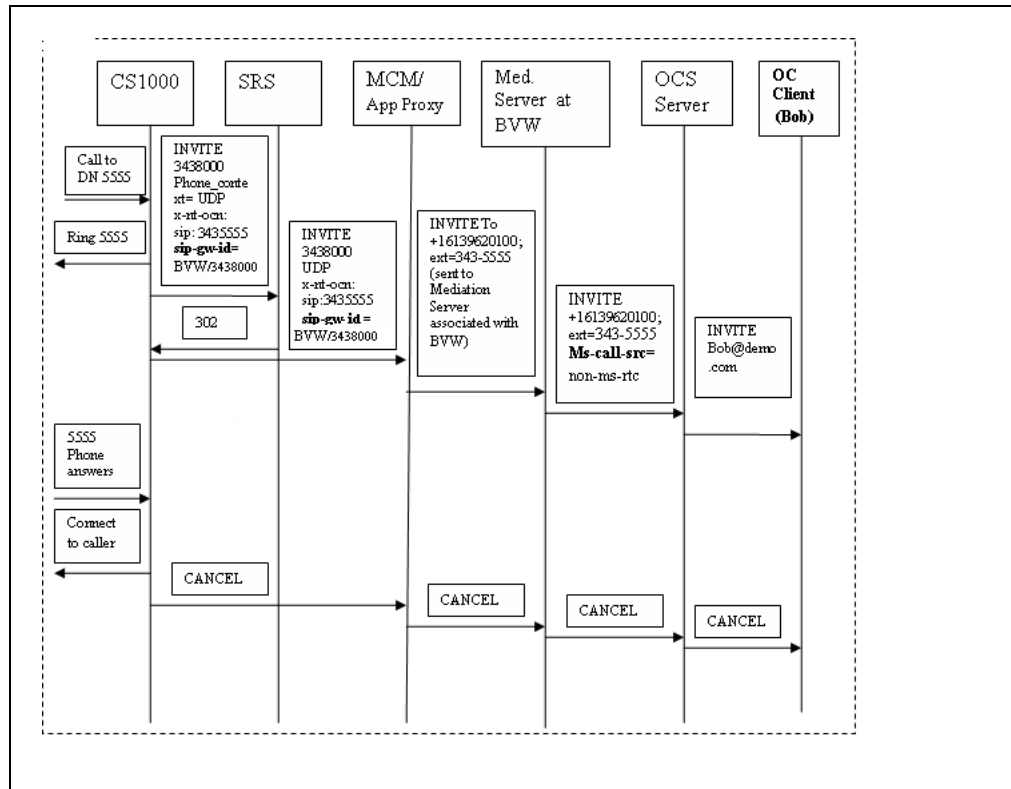
This scenario as illustrated in [Figure 95 "Inbound call to OC client with SRS, phone answers"](#) (page 241) depicts the presence of an SRS component on the network (instead of SPS).

For example, A Communication Server 1000 user dials 5555 which is the phone belonging to user Bob in the demo.com domain. Bob accepts the call from his phone (instead of the OC client).



**ATTENTION**  
 This scenario would also apply if the inbound call originated from the PSTN.

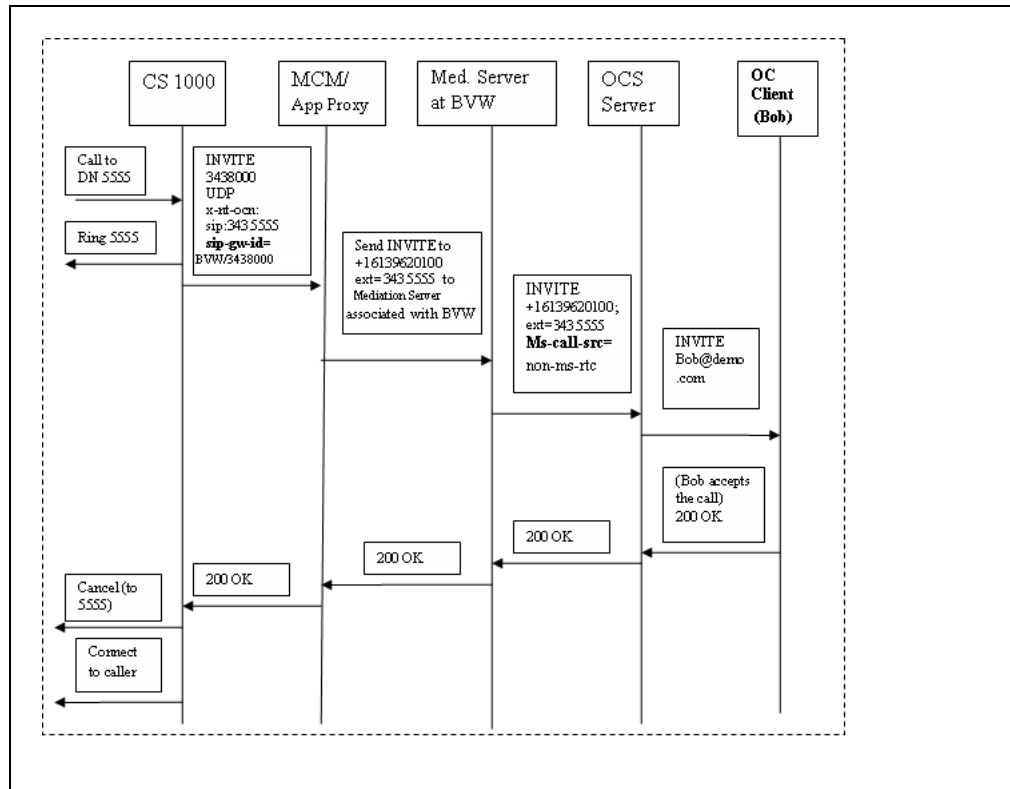
**Figure 95**  
**Inbound call to OC client with SRS, phone answers**



The next scenario as illustrated in [Figure 96 "Direct inbound call to OC client, OC client answers"](#) (page 242) depicts a limited deployment configuration where the MCM is pointing directly to the Communication Server 1000. The deployment of SPS or SRS are not present. A Communication Server 1000 user dials 5555 which is the phone belonging to user Bob in the demo.com domain. Bob accepts the call from his OC client.

**ATTENTION**  
 This scenario would also apply if the inbound call originated from the PSTN.

**Figure 96**  
**Direct inbound call to OC client, OC client answers**

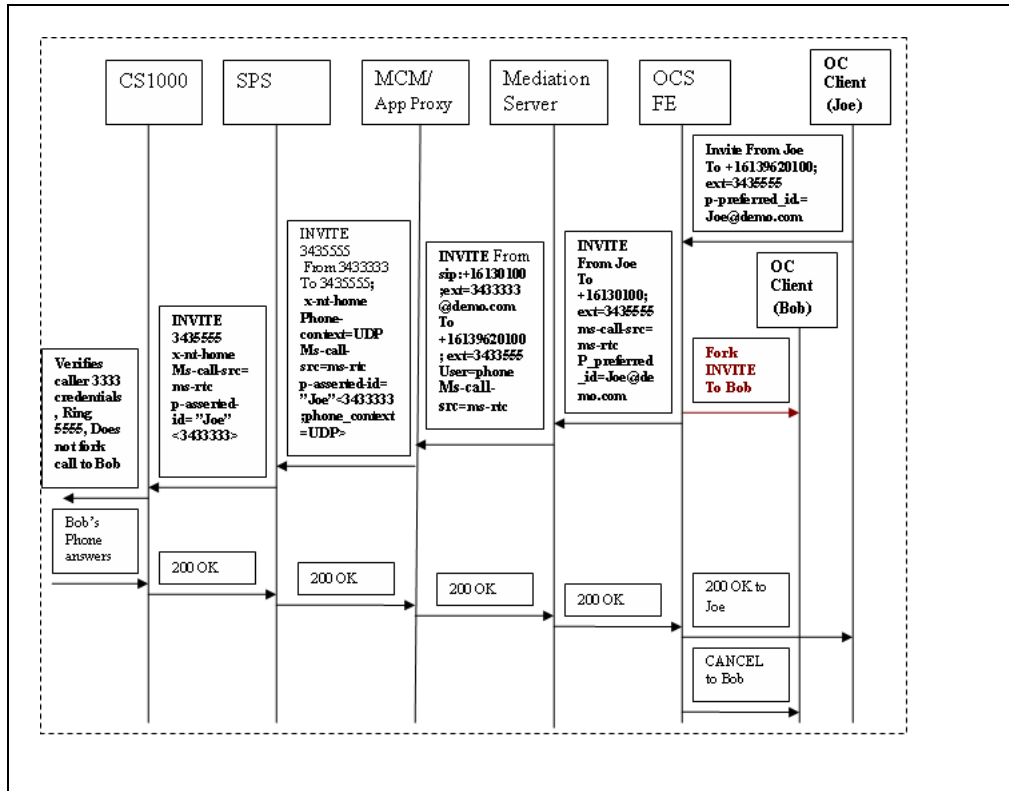


This scenario as illustrated in [Figure 97 "Outbound call from OC client to another client, phone answers"](#) (page 243) depicts the prevention of dual forking in a configuration where both users are registered to the same Communication Server 1000 with the presence of SPS. Joe calls Bob from his OC client. Bob accepts the call from his phone.

### ATTENTION

In this call flow scenario, homing operation is performed on the Communication Server 1000 to validate the caller's (Joe) permissions before proceeding with the call.

**Figure 97**  
**Outbound call from OC client to another client, phone answers**

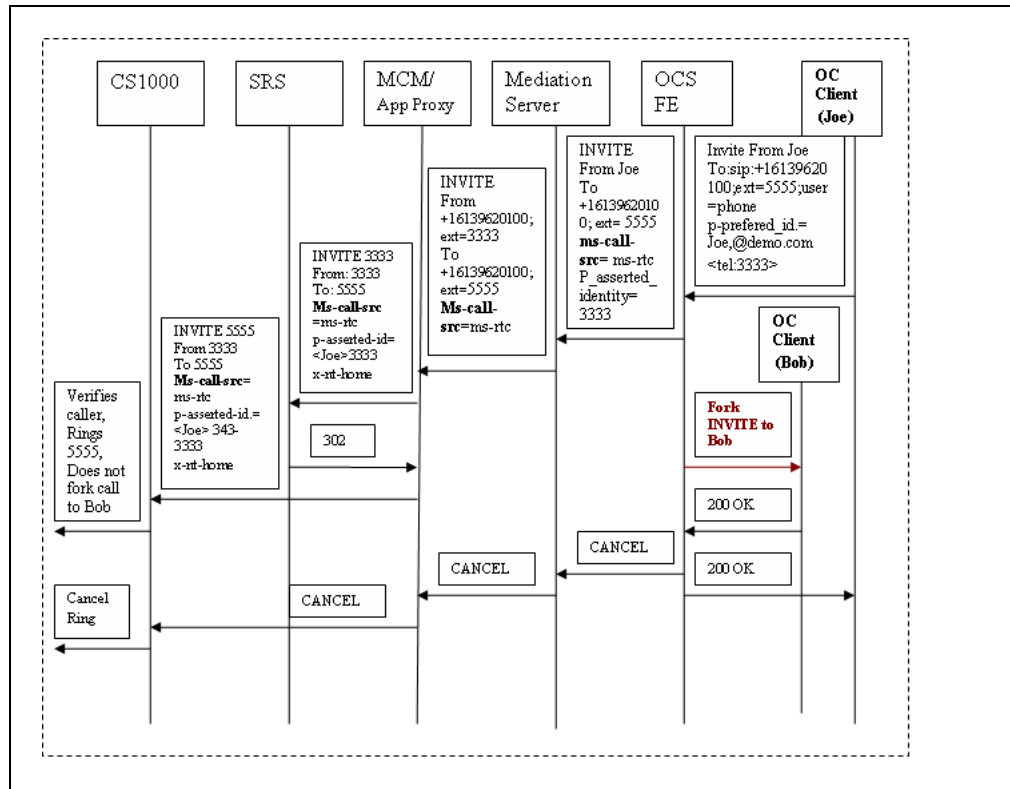


This scenario as illustrated in Figure 98 "Outbound call from OC client to another OC client, OC client answers" (page 244) depicts a configuration with a CDP dialing plan and the presence of the SRS component on the network. Joe calls Bob from his OC client. Bob accepts the call from his OC client.

**ATTENTION**

For the CDP dialing plan to work, the entire network must be configured with CDP. Therefore, it can only be deployed on small networks.

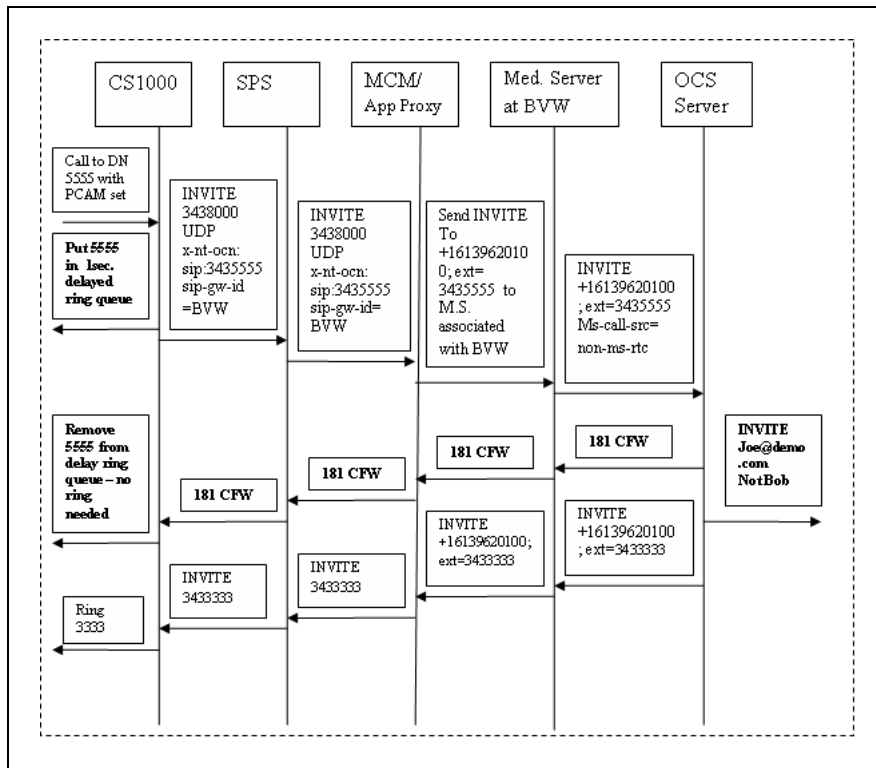
**Figure 98**  
**Outbound call from OC client to another OC client, OC client answers**



### Call Forward by OC client

This scenario depicts a situation where the Communication Server 1000 phone dials the phone number of an OC client Bob and is forwarded to another client Joe. Bob's twin phone number is x5555 and Joe's number is X3333.

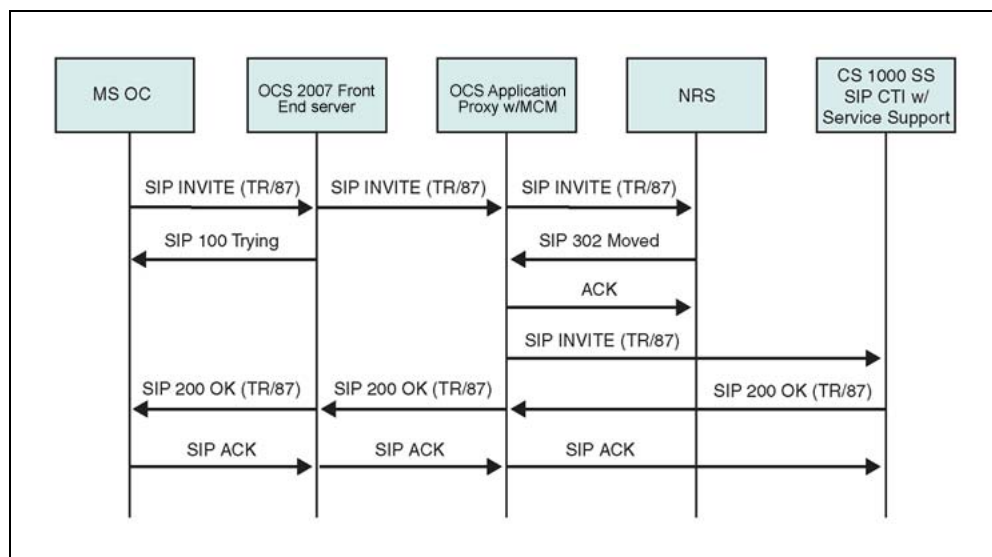
**Figure 99**  
**Call Forward call flow by OC client**



**Remote Call Control Call Flow**

Figure 100 "Remote Call Control Session Establishment through SRS" (page 246) illustrates the Remote Call Control Session Establishment through SRS.

**Figure 100**  
**Remote Call Control Session Establishment through SRS**



## Supported features

**Table 51**  
**SIP CTI supported features**

Feature	Supported by CS 1000 TR/87 FE	Supported by Office Communicator 2007
<b>Call Control Events</b>		
17.2.3 - Conference	X	X
17.2.4 - Connection Cleared	X	X
17.2.5 - Delivered	X	X
17.2.7 - Diverted	X	X
17.2.8 - Established	X	X
17.2.9 - Failed	X	X
17.2.10 - Held	X	X
17.2.14 - Originated	X	X
17.2.16 - Retrieved	X	X
17.2.18 - Transferred	X	X
<b>Call Associated Services</b>		
18.1.4 - Generate Digits	X	X

Feature	Supported by CS 1000 TR/87 FE	Supported by Office Communicator 2007
<b>Call Associated Events</b>		
18.2.5 - Service Completion Failure	X	X
<b>Logical Device Features</b>		
22.1.9 - Get Do Not Disturb	X (Release 5.0)	
22.1.10 - Get Forwarding	X	X
22.1.17 - Set Do Not Disturb		
22.1.18 - Set Forwarding	X	X
<b>Logical Device Feature Event</b>		
22.2.12 - Do Not Disturb	X	
22.2.13 - Forwarding	X	X
<b>Capability Exchange Services</b>		
13.1.1 - Get CSTA Features	X	X
<b>System Services</b>		
14.2.1 - Request System Status	X	X
<b>Monitoring Services</b>		
15.1.2 - Monitor Start	X	X
15.1.3 - Monitor Stop	X	X
<b>Call Control Services</b>		
17.1.2 - Alternate Call		X
17.1.3 - Answer Call	X	X
17.1.8 - Clear Connection	X	X
17.1.9 - Conference Call	X	
17.1.10 - Consultation Call	X	X
17.1.11 - Deflect Call	X	X

<b>Feature</b>	<b>Supported by CS 1000 TR/87 FE</b>	<b>Supported by Office Communicator 2007</b>
17.1.15 - Hold Call	X	X
17.1.18 - Make Call	X	X
17.1.21 - Reconnect Call		X
17.1.22 - Retrieve Call	X	X
17.1.25 - Single Step Transfer Call	X	X
17.1.26 - Transfer Call	X	X



---

# Appendix B

## Configuration Examples

---

### Contents

- "Introduction" (page 249)
- "Standard Edition" (page 249)
- "Enterprise Edition" (page 275)
- "Host Authorization" (page 283)
- "Routing" (page 284)
- "Configuring DNS" (page 286)
- "Active Directory configuration" (page 288)
- "Installing and configuring MCM" (page 289)
- "Signaling Server checklist" (page 292)
- "Configuring NRS" (page 293)

### Introduction

As described in the Planning and Engineering chapter, small, medium, and large networks require different editions of Office Communications Server (OCS) 2007. This appendix contains configuration examples for both Standard Edition and Enterprise Editions of OCS 2007.

### Standard Edition

This section provides information on how to configure and troubleshoot the Converged Office solution running the Standard Edition OCS 2007. This sample configuration is for a small network deployment.

## Setting up the lab

Follow these steps to ensure the lab is set up correctly:

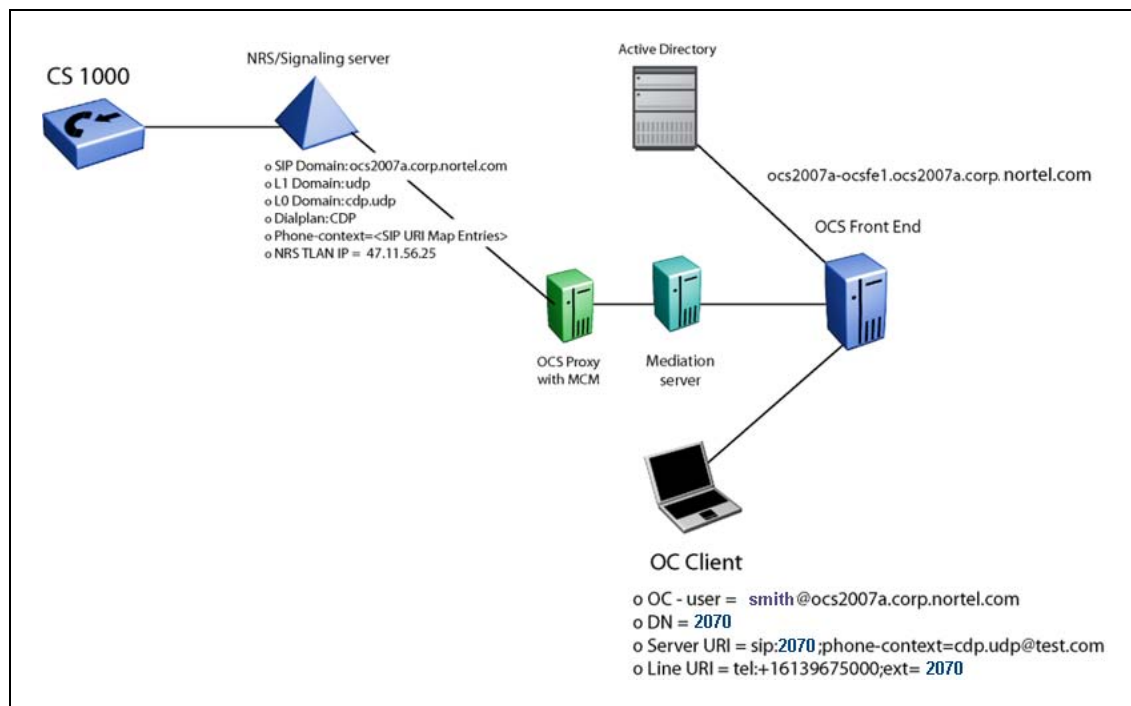
### Setting up the lab

Step	Action
1	Confirm that the CS 1000 server is version 5.0 with the Product Enhancement Package or a later version.
2	Confirm that the Signaling Server is version 5.0 or later with all patches as required in the Product Bulletin
3	Confirm that you have the OCS 2007 Standard Edition server .
4	Confirm that you have MCM 3.0 .

—End—

Figure 101 "Overview of lab setup" (page 250) illustrates how to set up a lab for Converged Office.

**Figure 101**  
Overview of lab setup



### Collecting required data

Collect the required data listed in the following three tables before you begin to configure the Converged Office solution. The information entered here can be used to verify configuration settings later on.

**Table 52**  
**Microsoft Active Directory**

Required information	Record your information	For example
User SIP URI		chris@ocs2007a.corp.nortel.com
Server URI		sip:2070;phone-context=cdp.udp@test.com
Line URI		tel:+16139675000;ext=2070

**Table 53**  
**Network Routing Service (NRS)**

Required information	Record your information	For example
IP-address Primary SPS		47.11.56.25
IP-address Secondary SPS		Not used
Node IP-address		47.11.56.24
MCM endpoint name		mcm@ocs2007a.corp.nortel.com
Communication Server 1000 SIP gateway endpoint name		ocs2007_node_A
Routing Entry for PCA		CDP: 888-MCM CDP: 20 and 21 > OCS2007_node A
Service domain		ocs2007a.corp.nortel.com
Level 1 domain		udp
Level 0 domain		cdp.udp

**Table 54**  
**Element Manager for Signaling Server**

Required information	Record your information	For example
Communication Server 1000 SIP gateway endpoint name		ocs2007_node_A
SIP Domain name		ocs2007a.corp.nortel.com
SIP URI map, Private/UDP domain name		udp

SIP URI map, Private/CDP domain name		cdp.udp
SIP CTI Service, Service enabled		Yes
SIP CTI Service, Customer Number		0
SIP CTI Service, International Calls As National		Yes
SIP CTI Service, National Prefix		0
SIP CTI Service, International Prefix		00
SIP CTI Service, Dialing Plan		cdp
SIP CTI Service, Calling Device URI Format		sip:2070;phone-context=cdp.udp@test.com
SIP CTI Service, Country Code		33
SIP CTI Service, National/Number of digits to strip		1

**Table 55**  
**MCM**

Required Information	Record your information	For example
Registration ID		mcm@ocs2007a.corp.nortel.com
Called Phone Context		cdp.udp

## Configuring the Call Server

Use the following procedure to check the configuration of the Call Server.

### Checking the Call Server configuration

Step	Action
1	Check the version of the Communication Server 1000 Call Server. The Communication Server 1000 Call Server version must be at least release 5.0 with the Product Enhancement Package (PEP).
2	Check the Product Bulletin and download the required patches for Converged Office.
3	In LD 22, confirm that <b>AST</b> , <b>PCA</b> , and <b>SIP CTI TR87</b> licenses are available.

**Table 56**  
**LD 22—check for licenses**

Prompt	Response	Description
REQ	prt	
TYPE	slt	

**Screen output:**

```

ANALOGUE TELEPHONES      32767      LEFT 32767      USED      0
CLASS TELEPHONES        32767      LEFT 32767      USED      0
DIGITAL TELEPHONES      32767      LEFT 32767      USED      0
DECT USERS              32767      LEFT 32767      USED      0
IP USERS                32767      LEFT 32756      USED     11
BASIC IP USERS          32767      LEFT 32767      USED      0
TEMPORARY IP USERS      32767      LEFT 32767      USED      0
DECT VISITOR USER      10000      LEFT 10000      USED      0
ACD AGENTS              32767      LEFT 32767      USED      0
MOBILE EXTENSIONS       32767      LEFT 32767      USED      0
TELEPHONY SERVICES     32767      LEFT 32761      USED      6
CONVERGED MOBILE USERS 32767      LEFT 32767      USED      0
NORTEL SIP LINES        32767      LEFT 32767      USED      0
THIRD PARTY SIP LINES   32767      LEFT 32767      USED      0
PCA 32767 LEFT 32762 USED 5
AST 32767 LEFT 32756 USED 11
ITG ISDN TRUNKS        32767      LEFT 32767      USED      0
H.323 ACCESS PORTS     32767      LEFT 32767      USED      0
AST                    32767      LEFT 32761      USED      6
SIP CONVERGED DESKTOPS 32767      LEFT 32767      USED      0
SIP CTI TR87           32767      LEFT 32760      USED      7
SIP ACCESS PORTS       32767      LEFT 32753      USED     14
RAN CON                 32767      LEFT 32767      USED      0
MUS CON                 32767      LEFT 32767      USED      0
TNS                    32767      LEFT 32639      USED    128
ACDN                   24000      LEFT 24000      USED      0
AML                    16         LEFT 14         USED      2
IDLE_SET_DISPLAY NORTEL
LTID                   32760      LEFT 32760      USED      0
RAN RTE                512        LEFT 512        USED      0
ATTENDANT CONSOLES     32767      LEFT 32767      USED      0
BRI DSL                10000      LEFT 10000      USED      0
MPH DSL                100        LEFT 100        USED      0
DATA PORTS             32767      LEFT 32767      USED      0
PHANTOM PORTS         32767      LEFT 32767      USED      0
TRADITIONAL TRUNKS     32767      LEFT 32767      USED      0
DCH                    255        LEFT 254        USED      1

```

- 4** Also in LD 22, confirm that the MS\_CONV package is present (this package is required).

**Table 57**  
**LD 22–MS\_CONV package**

Prompt	Response	Description
REQ	prt	
TYPE	pkg 408	

**Screen output:**

```
MS_CONV 408
```

- 5 Ensure that the VSID and the ELAN ID are **greater than or equal to 32** and that the SECU parameter is configured to **YES** for ELAN and for VAS configuration.

**Table 58**  
**LD 22–Check VSID and ELAN ID configuration**

Prompt	Response	Description
PT2000	<enter>	
REQ	prt	
TYPE	vas	
VSID	032	
DLOP	<enter>	

**Screen output:**

```
ELAN 032
SECU YES
INTL 0001
MCNT 9999
```

- 6 In LD 20, confirm that STRI/STRO is **WNK** for SIP Trunk configuration.

**ATTENTION**

The screen output shown here may differ, depending on the setup used.

**Table 59**  
**LD 20–SIP Trunk configuration**

Prompt	Response	Description
PT0000	<enter>	
REQ	prt	
TYPE	tnb	
TN	156 0 0 0	

Prompt	Response	Description
DATE	<enter>	
PAGE	<enter>	
DES	<enter>	

**Screen output:**

```

DES SIP
TN 156 0 00 00 VIRTUAL
TYPE IPTI
CDEN 8D
CUST 0
XTRK VTRK
ZONE 000
TRK ANLG
NCOS 0
RTMB 62 1
CHID 1
TGAR 0
STRI/STRO WNK WNK
SUPN YES
AST NO
IAPG 0
CLS UNR DTN WTA LPR APN THFD XREP P10 NTC
TKID
AACR NO
DATE 5 DEC 2006

```

- 7 In LD 21, check that NCNA and NCRD are configured to **YES** and that SIGO is **ESN5** in the SIP Route Configuration. For example:

**Table 60**  
**LD 21–SIP Route configuration**

Prompt	Response	Description
REQ	prt	
TYPE	rdb	
CUST	0	
ROUT	62	

**Screen output:**

```

TYPE RDB
CUST 00
ROUT 62
DES SIP
TKTP TIE
NPID_TBL_NUM 0

```

```

ESN NO
RPA NO
CNVT NO
SAT NO
RCLS EXT
VTRK YES
ZONE 000
PCID SIP
CRID YES
NODE 81
DTRK NO
ISDN YES
MODE ISLD
DCH 63
IFC SL1
PNI 00001
NCNA YES
NCRD YES
TRO YES
FALT NO
CTYP UKWN
INAC YES
ISAR NO
DAPC NO
PTYP ATT
...
DEXT NO
ANTK
SIGO ESN5
MFC NO
...

```

- 8 For TN configuration in LD 11, configure **AST, TR87A, PCAM, and CDMR Class of Service**. Configure **MARP** for the telephone.

**ATTENTION**  
The screen output shown here may differ depending on the setup used.

**Table 61**  
**LD 11–TN configuration**

Prompt	Response	Description
REQ	prt	
TYPE	dnb	
CUST	0	
DN	2070	
DATE	<enter>	



Prompt	Response	Description
PAGE	<enter>	
DES	<enter>	

**Screen output:**

```

DN 2070
CPND
CPND_LANG ROMAN
XPLN 16
DISPLAY_FMT FIRST, LAST
TYPE SL1
TN 100 0 03 04 V KEY 00 MARP DES
DLOCS2 3 DEC 2007
(2004P2)
TN 152 0 00 30 V KEY 00 DES PCA 12 JUL 2006
(PCA)
NACT

```

**Table 62**  
**LD 11**

Prompt	Response	Description
REQ	prt	
TYPE	tnb	
TN	152 0 0 14	
DATE	<enter>	
PAGE	<enter>	
DES	<enter>	

**Screen output:**

```

DES CDLCS
TN 152 0 00 14 VIRTUAL
TYPE I2004
CDEN 8D
CTYP XDLC
CUST 0
ZONE 000
FDN
TGAR 0
LDN NO
NCOS 0
SGRP 0
RNPG 0
SCI 0
SSU
LNRS 16

```

```

XLST 0
SCPW 2070
SFLT NO
CAC_MFC 0
CLS CTD FBD WTA LPR MTD FND HTD TDD HFD CRPD
MWD LMPN RMMD SMWD AAD IMD XHD IRD NID OLD VCE DRG1
POD DSX VMD CMSD SLKD CCSA-CSI SWD LNA CNDA
CFTD SFD MRD DDV CNID CDCA MSID DAPA BFED RCBD
ICDD CDMD LLCN MCTD CLBD AUTU
GPUD DPUD DNDA CFXD ARHD FITD CLTD ASCD
CPFA CPTA HSPD ABDD CFHD FICD NAID BUZZ
UDI RCC HBTD AHA IPND DDGA NAMA MIND PRSD NRWD NRCD
NROD
DRDD EXR0
USRD ULAD CCBD RTDD RBDD RBHD PGND OCBF FLXD FTTC
DNDY DNO3 MCBN
FSDS NOVD VOLA VOUD CDMR ICRD MCDD T87A KEM2
CPND_LANG ENG
BFTN 152 0 01 00
HUNT
PLEV 02
CSDN
AST 00
IAPG 0

```

- 9 Check LD 21 to confirm that PCA is activated. If not, configure LD 15 to PCA **ON** This allows the incoming call to twin the PCA and make the SIP Gateway call work. Use LD 11 to configure each user with PCA.

**Table 63**  
**LD 21—Confirm PCA is activated**

Prompt	Response	Description
REQ	prt	
TYPE	ft	
TYPE	FTR_DATA	
CUST	0	

**Table 64**  
**LD 21—Confirm PCA for SIP Gateway**

Prompt	Response	Description
REQ	prt	
TYPE	pca	
TN	96 0 8 15	

Prompt	Response	Description
DATE	<enter>	
PAGE	<enter>	
DES	<enter>	

The screen output shown here may differ depending on the setup used.

**Screen output:**

```

DES PCA
TN 096 0 08 15 VIRTUAL
TYPE PCA
CDEN 8D
CTYP XDLC
CUST 0
NUID
NHTN
CFG_ZONE 000
CUR_ZONE 000
NCOS 0
ERL 0
ECL 0
FDN
TGAR 1
LDN NO
NCOS 0
SGRP 0
RNPG 0
SCI 0
SSU
XLST
SFLT NO
CAC_CIS 0
CAC_MFC 0
CLS CTD FBD WTA LPR MTD FND HTD TDD HFD CRPD MWD LMPN
RMMD SMWD AAD IMD XHD IRD NID OLD VCE DRG1 POD DSX VMD
SLKD CCSD SWD LND CNDD CFTD SFD MRD DDV CNID CDCA MSID
DAPA BFED RCBD ICDD CDMD LLCN MCTD CLBD AUTU GPUD DPUD
DNDD CFXD ARHD CLTD ASCD CPFA CPTA ABDD CFHD FICD NAID
DNAA BUZZUDI RCC HBTD AHA IPND DDGA NAMA MIND PRSD
NRWD NRCD NROD UDI RCC HBTD AHA IPND DDGA NAMA MIND
PRSD NRWD NRCD NROD DRDD EXROUSMD USRD ULAD CCBP RTDD
RBDD RBHD PGND FLXD FTTC DNDY DNO3 MCB FDSD NOVD VOLA
VOUD CDMR ICRD MCDD T87D MSNV FRA PKCH PCAM
CPND_LANG ENG
HUNT
PLEV 02
DANI NO
AST

```

```
IAPG 0
AACS NO
AACS NO
ITNA NO
DGRP
MLWU_LANG 0
MLNG ENG
DNDR 0
KEY 00 SCR 2070 0
CPND
ANIE 0
01 HOT P 3 888
02
03
04
05
06
07
08
09
10
11
12
13
14
15
16
17 TRN
18 AO6
19 CFW 16
20 RGA
21 PRK
22 RNP
23
24 PRS
25 CHG
26 CPN
27
28
29
30
31
Date 16 APR 2008
```

**Screen output**

```
...
PCA ON
...
```

**Screen Output:**

```

....
TYPE UEXT
CDEN 8D
CTYP XDLC
CUST 0
UXTY TLSV
....
KEY 00 SCR 2070 0
01 HOT P 3 888

```

- 10 Confirm that AST is not configured.
- 11 Configure TR87D and CDMR Class Of Service.
- 12 Confirm that this PCA is not configured as MARP.
- 13 Configure Hot P for SIP Gateway calls.
- 14 Configure CLS PCAM.
- 15 Configure **DSC** for PCA. Create a DSC to route the call to the SIP route using the RL1.

**Table 65**  
**LD 87—Configure DSC for PCA**

Prompt	Response	Description
REQ	prt	
CUST	0	
FEAT	cdp	
TYPE	dsc	
DSC	8214	

### ATTENTION

The screen output shown here may differ depending on the setup used.

### Screen Output

```

FLEN 4
DSP LSC
RRPA NO
RLI 1
CCBA NO
NPA
NXX

```

- 16 Check LD 21 to confirm that PCA is activated. If not, configure LD 15 to PCA to **ON** to allow the incoming call to twin the PCA and make the SIP Gateway call work.

---

—End—

---

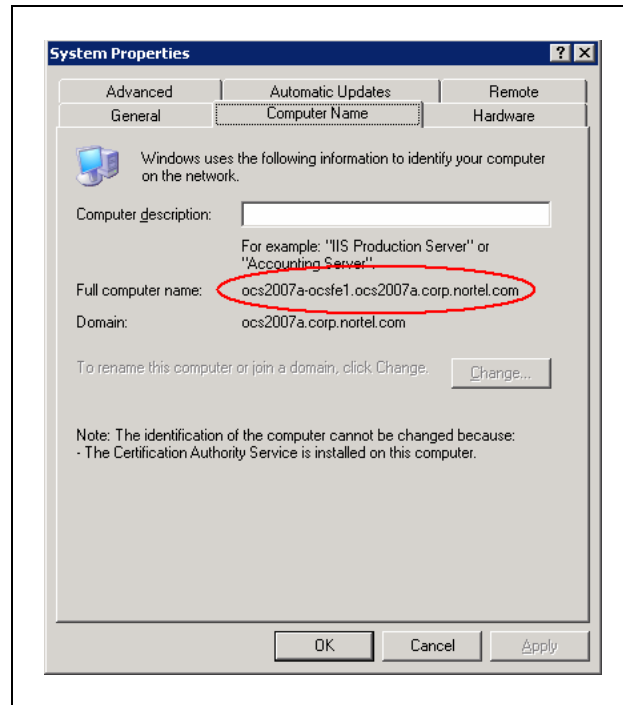
### Signaling Server checklist

Use the following procedure to confirm the correct configuration of the Signaling Server.

#### Checking the configuration of the Signaling Server

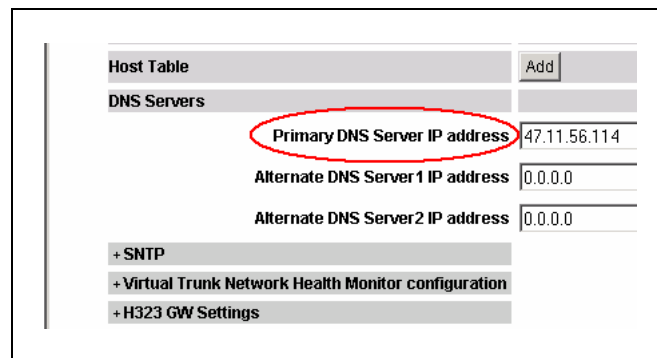
Step	Action
1	Confirm that the Signaling Server is version 5.0 or higher. Refer to the Product Bulletin for any required patches for Converged Office.
2	<p>Confirm that your installation meets the memory requirements.</p> <p>The maximum number of SIP CTI/TR87 users on a single Signaling Server is 5000. The Standard Signaling Server memory is 1 gigabyte (minimum requirement) and is required in the following scenarios:</p> <ol style="list-style-type: none"> <li>if SIP CTI/TR87 is co-resident with PD/RL/CL application</li> <li>if SIP CTI/TR87 is co-resident with H.323/SIP GW serving more than 200 ports, or co-resident with Terminal Proxy Server serving more than 1000 IP users</li> </ol>
3	Confirm the configuration of the Front End server and OCS Proxy server. Right-click on <b>My Computer</b> and choose the <b>Computer Name</b> tab. For more information, see <a href="#">Figure 102 "FQDN of the OCS 2007 Front End server"</a> (page 263).

**Figure 102**  
**FQDN of the OCS 2007 Front End server**



- 4 Define the IP address of the server acting as DNS. For example, in [Figure 103 "DNS configuration on the Signaling Server"](#) (page 263), the IP address is **47.11.56.114**.

**Figure 103**  
**DNS configuration on the Signaling Server**



- 5 Ensure that the SIP GW settings match the settings as shown in [Figure 104 "SIP GW Settings"](#) (page 264).

**Figure 104**  
**SIP GW Settings**

**NORTEL CS 1000 ELEMENT MANAGER**

**SIP GW Settings**

**TLS Security**

Security Policy: Security Disabled

TLS Security Port: 5061 (1 - 65535)

Client Authentication:

Re-negotiation:

X.509 Certificate Authentication:

**Primary Proxy or Re-direct Server**

Primary Proxy or Redirect (TLAN) IP address: 47.11.56.25

Port: 5060

Supports Registration:

Primary CDS Proxy or Re-direct server flag:

Transport Protocol: TCP

**Secondary Proxy or Re-direct Server**

Secondary Proxy or Redirect (TLAN) IP address: 0.0.0.0

Port: 5060

Supports Registration:

Secondary CDS Proxy or Re-direct server flag:

Transport Protocol: TCP

**CLID Parameters**

Country Code (CCC):

- 6 Confirm that the SIP URI Map settings match the settings as shown in Figure 105 "SIP URI Map" (page 265).

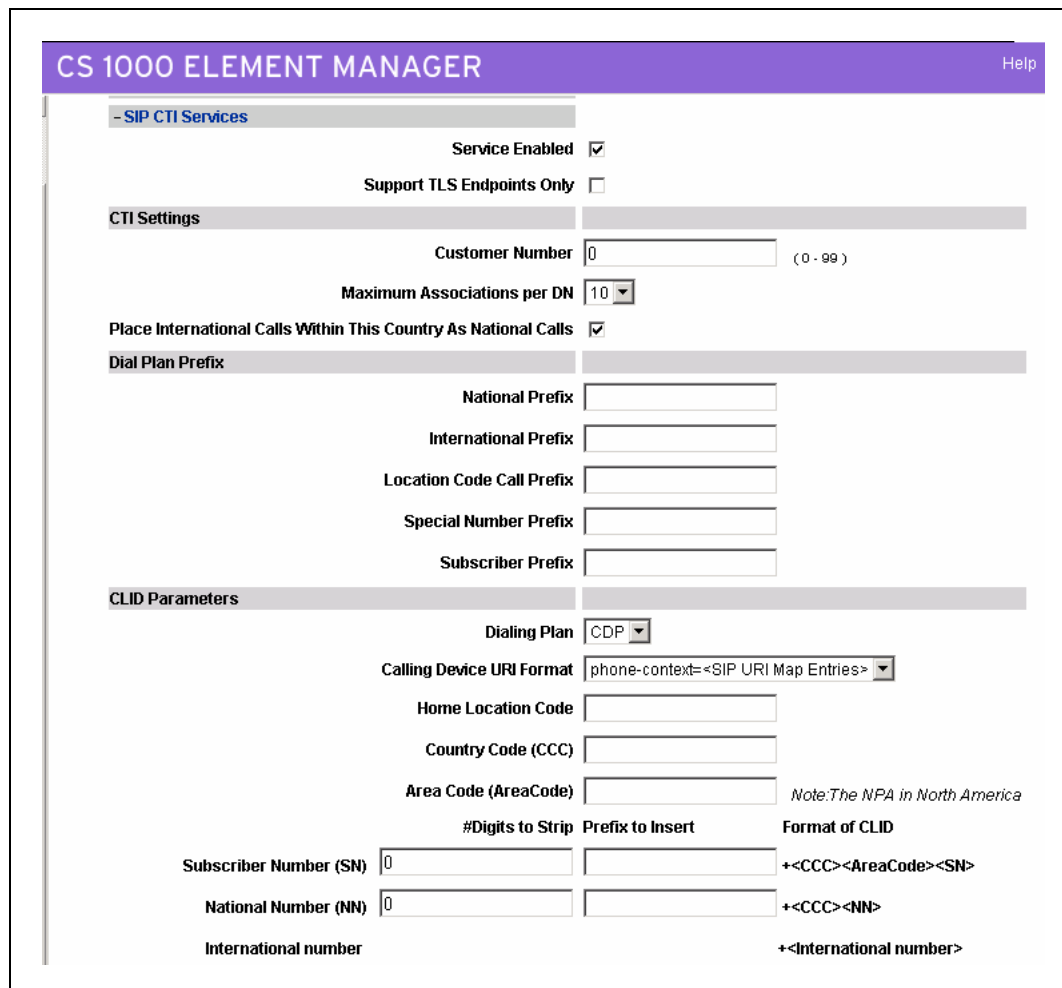


**Figure 105**  
**SIP URI Map**

CS 1000 ELEMENT MANAGER	
+ SIP CTI Settings	
SIP URI Map	
Public E.164/National domain name	+1
Public E.164/Subscriber domain name	+613
Public E.164/Unknown domain name	PublicUnknown
Public E.164/Special Number domain name	PublicSpecial
Private/UDP domain name	udp
Private/CDP domain name	cdp.udp
Private/Special Number domain name	PrivateSpecial
Private/Unknown (vacant number routing) domain name	PrivateUnknown
Unknown/Unknown domain name	UnknownUnknown
+ SIP CD Services	

- 7 Confirm that the SIP CTI Services settings match the settings as shown in [Figure 106 "SIP CTI Services"](#) (page 266).

**Figure 106**  
**SIP CTI Services**



**CS 1000 ELEMENT MANAGER** Help

**- SIP CTI Services**

Service Enabled

Support TLS Endpoints Only

**CTI Settings**

Customer Number  (0 - 99)

Maximum Associations per DN

Place International Calls Within This Country As National Calls

**Dial Plan Prefix**

National Prefix

International Prefix

Location Code Call Prefix

Special Number Prefix

Subscriber Prefix

**CLID Parameters**

Dialing Plan

Calling Device URI Format

Home Location Code

Country Code (CCC)

Area Code (AreaCode)  Note: The NPA in North America

	#Digits to Strip	Prefix to Insert	Format of CLID
Subscriber Number (SN)	<input type="text" value="0"/>	<input type="text"/>	+<CCC><AreaCode><SN>
National Number (NN)	<input type="text" value="0"/>	<input type="text"/>	+<CCC><NN>
International number			+<International number>

—End—

## Configuring Network Routing Service (NRS)

Use the following procedure to check the configuration of NRS.

### Checking NRS configuration

Step	Action
------	--------

- |   |   |
|---|---|
| 1 | Check the Signaling Server and MCM Endpoints Status as shown in <a href="#">Figure 107 "Signaling Server and MCM Endpoints status on NRS"</a> (page 267). |
|---|---|

**Figure 107**  
**Signaling Server and MCM Endpoints status on NRS**

The screenshot displays the 'NETWORK ROUTING SERVICE MANAGER' interface. At the top, it shows the managing database status as 'Active database' with IP '47.11.56.25'. Below this is a search section for endpoints, including a search box and filters for domains. The main content area shows a table of 'Gateway Endpoints (18)' and 'User Endpoints (0)'. The table is filtered by 'SIP phone context...'. The table columns are: ID, Supported Protocols, Call Signaling IP, Description, # of Routing Entries, and Context. The table lists five entries, with the first two being 'MCM' and 'MCM-Proxy2', both 'Dynamic SIP endpoint' and registered at IP 47.11.56.54 and 47.11.236.39 respectively. The last two are 'OCS2007NODEB' and 'OCS2007\_NODE\_A', both 'Dynamic SIP endpoint' and 'Not registered' at IP 47.11.56.88 and 47.11.56.24 respectively. The first entry has 1 routing entry, and the last two have 2 routing entries each.

<input type="checkbox"/>	ID	Supported Protocols	Call Signaling IP	Description	# of Routing Entries	Context
<input type="checkbox"/>	MCM	Dynamic SIP endpoint	47.11.56.54	MCM on OCS Proxy	1	ocs2007a.corp.nortel.com / udp / cdp
<input type="checkbox"/>	MCM-Proxy2	Dynamic SIP endpoint	47.11.236.39		1	ocs2007a.corp.nortel.com / udp / cdp
<input type="checkbox"/>	OCS2007NODEB	RAS H.323 endpoint / Dynamic SIP endpoint	Not registered / 47.11.56.88		1	ocs2007a.corp.nortel.com / udp / cdp
<input type="checkbox"/>	OCS2007_NODE_A	RAS H.323 endpoint / Dynamic SIP endpoint	Not registered / 47.11.56.24	OCS2007NODEA	2	ocs2007a.corp.nortel.com / udp / cdp
<input type="checkbox"/>	OCSProxy	Dynamic SIP endpoint	Not registered	OCS2007	2	lcs2005s.corp.nortel.com /

1 - 18 of 18 Gateway Endpoint(s) First | Previous | Next | Last

Ensure that all the endpoints are registered (the endpoints must be listed as "Dynamic Sip" under the Supported Protocols column and have an IP address under the Call Signaling IP column in Figure 107 "Signaling Server and MCM Endpoints status on NRS" (page 267).

- 2 Check the PCA Routing Entry as shown in Figure 108 "Routing Entry" (page 268) (refer to the information you recorded in Table 53 "Network Routing Service (NRS)" (page 251) ). To configure PCA for SIP Gateway, see step 9 in "Checking the Call Server configuration" (page 252).

**Figure 108**  
**Routing Entry**

NETWORK ROUTING SERVICE MANAGER
Help | Logout

**Managing:**  Active database 47.11.56.25  
 Standby database [Numbering Plan](#) » Routes

---

**Search for Routing Entries**

Enter a DnPrefix and Dn Type (use \* for all) and click Search. You may narrow the search by specifying a particular domain.

DN Prefix:  DN Type:

Limit results to Domain:  /  /

Endpoint Name:

Results per page:

**Routing Entries (25)    Default Routes (0)**

Routing test... Refresh

<input type="checkbox"/> DN Prefix ▲	DN Type	Route Cost	SIP URI Phone Context	Context
1 <input type="checkbox"/> 10	Private level 0 regional (CDP steering code)	1	cdp1.udp1	lcs2005s.corp.nortel.com / udp1 / cdp1 / node3228
2 <input type="checkbox"/> 11	Private level 0 regional (CDP steering code)	1	cdp1.udp1	lcs2005s.corp.nortel.com / udp1 / cdp1 / um_node134
3 <input type="checkbox"/> 2	Private level 0 regional (CDP steering code)	1	cdp1.udp1	lcs2005s.corp.nortel.com / udp1 / cdp1 / node1220
4 <input type="checkbox"/> 20	Private level 0 regional (CDP steering code)	1	cdp.udp	ocs2007a.corp.nortel.com / udp /

1 - 25 of 25 Routing Entry(ies) First | Previous | Next | Last

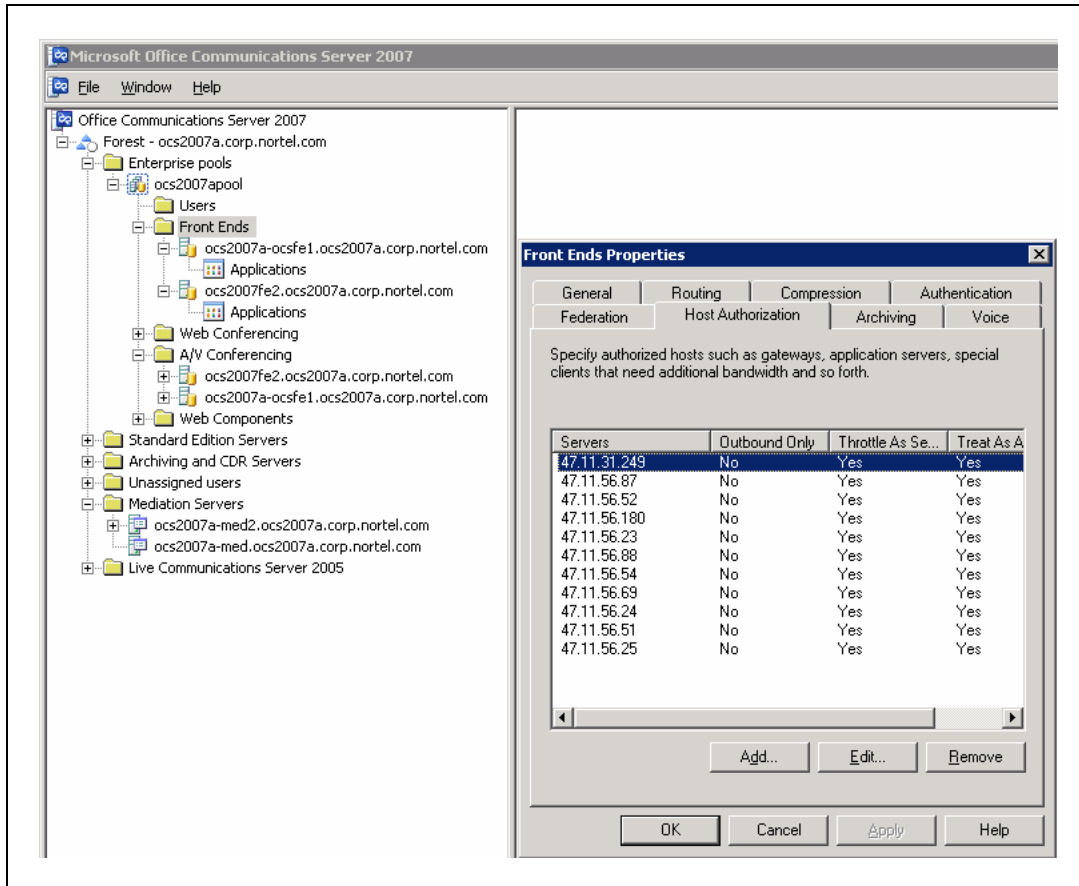
**3** Check the OCS 2007 Standard Edition configuration.

In Host Authorization for an OCS 2007 Standard Edition, configure the IP Address of the OCS Proxy server. (see [Figure 109 "Host Authorization"](#) (page 269)).

**ATTENTION**

Communication between MCM and the Communication Server 1000 is based on TCP. When using TCP, enter the IP address instead of FQDN.

**Figure 109**  
**Host Authorization**



- 4 Check the OCS Proxy server configuration. See [Table 53 "Network Routing Service \(NRS\)"](#) (page 251), the OCS Proxy IP is 47.11.56.54, and the Node IP is 47.11.56.24.

—End—

### Active Directory user configuration

Use the following procedure to check the Active Directory user configuration.

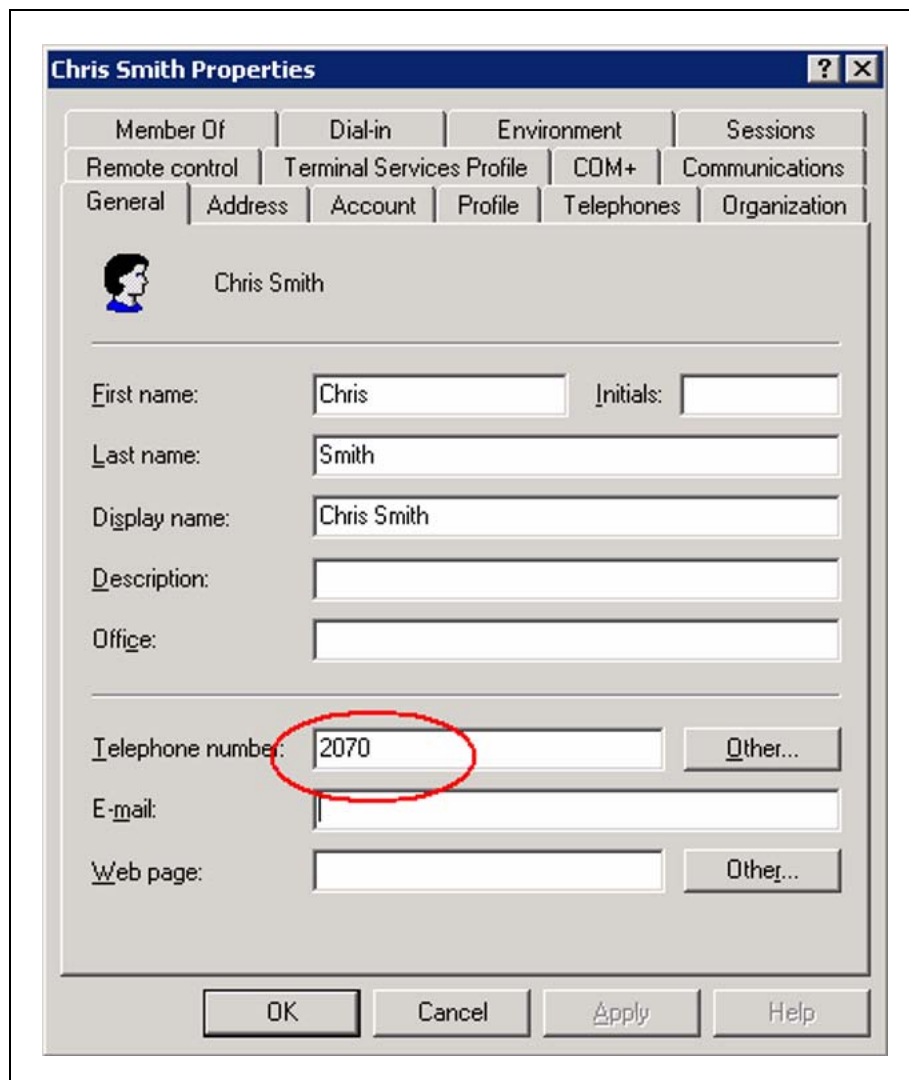
#### Checking the settings of Active Directory user configuration

Step	Action
------	--------

- 1 Check the user configuration by going to Active Directory, select the user and right-click on **User Properties**. Select the **General** tab. Complete the following actions:

- a. Compare and match your user properties settings with those in [Figure 110 "General user properties"](#) (page 270). The telephone number in the Telephone Number field must be the same as the information recorded in [Table 52 "Microsoft Active Directory"](#) (page 251).

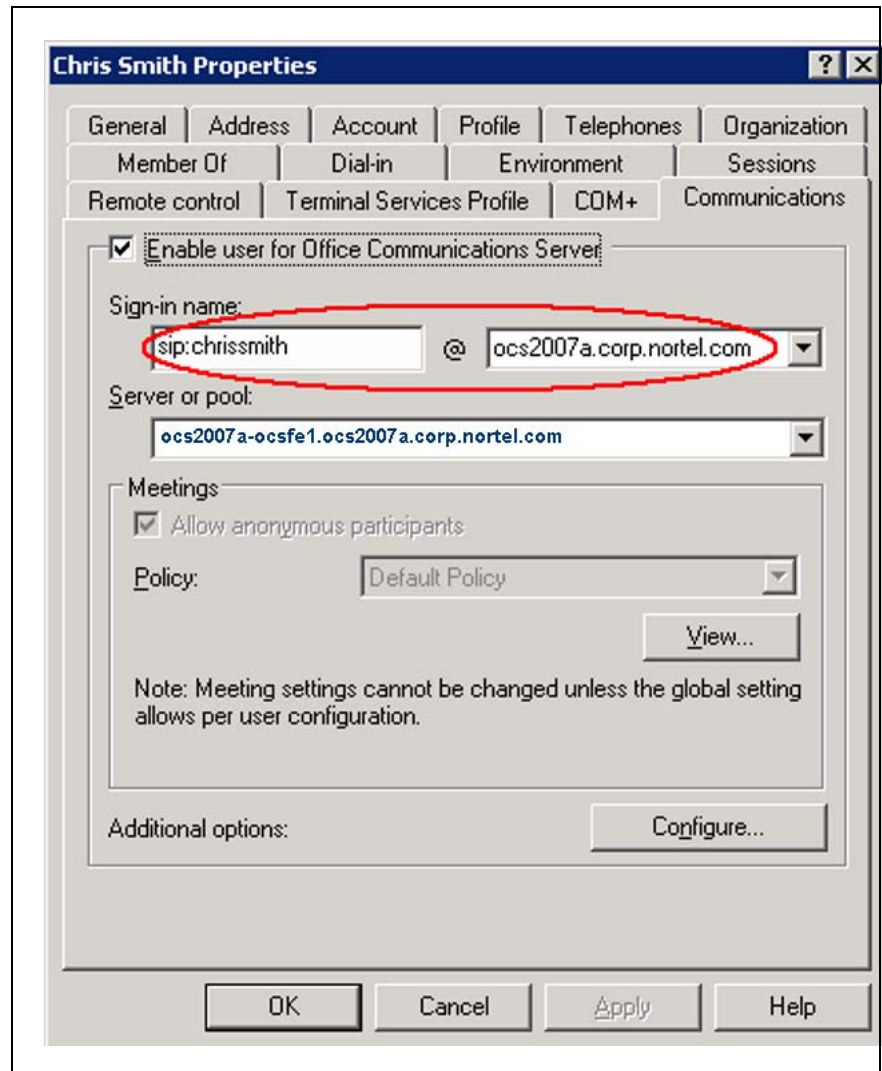
**Figure 110**  
**General user properties**



The screenshot shows a Windows-style dialog box titled "Chris Smith Properties". It has a tabbed interface with the following tabs: Member Of, Dial-in, Environment, Sessions, Remote control, Terminal Services Profile, COM+, Communications, General (selected), Address, Account, Profile, Telephones, and Organization. The "General" tab is active, displaying a small icon of a person and the name "Chris Smith". Below this, there are several text input fields: "First name:" with "Chris" entered, "Last name:" with "Smith" entered, "Display name:" with "Chris Smith" entered, "Description:" (empty), and "Office:" (empty). The "Telephone number:" field contains "2070" and is circled in red. To the right of this field is a button labeled "Other...". Below the telephone number field are "E-mail:" and "Web page:" fields, both empty, with "Other..." buttons to their right. At the bottom of the dialog are four buttons: "OK", "Cancel", "Apply", and "Help".

- b. Click on the **Communications** tab. Compare and match your settings in OCS 2007 Office Communications user properties with those in [Figure 111 "Communications properties"](#) (page 271). Ensure the SIP Sign-in name is the same as the information recorded in [Table 52 "Microsoft Active Directory"](#) (page 251).

**Figure 111**  
**Communications properties**



- c. Click the **Communications** tab and click the Configure button. Compare and match your settings with those in [Figure 112 "User Options"](#) (page 272). The Server URI and the Line URI must be the same as the information recorded in [Table 52 "Microsoft Active Directory"](#) (page 251)).

**Figure 112**  
**User Options**

**User Options**

Telephony

Select a telephony option. These settings affect only those calls that are routed through IP-PSTN or remote call control gateways.

Enable PC-to-PC communication only

Enable Remote call control

Enable Enterprise Voice

Enable PBX integration

Note: To enable both remote call control and PBX integration, you must specify a Server URI below.

Policy: Default Policy View...

Server URI: sip:2070;phone-context=cdp.udp@test.com

Line URI: tel+16139675000;ext=2070

Federation

Enable federation

Enable remote user access

Enable public IM connectivity

Archiving

Archive internal IM conversations

Archive federated IM conversations

Note: Archiving settings cannot be changed unless the global setting allows per user configuration.

Enable enhanced presence

Note: Enhanced presence cannot be changed once it has been set.

OK Cancel Help

---

—End—

---

### Checking the MCM installation and configuration

Check that the MCM is properly installed and configured.



## Checking the MCM installation and configuration

Step	Action
------	--------

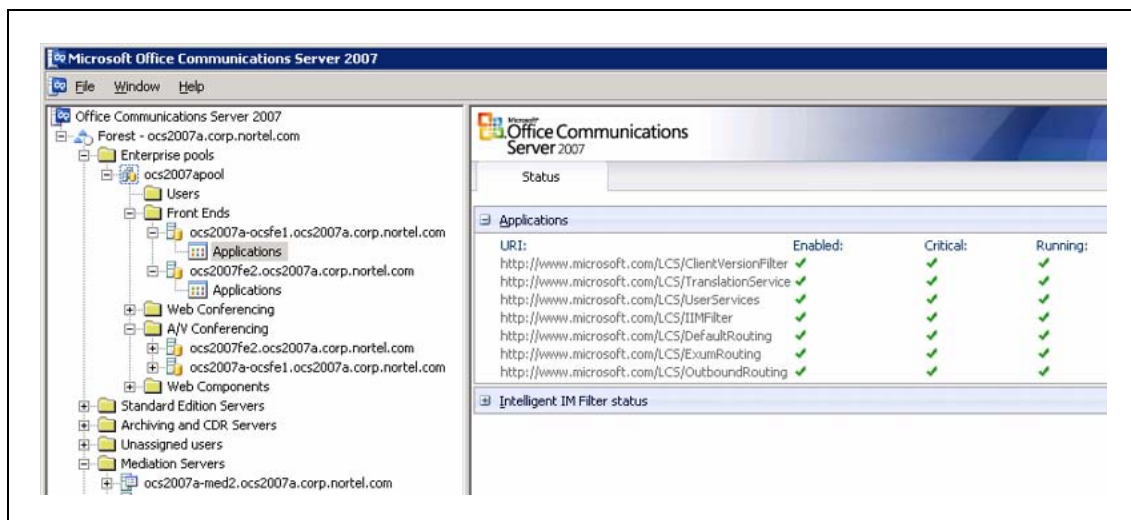
- |   |   |
|---|---|
| 1 | On the MCM, check that the user is a member of the RTC Server Applications and RTC Server Local Group.  |
| 2 | For MCM Application, confirm that MCM running and for the Default OCS applications, confirm that IM URL Filter and Routing Application are running (see Figure 113 "MCM Application" (page 273)). |

If the MCM application is not running:

Confirm that MCM is configured with the MCM user groups RTC Server Local Group and RTC Server Applications.

- Confirm that the MCM user password is correct.
- Check the Event logs to find out why MCM is not running.

**Figure 113**  
**MCM Application**



- |   |   |
|---|---|
| 3 | See Figure 114 "MCM Gateway Endpoint Configuration" (page 274) and Figure 115 "MCM Configuration screen" (page 275) to check for proper MCM configuration on NRS. |
|---|---|

—End—

**Figure 114**  
**MCM Gateway Endpoint configuration**

The screenshot displays the 'Edit Gateway Endpoint' configuration page in the Nortel Network Routing Service Manager. The interface includes a left-hand navigation menu and a main configuration area.

**Navigation Menu:**

- «Common Manager
  - System
    - NRS Server
    - Database
    - System Wide Settings
  - Numbering Plans
    - Domains
    - Endpoints
    - Routes
    - Network Post-Translation
    - Collaborative Servers
  - + Tools

**Main Configuration Area:**

**Managing:**  Active database **47.11.56.25**  
 Standby database [Numbering Plan >](#) [Endpoints >](#) [Gateway Endpoint](#)

**Edit Gateway Endpoint ( ocs2007a.corp.nortel.com / udp / cdp )**

End point name:  \*

Description:

Trust Node:

Tandem gateway endpoint name:

Endpoint authentication enabled:

Authentication password:

E.164 country code:

E.164 area code:

E.164 international dialing access code:

E.164 international dialing code length:

E.164 national dialing access code:

E.164 national dialing code length:

E.164 local (subscriber) dialing access code:

\* Required value

**Figure 115**  
**MCM Configuration screen**

The screenshot shows the 'Configuration' window with the following sections:

- Network Topology:** Call Server: CS 1000. SRS, SPS, and Direct Connect options are present. Primary IP: 47.11.56.25, Secondary IP: 0.0.0.0, Registration ID: MCM@ocs2007a.corp.nortel.co, Registration IP: 47.11.56.54, Mode: Proxy All, CS1000 SIP GW IP: 47.11.56.24, Transport: TCP, Port: 5060. Mediation Server is checked with a Routing Table button.
- Active Directory Configuration:** Query Server is selected with Synchronize at 03:00. Local Cache and Local Cache then Query Server are unselected. Non Default AD/LDAP Server is unchecked. Server IP: 0.0.0.0, Port: [empty].
- Network Dial Plan:** Dial Plan: CDP, Access Code: [empty].
- SIP-CTI Authorization:** Enable RCC Authorization is unchecked.
- Incoming Call Processing Parameters:** Called Phone Context: cdp.udp, Called Phone Prefix Delete: 0, Called Phone Prefix Insert: [empty], Caller Phone Prefix Delete: 0, Caller Phone Prefix Insert: [empty].
- Outgoing CLID Number Parameters:** Prefix Delete: 0, Prefix Insert: [empty].
- Outgoing CLID Name Parameters:** "FirstName LastName", "LastName, FirstName", and "LastName FirstName" are unchecked. AD Display Name is checked.

Buttons at the bottom: Ok, Cancel, Help.

## Enterprise Edition

This section describes the configuration of the OCS Enterprise Edition.

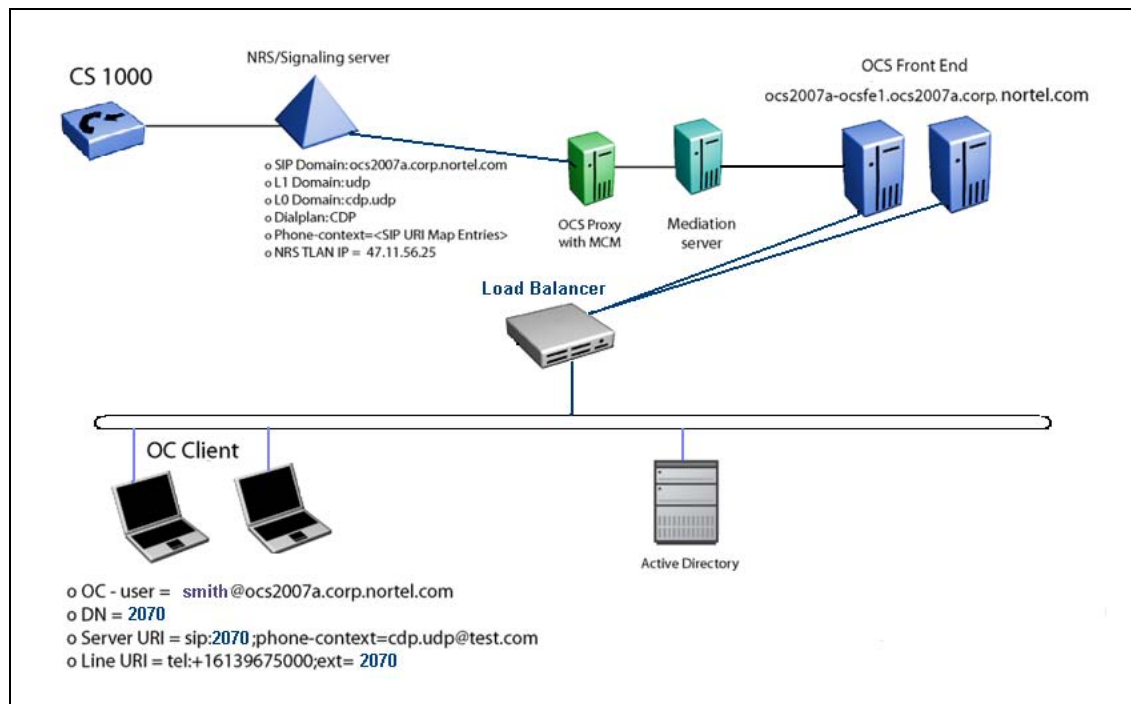
### Overview of general lab set-up

Figure 116 "OCS Enterprise Edition General Overview" (page 276), illustrates the lab set-up, which includes:

- Call Server version 5.0
- Signaling Server version 5.0
- MCM version 3.0
- 1 DNS/Active Directory Server
- Mediation Servers

- OCS FE Server with a Pool and a Microsoft Software Load Balancer
- 1 OCS Proxy server

**Figure 116**  
**OCS Enterprise Edition General Overview**



### Collecting Data for Enterprise Edition

Collect the required data listed in the following four tables before you begin to configure the Converged Office solution.

#### ATTENTION

The FQDN field is case sensitive. Enter the exact FQDN.

#### ATTENTION

The Certificate is complex and its correct configuration is not described in this section. Confirm that you have configured the Certificate correctly.

**Table 66**  
**Microsoft Active Directory**

Required information	Record your information	For example
User SIP URI		chris@ocs2007a.corp.nortel.com

Server URI		sip:2070;phone-context=cdp.udp@test.com
Line URI		tel:+16139675000;ext=2070
Telephone number		2070

**Table 67**  
**OCS**

Required information	Record your information	For example
OCS 2007 Proxy server		ocs2007a-proxy.ocs2007a.corp.nortel.com 47.11.56.54
Load Balancer Pool		ocs2007apool
OCS Enterprise Edition Front End server 1		ocs2007a-ocsfe1.ocs2007a.corp.nortel.com 47.11.56.51
OCS Enterprise Edition Front End server 2		ocs2007a-ocsfe1.ocs2007a.corp.nortel.com 47.11.56.52

**Table 68**  
**NRS**

Required information	Record your information	For example
IP-address Primary SPS		47.11.56.25 (standalone)
IP-address Secondary SPS		Not used
Node IP-address		47.11.156.24
OCS endpoint name		mcm@ocs2007a.corp.nortel.com
Communication Server 1000 SIP gateway endpoint name		ocs2007_node_A
Routing Entry for PCA		LOC: CDP: 888 - MCM LOC: 20 and 21 - OCS2007_node_A
Service domain		ocs2007asps.ocs2007a.corp.nortel.com
Level 1 domain		udp
Level 0 domain		cdp.udp

**Table 69**  
**Element Manager**

Required information	Record your information	For example
LAN configuration, FQDN (OCS Proxy and OCS Pool)		ocs2007a-proxy.ocs2007a.corp.nortel.com

LAN configuration, IP Address (OCS Proxy and OCS Pool)		47.11.56.54
Communication Server 1000 SIP gateway endpoint name		ocs2007_node_A
SIP Domain name		ocs2007a.corp.nortel.com
SIP Gateway Endpoint name		ocs2007_node_A
SIP URI map, Private/UDP domain name		udp
SIP URI map, Private/CDP domain name		cdp.udp
SIP CTI Service, Service enabled		Yes
SIP CTI Service, Customer Number		0
SIP CTI Service, International Calls As National		Yes
SIP CTI Service, National Prefix		0
SIP CTI Service, International Prefix		00
SIP CTI Service, Dialing Plan		CDP
SIP CTI Service, Calling Device URI Format		Phone-context=< sip URI map entries)
SIP CTI Service, Country Code		33
SIP CTI Service, National/ Number of digits to strip		1

### OCS Management Console

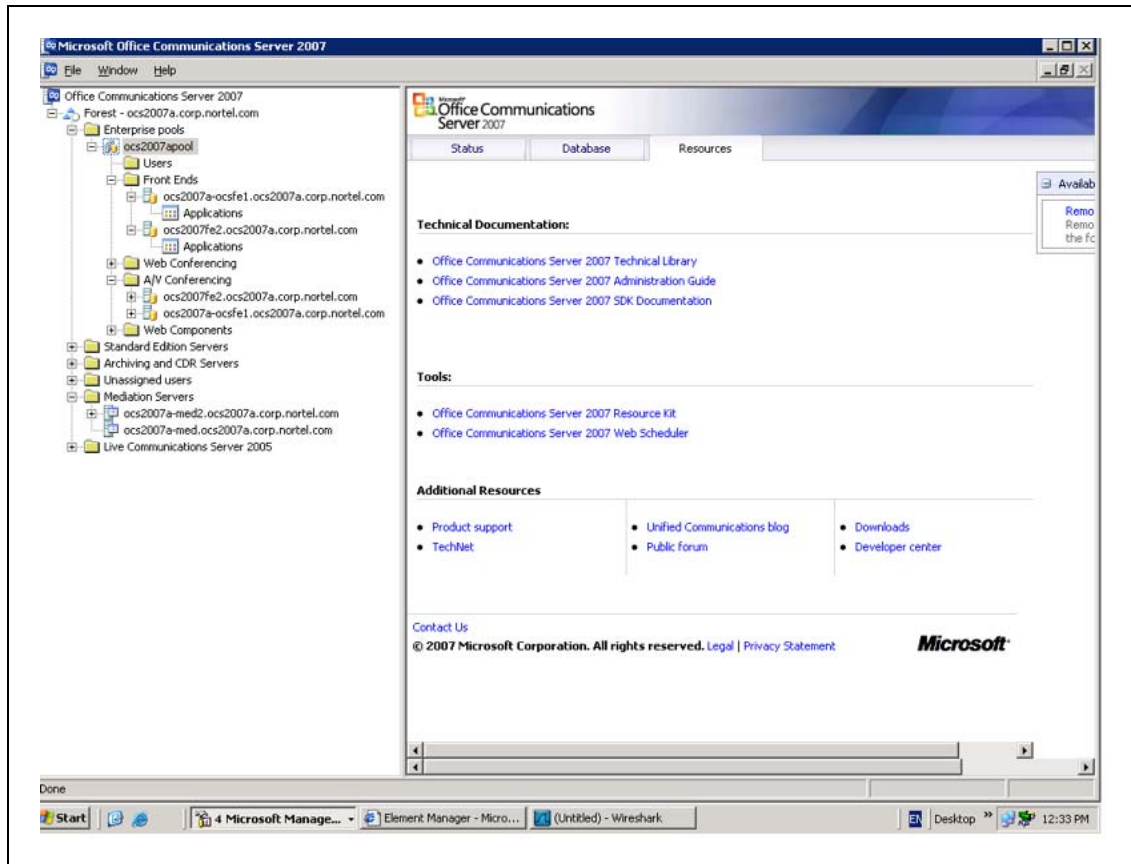
The OCS Management Console, shown in [Figure 117 "OCS Management Console" \(page 279\)](#), provides an overview of OCS configuration:

- The OCS Enterprise Edition Pool: **ocs2007apool**
- The OCS Enterprise Edition FE server(s): **ocs2007a-ocsfe1.ocs2007a.corp.nortel.com**  
The Enterprise edition can have multiple FE Servers.
- The OCS Enterprise Edition Proxy Server: **ocs2007a-proxy-ocs2007a.corp.nortel.com**

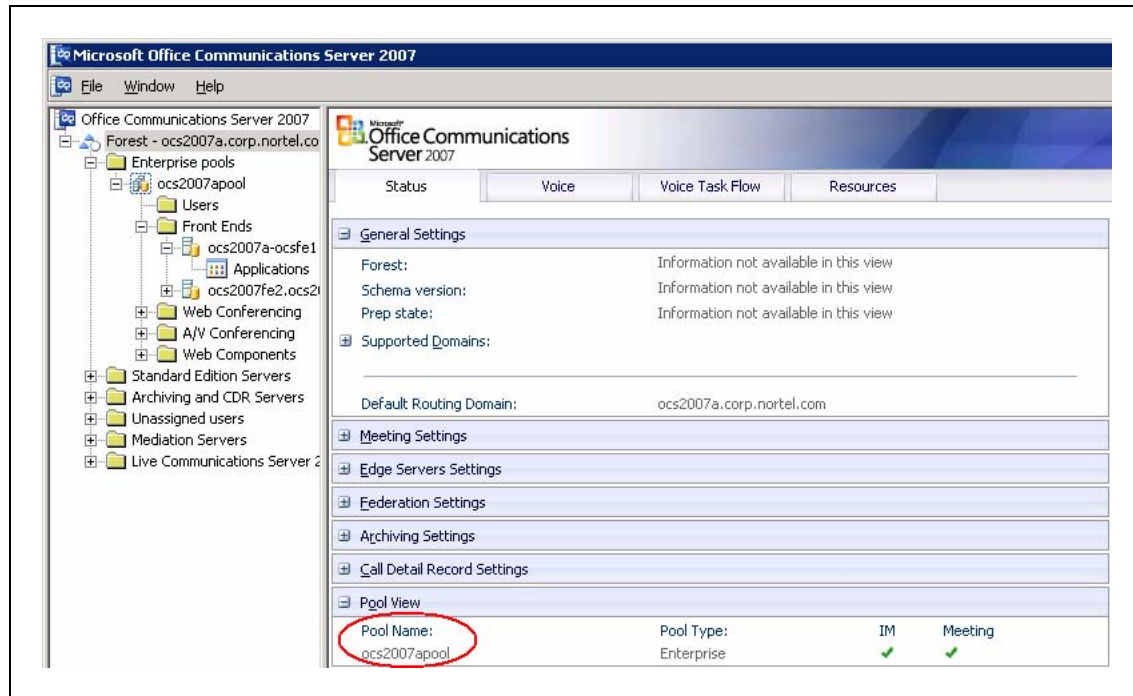
**ATTENTION**

The OCS GUI is always displayed in lower case. To determine the correct FQDN, right-click on pool, and the correct FQDN displays under Display Name as depicted in Figure 118 "Determining the exact FQDN of the pool" (page 280).

**Figure 117**  
**OCS Management Console**



**Figure 118**  
**Determining the exact FQDN of the pool**



### OCS Default Applications Running

Use the following procedure to determine which default applications are running.

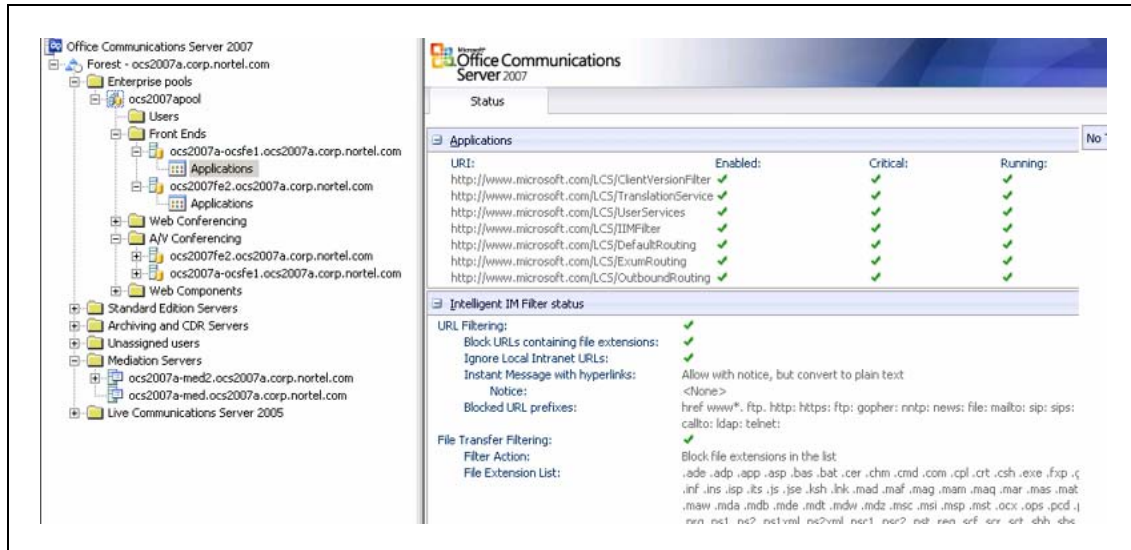
#### Identifying the active default applications

Step	Action
------	--------

- |   |  |
|---|--|
| 1 | To determine the exact FQDN of Pool, confirm that the two default applications, IM URL Filter Application Setting and Routing Application Setting are running. |
| 2 | In OCS 2007, click on Applications. See <a href="#">Figure 119 "Default applications"</a> (page 281) for an example window.                                    |



**Figure 119**  
**Default applications**



—End—

## General tab settings

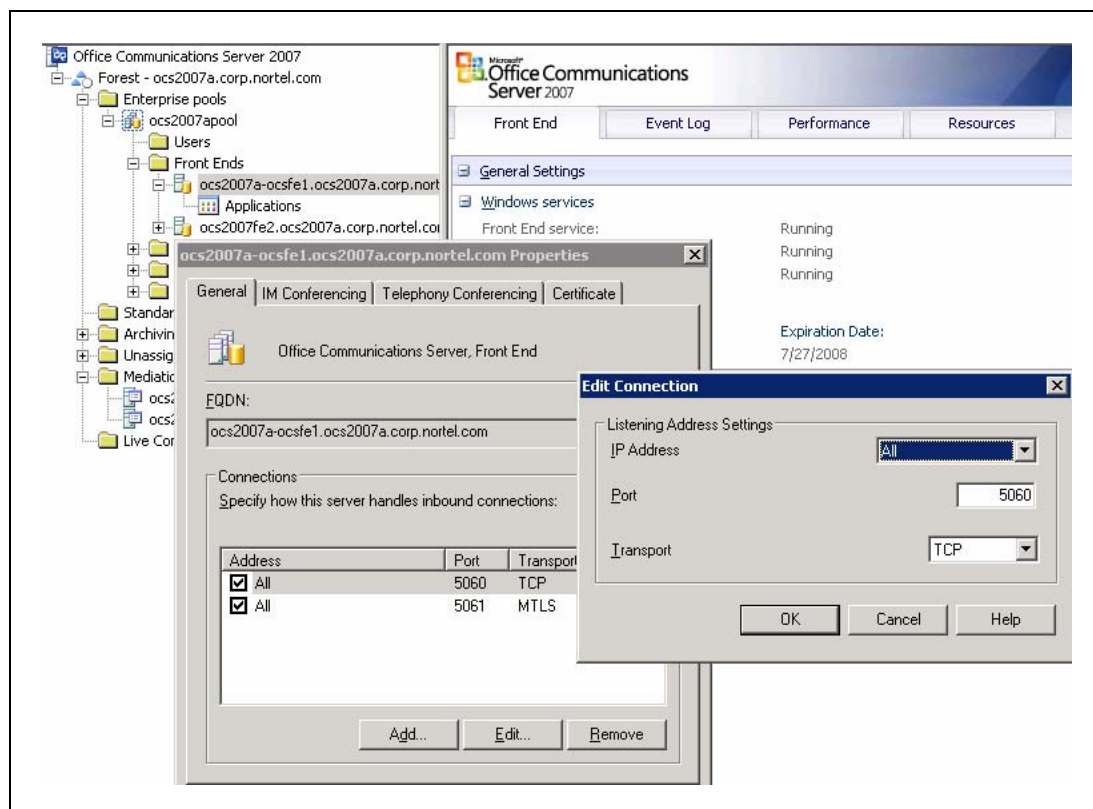
Use the following procedure to confirm the correct settings in the General tab.

### Step Action

- 1 Right-click on OCS 2007 Front End server and select **Properties**.
- 2 Choose the **General** tab and click the **Edit** button. Confirm you have the correct settings for the Front End server. For an example, see [Figure 120 "General settings"](#) (page 282).

—End—

**Figure 120**  
**General settings**



## Security/Certificates

Prior to the setup of Converged Office, configure certificates.

### ATTENTION

Certificate configuration is not covered in this section.

Use the following procedure to check your configuration settings of Certificates.

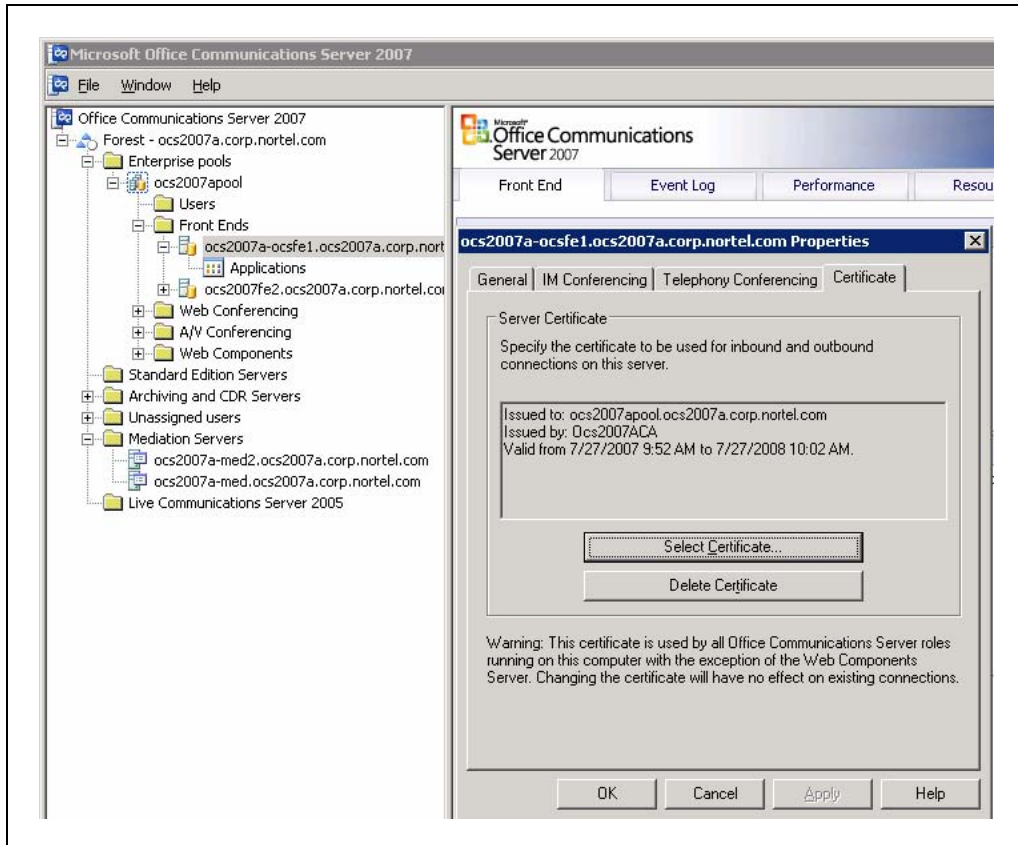
## Checking the configuration of Certificates

### Step Action

- 1 Right-click on the OCS 2007 Front End server, select **Properties**.
- 2 Choose the **Certificate** tab. The Certificate must be issued to the FDQN of the Pool, not to FQDN of the Front End server (see [Figure 121 "Front End server Certificate"](#) (page 283)).

- 3 Click the **Select Certificate** button to confirm the settings of the Front End server Certificate.

**Figure 121**  
**Front End server Certificate**



—End—

## Host Authorization

Use the following procedure to check your configuration settings of Host Authorization.

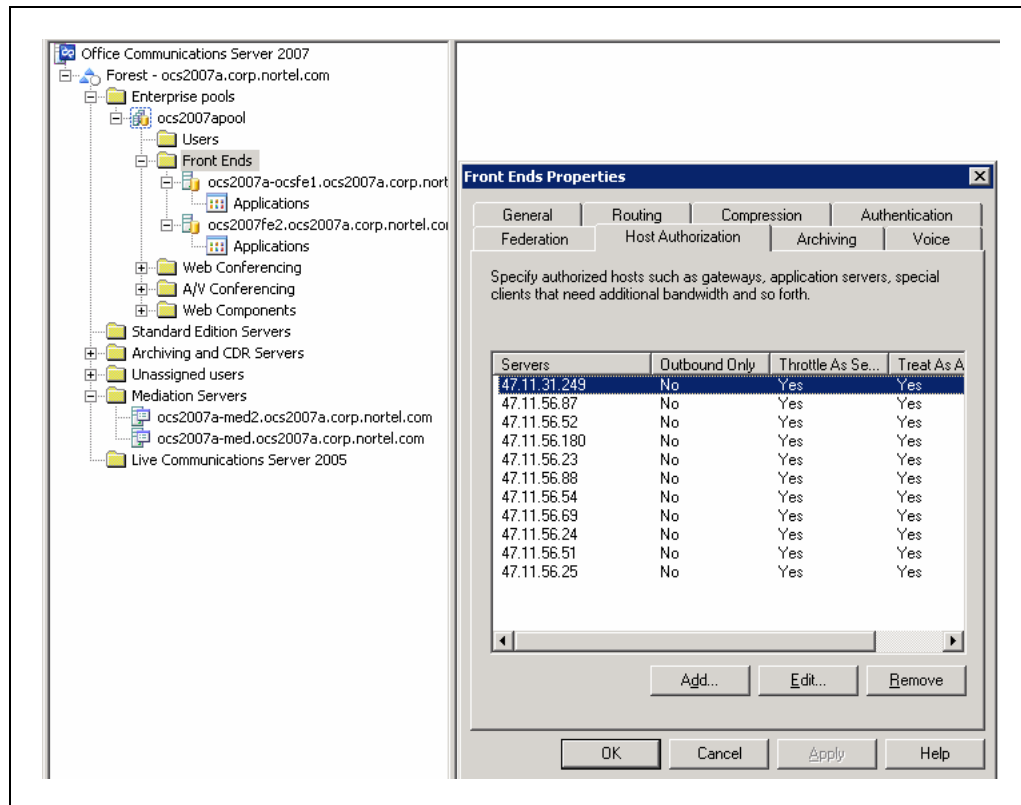
### Checking the configuration of Host Authorization

Step	Action
------	--------

- |   |   |
|---|---|
| 1 | Right-click on the OCS 2007 Front End server and select <b>Properties</b> . |
| 2 | Choose the <b>Host Authorization</b> tab.                                   |

- 3 Click the **Edit** button to confirm the settings of the Host Authorization for the Front End server (see Figure 122 "Host Authorization for Front End server" (page 284)).

**Figure 122**  
Host Authorization for Front End server



—End—

## Routing

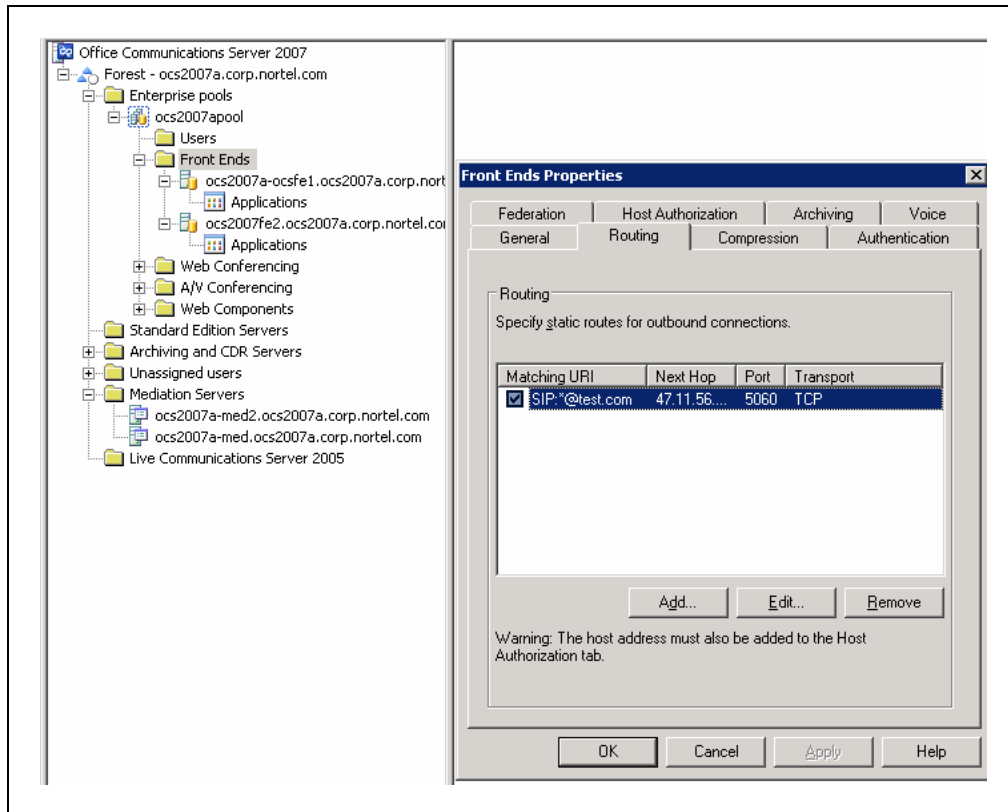
Use the following procedure to check that Routing is correctly configured.

### Checking that Routing is correctly configured

Step	Action
------	--------

- |   |   |
|---|---|
| 1 | Right-click on Front Ends and select <b>Properties</b> . Compare the Routing settings of the Front End server Enterprise Pool with the Routing settings in Figure 123 "Routing for Enterprise Pool" (page 285). |
|---|---|

**Figure 123**  
**Routing for Enterprise Pool**



- 2 Choose the **Routing** tab.
- 3 Click the **Edit** button to confirm the Matching URI and Next hop settings. (see [Figure 124 "Edit Static Route "](#) (page 286)). Forward all requests with the specified Domain.

**Figure 124**  
**Edit Static Route**

The screenshot shows a dialog box titled "Edit Static Route". It is divided into two main sections: "Matching URI" and "Next hop".

- Matching URI:**
  - Text: "Wildcard characters can be used in the domain names."
  - Field: "Domain:" with the value "test.com".
  - Checkbox: "Phone URI" (unchecked).
- Next hop:**
  - Radio buttons: "EQDN:" (unchecked) and "IP address:" (checked).
  - Field: "IP address:" with the value "47 . 11 . 56 . 54".
  - Field: "Transport:" with a dropdown menu showing "TCP".
  - Field: "Port:" with the value "5060".
  - Checkbox: "Replace host in request URI" (unchecked).

At the bottom of the dialog box are three buttons: "OK", "Cancel", and "Help".

---

—End—

---

## Configuring DNS

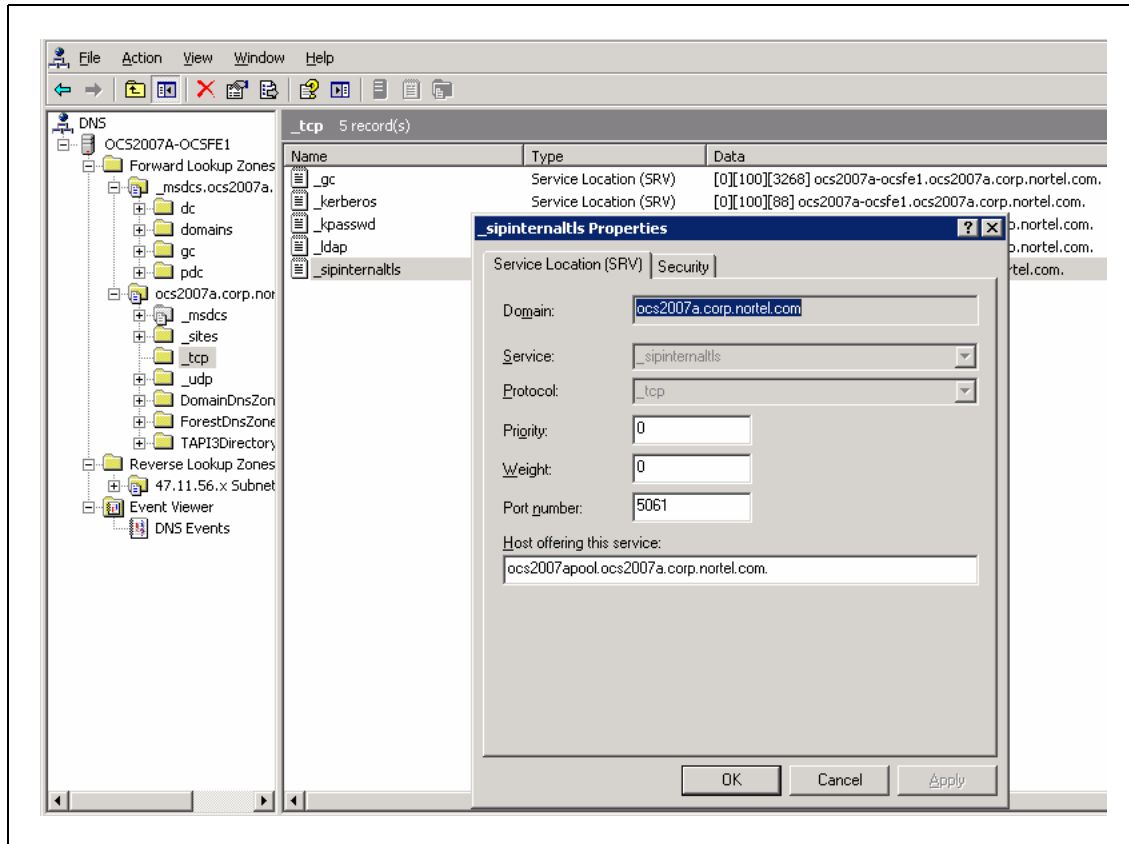
Use the following procedure to check the settings for DNS Configuration. Checking these settings assumes that the DNS service is enabled on the Windows 2003 server. The OCS servers are also using this DNS server.

### Checking that DNS is correctly configured

Step	Action
------	--------

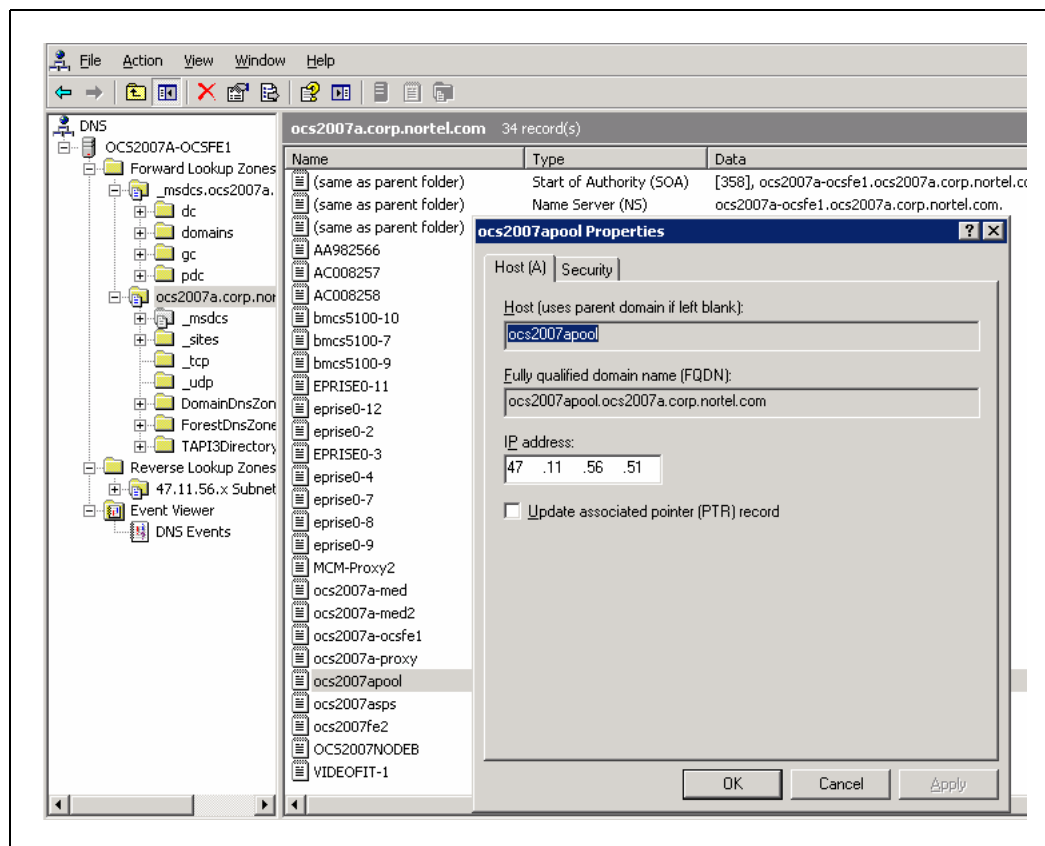
- |   |   |
|---|---|
| 1 | On the DNS server, select <b>_tcp</b> .   |
| 2 | Select <b>_sipinternaltls</b> .   |
| 3 | Right-click and select <b>Properties</b> .  |
| 4 | Click on the <b>Service Location (SRV)</b> tab.   |
| 5 | Check that the sipinternal SRV records are configured properly. See example <a href="#">Figure 125 "sipinternaltls SRV records"</a> (page 287) for the settings for sipinternaltls SRV records. |

**Figure 125**  
sipinternalts SRV records



- 6 On the DNS server, right-click on **ocs2007apool** and select **Properties**.
- 7 Select the **Host (A)** tab and check the Host A record for the Pool (see [Figure 126 "Host \(A\) record for the Pool"](#) (page 288)).

**Figure 126**  
**Host (A) record for the Pool**



For more information on these configurations, see the *Microsoft Office Communications Server 2007 Enterprise Edition Deployment Guide*. Download Microsoft documentation from the Download Center at [www.microsoft.com](http://www.microsoft.com).

—End—

## Active Directory configuration

### Step Action

- 1 On the Active Directory server, right-click on **Users** and select the name of the user to configure in the right pane.
- 2 Right-click and select **Properties**.
- 3 Choose the **Communications** tab.

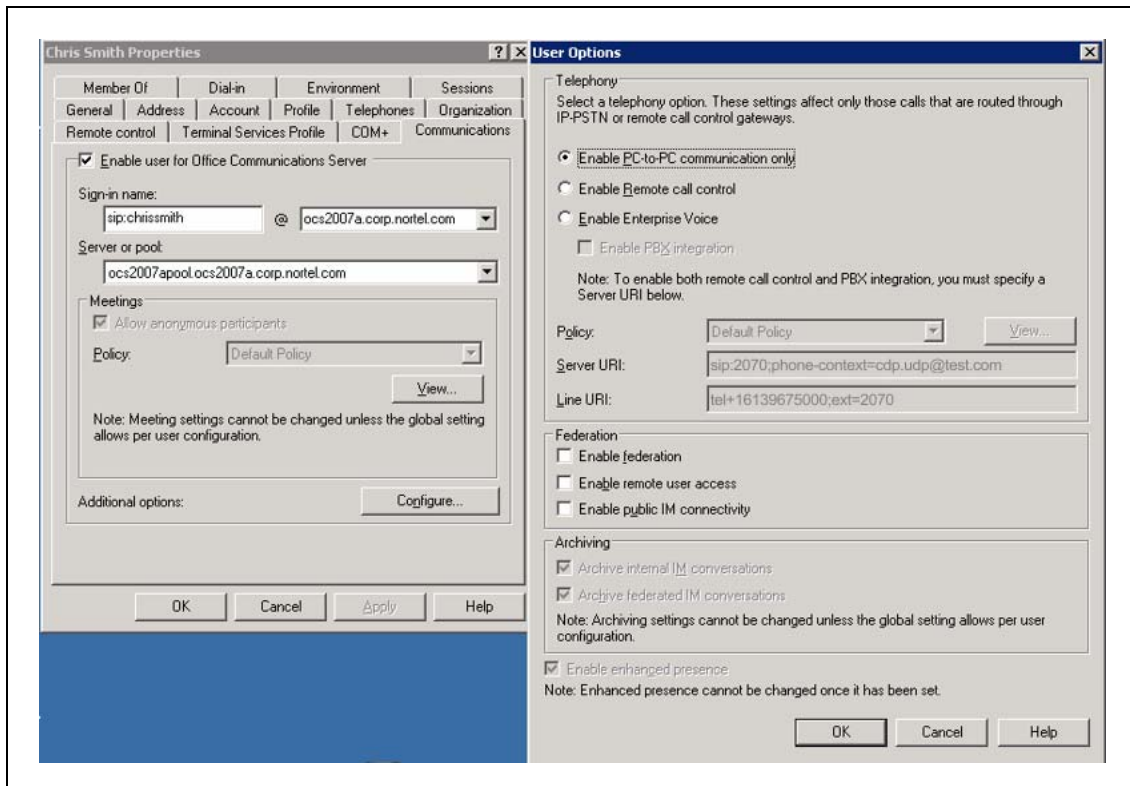


- 4 Click the **Configure** button.

—End—

See [Figure 127 "User Advanced Settings"](#) (page 289) to check the settings for Server URI and Line URI.

**Figure 127**  
**User Advanced Settings**



### ATTENTION

For more information on the user configuration of Active Directory, see the Standard Edition section ["Active Directory user configuration"](#) (page 269).

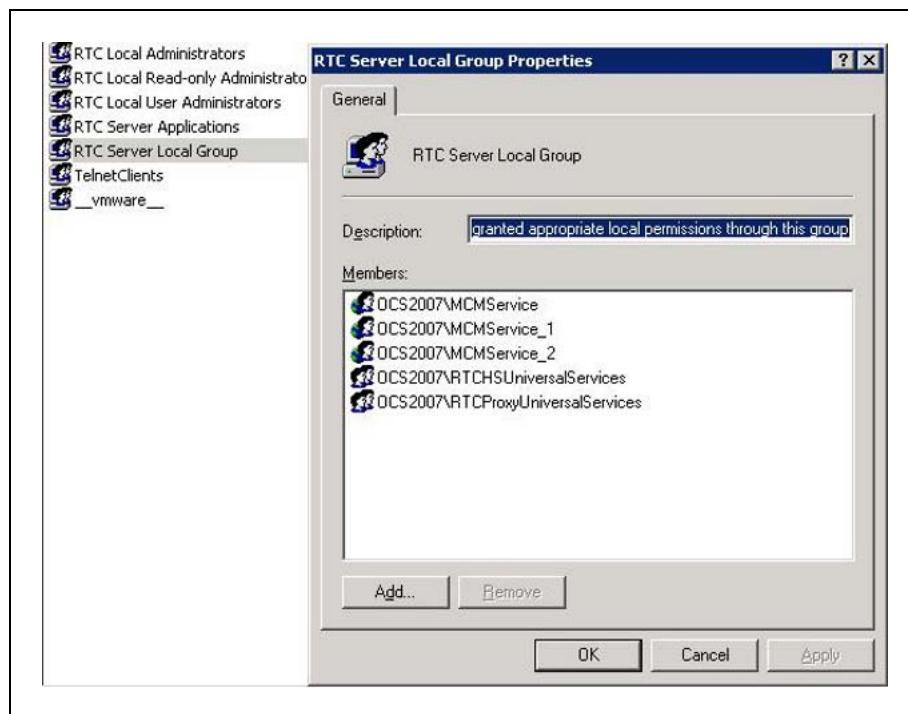
## Installing and configuring MCM

Use the following procedure to check that MCM is correctly installed and configured.

## Checking that MCM is correctly installed and configured.

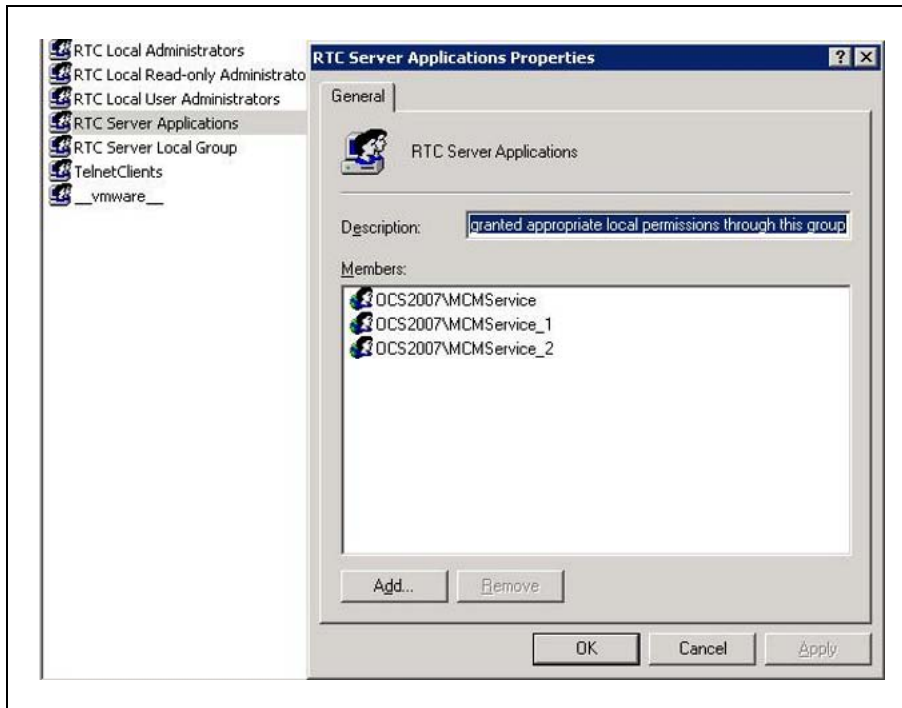
Step	Action
1	Assign the required Local group to the MCM user. Prior to installation of MCM, an MCM user inside the Active Directory is created and the RTC Server Local Group and RTC Server Application local group is assigned to this user.
2	On the Proxy Server, right-click on <b>My Computer</b> and choose <b>Manage</b> . This assigns the MCM user to the RTC Server Local Group and RTC Server Application.
3	Under Local Users and Groups, select <b>Groups</b> .
4	Right-click on <b>RTC Server Local Group</b> and select <b>Properties</b> . Confirm that the settings are correct. See <a href="#">Figure 128 "RTC Server Local Group"</a> (page 290) for an example.

**Figure 128**  
**RTC Server Local Group**



- 5 Right-click on **RTC Server Applications** and select **Properties**. Confirm that the settings of the RTC Server Application group are correct (see [Figure 129 "RTC Server Application group"](#) (page 291)).

**Figure 129**  
**RTC Server Application group**



### ATTENTION

- MCM may not run if the MCM user is not configured to belong to the required groups.
- MCM may not run if an incorrect password is entered during the MCM installation.

- 6 On the MCM server, choose the **Tools** menu and select **Configuration**. See [Figure 130 "MCM configuration"](#) (page 292) for an example.

**Figure 130**  
**MCM configuration**

- 7 Ensure that the correct **Called Phone Context** is entered. The Called Phone Context must correspond to what is configured for the **user inside Active Directory** and the **SIP URI map** (Private/CDP or UDP domain name) configured in Element Manager.

---

—End—

---

### Signaling Server checklist

Use the following procedure to check that the Signaling Server is correctly configured.

## Checking that the Signaling Server is correctly configured

Step	Action
1	Check the settings of <b>SIP URI</b> (see <a href="#">Figure 131 "SIP URI"</a> (page 293)).

Figure 131  
SIP URI

The screenshot shows the 'SIP URI Map' configuration page in the CS 1000 ELEMENT MANAGER. The page is titled 'CS 1000 ELEMENT MANAGER' and has a sub-header '+ SIP URI Settings'. Below this, there is a section for 'SIP URI Map' with several input fields for domain names:

- Public E.164/National domain name: +1
- Public E.164/Subscriber domain name: +613
- Public E.164/Unknown domain name: PublicUnknown
- Public E.164/Special Number domain name: PublicSpecial
- Private/UDP domain name: udp
- Private/CDP domain name: cdp.udp
- Private/Special Number domain name: PrivateSpecial
- Private/Unknown (vacant number routing) domain name: PrivateUnknown
- Unknown/Unknown domain name: UnknownUnknown

At the bottom of the page, there is a section for '+ SIP CD Services'.

—End—

## Configuring NRS

Use the following procedure to check that the NRS is correctly configured.

### Checking that NRS is correctly configured

Step	Action
1	Go to Network Routing Service (NRS) and select <b>Endpoints</b> . Confirm that the settings are correct (see <a href="#">Figure 132 "MCM endpoints"</a> (page 294)).

**Figure 132**  
**MCM endpoints**

The screenshot displays the 'Edit Gateway Endpoint' configuration page in the Nortel Network Routing Service Manager. The interface includes a left-hand navigation menu with sections for 'Common Manager', 'System', 'Numbering Plans', and 'Tools'. The main content area shows the following configuration details:

- Managing:** Active database (selected), Standby database (unselected). IP address: 47.11.56.25. Navigation path: [Numbering Plan](#) > [Endpoints](#) > [Gateway Endpoint](#).
- Endpoint Name:** MCM (marked as a required value with an asterisk).
- Description:** MCM on OCS Proxy.
- Trust Node:**
- Tandem gateway endpoint name:** Not configured.
- Endpoint authentication enabled:** Authentication off.
- Authentication password:** [Empty text field]
- E.164 country code:** [Empty text field]
- E.164 area code:** [Empty text field]
- E.164 international dialing access code:** [Empty text field]
- E.164 international dialing code length:** [Empty text field]
- E.164 national dialing access code:** [Empty text field]
- E.164 national dialing code length:** [Empty text field]
- E.164 local (subscriber) dialing access code:** [Empty text field]

A legend at the bottom left indicates that an asterisk (\*) denotes a required value.

- 2 From the **Routing Entries** tab, confirm that the settings are correct (see [Figure 133 "Routing Entries for Endpoints"](#) (page 295)).

**Figure 133**  
**Routing Entries for Endpoints**

The screenshot displays the 'NETWORK ROUTING SERVICE MANAGER' interface. At the top, there are links for 'Help' and 'Logout'. Below this, the 'Managing' section shows 'Active database' selected with IP '47.11.56.25' and 'Standby database' with a link to 'Numbering Plan > Routes'. The main section is titled 'Search for Routing Entries' and contains a search form with fields for 'DN Prefix' (with an asterisk), 'DN Type' (set to 'All DN Types'), 'Limit results to Domain' (with three dropdowns: 'All service domains', 'All L1 domains', and 'All L0 domains'), and 'Endpoint Name' (set to 'All gateway endpoints'). A 'Results per page' dropdown is set to '100' and a 'Search' button is present. Below the search form, there are two tabs: 'Routing Entries (25)' and 'Default Routes (0)'. The 'Routing Entries (25)' tab is active, showing a table with columns: 'DN Prefix', 'DN Type', 'Route Cost', 'SIP URI Phone Context', and 'Context'. The table lists four entries with checkboxes in the first column. At the bottom of the table, it says '1 - 25 of 25 Routing Entry(ies)' and navigation links 'First | Previous | Next | Last'.

<input type="checkbox"/>	DN Prefix	DN Type	Route Cost	SIP URI Phone Context	Context
<input type="checkbox"/>	10	Private level 0 regional (CDP steering code)	1	cdp1.udp1	lcs2005s.corp.nortel.com / udp1 / cdp1 / node3228
<input type="checkbox"/>	11	Private level 0 regional (CDP steering code)	1	cdp1.udp1	lcs2005s.corp.nortel.com / udp1 / cdp1 / um_node134
<input type="checkbox"/>	2	Private level 0 regional (CDP steering code)	1	cdp1.udp1	lcs2005s.corp.nortel.com / udp1 / cdp1 / node1220
<input type="checkbox"/>	20	Private level 0 regional (CDP steering code)	1	cdp.udp	ocs2007a.corp.nortel.com / udp /

—End—

## Normalizing Phone Numbers

When normalizing phone numbers, the **Telephone Number** field can be different from what is configured in the OCS user configuration for the **Line URI** field. However, a corresponding normalization rule should be defined in the "Company\_Phone\_Number\_Normalization\_Rules.txt" file to convert the Telephone Number to the Line URI format.

For example:

```
##
## CDP 4 digits
##
(d\d\d\d)
+16139675000;ext=$1
```

If the Telephone Number is normalized to the Line URI format, you can use the "Click to Call" feature to show the caller's user name when the Address Book Service is available.



---

## Appendix C

# Abbreviations

---

<b>ACD</b>	Automatic Call Distribution
<b>AD</b>	Active Directory
<b>AML</b>	Application Module Link
<b>ATS</b>	Activity Tracking System
<b>AUX</b>	Auxiliary
<b>B2BUA</b>	Back 2 Back User Agent
<b>BCC</b>	Basic Client Configuration
<b>BRSC</b>	Basic Rate Signaling Concentrator
<b>CAST</b>	Customer Assurance and Serviceability Test
<b>CCMS</b>	Contact Center Manager Server
<b>CCR</b>	Customer Controlled Routing

<b>CDP</b>	Coordinated Dialing Plan
<b>CDR</b>	Call Detail Recording
<b>CS</b>	Communication Server
<b>CSTA</b>	Computer Supported Telecommunications Applications
<b>DC</b>	Domain Controllers
<b>DRAM</b>	Dynamic Random Access Memory
<b>DN</b>	Directory Number
<b>DNIS</b>	Dialed Number Identification Services
<b>EC</b>	Enterprise Configurator
<b>EMS</b>	Enterprise Multimedia Systems
<b>EPROM</b>	Erasable Programmable Read-Only Memory
<b>FS</b>	Feature Specification
<b>FQDN</b>	Fully Qualified Domain Name
<b>GC</b>	Global Catalog
<b>GNTS</b>	Global Network Technical Support

---

<b>IP</b>	Internet Protocol
<b>IPSec</b>	Secure Internet Protocol
<b>IVR</b>	Interactive Voice Response
<b>LDAP</b>	Lightweight Directory Access Protocol
<b>MISP</b>	Multipurpose ISDN Signaling Processor
<b>MCM</b>	Multimedia Convergence Manager
<b>MMC</b>	Microsoft Management Console
<b>MNM</b>	Meridian Network Management
<b>MSDL</b>	Multi-purpose Serial Data Link
<b>NAS</b>	Nortel Application Switch
<b>NCR</b>	Number of Call Registers
<b>NRS</b>	Network Routing Service
<b>OC</b>	Office Communicator
<b>OCS</b>	Office Communications Manager
<b>P</b>	Pentium

<b>PSTN</b>	Public Switched Telephone Network
<b>PRD</b>	Product Requirements Document
<b>RCC</b>	Remote Call Control Provides full Microsoft Office integration of telephony to control business-grade telephony phones from within Microsoft Office applications, as well as support for a standards-based CTI interface defined by the TR/87 protocol.
<b>RDB</b>	Route Data Block
<b>RTP</b>	Real-Time Transport Protocol
<b>SA</b>	StrongARM
<b>SDP</b>	Session Description Protocol
<b>SIP CTI</b>	Session Initiation Protocol Computer Telephony Integration The SIP CTI (TR/87) protocol is on the Communication Server 1000 Signaling Server. TR/87 is the specification that OC 2007 uses to implement phone integration throughout the suite of Microsoft Office applications.
<b>SISP</b>	Small System ISDN Signaling Processor
<b>SPS</b>	SIP Proxy Server
<b>SRS</b>	SIP Redirect Service
<b>SRTP</b>	Secure Real-Time Transport Protocol

<b>TN</b>	Terminal Number
<b>URI</b>	Uniform Resource Identifier
<b>VIP</b>	Virtual Internet Protocol
<b>VoIP</b>	Voice over Internet Protocol
<b>VTRK</b>	Virtual Trunk
<b>XPEC</b>	Expanded Peripheral Equipment Controller Pack





Nortel Communication Server 1000

## Nortel Converged Office Fundamentals — Microsoft Office Communications Server 2007

Copyright © 2005–2008 , Nortel Networks  
All Rights Reserved.

Publication: NN43001-121  
Document status: Standard  
Document version: 01.03  
Document date: 30 April 2008

### LEGAL NOTICE

While the information in this document is believed to be accurate and reliable, except as otherwise expressly agreed to in writing, NORTEL PROVIDES THIS DOCUMENT "AS IS" WITHOUT WARRANTY OR CONDITION OF ANY KIND, EITHER EXPRESS OR IMPLIED. The information and/or products described in this document are subject to change without notice.

Nortel, the Nortel logo, the Globemark, Meridian 1, and Succession are trademarks of Nortel Networks.

All other trademarks are the property of their respective owners.

To provide feedback or report a problem in the document, go to [www.nortel.com/documentfeedback](http://www.nortel.com/documentfeedback).

Sourced in Canada





## Free Manuals Download Website

<http://myh66.com>

<http://usermanuals.us>

<http://www.somanuals.com>

<http://www.4manuals.cc>

<http://www.manual-lib.com>

<http://www.404manual.com>

<http://www.luxmanual.com>

<http://aubethermostatmanual.com>

Golf course search by state

<http://golfingnear.com>

Email search by domain

<http://emailbydomain.com>

Auto manuals search

<http://auto.somanuals.com>

TV manuals search

<http://tv.somanuals.com>