



Nortel Communication Server 1000

Main Office Configuration Guide for SRG 50

NN43001-307

Document status: Standard
Document version: 02.02
Document date: 3 December 2007

Copyright © 2005-2007, Nortel Networks
All Rights Reserved.

Sourced in Canada.

The information in this document is subject to change without notice. The statements, configuration, technical data, and recommendations in this document are believed to be accurate and reliable, but are presented without express or implied warranty. Users must take full responsibility for their applications of any products specified in this document. The information in this document is proprietary to Nortel Networks.

Nortel, Nortel (Logo), the Globemark, SL-1, Meridian 1, and Succession are trademarks of Nortel Networks.

All other trademarks are the property of their respective owners.

Revision history

December 2007

Standard 02.02. This document is up-issued to support CS 1000 Release 5.0 for SRG 50 Release 3.0. This document includes SIP Trunks configuration at the main office.

August 2007

Standard 02.01. This document is up-issued to support CS 1000 Release 5.0 for SRG 50 Release 3.0.

June 2007

Standard 01.02. This document is up-issued to remove the Nortel Networks Confidential statement.

May 2007

Standard 01.01. This document is up-issued to support Communication Server 1000 Release 5.0. This document contains information previously contained in the following legacy document, now retired: (553-3001-207). This document is up-issued to include updated information due to CR Q01587820. See "[Codec negotiation](#)" (page 95).

October 2006

Standard 3.00. This document is up-issued to support SRG 50 Release 2.0 for CS 1000 Release 4.5.

January 2006

Standard 2.00. This document is up-issued for CR Q01202736, with information on reconfiguring Call Server alarm notification levels if necessary when configuring Adaptive Network Bandwidth Management.

August 2005

Standard 1.00. This document is a new document to support Communication Server 1000 Release 4.5.

4 Revision history

Nortel Communication Server 1000
Main Office Configuration Guide for SRG 50
NN43001-307 02.02 Standard
Release 5.0 3 December 2007

Copyright © 2005-2007, Nortel Networks

Contents

| | |
|---|-----------|
| New in this release | 9 |
| Other | 9 |
| Subject | 9 |
| Intended audiences | 9 |
| Related information | 9 |
| NTPs | 10 |
| Online | 10 |
| CD-ROM | 10 |
| <hr/> | |
| Description | 11 |
| Contents | 11 |
| Survivable Remote Gateway | 11 |
| Main office hardware description | 14 |
| Main office requirements | 17 |
| Optional features to enhance SRG functionality | 18 |
| Normal Mode and Local Mode overview | 19 |
| Normal Mode | 19 |
| Bandwidth Management Overview | 24 |
| Time of Day | 24 |
| SRG IP Phone to local PSTN calls | 25 |
| IP Phone to analog (500/2500-type) telephone calls | 25 |
| Capacity | 26 |
| Branch office dialing plan | 27 |
| Branch office and SRG 50 terminology | 28 |
| Limitations | 29 |
| <hr/> | |
| Setting up the main office | 31 |
| Contents | 31 |
| Introduction | 31 |
| SRG information required by the main office | 31 |
| Main office information required by the SRG | 32 |
| Zone parameters | 34 |
| Branch office IP Phone configuration at the main office | 38 |
| SIP IP Trunks configuration at the main office | 40 |

Dialing Plan configuration 43

- Contents 43
 - Overview 43
 - On-net dialing plan 43
 - Off-net dialing plan 45
 - Routing calls 45
 - SIP/H.323 zones 45
 - Zone-based digit manipulation 46
 - Configuring the dialing plan for PSTN access to SRG users in Normal Mode 48
 - Dialing plan examples 65
-

Bandwidth Management 95

- Contents 95
 - Introduction 95
 - Codec negotiation 95
 - Configuring Bandwidth Management parameters 101
 - Adaptive Network Bandwidth Management 110
 - Tandem Bandwidth Management overview 129
 - Dialing Plan Overview 130
 - Network using Uniform Dialing Plan 132
 - Network using Coordinated Dialing Plan 154
-

Alternative Call Routing for Network Bandwidth Management 159

- Contents 159
 - Description 159
 - Operating parameters 174
 - Feature interactions 175
 - Feature packaging 176
 - Feature implementation using Command Line Interface 176
 - Feature implementation using Element Manager 178
 - Diagnostics 180
 - Maintenance 184
 - Feature operation 187
-

Emergency Services configuration 189

- Contents 189
 - Overview 189
 - Emergency Services Access 190
 - Emergency Services for Virtual Office 200
 - On-Site Notification 201
 - Configuring the NRS for ESA SPN 201
 - Testing the ESDN number 202
 - Configuring ESA using Element Manager 202
 - Emergency Service using Special Numbers (SPN) 202
-

| | |
|---|---|
| Enhanced UNiStim Firmware Download | 205 |
| Contents | 205 |
| Description | 205 |
| Firmware upgrade | 206 |
| Appendix A Media Redirection Scenarios | 209 |
| List of terms | 213 |
| Index | 218 |
| Procedures | |
| Procedure 1 | Configuring ESN and SRG zones 34 |
| Procedure 2 | Configuring branch office IP Phones at the main office using LD 11 39 |
| Procedure | Configuring SIP IP Trunks 40 |
| Procedure 3 | Configuring the main office 49 |
| Procedure 4 | Configuring the NRS database 57 |
| Procedure 5 | Configuring the branch office 60 |
| Procedure 6 | Testing PSTN access using an SRG IP Phone 64 |
| Procedure 7 | Printing intrazone and interzone statistics for a zone 106 |
| Procedure 8 | Displaying CAC parameters for one or more zones 124 |
| Procedure 9 | Provisioning Tandem Bandwidth Management 145 |
| Procedure 10 | Accessing the Zones web page 178 |
| Procedure 11 | Printing zone ALTPrefix 181 |
| Procedure 12 | Show Status 183 |
| Procedure 13 | Enabling behavior at a zone 185 |
| Procedure 14 | Suppress Alternative Call Routing for NBWM alarms 187 |
| Procedure 15 | Configuring the main office 195 |
| Procedure 16 | Configuring the branch office zone 200 |
| Procedure 17 | Testing ESDN using an SRG telephone 202 |
| Procedure 18 | Upgrading firmware 207 |

New in this release

The *CS 1000 Main Office Configuration for SRG50 (NN43001-307)* for CS 1000 Release 5.0 includes support for SRG 50 Release 3.0.

The following sections detail what is new in *CS 1000 Main Office Configuration for SRG50 (NN43001-307)* for CS 1000 Release 5.0 .

Other

CS 1000 Main Office Configuration for SRG50 (NN43001-307) includes the following changes:

- Replaced instances of OTM 2.2 with TM 3.1.
- Updated Element Manager with enhancements.
- Added support for new IP Phones.
- Removed instances of CS 1000S and Small Systems.
- Removed instances of Terminal Numbers (TN) in "c u" format. Only TN in "l s c u" format are supported.

Subject

This document describes the *CS 1000 Main Office Configuration for SRG50 (NN43001-307)* for software Release 3.0 for CS 1000 Release 5.0. Information in this document complements information found in documents in the Communication Server 1000 documentation suite. For information about how to configure the SRG 50, see *SRG50 Configuration Guide (NN40140-500)* at www.nortel.com. Select Support & Training > Technical Documentation > Communication Servers > BCM.

Intended audiences

This document is intended for individuals responsible for configuring the main office for Survivable Remote Gateway for organizations using CS 1000 systems.

Related information

This section lists information sources that relate to this document.

Nortel Communication Server 1000
Main Office Configuration Guide for SRG 50
NN43001-307 02.02 Standard
Release 5.0 3 December 2007

NTPs

The following NTPs are referenced in this document:

- *Converging the Data Network with VoIP (NN43001-260)*
- *Electronic Switched Network Reference—Signaling and Transmission (NN43001-280)*
- *Dialing Plans Reference (NN43001-283)*
- *Signaling Server Installation and Commissioning (NN43001-312)*
- *IP Peer Networking Installation and Commissioning (NN43001-313)*
- *Branch Office Installation and Commissioning (NN43001-314)*
- *Telephony Manager 3.1 System Administration (NN43050-601)*
- *Software Input Output Administration (NN43001-611)*
- *Emergency Services Access Fundamentals (NN43001-613)*
- *Element Manager System Reference Administration (NN43001-632)*
- *IP Line Fundamentals (NN43100-500)*
- *ISDN Primary Rate Interface Fundamentals (NN43001-569)*
- *Basic Network Feature Fundamentals (NN43001-579)*
- *Communication Server 1000M and Meridian 1 Small System Planning and Engineering (NN43011-220)*
- *Communication Server 1000M and Meridian 1 Large System Planning and Engineering (NN43021-220)*
- *Communication Server 1000E Planning and Engineering (NN43041-220)*
- *Software Input Output Reference—Maintenance (NN43001-711)*
- *SRG50 Configuration Guide (NN40140-500)*

Online

To access Nortel documentation online, click the Technical Documentation link under Support & Training on the Nortel home page:

www.nortel.com

CD-ROM

To obtain Nortel documentation on CD-ROM, contact your Nortel customer representative.

Description

Contents

This section contains information about the following topics:

- ["Survivable Remote Gateway" \(page 11\)](#)
- ["Main office hardware description" \(page 14\)](#)
- ["Main office requirements" \(page 17\)](#)
- ["Optional features to enhance SRG functionality" \(page 18\)](#)
- ["Normal Mode and Local Mode overview" \(page 19\)](#)
- ["Capacity" \(page 26\)](#)
- ["Branch office dialing plan" \(page 27\)](#)
- ["Branch office and SRG 50 terminology" \(page 28\)](#)

Survivable Remote Gateway

The Survivable Remote Gateway (SRG) extends the desktop feature and user interface of the CS 1000 to remote IP branch office users and gives them full access to the same applications as the main site. CallPilot, Contact Center Management Server (CCMS), and other central applications are shared by remote users to deliver state-of-the-art features and functionality to small remote offices.

SRG 50 Release 2.0 provides the following:

- extends the supported number of survivable IP users from 32 to 80
- extends support for the IP Phone 1120E, IP Phone 1140E, IP Audio Conference Phone 2033, and WLAN 2212

See ["Supported IP Phones" \(page 16\)](#) for a complete list of supported IP Phones.

- supports H.323 and SIP Trunking to the CS 1000 main office
- supports analog devices, such as fax machines and terminals but are limited in number and limited to basic access

SRG 50 Release 3.0 provides the following:

- extends support for the IP Phone 1110
See "[Supported IP Phones](#)" (page 16) for a complete list of supported IP Phones.
- evolves the SIP trunk to support a standard SIP Trunk interface
- supports On-site Notification

Table 1
Supported software at the branch office

| IP branch office solution | Survivable users | Server support | Feature description |
|---------------------------|------------------|--|---|
| SRG 1.0 | up to 90 | Succession 3.0 CS 1000 Release 4.0 CS 1000 Release 4.5 | VoIP and Application Gateway Local Mode = Basic telephony features |
| SRG 50 Release 1.0 | up to 32 | Succession 3.0 CS 1000 Release 4.0 CS 1000 Release 4.5 | VoIP and Application Gateway Local Mode = Basic telephony features A more cost effective small branch office solution. Provides H.323 trunking. For more information, see <i>CS 1000 Main Office Configuration Guide for SRG 50 (553-3001-207)</i> . |
| SRG200/400 Release 1.5 | up to 90 | Succession 3.0 CS 1000 Release 4.0 CS 1000 Release 4.5 CS 1000 Release 5.0 | VoIP and Application Gateway Local Mode = Basic telephony features Feature Parity with SRG 50, new OS, and extended IP Phone support. Provides H.323 trunking. For more information, see <i>Main Office Configuration Guide for SRG 200/400 Release 1.5 (NN43001-308)</i> . |
| SRG 50 Release 2.0 | up to 80 | Succession 3.0 CS 1000 Release 4.0 CS 1000 Release 4.5 CS 1000 Release 5.0 | VoIP and Application Gateway Local Mode = Basic telephony features Extends IP Phone support and survivable IP users from 32 to 80. Provides H.323 and SIP trunking. For more information, see <i>CS 1000 Main Office Configuration Guide for SRG 50 (553-3001-207)</i> . |

| IP branch office solution | Survivable users | Server support | Feature description |
|---------------------------|------------------|--|---|
| SRG 50 Release 3.0 | up to 80 | CS 1000 Release 5.0 | VoIP and Application Gateway Local Mode = Basic telephony features Extends IP Phone support to include the IP Phone 1110. Supports On Site Notification for E-911 calls. Provides H.323 and SIP trunking. |
| MG 1000B | up to 400 | Succession 3.0 CS 1000 Release 4.0 CS 1000 Release 4.5 CS 1000 Release 5.0 | 100% CS 1000 feature and application redundancy in survivable mode. Designed and positioned for larger IP branch offices. Provides H.323 and SIP trunking. |
| MG 1000E | up to 400 | CS 1000 Release 5.0 | Provides survivability with the addition of Call Processor Pentium Mobile (CP PM). |

The SRG is implemented on a BCM 50 platform and is connected to a CS 1000 at the main office through Virtual Trunks over a reliable IP WAN access facility. This configuration allows the call processing for the IP Phones at the SRG site to be centralized at the main office. The Call Server at the main office provides the call processing for the IP Phones registered to both the main office and branch offices. The SRG provides call processing functionality to phones in local mode and local analog devices. The SRG supports business continuity and call failover through digital and analog trunk access to the local Public Switched Telephone Network (PSTN).

In order for devices in the CS 1000 network to access analog devices at the SRG or to access the PSTN at the SRG, virtual trunks are used over the LAN/WAN.

If the main office fails to function, or if there is a network/WAN outage, the SRG automatically switches to Local mode and provides basic telephony service to the phones located at the branch office. This enables the IP Phones to survive the outage between the branch office and the main office.

To ensure proper operation of the SRG solution it must be configured to support a common dialing plan with the CS 1000 main office. Any other configuration is not guaranteed to work reliably. Since the Call Server and the SRG handle dialing slightly differently, ensure that any settings you use for the main office that need to interact with the SRG, can be accommodated by the SRG call processing.

Figure 1 "SRG network" (page 14) shows the networking among the main office, SRG, and IP Phones.

Figure 1
SRG network

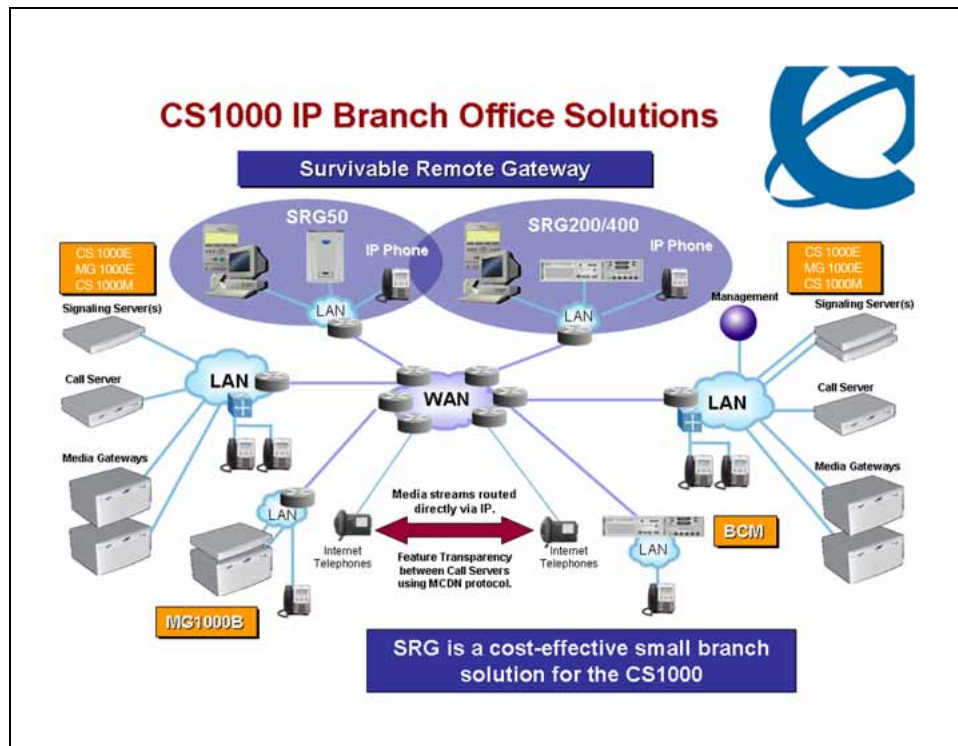

Main office hardware description

The main office must be one of the following systems:

- CS 1000E
- CS 1000M Cabinet
- CS 1000M Chassis
- CS 1000M HG
- CS 1000M SG
- CS 1000M MG

Throughout this document, references to CS 1000 systems encompass all CS 1000 system types.

The diagrams throughout this documentation show a CS 1000E main office. All of the systems appearing in the list perform identical main office functions as far as the SRG is concerned. For information about the SRG, see *SRG50 Configuration Guide (NN40140-500)*.

Signaling Server

The following Signaling Servers are available for CS 1000 Release 5.0 :

- ISP1100
- HP-DL320-G4
- IBM-X306m
- Common Processor Pentium Mobile (CP PM)

The Signaling Server is required at the main office only. It provides the following functions:

- Terminal Proxy Server (TPS)
The TPS provides a connection from the IP Phones to the Call Server and a connection from a Virtual Trunk to the Call Server.
- H.323 Gateway (Virtual Trunk)
- SIP Gateway (Virtual Trunk)
- CS 1000 Element Manager Web Server and Network Routing Service (NRS)
- NRS, consisting of:
 - SIP Redirect Server NRS
 - H.323 Gatekeeper
 - Network Connection Service (NCS)
- Personal Directory

A second Signaling Server can be used to provide redundancy in the case of a failure in the primary Signaling Server at the main office.

A similar function to the Signaling Server is used at the SRG when the phones are in local mode.

The Signaling Server supports en bloc signaling which is standard on the Signaling Server.

For more information about the Signaling Server, see *Signaling Server Installation and Commissioning (NN43001-312)*. For more information about H.323 and overlap signaling, see *IP Peer Networking Installation and Commissioning (NN43001-313)*.

Network Routing Services

- The Network Routing Service (NRS) application provides network-based routing, combining the following into a single application:

- **H.323 Gatekeeper**— provides central dialing plan management and routing for H.323-based endpoints and gateways.
- **SIP Redirect Server NRS** — provides central dialing plan management and routing for SIP-based endpoints and gateways. SIP Trunks are used for Voice packet traffic alone.
- **NRS Database**— stores the central dialing plan in XML format for the H.323 Gatekeeper, and the SIP Redirect Server. The H.323 Gatekeeper and the SIP Redirect Server accesses this common endpoint and gateway database.
- **Network Connect Server (NCS)** — used only for Media Gateway Controller (MGC) based MG 1000B, SRG, Geographic Redundancy, and Network-wide Virtual Office solutions. The NCS allows the Line TPS (LTPS) to query the NRS.
- **NRS Manager web interface**— the NRS provides its own web interface to configure the H.323 Gatekeeper, SIP Redirect Server, and the NCS.

The NRS application provides routing services to H.323 devices and SIP-compliant devices. The H.323 Gatekeeper can be configured to support H.323 routing services, while the SIP Redirect Server NRS can be configured to support SIP routing services. The H.323 Gatekeeper and the SIP Redirect Server NRS can reside on the same Signaling Server.

Each system in an IP Peer network must register to the NRS. The NRS software identifies the IP addresses of systems based on the network-wide numbering plan. NRS registration eliminates the need for manual configuration of IP addresses and numbering plan information at every site.

When configuring the NRS it is necessary to enable the NCS. Ensure that the check box "Network Connection Server enabled" is checked in the NRS configuration window of CS 1000 Element Manager.

For information about configuring the NRS, see *IP Peer Networking Installation and Commissioning (NN43001-313)*.

Supported IP Phones

Table 2 "IP Phone support " (page 16) shows the supported IP Phones for each software release.

Table 2
IP Phone support

| IP Phone | Release 1.0 | Release 2.0 | Release 3.0 |
|---------------|-------------|-------------|-------------|
| IP Phone 2001 | Supported | Supported | Supported |

| | | | |
|-----------------------------------|---------------|---------------|---------------|
| IP Phone 2002 | Supported | Supported | Supported |
| IP Phone 2004 | Supported | Supported | Supported |
| IP Phone 2007 | Supported | Supported | Supported |
| IP Audio Conference Phone 2033 | Supported | Supported | Supported |
| IP Softphone 2050 | Supported | Supported | Supported |
| IP Phone 1110 | Not supported | Not supported | Supported |
| IP Phone 1120E | Not supported | Supported | Supported |
| IP Phone 1140E | Not supported | Supported | Supported |
| IP Phone 1150E | Not supported | Not supported | Not supported |
| Mobile Voice Client (MVC) 2050 | Supported | Supported | Supported |
| Analog (500/2500-type) telephones | Supported | Supported | Supported |
| WLAN Handset 2210 | Supported | Supported | Supported |
| WLAN Handset 2211 | Supported | Supported | Supported |
| WLAN Handset 2212 | Not supported | Supported | Supported |
| WLAN Handset 6120 | Not supported | Not supported | Not supported |
| WLAN Handset 6140 | Not supported | Not supported | Not supported |

Throughout this document, the IP Phones are referred to collectively as IP Phones.

Main office requirements

The branch office running SRG Release 3.0 requires the following at the main office:

- CS 1000 hardware, running CS 1000 Release 4.0, CS 1000 Release 4.5, or CS 1000 Release 5.0 .
- Configure at least one of the following packages for IP Peer Networking:
 - H.323 Virtual Trunk (H323_VTRK) package 399
 - SIP Gateway and Converged Desktop Package (SIP) package 406
- The main office must have a software Service Level of 2 or higher to work with the branch office.
- Ensure that you have ordered enough IP user and Virtual Trunk licenses at the main office to support the SRG 50 or the capacity of your branch office.

The two different IP user licenses at the main office are:

- Basic IP License for the IP Phone 2001, IP Audio Conference Phone 2033, and IP Phone 1110

- IP User License for the IP Phone 2002, IP Phone 2004, IP Phone 2007, IP Phone 1120E, IP Phone 1140E, IP Softphone 2050, Mobile Voice Client (MVC) 2050, WLAN Handset 2210, WLAN Handset 2211, and WLAN Handset 2212

The main office requires the following software packages to support the specified Basic Network features. See *Basic Network Feature Fundamentals (NN43001-579)* for more information about these features.

- Network Call Back Queuing (MCBQ) package 38. This package is required for SRG IP Phones to invoke any queuing feature or ringback when free.
- Network Speed Call (NSC) package 39. This package is required for SRG IP Phones to invoke the Network Speed Call feature.

The main office requires the following software packages to support the specified ISDN Primary Rate Interface features. See *ISDN Primary Rate Interface Fundamentals (NN43001-569)* for more information about these features.

- Network Attendant Service (NAS) package 159. This package is required for analog (500/2500-type) telephones in the branch office to access attendant services when the attendant is configured on the main office.
- Network Message Services (NMS) package 175. This package is required for analog (500/2500-type) telephones in the branch office to share the voice mail system in the main office. For any configurations using centralized CallPilot on the main office with one or more branch offices in separate time zones, the NMS package is required at the main office for the branch IP Phones.

Optional features to enhance SRG functionality

- Network Alternate Route Selection (NARS) package 58. See *Basic Network Feature Fundamentals (NN43001-579)*.
- Overlap Signaling (OVL P) package 184. This package is optional; it is required for overlap signaling. It is packaged with H.323 Virtual Trunk (H323_VTRK) package 399.
- Emergency Services Access (ESA) package 329. This package is optional; it is required only to receive 911/ESA features in North American and some Caribbean and Latin American (CALA) markets. See *Emergency Services Access Fundamentals (NN43001-613)*.
- Virtual Office (VIRTUAL_OFFICE) package 382. This package is optional; it is required only for Virtual Office functionality.

- Network Signaling (NSIG) package 37. This package is optional for SRG IP Phones to access set-based Network Class of Service (NCOS) features.
- Adaptive Network Bandwidth Management package 407.
- Alternative Call Routing for Network Bandwidth Management.

For software and hardware requirements for SRG, see *SRG50 Configuration Guide (NN40140-500)*.

Normal Mode and Local Mode overview

Normal Mode and Local Mode overview provides a description of the following sections:

- Normal Mode
- Local Mode
- Survivability
- Recovery to Normal Mode
- Local Mode operation
- Virtual trunks

Normal Mode

IP Phones that are physically located at the SRG but are registered with the main office are operating in Normal Mode. In Normal Mode, the main office provides centralized call processing to all applications transparently to all IP Phones at the Branch Office. All IP Phones at the Branch, in Normal Mode, are registered to the main office TPS and are controlled by the Call Server at the main office.

Users of the SRG IP Phones receive the features, applications, key layout, and tones of the main office Call Server. This provides feature and application transparency between the branch office and the main office.

Local Mode

Users at the branch office may be in Local Mode, or survivable mode for two different reasons:

1. IP Phone has just booted up.
2. IP Phone cannot communicate to the main office because of a WAN failure or a failure of the main office components.

ATTENTION

When a telephone or trunk in the main office calls an SRG IP Phone that has switched to Local Mode due to WAN failure, the call is treated according to the main office call redirection configuration (such as forwarding to voice mail or continuous ringback).

In the event that the IP Phones at the branch office lose the connection to the main office CS 1000 call server for any reason (WAN failure, main office call server failure, main office Signaling Server failure), the SRG 50 reverts to Local Mode automatically. Essentially, when VoIP connectivity is lost, each IP Phone loses its Reliable UDP (RUDP) connection with the main office Terminal Proxy Server (TPS). The IP Phones at the branch office reboot and reregister to the SRG 50, placing them in Local Mode.

After this occurs, the IP Phones displays an indication on the display area that the set is in Local Mode of operation. This display is configurable by installers to meet local language and usage norms.

In Local Mode, the IP users connected at the branch office are under the control of the SRG 50 call services. As such, the normal main office call server features are not available. The SRG 50 offers a basic feature set when in Local Mode which allows IP Phones to continue to make and receive calls internally within the branch office and over the provisioned local PSTN interfaces. Basic services, such as transfer, last number redial, and single key access through the PSTN to a centralized voice messaging system are supported. Local PSTN access and local Emergency Services access is also supported. No local applications or Business Communication Manager features are supported in Local Mode operation.

Analog devices continue to be under the control of the SRG 50 system. It is the intent of Local Mode to provide continued access to the PSTN for critical calls and emergency services.

In Local Mode, since the SRG 50 handles all call processing, calls between two IP phones at the SRG 50 are handled locally as a simple station-to-station call. When an IP Phone initiates a local PSTN call, the SRG 50 routes the call to a trunk that is connected to the local PSTN. Incoming DID calls are also handled by the SRG 50 and terminated on the appropriate IP Phone.

In the event of a WAN failure, in Local Mode, the IP Phones do not have access to the main office network over the VoIP trunks. If the appropriate alternate routes are configured, calls will be routed to the main office or other branch offices using the available PSTN trunks.

While in Local Mode, the SRG 50 system continues to monitor for a main office CS 1000 heartbeat signal, and once detected, automatically redirects phones on an individual basis back to Normal Mode of operation. If a call is active, the SRG waits until the call is completed before redirecting the phones; calls in progress are not interrupted. This switch-over occurs almost immediately once the SRG determines that an individual phone can be redirected. This reinstates the CS 1000 normal user interface and feature set for the IP Phone user, on a user by user basis.

The SRG 50 system implements the same interface used by the MG 1000B system to interact with the main office CS 1000 system. This allows the main office to identify attached clients and the local PSTN as branch office entities, enabling proper operation of dial plans and E911 access.

In Local Mode, devices that are physically located at the branch office, that are controlled by the local system and receive a basic telephony feature set, provide business continuity for the branch office during the WAN or system failure. The SRG supports a main office heartbeat or reliable UDP signaling which automatically reregisters users once WAN or system failure has recovered.

For information about the features supported in Local Mode, see *SRG50 Configuration Guide (NN40140-500)*.

Survivability

SRG is specifically designed to provide automatic survivability against WAN failure, main office Call Server failure, main office Signaling Server failure, and Gatekeeper failure.

SRG supports the Geographic Redundancy feature. For further information about Geographic Redundancy, see *System Redundancy Fundamentals (NN43001-507)*.

In the event of a WAN failure, the SRG IP Phones lose communication with the main office. This causes the SRG IP Phones to reset and register with the SRG. The IP Phones then operate in Local Mode, providing basic telephony services delivered by the local SRG system. For further information about services and features supported on the SRG, see *SRG50 Configuration Guide (NN40140-500)*.

If the main office Call Server fails and call processing services are provided by an Alternate Call Server, the SRG IP Phones reset and reregister with the Alternate Call Server and receive call processing services from it. If no Alternate Call Server is available, the SRG IP Phones go to Local Mode while the SRG attempts to find an Alternate Call Server by way of the NCS.

If the main office Signaling Server fails and an Alternate Signaling Server is available, the SRG IP Phones reset and reregister with the SRG. The SRG will then query the NCS for the Alternate Signaling Server IP address. The SRG will redirect the IP Phone to the Alternate Signaling Server and continue to receive call processing services from the main office Call Server. If no Alternate Signaling Server is available, the SRG IP Phones reset and register with the SRG in Local Mode.

When an IP Phone at the SRG first boots up, the IP Phone attempts to communicate with the SRG. After communication with the SRG is established, the SRG redirects the IP Phone to the main office. When the SRG IP Phone attempts to register with the main office, the SRG first queries the Primary NCS for the main office Virtual Trunk node IP address to redirect the IP Phone. If the Primary NCS is down or unreachable, the SRG queries the Alternate NRS (H.323 Gatekeeper/SIP Redirect Server), if one is specified. If it receives a positive response, the SRG IP Phone is redirected to the specified main office. Otherwise, if neither a Primary or an Alternate NRS (H.323 Gatekeeper/SIP Redirect Server) is available, the SRG IP Phone remains in Local Mode, and receives call processing services from the SRG until communication can be reestablished.

SRG IP Phones in Normal Mode remain registered with the main office if the Primary NCS fails and no Alternate NCS is available. They can call any main office telephone or IP Phones in Normal Mode in other branch offices. However, they cannot call any SRG analog (500/2500-type) telephones or any external numbers through the SRG trunks because an H.323 Gatekeeper/SIP proxy server, which could route call properly in case of an NRS failure, is not available.

Recovery to Normal Mode

After communication is reestablished with the main office call server, all IP Phones at the branch office that are in Local Mode automatically redirect and reregister to the main office and return to Normal Mode operation. IP Phones that were busy at the time communication was reestablished complete the call in Local Mode, and then reregister with the main office after the call is complete.

Local Mode operation

When an SRG IP Phone is in Local Mode, the user has full access to the services configured at the SRG (analog devices or analog or digital trunks) and to other IP Phones registered to the SRG. In Local Mode, the IP Phones can make local calls to other IP Phones and other analog (500/2500-type) telephones at the branch office. They can also be used to make outgoing PSTN calls and receive incoming calls as usual. SRG IP Phones can access the main office IP Phones or other branches by routing through the local PSTN.

Testing the phone in Local Mode

From Normal Mode, the branch user has the option of going to Local Mode manually using the Test Local Mode feature, or when the telephone is power-cycled. The test can be performed by the user at any time and does not require a password. This test is invoked from any IP Phone at the branch office.

Nortel recommends testing Local Mode operation after changing the provisioning for a telephone on the SRG.

To ensure that users do not forget to resume Normal Mode operation, the SRG redirects the telephone to the main office to return the telephone to Normal mode. This occurs if the telephone remains registered to the SRG in Test Local Mode for ten minutes (default setting). Alternatively, the user can press the Quit key on the phone to return to Normal Mode.

For further information about Local Mode functionality for SRG, see *SRG50 Configuration Guide (NN40140-500)*.

Virtual Trunks

In order for endpoints in the CS 1000 network to access endpoints in local mode at the SRG or to access the PSTN at the SRG, Virtual Trunks are used over the LAN/WAN.

Virtual Trunks are software components that provide the trunking features of the Meridian Customer-Defined Network (MCDN) feature set. Access to PSTN digital or analog trunks at the branch office occurs through the MCDN Virtual Trunk.

Virtual Trunks are sometimes referred to as SIP or H.323 Virtual Trunks. In the *SRG50 Configuration Guide (NN40140-500)*, Virtual Trunks are referred to as IP Trunks.

For more information about Virtual Trunks, see *IP Peer Networking Installation and Commissioning (NN43001-313)*.

IP Phone calls

When an IP Phone calls another IP Phone, each telephone receives the address of the other to exchange media directly between the telephones. When in Normal Mode, an SRG IP Phone calling a main office IP Phone does not require any trunking to set up the call. However, LAN/WAN bandwidth is used to provide a media path for the call. For more information on Direct IP media path functionality, see *IP Peer Networking Installation and Commissioning (NN43001-313)*.

Bandwidth Management Overview

For a complete overview of Bandwidth Management, see the *Converging the Data Network with VoIP (NN43001-260)* and for details on configuration, see "[Bandwidth Management](#)" (page 95).

Network Bandwidth Management

Network Bandwidth Management allows for a limit to be placed on the amount of interzone bandwidth allowed between IP Phones in Normal Mode at the SRG and the rest of the CS 1000 network.

As well, it allows for the selection of interzone bandwidth codecs for calls between the IP Phones in Normal Mode and the rest of the CS 1000 network.

Adaptive Network Bandwidth Management

Adaptive Network Bandwidth Management allows the system to dynamically react to Quality of Service (QoS) degradation and take corrective action.

Network Bandwidth Management Zones

A zone is a collection of IP Phones that:

- share similar IP bandwidth restrictions
- are geographically close to one another
- are all in the same time zone
- are all in the same PSTN dialing plan

The Network Bandwidth Management Zone is made up of the VPNI and the zone. The VPNI of the main office and all the SRG associated with it must be the same.

Each SRG must have its own unique zone number and configured in the main office Call Server and the SRG.

ATTENTION

Throughout this document, the term zone is defined as a Bandwidth Management Zone, not an NRS (H.323 Gatekeeper) Zone. See "[Bandwidth Management](#)" (page 95).

Time of Day

Because the SRG IP Phones, in Normal Mode, receive their clock information from the main office, which may be located in a different time zone, the main office must be able to provide a different time of day for these phones.

The time zone of the SRG is configured with the SRG zone at the main office. The time zone adjusts the main office time for display at the SRG. SRG phones then display the correct time of the SRG, rather than that of the main office. For any configurations using centralized Call Pilot on the main office with one or more branch offices in separate time zones, the NMS package is required at the main office for the branch IP Phones.

SRG IP Phone to local PSTN calls

When an SRG IP Phone in Normal Mode dials a local PSTN number, the call is processed by the main office Call Server. The dialed digits are modified according to the dialing plan information configured in the zone for the SRG IP Phone.

The call is configured to be routed over the Virtual Trunk to the branch office. The SRG then tandems the call to the local PSTN. Likewise, long distance calls can also be configured.

If you use one Access Code for both local and long distance calls, and that Access Code is associated with a branch office zone, all calls (local and long distance) are routed through the SRG

IP Phone to analog (500/2500-type) telephone calls

When an IP Phone in Normal Mode at the SRG calls an analog (500/2500-type) telephone of the same SRG, the call is processed at the main office Call Server. A Virtual Trunk route is selected according to the digits dialed. The call is routed over a Virtual Trunk to the branch office. The SRG processes the incoming Virtual Trunk call and terminates it to the local analog (500/2500-type) telephone. Since this is a call between IP and circuit-switched devices, a DSP resource on a Media Card is allocated and connected to the analog (500/2500-type) telephone. The IP address of the DSP resource is returned to the main office Call Server so a direct media path between the IP Phone and the DSP resource can be set up when the call is established. See *IP Peer Networking Installation and Commissioning (NN43001-313)* for details.

Conference calls

When an SRG user initiates a conference call, the conference facilities of the main office are used. This means that in a conference among three SRG users, the LAN/WAN bandwidth of three media paths is used. The calls are controlled by the main office, except in Local Mode. In Local Mode, SRG users do not have access to conferencing.

Networking consideration

A fault condition can occur if IP Phones use a different route to the main office than that used by the SRG.

**CAUTION****Service Interruption**

If the network is planned so that IP Phones use a different route to the main office than that used by the SRG, a fault condition can occur. When the SRG can reach the main office but the IP Phone cannot ping the main office due to a network outage, an IP Phone registration can force the telephone into a cycle of registering locally, being redirected to the main office, rebooting, and then registering locally again. When this cycle occurs, further diagnose the network outage.

Capacity

Each CS 1000 main office can support up to 255 branch offices, which can be made up of any combination SRG and MGC based MG 1000B. SRG 50 Release 2.0 and later supports up to 80 survivable IP users. However, since all IP Phones register with the main office, the governing factor is the maximum number of IP Phones that can be supported at the main office. This means the total number of IP Phones in all offices can be no greater than the capacity of the main office. See one of the following documents to determine the total number of phones your system can support:

- *Communication Server 1000E Planning and Engineering (NN43041-220)*
- *Communication Server 1000M and Meridian 1 Large System Planning and Engineering (NN43021-220)*

Virtual Trunks capacity

The SRG capacity to support a number of simultaneous calls depends on the specific codec type used and the available bandwidth.

If both the intrazone and interzone codes are configured as Best Quality (G.711), the SRG supports up to 24 Virtual Trunks (H.323 or SIP), otherwise, only 15 Virtual Trunks (H.323 or SIP) are supported.

In Normal Mode, the codec selection used is controlled by specific programming of the CS 1000.

In Local Mode, if the WAN has failed, Virtual Trunks between the SRG and CS 1000 cannot be established. However, the SRG will continue to convert calls from IP terminals for communication through the PSTN. Nortel recommends you use G.711 codec.

Branch office dialing plan

Since IP Phone users can be located at a branch office equipped with an SRG, the routing of calls to the local gateway is important (especially when toll charges apply to calls made from the central Call Server that controls the telephone). The administrator can configure digit manipulation through zone attributes for IP Phones to select a main office or branch office that provides PSTN access local to the destination of the call.

Calls from the PSTN to users within the network can be routed with the various ESN numbering plan configurations.

To access local PSTN resources, outgoing calls can be routed using ESN as well as zone parameters that enable digit insertion. The zone parameters force calls made by an SRG user to be routed to the desired local PSTN facilities.

ATTENTION

Outgoing calls can include local and, optionally, long distance calls.

Nortel recommends that the Branch User ID (BUID) be the same at the branch office as the DN at the main office. A BUID has a maximum of 15 digits. Under the recommended Coordinated Dialing Plan (CDP), the BUID can be an extension (for example, 4567). Under the Uniform Dialing Plan (UDP), the BUID is the user main office DN, the Location Code (LOC), plus the Access Code (for example, 6 343-5555). The main office DN must be an ESN compliant DN. See "[ESN Access Codes](#)" (page 27).

The SRG only supports only one dialing plan option at a time. CDP and UDP dialing plan options cannot be configured at the same time in the same system.

For more information about dialing plans and configuration, see "[Dialing Plan configuration](#)" (page 43). For more information about the branch office dialing plan, see *CS 1000 Main Office Configuration for SRG50 (NN43001-307)*.

ESN Access Codes

ESN data is configured with two Access Codes, called AC1 and AC2. AC1 normally applies to long distance calls, whether placed on or off the customer's private network (for example, dialing 6). AC2 normally applies to local calls (for example, 9). For more information, see *Electronic Switched Network Reference—Signaling and Transmission (NN43001-280)*.

Music on Hold

For SRG users in Normal Mode, the main office provides music to the user if Music on Hold is provisioned. The use of the G.729A/AB codec between the main office and the branch office can impact the music quality.

ATTENTION

G.723 codec is not supported on SRG 50.

Branch office and SRG 50 terminology

Table 3 "Branch office and SRG 50 terminology" (page 28) lists configuration-related terms and contexts where branch office and SRG 50 terminology differ.

Table 3
Branch office and SRG 50 terminology

| Term or context | Branch office | SRG 50 |
|---|---|--|
| dialing plan | on-net/off-net dialing | Private/Public network dialing |
| routing | distant steering codes (DSC), Trunk steering codes (TSC), Local steering codes (LSC) | call routing, destination codes, line pool access codes |
| | Digit manipulation table | dial-out digits (routing) |
| alternate routing selection | Facility Restriction Level (FRL) | scheduled call routing |
| Type of number | CDP/UDP/TNDN | CDP/UDP/no equivalent |
| Numbering Plan ID | ISDN/Telephony (E.164), Private, Telephony (E.163), Telex, (F.69), Data (X.121), National Standard | Private |
| User ID | BUID | BUID |
| | bandwidth management zone | Zone ID |
| Trunks | public exchange | PSTN |
| | virtual trunk | IP trunk |
| access codes (SRG 50: destination codes) | 7 = system trunk access | 7 = not assigned |
| | 8 = Basic Alternate Route Selection (BARS)/Network Alternate Route Selection (NARS) | 8 = not assigned |
| | 9 = public exchange access | 9 = line pool A access code |

| Term or context | Branch office | SRG 50 |
|---|---------------------------------------|--------|
| telephone numbers (internal, not PSTN) | Network Class of Service (NCOS) DN | DN |

Limitations

The following is a list of limitations for SRG 50 Release 3.0:

- When an IP Phone is in Local Mode, the SRG 50 does not provide all the features as those provided by the CS 1000 main office. In Local Mode, the SRG provides basic features, basic call handling, and basic routing capabilities only.
- When an IP Phone is in Local Mode, the SRG 50 does not support IP Phone Key Expansion Module or Expansion Module for IP Phone 1100 Series.
- You cannot configure the BUID and MOTN using the IP Phone. Configure the BUID and MOTN using SRG Element Manager.
- The SRG and the CS 1000 are configured separately. There is no single management paradigm or application to update both the CS 1000 and the SRG. Use Element Manager to configure the SRG, and use standard configuration tools to configure the CS 1000.
- Virtual Office Login is not supported in Local Mode.
- Language, Volume, and Contrast settings in the SRG are not synchronized with the CS 1000 settings which causes a potential mismatch in settings between Normal Mode and Local Mode.
- Language options available on the CS 1000 may not be available on the SRG.
- For the CS 1000 Release 5.0 Alternate Routing for Network Bandwidth Management feature, the SRG does not support an automatic redirection of IP trunk calls through the PSTN when such calls are blocked by the CS 1000 due to bandwidth availability.
- Multiple ESDN is not supported.
- VLAN tagging is not supported. However, VLAN tagging is achieved by using an external router.
- Active Call Failover is not supported.
- SIP trunks are used only for voice packet traffic alone. H.323 trunking is used for main office and Gatekeeper/NRS discovery, polling of WAN link, as well as voice traffic.

Setting up the main office

Contents

This section contains the following topics:

- "Introduction" (page 31)
- "SRG information required by the main office" (page 31)
- "Main office information required by the SRG" (page 32)
- "Zone parameters" (page 34)
- "Branch office IP Phone configuration at the main office" (page 38)
- "SIP IP Trunks configuration at the main office" (page 40)

Introduction

This section describes the following information required to configure the main office:

- SRG information required by the main office
- Main office information required by the SRG
- Zone parameters
- IP Phone passwords and parameters
- Branch office IP Phone configuration

For more information on main office configuration, see *IP Peer Networking Installation and Commissioning (NN43001-313)*.

SRG information required by the main office

The main office administrator must gather information about the SRG system. The following information is required:

- an inventory of IP Phones that will be installed on the SRG so the administrator knows what type of telephone to assign to each main office terminal record

- information which allows the administrator to create an NCS (H.323 Gatekeeper or SIP Redirect Server) entry for the SRG
- if using advanced routing, such as tandem dialing between systems, local PSTN number for the SRG and the internal SRG routing codes that will allow the main office to connect to the SRG and to tandem over the SRG PSTN lines, is required

Use [Table 4 "SRG information required for the main office configuration" \(page 32\)](#) to record the information before setting up the SRG on the main office server.

Table 4
SRG information required for the main office configuration

| | |
|--|--|
| SRG parameters | |
| SRG public IP address | |
| H.323 ID (required for requests to NCS) Each H.323 ID in the node should match SIP endpoint name for this system in pure SIP environment. | |
| List of types and number of IP Phones Telephone types are hard-coded to the Terminal Numbers (TN) and the main office. Therefore, install the same type of IP Phones to the coordinating record on the SRG. | |
| PSTN number to dial into the SRG (in local mode) | |
| Destination codes (steering codes) to route the main office calls to the SRG and out through the SRG PSTN lines | |
| IP Ports that affect SRG traffic with the main office and have been assigned firewall filters For further information on port configuration, see <i>Converging the Data Network with VoIP (NN43001-260)</i> or <i>SRG50 Configuration Guide (NN40140-500)</i> . | |

Main office information required by the SRG

The main office administrator must supply numerous main office settings to the SRG installer so that the SRG can be efficiently configured. In addition, the main office administrator needs to supply the following information:

- a list of the terminal record numbers (TN)
- a list of BUID (Prime DN)
- if using advanced routing, such as tandem dialing between systems, main office routing (steering) codes, are required

Use Table 5 "Main office interoperation information" (page 33) to record main office information required by the SRG.

Table 5
Main office interoperation information

| Main office components | Information about this system |
|--|-------------------------------|
| Main office IP network information: | |
| Main office call server type | S1000 (default) |
| Primary network connect server address | |
| Alternate network connect server | |
| Network Connect server port | |
| Trunk/telephony preferred codecs and jitter buffers listed in order of preference | |
| NRS (H.323 Gatekeeper/SIP Redirect Server) requirements | |
| Indicate if the SRG needs to manually assign ports with firewall filters. | |
| Telephony programming: | |
| DN length, DN (TN) range | |
| Numbering plan ID | Private (default) |
| Type of number SRG 50 only supports CDP and UDP dialing plans. Nortel recommends that the SRG use CDP. The SRG supports only one dialing plan option at a time. CDP and UDP dialing plan options cannot be configured at the same time in the same system. | |
| Node ID When the SRG is down the phones use S2 settings to register with the main office. | |
| Virtual Private Network ID (VPNI) | |
| Zone ID and dialing string information requirements | |
| Main office dial-up number (for PSTN calls to the main office in Local Mode) | |
| Access code to reach the main office PSTN through VoIP trunks | |

| Main office components | Information about this system |
|---|-------------------------------|
| Zone dialing: <ul style="list-style-type: none"> ZDP appended to SRG IP Phone PSTN dialing strings to redirect the call to SRG PSTN Any steering codes (destination codes) that must be mirrored by SRG programming | |
| IP Phone configuration: | |
| MOTN/BUID list, including which type of IP Phone is assigned to each number. Make note of the leading number, as SRG uses this as the DN range for CDP dialing. If the DCP access code is more than one digit, the second digit number must also be used to further define the DN range. | |
| Current IP Phone firmware version | |
| Is a VLAN configured on the network? | |

Zone parameters

Zone parameters must be configured at both the main office Call Server and the SRG. The main office procedure is similar to an IP Peer Network configuration with the branch office-specific configuration outlined in this chapter.

Zone parameters are defined at the main office in LD 117 and are applied to IP Phones in LD 11.

Use [Procedure 1 "Configuring ESN and SRG zones"](#) (page 34) to configure ESN and SRG zones.

Procedure 1

Configuring ESN and SRG zones

| Step | Action |
|--|--|
| <p>ATTENTION</p> <p>Before and after an upgrade, perform a data dump (using LD 43 EDD or through Element Manager) on the Call Serve or on the MGC to back up existing data.</p> | |
| 1 | Configure the Home Location Code (HLOC) and the Virtual Private Network Identifier (VPNI). |

Table 6
Configure Customer Data Home Location Code and Virtual Private Network Identifier

| Prompt | Response | Description |
|--------|-------------|--|
| REQ: | CHG | Changing existing data |
| TYPE: | NET | ISDN and ESN Networking options |
| CUST | | Customer number |
| | 0-99 | Range for Large Systems |
| ... | ... | ... |
| CLID | YES | Allow Calling Line Identification option |
| -ENTRY | xx | CLID entry to be configured |
| --HLOC | 100-9999999 | Home Location code (ESN) (3-7 digits) |
| ISDN | YES | Integrated Services Digital Network |
| -VPNI | (0)-16383 | Virtual Private Network Identifier for Bandwidth Management feature X = Disables feature 1-16383 = Enables feature <cr> = No Change |

- 2** Configure the zone properties for IP Telephony bandwidth management. Use LD 117 or Element Manager. See *IP Peer Networking Installation and Commissioning (NN43001-313)*.

The branch office zone number and zone bandwidth management parameters at the main office must match the corresponding branch office zone number and zone bandwidth management parameters at the branch office.

ATTENTION

Zone 0, the default zone, must not be configured as a branch office zone. Network Bandwidth Management does not support zone 0. If zone 0 is configured as an branch office zone, the Bandwidth Management feature is not activated.

- 3** Define the zone parameters for the branch office. Use LD 117 or Element Manager. See *IP Peer Networking Installation and Commissioning (NN43001-313)*.

LD 117 Define zone parameters for the branch office

| Command | Description |
|--------------------------|-------------|
| CHG ZBRN <Zone> <yes no> | |

| Command | Description |
|--|--|
| | Define a zone as a branch office zone. |
| CHG ZDST <Zone> <yes no> <StartMonth> <StartWeek> <StartDay> <StartHour> <EndMonth> <EndWeek> <EndDay> <EndHour> | If the branch office observes Daylight Savings Time (DST), these parameters specify the start and end of DST. During DST, the clock automatically advances one hour forward. |
| CHG ZTDF <Zone> <TimeDifferencefromMainOffice> | Specified in minutes, the time difference between main office and branch office when both are not in DST. |
| CHG ZDES <Zone> <ZoneDescription> | A name to render data display more meaningful. |

- 4 Enable the features for the branch office zone in LD 11.

LD 117 Enable features for an SRG zone

| Command | Description |
|--------------------|--|
| ENL ZBR <zone> ALL | Enables features for branch office <zone>. |

—End—

Configuring zone parameters using CS 1000 Element Manager

Use Element Manager to configure the branch office specific zone properties and time difference.

1. Select **IP Network > Zones** in Element Manager navigator.

The Zones window opens. See [Figure 2 "Zone List web page" \(page 36\)](#). The zone list is the main window used for zone configuration.

Figure 2
Zone List web page

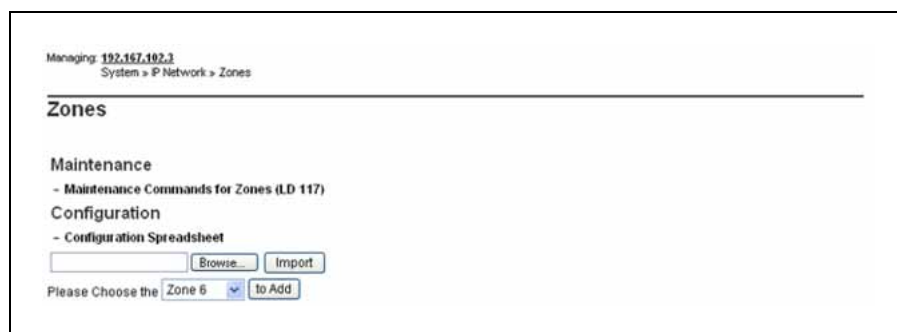

2. Select the zone to be configured and configure the following properties.
 - Basic Property and Bandwidth Management (see [Figure 3 "Zone Basic Property and Bandwidth Management web page"](#) (page 37))
 - Time Difference and Daylight Saving Time Property (see [Figure 4 "Zone Time Difference and Time web page"](#) (page 38))

Figure 3
Zone Basic Property and Bandwidth Management web page

Managing: 192.167.192.1
System > IP Network > Zones > Zone 0 > Zone Basic Property and Bandwidth Management

Zone Basic Property and Bandwidth Management

| Input Description | Input Value |
|----------------------------------|-------------------|
| Zone Number (ZONE): | 0 |
| Intrazone Bandwidth (INTRA_BW): | 1000000 |
| Intrazone Strategy (INTRA_STGY): | Best Quality (BQ) |
| Interzone Bandwidth (INTER_BW): | 1000000 |
| Interzone Strategy (INTER_STGY): | Best Quality (BQ) |
| Resource Type (RES_TYPE): | Shared (SHARED) |
| Zone Intent (ZBRN): | MO (MO) |
| Description (ZDES): | |

Figure 4
Zone Time Difference and Time web page

Managing: 192.167.192.3
 System > IP Network > Zones > Zone 1 > Time Difference and Daylight Saving Time

Time Difference and Daylight Saving Time

Time Difference Property

| Input Description | Input Value |
|------------------------------|-------------|
| Time Difference (TIME_DIFF): | 0 |

Daylight Saving Time Property

| Input Description | Input Value |
|--|--------------------------|
| Zone Number (ZONE): | 1 |
| Use Daylight Saving Time (USE_DST): | <input type="checkbox"/> |
| Active Status of Daylight Saving Time (DST_ACT): | No |
| Start Month (START_MON): | January |
| Start Week (START_WEEK): | 1 |
| Start Day (START_DAY): | Sunday |
| Start Hour (START_HOUR): | 1 |
| End Month (END_MON): | January |
| End Week (END_WEEK): | 1 |
| End Day (END_DAY): | Sunday |
| End Hour (END_HOUR): | 1 |

Submit Refresh Cancel

Zone parameters must be configured on the main office and the branch office. For information on configuring zones, see "[Bandwidth Management](#)" (page 95).

Branch office IP Phone configuration at the main office

After the branch office zones and passwords are provisioned, provision the branch office IP Phones at the main office. These can be provisioned using Telephony Manager 3.1. See "[Branch office IP Phone configuration using Telephony Manager 3.1](#)" (page 38) or LD 11. See Procedure 2 "[Configuring branch office IP Phones at the main office using LD 11](#)" (page 39).

ATTENTION

There is no automatic data synchronization between the main office Call Server and SRG. The technician must provision the telephone on both the Call Server and the SRG.

Branch office IP Phone configuration using Telephony Manager 3.1

At the main office, Telephony Manager 3.1 can be used to configure branch office IP Phones. Use Telephone Pages to configure the telephones to include the following:

- Terminal Type
- TN

- Customer Number
- Branch Office Zone
- Prime DN corresponding to the BUID

See *Telephony Manager 3.1 System Administration (NN43050-601)* for details.

Branch office IP Phone configuration using LD 11

Use [Procedure 2 "Configuring branch office IP Phones at the main office using LD 11" \(page 39\)](#) at the main office to configure branch office IP Phones.

Procedure 2

Configuring branch office IP Phones at the main office using LD 11

| Step | Action |
|------|--------|
|------|--------|

- | | |
|---|---|
| 1 | Configure the branch office zones and dialing plan. See Procedure 1 "Configuring ESN and SRG zones" (page 34) . |
| 2 | Configure the following telephone data in LD 11: <ul style="list-style-type: none"> • Terminal type • Customer Number • TN • Zone • Prime DN to correspond to BUID |

LD 11 Provision Branch User and SCPW at the main office

| Prompt | Response | Description |
|--------|----------|--|
| REQ: | NEW CHG | Add new data, or change existing data. |
| TYPE: | a...a | Terminal type. Type ? for a list of possible responses. |
| CUST | xx | Customer number as defined in LD 15. |
| ZONE | 0-255 | Zone number to which the IP Phone belongs. The zone prompt applies only when the TYPE is 2001P2, 2002P1, 2002P2, 2004P1, 2004P2, 2050PC, 2007, 1110, 1120, 1140, 2210, 2211, 2212 Zone number is not checked against LD 117. |

| Prompt | Response | Description |
|--------|----------|--|
| ... | ... | ... |
| SCPW | xxxxx | Station Control Password Must equal Station Control Password Length (SCPL) as defined in LD 15. Not prompted if SCPL = 0. Precede with X to delete. |

—End—

SIP IP Trunks configuration at the main office

In order for the SRG 50 to act as a SIP endpoint and to use the SIP Trunks for call signaling with the CS 1000, you must configure SIP Trunks between the SRG 50 branch office and the CS 1000 Release 5.5 main office.

Configuring SIP IP Trunks

| Step | Action |
|------|---|
| 1 | From the Element Manager navigator, click IP Network > Nodes: Servers, Media Cards . The Node Configuration window appears. |
| 2 | Click the Edit button associated with the node to be updated. |
| 3 | Click the plus (+) sign beside Signaling Server Properties. |
| 4 | From the Enable IP Peer Gateway (Virtual Trunks TPS) list, select SIP only . |
| 5 | Enter the CS 1000 domain name in the SIP Domain Name field. |
| 6 | Enter the SIP Port number in the Local SIP TCP UDP Port to Listen to field. |
| 7 | Enter the Signaling Server name in the SIP Gateway Endpoint Name field. See Figure 5 "SIP Trunk configuration in Element Manager" (page 41). |

Figure 5
SIP Trunk configuration in Element Manager

- 8 Click **Save and Transfer**.
The Save and Transfer window appears.
- 9 Click **OK**.
- 10 Log on to Network Routing Service (NRS) Manager.
- 11 Select the **Configuration** tab.
- 12 From the H.323 Support list, select **H.323 not supported**.
- 13 Select the **Network Connection Server enabled** check box. See [Figure 6 "SIP Trunk configuration in NRS"](#) (page 41).

Figure 6
SIP Trunk configuration in NRS

- 14 Select **Save**.
- 15 Select **Configuration > Gateway Endpoints**.

The Gateways Endpoints window appears.

The SRG registers as a static SIP endpoint. See Figure 7 "Gateways Endpoints window in NRS" (page 42).

Figure 7
Gateways Endpoints window in NRS

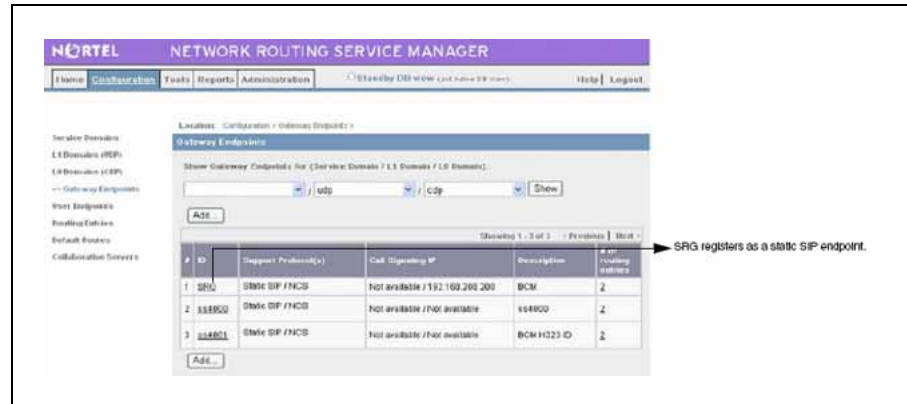

—End—

Dialing Plan configuration

Contents

This section contains the following topics:

- "Overview" (page 43)
- "On-net dialing plan" (page 43)
- "Off-net dialing plan" (page 45)
- "Routing calls" (page 45)
- "SIP/H.323 zones" (page 45)
- "Zone-based digit manipulation" (page 46)
- "Configuring the dialing plan for PSTN access to SRG users in Normal Mode" (page 48)
- "Dialing plan examples" (page 65)

Overview

This section provides an overview of dialing plan programming on the SRG and the main office.

When a number is dialed, the Call Server determines whether the called number is internal or external to the branch office. If internal or off-net, the system terminates the call on the appropriate terminal. If external or on-net, the system routes the call using one of the supported dialing plans.

On-net dialing plan

The SRG only supports only one dialing plan option at a time. CDP and UDP dialing plan options cannot be configured at the same time in the same system.

The SRG supports the following dialing plans:

- Coordinated Dialing Plan (CDP) – BUID is the same as the Directory Number (DN)

- Uniform Dialing Plan (UDP) – Location code is added to the DN for the BUID

ATTENTION

Nortel recommends that the SRG use CDP.

CDP Terminal Numbers (TN) can be activated on the other systems if the user moves and wants to retain their phone number. SRG does not support Transferable Directory Numbers (TNDN) due to differences in dialing plans and the small range of DN available on the SRG.

For specific examples for CDP and UDP dialing plans, see "[Dialing plan examples](#)" (page 65).

Once the call is sent over the IP network, the call is routed to the SRG, which uses the NRS (H.323 Gatekeeper/SIP Redirect Server) to route the call. The NRS (H.323 Gatekeeper/SIP Redirect Server) translates the address form a telephone number to an IP address, and authorizes the call.

Specific dialing plan configuration is required for IP Phones to properly select a main office or a branch office that provides access to the PSTN for the originating IP Phone. A common configuration might be:

- SRG users select the SRG PSTN for local calls.
- Main office users select the main office PSTN for local calls.
- All users select either the main office or SRG PSTN for long-distance calls to minimize toll charges.
- calls configured to minimize toll charges.

However, this configuration represents only one way that the dialing plan could be configured. PSTN calls can be routed according to the point of origin (main office or branch office) and/or the desired destination, and can select trunks at the main office, branch office, or other branch offices as required. Therefore, the user can route calls to gateways that minimize long-distance costs, minimize bandwidth usage, or meet other criteria.

Nortel recommends that customers use Coordinated Dialing Plan (CDP) between the main office and its branch offices since it enables all users, at the main office or the branch office, to call each other using just an extension number. CDP enables consistent dialing between the main office and SRG IP Phones and devices.

For more information, see *Dialing Plans Reference (NN43001-283)*.

Off-net dialing plan

When dialing to the PSTN, the Call Server determines that the call destination is off-net by analyzing the digits that must be preconfigured at major Call Servers in the network.

If routed over a Virtual Trunk, a request is sent to the NRS to determine the location of public E.164 numbers. The NRS is configured with a list of potential alternate routes that can be used to reach a certain dialed number. Each route is configured with a unique route cost to determine the least-cost route.

The NRS replies with the address information for E.164 numbers. It also provides a list of alternative SIP or H.323 endpoints, sorted by cost. If a terminating endpoint resource is busy when a call attempt is made, the originating endpoint tries the next alternative. If no alternative is available over the IP network, the originating endpoint steps to the next entry on its route list, which could be a TIE or PSTN alternate route.

Routing calls

SRG user call to an SRG PSTN

The SRG user telephone is registered at the main office. The SRG user telephones are physically located at the branch office, so routing of local PSTN calls back to the branch office is essential, even if they are registered with the main office.

Branch office behavior of the SRG user telephones at the main office is configured by setting branch office zone characteristics through LD 117 at the main office.

SRG PSTN to an SRG telephone (DID call)

If the DN is valid and can terminate, call termination at the branch office is treated differently for IP Phones and non-IP Phones, as follows:

- IP Phones—If the telephone is registered to the SRG (Local Mode), the call is terminated locally. If the telephone is not registered to the SRG (Normal Mode), the call is routed through a Virtual Trunk to the main office.
- Non-IP Phones—Calls are terminated locally (within the branch office).

SIP/H.323 zones

In a SIP/H.323 network, each NRS controls one SIP/H.323 zone. Each zone can consist of many SIP/H.323 endpoints. If a call terminates beyond the call originator zone, the SIP Redirect Server or H.323 Gatekeeper of the called party zone provides the endpoint information to set up the connection.

It is possible to divide a system into several zones. It is also possible to divide a customer within a system into different zones. It is more common to assign one zone to one system and one customer.

Zone-based digit manipulation

For SRG users in Normal Mode, it may be desirable to provide routing that is different from that provided to main office users. For example, it may be desirable to route certain calls directly to the SRG PSTN trunk, rather than receive the same routing as non-SRG users in the main office.

To achieve this, the Zone Access Code Behavior (ZACB) and Zone Digit Prefix (ZDP) properties of the branch office zone are used to add digits to the digits dialed by the SRG user. The resulting digit string is then used to route the call. The net effect of this is that an SRG user's and a main office user's call can be routed differently, even though the dialed digits were the same.

For example, if 1 87654321 is dialed, where 1 is the Access Code, then:

- for a main office user, the call is routed based on the dialed digits.
- for an SRG user, the digits undergo zone-based digit manipulation (such as inserting 101), and the call is routed based on the new manipulated digit string (in this example 1 101 87654321).

By performing this zone-based digit manipulation, calls from main office users and SRG users undergo different routing. Some applications are:

- routing all SRG user calls to the SRG PSTN trunk
- routing SRG user local calls to the SRG PSTN trunk
- routing all SRG user calls to the main office PSTN trunk
- routing SRG user long-distance calls to the main office PSTN trunk

Special considerations apply in the case where a single Access Code is used for both on-net and off-net calls, especially when UDP is used. Routing of on-net and off-net calls is normally different. The Call Server ESN Special Number provisioning and Gatekeeper Numbering Plan Entry provisioning should be used to provide this different routing.

In the case where a single Access Code is not shared, that is, where one Access Code is exclusively used for UDP on-net dialing, standard procedures should be used. See *Dialing Plans Reference (NN43001-283)*.

For a given branch office, there may be more than one zone defined at the main office. Therefore, different SRG users may receive different routing treatments.

The combination of zone-based digit manipulation and CS 1000 routing capabilities can be used to achieve many other routing outcomes for SRG user calls.

Calling Line ID composition

Digital manipulation is commonly used for digit insertion and deletion. It is also used for call type conversion before out-pulsing the digits to the Virtual Trunk.

The IP Special Number (ISPN) parameter in the ESN data block ensures the Calling Line ID (CLID) is formed correctly when a call-type is converted from its original type (such as International, National, or SPN) to CDP/UDP/SPN format. Conversion to CDP/UDP/SPN format ensures that the call-type stays in the Private/Special Number domain.

The ISPN parameter is configured in LD 86. By default, it is set to NO.

If ISPN is NO, the CLID is formed based on the CTYP parameter of the DMI data block, and INST digits are inserted.

If ISPN is YES, the CLID is formed based on the call-type before digit manipulation. INST digits are inserted, and the CLID is considered an IP Special Number. The call-type before digit manipulation is determined as follows:

- If the call-type before digit manipulation is SPN (Special Number), it is converted to a value corresponding to the CLTP parameter in the Special Number Translations data block, as shown in [Table 7 "Mapping between from CLTP parameter in SPN block to call-type before digit manipulation"](#) (page 47).

Table 7

Mapping between from CLTP parameter in SPN block to call-type before digit manipulation

| CLTP parameter | Call-type before digit manipulation |
|----------------|-------------------------------------|
| LOCL | Local PSTN |
| NATL | National PSTN |
| INTL | International PSTN |

- If the call-type before digit manipulation is not SPN (Special Number), it is not changed.

CLID verification

Use the CLIDVER prompt in LD 20 to verify that the CLID has been properly composed and configured. This command simulates a call, without actually making the call, and generates a report of the properties of the call.

Configuring the dialing plan for PSTN access to SRG users in Normal Mode

Preparing to configure the dialing plan

Before configuring the dialing plan for PSTN access to SRG users in Normal Mode, you must complete the following steps:

- At the main office, configure the Virtual Trunk to enable calls originating on SRG IP Phones in Normal Mode to reach the branch office. See *IP Peer Networking Installation and Commissioning (NN43001-313)* for details.
- At the main office, configure trunks for access to the PSTN.
- At the branch office, configure the Virtual Trunk to enable calls originating on SRG IP Phones in Normal Mode to reach the branch office. See *IP Peer Networking Installation and Commissioning (NN43001-313)* for details.
- At the branch office, configure trunks for access to the PSTN.
- At the main office, configure the branch office zone properties in LD 117, excluding the ZACB and ZDP properties. See *IP Peer Networking Installation and Commissioning (NN43001-313)* for details.
- At the main office, configure the routing for PSTN access.
- At the branch office, configure the routing to enable calls made from TDM or IP Phones in Local Mode to access the PSTN.
- Configure IP Phones with the same zone number at both the main office and the branch office. Nortel also recommends that the Prime DN be the same at both the main and the branch offices. If different DN are configured, the dial-in numbers change when the branch office is in Local Mode.
- Assign unique individual DN as Branch User Identities (BUID) to Automatic Call Distribution (ACD) telephones.

Configuring the dialing plan

The steps to configure the dialing plan for SRG PSTN access are:

- At the main office—see [Procedure 3 "Configuring the main office" \(page 49\)](#).
 1. Configure the ZACB property for the branch office zone.
 2. Configure the ZDP property for the branch office zone.
 3. Configure the Route List Index.
 4. Configure the ESN Special Number and Digit Manipulation.

- Configure the NRS—see [Procedure 4 "Configuring the NRS database" \(page 57\)](#).
 1. Access NRS Manager.
 2. Select an endpoint.
 3. Configure the Numbering Plan Entry for the branch office.
- At the branch office—see [Procedure 5 "Configuring the branch office" \(page 60\)](#).
 1. Configure the Route List Index.
 2. Configure ESN.

These steps can be done using overlays, as described in this section, or in Element Manager and NRS Manager. See *IP Peer Networking Installation and Commissioning (NN43001-313)* for more details.

Procedure 3 Configuring the main office

| Step | Action |
|------|--------|
|------|--------|

- | | |
|---|---|
| 1 | Configure the ZACB property for the branch office zone. |
|---|---|

LD 117 Define the zone Access Code handling for the branch office zone

| Command | Description |
|--|--|
| CHG ZACB <zone> [ALL][<AC1 AC2> <AC1 AC2>] | Define the Access Codes used to modify local or long-distance calls in the branch office to force all branch office calls to be routed to the MG 1000B PSTN. |

The ZACB and ZDP properties are used to configure the digit manipulation behavior of the branch office zone (see step 2).

The ZACB property specifies which calls undergo digit manipulation. The attribute can be configured in the following ways:

- CHG ZACB <zone>

In this configuration, dialing AC1 or AC2 does not trigger digit manipulation. SRG user calls are treated exactly the same as those for main office users.
- CHG ZACB <zone> ALL

In this configuration, calls dialed with AC1 and calls dialed with AC2 undergo zone-based digit manipulation. All SRG user calls can then be routed to the SRG PSTN.

For example, assume that AC1 = 1, AC2 = 2, and ZDP = 101. If an SRG user dials 1 87654321, ZDP is inserted in the dialed digits to form a digit string of 1 101 87654321. If an SRG user dials 2 87654321, ZDP is inserted in the dialed digits to form a digit string of 2 101 87654321.

- CHG ZACB <zone> AC1 AC2

In this configuration, only calls dialed with AC1 undergo zone-based digit manipulation. All SRG user calls dialed with AC1 can then be routed to the SRG PSTN.

For example, assume that AC1 = 1, AC2 = 2, and ZDP = 101. If an SRG user dials 1 87654321, ZDP is inserted in the dialed digits to form a digit string of 2 101 87654321. If an SRG user dials 2 87654321, zone-based digit manipulation does not occur and the digit string remains unchanged.

- CHG ZACB <zone> AC2 AC2

In this configuration, only calls dialed with AC2 undergo zone-based digit manipulation. All SRG user calls dialed with AC2 can then be routed to the SRG PSTN.

For example, assume that AC1 = 1, AC2 = 2, and ZDP = 101. If an SRG user dials 1 87654321, zone-based digit manipulation does not occur and the digit string remains unchanged. If an SRG user dials 2 87654321, ZDP is inserted in the dialed digits to form a digit string of 2 101 87654321.

As part of the ZACB configuration, you can also change the dialed Access Code, so if you dial AC2 it can be changed to AC1, or vice versa. This provides more flexibility in the main office NARS configurations. Normally, you do not need to change the Access Code.

The Access Code dialed by the user is used internally by the Call Server. It is not sent as part of the outpulsed digits (to the NRS or to the trunks).

If a specified Access Code is used for both local and long-distance dialing, then both types of calls will receive the specified routing.

- 2 Configure the ZDB property for the branch office zone in the main office. See *IP Peer Networking Installation and Commissioning (NN43001-313)*.

LD 117 Define the zone digit manipulation for the branch office zone at the main office

| Command | Description |
|---|--|
| CHG ZDP <zone> <DialingCode1> <DialingCode2> <DialingCode3> | Define the dialing plan for the branch office zone, where DialingCode1, DialingCode2, and DialingCode3 are inserted into the dialed digits between the Access Code and the remainder of the dialed number. |

The ZDP and ZACB (step 1) properties are used to configure the digit manipulation behavior of the branch office zone.

The ZDP property is inserted between the Access Code specified in the ZACB command and the dialed digits. This zone-based digit manipulation allows the main office Call Server and the network NRS to distinguish the SRG user calls from the main office user calls, and route them accordingly. The digit manipulation occurs before any digit processing in the main office Call Server or NRS.

ATTENTION

If DialingCode1, DialingCode2, or DialingCode3 are already present in the dialed digits, then they will not be re-inserted.

Nortel recommends that the ZDP attribute for each branch office zone be set to a unique non-dialable number within the dialing plan (for example 1019 or 999). This unique non-dialable number can then be used, when configuring the main office ESN Special Number (step 4 of [Procedure 3 "Configuring the main office" \(page 49\)](#)) and the NRS (H.323 Gatekeeper) ([Procedure 4 "Configuring the NRS database" \(page 57\)](#)), to route the calls to the branch office for connection to the local PSTN.

For example, assume AC1 = 1, AC2 = 2, ZACB = AC1 AC1, and ZDP = 101.

If an branch office user dials 1 87654321, zone digit manipulation occurs because AC1 was dialed and ZACB = AC1 AC1. ZDP is inserted in the dialed digits to form a digit string of 1 101 87654321. The call is routed differently than with the digits 1 87654321. ESN configuration at the main office Call Server (step 4) routes the call to the NRS because it recognizes 101 87654321 after the Access Code rather than 87654321. The Access Code (1) is not included in the digit string that is sent to the NRS. The NRS recognizes 101 at the front of the digit string and routes the call to the destination SRG. At the branch office, the ESN Special Number is configured (step 2) to remove 101 from the digit string and route the call based on the digits 87654321.

Nortel recommends that the ZDP attribute for each branch office zone be set to a unique non-dialable number within the dialing plan (for example 1019 or 999). This unique non-dialable number can then be used, when configuring the main office ESN Special Number (step 4 of [Procedure 3 "Configuring the main office" \(page 49\)](#)) and the NRS (H.323 Gatekeeper/SIP Redirect Server) ([Procedure 4 "Configuring the NRS database" \(page 57\)](#)), to route the calls to the branch office for connection to the local PSTN.

For example, assume AC1 = 1, AC2 = 2, ZACB = AC1 AC1, and ZDP = 101.

If an branch office user dials 1 87654321, zone digit manipulation occurs because AC1 was dialed and ZACB = AC1 AC1. ZDP is inserted in the dialed digits to form a digit string of 1 101 87654321. The call is routed differently than with the digits 1 87654321. ESN configuration at the main office Call Server (step 4) routes the call to the NRS because it recognizes 101 87654321 after the Access Code rather than 87654321. The Access Code (1) is not included in the digit string that is sent to the NRS. The NRS recognizes 101 at the front of the digit string and routes the call to the destination SRG. At the branch office, the ESN Special Number is configured (step 2) to remove 101 from the digit string and route the call based on the digits 87654321.

If an branch office user dials 2 87654321, zone-based digit manipulation does not occur because AC2 was dialed and ZACB = AC1 AC1. The digit string remains unchanged 2 101 87654321. The main office routes the call using ESN configuration and the dialed digits.

3 Configure the Route List Index at the main office.

After configuring zone-based digit manipulation, a specialized route for the call must be configured. To select a trunk to route calls, a Route List Index (RLI) must be configured in the Route List Block (RLB). The RLI uses the route number for the Virtual Trunk to route calls to the NRS. A Digit Manipulation Index (DMI) is associated with the RLI to allow manipulation of the digits to be outpulsed. For this application, at the main office, the DMI is used to update the call type of the off-net calls to the Special Number (SPN) to make sure the number stays in the Private/Special Number domain.

- a. Configure the DMI in LD 86 with the DGT feature.

LD 86 Configure the Digit Manipulation Index at the main office

| Prompt | Response | Description |
|--------|----------|---------------|
| REQ | NEW | Add new data. |

| Prompt | Response | Description |
|-------------|----------|---|
| CUST | xx | Customer number as defined in LD 15. |
| FEAT | DGT | Digit manipulation data block |
| DMI | 1-999 | Digit Manipulation Index numbers The maximum number of Digit Manipulation tables is defined at the MXDM prompt in LD 86. |
| DEL | (0) -19 | Number of leading digits to be deleted, usually 0 at the main office. |
| INST | x...x | Insert. Up to 31 leading digits can be inserted, usually none at the main office. Default is none. |
| ISPN | (YES) | IP Special Number For off-net calls |
| | NO | For on-net calls |
| CTYP | | Call type to be used by the call. This call type must be recognized by the NRS and far-end switch. This is critical for correct CLID behavior. If ISPN=NO, the CLID is based on this field. If ISPN=YES, the CLID is based on the call type before digit manipulation. |
| | SPN | For off-net calls (ISPN=YES) |
| | LOC | For on-net calls (ISPN=NO) |

b. Configure the RLI in LD 86 with the RLB feature.

LD 86 Configure Route List Index.

| Prompt | Response | Description |
|-------------|----------|--|
| REQ | NEW | Add new data. |
| CUST | xx | Customer number as defined in LD 15. |
| FEAT | RLB | Route List data block |
| RLI | | Route List Index to be accessed |
| | 0-127 | CDP and BARS |
| | 0-255 | NARS |
| | 0-999 | FNP |
| ENTR | 0-63 | Entry number for NARS/BARS Route List |
| | X | Precede with x to remove |
| LTER | NO | Local Termination entry |
| ROUT | | Route number of the Virtual Trunk as provisioned in LD 16. |

| Prompt | Response | Description |
|------------|----------|---|
| | 0-511 | Range for Large Systems |
| | 0-127 | Range for MG 1000B |
| ... | | |
| DMI | 1-999 | Digit Manipulation Index number as defined in LD 86, FEAT = DGT (see step a). |

For example, assume that the Virtual Trunk is on route 10, and the Customer number is 0:

```
>LD 86
REQ NEW
CUST 0
FEAT DGT
DMI 10
DEL
INST
ISPN YES
CTYP NATL
REQ NEW
CUST 0
FEAT RLB
RLI 10
ENTR 0
LTER NO
ROUT 10
...
DMI
...
```

4 Configure ESN Special Number and Digit Manipulation.

LD 90 Configure ESN Special Number and Digit Manipulation

| Prompt | Response | Description |
|-------------|----------|-------------------------------------|
| REQ | NEW | Add new data. |
| CUST | xx | Customer number as defined in LD 15 |
| FEAT | NET | Network translation tables |
| TRAN | | Translator |
| | AC1 | Access Code 1 (NARS/BARS) |
| | AC2 | Access Code 2 (NARS) |
| TYPE | SPN | Special code translation data block |

| Prompt | Response | Description |
|---------------|----------|--|
| SPN | x...x | Special Number translation Enter the SPN digits in groups of 3 or 4 digits, separated by a space (for example, xxxx xxx xxxx). The SPN can be up to 19 digits long. The maximum number of groups allowed is 5. |
| FLEN | (0) -24 | Flexible Length The number of digits the system expects to receive before accessing a trunk and outpulsing these digits. |
| ... | | |
| - RLI | 0-999 | Route List Index configured in LD 86 (see step 3) |
| - CLTP | | Type of call that is defined by the special number. |
| | LOCL | Local PSTN |
| | NATL | National PSTN |
| | INTL | International PSTN |

—End—

After configuring the zone-based digit manipulation (step 1 and step 2) and specialized route (step 3), the route must be associated with the ESN Special Number. The main office ESN Special Number configuration is based on new digits inserted by zone-based digit manipulation. The digits are processed based on the Access Code, AC1 or AC2, that was dialed.

For off-net calls the following should be considered:

- If all calls that have undergone Zone-based digit manipulation are to be routed by the NRS, one SPN must be provisioned for each call type to route calls to the NRS based on the ZDP.
- If some calls are to be routed by the NRS, and others by the main office Call Server, multiple SPN should be provisioned to route calls based on the ZDP value and one or more dialed digits. Each SPN can then use a different RLI if required.

For example, assume ZDP = 101. It is possible to provision multiple SPN (1011, 1012, 1013, 1014, 1015, 1016, 1017, 1018, 1019, and 1010) to route calls based on the ZDP value plus the first dialed digit. However, it may not be necessary to provision all SPN combinations. For example, if calls dialed with a first digit of 3 after the Access Code are invalid, then SPN 1013 does not need to be provisioned.

- Be careful when choosing how many dialed digits to include in the SPN. If one of the dialed digits is included in the SPN (that is, ZDP + one dialed digit), a maximum of ten SPN must be configured for each branch office. Similarly if two dialed digits are included in the SPN (ZDP + two dialed digits), a maximum of 100 SPN must be configured for each branch office. For each additional dialed digit included in the SPN, the maximum number of SPN that must be provisioned for each branch office is increased by a factor of ten.

If a single Access Code that undergoes Zone-based digit manipulation is used for both on-net and off-net calls, then separate DMI and SPN must be provisioned to correctly route these calls. The SPN must correctly identify the routing to be used, and its CLTP field must set the call type correctly. A DMI, associated with this SPN, is used to make sure the number stays in the Private/Special Number domain.

ESN Special Numbers are configured in LD 90. Respond to the prompts as follows:

- TRAN — Enter the Access Code.
- TYPE — Enter SPN for this configuration, as the ZDP value configured in step 3 is usually a unique non-dialable number.
- SPN — Enter the ZDP value plus enough digits to distinguish the type of number, such as national, international, or local. There must be enough SPN entries to route all valid dialed numbers (see the example in this section).
- FLEN — Enter the number of digits that are expected for the call type.
- RLI — Enter the RLI configured in LD 86 in step b. The RLI routes the call to the NRS with the correct type of number.
- CLTP — Enter the type of call defined by this Special Number: local (LOCL), national (NATL), or international (INTL).
- For example, assume the following:

AC1 = 1, ZACB = AC1 AC1, and ZDP = 101

Customer number = 0

Long-distance calls start with 1, have 11 digits, and use RLI = 10 and DMI = 10.

Local calls start with 5 or 6, are seven digits long, and use RLI = 30 and DMI = 30.

ATTENTION

RLI and DMI values do not have to be the same, but for clarity, it may be useful to set them the same.

```

>LD 90
REQ NEW
CUST 0
FEAT NET
TRAN AC1
TYPE SPN
SPN 1011
FLEN 14          11 digits for long-distance + 3 digits for ZDP

...
RLI 10
CLTP NATL

...
SPN 1015
FLEN 10          7 digits for long-distance + 3 digits for ZDP

...
RLI 30
CLTP LOCL

...
SPN 1016
FLEN 10          7 digits for long-distance + 3 digits for ZDP

RLI 30
CLTP LOCL

...

```

After configuring main office routing to the NRS, the NRS database must be provisioned to identify the desired endpoint for the calls. This procedure configures the NRS database with the inserted digits specified by the zone-based digit manipulation configuration.

Instead of configuring the NRS database, you can configure a route in the main office to directly route the call (see step 4).

This procedure provides information specific to the configuration of the NRS database for this application. See *IP Peer Networking Installation and Commissioning (NN43001-313)* for complete details on configuring the NRS.

Procedure 4 Configuring the NRS database

| Step | Action |
|------|--|
| 1 | Click the Configuration tab in NRS. |
| 2 | Click set Standby DB view to work in the standby (inactive) database. |
| 3 | Select Routing entries from the navigation menu on the left-hand side of the Network Routing Service window. |

The **Routing Entries** window opens, as shown in Figure 8 "NRS Routing Entries window with no endpoint selected" (page 58).

Figure 8
NRS Routing Entries window with no endpoint selected

- 4 Choose the appropriate Service Domain, L1 Domain, and L0 Domain from the corresponding drop-down menus.
- 5 Click on **Look up** to open a window with a lookup path for gateway endpoints.
- 6 Click **Search** to display a list of gateway endpoints (see Figure 9 "NRS Lookup path for gateway endpoints" (page 58)), and click on the endpoint at the branch office.

The **Routing Entries** window then displays a list of routing entries corresponding to that endpoint, if any. See Figure 10 "NRS Routing Entries window for selected endpoint" (page 59).

Figure 9
NRS Lookup path for gateway endpoints

| # | ID [Click to select] | Support Protocol(s) | Description | # of routing entries | # of default routes |
|---|----------------------------|---------------------|---------------------|----------------------|---------------------|
| 1 | srgGWsite1 | RAS H.323 | This is a Gatew . . | 2 | 0 |
| 2 | srgGWsite2 | RAS H.323 | This is a SRG G . . | 0 | 0 |

Figure 10
NRS Routing Entries window for selected endpoint

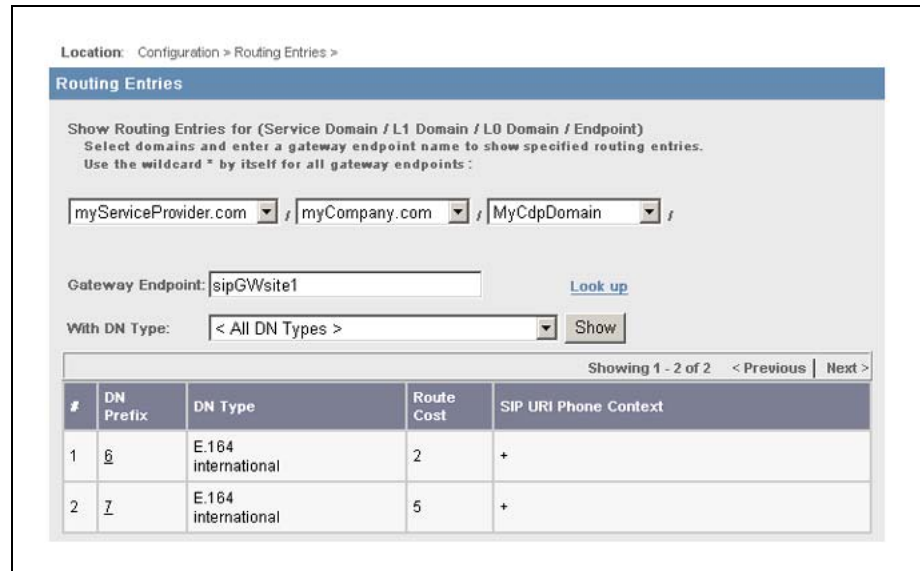

- Click **Add** in the **Routing Entries** window to add a routing entry. The Add Routing Entry window opens, as shown in [Figure 11 "Add Routing Entry"](#) (page 59).

Figure 11
Add Routing Entry



- Configure the numbering plan entries for the branch office. This is usually set to the unique non-dialable number that identifies the branch office, as configured in the ZDP property of the branch office zone in LD 117 at the main office (see step 2).

The type of number configured in the NRS should be set to match the type of number as configured in the main office.

If some calls are to be routed differently from others, it is possible to provision the multiple Numbering Plan Entries in the NRS to achieve this.

For example, if ZDP = 101, it is possible to provision multiple Numbering Plan Entries (101, 1011, and so on) to route calls based on the ZDP value or the ZDP value plus some of the dialed digits.

Unlike on the Call Server, if the ZDP plus additional digits are used to identify routing it is not necessary to provision all of the combinations. For example, if calls with digit strings starting with 1011 are to be routed differently from those starting with 101x (where x is a digit other than 1), then only 101 and 1011 need to be provisioned as numbering plan entries on the NRS.

—End—

Procedure 5 Configuring the branch office

| Step | Action |
|------|--------|
|------|--------|

- | | |
|---|--|
| 1 | Configure the Route List Index at the branch office. |
|---|--|

After the call arrives at the branch office, a route must be provisioned to handle the call. In order to be able to select a trunk to route calls, a Route List Index (RLI) must be configured in the Route List Block (RLB). The RLI uses the route number for PSTN trunk to route calls to the PSTN. A Digit Manipulation Index (DMI) can be associated with the RLI to allow manipulation of the digits to be outpulsed. For this application, the DMI is used to remove the ZDP digits that were inserted in the dialed digits at the main office. The DMI is also used to convert the call type back correctly according to the incoming SPN pattern.

- a. Configure the DMI in LD 86 with the DGT feature.

LD 86 Configure Digit Manipulation Index at the branch office

| Prompt | Response | Description |
|--------|----------|--|
| REQ | NEW | Add new data. |
| CUST | xx | Customer number as defined in LD 15 |
| FEAT | DGT | Digit manipulation data block |
| DMI | 1-999 | Digit Manipulation Index numbers The maximum number of Digit Manipulation tables is defined by prompt MXDM in LD 86. |
| DEL | (0) -19 | Number of leading digits to be deleted. This would normally be configured to remove the unique non-dialable number that identifies the branch office, configured in the ZDP property of the branch office zone in LD 117 at the main office (step 2). |

| Prompt | Response | Description |
|--------|----------|---|
| ISPN | NO | IP Special Number |
| INST | x...x | Insert. Up to 31 leading digits can be inserted. |
| CTYP | | Call type used by the call. The far-end switch must recognize this call type. |
| | INTL | International |
| | NPA | National |
| | NXX | UDP |
| | LOC | Local PSTN |
| | SPN | Special Number |

b. Configure the RLI in LD 86 with the RLB feature.

LD 86 Configure Route List Index

| Prompt | Response | Description |
|--------|----------|---|
| REQ | NEW | Add new data. |
| CUST | xx | Customer number as defined in LD 15 |
| FEAT | RLB | Route List data block |
| RLI | | Route List Index to be accessed |
| | 0-127 | CDP and BARS |
| | 0-255 | NARS |
| | 0-999 | FNP |
| ENTR | 0-63 | Entry number for NARS/BARS Route List |
| | X | Precede with x to remove. |
| LTER | NO | Local Termination entry |
| ROUT | | Route number of the Virtual Trunk as provisioned in LD 16. |
| | 0-511 | Range for Large Systems |
| | 0-127 | Range for MB 1000B |
| ... | | |
| DMI | 1-999 | Digit Manipulation Index number as defined in LD 86, FEAT = DGT (step a). |

For example, assume that the PSTN trunk is on route 18 and the Customer number = 0.

```
>LD 86
REQ NEW
CUST 0
FEAT DGT
DMI 18
DEL 3
```

Set to remove ZDP added in the main office

```
INST
CTYP LOC
REQ NEW
CUST 0
FEAT RLB
RLI 18
ENTR 0
LTER NO
ROUT 18
...
DMI 18
...
```

Set according to associated SPN pattern

2 Configure ESN Special Number and Digit Manipulation.

LD 90 Configure ESN Special Number and Digit Manipulation

| Prompt | Response | Description |
|---------------|----------|---|
| REQ | NEW | Add new data. |
| CUST | xx | Customer number as defined in LD 15. |
| FEAT | NET | Network translation tables |
| TRAN | | Translator – Access Code 1 (NARS/BARS) |
| | | Because the call is incoming to the branch office, AC1 is triggered if INAC = YES in the Route Data Block for the Virtual Trunk in LD 16 and the INTL call type is associated with AC1 in NET_DATA of the Customer Data Block in LD 15. |
| | AC1 | |
| TYPE | SPN | Special code translation data block |
| | x...x | Special Number translation |
| | | Enter the SPN digits in groups of 3 or 4 digits, separated by a space (for example, xxxx xxx xxxx). The SPN can be up to 19 digits long. |
| | | The maximum number of groups allowed is 5. |
| - FLEN | (0) -24 | Flexible Length |
| | | The number of digits the system expects to receive before accessing a trunk and outpulsing these digits. |

| Prompt | Response | Description |
|--------|----------|---|
| ... | | |
| - RLI | 0-999 | Route List Index configured in LD 86 (see step 1) |

After configuring the specialized route for calls that have been routed to the branch office by the NRS, the route must be associated with the ESN Special Number.

The branch office receives the manipulated number as an incoming call, indicating that the ZDP value added at the main office is at the beginning of the number. The branch office ESN configuration must ensure that the extra digits (the ZDP value) are deleted by using a proper DMI. The call then terminates at the PSTN connection.

ATTENTION

The DMI configured in LD 86 in step 1 is used to remove the digits that were inserted in the dialed number at the main office.

For example, assume ZDP at the main office = 101, Customer number = 0, and the RLI for the PSTN trunk = 18.

```
LD > 90
REQ NEW
CUST 0
FEAT NET
TRAN AC1
TYPE SPN
SPN 1011
FLEN 0
...
RLI 18
```

—End—

Configuring the dialing plan using CS 1000 Element Manager

From Element Manager, configure the branch office-specific zone dialing plan and Access Codes. From the navigator, select **IP Network > Zones**. From the **Zones** window in Element Manager, select the **Branch Office Dialing Plan and Access Codes** option, and enter the necessary information. See [Figure 12 "Zone Dialing Plan and Access Codes"](#) (page 64).

Figure 12
Zone Dialing Plan and Access Codes

| Input Description | Input Value |
|-------------------------------------|-------------------------|
| Zone Number (ZONE): | <input type="text"/> |
| Prefix (ACB_DC1): | <input type="text"/> |
| Country Code/Trunk Code (ACB_DC2): | <input type="text"/> |
| Destination Network Code (ACB_DC3): | <input type="text"/> |
| Dialed Access Code (ACB_LOC_AC): | No Access Code (NONE) ▼ |
| New Access Code (ACB_LD_AC): | No Access Code (NONE) ▼ |

Submit Refresh Cancel

Testing PSTN access using an SRG IP Phone

Use [Procedure 6 "Testing PSTN access using an SRG IP Phone"](#) (page 64) to test that PSTN access is working correctly.

Procedure 6

Testing PSTN access using an SRG IP Phone

| Step | Action |
|------|--------|
|------|--------|

| | |
|---|-------------------------------------|
| 1 | From an SRG IP Phone in Local Mode: |
|---|-------------------------------------|

- a. Make a local PSTN call.
- b. Make a long-distance call.

The calls must be routed according to the branch office ESN configuration.

| | |
|---|--------------------------------------|
| 2 | From an SRG IP Phone in Normal Mode: |
|---|--------------------------------------|

- a. Make a call to the local PSTN.
- b. Make a long-distance call.

—End—

The calls must be routed according to the ESN configuration that was configured in [Procedure 3 "Configuring the main office"](#) (page 49).

For calls that tandem over the Virtual Trunk to the branch office and go out to the PSTN trunk(s) in the branch office, the following configuration problems can occur:

- The call can receive overflow tones. Use L D 96 to view the digits sent to the Virtual Trunk (ENL MSGO {dch#}).
- If the digits look correct at the main office, the NRS might not be properly configured. If the NRS rejects the call, a diagnostic message is displayed on the Signaling Server console.
- If the call makes it to the correct branch office (check that it is not going to the wrong node if the NRS is configured incorrectly) the branch office is probably rejecting it because it does not know the digit string. Use LD 96 to view the digits (ENL MSGI {dch#}).

Dialing plan examples

This section describes the following dialing plans:

- Coordinated Dialing Plan (CDP)
- Uniform Dialing Plan (UDP)

Coordinated Dialing Plan

The following section provides three options for creating a CDP dialing configuration.

Overview

Dialing plans between the SRG and the main office need to be coordinated to ensure seamless dialing between the systems. The option you choose will determine how the user dials the other system or the SRG IP telephones.

- Option 1: DN ranges in the main office and SRG are unique, and DNs for SRG IP Phones are the same in both Normal and Local mode. This is the recommended configuration to support seamless dialing on both systems. See ["Option 1" \(page 70\)](#).
- Option 2: DN ranges in the main office and SRG overlap, and DNs for SRG IP Phones are the same in both Normal and Local mode. See ["Option 2" \(page 75\)](#).
- Option 3: DN of SRG IP Phones and DN in the main office overlap in Normal Mode, but are unique in Local Mode. See ["Option 3" \(page 81\)](#).

Call scenarios

Call scenarios fall into the following categories:

- Common call scenarios occur in all CDP calls, regardless of which option is used.
- Unique call scenarios occur only within certain CDP options.

This section describes the common call scenarios. The unique call scenarios are described with the configuration of the corresponding option, starting with "Option 1" (page 70).

Normal Mode: Main office telephone calls an analog phone at the SRG The call is routed through the NRS and handled by the SRG. Figure 13 "Normal Mode: Main office telephone calls an analog phone at the SRG" (page 66) shows how the call proceeds.

Figure 13
Normal Mode: Main office telephone calls an analog phone at the SRG

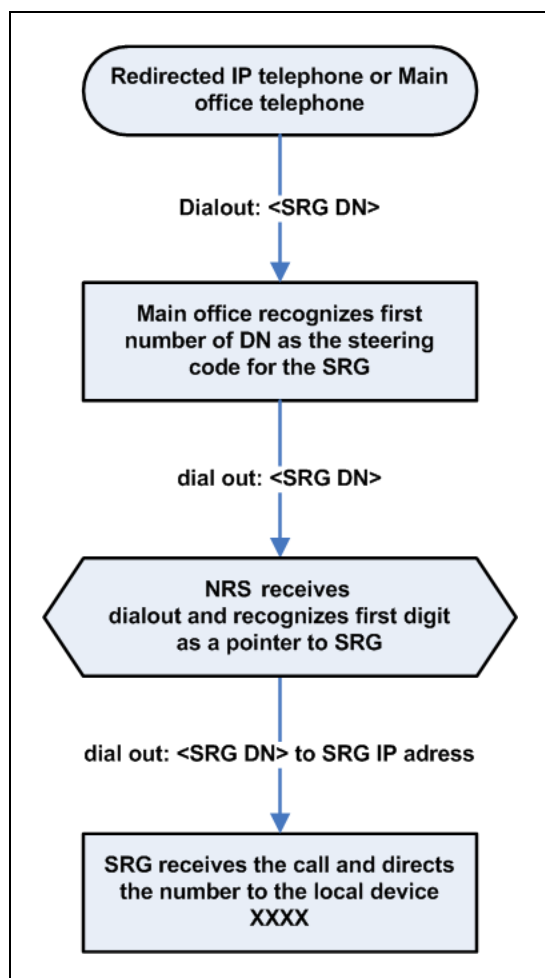

Normal Mode: Main office telephone calls a branch IP Phone The call is recognized as a main office number, and the call is directed to the SRG IP telephone using internal routing at the main office.

Normal Mode: Main office telephone makes a call over the PSTN through the SRG Routing is configured so the destination code of the PSTN through the SRG is at the start of the dialing string. Figure 14 "Normal Mode: Main office telephone makes a call over the PSTN through the SRG" (page 67) shows how the call proceeds.

Figure 14
Normal Mode: Main office telephone makes a call over the PSTN through the SRG

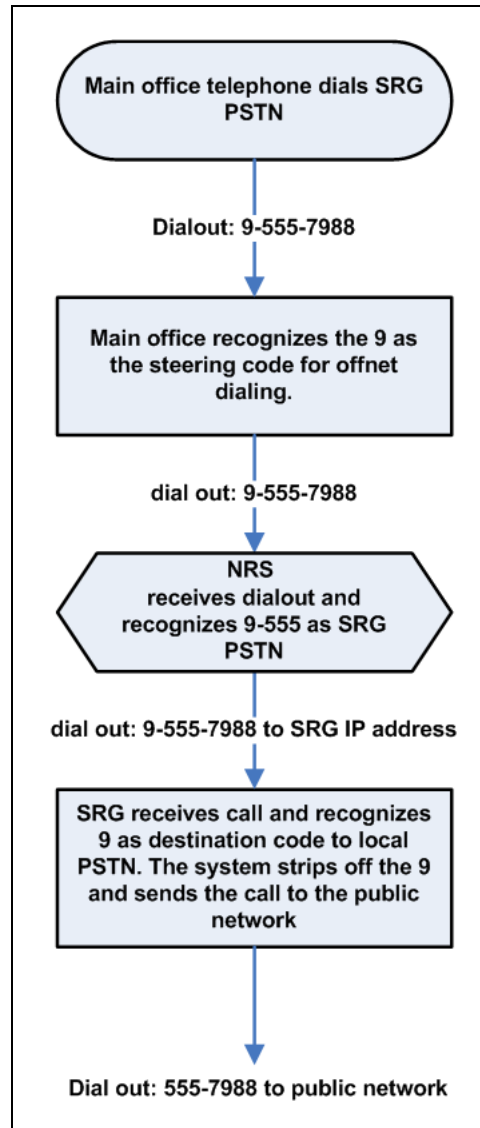

Normal Mode: SRG IP Phone makes a call over the PSTN Zone management at the main office recognizes that an SRG IP Phone in Normal Mode is dialing the PSTN. Figure 15 "Normal Mode: SRG IP Phone makes a call over the PSTN" (page 68) shows how the call proceeds.

Figure 15
Normal Mode: SRG IP Phone makes a call over the PSTN

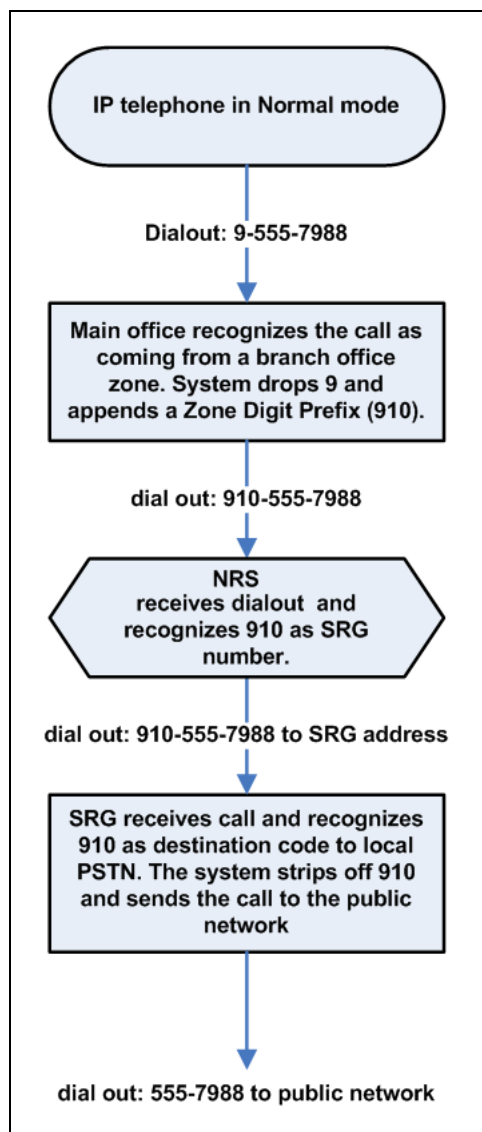

A telephone registered to the SRG calls another telephone registered to the SRG The SRG routes the call internally.

Local Mode: SRG telephone calls an SRG IP Phone The call is handled by the SRG and is sent directly to the SRG IP Phone.

Local Mode: SRG telephone calls a main office telephone In this case, the WAN or NRS is not accessible. [Figure 16 "Local Mode: SRG telephone calls a main office telephone" \(page 69\)](#) shows how the call proceeds.

The user must have configured the fallback route appropriately. See the *SRG50 Configuration Guide (NN40140-500)* for further information.

Figure 16
Local Mode: SRG telephone calls a main office telephone

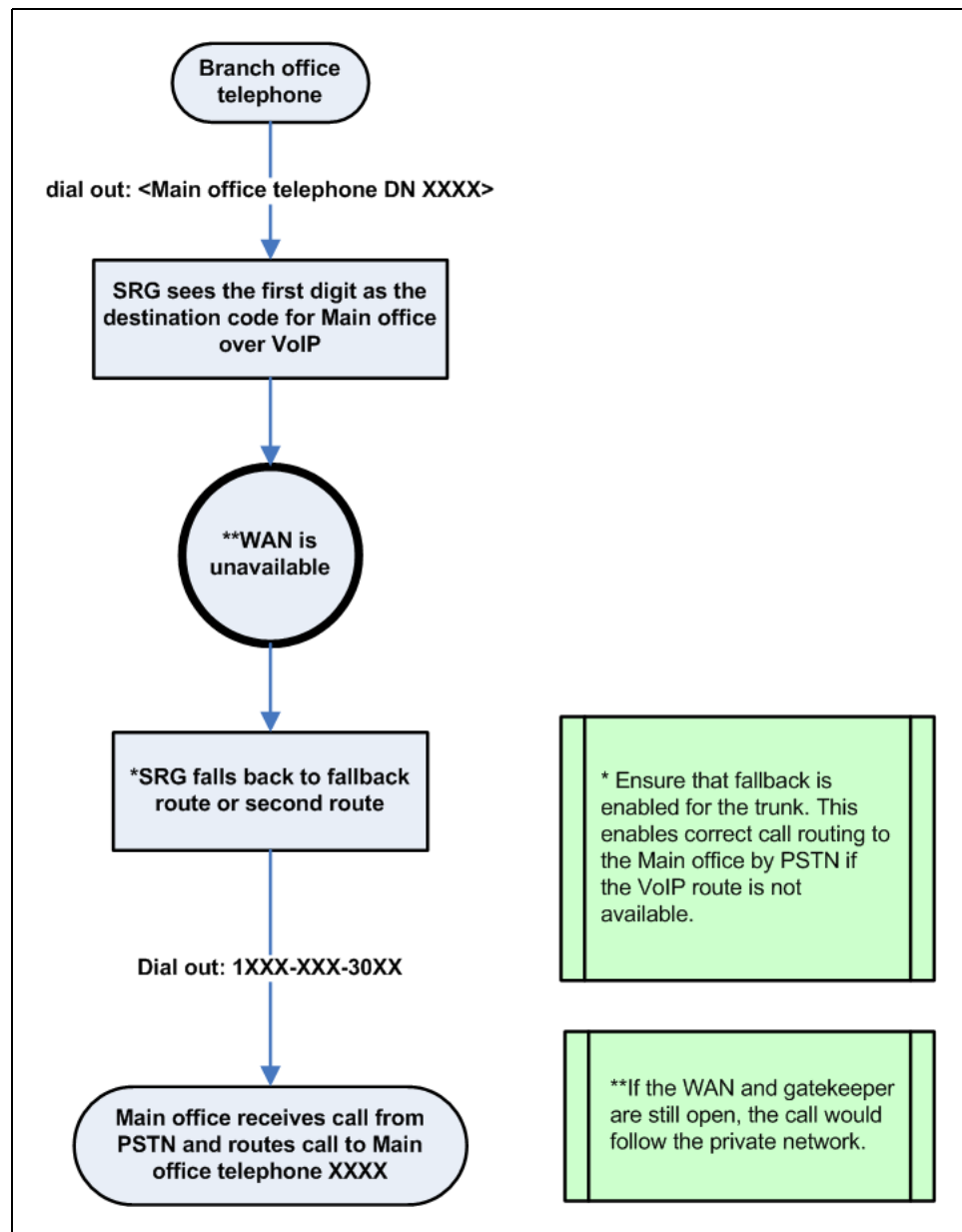

Local Mode: Main office telephone calls an SRG IP Phone The call is treated according to main office redirection configuration, such as forwarding to voice mail or continuous ringback.

Option 1**DN ranges in the main office and SRG are unique; DNs for SRG IP Phone are the same in Normal and Local Mode**

This is the recommended CDP configuration to offer seamless dialing.

In this configuration, the user dials the same DN for SRG IP Phones in either Normal or Local Mode. The DN for SRG IP Phones are configured to be the same on both the SRG and main office. This allows seamless dialing from both the SRG and main office. However, in this configuration, the DN range for telephones registered at the SRG is unique from the DN range for telephones registered at the main office.

The advantage of this configuration is that the system manages the routing for the SRG IP Phones, so users in the SRG and main office do not have to be aware of whether the SRG is in Normal Mode.

See [Figure 17 "CDP Option 1" \(page 70\)](#).

Figure 17
CDP Option 1

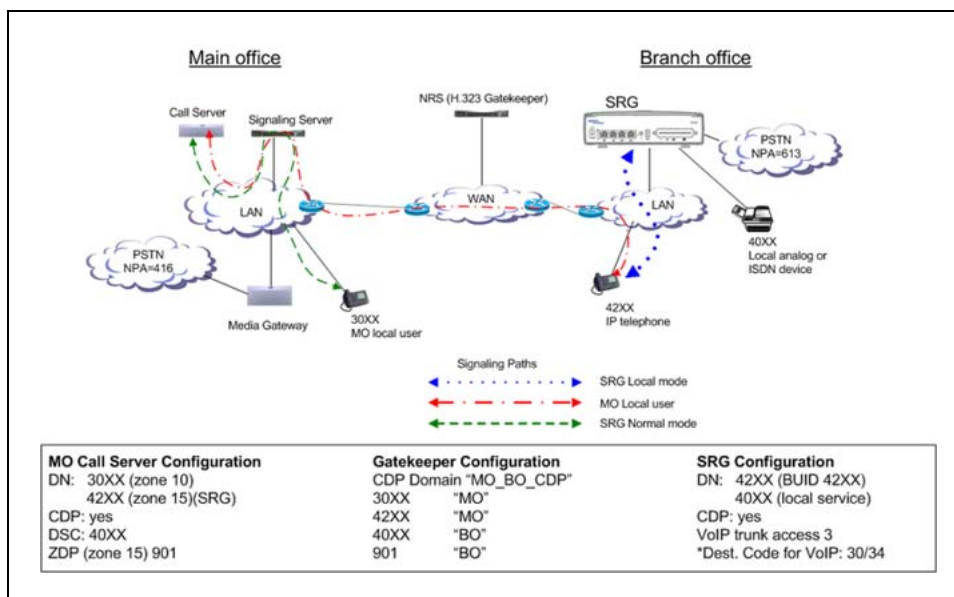

Call scenarios Common call scenarios for this CDP option are listed in ["Call scenarios" \(page 65\)](#). The following additional call scenarios are unique to this CDP option:

- An SRG analog telephone registered to the SRG calls a telephone registered at the main office that can also be an SRG IP Phone in Normal Mode.

Figure 18 "Calls to an SRG IP Phone and a main office IP Phone registered to the main office " (page 72) shows the WAN is up. An SRG analog phone calls an SRG IP Phone and a main office IP Phone registered to the main office (Normal Mode).

Figure 19 "Calls to an SRG analog phone, SRG IP Phone, and a main office IP Phone " (page 73) shows the WAN is down. An SRG analog phone calls an SRG IP Phone and a main office IP Phone registered to the SRG (Local Mode).

Figure 18
Calls to an SRG IP Phone and a main office IP Phone registered to the main office

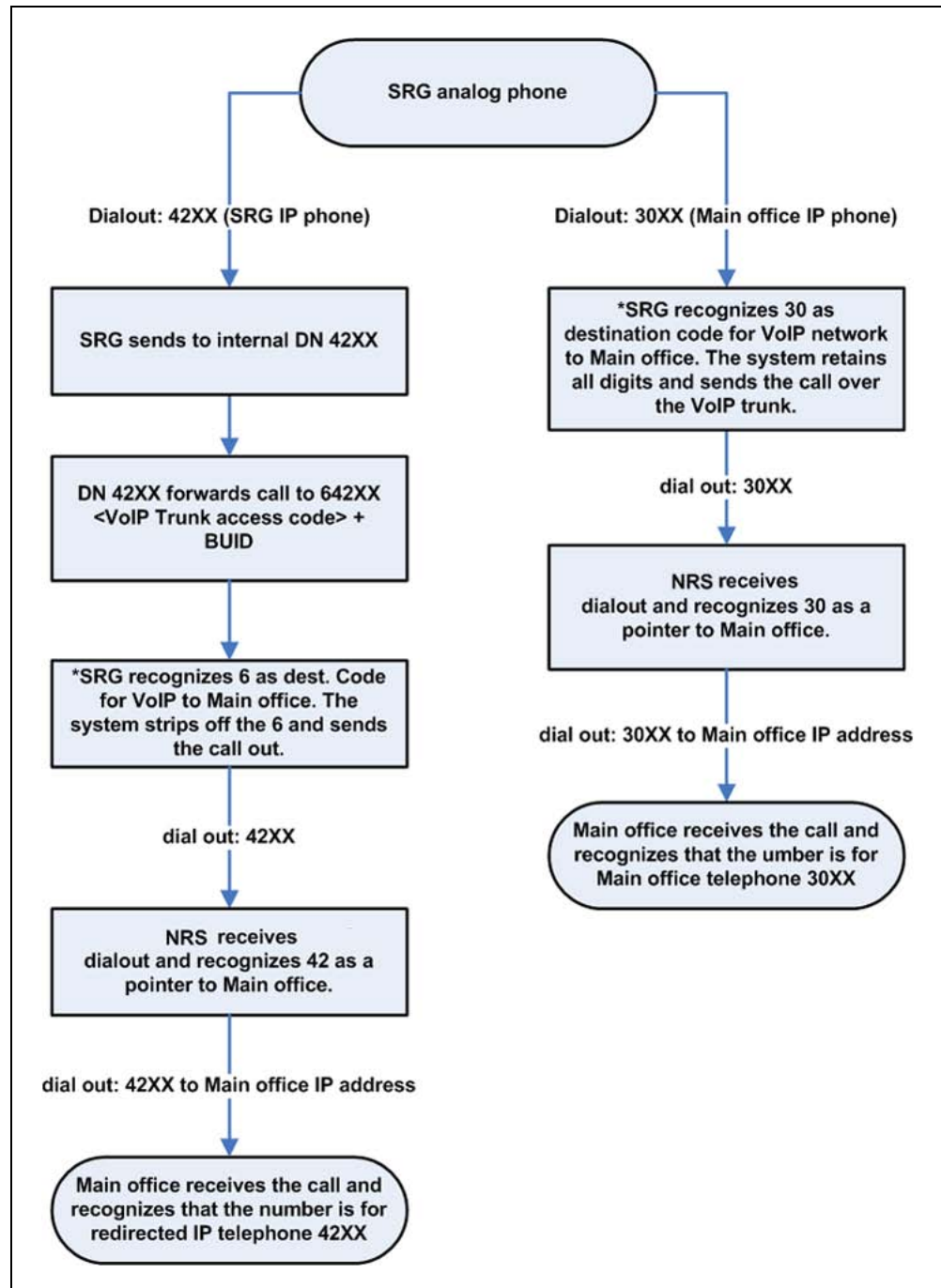
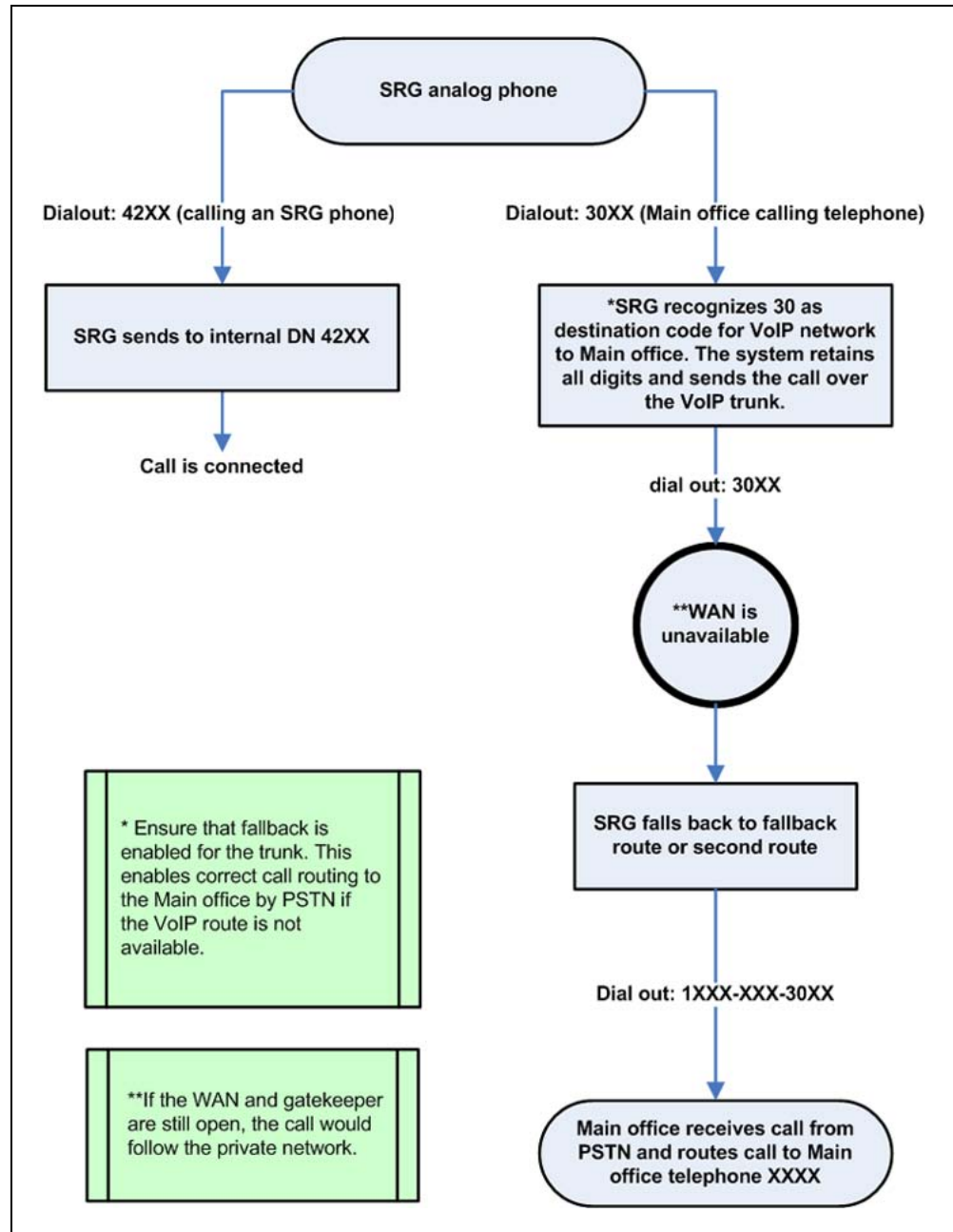

Figure 19
Calls to an SRG analog phone, SRG IP Phone, and a main office IP Phone



Configuration To configure the main office:

- Configure the ESN Control Block for CDP in LD 86.

```
>LD 86
REQ NEW
CUST 0
```

```
FEAT ESN
CDP YES
MXSC 50
NCDP 4
DLTN YES
```

- Configure the CDP Distant Steering Code (DSC) in LD 87.

```
> LD 87
REQ NEW
CUST 0
FEAT CDP
TYPE DSC
DSC 50
FLEN 4
RLI 12
```

To configure the NRS (H.323 Gatekeeper/SIP Redirect Server):

- Create CDP Domain: MO_BO_CDP.
- Create H.323/SIP endpoints: MO, BO.
- Create Numbering Plan entries in CDP Domain:
 - Add 40 for endpoint BO.
 - Add 30 for endpoint MO.
 - Add 42 for endpoint MO.

For information about configuring H.323/SIP Redirect Server, see *IP Peer Networking Installation and Commissioning (NN43001-313)*.

To configure the SRG:

- Configure DN and BUID as the same number on each of the redirected IP Phones. For example, DN/BUID = 42XX.
- Set the main office VoIP Trunk Access code to 3. For example, main office VoIP trunk access code = 3.
- Set the destination code for the VoIP trunk to 30 (retain all digits) or 34 (remove first digit). For example, BUID dialout = 342XX.

The VoIP route destination codes 30 (no digits dropped) and 34 (1 digit dropped) route any call that starts with 30 or 34 out of the system over the VoIP trunk to the main office.

The main office access code length is still 0.

- Assign the telephones registered to the SRG (IP Phones or analog [500/2500-type]) telephones to a different range, such as 40XX. See the NRS configuration above.

The users in both the main office and the SRG dial only the DN for all telephones in the main office and the SRG in both Normal Mode and Local Mode.

For more information on configuring the main office and NRS, see *Branch Office Installation and Commissioning (NN43001-314)* and *IP Peer Networking Installation and Commissioning (NN43001-313)*. For more information on configuring the SRG, see *SRG50 Configuration Guide (NN40140-500)*.

Option 2

DN ranges in the main office and SRG overlap; DNs for SRG IP Phones are the same in Normal and Local Mode

In this configuration, the SRG DN overlap with the main office DN. However, since SRG does not support Vacant Number Routing (VNR), a user registered to the SRG must dial a destination code before the main office DN to call a main office telephone.

To call an SRG IP Phone in either Normal or Local Mode, SRG and main office users need to dial only the DN for the SRG IP Phone. SRG IP Phone calls are forwarded with the main office Private Network ID/destination code appended to the BUID, which allows the call to flow to the VoIP trunks for the main office.

This configuration is not a true CDP dialing plan. A destination code is added by the system to properly direct the SRG IP Phone calls, since the start digits of the DN are not unique for SRG and main office users. Users dialing a telephone registered at the main office must dial a destination code before the main office DN. This plan allows all systems on the network to appear to be available within a range of numbers.

Since the SRG DN range is limited to about 200 DN, this configuration only works if SRG dialing to the main office is limited to the redirected IP Phones and to a small number of main office telephones, such as to a central attendant and voice mail lines.

See [Figure 20 "CDP Option 2" \(page 76\)](#) shows this CDP option.

Figure 20
CDP Option 2

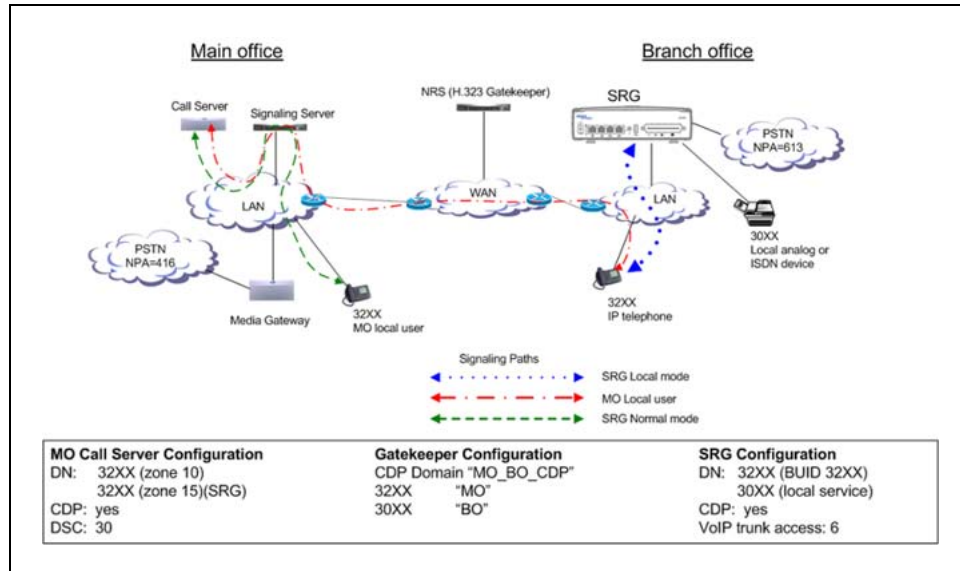

Call scenarios Common call scenarios for this CDP option are listed in "Call scenarios" (page 65). The following additional call scenarios are unique to this CDP option:

- Normal Mode: An SRG analog phone calls an SRG IP Phone and a main office IP Phone registered to the main office.

The WAN is up. SRG analog phone calls an SRG IP Phone and a main office IP Phone registered to the main Office (Normal Mode). See [Figure 21 "SRG analog phone calls an SRG IP Phone and a main office IP Phone registered to the main office"](#) (page 77).

Figure 21
SRG analog phone calls an SRG IP Phone and a main office IP Phone registered to the main office

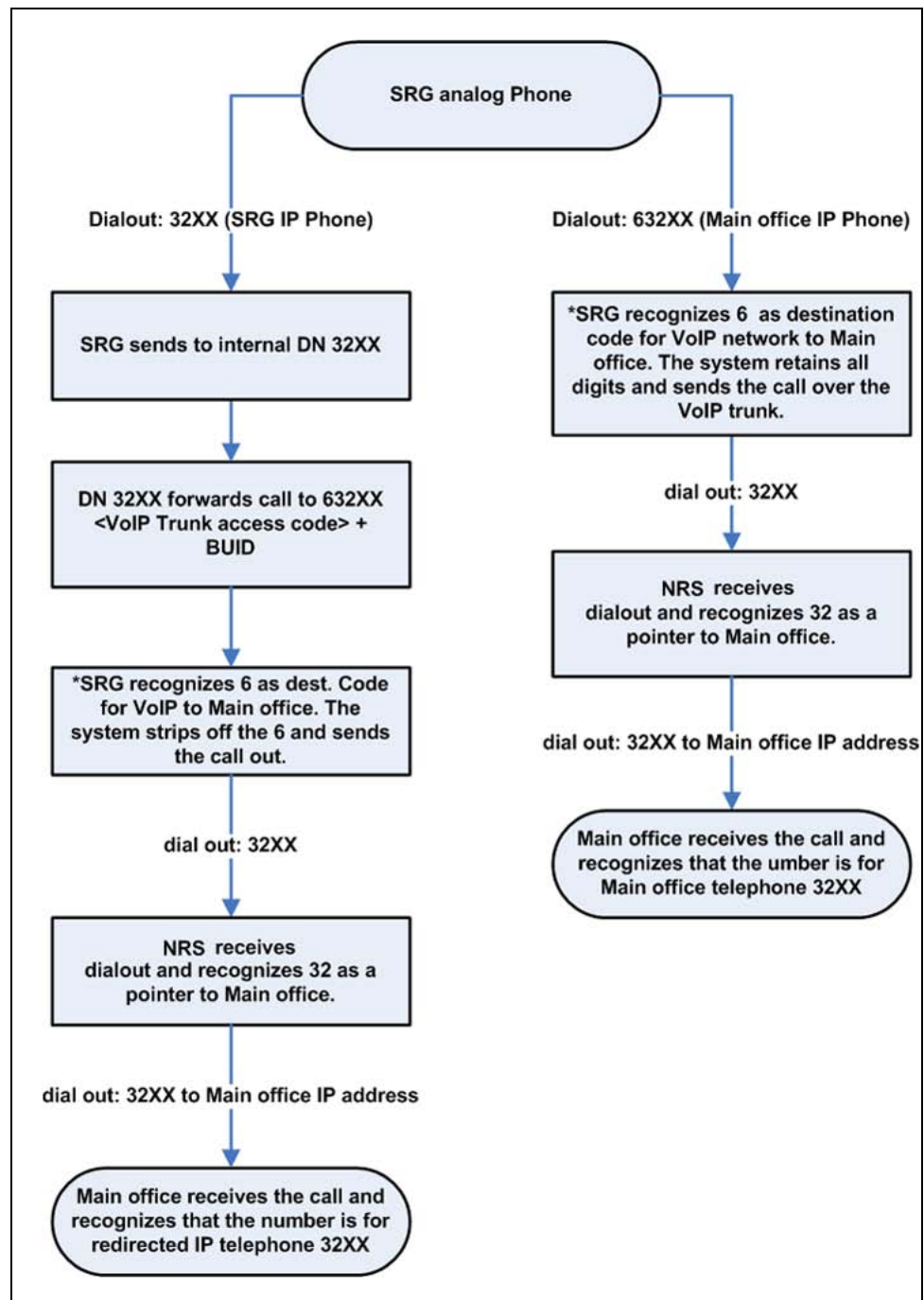

- Local Mode: SRG IP Phones are registered to the SRG.

In this scenario, the WAN and the NCS are working. However, the SRG IP Phones are redirected to the SRG and are in Local Mode (Call Forward All Calls is inactive). The following occur:

- Telephones registered at the SRG dial local DNs (see the common call scenarios given in "[Call scenarios](#)" (page 65)).
- SRG calls to the main office use VoIP routing. The WAN is down. SRG analog phone calls an SRG IP Phone and a main office IP Phone registered to the SRG (Local Mode) See [Figure 22 "SRG analog phone calls an SRG IP Phone and a main office IP Phone "](#) (page 79).
- Main office calls to SRG IP Phones in Local Mode cannot complete because the NRS cannot resolve the numbering.

Figure 22
SRG analog phone calls an SRG IP Phone and a main office IP Phone

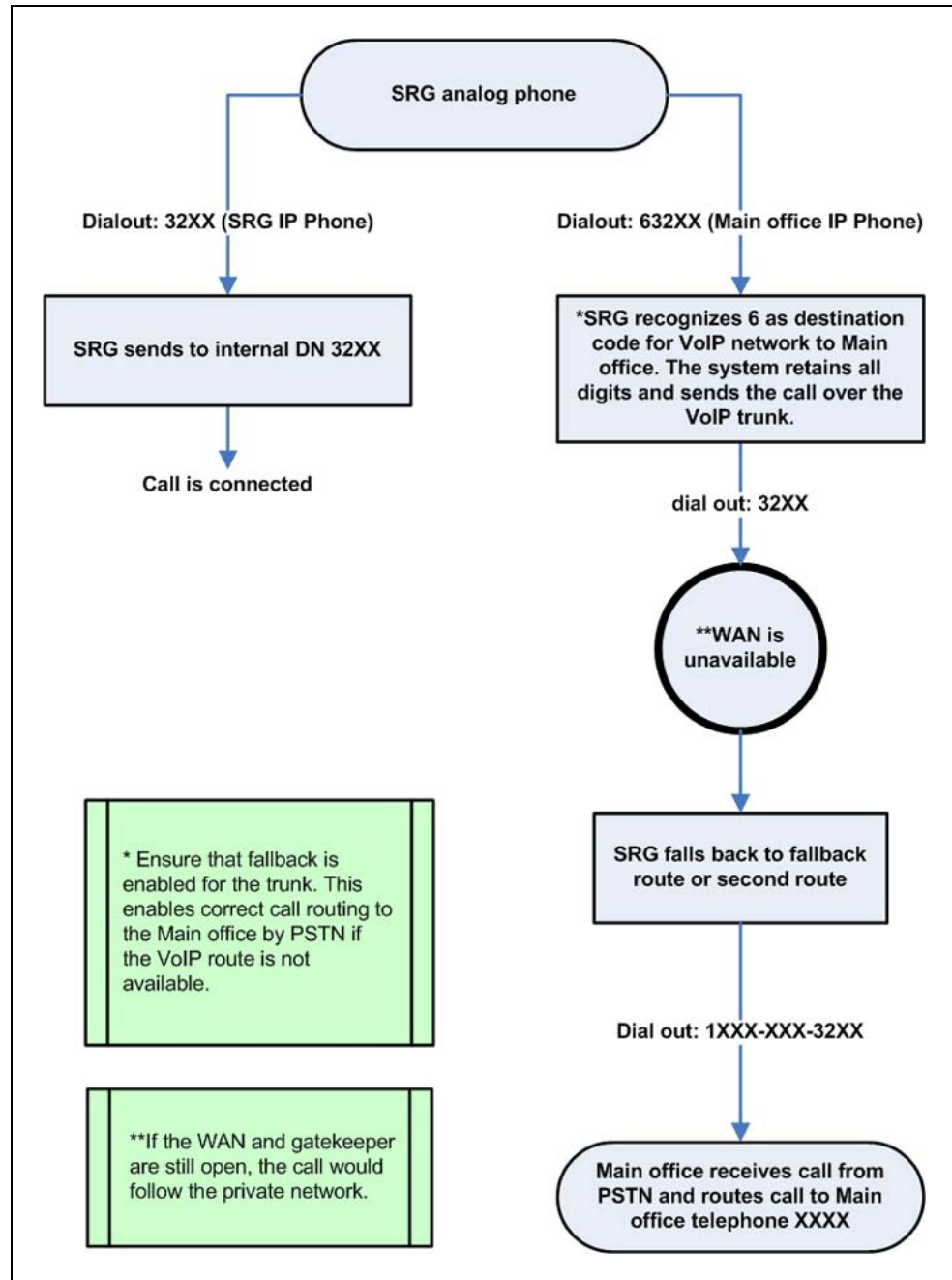

Configuration To configure the main office:

- Configure the ESN Control Block for CDP in LD 86.

```
> LD 86
REQ NEW
```

```
CUST 0
FEAT ESN
CDP YES
MXSC 50
NCDP 4
DLTN YES
```

- Configure the CDP Distant Steering Code (DSC) in LD 87.

```
> LD 87
REQ NEW
CUST 0
FEAT CDP
TYPE DSC
DSC 50
FLEN 4
RLI 12
```

To configure the NRS (H.323 Gatekeeper/SIP Redirect Server):

- Create CDP Domain: MO_BO_CDP.
- Create H.323 and SIP endpoints: MO, BO.
- Create Numbering Plan entries in CDP Domain:
 - Add 30 for endpoint BO.
 - Add 32 for endpoint MO.

For information about configuring H.323 Gatekeeper/SIP Redirect Server, see *IP Peer Networking Installation and Commissioning (NN43001-313)*.

To configure the SRG:

- Configure DN and BUID as the same number on each of the redirected IP Phones. For example, DN/BUID = 32XX.
- Set the main office VoIP Trunk Access code to 6. For example, main office VoIP trunk access code = 6.
- Set the destination code for the VoIP trunk to 6, the same value as the access code. For example, BUID dialout = 632XX.

The main office access code length is still 0.

- Assign the telephones registered to the SRG (IP Phones or analog [500/2500-type] telephones) to a different range, such as 30XX, than the telephones registered to the main office.

SRG users must dial the destination code before the DN when making a call to a telephone in the main office, whether they are in Normal or Local Mode. When calling another IP Phone in the SRG, SRG users dial only the DN, whether they are in Normal or Local Mode. The main office uses VNR to route SRG DN to the SRG in both Normal and Local Mode.

For more information on configuring the main office and NRS, see *Branch Office Installation and Commissioning (NN43001-314)* and *IP Peer Networking Installation and Commissioning (NN43001-313)*. For more information on configuring the SRG, see *SRG50 Configuration Guide (NN40140-500)*.

Option 3

DNs of SRG IP Phones and DNs in the main office overlap in Normal Mode, but are unique in Local Mode

In this CDP configuration, each node on the network has unique leading digits that is included in the DN range. The unique leading digits indicate the private network code for the system.

This configuration allows seamless dialing for users registered at the SRG, but main office users must dial a different DN to call SRG IP Phones in Normal and Local mode. Therefore, SRG IP Phones have DNs and BUIDS that do not match.

In [Figure 23 "CDP Option 3 " \(page 82\)](#), the SRG IP Phones have a DN starting with 4 on the SRG to accommodate the SRG Private Network Code. On the main office, the SRG IP Phones are given a DN (BUID) starting with 3, the main office Private Network Code. The NRS is programmed to recognize that 3X numbers go to the main office and that 4X numbers go to the SRG.

In Normal mode, when a call is directed into the SRG, or from a telephone registered at the SRG, to the SRG IP Phone in Normal mode, the SRG system translates the SRG IP telephone DN (4XXX) to the main office BUID (3XXX) so that the call can route correctly through the main office VoIP trunk. Users registered at the main office dial the main office DN (3XXX) for the SRG IP Phone.

In Local mode, the users registered to the SRG still dial the SRG IP Phone DN (4XXX). The main office users can not call the SRG IP Phone by dialing the main office DN for the telephone (3XXX) because the NRS cannot route the call to the SRG. If the main office user dials the SRG IP Phone DN (4XXX), the call goes through.

Figure 23
CDP Option 3

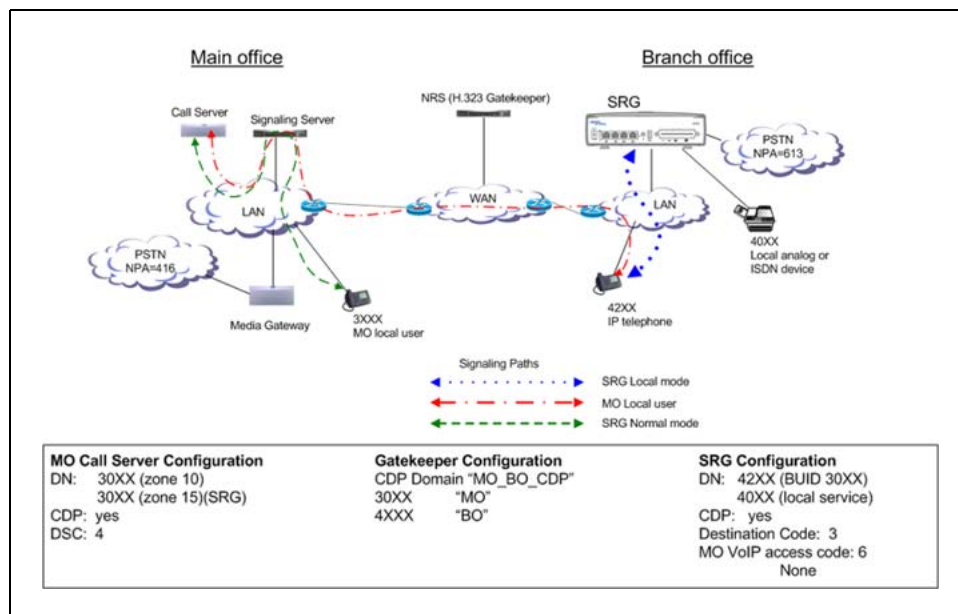

Call scenarios Common call scenarios for this CDP option are listed in "Call scenarios" (page 65). The following additional call scenarios are unique to this CDP option:

- Normal Mode: An SRG analog phone calls an SRG IP Phone and a main office IP Phone registered to the main office.

In this scenario, the telephone registered to the SRG can either dial the SRG DN or the main office DN for the SRG IP Phone. In Local Mode, the SRG IP telephone is reached only with the SRG DN.

In Normal Mode, the display on the IP Phone displays the main office DN (3xxx) for the IP Phone. In Local Mode, the SRG DN (4xxx) is displayed. The WAN is up: SRG analog phone calls an SRG IP Phone and a main office IP Phone registered to the main office (Normal Mode).

Figure 24 "SRG analog phone calls an SRG IP Phone and a main office IP Phone registered to the main office" (page 83) shows this scenario.

Figure 24
SRG analog phone calls an SRG IP Phone and a main office IP Phone registered to the main office

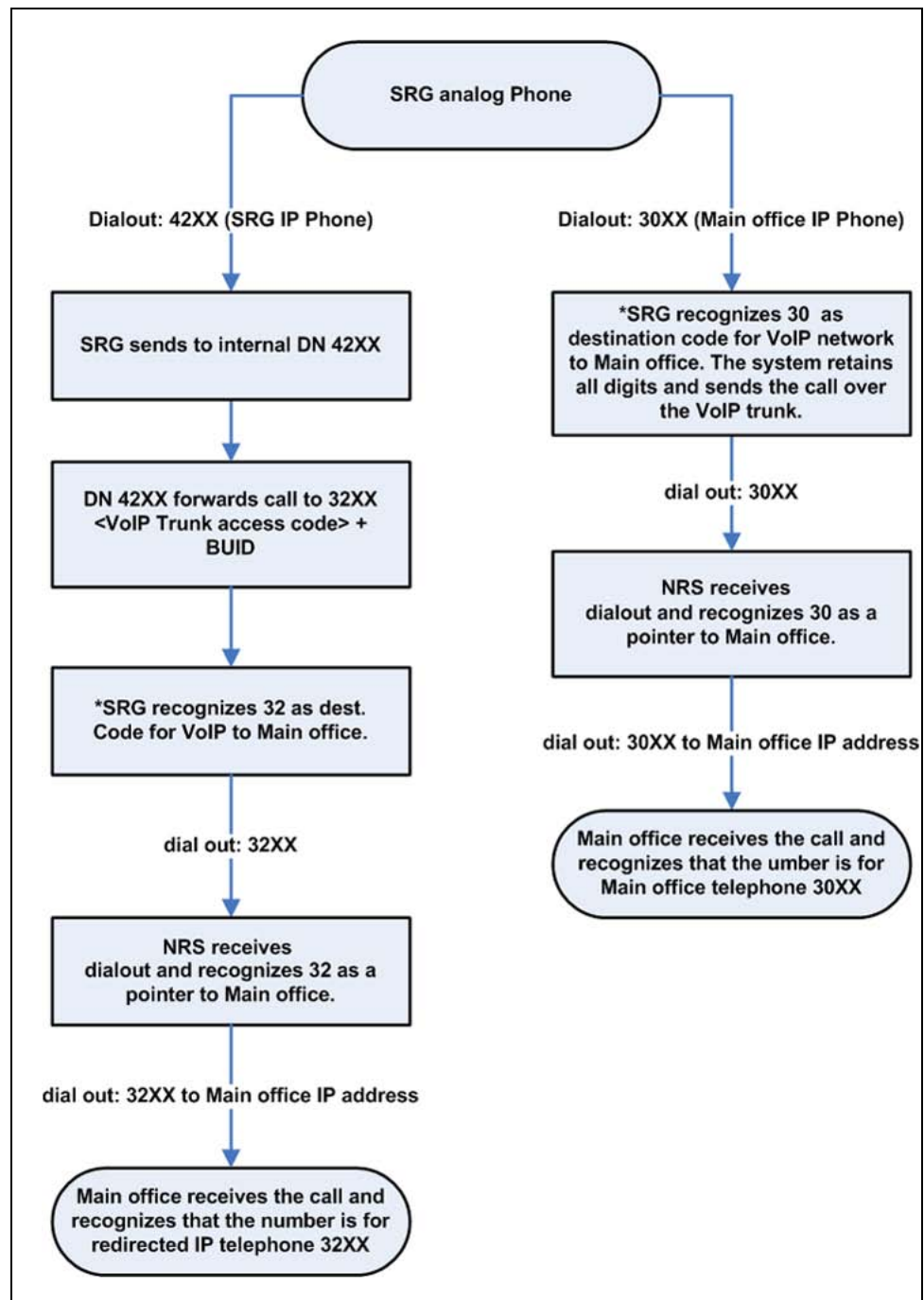

- Local Mode: SRG IP Phones are registered at the SRG.

In this scenario, the WAN and the NCS are working. If the main office user dials the SRG DN (42xx) to call the IP Phone, the call goes through.

Configuration To configure the main office:

- Configure the ESN Control Block for CDP in LD 86.

```
> LD 86
REQ NEW
CUST 0
FEAT ESN
CDP YES
MXSC 50
NCDP 4
DLTN YES
```

- Configure the CDP Distant Steering Code (DSC) in LD 87.

```
> LD 87
REQ NEW
CUST 0
FEAT CDP
TYPE DSC
DSC 4
FLEN 4
RLI 12
```

To configure the NRS (H.323 Gatekeeper/SIP Redirect Server):

- Create CDP Domain: MO_BO_CDP.
- Create H.323/SIP endpoints: MO, BO.
- Create Numbering Plan entries in CDP Domain:
 - Add 4 for endpoint BO.
 - Add 30 for endpoint MO.

For information about configuring H.323 Gatekeeper/SIP Redirect Server, see *IP Peer Networking Installation and Commissioning (NN43001-313)*.

To configure the SRG:

- Set the BUID to the same number that was assigned for the TN by the main office.
- Set the main office VoIP Trunk Access code to 0.
- Do not assign a value to the main office trunk access code field.

For more information on configuring the main office and NRS, see *Branch Office Installation and Commissioning (NN43001-314)* and *IP Peer Networking Installation and Commissioning (NN43001-313)*. For more information on configuring the SRG, see *SRG50 Configuration Guide (NN40140-500)*.

Uniform Dialing Plan Overview

Figure 25 "UDP using location codes" (page 85) shows an example of a Uniform Dialing Plan (UDP) using location codes (Access Code + LOC + DN) configuration.

In this type of dialing plan, the DNs on the SRG do not need to be different from the BUID, since the location code (LOC) defines the unique node characteristic. Therefore, in this example:

- The SRG IP Phone has DN 3002 and BUID 3002. (The system adds the routing code and LOC code to the BUID).
- The local telephone has a DN of 3101.
- The main office has a telephone configured as TN 3001.
- On the main office, the AC1 steering code for the SRG is 6 and the LOC is 504.
- On the SRG, the destination code for the main is 6 and the LOC is 501.

Figure 25
UDP using location codes

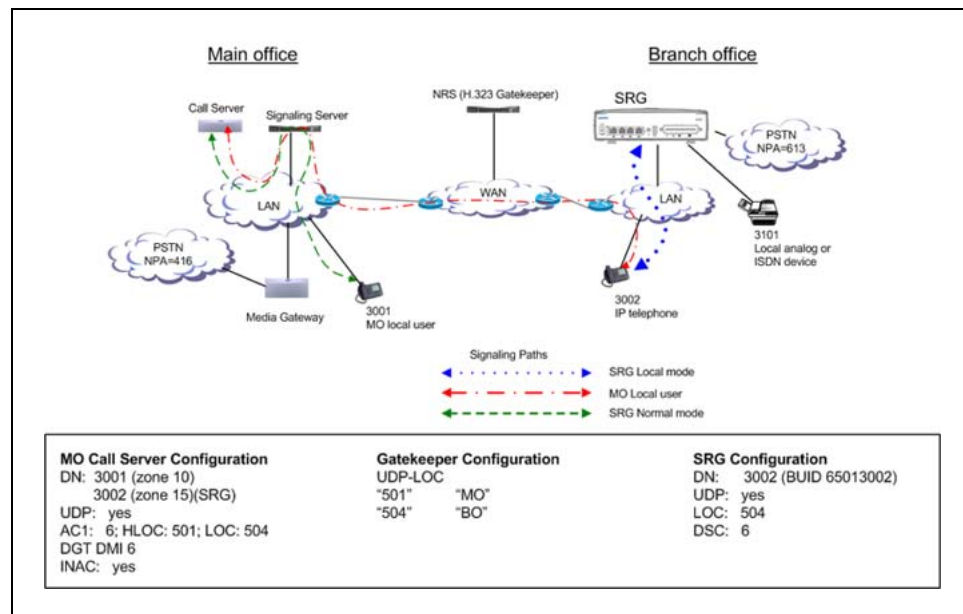

Call scenarios

This section describes how calls interact between the SRG and main office with UDP.

Calling from main office to the SRG and SRG PSTN, in Normal mode In this scenario, a telephone registered at the main office calls a telephone registered to the SRG, or makes a call over the PSTN through the SRG. Figure 26 "Calling from the main office to the SRG and SRG PSTN, in Normal Mode" (page 86) shows this scenario.

Figure 26
Calling from the main office to the SRG and SRG PSTN, in Normal Mode

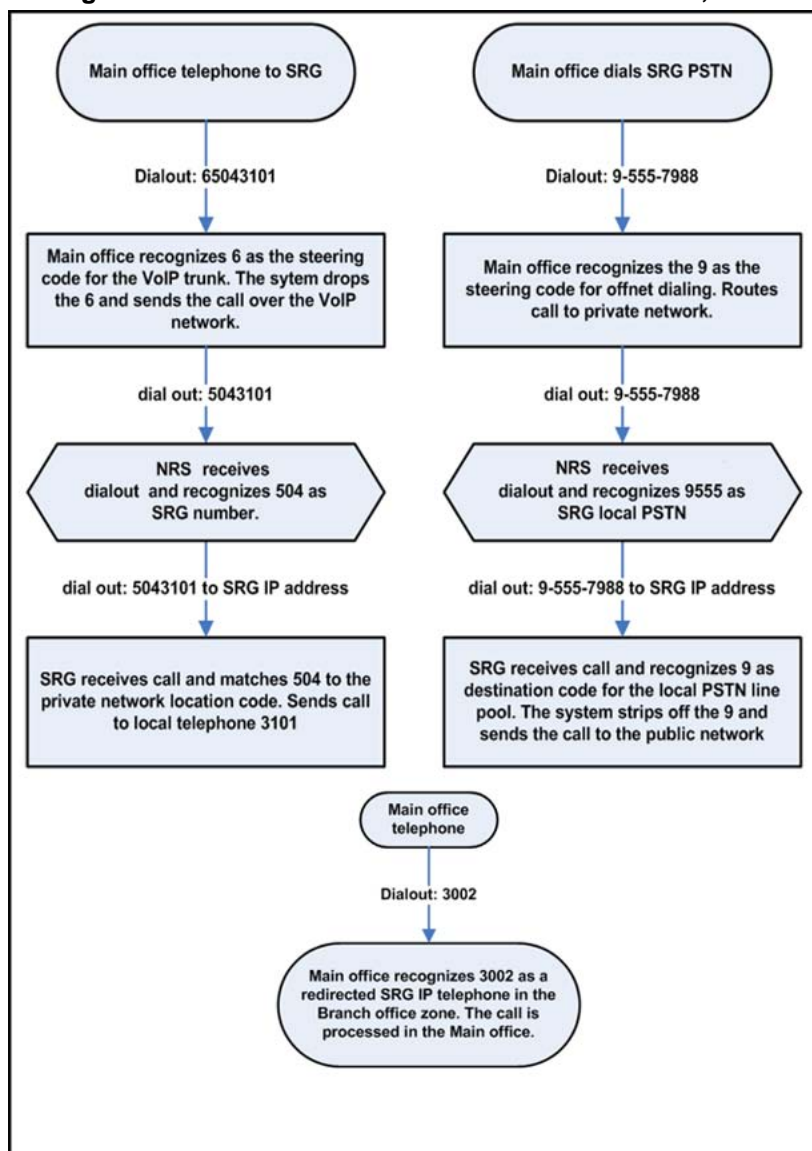

Calling from the SRG to the main office, in Normal Mode In this scenario, a telephone registered at the SRG calls an SRG IP Phone and a main office IP Phone registered to the main office. The WAN is up. SRG analog phone calls an SRG IP Phone and a main office IP Phone registered to the main office (Normal Mode). [Figure 27 "SRG analog phone calls an SRG IP Phone and a main office IP Phone registered to the main office" \(page 88\)](#) shows this scenario.

Figure 27
SRG analog phone calls an SRG IP Phone and a main office IP Phone registered to the main office

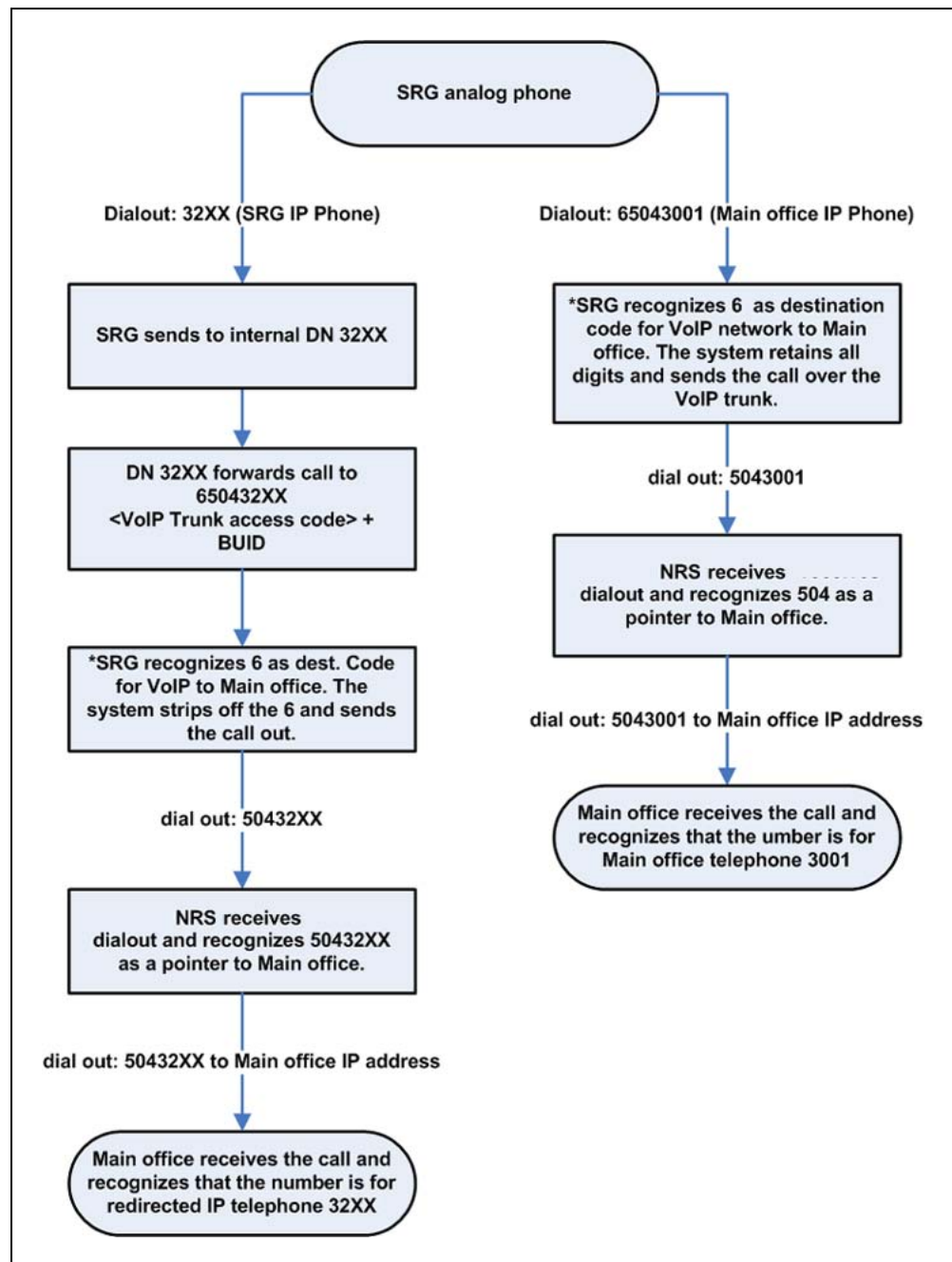

Calling in Local Mode In this scenario, the IP Phones at the SRG are in Local Mode because the WAN is down. The SRG IP telephones are reregistered to the SRG and call forward BUID is inactive on these telephones. These IP Phones are registered at the SRG, and call forward BUID is inactive on these telephones.

The inset shows a main office call to SRG telephones. The user must dial the SRG DN for the IP telephone (6002 instead of 3002). In this case, the user dialing is different in the following ways:

- DN 3001 can call DN 3002 by dialing 65043002, instead of 3002.
- DN 3101 can call DN 3002 by dialing 3002, instead of 65013002 dialed in Normal Mode.
- DN 3002 can call DN 3001 by dialing 65013001, instead of 3001 dialed in Normal Mode.
- DN 3002 can call DN 3101 by dialing 3101 instead of 65043101 dialed in Normal Mode.

The WAN is down. SRG analog phone calls an IP Phone and a main office IP Phone registered to the SRG (Local Mode). [Figure 28 "SRG analog phone calls an IP Phone and a main office IP Phone registered to the SRG " \(page 90\)](#) shows a call from the SRG to an SRG IP Phone and a main office IP Phone registered at the SRG.

Figure 28
SRG analog phone calls an IP Phone and a main office IP Phone registered to the SRG

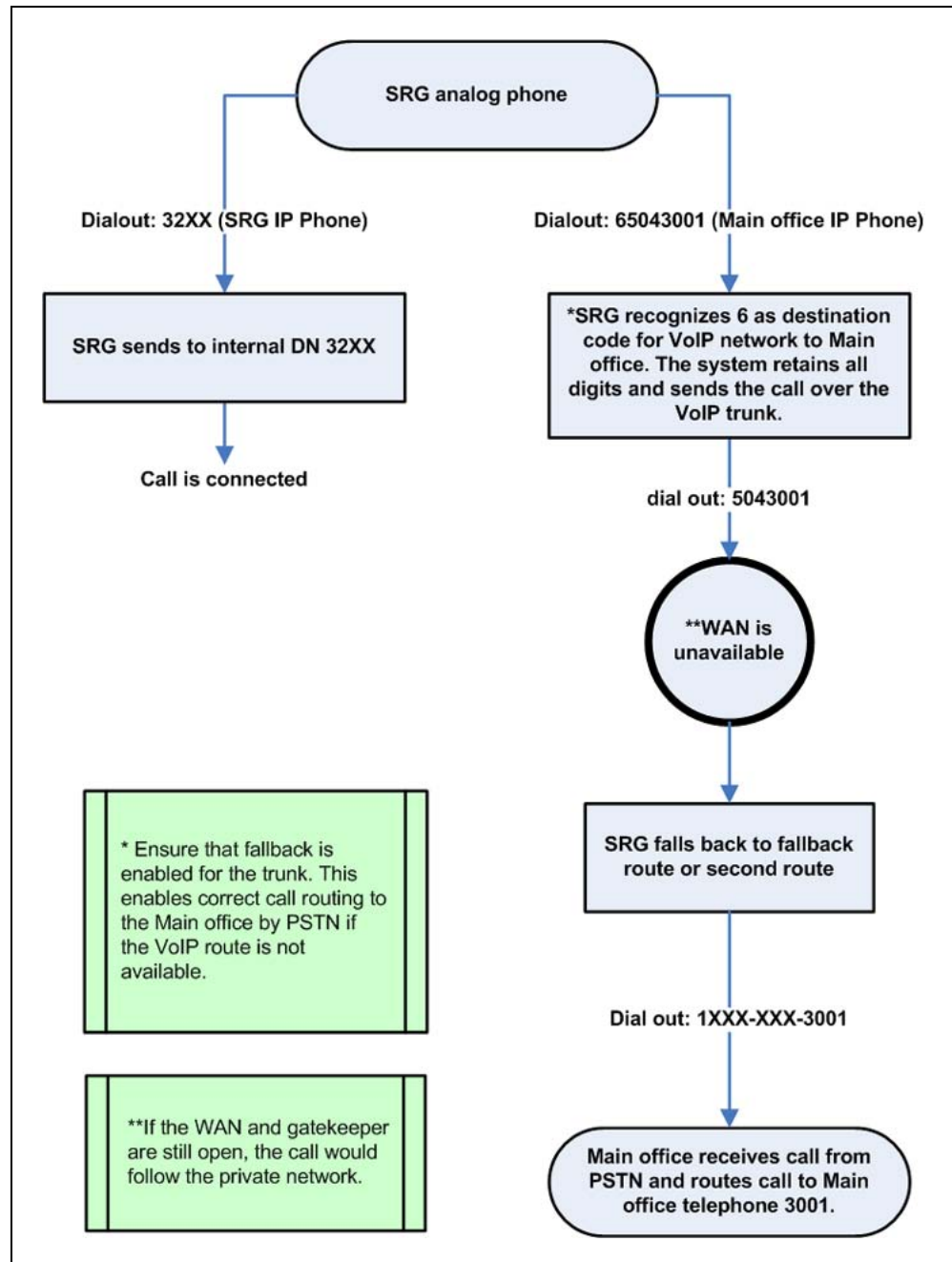

Configuration examples

The following configurations are based on the examples provided in this section. For further information, see *Branch Office Installation and Commissioning (NN43001-314)*.

To configure the main office:

- Configure the ESN Control Block for UDP in LD 86.

```
> LD 86
REQ NEW
CUST 0
FEAT ESN
AC1 16
```

- Configure Digit Manipulation (DGT) in LD 86.

```
> LD 86
REQ NEW
FEAT DGT
DMI 6
DEL 3
```

- Configure the UDP Location Code (LOC) in LD 90.

```
> LD 90
REQ NEW
FEAT NET
TRAN AC1
TYPE LOC
LOC 504
FLEN 7
RLI 12
LDN 0
```

- Configure the UDP HLOC in LD 90.

```
FEAT NET
TRAN AC1
TYPE HLOC
HLOC 501
DMI 6
```

- Configure the HLOC in the Customer Data Block in LD 15.

```
> LD 15
REQ CHG
TYPE CDB
NET_DATA YES
ISDN YES
CLID YES
ENTRY <xx>
HLOC 501
```

- Configure the Virtual Trunk route in LD 16.

```
> LD 16
REQ NEW
```

```
TYPE RDB
CUST 00
ROUT 120
DES VTRKNODE51
TKTP TIE
VTRK YES
ZONE 101
NODE 51
PCID H323
ISDN YES
MODE ISLD
DCH 12
IFC SL1
INAC YES
```

To configure the NRS (H.323 Gatekeeper/SIP Redirect Server):

- Create H.323/SIP endpoints: MO, BO.
- Create Numbering Plan entries:
 - Choose type UDP-LOC.
 - Add 504 for endpoint BO.
 - Add 501 for endpoint MO.

For information about configuring H.323 Gatekeeper/SIP Redirect Server, see *IP Peer Networking Installation and Commissioning (NN43001-313)*.

To configure the SRG:

- Create route and destination code to main office.
- In the main office screen:
 - Set the type of number to ESN LOC.
 - The VoIP trunk access code field is empty.
 - Set the main office Access Code Length to 1.

You can also include the LOC as the dial out when you configure the route for the VoIP line pool. This allows users to dial fewer numbers. For example, if 501 is configured as the dialout, and 6 is the destination code, the user could dial 6+<main office DN>. Once the system identifies the route (VoIP trunks) and drops the 6, it adds the LOC in front of the DN and dials <LOC>+<DN>. In the case of redirected IP Phones, the BUID is <destination code>+DN. The main office Access code length, in this circumstance, is set to 1.

- Dialing plan:
 - Set Type to UDP.

- Set LOC to 504.
- Set the BUID on the IP Phones to <VoIP trunk destination code> + <LOC> + <DN>.

For more information on configuring the main office and NRS, see *Branch Office Installation and Commissioning (NN43001-314)* and *IP Peer Networking Installation and Commissioning (NN43001-313)*. For more information on configuring the SRG, see *SRG50 Configuration Guide (NN40140-500)*.

Bandwidth Management

Contents

This section contains information on the following topics:

- "Introduction" (page 95)
- "Codec negotiation" (page 95)
- "Interoperability between CS 1000 and SRG" (page 101)
- "Adaptive Network Bandwidth Management" (page 110)
- "Tandem Bandwidth Management overview" (page 129)
- "Dialing Plan Overview" (page 130)
- "Network using Uniform Dialing Plan" (page 132)
- "Network using Coordinated Dialing Plan" (page 154)

Introduction

CS 1000 supports Bandwidth Management on a network-wide basis so that voice quality can be managed between multiple Call Servers.

Bandwidth management allows for codec selection and bandwidth limitations to be placed on calls, depending on whether the calls are intrazone or interzone.

Adaptive Network Bandwidth Management is an enhancement of Bandwidth Management in which Quality of Service (QoS) metrics are used to automatically lower available bandwidth.

Once all bandwidth is used, any additional calls are blocked or rerouted. Keep this in mind when designing and implementing Network Bandwidth Management

Codec negotiation

Codec refers to the voice coding and compression algorithm used by DSP. Each codec has different QoS and compression properties.

IP Peer Networking supports the per-call selection of codec standards, based on the type of call (interzone or intrazone). IP Peer Networking supports the following codecs (with supported payload sizes in parentheses, with the default value in bold):

- G.711 A/mu-law (10 ms, **20 ms**, and 30 ms)
- G.729 A (10 ms, **20 ms**, 30 ms, 40 ms, and 50 ms)
- G.729 AB (10 ms, **20 ms**, 30 ms, 40 ms, and 50 ms)
- G.723.1 (**30 ms**) (though it can limit the number of DSP channels available)

SRG 50 does not support G.723 codec.

- T.38 for fax

ATTENTION

The G.XXX series of codecs are standards defined by the International Telecommunications Union (ITU).

By default, the G.711 codec must be supported at both ends of a call. Codec configuration is performed for each node and is independent of the signaling gateway that is used on the node.

The payload size on the CS 1000 must be set to 30 msec in order to work with the SRG.

IP Peer Networking performs codec negotiation by providing a list of codecs that the devices can support. Use CS 1000 Element Manager to configure the list of codec capabilities. See *IP Peer Networking Installation and Commissioning (NN43001-313)* for instructions on configuring codecs.

The codec preference sequence sent over SIP/H.323 depends on the bandwidth policy selected for the Virtual Trunk zone and the involved telephones. For “Best Quality”, the list is sorted from best to worst voice quality. For Best Bandwidth, the list is sorted from best to worst bandwidth usage.

The G.711 codec delivers “toll quality” audio at 64 kbit/s. This codec is optimal for speech quality, as it has the smallest delay and is resilient to channel errors. However, the G.711 codec uses the largest bandwidth.

The G.729A codec provides near toll quality voice at a low delay. The G.729A codec uses compression at 8 kbit/s. The G.729AB codec also uses compression at 8 kbit/s.

The G.723.1 codec provides the greatest compression.

SRG 50 does not support G.723 codec.

ATTENTION

If the payload sizes are set higher than the default values (for example, to support a third-party gateway), then the local IP calls are affected by higher latency. This is because the codec configuration applies to both IP Peer calls and local IP (IP Line) calls.

G.711 A-law and mu-law interworking

In case the far end uses a different Pulse Code Modulation (PCM) encoding law for its G.711 codec, systems that are configured as G.711 A-law also include G.711 mu-law on their codec preferences list. Systems configured as G.711 mu-law include G.711 A-law as their last choice. Therefore, encoding law conversion is performed between systems with different laws.

Bandwidth management and codecs

Bandwidth management defines which codecs are used for intrazone calls and interzone calls.

Bandwidth management enables administrators to define codec preferences for IP Phone to IP Phone calls controlled by the same CS 1000 system in the same zone. These calls are known as intrazone calls. This is different than the codec preferences for calls between an IP Phone on the CS 1000 system to a Virtual Trunk (potentially an IP Phone on another CS 1000 system) or calls to IP Phones in another zone. These calls are known as interzone calls.

For example, you may prefer high quality speech (G.711) over high bandwidth within one system, and lower quality speech (G.729AB plus Voice Activity Detection [VAD]) over lower bandwidth to a Virtual Trunk. Such a mechanism can be useful when a system is on the same LAN as the IP Phones it controls, but the other systems are on a different LAN (connected through a WAN).

The Virtual Trunk usage of bandwidth zones is different than IP Phone bandwidth usage. For Virtual Trunks, a zone number is configured in the Route Data Block (RDB) (LD 16). The zone number determines codec selection for interzone and intrazone calls (that is, Best Bandwidth or Best Quality). See *IP Peer Networking Installation and Commissioning (NN43001-313)* for information on configuring the RDB zone.

Bandwidth usage for Virtual Trunks is accumulated in its zone in order to block calls that exceed the bandwidth availability in a specific zone. However, the amount of bandwidth that is required to complete a given

call is not known until both call endpoints have negotiated which codec to use. The bandwidth used for calculating the usage of a Virtual Trunk call is determined by the preferred codec of the device that connects to the Virtual Trunk. If the device is an IP Phone, the bandwidth calculations use the preferred codec of the IP Phone, based on the codec policy defined for the zones involved (that is, Best Bandwidth or Best Quality). Likewise, the bandwidth calculations use the preferred codec of the Voice Gateway Media Card for connections between a circuit-switched device (for example, a PRI trunk) and a Virtual Trunk.

Codec selection

For every Virtual Trunk call, a codec must be selected before the media path can be opened. When a call is set up or modified (that is, media redirection), one of two processes occurs:

- The terminating node selects a common codec and sends the selected codec to the originating node.
- The codec selection occurs on both nodes.

Each node has two codec lists: its own list and the far end's list. In order to select the same codec on both nodes, it is essential to use the same codec selection algorithm on both nodes. Before the codec selection occurs, the following conditions are met:

- Each codec list contains more than one payload size for a given codec type (it depends on the codec configuration). Payload size must be set to 30 msec for proper functionality between the CS 1000 and the SRG.
- Each codec list is sorted by order of preference (the first codec in the near end's list is the near end's most preferred codec, the first codec in the far end's list is the far end's preferred codec).

Codec selection algorithms

When the codec lists meet the above conditions, one of the following codec selection algorithms selects the codec to be used:

- H.323 Master/Slave algorithm
- SIP Offer/Answer model
- Best Bandwidth codec selection algorithm

H.323 Master/Slave algorithm

In the case of a Virtual Trunk call between Nortel and third-party equipment, the H.323 Master/Slave algorithm is used.

The codec selection algorithm proposed by the H.323 standard involves a Master/Slave negotiation. This is initiated each time two nodes exchange their capabilities (TCS message). The Master/Slave information decides

that one node is Master and the other node is Slave. The outcome of the Master/Slave negotiation is not known in advance; it is a random result. One node could be Master then Slave (or vice versa) during the same call.

Algorithm details The H.323 Master/Slave algorithm operates in the following manner:

- The Master node uses its own codec list as the preferred one and finds a common codec in the far end's list. In other words, the Master gets the first codec in its list (for example, C1), checks in the far end's list if it is a common codec; if it is, C1 is the selected codec. Otherwise, it gets the second codec in its list and verifies it against the far end, and so on.
- The Slave node uses the far end's list as the preferred one and finds in its own list the common codec.

Issues caused by the H.323 Master/Slave algorithm The issues caused by the Master/Slave algorithm are due to the random nature of the Master/Slave information. In other words, one cannot predetermine the codec that is used during a Virtual Trunk call.

The following are the issues associated with the H.323 Master/Slave algorithm:

- After an on-hold and off-hold scenario (which triggers Master/Slave negotiation), the codec used for the restored call might be different than the one used before on-hold, because the Master/Slave information could have been changed.
- When using Fast Start codec selection, a call from Telephone 1 (node1) to Telephone 2 (node2) can use a different codec than a call from Telephone 2 (node2) to Telephone 1 (node1), because the terminating end is always Master.
- For tandem calls, the Master/Slave information is not relevant. The Master/Slave information is designed for use between two nodes only, not between three or more nodes. It makes the codec selection for tandem calls more complex and inefficient.

To solve the issues, another codec selection algorithm, not based on the unpredictable Master/Slave information, is needed. Since any change to the Master/Slave algorithm implies a change to the H.323 standard, the new codec algorithm is used for Virtual Trunk calls between Nortel equipment.

SIP Offer/Answer model

The SIP codec negotiation is based on the Offer/Answer model with Session Description Protocol (SDP).

The following three cases of codec negotiation are supported:

- The calling user agent sends an SDP offer with its codec list in the INVITE message with a sendrecv attribute. In this case, the called user agent selects one codec and sends the selected codec in an SDP answer. The SDP answer is included in the 200 OK message (which is the response to the INVITE) with the sendrecv attribute.

This is the preferred method of operation.

- The calling user agent sends an SDP offer with its codec list in the INVITE message with a sendrecv attribute. The called user agent returns more than one codec in the SDP answer. In the case that many codecs are included in the response, the calling user agent picks the first compatible codec from the called user agent's list, and sends a new SDP offer with a single codec to lock it in.
- If the SDP of the calling user agent is not present in the INVITE message, then the called user agent sends its codec list in an SDP offer in the 200 OK message, with the sendrecv attribute. The calling user agent selects one codec and sends the selected codec in an SDP answer inside the ACK message, with sendrecv attribute.

For more information on this algorithm, refer to RFC 3264 – An Offer/Answer Model with the Session Description Protocol (SDP).

Best Bandwidth codec selection algorithm

The "Best Bandwidth" codec selection algorithm solves the issues caused by the H.323 Master/Slave algorithm. The "Best Bandwidth" algorithm selects one common codec based on two codec lists. Every time the selection is done with the same two lists, the selected codec is the same.

The "Best Bandwidth" codec decision is based on the codec type only, it does not take into account the fact that some codecs, while generally using less bandwidth, can consume more bandwidth than others at certain payload sizes.

Algorithm details The selected codec is the type considered as the best bandwidth codec type. To know whether one codec type has better bandwidth than another, see the rule as summarized in [Table 8 "Codec types"](#) (page 100).

Table 8
Codec types

| | G.711 A-law | G.711 mu-law | G.729 A | G. 729 AB | G. 723.1 |
|---------------------|--------------------|---------------------|----------------|------------------|-----------------|
| G.711 A-law | G.711 A-law | G.711 mu-law | G.729 A | G. 729 AB | G. 723.1 |
| G.711 mu-law | G.711 mu-law | G.711 mu-law | G.729 A | G. 729 AB | G. 723.1 |
| G.729 A | G.729 A | G.729 A | G.729 A | G. 729 AB | G.729 A |

| | | | | | |
|--------------------------------------|-----------|-----------|-----------|-----------|-----------|
| G. 729 AB | G. 729 AB | G. 729 AB | G. 729 AB | G. 729 AB | G. 729 AB |
| G. 723.1 | G. 723.1 | G. 723.1 | G.729 A | G. 729 AB | G. 723.1 |
| SRG 50 does not support G.723 codec. | | | | | |

Interoperability between CS 1000 and SRG

The SRG is designed to interoperate with CS 1000 in a manner similar to MG 1000B but with a limitation with respect to codec selection policy. Calls between branch IP Phones and branch analog phones are based on the interzone policy rather than the intrazone policy defined in the CS 1000 main office. The zone table is updated based on the intrazone policy.

The net result of this limitation is that calls between branch IP Phone users and the branch PSTN or between the IP Phones and branch analog phones will always use a Best Bandwidth codec. However, the calls will be accounted for as Best Quality. This may impact the perception of call quality in this scenario, but it will not result in early call blocking. There is no impact to codec selection or bandwidth usage tracking for calls that require WAN bandwidth.

Configuring Bandwidth Management parameters

The following sections describe how to configure Bandwidth Management in a CS 1000 network. Nortel recommends that you read the Bandwidth Management section in *Converging the Data Network with VoIP (NN43001-260)* before using the following configuration information.

Zones

Bandwidth Management Zones are configured for each endpoint on a Call Server. The Network Bandwidth Zone number determines if a call is an intrazone call or an interzone call. Once that is determined, the proper codec and bandwidth limit is applied to the call.

All of the endpoints on one Call Server are configured with Zone number to identify all of the endpoints as being in a unique geographic location in the network. In addition, Virtual Trunks are configured with a Zone number that is different from the endpoint Zone numbers in the Call Server.

Codec selection occurs as described in "[Codec selection](#)" (page 98).

Configuration rules

There are four configuration rules for Bandwidth Management, as follows:

1. Each Call Server in the network must be configured with a unique VPNI, with the only exception noted in point 2, next.

2. Branch office (MG 1000B and SRG) Call Servers must be configured with the same VPNI as that of the main office Call Server with which they register.
3. Nortel recommends that all the endpoints on a Call Server (IP Phones and Voice Gateway Media Cards) be configured with the same Zone number.
4. Virtual Trunks must be configured with a different Zone number than the endpoints.

Network Planning

Before configuring Bandwidth Management in a CS 1000 network, follow these steps:

| Step | Action |
|------|---|
| 1 | Choose unique VPNI for all Call Servers in the network. |
| 2 | Choose unique Bandwidth Zone numbers for all Call Servers in the network. These are used when configuring the endpoints (telephones and gateways) on the Call Server. |
| 3 | Choose unique Bandwidth Zone numbers for the Virtual Trunks in the network. |
| 4 | Choose the codecs that will be enabled on each Call Server. |
| 5 | Identify what the interzone codec strategy will be (BB-Best Bandwidth or BQ-Best Quality) for each zone in the network. |
| 6 | Identify what the intrazone codec strategy will be (BB-Best Bandwidth or BQ-Best Quality) for each zone in the network. |
| 7 | Calculate the bandwidth available for intrazone calls for each zone in the network. |
| 8 | Calculate the bandwidth available for interzone calls for each zone in the network. |
| 9 | Calculate the bandwidth available for intrazone calls |

—End—

Enabling codecs

In Element Manager, select the codecs that will be enabled for calls on the Call Server, and define the associated parameters, such as payload size.

Select the zone on the **Zones** web page (see [Figure 30 "Zones web"](#) (page 105)) and click **VGW and IP phone codec profile**. Select an existing codec or configure a new one in the **VGW and IP phone codec profile** section, shown in [Figure 29 "Configuring a codec"](#) (page 103). See *IP Peer Networking Installation and Commissioning (NN43001-313)* for full instructions on configuring a codec.

Figure 29
Configuring a codec

- VGW and IP phone codec profile

Enable Echo canceller

Echo canceller tail delay (milliseconds)

Voice activity detection threshold (-20 - +10 DBM)

Idle noise level (-327 - +327 DBM)

DTMF Tone detection

Enable V.21 FAX tone detection

FAX maximum rate (bps)

FAX payout nominal delay (0 - 300 milliseconds)

FAX no activity timeout (10 - 32000 milliseconds)

FAX packet size

+ Codec G711 Select

+ Codec G729A Select

+ Codec G723.1 Select

+ Codec T38 FAX Select

+ OoS

+ LAN configuration

+ SNMP

+ Virtual Trunk Network Health Monitor configuration

+ H323 GW Settings

+ Firmware

Configuring Bandwidth Management

The steps to configure Bandwidth Management on the Call Server are as follows:

| Step | Action |
|------|--------|
|------|--------|

- | | |
|---|---|
| 1 | Define a VPNI number in LD 15. |
| 2 | <p>Configure the Bandwidth Management parameters for each zone on the Call Server using either Element Manager (see "Configuration using CS 1000 Element Manager" (page 104)) or LD 117 (see "Configuration using LD 117" (page 105)).</p> <ul style="list-style-type: none"> Call Server zones that will be used for endpoints (telephones and gateways) with the following properties: |

- Intrazone Preferred Strategy = Best Quality (BQ)
 - Intrazone Bandwidth = default (1000000)
 - Interzone Preferred Strategy = Best Bandwidth (BB)
 - Interzone Bandwidth = maximum bandwidth usage allowed between peer Call Servers
- Call Server zones that will be used for Virtual Trunks with the following properties:
 - Intrazone Preferred Strategy = Best Quality (BQ)
 - Intrazone Bandwidth = default (1000000)
 - Interzone Preferred Strategy = Best Quality (BQ)
 - Interzone Bandwidth = default (1000000)
- 3** Configure the IP Phone, DSP and Virtual Trunk data with the corresponding zone numbers.

For example, for an IP Phone 2004 telephone in zone 8:

```
LD 11
REQ NEW
TYPE 2004
...
ZONE 8
...
```

—End—

Configuration using CS 1000 Element Manager

Zones are configured from the Zones web page, shown in [Figure 30 "Zones web" \(page 105\)](#).

See ["Configuring zone parameters using CS 1000 Element Manager" \(page 36\)](#) for instructions on configuring a Network Bandwidth Management zone, using the values given on ["Configuring Bandwidth Management" \(page 103\)](#).

Figure 30
Zones web

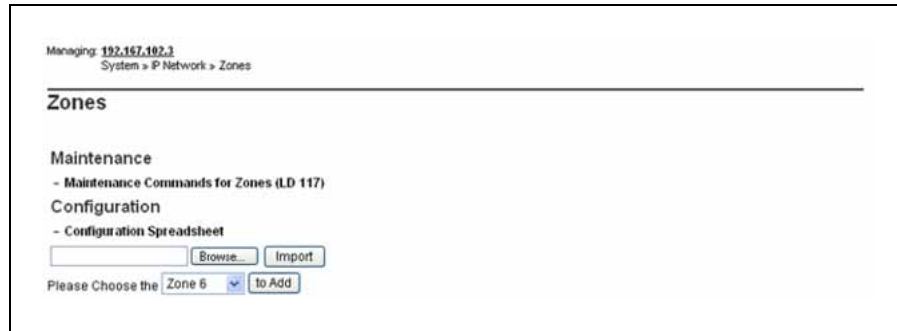

Configuration using LD 117

A new Bandwidth Management zone is configured in LD 117 using the NEW ZONE command. An existing zone can be modified using the CHG ZONE command.

LD 117 Configure a new or existing Bandwidth Management zone.

| Command | Description |
|---|--|
| NEW CHG ZONE <zoneNumber> [<intraZoneBandwidth> <intraZoneStrategy> <interZoneBandwidth> <interZoneStrategy> <zoneIntent> <zoneResourceType>] | <p>Configure a new zone (NEW) or change (CHG) an existing zone, where:</p> <ul style="list-style-type: none"> • zoneNumber = 0-255 • intraZoneBandwidth = Available intrazone bandwidth (Kbit/s); Nortel recommends this value be set to the maximum value. • intraZoneStrategy = BB (Best Bandwidth) or BQ (Best Quality); Nortel recommends this value be set to BQ. • interZoneBandwidth = <ul style="list-style-type: none"> — For Call Server zone = Maximum bandwidth usage (in Kbit/s) allowed between peer Call Servers — For Virtual Trunk zones = 1000000 (Kbit/s) • interZoneStrategy = BB (Best Bandwidth) or BQ (Best Quality); Nortel recommends this value be set to BB to conserve interzone bandwidth. • zoneIntent = type of zone, where: <ul style="list-style-type: none"> — MO = Main Office (Call Server) zone — BMG = Branch Media Gateway (for branch office zones) — VTRK = Virtual Trunk zone • zoneResourceType = resource intrazone preferred strategy, where: |

| Command | Description |
|---------|---|
| | <ul style="list-style-type: none"> — shared = shared DSP channels (default) — private = private DSP channels <p>In CS 1000 Release 5.0, the zones that were described with BMG designator stay with BMG one, all the other zones are provided with MO designator. It is possible to update ZoneIntent using CHG ZONE command.</p> |

Maintenance commands

Maintenance commands can be run from Element Manager or LD 117.

Maintenance using Element Manager

The PRT INTRAZONE and PRT INTERZONE commands are available in Element Manager from the Zones web page, shown in [Figure 30 "Zones web" \(page 105\)](#). To access these commands, follow the steps in [Procedure 7 "Printing intrazone and interzone statistics for a zone" \(page 106\)](#).

Procedure 7

Printing intrazone and interzone statistics for a zone

| Step | Action |
|------|--|
| 1 | Select IP Networks > Zones from the navigator. The Zones web page opens. |
| 2 | Click Maintenance Commands for Zones (LD 117) . The Maintenance Commands for Zones web page opens, as shown in Figure 31 "Maintenance Commands for Zones web page" (page 107) . This page lists all the configured zones. |

Figure 31
Maintenance Commands for Zones web page

Managing: 192.167.102.3
 System > IP Network > Zones > Maintenance Commands for Zones

Maintenance Commands for Zones

Action: Print Intrazone Statistics per Local Zone (PRT INTRAZONE)
 Zone #: Print Intrazone Statistics per Local Zone (PRT INTRAZONE)

Print Bandwidth Property (PRT ZBW)
 Print Description (PRT ZDES)
 Print Dialing Plan and Access Codes (PRT ZDP)
 Print Time Change Property (PRT ZTP)
 Show Branch Office Behaviour (STAT ZBR)
 Show Status (STAT ZONE)

| Zone # | Enable a Zone (ENL ZONE) | Average(Kbps) | Peak(%) |
|--------|---|---------------|---------|
| 0 | Disable a Zone (DIS ZONE) | 0 | 0 |
| 1 | Enable a Zone's Branch Office Behaviour (ENL ZBR) | 0 | 0 |
| 2 | Disable a Zone's Branch Office Behaviour (DIS ZBR) | 0 | 0 |
| 3 | Print Adaptive Network Bandwidth Management and CAC Parameters (PRT ZCAC) | 0 | 0 |
| 4 | Print Interzone Statistics (PRT INTERZONE) | 0 | 0 |
| 5 | Reset CAC Statistics (CLR CACR) | 0 | 0 |

Print Zone Alternate Prefix Information (PRT ZALT)
 Show Alternate Routing Status (STAT ZALT)
 Print Alarm Suppression Time Period (PRT ZAST)

Number of Zones configured = 6

- 3 Do one of the following:
- To display intrazone statistics:
 1. Select **Print Interzone Statistics (PRT INTERZONE)** from the **Action** drop-down list.
 2. Select a zone from the **Zone Number** drop-down list, by doing of the following:
 - Select **ALL** to print statistics for all zones.
 - Select a specific zone number to display statistics for a specific zone.
 - To display interzone statistics:
 1. Select **Print Intrazone Statistics per Local Zone (PRT INTRAZONE)** from the **Action** drop-down list.
 2. Select a zone from the **Near End Zone Number** drop-down list, by doing of the following:
 - Select **ALL** to print statistics for all zones.
 - Select a specific zone number to display statistics for a specific zone.
- 4 Click **Submit**.

The **Maintenance Commands for Zones** web page reopens, displaying the statistics for the specified zone or zones. A blank field indicates that statistic is either not available or not applicable to that zone.

Figure 32 "Element Manager intrazone statistics" (page 108) shows an example of intrazone statistics. Figure 33 "Element Manager interzone statistics" (page 108) shows an example of interzone statistics.

Figure 32
Element Manager intrazone statistics

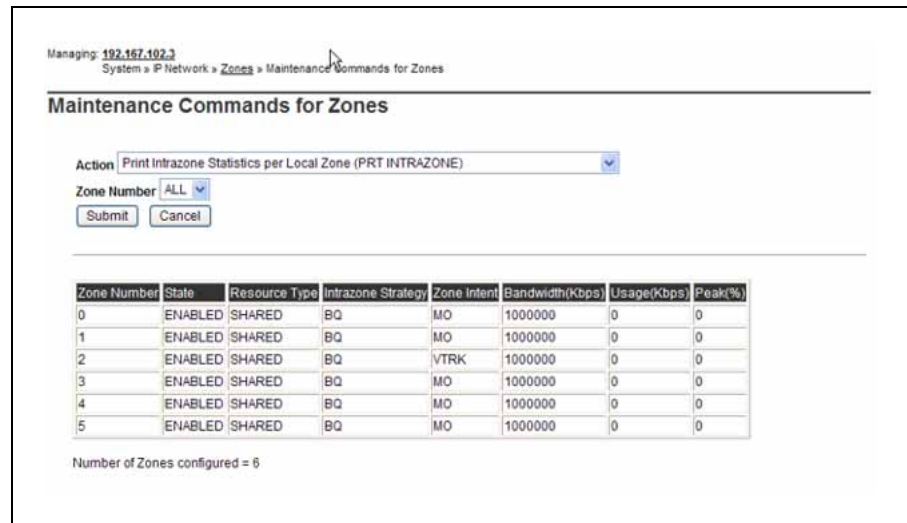
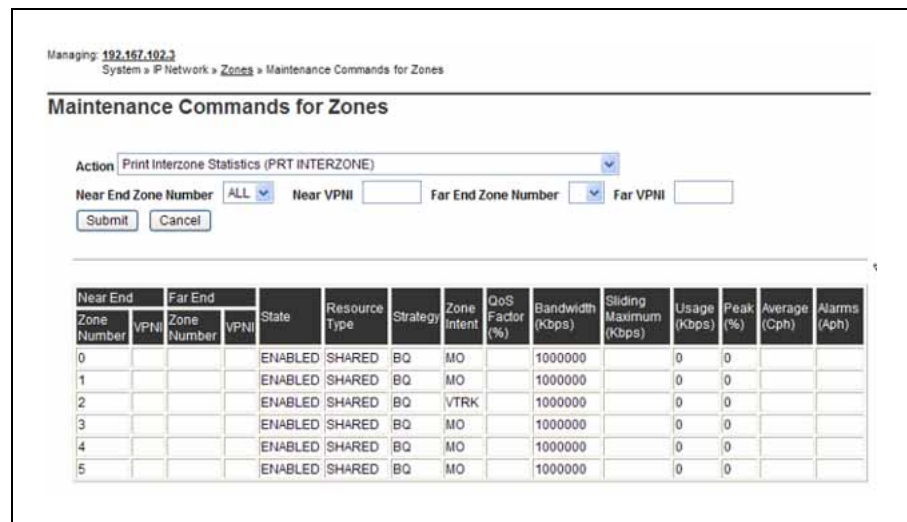

Figure 33
Element Manager interzone statistics



—End—

Maintenance using LD 117

Use the PRT INTRAZONE or PRT INTERZONE commands in LD 117 to view the intrazone or interzone statistics for specified zones.

ATTENTION

Do not use the PRT ZONE command — it has been replaced by the PRT INTRAZONE and PRT INTERZONE commands.

LD 117 Print zone statistics.

| Command | Description |
|--|--|
| PRT INTRAZONE [<zone>] | <p>Print intrazone statistics for the identified zones, where:</p> <ul style="list-style-type: none"> • zone = ALL or 0-255 <p>The output of this command displays the following information:</p> <ul style="list-style-type: none"> • Zone • Type = PRIVATE/SHARED • Strategy = BB/BQ • zoneIntent = MO/VTRK/BMG • Bandwidth = number of Kbps • Usage = number of Kbps • Peak = % |
| PRT INTERZONE [nearZone>] [<nearVPNI>] [<farZone>] [<farVPNI>] | <p>Print interzone statistics for the specific VPNI zone; where:</p> <ul style="list-style-type: none"> • nearZone = ALL or 0-255 <p>The output of this command displays the following information:</p> <ul style="list-style-type: none"> • Zone number = 0-255 • Zone VPNI = 1-16283 |

| Command | Description |
|---------|--|
| | <ul style="list-style-type: none"> • Type= PRIVATE/SHARED • Strategy = BB/BQ • ZoneIntent = MO/VTRK |

Adaptive Network Bandwidth Management

CS 1000 Release 4.5 supports the Adaptive Network Bandwidth Management feature.

Description

The Adaptive Network Bandwidth Management feature enhances the performance of Voice over Internet Protocol (VoIP) networks based on real-time interaction. It provides the means to automatically adjust bandwidth limits and take corrective action in response to Quality of Service (QoS) feedback. This dynamic bandwidth adjustment maintains a high level of voice quality during network degradation.

The Adaptive Network Bandwidth Management feature dynamically adapts to QoS in the network and reduces the bandwidth available for interzone calls if QoS degrades. Typically, each Call Server in the network has a zone assigned to it. The Call Server keeps track of the bandwidth being used between its own zone and zones belonging to other Call Servers. If the QoS degrades between the Call Server's zone and a particular zone belonging to another Call Server, the available bandwidth is reduced automatically between those two zones. When the QoS between the two zones improves, then the bandwidth limit is allowed to return to normal.

When an IP Phone encounters degradation of the network, it informs the Call Server through various QoS alarms. These QoS alarms (packet loss, jitter, delay, and, for phase 2 IP Phones, R value) get reported to the Call Server. Depending upon the rate of the incoming alarms and the value of the alarms, the Call Server reduces the available bandwidth available to make new calls. The Call Server will lower/limit the number of new calls allowed, based on the available bandwidth. This prevents excessive calls being placed on a network with limited bandwidth (resulting in poor voice quality). Once the adjusted (lowered) bandwidth reaches its full capacity, new calls are either routed to an alternate route (if available) using Network Alternate Routing Service (NARS) , or Alternative Routing for Network Bandwidth Management feature, or new calls are blocked. For further information about the Alternative Routing for Network Bandwidth Management feature, see *Branch Office Installation and Commissioning (NN43001-314)*. The Call Server continues to monitor the network throughout the network degradation

period. When the degradation is removed or the performance of the network improves, the allowable bandwidth returns to provisioned levels and the Call Server gradually starts allowing new calls.

Essentially, Adaptive Network Bandwidth Management provides a fallback to PSTN on QoS degradation for new calls. As a result, bandwidth is managed and quality measured between all the zones across the entire network, and when necessary corrective action is taken. Due to the real-time interaction with the network, less maintenance is required for the network since the system reacts automatically to network conditions.

With Adaptive Network Bandwidth Management, it is not necessary to provision bandwidth parameters between every zone in the network. Rather, the Call Server automatically learns of new zones in the network and applies Adaptive Network Bandwidth Management to these new zones as required. Therefore, as new Call Servers are added to the network, it is not necessary to re-provision all the other Call Servers on the network to take into account this new Call Server. Conversely, when Call Servers are removed from the network, the remaining Call Servers age out the old Call Server information and therefore, provide only up to date bandwidth information.

This feature operates between all IP Peer CS 1000 systems, including the Media Gateway 1000B and Survivable Remote Gateway 50.

Call scenario

A call is requested from a telephone in VPNI 1/Zone 2 on Call Server A to a telephone in VPNI 3/Zone 3 on Call Server B. Both zones have Adaptive Network Bandwidth Management enabled.

1. Call Server A contacts the Network Redirect Server to obtain the address of Call Server B.
2. Call Server A sends a call setup message to Call Server B, identifying the calling telephone's VPNI and zone.
3. Call Server B determines if there is sufficient bandwidth for the call, and sends back the VPNI and zone of the called telephone.
4. Call Server A checks its bandwidth table to determine if there is sufficient bandwidth available for the call from Call Server A to Call Server B.
5. If Call Server A determines there is enough bandwidth available, the call is established; otherwise, alternate treatment is provided in the form of blocking or rerouting the call.

Both Call Server A and Call Server B must consult their own bandwidth tables to determine if there is enough bandwidth for the call to proceed. [Figure 34 "Call Progress with Adaptive Network Bandwidth Management" \(page 112\)](#) shows this scenario.

Figure 34
Call Progress with Adaptive Network Bandwidth Management

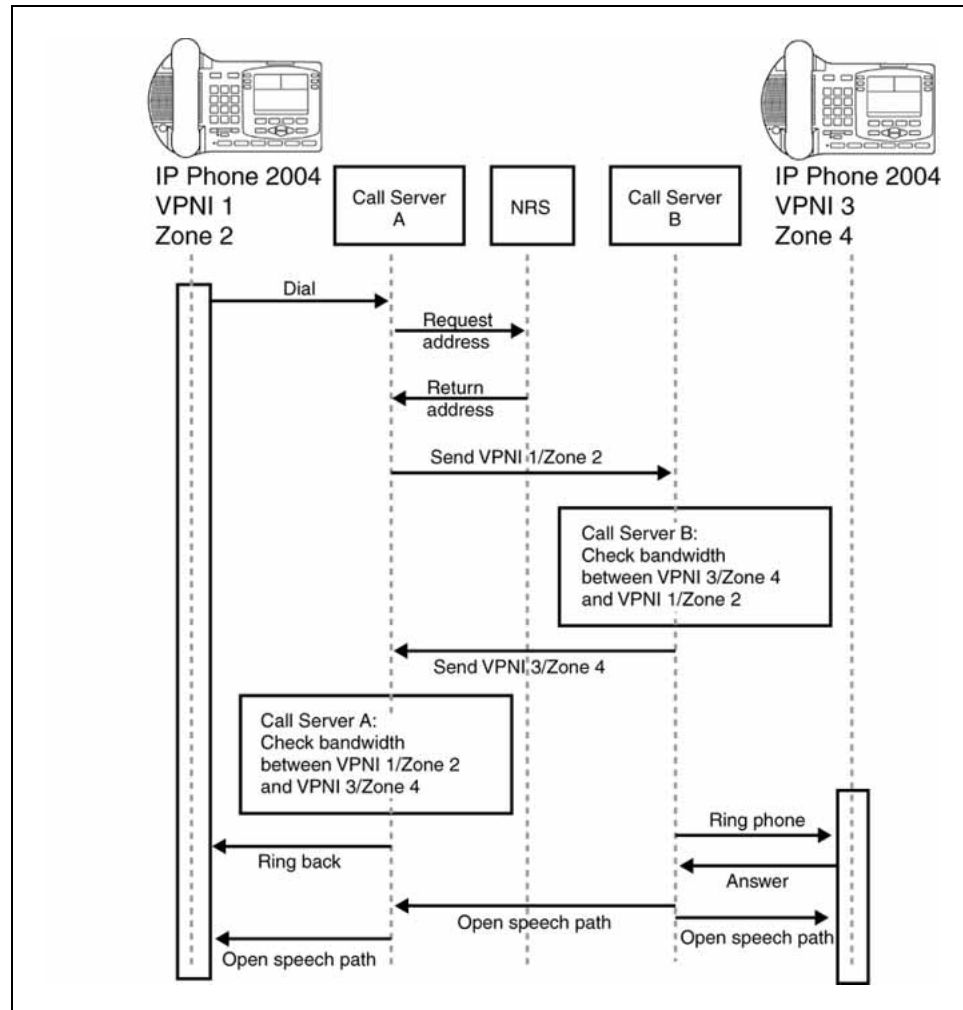

Zone bandwidth management and Adaptive Network Bandwidth Management

Using Element Manager or the Command Line Interface (CLI), previously configured zones (except Zone 0) can have the Adaptive Network Bandwidth Management feature turned on or off. Once turned on, alarm threshold levels and the QoS coefficients can be adjusted from the default values. Adaptive Network Bandwidth Management cannot be enabled for Zone 0.

When Adaptive Network Bandwidth Management is enabled for a particular zone on the Call Server, the zone appears in the zone table. The zone table can be displayed using Element Manager or LD 117. When a call is made from the configured zone to another zone, the bandwidth used appears in the zone table.

When a call is made from a zone with Adaptive Network Bandwidth Management enabled, to a third party gateway, which has no zone, then the zone of the Virtual Trunk (VTRK) is used and appears in the zone table.

Figure 35 "Adaptive Network Bandwidth Management graph" (page 113) shows an example of the bandwidth changes.

Figure 35
Adaptive Network Bandwidth Management graph

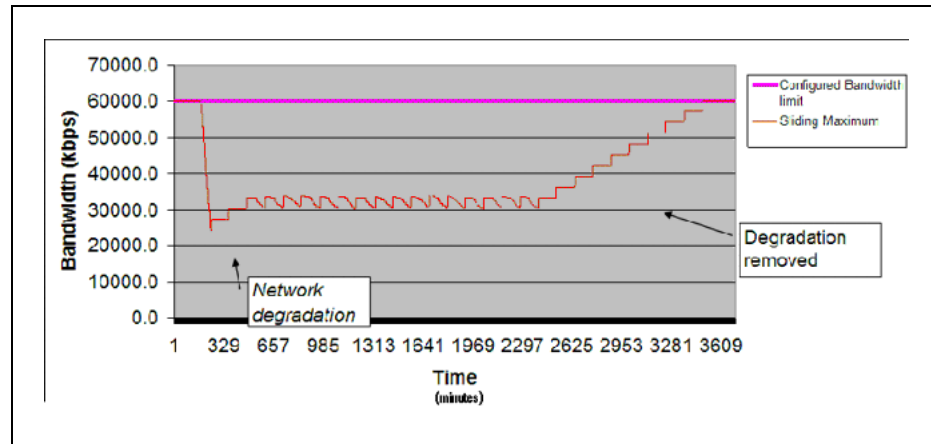

When a Call Server receives a QoS alarm, the two zones that originated the alarm are determined. Using this information, the Call Server reduces the bandwidth limit between the two zones. This zone-to-zone bandwidth limit (in effect at any particular time) is known as the Sliding Maximum Bandwidth Limit and is a percentage of the Configured Interzone bandwidth limit. The Sliding Maximum value is displayed using the `prt interzone` command. The QoS Factor % is also displayed and is the percentage of the Sliding Maximum versus the configured allowable bandwidth. The Call Server checks the Network Bandwidth zone management tables for the originating and terminating zones of the new call to determine the available bandwidth for the call.

For more information about alarms, see *Software Input Output Reference—System Messages (NN43001-712)*.

When feedback indicates a significant QoS change in a zone, the Call Server reduces the available bandwidth (Sliding Maximum Bandwidth Limit) in the zone until the QoS reaches a satisfactory level. Once satisfactory QoS is reached, the bandwidth is slowly raised until either the full bandwidth is available or until QoS degrades again. Bandwidth changes can be configured to be gradual (to reduce rapid swings and variations) or rapid.

Multiple Appearance Directory Numbers (MADN) can exist on different zones. Calls to an MADN are handled the same as other IP Phone calls, and are subject to the same bandwidth limitations.

New SNMP alarms are provided to monitor the system. When the bandwidth limit between zones is reduced below configured levels, an alarm is raised. A Warning alarm and an Unacceptable alarm, each corresponding to a drop below a configured threshold, are used. When the bandwidth returns to normal, the alarm is cleared. If the bandwidth limit reaches zero, an additional Unacceptable alarm is raised. These alarms allow the system administrator to monitor the system and take corrective action when required.

Adaptive Network Bandwidth Management configuration parameters

Packet Loss (pl), Jitter (j) and Delay (d) measurements, along with the R factor (r) in IP Phone 200x Phase II telephones, are used to calculate the QoS level for the zones. The coefficients for these QoS measurements — packet loss (Cpl), jitter (Cj), delay (Cd), and the R factor (Cr) — can be configured and are used to calculate the rate of bandwidth change. Increasing them from their default values causes the Sliding Maximum to decrease faster in response to the specific QoS alarm.

The QoS Coefficient (CQoS) can be varied from its default value. Increasing this value causes the Sliding Maximum to change more rapidly in response to QoS alarms. However, making this value too large will result in loss of overall bandwidth, as shown in [Figure 36 "Effect of the default CQoS Coefficient" \(page 115\)](#) below and [Figure 37 "Effect of a higher CQoS Coefficient" \(page 115\)](#).

Figure 36
Effect of the default CQoS Coefficient

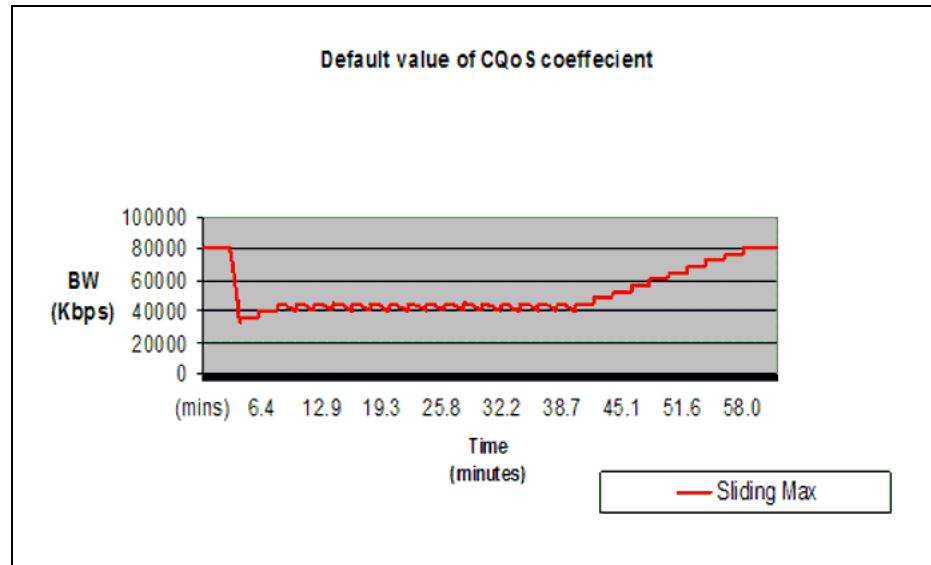
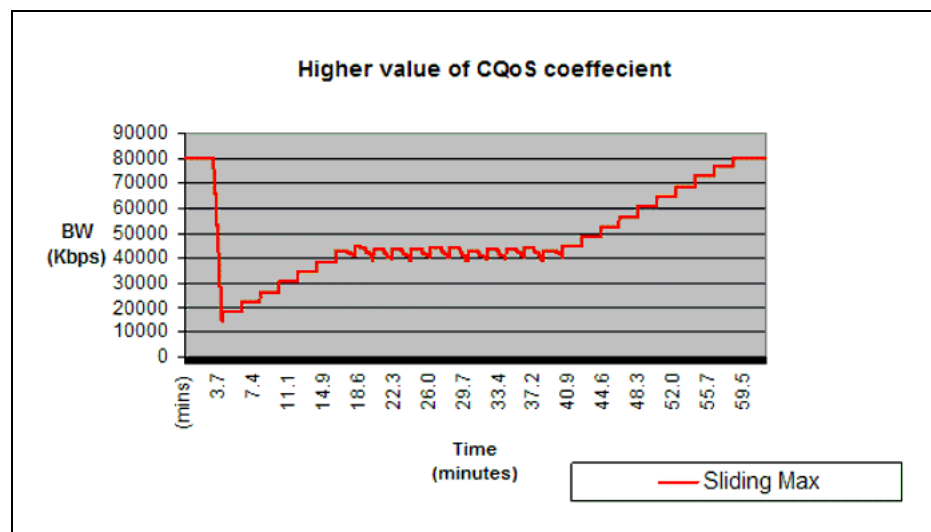

Figure 37
Effect of a higher CQoS Coefficient



Other configurable coefficients used in the calculation are the QoS Coefficient (CQoS), QoS Response Time Increase (ZQRT), and QoS Response Time Interval (ZQRTI). CQoS, Cr, Cd, Cpl, and Cj control the rate of bandwidth decrease, while ZQRT and ZQRTI control the rate of bandwidth increase.

The Call Admission Control (CAC) Validity Time Interval (CACVT) is used to control the length of time that records from a Call Server are saved in the Bandwidth Management table. If there have not been any calls between two Call Servers within the configured time, the Call Server is removed from the table. For example, if Call Server A has Call Server B in the table, and no call has been placed between A and B for the CACVT time, then Call Server A removes all Call Server B records in the table.

Limitations

Virtual Office IP Phones are not subject to bandwidth limitations. They may not have the correct zone information configured. They can also be controlled by a Call Server that is not responsible for the particular zone. Thus, bandwidth management is not possible for these phones.

Feature packaging

The Adaptive Network Bandwidth Management feature requires the following packages:

- QoS Enhanced Reporting (PVQM) package 401

ATTENTION

Package 401, QoS Enhanced Reporting (PVQM), is required if the R value from the Phase II IP Phones is to be reported and used in the calculations.

- Call Admission Control (CAC) package 407

Configuration rules

The configuration rules for Adaptive Network Bandwidth Management are as follows:

- Each main office Call Server in a network must have a unique non-zero VPNI.
- All branch offices associated with a particular main office must have the same VPNI as the main office Call Server.
- All IP Phones (other than specific IP Softphone 2050) and DSP endpoints on a Call Server must be configured for the same zone.
- IP Softphone 2050 being used remotely must be configured for Zone 0.
- Branch office systems must tandem all calls through the main office Call Server to allow bandwidth monitoring and control. In this case, the media path is direct between the branch office and any point in the network.
- Trunk Route Optimization (TRO) must be disabled between the main office Call Server and the SRG. In this case, the media path is direct between the branch office and any point in the network.

- Adaptive Network Bandwidth Management parameters are configured on the main office only and must not be configured at the branch offices.

Configuring Adaptive Network Bandwidth Management

The following is a summary of the tasks necessary to configure Adaptive Network Bandwidth Management in the network.

1. Enable the Call Admission Control (CAC) package.
2. Configure CAC in Element Manager or LD 117:
 - a. Configure the VPNI on the main office and branch offices.
 - b. Configure both the main office and branch office zones at the main office.
 - c. Configure the branch office zone on the SRG.
 - d. Configure the interzone and intrazone bandwidth limits at the main office and SRG.
 - e. Enable Adaptive Network Bandwidth Management for the zones on the main office Call Server.
 - f. If required, alter the Adaptive Network Bandwidth Management parameters in keeping with the information in "[Advanced Configuration Notes](#)" (page 117) below.
3. Tandem the outbound branch office calls by configuring the NRS.
4. Tandem the inbound branch office calls by creating a dialing plan which routes all calls destined for the branch office through the main office.

Advanced Configuration Notes

1. The default values for Cpl, Cj, Cd, Cr and CQos can be increased to increase the response time for Sliding Maximum changes. However, increasing them can cause the Sliding Maximum to temporarily decrease to a lower value than necessary, resulting in the needless blocking of interzone calls.
2. Increasing the value of ZQRT will increase the speed at which the Sliding Maximum increases. The same effect can be achieved by decreasing ZQRTI. However, changing these values can cause the Sliding maximum to oscillate until the network degradation is removed.

Configuration using Element Manager

Element Manager can be used to enable and configure the feature.

The zone must exist before it can be configured for Adaptive Network Bandwidth Management. See *IP Peer Networking Installation and Commissioning (NN43001-313)* for instruction on how to create and configure basic properties of the zone.

To configure the Adaptive Network Bandwidth Management feature, select a zone on the Zones web page. See [Figure 30 "Zones web" \(page 105\)](#) and click **Adaptive Network Bandwidth Management and CAC**. The **Adaptive Network Bandwidth Management and CAC** web page opens, as shown in [Figure 38 "Adaptive Network Bandwidth Management and CAC web page" \(page 118\)](#).

ATTENTION

Do not configure Adaptive Networks Bandwidth Management for Zone 0 or Virtual Trunk zones.

Figure 38
Adaptive Network Bandwidth Management and CAC web page

| Input Description | Input Value |
|--|--------------------------|
| Zone Number (ZONE): | 1 |
| Enable Call Admission Control Feature (STATE): | <input type="checkbox"/> |
| OoS Response Time Increase (ZORT): | 10 (1 - 100 %) |
| OoS Response Time Interval (ZORTI): | 5 (1 - 120 min) |
| Warning Alarm Threshold (ZOWAT): | 85 (1 - 99 %) |
| Unacceptable Alarm Threshold (ZOUAT): | 75 (1 - 99 %) |
| R Alarm Coefficient (CR): | 50 (1 - 100) |
| Packet Loss Alarm Coefficient (CPL): | 50 (1 - 100) |
| Delay Alarm Coefficient (CD): | 50 (1 - 100) |
| Jitter Alarm Coefficient (CJ): | 50 (1 - 100) |
| Coefficient for OoS (COoS): | 50 (1 - 100) |
| Record Validity Time Interval (CACVT): | 48 (1 - 255 hour) |

Submit Refresh Cancel

If the Adaptive Network Bandwidth Management feature is enabled using the **Enable Call Admission Control feature (ZCAC)** check box, then the other parameters can be adjusted as required.

[Table 9 "Adaptive Network Bandwidth Management and CAC fields" \(page 119\)](#) shows the fields in the **Adaptive Network Bandwidth Management and CAC** web page, the field definitions, and their LD 117 command equivalent.

Table 9
Adaptive Network Bandwidth Management and CAC fields

| Field Title | Field Definition | LD 117 equivalents |
|---|---|--------------------------|
| Enable Call Admission Control Feature (CAC) | Control the CAC feature for the zone <ul style="list-style-type: none"> • Enable (check box selected) • disable (clear the check box) | ENL ZCAC DIS ZCAC |
| QoS Response Time Increase (ZQRT) | Bandwidth limit increment, as a percentage of the QoS factor for the zone | CHG ZQRT |
| QoS Response Time Interval (ZQRTI) | Time (in minutes) between bandwidth limit increments | CHG ZQRTI |
| Warning Alarm Threshold (ZQWAT) | A QoS value, which is lower than this value, but higher than the Critical (Unacceptable) Alarm Threshold, triggers a Major Alarm. | CHG ZQWAT |
| Critical Alarm Threshold (ZQUAT) | A QoS value, which is lower than this value, triggers an Unacceptable (Critical) Alarm. | CHG ZQUAT |
| R Alarm Coefficient (CR) | The R (Cr) coefficient is used to calculate the QoS value for the zone. | CHG CR |
| Packet Loss Alarm Coefficient (CPL) | The Packet Loss (Cpl) coefficient is used to calculate the QoS value for the zone. | CHG CPL |
| Delay Alarm Coefficient (CD) | The Delay (Cd) coefficient is used to calculate the QoS value for the zone. | CHG CD |
| Jitter Alarm Coefficient (CJ) | The Jitter (Cj) coefficient is used to calculate the QoS value for the zone. | CHG CJ |
| Coefficient of QoS (CQoS) | The Coefficient of QoS (CQoS) is used to calculate the overall QoS value for the zone. | CHG CQOS |
| Recent Validity Time Interval (CACVT) | Amount of time (in hours) for zone-to-zone record validity. Once this interval expires, records for unused zones are purged from the tables. | CHG CACVT |

Configuration using Command Line Interface

You can also configure the Adaptive Network Bandwidth Management feature using LD 117.

LD 117 Configure Adaptive Network Bandwidth Management

| Command | Description |
|-----------------------------|-------------|
| CHG CACVT <Zone> <Interval> | |

| Command | Description |
|------------------------|---|
| | <p>Configure the zone-to-zone record validity time interval, where:</p> <ul style="list-style-type: none"> • Zone = 1-255 • Interval = 1-(48)-255 |
| CHG CD <Zone> <Cd> | <p>Change the Cd coefficient in the formula that determines how quickly an alarm reduces the Sliding Maximum bandwidth for the identified zone, where:</p> <ul style="list-style-type: none"> • Zone = 1-255 • Cd = Cd coefficient = 1-(50)-100 |
| CHG CPL <Zone> <Cpl> | <p>Change the Cpl coefficient in the formula that determines how quickly an alarm reduces the Sliding Maximum bandwidth for the identified zone, where:</p> <ul style="list-style-type: none"> • Zone = 1-255 • Cpl = Cpl coefficient = 1-(50)-100 |
| CHG CJ <Zone> <Jitter> | <p>Change the Cj coefficient in the formula that determines how quickly an alarm reduces the Sliding Maximum bandwidth for the identified zone, where:</p> <ul style="list-style-type: none"> • Zone = 1-255 • Jitter = Jitter coefficient = 1-(50)-100 |
| CHG CQOS <Zone> <QoS> | <p>Change the QoS coefficient in the formula that determines how quickly an alarm reduces the Sliding Maximum bandwidth for the identified zone, where:</p> <ul style="list-style-type: none"> • Zone = 1-255 • QoS = QoS coefficient = 1-(50)-100 |
| CHG CR <Zone> <Cr> | <p>Change the Cr coefficient in the formula that determines how quickly an alarm reduces the Sliding Maximum bandwidth for the identified zone, where:</p> <ul style="list-style-type: none"> • Zone = 1-255 • Cr = Cr coefficient = 1-(50)-100 |

| Command | Description |
|--|---|
| CHG ZONE <zoneNumber> <intraZoneBandwidth> <intraZoneStrategy> <interZoneBandwidth> <interZoneStrategy> [<zoneIntent> <zoneResourceType>] | <p>Change the parameters of an existing zone, where:</p> <ul style="list-style-type: none"> • zoneNumber = 1-255 • intraZoneBandwidth = 1000000 (Mbit/s) • intraZoneStrategy = intrazone preferred strategy <ul style="list-style-type: none"> — Best Quality = BQ — Best Bandwidth = BB • interZoneBandwidth = 1000000 (Mbit/s) • interZoneStrategy = intrazone preferred strategy <ul style="list-style-type: none"> — Best Quality = BQ — Best Bandwidth = BB • zoneIntent = type of zone, where: <ul style="list-style-type: none"> — MO = Main Office zone — BMG = Branch Media Gateway (branch office) zone — VTRK = Virtual Trunk zone • zoneResourceType = resource intrazone preferred strategy <ul style="list-style-type: none"> — shared DSP channels (default) = shared — private DSP channels = private <p>In CS 1000 Release 5.0 , the zones that were described with BMG designator stay with BMG one, all the other zones are provided with MO designator. It is possible to update ZoneIntent using the CHG ZONE command.</p> |
| CHG ZQRT <Zone> <Incr> | <p>Change ZQRT, which is Response time increase by percentage. It is used to determine the increase to the Sliding Maximum for the identified zone, where:</p> <ul style="list-style-type: none"> • Zone = 1-255 • Incr = increase value in percentage = 1-(10)-100 |
| CHG ZQRTI <Zone> <Interval> | |

| Command | Description |
|--|---|
| | <p>Change the QoS Response Time Interval while alarms are not coming, in order to increase the Sliding Maximum for the identified zone, where:</p> <ul style="list-style-type: none"> • Zone = 1-255 • Interval = interval in minutes = 1-(5)-120 |
| <p>CHG ZQUAT <Zone> <Thres></p> | <p>Change the QoS Unacceptable Alarm Threshold value for the identified zone, where:</p> <ul style="list-style-type: none"> • Zone = 1-255 • Thres = threshold value = 1-(75)-99 <p>When the zone-to-zone QoS value drops below the threshold value, the alarm is presented. When the zone-to-zone QoS value is greater than this threshold value, this alarm is presented as being deactivated. This value must be below the value of ZQWAT.</p> |
| <p>CHG ZQWAT <Zone> <Thres></p> | <p>Change the QoS Warning Alarm Threshold value for the identified zone, where:</p> <ul style="list-style-type: none"> • Zone = 1-255 • Thres = threshold value = 1-(85)-99 <p>When the zone-to-zone QoS value drops below the threshold value, the alarm is presented. When the zone-to-zone QoS value is greater than this threshold value, this alarm is presented as being deactivated. The value for ZQWAT must be higher than the value of ZQUAT.</p> |
| <p>NEW ZONE <zoneNumber> [<intraZoneBandwidth> <intraZoneStrategy> <interZoneBandwidth> <interZoneStrategy> <zoneIntent> <zoneResourceType>]</p> | |

| Command | Description |
|-----------------|---|
| | <ul style="list-style-type: none"> • zoneNumber = 1-255 • intraZoneBandwidth = 1000000 (Mbit/s) • intraZoneStrategy = BQ (Best Quality) • interZoneBandwidth = 1000000 (Mbit/s) • interZoneStrategy = intrazone preferred strategy <ul style="list-style-type: none"> — Best Quality = BQ — Best Bandwidth = BB • zoneIntent = type of zone, where: <ul style="list-style-type: none"> — MO = Main Office zone — BMG = Branch Media Gateway (branch office) zone — VTRK = Virtual Trunk zone • zoneResourceType = resource intrazone preferred strategy <ul style="list-style-type: none"> — shared DSP channels (default) = shared — private DSP channels = private |
| DIS ZCAC <Zone> | <p>Disables the Call Admission Control (CAC) feature for the specified zone, where:</p> <ul style="list-style-type: none"> • Zone = 1-255 <p>This disables the feature on a zone-by-zone basis.</p> |
| ENL ZCAC <Zone> | <p>Enables the Call Admission Control (CAC) feature for the specified zone, where:</p> <ul style="list-style-type: none"> • Zone = 1-255 <p>This enables the feature on a zone-by-zone basis.</p> |

Maintenance commands

The Adaptive Network Bandwidth Management feature can be maintained using Element Manager or LD 117.

Maintenance using Element Manager

The CAC parameters, intrazone statistics, and interzone statistics for one or more zones are available in Element Manager from the Zones web page, shown in [Figure 30 "Zones web" \(page 105\)](#). To view the intrazone or interzone statistics, use [Procedure 7 "Printing intrazone and interzone statistics for a zone" \(page 106\)](#). To display the CAC parameters, follow the steps in [Procedure 8 "Displaying CAC parameters for one or more zones" \(page 124\)](#).

Procedure 8

Displaying CAC parameters for one or more zones

| Step | Action |
|------|--|
| 1 | Select IP Network > Zones from the navigator. The Zones web page opens (see Figure 30 "Zones web" (page 105)). |
| 2 | Click Maintenance Commands for Zones (LD 117) . The Maintenance Commands for Zones web page appears, as shown in Figure 31 "Maintenance Commands for Zones web page" (page 107) . This page lists all the configured zones and their intrazone statistics by default. |
| 3 | Select Print Adaptive Network Bandwidth Management and CAC Parameters (PRT ZCAC) from the Action drop-down list. |
| 4 | Select a zone from the Zone Number drop-down list, by doing one of the following: <ul style="list-style-type: none"> • Select ALL to print statistics for all zones. • Select a specific zone number to display statistics for a specific zone. |
| 5 | Click Submit . The Maintenance Commands for Zones web page reopens, displaying the statistics for the specified zone or zones. A blank field indicates that statistic is either not available or not applicable to that zone. |

[Figure 39 "Element Manager CAC parameters" \(page 125\)](#) shows an example of the CAC parameters.

Figure 39
Element Manager CAC parameters

Managing: 192.167.192.1
 System > IP Network > Zones > Maintenance Commands for Zones

Maintenance Commands for Zones

Action: Print Adaptive Network Bandwidth Management and CAC Parameters (PRT ZCAC) ▾

Zone Number: ALL ▾

| Zone Number | State | Response Time | | Alarm Threshold(%) | | Coefficient for QoS | Alarm Coefficient | | | | Record Validity Time(hours) |
|-------------|----------|---------------|----------------|--------------------|--------------|---------------------|-------------------|-------------|-------|--------|-----------------------------|
| | | Increase (%) | Interval (min) | Warning | Unacceptable | | R | Packet Loss | Delay | Jitter | |
| 0 | DISABLED | 10 | 5 | 85 | 75 | 50 | 50 | 50 | 50 | 50 | 48 |
| 1 | DISABLED | 10 | 5 | 85 | 75 | 50 | 50 | 50 | 50 | 50 | 48 |
| 2 | DISABLED | 10 | 5 | 85 | 75 | 50 | 50 | 50 | 50 | 50 | 48 |
| 3 | DISABLED | 10 | 5 | 85 | 75 | 50 | 50 | 50 | 50 | 50 | 48 |
| 4 | DISABLED | 10 | 5 | 85 | 75 | 50 | 50 | 50 | 50 | 50 | 48 |
| 5 | DISABLED | 10 | 5 | 85 | 75 | 50 | 50 | 50 | 50 | 50 | 48 |

Number of Zones configured = 6

—End—

Maintenance using LD 117

The same information can be displayed using commands in LD 117.

LD 117 Display Adaptive Network Bandwidth Management information

| Command | Description |
|--|--|
| CLR CACR <nearZone> [<nearVPNI>] [<farZone>] [<farVPNI>] | <p>Clear zone-to-zone record for near (VPNI-Zone) for far (VPNI-Zone), where:</p> <ul style="list-style-type: none"> • nearZone = 0-255 • nearVPNI = 1-16383 • farZone = 0-255 • farVPNI = 1-16383 |
| PRT INTRAZONE [<zone>] | |

| Command | Description |
|--|---|
| | <p>Print intrazone statistics for the identified zones, where:</p> <ul style="list-style-type: none"> • zone = ALL or 1-255 <p>The output of this command displays the following information:</p> <ul style="list-style-type: none"> • Zone • State = ENL/DIS • Type = PRIVATE/SHARED • Strategy = BB/BQ • MO/TRK/BMG = zoneIntent • Bandwidth = Kbps • Usage = Kbps • Peak = % <p>Figure 40 "Sample output for PRT INTRAZONE command" (page 128) shows an example of the output for this command.</p> |
| <p>PRT INTERZONE [<nearZone>] [<nearVPNI>] [<farZone>] [<farVPNI>]</p> | <p>Print interzone statistics for the specific VPNI zone; where:</p> <ul style="list-style-type: none"> • nearZone = ALL or 0-255 • nearVPNI = 1-16383 • farZone = 0-255 • farVPNI = 1-16383 <p>The output of this command displays the following information:</p> <ul style="list-style-type: none"> • Near end Zone • Near end VPNI • Far end Zone • Far end VPNI • State = ENL/DIS • Type = PRIVATE/SHARED |

| Command | Description |
|---------|---|
| | <ul style="list-style-type: none"> • Strategy = BB/BQ • MO/VTRK/BMG = zoneIntent • QoS factor = % • Bandwidth configured = Kbps • Sliding max = Kbps • Usage = Kbps • Peak = % • Call = Cph • Alarm = Aph <p>The report rows are grouped as:</p> <ul style="list-style-type: none"> • First row = summary bandwidth usage per near zone • Next rows = bandwidth usage per near (VPNI- Zone) and far (VPNI - Zone) <p>Figure 41 "Sample output for PRT INTERZONE command" (page 129) shows an example of the output for this command.</p> <p>PRT ZCAC [<zone>]</p> <p>Print CAC parameters for the specified zone, or for all zones, where:</p> <ul style="list-style-type: none"> • zone = ALL or 0-255 <p>The output of this command displays the following information:</p> <ul style="list-style-type: none"> • Local ZONE = 0-255 • State = ENL/DIS • CR = 1-100 • CPL = 1-100 • CD = 1-100 • CJ = 1-100 • CQOS = 1-100 • ZQRT = 1-100 |

| Command | Description |
|---------|---|
| | <ul style="list-style-type: none"> • ZQRTI = 10-120 • ZQUAT = 1-99 • ZQWAT = 1-99 • CACVT = 1-255 |

Sample outputs for PRT commands Figure 40 "Sample output for PRT INTRAZONE command" (page 128) shows an example of the output of the PRT INTRAZONE command. Figure 41 "Sample output for PRT INTERZONE command" (page 129) shows an example of the output of the PRT INTERZONE command.

Figure 40
Sample output for PRT INTRAZONE command

```
=> prt intrazone
```

| Zone | State | Type | Strategy | MO/ VTRK/ BMG | Bandwidth kbps | Usage kbps | Peak % |
|------|-------|--------|----------|---------------------|-------------------|---------------|-----------|
| 2 | ENL | SHARED | BQ | MO | 10000 | 190 | 3 |
| 44 | ENL | SHARED | BQ | BMG | 10000 | 0 | 1 |

Number of Zones configured = 2

Figure 41
Sample output for PRT INTERZONE command

```

=> prt interzone
Near end | Far end | State | Type | Stra | MO/ | QoS | Bandwidth | Sliding | Usage | Peak | Calls | Alarm
Zone | Zone | | | tegy | VTRK | tor | Conf | max | | | | |
VPNI | VPNI | | | | | | | | | | | |
2 | | | ENL | SHARED | BB | MO | | 10000 | | kbps | 78 | 1 |
2 | 1 | 33 | 1 | ENL | SHARED | BB | MO | 100 | 10000 | | kbps | 78 | 1 | 1 | 0
33 | | | ENL | SHARED | BB | BMG | | 10000 | | kbps | 78 | 1 |
33 | 1 | 2 | 1 | ENL | SHARED | BB | BMG | 100 | 10000 | | kbps | 78 | 1 | 1 | 0
Number of Zones configured = 1
  
```

Note: The Far end and VPNI fields are displayed only when Adaptive Bandwidth Management is enabled in LD 117.

Tandem Bandwidth Management overview

In order for the main office to correctly keep track of all the bandwidth being used to and from a branch office the call must be tandemed through the main office. When calls are tandemed through the main office only the signaling is tandemed, the actual voice bandwidth travels directly between the source and destination.

Bandwidth utilization for the branch office is tracked at the main office and can be displayed in LD 117 using the PRT INTERZONE command. In order to provide the correct bandwidth utilization to the main office Call Server, when a branch office is calling another node in the network, the calls must be tandemed through the main office Call Server in both the inbound and outbound direction.

Entering the main office Gateway endpoint identifier in the Tandem Endpoint field for each branch office gateways configured on the NRS only provides tandeming in the outbound direction from each branch office (from branch office to main office).

In order to tandem calls through the main office in the inbound direction (from main office to branch office), one must make use of the dialing plan capabilities of the CS 1000 to first route the call to the main office. The main office prepends a prefix to the dialed number and the number is routed to the branch office.

Tandeming all branch office calls through the main office allows the main office to keep track of the bandwidth being used at each branch office.

Application

This feature applies to the branch office and the Adaptive Bandwidth Management feature. Specifically, it applies to calls made to and from the branch office from either telephones registered locally at the branch office (digital, analog [500/2500-type] telephones, and IP Phones) or trunks at the branch office to another node in the network. It does not apply when using branch office IP Phones that are registered with the main office (for example, Normal Mode).

Patch Number

A patch is required on the main office in order to invoke this feature. The patch number is MPLR 20259.

Dialing Plan Overview

Depending upon the type of dialing plan used in the network (Coordinated Dialing Plan [CDP], or Uniform Dialing Plan [UDP] or a combination of both) the general idea is to have all calls that are terminating at a branch office first dial a number that will get routed to the main office associated with that branch office. The main office recognizes this number as belonging to the branch office and appends a tandem prefix to this number using Digit Manipulation Index (DMI). The main office then routes the call to the branch office while accounting for the additional bandwidth used.

See [Figure 42 "A call between two branch offices tandems through the main office" \(page 131\)](#) for an example of a tandem call.

Figure 42**A call between two branch offices tandems through the main office**

Figure 43 "General legend" (page 132) shows a general legend for the figures in the following section.

Figure 43
General legend

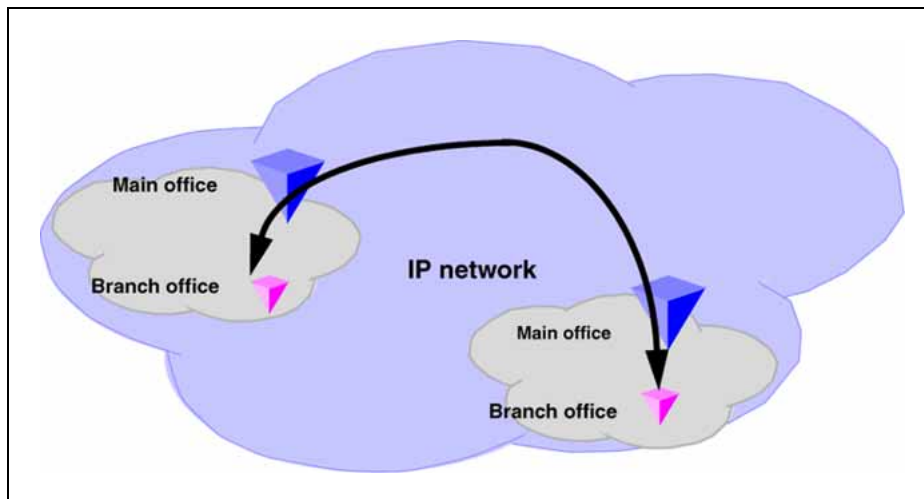
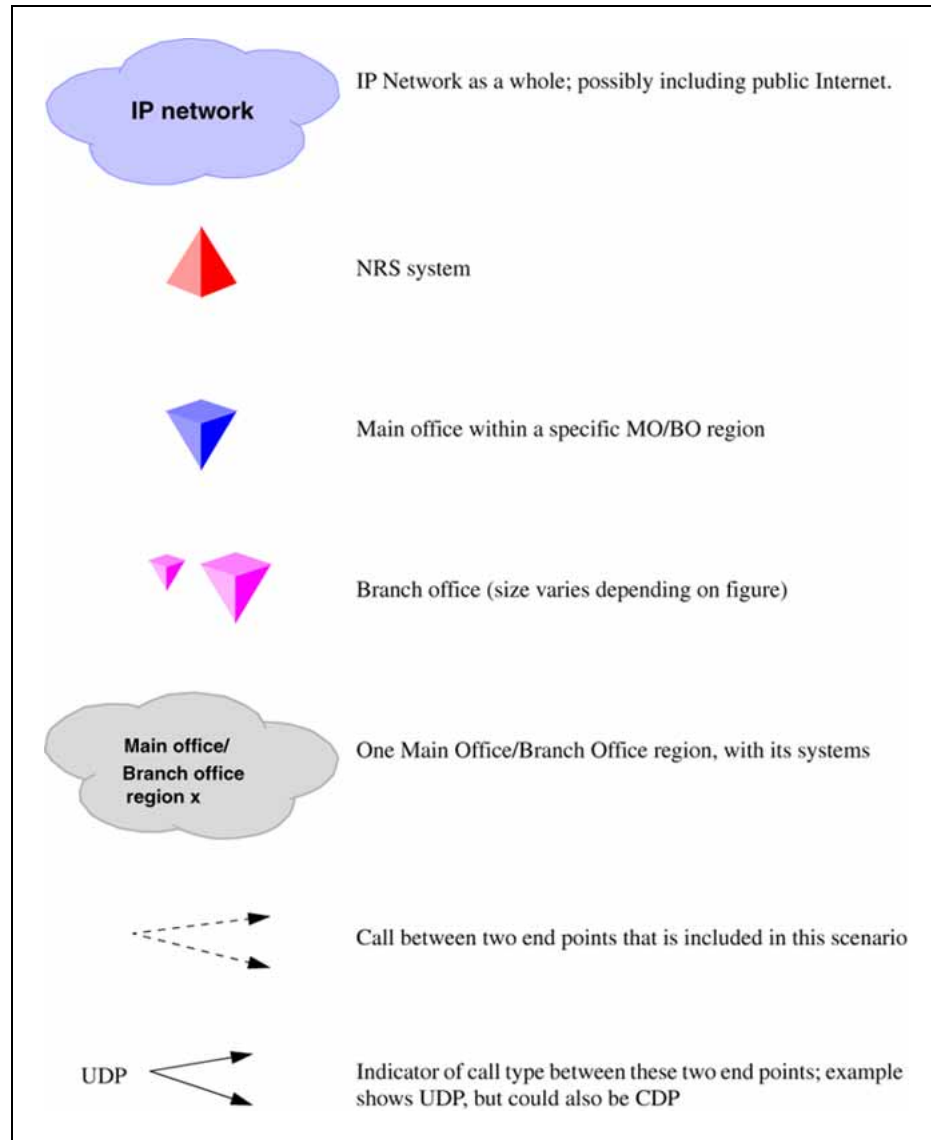

Network using Uniform Dialing Plan

The following section provides general network configuration for a network using UDP only.

Figure 44 "Scenario 1: UDP throughout the network" (page 133) shows two or more main offices with their branch offices, within a larger network. Callers within each main office/branch office region use UDP to place calls between systems. Callers also use UDP to place calls across the IP network to the other main office(s) and its (their) branch offices.

In a typical network, a full region uses a single Home Location Code (HLOC). However, it is also possible, where the number of users requires it, to have two or more codes, although using one for the main office and one for each branch office is unlikely at best.

Figure 44
Scenario 1: UDP throughout the network

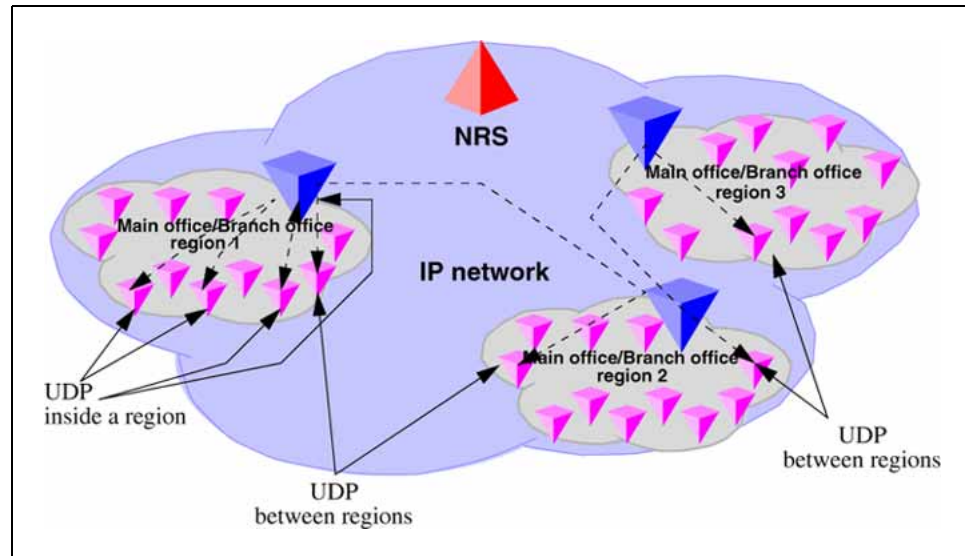

Common details

In general, if an HLOC is shared between two or more systems, the provisioning at the main office gets more complex, unless all branch offices share HLOC with the main office. That is, if the main office has two or more HLOC, and one or more of these (but not necessarily the same one) is used by every branch office, then provisioning is relatively straight forward.

Table 10 "Configuration details for the general case" (page 133) describes the network configuration and the steps that a call takes during its setup.

Table 10
Configuration details for the general case

| Region | Call progress steps | Configuration detail and call progress during call setup |
|---------|---------------------|--|
| 1, 2, 3 | | UDP used for all calls within the region. |
| 1, 2, 3 | | UDP used for region to region calls. |
| 1, 2, 3 | | Prefixes for branch offices for regular calls are required for all branch offices. May have additional prefixes for E-911 calls, if required, or may share prefixes. |

| Region | Call progress steps | Configuration detail and call progress during call setup |
|--------|---------------------|--|
| 1 | 1 | All branch offices are provisioned at the NRS to route all outbound calls (from the branch office) through the main office. (NRS tandem configuration). |
| 1 | 2 | Main office sends all UDP calls to destinations that are not its own branch office to the NRS with unchanged dialled digits. |
| 1 | 3 | Main office sends all UDP calls to destinations that are its own branch office to the NRS with a specific gateway prefix in front of the dialled digits. |
| 1 | 4 | All branch offices delete the prefix and any LOC codes, and terminate the calls. May be to a local set or to a trunk. |
| 2,3 | | Similar call setup steps take places for calls within region 2 and 3. |

Differences when every branch office HLOC is shared with the main office

Table 11 "Provisioning details for this case" (page 134) shows the configuration when the branch office HLOC is shared with the main office.

Table 11
Provisioning details for this case

| Region | Provisioning detail |
|--------|---|
| 1 | Provisioning on the main office requires parsing to only normal LOC identification and HLOC deletion. |
| 1 | LOC values that are on branch offices may be provisioned as extended LOC (> 3 digit codes). |
| 1 | The DMI for the branch office LOC inserts a gateway routing prefix in front of the number. |
| 2,3 | Similar configuration, as above, applies to regions 2 and 3. |

Call between two branch offices associated with the same main office

The following scenarios describe calls between two branch offices that belong to the same main office. the different scenarios described below vary in the manner in which the HLOC is architected; branch offices have same HLOC as the main office, branch offices have a different HLOC than the main office and so on.

Every branch office HLOC is shared with the main office

In the following example, the HLOC of all the branch offices and the HLOC of the main office are all the same. See Figure 45 "Call flow for Scenario 1 - local call" (page 135).

Figure 45
Call flow for Scenario 1 - local call

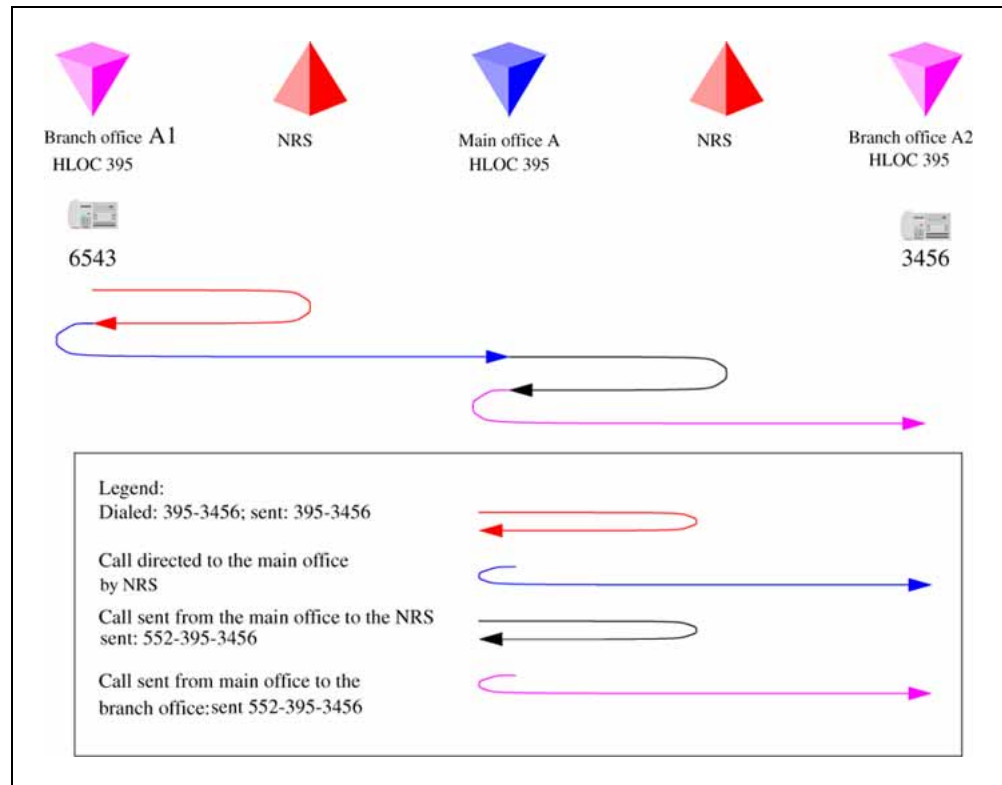

1. The branch office user dials 6-395-3456. The system transmits 395-3456 to the NRS. The NRS checks its provisioning, and determines that all calls are to be sent to the main office; it directs the call to the main office.
2. The branch office sends the call to 395-3456 to the main office.
3. The main office determines that this is LOC 39534, to another branch office, with gateway routing prefix 552. The system inserts the prefix and transmits 552-395-3456 to the NRS. The NRS checks its provisioning, and determines that all calls to prefix 552 are to be sent to branch office A2; it directs the call to the branch office.
4. The main office sends the call to 552-395-3456 to the branch office. The branch office deletes the prefix and the HLOC, and rings set 3456.

No branch office HLOC is shared with the main office, but can be shared with another branch office

In this example, the HLOC of the branch offices are the same but the HLOC of the main office is different. See [Figure 46 "Call flow for Scenario 1 - local call" \(page 136\)](#).

Figure 46
Call flow for Scenario 1 - local call

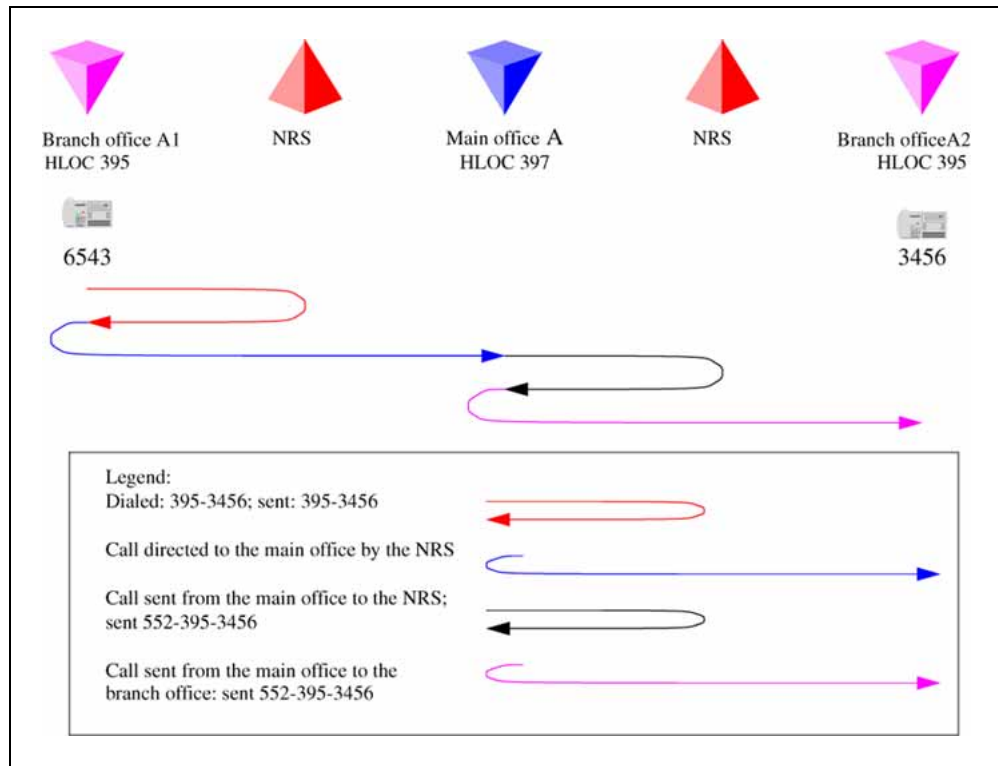

1. The branch office user dials 6-395-3456. The system transmits 395-3456 to the NRS. The NRS checks its provisioning, and determines that all calls are to be sent to the main office; it directs the call to the main office.
2. The branch office sends the call to 395-3456 to the main office.
3. The main office determines that this is LOC 39534 to another branch office, with gateway routing prefix 552. The system inserts the prefix and transmits 552-395-3456 to the NRS. The NRS checks its provisioning, and determines that all calls to prefix 552 are to be sent to branch office A2; it directs the call to the branch office.
4. The main office sends the call to 552-395-3456 to the branch office. The branch office deletes the prefix and the HLOC and rings set 3456.

No branch office HLOC is shared with the main office or another branch office

In this example, the HLOC is unique between all the branch offices and the main office. See [Figure 47 "Call flow for Scenario 1- local call" \(page 137\)](#).

Figure 47
Call flow for Scenario 1- local call

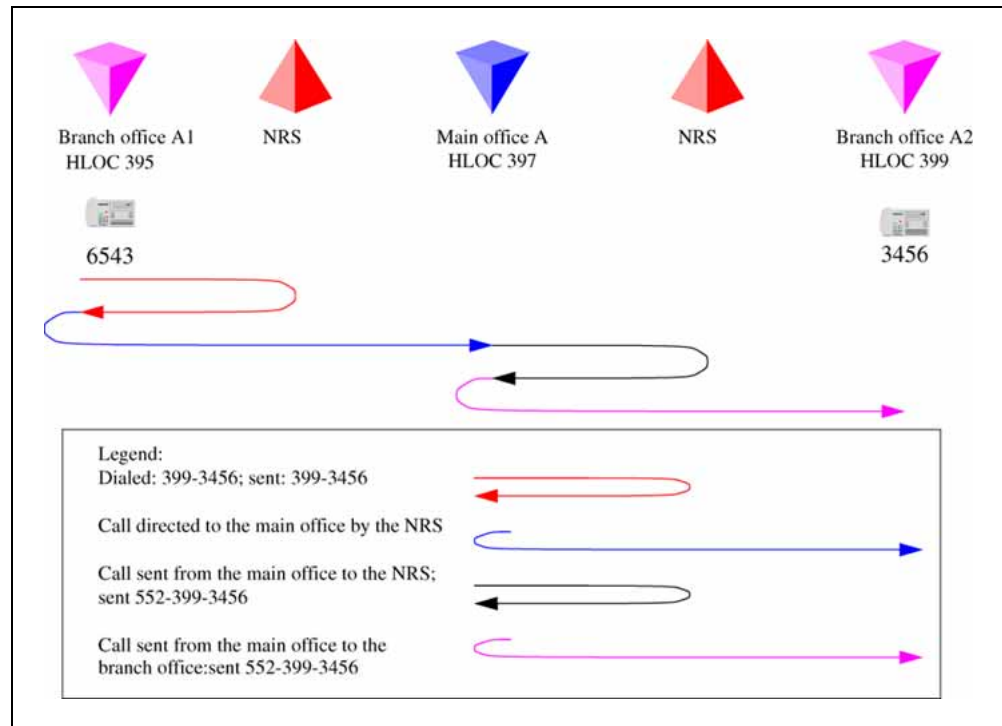

1. The branch office user dials 6-395-3456. The system transmits 399-3456 to the branch office user dials 6-399-3456. NRS. The NRS checks its provisioning, and determines that all calls are to be sent to the main office; it directs the call to the main office.
2. The branch office sends the call to 399-3456 to the main office.
3. The main office determines that this is to another branch office, with office prefix 552. The system inserts the prefix and transmits 552-399-3456 to the NRS. The NRS checks its provisioning, and determines that all calls to prefix 552 are to be sent to branch office A2; it directs the call to the branch office.
4. The main office sends the call to 552-399-3456 to the branch office. The branch office deletes the prefix and the HLOC, and rings set 3456.

Call between branch offices associated with different main office

The following scenarios describe calls between two branch offices that belong to different main offices. Note that the different scenarios described below vary in the manner in which the HLOC is architected; branch offices have same HLOC as the main office, branch offices have a different HLOC than the main office and so on.

Every branch office HLOC is shared with the main office

Figure 48 "Call to a remote branch office on the originator side " (page 138) shows the first half of the call setup (the originator side is side A). In this example, the branch office and the main office share the same HLOC. Figure 49 "Call to remote branch office on the destination side" (page 139) shows the second half of the call (the terminating side is side B).

Figure 48
Call to a remote branch office on the originator side

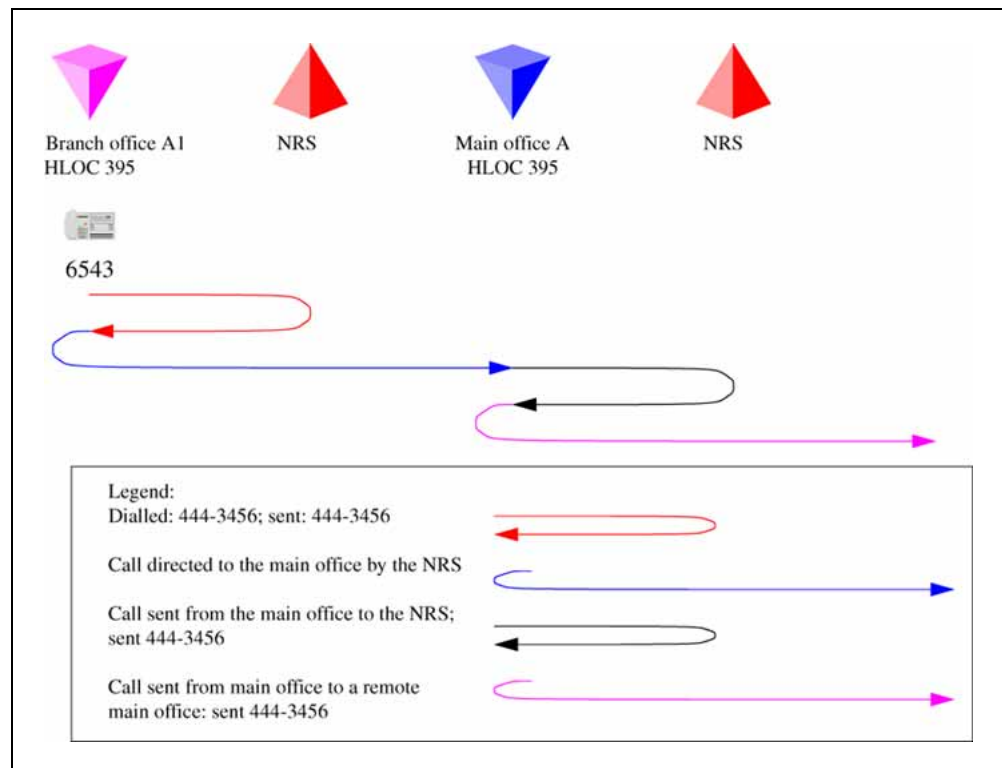

1. The branch office user dials 6-444-3456. The system transmits 444-3456 to the NRS. The NRS checks its provisioning, and determines that all calls are to be sent to the main office; it directs the call to the main office.
2. The branch office sends the call to 444-3456 to the main office.
3. The main office determines that this is to another main office. The system transmits 444-3456 to the NRS. The NRS checks its provisioning, and determines that this call goes to main office B.

Figure 49
Call to remote branch office on the destination side

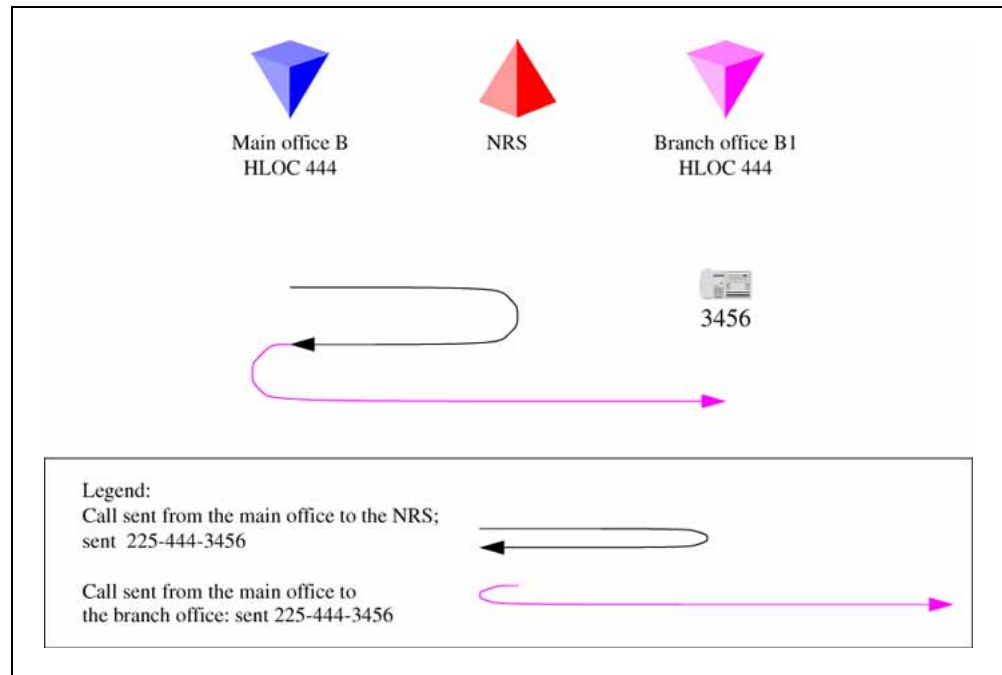

1. Main office B determines that this is to LOC 44434, which is a local branch office with prefix 225. The system transmits 225-444-3456 to the NRS. The NRS checks its provisioning, and determines that this call goes to branch office B1.
2. The main office sends the call to 225-444-3456 to the branch office. The branch office deletes the prefix, discovers the call is to its HLOC 444, deletes the HLOC, and rings set 3456.

No branch office HLOC is shared with the main office, but can be shared with another branch office

[Call to remote branch office on the originator side](#) shows the first half of the call (originator side of the call). [Figure 51 "Call to remote branch office on destination side"](#) (page 141) shows the second half of the call (destination side of the call).

Figure 50
Call to remote branch office on the originator side

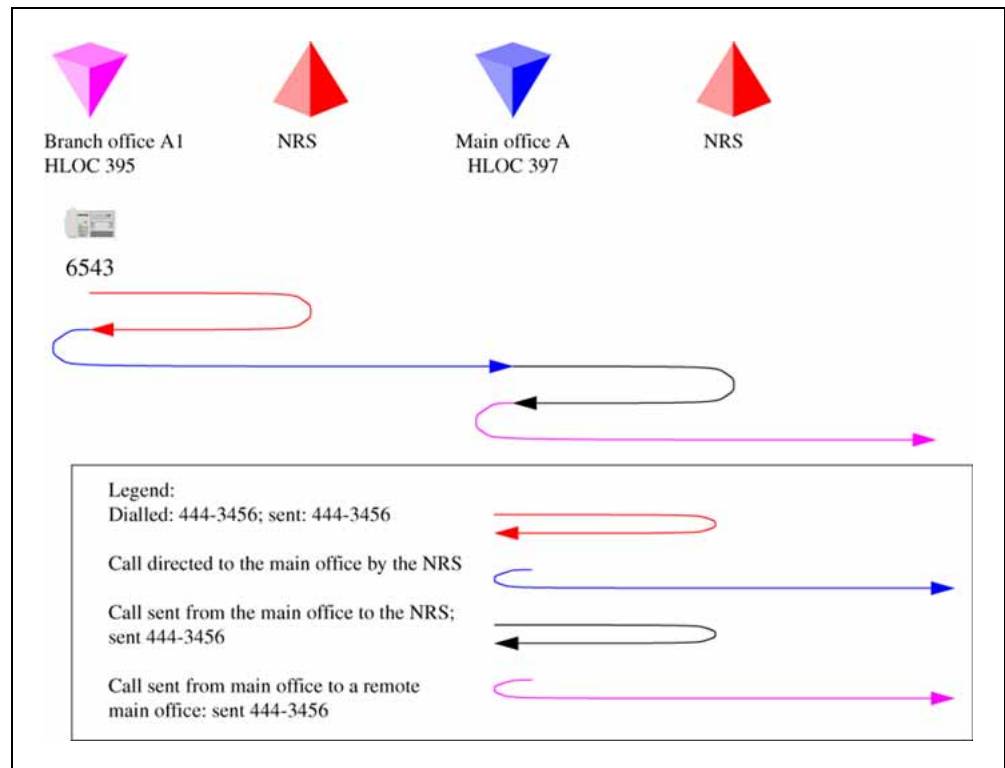

1. The branch office user dials 6-444-3456. The system transmits 444-3456 to the NRS. The NRS checks its provisioning, and determines that all calls are to be sent to the main office; it directs the call to the main office.
2. The branch office sends the call to 444-3456 to the main office.
3. The main office determines that this is to another main office. The system transmits 444-3456 to the NRS. The NRS checks its provisioning, and determines that this call goes to main office B.

Figure 51
Call to remote branch office on destination side

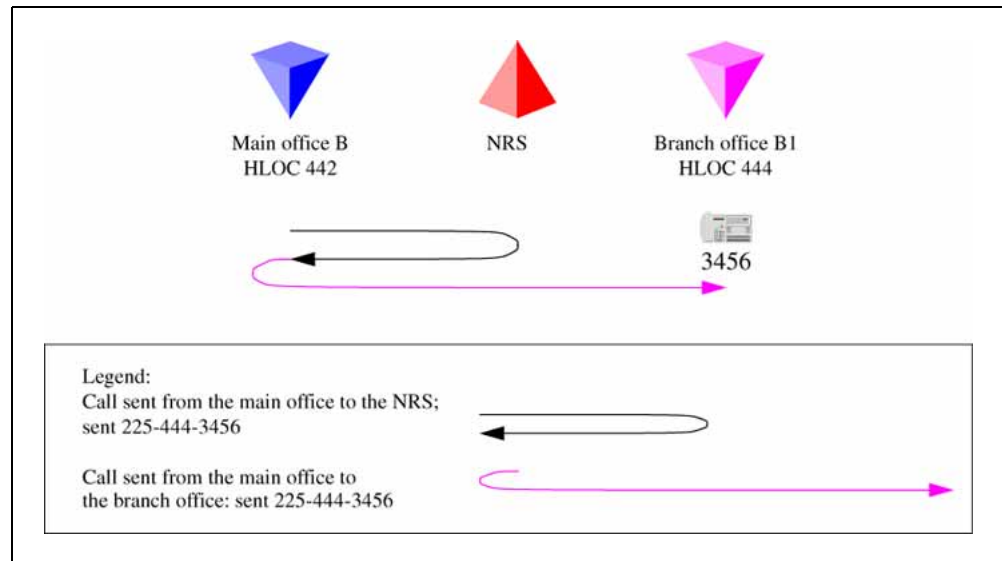

1. Main office B determines that this LOC plus digits is to a local branch office with prefix 225. (If sharing this LOC with another branch office, the extended LOC is 44434.) The system transmits 225-444-3456 to the NRS. The NRS checks its provisioning, and determines that this call goes to branch office B1.
2. The main office sends the call to 225-444-3456 to the branch office. The branch office deletes the prefix, and the HLOC, and rings set 3456.

No branch office HLOC is shared with the main office or another branch office

The following example shows a call between two branch offices. In this example, the HLOC is unique between the main office and branch office. [Figure 52 "Call to remote branch office on the originator side"](#) (page 142) shows the first half of the call (originator side of the call). In [Figure 53 "Call to remote branch office on destination side"](#) (page 143) shows the second half of the call (destination side of the call).

Figure 52
Call to remote branch office on the originator side

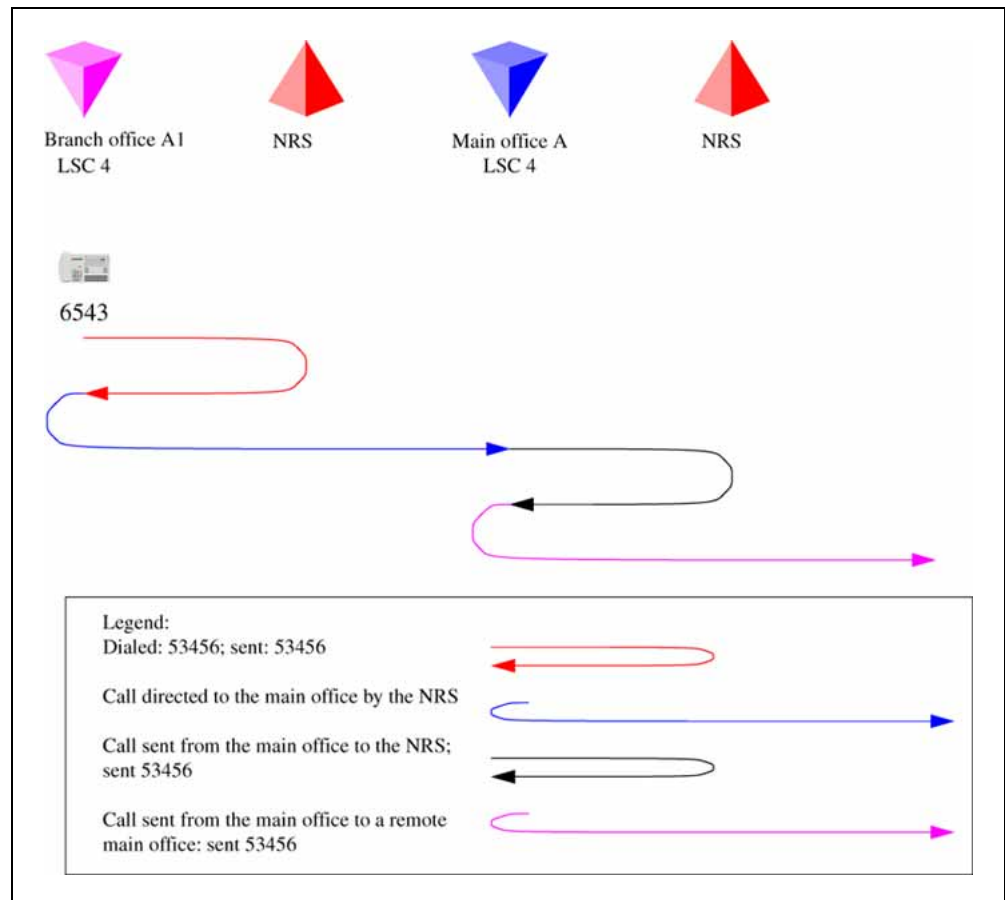

1. The branch office user dials 6-444-3456. The system transmits 444-3456 to the NRS. The NRS checks its provisioning, and determines that all calls are to be sent to the main office; it directs the call to the main office.
2. The branch office sends the call to 444-3456 to the main office.
3. The main office determines that this is to another main office. The system transmits 444-3456 to the NRS. NRS checks its provisioning, and determines that this call goes to main office B.

Figure 53
Call to remote branch office on destination side

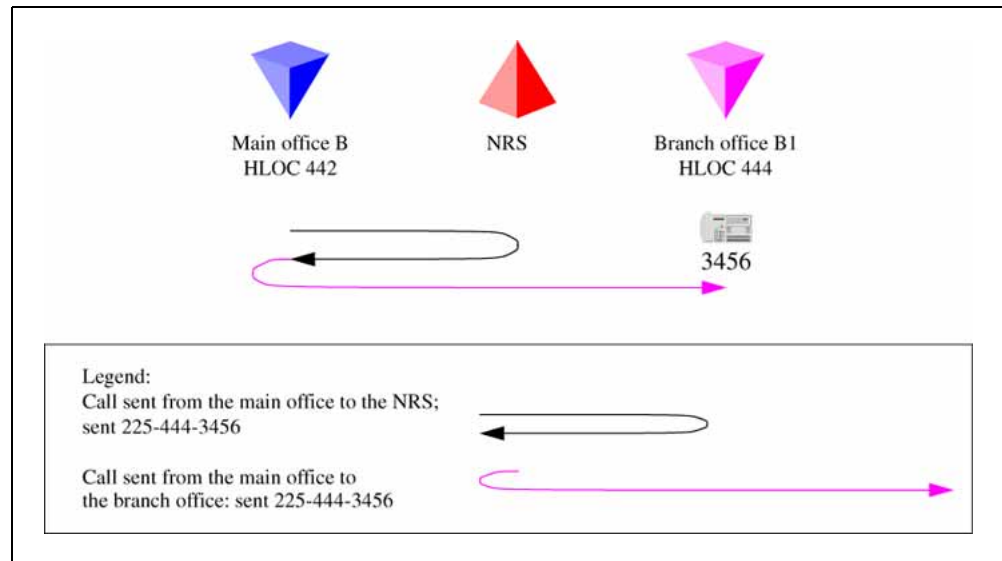

1. Main office B determines that LOC 444 is to a local branch office with prefix 225. The system transmits 225-444-3456 to the NRS. The NRS checks its provisioning, and determines that this call goes to branch office B1.
2. The main office sends the call to 225-444-3456 to the branch office. The branch office deletes the prefix, discovers the call is to its HLOC, deletes the HLOC, and rings set 3456.

Summary of provisioning procedures for Tandem Bandwidth Management

Use [Procedure 9 "Provisioning Tandem Bandwidth Management"](#) (page 145) to provision the network.

| Step | Action |
|------|--|
| 1 | Enter the main office Gateway endpoint identifier in the Tandem Endpoint field for each branch office gateway configured on the NRS. This provides tandeming for outbound calls from a branch office through its main office. See Step 1. |
| 2 | Plan the gateway routing prefixes, if not already done. At least one prefix is needed per branch office, although any branch offices that have a prefix for ESA 911 calls does not necessarily require another. (These prefixes will be SPN - Special Number - entries.) See Step 2. |
| 3 | Provision the NRS to send all calls to a LOC without a gateway routing prefix to the main office of that LOC, or to the main office |

which provides service for the branch office using the LOC. See Step 3.

- 4 Provision the NRS to send all calls to a LOC with a gateway routing prefix to the branch office directly. Using the gateway routing prefix and the Type of Number of SPN, the entries can be differentiated from the normal LOC easily. See Step 4.
- 5 Provision the main office with the DGT table DMI to insert the prefixes and set the Type of Number correctly. Create RLB RLI entries to use these DMI for the VTRK route(s). One RLI per branch office will be the minimum requirement. Note that calls from remote systems will typically have the HLOC prefix, so this is defined here. See Step 5.
- 6 Provision the main office with CDP DSC (mapped by the RLI into Location Codes) sufficient to uniquely identify all of its branch offices (using extended location codes, if required); use the RLI index defined for each branch office as the RLI value of the LOC definition. This is the route to the branch office. See Step 6.
- 7 Provision the main office and branch office with a home location code (HLOC) or multiple codes to terminate all calls that should terminate on this system. See Step 7.
- 8 Provision the main office to send all other LOC to the IP network without prefixes. These are going to a remote main office. See Step 8.
- 9 Provision the branch office with a terminating RLI with a DMI to delete the LOC prefixes. See Step 9.

—End—

Provisioning Example of Tandem Bandwidth Management

Figure 54 "Provisioning example" (page 145) shows an example of the network configuration.

Figure 54
Provisioning example

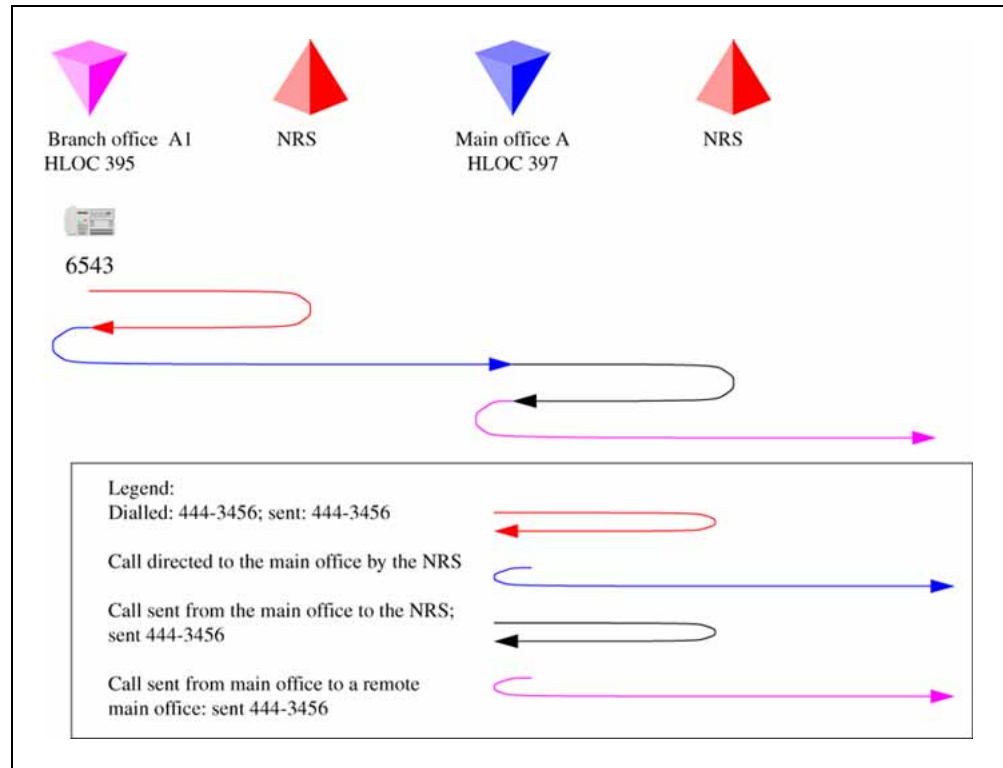

Procedure 9
Provisioning Tandem Bandwidth Management

| Step | Action |
|------|--------|
|------|--------|

- 1 Enter the main office Gateway endpoint identifier in the Tandem Endpoint field for each branch office GW configured on the NRS. This provides tandeming for outbound calls from a branch office through its main office.

Figure 55 "Tandem endpoint configuration in Element Manager" (page 146) shows the tandem endpoint configuration in Element Manager.

Figure 55
Tandem endpoint configuration in Element Manager

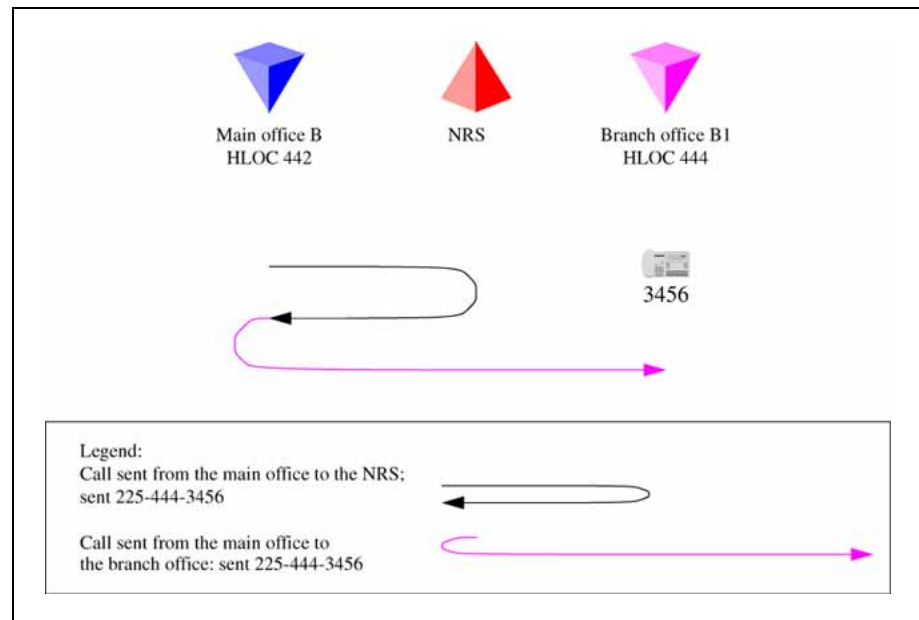

- 2 Plan the gateway routing prefixes. At least one prefix is needed per branch office, although any branch offices that have a prefix for ESA 911 calls does not necessarily require another. (These prefixes will be SPN - Special Number - entries if you are using ESA 911. In the example these are LOC codes because *network 911* is not being used.) In our example the Branch office prefixes are 741 (branch office B) and 742 (branch office A).
- 3 Provision the NRS to send all calls to a LOC without a gateway routing prefix to the main office of that LOC, or to the main office which provides service for the branch office using the LOC. In our example the NRS is provisioned with 841 (for main office B) and 842 (for main office A).
- 4 Provision the NRS to send all calls to a LOC with a gateway routing prefix to the branch office directly. Using the gateway routing prefix and the Type of Number as used (LOC or SPN), the entries can be differentiated from the normal LOC easily. In our example the NRS is provisioned with 741-841 at branch office B and 742-842 for branch office A.
- 5 Provision the main office with the DGT table DMI to insert the prefixes and set the Type of Number correctly. Create RLB RLI entries to use these DMI for the VTRK route(s). One RLI per branch office will be the minimum requirement. Note that calls from remote systems will typically have the HLOC prefix, so this is defined here

Table 12 "Main office B DMI and RLI provisioning for calls in branch office B" (page 147) lists main office B DMI and RLI provisioning.

Table 12
Main office B DMI and RLI provisioning for calls in branch office B

| Create a DMI | Create an RLI |
|--------------|---------------|
| LD 86 | LD 86 |
| REQ new | REQ new |
| CUST 0 | CUST 0 |
| FEAT dgt | FEAT rlb |
| DMI 50 | RLI 50 |
| DEL 0 | ENTR 0 |
| ISPN no | LTER no |
| INST 741841 | ROUT 71 |
| CTYP loc | DMI 50 |

- 6 Provision the main office with CDP DSC (mapped by the RLI into Location Codes) sufficient to uniquely identify all of its branch offices (using extended location codes, if required); use the RLI index defined for each branch office as the RLI value of the LOC definition. This is the route to the branch office.

Table 13 "Main office B LOC provisioning for LOC 741 841" (page 147) lists main office B LOC provisioning.

Table 13
Main office B LOC provisioning for LOC 741 841

| |
|--|
| Create a CDP mapped to the LOC: |
| LD 87 |
| REQ NEW |
| CUST 0 |
| FEAT CDP |
| TYPE DSC |
| DSC 4030 |
| FLEN 4 |
| RLI 50 |
| Create a CDP mapped to the LOC: |
| LD 87 |

- 7 Provision the main office and branch office with a home location code (HLOC) or multiple codes to terminate all calls that should terminate on this system.

[Table 14 " Main office B and branch office B" \(page 148\)](#) lists main office and branch office HLOC provisioning.

Table 14
Main office B and branch office B

| Create a DMI | Create an HLOC |
|--------------|----------------|
| LD 86 | LD 90 |
| REQ new | REQ new |
| CUST 0 | CUST 0 |
| FEAT dgt | FEAT net |
| DMI 61 | TRAN ac1 |
| DEL 3 | TYPE hloc |
| ISPN no | HLOC 841 |
| | DMI 61 |

Repeat the above for all the main offices and branch offices.

- 8 Provision the main office to send all other LOC to the IP network without prefixes. These are going to a remote main office.

[Table 15 "Main office B LOC provisioning for LOC to remote main office system " \(page 148\)](#) lists main office B LOC provisioning for LOC to remote main office. The Main Office A is LOC 842.

Table 15
Main office B LOC provisioning for LOC to remote main office system

| Create an RLI | Create a LOC |
|---------------|--------------|
| LD 86 | LD 90 |
| REQ new | REQ NEW |
| CUST 0 | CUST 0 |
| FEAT rlb | FEAT NET |
| RLI 51 | TRAN AC1 |
| ENTR 0 | TYPE LOC |
| LTER no | LOC 842 |
| ROUT 71 | FLEN 7 |
| | RLI 51 |

Table 16 "Main office A LOC provisioning for LOC to remote main office systems " (page 149) lists main office A LOC provisioning for LOC to the remote office. The Main office B is LOC 841

Table 16
Main office A LOC provisioning for LOC to remote main office systems

| Create an RLI | Create a LOC |
|---------------|--------------|
| LD 86 | LD 90 |
| REQ new | REQ NEW |
| CUST 0 | CUST 0 |
| FEAT rlb | FEAT NET |
| RLI 71 | TRAN AC1 |
| ENTR 0 | TYPE LOC |
| LTER no | LOC 841 |
| ROUT 75 | FLEN 7 |
| | RLI 71 |

- 9 Provision the branch office with a terminating RLI with a DMI to delete the LOC prefixes.

Table 17
Branch office terminating RLI provisioning

| Create a DMI | Create an HLOC |
|--------------|----------------|
| LD 86 | LD 90 |
| REQ new | REQ NEW |
| CUST 0 | CUST 0 |
| FEAT dgt | FEAT net |
| DMI 61 | TRAN ac1 |
| DEL 6 | TYPE hloc |
| ISPN no | HLOC 741 |
| | DMI 61 |

—End—

Network using mixed Coordinated Dialing Plan and Uniform Dialing Plan

The following section provides general details of the network setup. shows an example of a mixed network configuration.

Figure 56
UDP between main offices and CDP inside the main office region

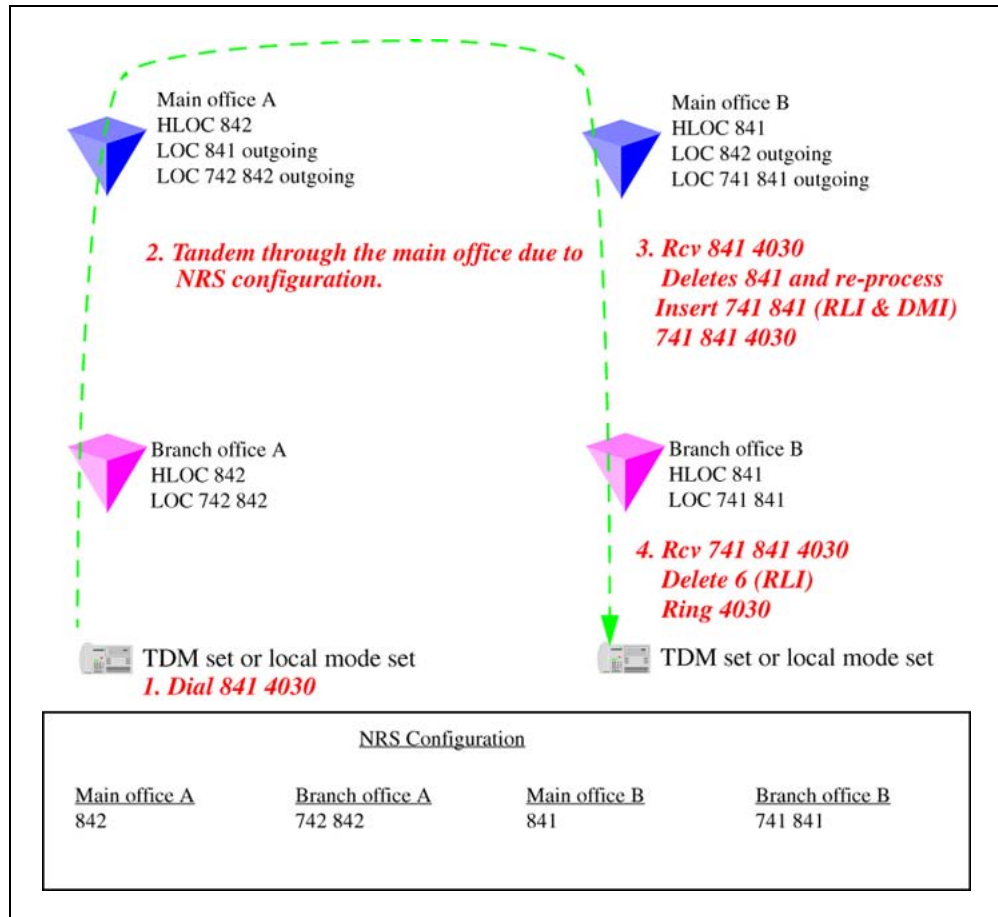

Table 18 "Provisioning details for this case" (page 150) lists provisioning details for a mixed network.

Table 18
Provisioning details for this case

| Region | Provisioning detail |
|---------|--|
| 1, 2, 3 | CDP used for all calls within the region. |
| 1, 2, 3 | UDP used for region to region calls. |
| 1, 2, 3 | Prefixes for branch offices for regular calls not required. May still have prefixes for E-911 calls, if required. |
| 1 | All branch offices are provisioned at the NRS to route all calls through the main office. |
| 1 | Main office sends all UDP calls to destinations that are not its own branch office to the NRS with unchanged dialled digits. |

| Region | Provisioning detail |
|--------|--|
| 1 | Main office sends all UDP calls to destinations that are its own branch office to the NRS after deleting the HLOC and converting to CDP. |
| 2,3 | Similar configuration, as above, applies to regions 2 and 3. |

Call between two local branch offices

Figure 57 "Local call dials CDP" (page 151) shows the NRS Configuration web page in Element Manager.

Figure 57
Local call dials CDP

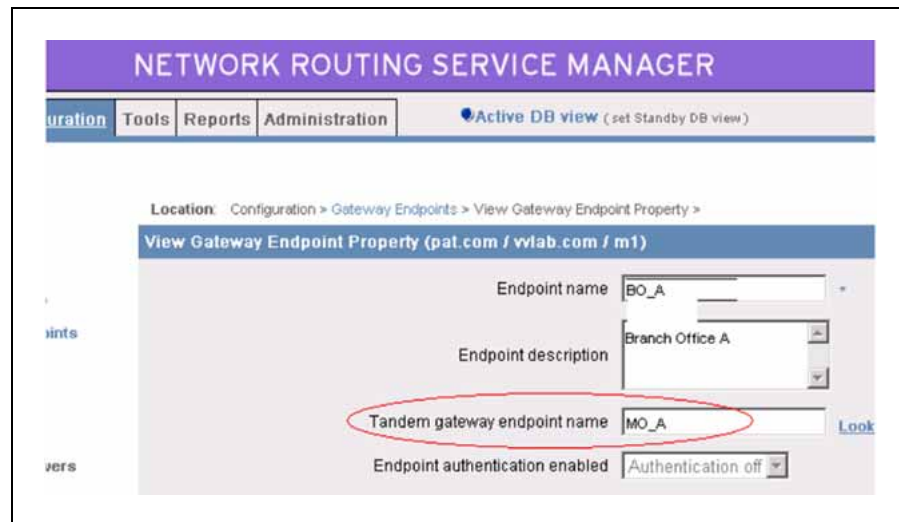

1. The branch office user dials 3456 (CDP). The system transmits 3456 to the NRS. The NRS checks its provisioning, and determines that all calls are to be sent to the main office; it directs the call to the main office.
2. The branch office sends the call to 3456 to the main office.
3. The main office determines that this is to another branch office. The system transmits 3456 to the NRS. The NRS checks its provisioning, and determines that all calls to 3456 in this CDP domain are to be sent to branch office A2; it directs the call to the branch office.
4. The main office sends the call to 3456 to the branch office. The branch office rings set 3456.

Abnormal case - calls originating using UDP, but terminating using CDP

Figure 58

Call flow for Scenario 2 - local call dial UDP

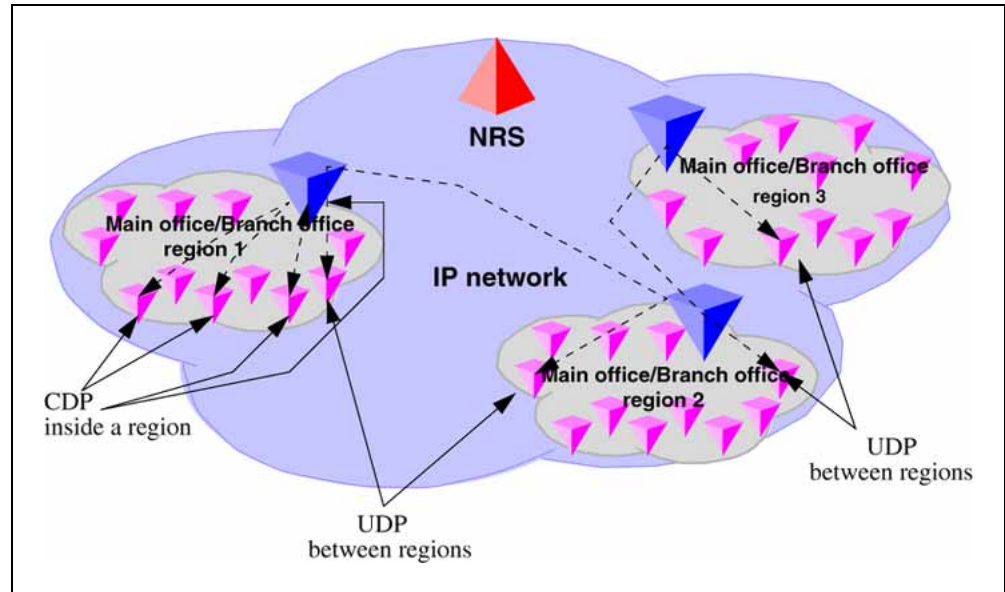

1. The branch office user dials 6-395-3456. The system transmits 395-3456 to the NRS. The NRS checks its provisioning, and determines that all calls are to be sent to the main office; it directs the call to the main office.
2. The branch office sends the call to 395-3456 to the main office.
3. The main office determines that this is to another branch office, using CDP. The system deletes the HLOC and transmits 3456 to the NRS. The NRS checks its provisioning, and determines that all calls to 3456 from this CDP region are to be sent to branch office A2; it directs the call to the branch office.
4. The main office sends the call to 3456 to the branch office. The branch office rings set 3456.

Call between branch offices associated with different main offices

In Figure 59 "Call flow for Scenario 2 - local call to remote branch office (originator side)" (page 153), the first half of the call is shown (the originator side of the call).

Figure 59
Call flow for Scenario 2 - local call to remote branch office (originator side)

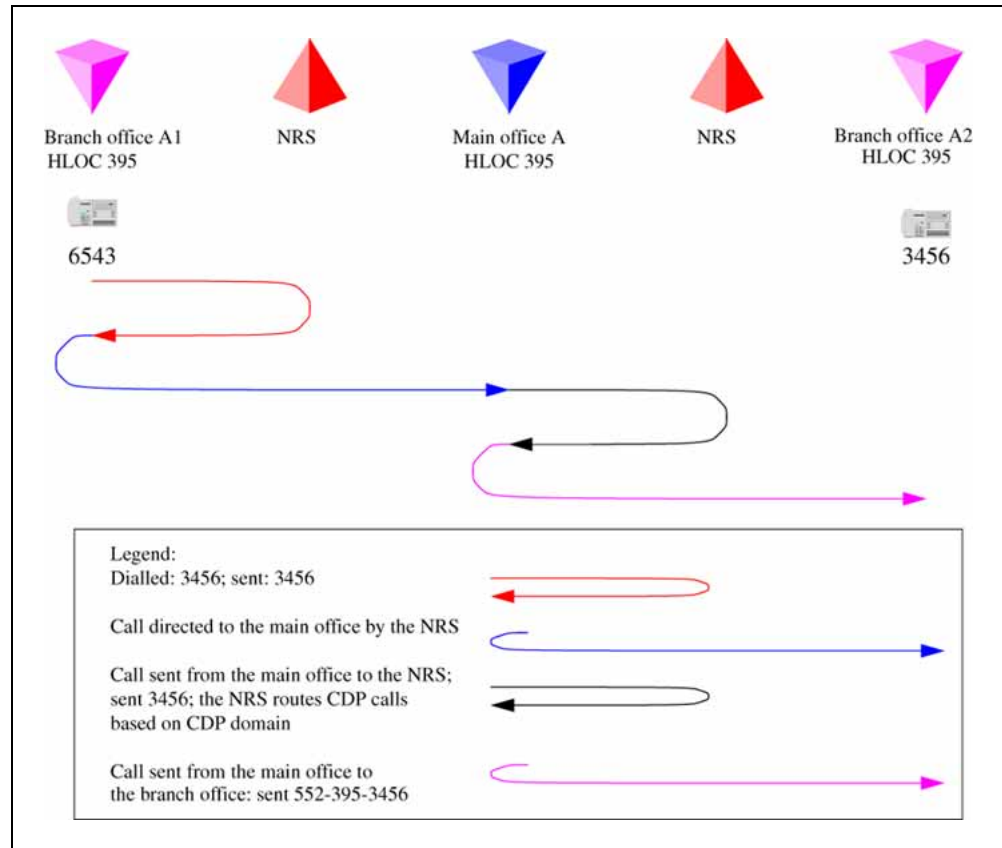

1. The branch office user dials 6-444-3456. The system transmits 444-3456 to the NRS. The NRS checks its provisioning, and determines that all calls are to be sent to the main office; it directs the call to the main office.
2. The branch office sends the call to 444-3456 to the main office. The main office determines that this is to another main office. The system transmits 444-3456 to the NRS. The NRS checks its provisioning, and determines that this call goes to main office B.

Figure 60 "Call to remote branch office on the destination side" (page 154) shows the second half of the call (destination side of the call).

Figure 60
Call to remote branch office on the destination side

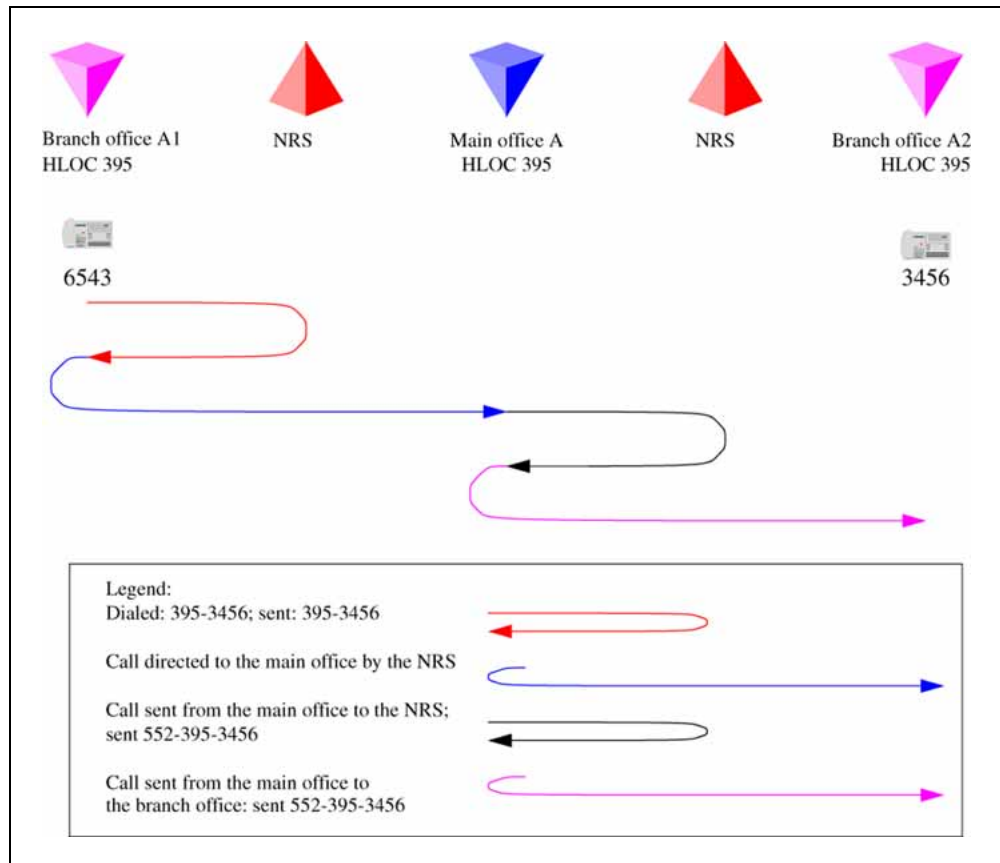

1. The main office B deletes the HLOC, and determines that this is to a local branch office. The system transmits 3456 to the NRS. The NRS checks its provisioning, and determines that for this CDP region this call goes to branch office B1.
2. The main office sends the call to 3456 to the branch office. The branch office rings set 3456.

Network using Coordinated Dialing Plan

The following section provides general details of network setup.

Figure 61 "Full CDP network" (page 155) shows a full CDP network configuration.

Figure 61
Full CDP network

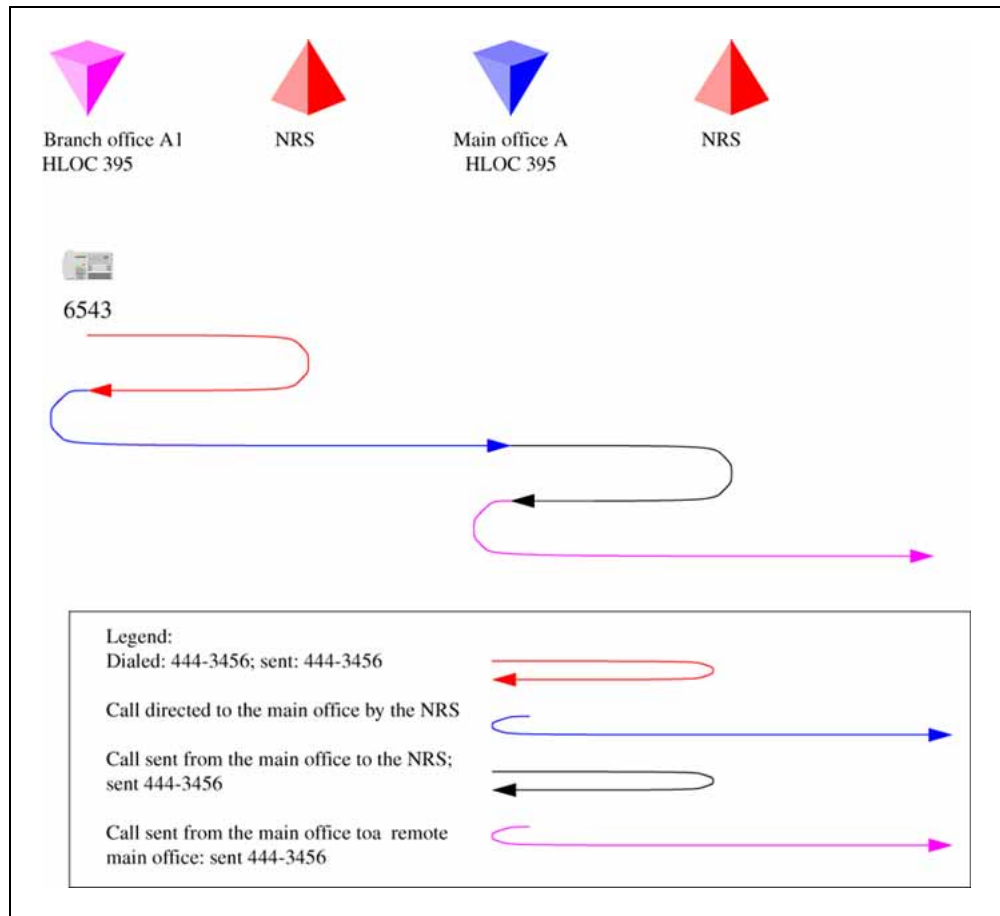

Table 19 "Provisioning details for this case" (page 155) lists the provisioning details for a full CDP network.

Table 19
Provisioning details for this case

| Region | Provisioning detail |
|---------|---|
| 1, 2, 3 | CDP used for all calls within the region. |
| 1, 2, 3 | CDP used for region to region calls. |
| 1, 2, 3 | All CDP numbers must be sufficiently long to allow unique termination of the calls. That is, every main office/branch office region requires its own LSC to ensure that all numbers are unique. |
| 1, 2, 3 | Prefixes for branch offices for regular calls are required. May have additional prefixes for E-911 calls, if required, or may share prefixes. |

| Region | Provisioning detail |
|--------|--|
| 1 | All branch offices are provisioned at the NRS to route all calls through the main office. |
| 1 | Main office sends all CDP calls to destinations that are not its own branch office to the NRS with unchanged dialled digits. |
| 1 | Main office sends all CDP calls to destinations that are its own branch office to the NRS with a specific gateway prefix in front of the dialled digits. |
| 1 | All branch offices delete the prefix and terminate the calls. May be to a local set or to a trunk. |
| 2,3 | Similar configuration, as above, applies to regions 2 and 3. |

Call between two local branch offices

Figure 62 "Call flow for Scenario 3 - local call" (page 156) shows the call flow of a call between two local branch offices.

Figure 62
Call flow for Scenario 3 - local call

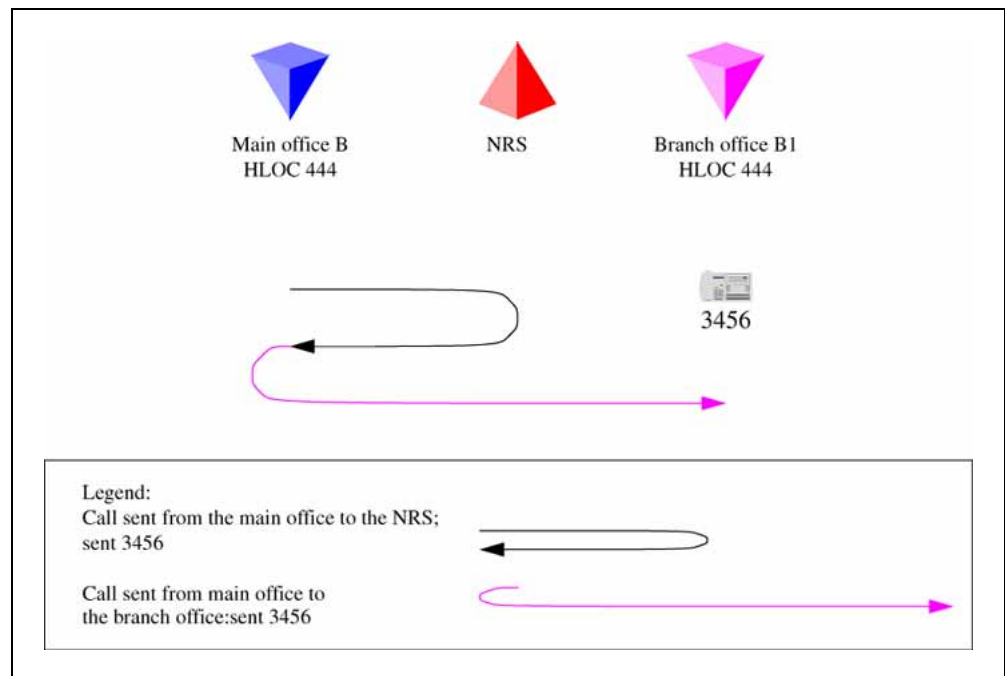

1. The branch office user dials 43456. The system transmits 43456 to the NRS. The NRS checks its provisioning, and determines that all calls are to be sent to the main office; it directs the call to the main office.
2. The branch office sends the call to 43456 to the main office.
3. The main office determines that this is to another branch office, with office prefix 552. The system inserts the prefix and transmits 552-43456

to the NRS. The NRS checks its provisioning, and determines that all calls to prefix 552 are to be sent to branch office A2; it directs the call to the branch office.

4. The main office sends the call to 552-43456 to the branch office. The branch office deletes the prefix and LSC 4, and rings set 3456.

Call between branch offices associated with different main offices

In Figure 63 "Call flow for Scenario 3 - calls to remote branch office (originator side)" (page 157), the first half of the call is shown (originator side of the call).

Figure 63

Call flow for Scenario 3 - calls to remote branch office (originator side)

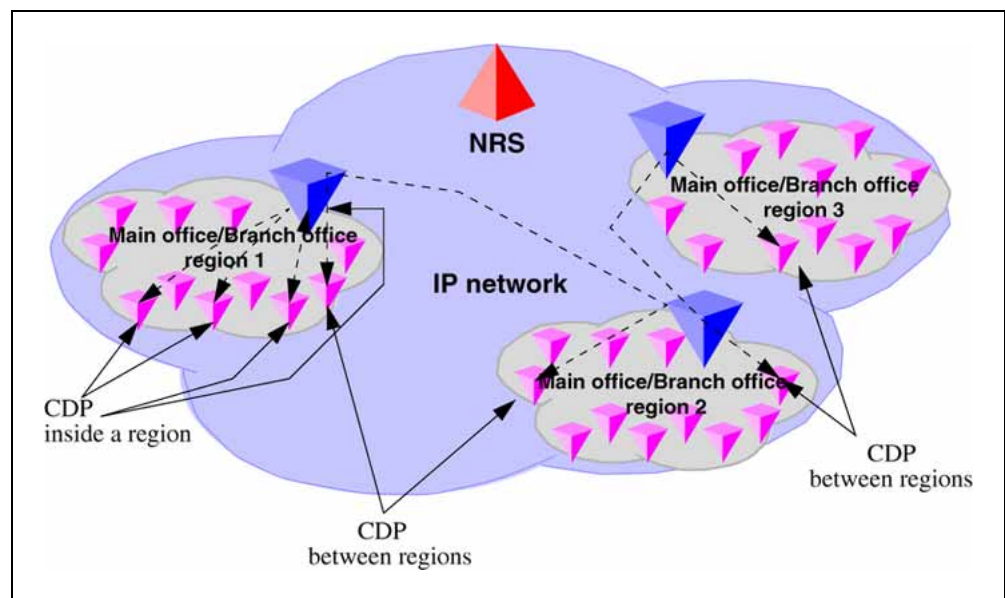

1. The branch office user dials 53456. The system transmits 53456 to the NRS. The NRS checks its provisioning, and determines that all calls are to be sent to the main office; it directs the call to the main office.
2. The branch office sends the call to 53456 to the main office.
3. The main office determines that this is to another main office. The system transmits 53456 to the NRS. The NRS checks its provisioning, and determines that this call goes to main office B.

In Figure 64 "Call flow for Scenario 3- calls to remote branch office (destination side)" (page 158), the second half of the call is shown (destination side of the call).

Figure 64
Call flow for Scenario 3- calls to remote branch office (destination side)

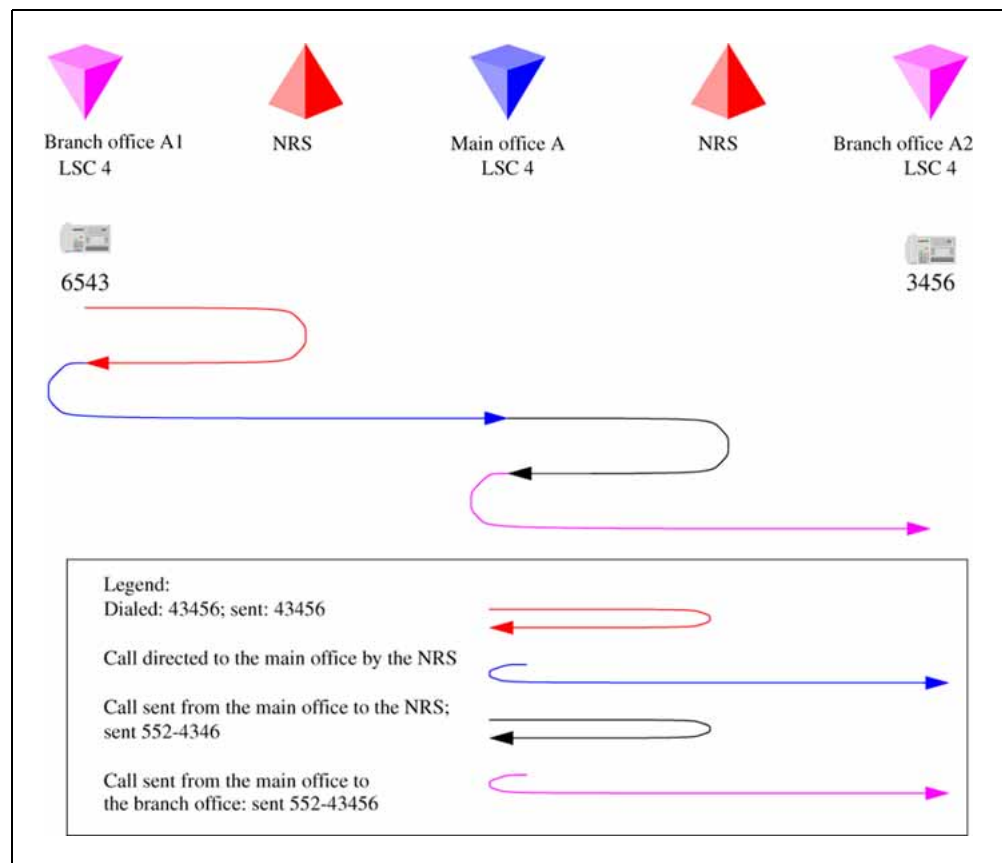

1. Main office B determines that this is to a local branch office with prefix 225. The system transmits 225-53456 to the NRS. The NRS checks its provisioning, and determines that this call goes to branch office B1.
2. The main office sends the call to 225-53456 to the branch office. The branch office deletes the prefix and LSC, and rings set 3456.

Alternative Call Routing for Network Bandwidth Management

Contents

This section contains information on the following topics:

- "Description" (page 159)
- "Operating parameters" (page 174)
- "Feature interactions" (page 175)
- "Feature packaging" (page 176)
- "Feature implementation using Command Line Interface" (page 176)
- "Feature implementation using Element Manager" (page 178)
- "Diagnostics" (page 180)
- "Maintenance" (page 184)
- "Feature operation" (page 187)

Description

Alternative Call Routing for Network Bandwidth Management (NBWM) is available for CS 1000 Release 4.5 and CS 1000 Release 5.0 .

Alternative Call Routing for Network Bandwidth Management (NBWM) allows a station-to-station call (that is, a call that does not use a trunk) between a branch office and main office to overflow to traditional routes. Overflow can occur if there is insufficient interzone bandwidth available to carry the call or if the Quality of Service (QoS) has degraded to unacceptable levels. The feature also applies to station-to-station calls from one branch office to another branch office, provided both stations are registered to the same main office.

Figure 65 "Example of Alternative Call Routing for NBWM in operation" (page 160) shows a diagram of a typical network where Alternative Call Routing for NBWM can be used. It illustrates the sequence of events that are explained in the information following the diagram.

Event number 1 pertains to the originally dialed call that experiences low bandwidth or unacceptable QoS conditions. Event number 2 pertains to the alternately routed call.

Figure 65
Example of Alternative Call Routing for NBWM in operation

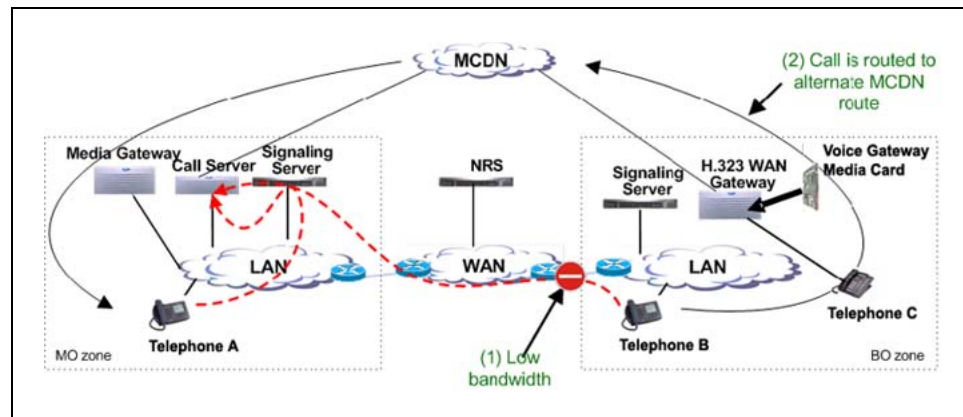

There are multiple choices of alternate routes provided for the overflowed calls. Network administrators who do not want calls to be blocked, but have a limited amount of bandwidth available, want to overflow calls to conventional trunks, (Public Switched Telephone Network [PSTN] or TIE/Meridian Customer Defined Network [MCDN]). This feature allows calls to be routed by overflowing them, trading off the capital cost of WAN bandwidth against the incremental cost of overflowed calls.

Nortel recommends that this feature be used with DID (Direct Inward Dial) numbers. This allows calls that are rerouted over the PSTN to ring the intended telephone directly. It is possible to use this feature without having DID, so that when the call gets rerouted over the PSTN the call reaches an attendant console or a specific telephone.

When there is insufficient bandwidth for a station-to-station call, the Alternative Call Routing for NBWM feature uses a trunk for a call which would not normally use a trunk.

Prior to the introduction of the Alternative Call Routing for NBWM feature, there was no alternate routing mechanism for the following types of station-to-station calls:

- Branch office calls to or from the main office
- Branch office calls to or from another branch office controlled by the same main office

ATTENTION

The term branch office refers to Media Gateway 1000B (MG 1000B) and Survivable Remote Gateway (SRG) systems in this document.

This feature enables alternate routing to occur for branch office users registered to the main office, when they place interzone, station-to-station calls to main office stations or branch office stations.

The Alternative Call Routing for NBWM feature can be triggered by operation of either of the following features:

- NBWM
- Adaptive Network Bandwidth Management

For more information on Network Bandwidth Management and Adaptive Network Bandwidth Management, see *IP Peer Networking Installation and Commissioning (NN43001-313)*.

The Alternative Call Routing for NBWM feature can be implemented to operate in one of the following two ways:

- Bandwidth insufficiency: Alternately routes station-to-station IP network calls that encounter lack of bandwidth or poor QoS in the originating or terminating zone as the calls are being established
- All Calls: Alternately routes station-to-station IP network calls, regardless of available bandwidth

Configure one of these two modes of operation (Bandwidth insufficiency or All Calls) on a zone basis.

The Alternative Call Routing for NBWM feature deals only with interzone calls. This feature is configurable for main office and branch office zones, not virtual trunk zones.

It is possible to configure this feature to reroute all calls to MCDN or PSTN routes and still maintain the main office-branch office architecture.

ALTPrefix

When the Alternative Call Routing for NBWM feature is invoked, the dialed number is modified with a prefix (called the ALTPrefix) inserted at the beginning of the digit string. The ALTPrefix can have a maximum of seven digits.

The system handles the call with the ALTPrefix inserted as if the user had dialed the digits.

The ALTPrefix applies to the zone in which the call originates. There is one ALTPrefix for each zone that requires alternate routing.

All Call Servers must be able to translate the ALTPrefixes for all zones that require Alternative Call Routing for NBWM.

How Alternative Call Routing for NBWM works

When a user dials a station-to-station call between two different zones (that is, the calling and called telephones are not located in the same geographic area) and the bandwidth limit has been reached, then the Alternative Call Routing feature is invoked.

The following steps occur in Alternative Call Routing scenarios.

Call from branch office telephone in Normal Mode

1. The interzone station-to-station call is attempted. There is insufficient bandwidth available to make the call.
2. The main office inserts the ALTPrefix associated with the originator's zone (the branch office in this case) before the dialed digits.
3. The main office uses Coordinated Dialing Plan (CDP) or Vacant Number Routing (VNR) to route the call to a virtual trunk.
4. A request is made to the NRS in order to determine the endpoint. The NRS returns the branch office address as the endpoint.
5. The call is routed on the virtual trunk to the branch office.
6. The branch office treats the ALTPrefix as a steering code. The branch office determines the Route List Index (RLI) and uses a Digit Manipulation Index (DMI) to change the dialed number into a PSTN/MCDN format number.
7. The call is routed over the PSTN/MCDN trunks to the telephone at the main office or other branch office.

Call from main office telephone to branch office telephone

1. The interzone station-to-station call is attempted. There is insufficient bandwidth available to make the call.
2. The main office inserts the ALTPrefix associated with the originator's zone (the main office in this case) before the dialed digits.
3. The main office uses CDP and recognizes the ALTPrefix as a steering code.
4. The main office determines the RLI and uses a DMI to change the dialed number into a PSTN/MCDN format number.
5. The call is routed over the PSTN/MCDN to the telephone at the branch office.

With the ALTPrefix digits inserted, the resulting number must be one that CDP or VNR software can process as a steering code.

For SRG, the main office manipulates the digits in the call into a format appropriate for routing from the SRG on PSTN/MCDN trunks.

The steering code allows the call to be translated and referenced to a Route List Index from which the system chooses the alternate route. The digit manipulation capability of CDP allows digits (such as the ALTPrefix) to be deleted and it can insert digits so the resulting number is appropriate for the alternate route choice selected (PSTN or MCDN). For example, you can manipulate the digits for PSTN routes so that DID destinations are dialable.

Dialing plans

Consider the many ways that calls can be dialed in a network. A station-to-station call can be dialed using the following:

- Directory Number (DN)
- Coordinated Dialing Plan DN (starting with a Local Steering Code or Distant Steering Code)
- Uniform Dialing Plan DN (starting with a Location Code or Home Location Code)
- Transferable DN (TNDN) or Group Dialing Plan DN

Main offices and branch offices must be able to translate the calls, after the ALTPrefix is inserted, using CDP or VNR. Take into account the format of the calls with an ALTPrefix inserted prior to the rest of the digits.

Before deciding whether to program the steering codes as Distant Steering Codes (DSC) or Trunk Steering Codes (TSC), take into account that the system counts the digits in calls that start with a DSC.

Without Flexible Numbering Plan (FNP), DSC calls must have the same number of digits as specified in LD 86 ESN (the NCDP prompt). With FNP, fewer digits are acceptable, if the FLEN prompt is programmed correctly.

The maximum length of a CDP DN is seven digits (if DNXP is not equipped), and ten digits, if DNXP is equipped. For more information see *Dialing Plans Reference (NN43001-283)*.

Calls preceded by the ALTPrefix can be handled by the Vacant Number Routing (VNR) feature. Use Flexible Numbering Plan (FNP) software for this type of routing.

Examples of Alternative Call Routing for NBWM in operation

A call from a branch office telephone to a main office telephone

Figure 66 "Call between a branch office telephone in Normal Mode and a main office telephone" (page 164) shows an example of an alternately routed call between two CS 1000 systems. The system shown on the left is a main office. The system shown on the right is a branch office. Both systems have access to the PSTN. The Wide Area Network (WAN) is shown in the center with a gatekeeper/Network Routing Service (NRS) that can be co-resident with a Signaling Server. IP Phones are also shown associated with each system. Telephone A belongs to the main office. Telephone B is a telephone at the branch office registered to the main office. There are two bandwidth zones indicated by the dashed line (main office zone - MO zone and branch office zone - BO2 zone). Telephone A and the Media Gateway belong to the MO zone. The branch office and Telephone B belong to the BO2 zone.

Figure 66

Call between a branch office telephone in Normal Mode and a main office telephone

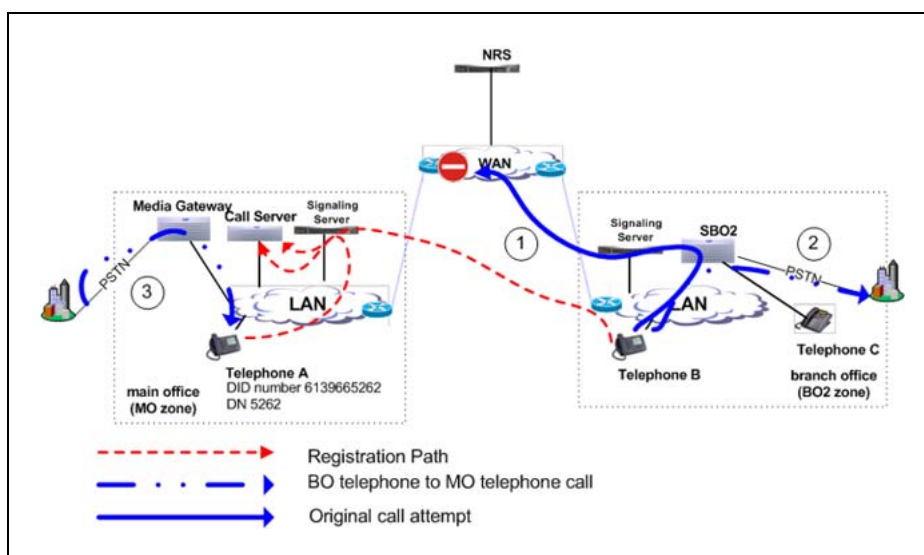

Telephone B calls Telephone A (the user dials DN 5262). In this example, the call alternately routes to the PSTN. (The PSTN telephone number of Telephone A is 613-966-5262.)

Configuration required Configure the following:

At the main office:

- Use one of the dialing plan software packages to process the call, such as CDP or NARS.
- Provision an ALTPrefix for the BO2 zone.

- Provision the ALTPrefix as a Steering Code at the main office. Build a Route List Index (RLI) so these calls go to the virtual trunk or configure the Vacant Number Routing feature to do the same.

At the branch office:

- Provision the ALTPrefix as a steering code. Build a Route List Index and DMI associated with this steering code that alternately routes these calls to the PSTN with the correct digits.

At the NRS:

- Create a CDP entry for the ALTPrefix in the branch office gateway.

Sequence of events in the call The information that follows refers to [Figure 66 "Call between a branch office telephone in Normal Mode and a main office telephone" \(page 164\)](#) and [Figure 67 "Digits dialed and outpulsed with Alternative Call Routing for NBWM" \(page 166\)](#).

[Figure 67 "Digits dialed and outpulsed with Alternative Call Routing for NBWM" \(page 166\)](#) illustrates the steps that occur in an alternately routed station-to-station call. The diagram assumes that alternately routed calls originate on Voice Gateway Media Cards at the branch office.

Figure 67
Digits dialed and outpulsed with Alternative Call Routing for NBWM

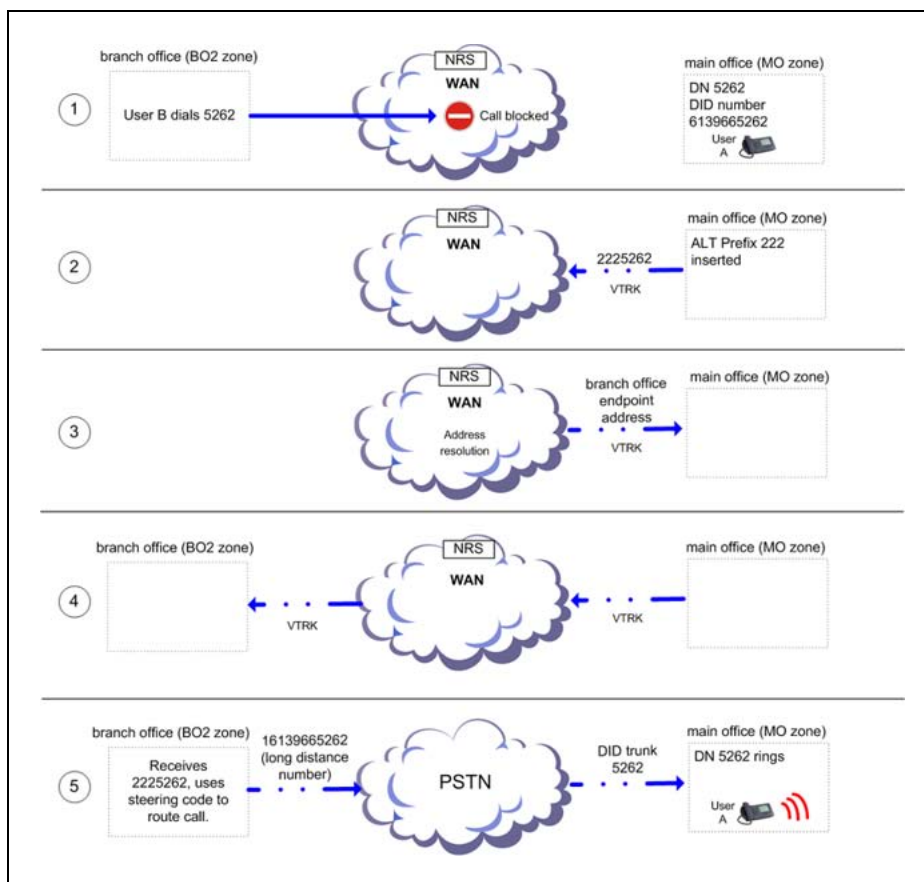

1. IP Phone User B in the BO2 zone dials IP Phone A in the main office zone (DN 5262) (action labeled 1 in [Figure 66 "Call between a branch office telephone in Normal Mode and a main office telephone"](#) (page 164)).
2. The main office Call Server determines there is insufficient bandwidth between the two zones.
3. The Call Server inserts the ALTPrefix configured for the BO2 zone prior to IP Phone A's telephone number, dialed by the user.
 Example: ALTPrefix assigned is 222. The dialed DN number becomes 222 5262.
4. The call is routed to the virtual trunk by CDP or VNR. The virtual trunk sends a request to the NRS for address resolution. The digit string sent to the NRS contains the ALTPrefix. The NRS returns the IP address of the branch office endpoint to the virtual trunk.
5. The virtual trunk places the call to the branch office.

6. The branch office receives the call and recognizes the first part of the number as a Steering Code. The call is steered to an RLI. The DMI manipulates the number into a PSTN number and the branch office outputs the digits to the Central Office (CO) serving the branch office. (This may be the same CO as the one serving the main office.) If the alternate route has MCDN trunks in the BO2 zone, the call is outputted on one of these trunks, after the branch office uses Digit Manipulation (action labeled 2 in [Figure 66 "Call between a branch office telephone in Normal Mode and a main office telephone" \(page 164\)](#)).

Example: See [Figure 67 "Digits dialed and outputted with Alternative Call Routing for NBWM" \(page 166\)](#).

2225 is programmed as a Steering Code at the branch office. Calls starting with this Steering Code are handled by an RLI with a PSTN trunk route as an entry. If the Public format number for the destination telephone is a DID number, then the Digit Manipulation Index associated with the PSTN route must:

- delete 3 digits (remove the ALTPrefix 222)
- insert 1613966 (in order to compose the DID number of the destination telephone, which is 16139665262)

Program other Steering Codes to route calls to other locations properly (for example, program Steering Code 2226 to route calls to another branch office where 15063486XXX would have to be outputted). See the section called ["A call from a branch office telephone to another branch office telephone" \(page 170\)](#)

7. Call comes into IP Phone A from the PSTN or MCDN trunks in the main office zone (action labeled 3 in) [Figure 66 "Call between a branch office telephone in Normal Mode and a main office telephone" \(page 164\)](#).

A call from a main office telephone to a branch office telephone

[Figure 68 "Call between a main office telephone and a branch office telephone" \(page 168\)](#) shows an alternately routed call between two CS 1000 systems. The system shown on the left is a main office. The system shown on the right is a branch office. Both systems have access to the PSTN. The Wide Area Network (WAN) is shown in the center with a gatekeeper/Network Routing Service (NRS) that can be co-resident with a Signaling Server. IP Phones are also shown associated with each system. Telephone A belongs to the main office. Telephone B is a telephone at the branch office registered to the main office. There are two bandwidth zones indicated by the dashed line (main office zone [MO zone] and branch office zone [BO2 zone]). Telephone A and the Media Gateway belong to the MO zone. Telephones B and C and the branch office belong to the BO2 zone.

Figure 68
Call between a main office telephone and a branch office telephone

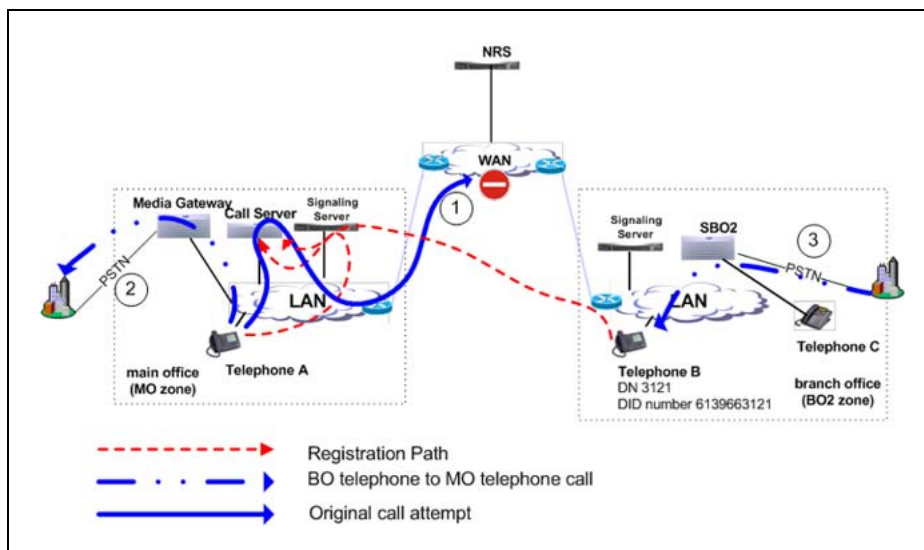

Telephone A calls Telephone B (the user dials DN 3121). In this example, the call alternately routes to the PSTN. (The PSTN telephone number of Telephone B is 613-966-3121.)

Configuration required Configure the following:

At the main office:

- Use one of the dialing plan software packages to process the call, such as CDP or NARS.
- Provision an ALTPrefix for the MO zone.
- Provision the ALTPrefix as a Steering Code at the main office. Build a Route List Index (RLI) so these calls go to the virtual trunk or configure the Vacant Number Routing feature to do the same.
- Provision the ALTPrefix as a Steering Code. Build a Route List Index (RLI). Translate these calls to go to this RLI which contains PSTN or MCDN trunks.
- Set up a Digit Manipulation Index (DMI) to outpulse the correct digits to the branch office telephone.

At the branch office:

- No provisioning required.

At the NRS:

- No provisioning required.

Sequence of events in the call The information that follows refers to Figure 68 "Call between a main office telephone and a branch office telephone" (page 168) and Figure 69 "Digits dialed and outpulsed with Alternative Call Routing for NBWM" (page 169).

Figure 69
Digits dialed and outpulsed with Alternative Call Routing for NBWM

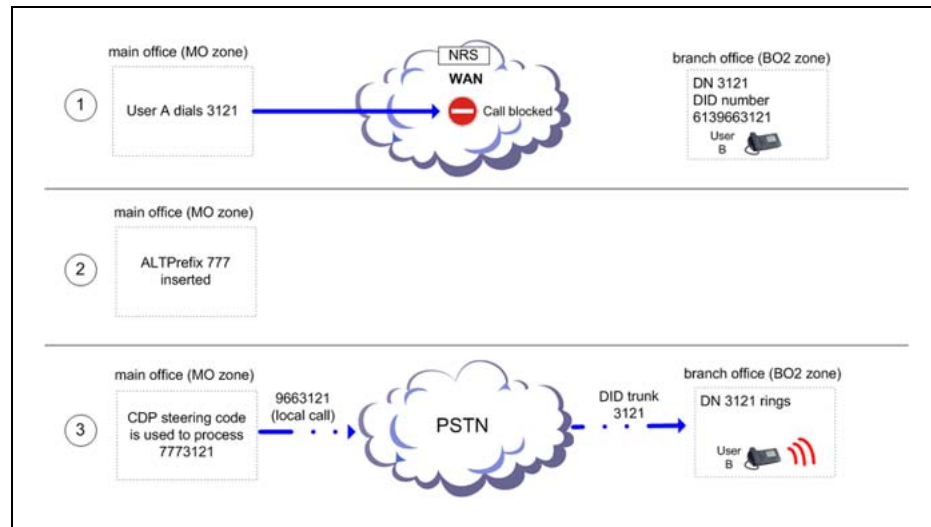

1. IP Phone User A in the MO zone dials IP Phone B in the BO2 zone (DN 3121) (action labeled 1 in Figure 68 "Call between a main office telephone and a branch office telephone" (page 168)).
2. The main office Call Server determines there is insufficient bandwidth between the two zones.
3. The Call Server inserts the ALTPrefix configured for the MO zone prior to IP Phone B's telephone number. The rebuilt number contains the ALTPrefix.
Example: ALTPrefix assigned is 777. The dialed number becomes 777 3121.
4. The call is routed by CDP or VNR to the outgoing route using an RLI.
Example: 7773 is a steering code, translated to go to an RLI where there is one entry, a PSTN trunk route.
5. The main office manipulates the digits and the call is routed to the PSTN in the MO zone (action labeled 2 in Figure 68 "Call between a main office telephone and a branch office telephone" (page 168)).
Example: Use DMI to delete and insert digits on the PSTN trunk route.
 - delete 3 digits (remove the ALTPrefix 777)

- insert 966 (in order to compose the DID number of the destination telephone which is 9663121, a local call.)
6. The call terminates on IP Phone B from the PSTN in the BO2 zone (action labeled 3 in [Figure 68 "Call between a main office telephone and a branch office telephone"](#) (page 168)).

A call from a branch office telephone to another branch office telephone

[Figure 70 "Call between a branch office telephone and another branch office telephone"](#) (page 171) shows an alternately routed call between three systems: one main office and two branch offices.

All three systems are configured with the same Virtual Private Network Identifier (VPNI). All systems have virtual trunks.

The Wide Area Network (WAN) is shown with a gatekeeper/Network Routing Service (NRS) that can be co-resident with one of the Signaling Servers.

Telephone F belongs to branch office 1 in Normal Mode and telephone B is a branch office 2 telephone in Normal Mode.

There are three bandwidth zones indicated by the dashed lines (main office zone [MO zone], branch office zone [BO2 zone], and branch office 1 zone [BO1 zone]). Telephone F and branch office 1 belong to the BO1 zone. Telephone B and the other branch office belong to the BO2 zone.

Figure 70
Call between a branch office telephone and another branch office telephone

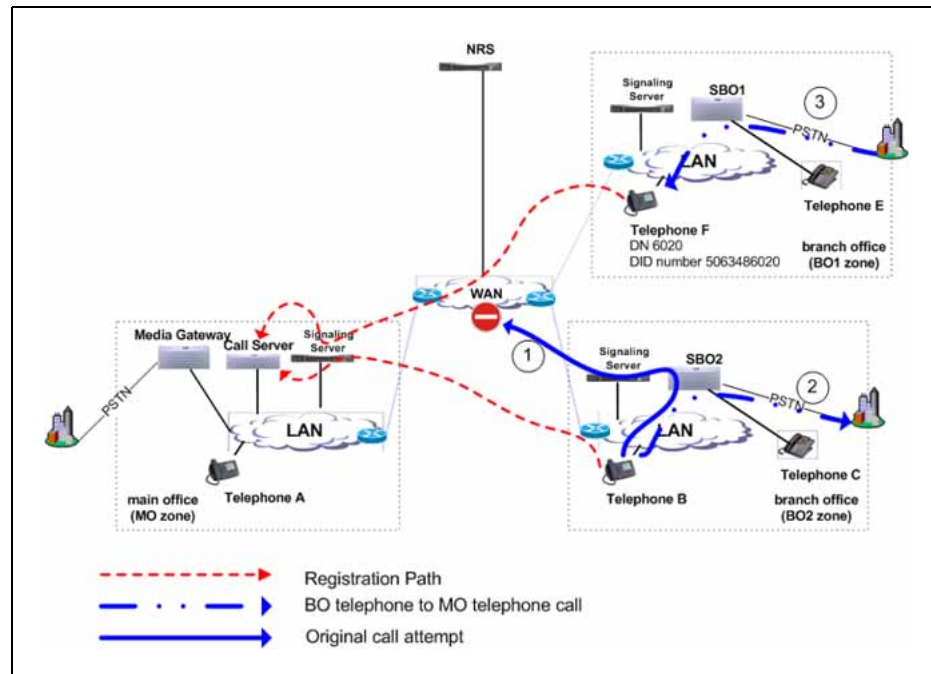

Telephone B in the BO2 zone calls Telephone F in the BO1 zone (the user dials 6020). In this example, the call alternately routes to the PSTN. (The PSTN telephone number of Telephone F is 506-348-6020.)

Configuration required Configure the following:

At the main office:

- Use one of the dialing plan software packages to process the call, such as CDP or NARS.
- Provision an ALTPrefix for the BO2 zone.
- Provision the ALTPrefix as a Steering Code at the main office. Build a Route List Index (RLI) so these calls go to the virtual trunk or configure the Vacant Number Routing feature to do the same.

At the branch office:

- Provision the ALTPrefix as a steering code. Build a Route List Index and DMI associated with this steering code that alternately routes these calls to the PSTN.

At the NRS:

- Create a CDP entry for the ALTPrefix in the branch office gateway.

Sequence of events in the call The information that follows refers to Figure 70 "Call between a branch office telephone and another branch office telephone" (page 171) and Figure 71 "Digits dialed and outpulsed with Alternative Call Routing for NBWM" (page 172).

Figure 71
Digits dialed and outpulsed with Alternative Call Routing for NBWM

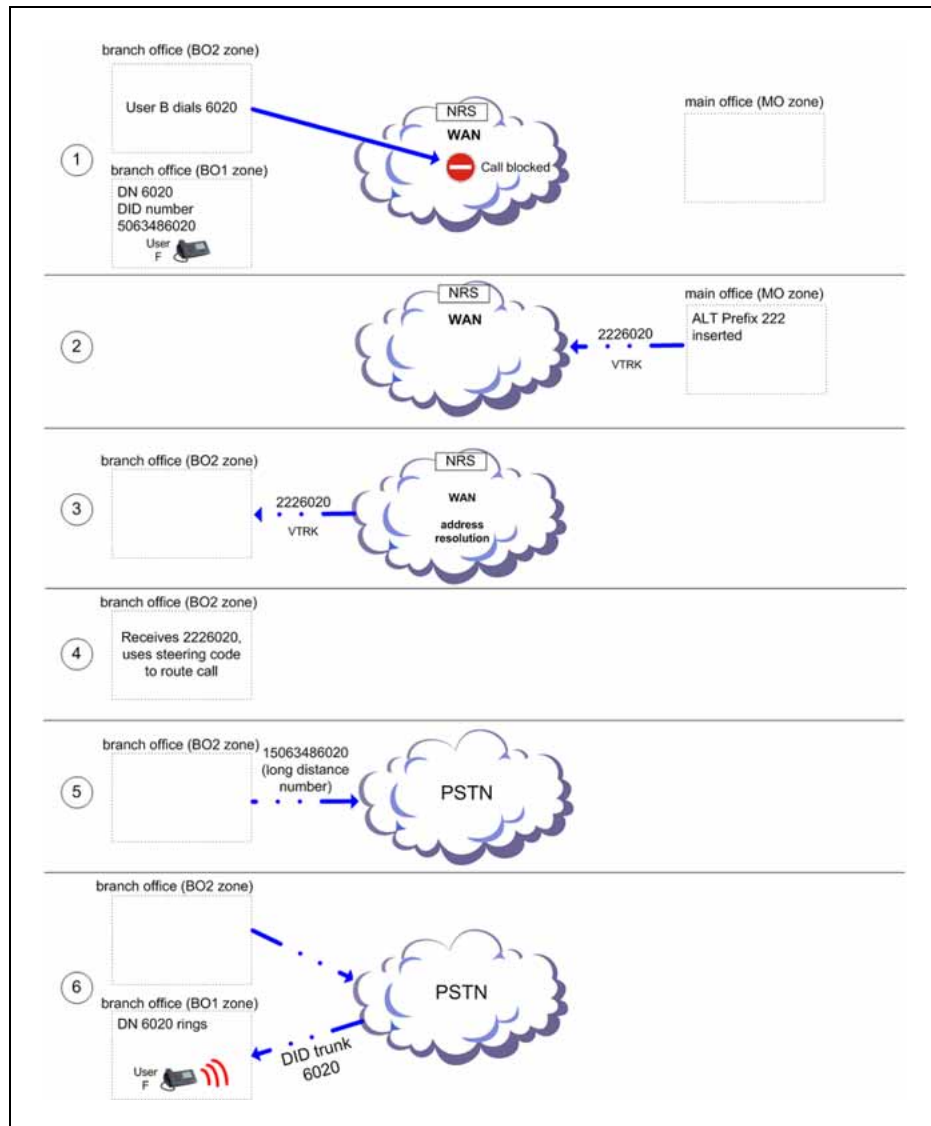

1. The user of IP Phone B in the BO2 zone dials IP Phone F in the BO1 zone (DN 6020) (action labeled 1 in) Figure 70 "Call between a branch office telephone and another branch office telephone" (page 171).
2. The main office Call Server determines there is insufficient bandwidth between the BO2 and BO1 zones.

3. The Call Server inserts the ALTPrefix configured for the BO2 zone prior to IP Phone F's telephone number, dialed by the user.

Example: ALTPrefix assigned is 222. The dialed number becomes 222 6020.

4. The call is routed to the virtual trunk by CDP or VNR. The virtual trunk sends a request to the NRS for address resolution. The digit string sent to the NRS contains the ALTPrefix. The NRS returns the IP address of the branch office endpoint to the virtual trunk.
5. The virtual trunk places the call to the branch office.

The branch office receives the call and recognizes the first part of the number as a Steering Code. The call is steered to an RLI. The DMI manipulates the number into a PSTN number and the branch office outputs the digits to the Central Office (CO) serving the branch office. (This may be the same CO as the one serving the main office.) If the alternate route has MCDN trunks in the BO2 zone, the call is outputted on one of these trunks, after the branch office uses Digit Manipulation (action labeled 2 in [Figure 70 "Call between a branch office telephone and another branch office telephone" \(page 171\)](#)).

Example: The digit string 2226 is programmed as a Distant Steering Code (DSC) at the branch office. Calls starting with this DSC are handled by an RLI with PSTN trunks as an entry. If the Public format number for the destination telephone is a DID number, then the Digit Manipulation Index associated with the PSTN route must:

- delete 3 digits (remove the ALTPrefix 222)
- insert 1506348 (in order to compose the DID number of the destination telephone, which is 15063486020)

6. The call comes into IP Phone F from the PSTN in the BO1 zone (action labeled 3 in [Figure 70 "Call between a branch office telephone and another branch office telephone" \(page 171\)](#)).

Alternative Call Routing for NBWM feature used in All Calls mode

The situations illustrated in [Figure 66 "Call between a branch office telephone in Normal Mode and a main office telephone" \(page 164\)](#), [Figure 68 "Call between a main office telephone and a branch office telephone" \(page 168\)](#), and [Figure 70 "Call between a branch office telephone and another branch office telephone" \(page 171\)](#) can also apply to the operation of the feature when it is active all the time, regardless of available bandwidth.

For an example of this, the information below applies to [Figure 66 "Call between a branch office telephone in Normal Mode and a main office telephone" \(page 164\)](#) when all calls are alternately routed.

The configuration and provisioning for the All Calls mode is exactly the same as the regular Alternative Call Routing for NBWM feature except that the Alternate Routing for All Calls option is selected in overlay 117 or Element Manager.

Operating parameters

This feature applies to all CS 1000 systems.

This feature applies to station-to-station, interzone calls. The call can be between IP Phones or a TDM telephone at the main office and an IP Phone at the branch office.

This feature is configurable for main office and branch office zones, not virtual trunk zones.

The operation of the Alternative Call Routing for NBWM feature depends on the proper configuration of the Network Bandwidth Management feature. If Network Bandwidth Management encounters insufficient bandwidth for an interzone call, the Alternative Call Routing for NBWM feature attempts to re-route the call through the PSTN or TIE/MCDN route, if Alternative Call Routing is configured for the originating zone.

Configure the Voice Gateway bandwidth zone and the IP Phone bandwidth zone with the same number on each Call Server.

For alternately routed calls that originate at the branch office, the network administrator must decide whether to program the main office to use conventional PSTN or TIE/MCDN routes that physically terminate at the branch office or to use conventional trunks at the main office. Outpulsed digits on the PSTN trunks must be in the format required by the Central Office serving the chosen system. For example, if the two systems are served by the same Central Office, PSTN calls can use the trunks at the main office. However, if the two systems are located at a great distance from each other, it may make sense to program the main office to use trunks at the branch office for alternately routed calls.

If there is a location with multiple NXX codes for DID users, it is possible to translate and outpulse calls properly as long as each NXX has a unique DN range. Non-DID users can be reached through the attendant console, by deleting the ALTPrefix and the DN dialed and inserting the digits in the Listed Directory Number (LDN).

When calls are rerouted to use the PSTN instead of the station-to-station IP network, there may be a loss of feature functionality normally available for station-to-station calls. Features that are not available over the PSTN are not available to the user.

This feature does not apply to virtual trunk calls. It only applies to station-to-station calls, and routes them over the PSTN or MCDN network. Virtual Trunk calls already have this feature and can be alternately routed using traditional methods (such as NARS), which is outside the scope of this feature.

Alternative Call Routing for NBWM does not apply to users who are registered in local mode to the Branch Office.

Calls that are in an ACD queue cannot be alternately routed by this feature. These calls remain in the ACD queue until an ACD agent and sufficient bandwidth are available.

Music on Hold is not affected by this feature.

A QoS0038 message prints out when insufficient bandwidth is detected between two zones. A QoS0039 message prints out when the Alternative Call Routing for NBWM feature is invoked.

If a user at a branch office attempts to make a conference call, Alternative Call Routing for NBWM is not invoked.

Feature interactions

Call Redirections

The Alternative Call Routing for NBWM feature works with Call Transfer, Call Forward All Calls, and Conference. Redirection operates as if the user dialed the ALTPrefix manually.

Multiple Appearance Directory Number

If telephone endpoints sharing Multiple Appearance DN (MADN) are configured in different zones, then this feature handles the call in the same way that Network Bandwidth Management does. The zone number of the telephone that is prime for the DN is the only zone considered.

Network Bandwidth Management

The Alternative Call Routing for NBWM feature does not detect insufficient bandwidth. It reacts to insufficient bandwidth detected by the Network Bandwidth Management and Adaptive Network Bandwidth Management features. For more information on these two features, see *IP Peer Networking Installation and Commissioning (NN43001-313)*.

Network Class of Service

The telephone calling must have an NCOS assigned that allows the call to use the alternate route.

Network Routing Service (NRS)

Both the main office and branch office must be registered on the Nortel NRS for tandem routing to work for main office to branch office tandeming.

Trunk Route Optimization (TRO)

Disable Trunk Route Optimization between the branch office (or SRG) and the main office in order to allow the tandeming required for the feature to work.

Virtual Office

It is not possible to determine the real Bandwidth Zone of a telephone logged in as a Virtual Office telephone.

Feature packaging

The Alternative Call Routing for NBWM feature requires the following software package:

- Coordinated Dialing Plan (CDP) package 59

The following software package is optional:

- Flexible Numbering Plan (FNP) package 160

Feature implementation using Command Line Interface**Task summary list**

The following is a summary of the tasks in this section:

1. ["LD 117 " \(page 176\)](#)

Enable Alternative Call Routing for NBWM for a particular zone

2. ["LD 117" \(page 177\)](#)

Configure Alternate Prefix number for a particular zone and the All Calls option, if desired.

3. ["LD 117 " \(page 177\)](#)

Print Alternate Prefix number for a particular zone.

LD 117

| Command | Description |
|--|---|
| ENL ZALT <zone> | |
| Enable Alternative Call Routing for NBWM, where: | |
| <zone> | Input zone number (0-255). Configure the branch office zone using LD 117 at the main office. |

LD 117

| Command | Description |
|--|--|
| CHG ZALT <zone> <ALTPrefix> [<re-route all calls>] | |
| Change ALTPrefix number for zone, where: | |
| <zone> | Input zone number (0 to 255). Configure the branch office zone using LD 117 at the main office. |
| <ALTPrefix> | A digit string, of up to 7 digits, added to the start of the dialed number, if the call will not be routed through the WAN (due to lack of bandwidth, poor QoS, or feature is configured for all calls). |
| [<re-route all calls>] | Allow or Deny Alternative Call Routing for all calls, where: <ul style="list-style-type: none"> • (NO) = deny • YES = allow |

LD 117

| Command | Description |
|--|---|
| PRT ZALT <zone> | |
| Print the ALTPrefix assigned to a particular zone and if the feature operates for all calls from that zone, where: | |
| <zone> | Input zone number (0 to 255). If you do not input a zone number, the system prints the information for all configured zones. |

Sample printout

| # | ZALT | Alternate Prefix | All Calls | Alarms Suppression Time |
|----|------|------------------|-----------|-------------------------------|
| 10 | ENL | 100 | YES | 50 |
| 11 | ENL | 101 | YES | 0 |
| 12 | DIS | 102 | NO | 1000 |

Feature implementation using Element Manager

Zone configuration

Use Element Manager to configure the specific zone properties.

1. Access the **Zones** web page to select **Alternate Routing for Calls between IP Stations**.
2. Access the **Alternate Routing for Calls between IP Stations** web page to configure the feature.

Accessing the Zones web page

Procedure 10

Accessing the Zones web page

| Step | Action |
|------|--------|
|------|--------|

- | | |
|---|--|
| 1 | From the navigator, click IP Network > Zones . |
|---|--|

The **Zones** web page opens. See [Figure 72 "Zones" \(page 178\)](#).

Figure 72
Zones

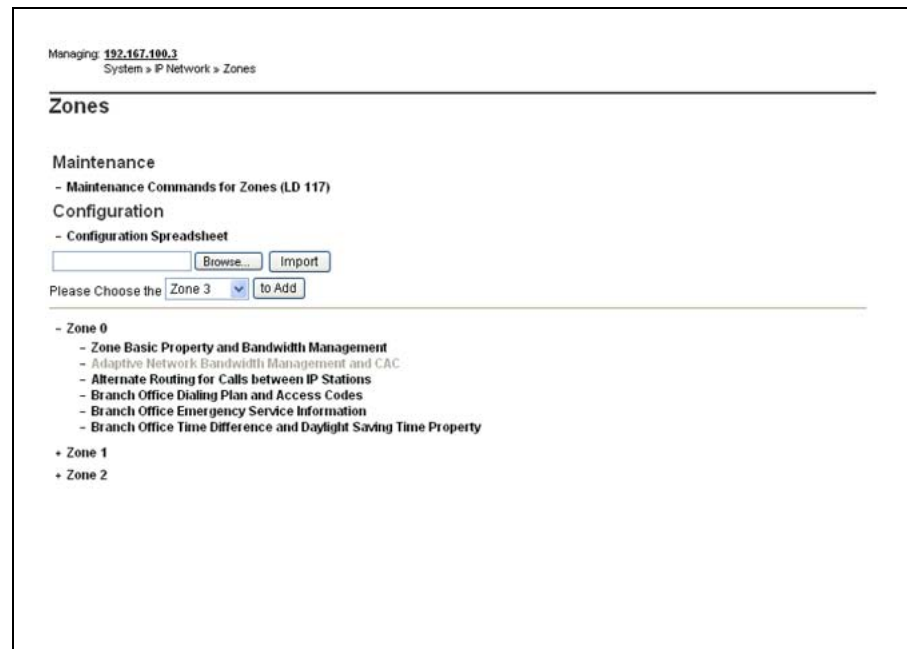

- | | |
|---|---|
| 2 | Under Configuration click beside the Zone , or click the Zone you are programming, to expand the choices under it. |
| 3 | Click Alternate Routing for Calls between IP Stations . |

A web page appears that displays the configuration parameters related to the Alternative Call Routing for NBWM feature. See [Figure 73 "Access the Alternate Routing for Calls between IP Stations "](#) (page 179).

Figure 73
Access the Alternate Routing for Calls between IP Stations

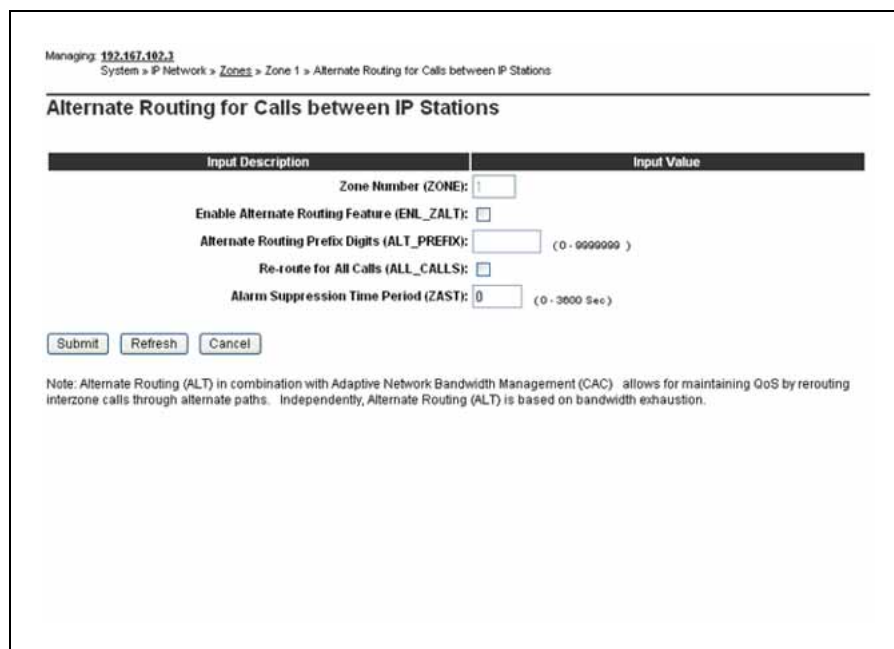

| Input Description | Input Value |
|---|--------------------------|
| Zone Number (ZONE): | 1 |
| Enable Alternate Routing Feature (ENL_ZALT): | <input type="checkbox"/> |
| Alternate Routing Prefix Digits (ALT_PREFIX): | [text box] (0-9999999) |
| Re-route for All Calls (ALL_CALLS): | <input type="checkbox"/> |
| Alarm Suppression Time Period (ZAST): | 0 (0-3600 Sec) |

Submit Refresh Cancel

Note: Alternate Routing (ALT) in combination with Adaptive Network Bandwidth Management (CAC) allows for maintaining QoS by rerouting interzone calls through alternate paths. Independently, Alternate Routing (ALT) is based on bandwidth exhaustion.

The **Zone Number** for the zone you selected in step 3 is displayed.

- 4 Select the **Enable Alternate Routing feature (ENL_ZALT)** check box to enable the Alternative Call Routing for NBWM feature.
- 5 Enter a maximum of 7 digits in **Alternate Routing Prefix Digits (ALTPrefix)**.
- 6 Select the **Re-route for All Calls (ALL_CALLS)** check box to enable the feature for all calls.
- 7 Enter a maximum of 4 digits in **Alarm Suppression Time Period (ZAST)**.
- 8 Click **Submit** to enter the data.

—End—

Diagnostics

Command Line Interface diagnostics

LD 117 Obtain status for a particular zone

| Command | Description |
|---|--|
| STAT ZALT <zone> | Display Alternative Call Routing Status, where: zone = bandwidth zone |
| If you do not enter a value in the zone field, you obtain a printout of the status of all configured zones. | |

The printout for all configured zones appears as follows:

| # | Alternate Routing Status |
|----|--------------------------|
| 10 | ENL |
| 11 | DIS |
| 12 | DIS |

LD 117 Obtain status for a branch office zone

| Command | Description |
|---|--|
| STAT ZBR <zone> | Show status of specified branch office zone, where: zone = bandwidth zone |
| If you do not enter a value in the zone field, you obtain a printout of the status of all configured branch office zones. | |

The printout for all configured branch office zones appears as follows:

| # | State | Flags | Des |
|----|-------|---------|-----|
| 10 | ENL | TIM | BVW |
| 11 | DIS | LOC ALT | TOR |
| 12 | DIS | ESA ALT | |

Des entries are codes you assign to each branch office for your own records.

Element Manager diagnostics

Print zone Alternative Call Routing information

The print capability allows the following parameters to be viewed for each zone:

- enable/disable status of the Alternative Call Routing for NBWM feature
- ALTPrefix digits

- enable/disable status of the All Calls option

Procedure 11

Printing zone ALTPrefix

| Step | Action |
|------|--------|
|------|--------|

- | | |
|---|--|
| 1 | From the navigator, click System > Maintenance . The Maintenance web page appears. See Figure 74 "Maintenance web page" (page 181). |
|---|--|

Figure 74
Maintenance web page



- | | |
|---|--|
| 2 | Click Select by Functionality . The Select by Functionality web page appears. See Figure 75 " Select by Functionality" (page 182). |
|---|--|

Figure 75
Select by Functionality

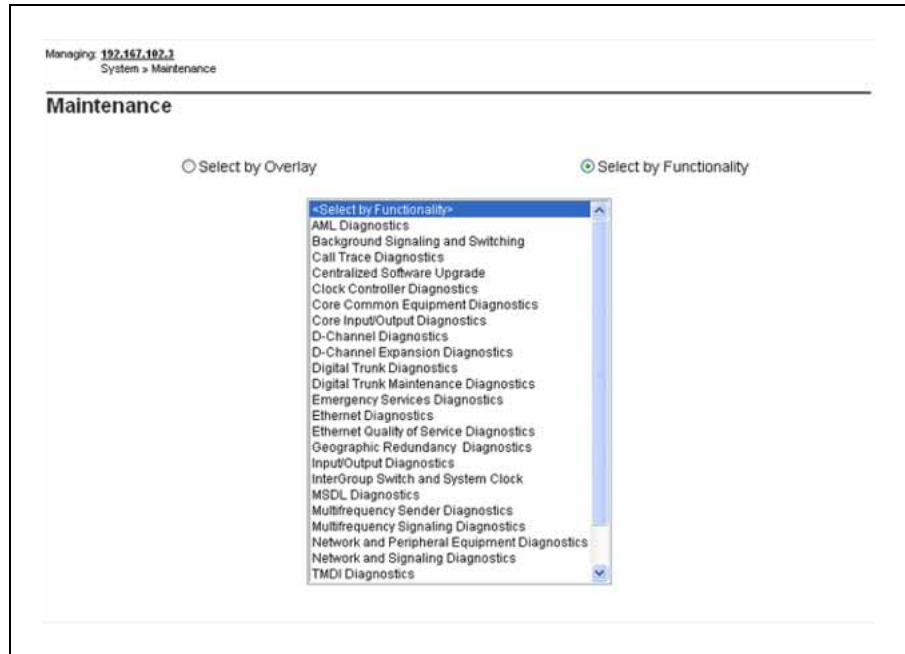

- 3 Click **Zone diagnostics**. The **Maintenance Commands for Zones** web page appears. See [Figure 76 "Maintenance Commands for Zones "](#) (page 182). You can also access this page if you click on **Zones**, as you see in [Figure 72 "Zones"](#) (page 178).

Figure 76
Maintenance Commands for Zones

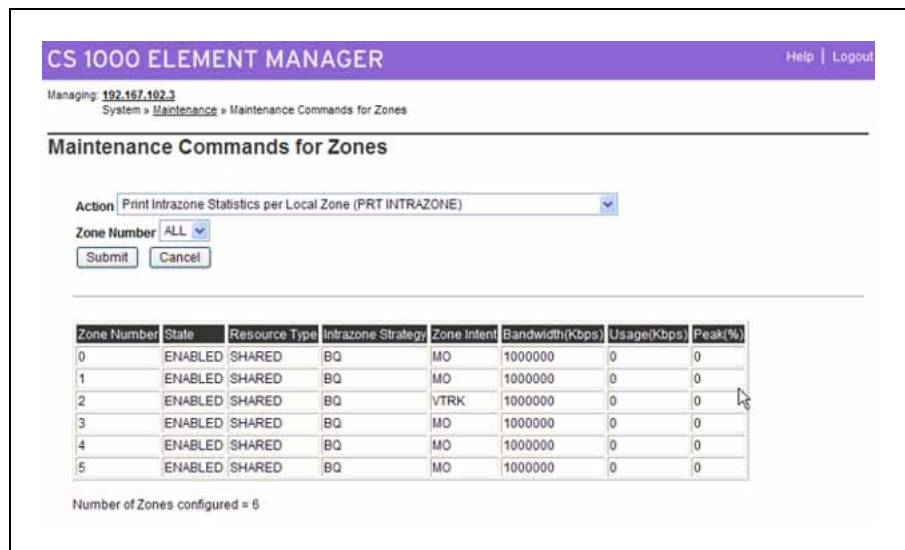

- 4 Select **Print Zone Alternate Prefix Information (PRT ZALT)** from the drop-down list beside **Action**. See

Figure 77
Maintenance Commands for Zones Action list

CS 1000 ELEMENT MANAGER Help | Logout

Managing: 192.167.192.3
System » Maintenance » Maintenance Commands for Zones

Maintenance Commands for Zones

Action: Print Intrazone Statistics per Local Zone (PRT INTRAZONE) ▼

Zone N: Print Intrazone Statistics per Local Zone (PRT INTRAZONE)

Subm: Print Bandwidth Property (PRT ZBW)
Print Description (PRT ZDES)
Print Dialing Plan and Access Codes (PRT ZDP)
Print Time Change Property (PRT ZTP)
Show Branch Office Behaviour (STAT ZBR)
Show Status (STAT ZONE)

| Zone N | Age(Kbps) | Peak(%) |
|--------|-----------|---------|
| 0 | 0 | 0 |
| 1 | 0 | 0 |
| 2 | 0 | 0 |
| 3 | 0 | 0 |
| 4 | 0 | 0 |
| 5 | 0 | 0 |

Number of Zones configured = 6

- 5 Select ALL or a zone number from the **Zone Number** drop-down list.
- 6 Click **Submit**.

—End—

Show the status of the Alternative Call Routing for NBWM feature

The Show Status functionality displays the enable/disable status of the Alternative Call Routing for NBWM feature. The configured zones and the status of the feature for each zone can be listed.

Procedure 12

Show Status

| Step | Action |
|------|--------|
|------|--------|

- | | |
|---|--|
| 1 | From the navigator, click System > Maintenance . The Maintenance web page appears. See Figure 74 "Maintenance web page" (page 181). |
| 2 | Click Select by Functionality . The Select by Functionality web page appears. See Figure 75 "Select by Functionality" (page 182). |
| 3 | Click Zone diagnostics . The Maintenance Commands for Zones web page appears. |

- 4 Select **Show Alternate Routing Status (STAT ZALT)** from the drop-down list beside **Action**. See Figure 78 "Show Alternative Routing Status" (page 184).

Figure 78
Show Alternative Routing Status

The screenshot shows the 'Maintenance Commands for Zones' page in the CS 1000 ELEMENT MANAGER. The 'Action' dropdown menu is set to 'Show Alternate Routing Status (STAT ZALT)'. The 'Zone Number' dropdown menu is set to 'ALL'. There are 'Submit' and 'Cancel' buttons below the dropdowns. Below the form is a table with the following data:

| Zone Number | Alternate Routing Status |
|-------------|--------------------------|
| 0 | DISABLED |
| 1 | DISABLED |
| 2 | DISABLED |
| 3 | DISABLED |
| 4 | DISABLED |
| 5 | DISABLED |

Number of Zones configured = 6

- 5 Select ALL or a zone number from the **Zone Number** drop-down list.
- 6 Click **Submit** to enter the data
The display updates with the data associated with that zone.

—End—

Maintenance Command Line Interface

LD 117 Enable and disable Alternative Call Routing for NBWM for a zone

| Command | Description |
|--|---|
| ENL ZALT <zone> | Enable Alternative Call Routing for Bandwidth Management for zone specified. |
| DIS ZALT <zone> | Disable Alternative Call Routing for Bandwidth Management for zone specified. |
| The system responds with ok, if operation is successful. | |

| Command | Description |
|--|---|
| ENL ZBR <zone> [ALL] [LOC][ESA][TIM][ALT] | Enable features for the branch office zone. If you do not input features, then all are enabled. |
| DIS ZBR [ALL] [LOC][ESA][TIM][ALT] | Disable features for the branch office zone. If you do not input features, then all are disabled. |
| The system responds with ok, if operation is successful. | |

LD 117 Change and Print Zone Alarm Suppression Time Interval

| Command | Description |
|--|---|
| CHG ZAST <zone> <Alarm Suppression Interval> | Change Suppression Time Interval for QoS alarms related to Alternative Call Routing for NBWM feature for zone specified. Time Interval is measured in seconds from the time the last alarm was printed. Default is 0. Range is 0 - 3600 seconds. |
| PRT ZAST <zone> | Print Suppression Time Interval for QoS alarms related to Alternative Call Routing for NBWM feature for zone specified. No entry for zone number results in printout for all zones. |

Sample printout:

| # | Alarms Suppression Time |
|----|-------------------------|
| 10 | 50 |
| 11 | 0 |
| 12 | 1000 |

Where # is the column header for zone number.

Element Manager maintenance

Enable branch office behavior for a zone

You can configure the Alternative Call Routing for NBWM feature while you configure the zone's branch office behavior.

Procedure 13

Enabling behavior at a zone

| Step | Action |
|------|--------|
|------|--------|

- | | |
|---|--|
| 1 | From the navigator, click System > Maintenance . The Maintenance web page appears. See Figure 74 "Maintenance web page" (page 181). |
|---|--|

- 2 Click **Select by Functionality**. The **Select by Functionality** web page appears. See Figure 75 "Select by Functionality" (page 182).
- 3 Click **Zone diagnostics**. The **Maintenance Commands for Zones** web page appears .
- 4 Select **Enable a Zone's Branch Office Behavior** from the drop-down list beside **Action**. See Figure 79 "Enable branch office behavior for a zone" (page 186).

Figure 79
Enable branch office behavior for a zone

CS 1000 ELEMENT MANAGER Help | Logout

Managing: 192.167.102.3
System » Maintenance » Maintenance Commands for Zones

Maintenance Commands for Zones

Action: Enable a Zone's Branch Office Behaviour (ENL ZBR) ▼

Zone Number: 0 ▼

Zone Branch Office Options (ZBR_OPT):

Local Dialing Access Time Adjustment Alternate Routing for Branch

| Zone Number | Alternate Routing Status |
|-------------|--------------------------|
| 0 | DISABLED |
| 1 | DISABLED |
| 2 | DISABLED |
| 3 | DISABLED |
| 4 | DISABLED |
| 5 | DISABLED |

Number of Zones configured = 6

- 5 Select the zone number you want to configure from the **Zone Number** drop-down list.
- 6 Select the check box beside the **Alternate Routing for Branch** option to enable the feature.
- 7 Click **Submit**. The display updates with new configuration data for the zone you specified.

—End—

Suppress alarms

You can suppress alarms QoS0038 and QoS0039 for a configurable amount of time (0 - 3600 seconds).

Procedure 14 Suppress Alternative Call Routing for NBWM alarms

| Step | Action |
|------|--------|
|------|--------|

- | | |
|---|--|
| 1 | Click IP Network > Zones . The Zones web page appears. |
| 2 | Click beside the Zone , or click the Zone you are programming, to expand the choices under it. |
| 3 | Enter digits in Alarm Suppression Time Period (ZAST) . See Figure 80 "Alarm Suppression Time Period (ZAST)" (page 187). |
| 4 | Click Submit to enter the data. |

Figure 80
Alarm Suppression Time Period (ZAST)

Managing: 192.167.162.3
System > IP Network > Zones > Zone 1 > Alternate Routing for Calls between IP Stations

Alternate Routing for Calls between IP Stations

| Input Description | Input Value |
|---|-------------------------------------|
| Zone Number (ZONE): | 1 |
| Enable Alternate Routing Feature (ENL_ZALT): | <input type="checkbox"/> |
| Alternate Routing Prefix Digits (ALT_PREFIX): | <input type="text"/> (0 - 9999999) |
| Re-route for All Calls (ALL_CALLS): | <input type="checkbox"/> |
| Alarm Suppression Time Period (ZAST): | 0 (0 - 3600 Sec) |

Note: Alternate Routing (ALT) in combination with Adaptive Network Bandwidth Management (CAC) allows for maintaining QoS by rerouting interzone calls through alternate paths. Independently, Alternate Routing (ALT) is based on bandwidth exhaustion.

—End—

Feature operation

No specific operating procedures are required to use this feature

Emergency Services configuration

Contents

This section contains the following topics:

- "Overview" (page 189)
- "Emergency Services Access" (page 190)
- "Emergency Services for Virtual Office" (page 200)
- "On-Site Notification" (page 201)
- "Configuring the NRS for ESA SPN" (page 201)
- "Testing the ESDN number" (page 202)
- "Configuring ESA using Element Manager" (page 202)
- "Emergency Service using Special Numbers (SPN)" (page 202)

Overview

Support for access to emergency services by branch users in Normal Mode is configured at the main office.

The key difference between the main office user and the branch user is the route selected for the emergency call. An emergency call must be handed off to the PSTN over a trunk at the central office that is geographically closest to the caller—this means that there is normally an emergency trunk in the main office, and one in each of the branch offices. An emergency call originating from an SRG IP Phone must route from the main office Call Server to the SRG so that the call can be sent on the SRG PSTN Trunks.

In Normal Mode, an IP Phone must have a Virtual Trunk available and configured between the main office and branch office in order to complete an emergency services call.

ATTENTION

Do not route ESA calls to a node that has no direct ESA trunks.

Nortel recommends using the Emergency Services Access (ESA) feature. This is the preferred method in North America, the Caribbean and Latin America (CALA), and in those countries that are members of the European Union (EU). ESA provides specific features and capabilities required by legislation in these jurisdictions.

The ESA feature provides the following advantages:

- recognizes special Emergency Service Directory Number (ESDN)
- overrides calling restrictions
- provides optional assignment of ESA CLID per DN
- provides optional selection of a special emergency route
- provides optional routing digits (for NRS resolution)
- provides optional assignment of an Emergency Location Identification Number (ELIN)
- provides On Site Notification (OSN) through an external tool, which traps the emergency call event and records an alarm when an emergency calls are placed at the branch office.

For more information about ESA, see *Emergency Services Access Fundamentals (NN43001-613)*.

The main office Call Server forwards emergency services calls to the SRG using a virtual trunk.

Emergency Services Access

The Emergency Services Access (ESA) configuration specifies the digit sequence (a DN) that the user dials to start an emergency call, known as the Emergency Services Directory Number (ESDN). There can only be one ESA configuration per customer and thus only one ESDN per customer, which means that all telephones on the same network must be in the same numbering plan.

With all sites using the same ESDN, a conflict occurs in the NRS because the same ESDN may need to route to different gateways. The conflict is resolved by using a routing digit for each site that the main office adds as it routes the call. The suggested routing digit is the ESN home location code of the SRG, or alternately, the Numbering Plan Area (NPA) code of the SRG if there is not more than one Call Server in the NPA. Virtually any unique digit string (maximum 15 digits) can be used as a routing digit, because the call is sent to the NRS as a Private/Special Number (SPN). In the NRS, SPN have their own separate numbering plan.

The Automatic Number Identification (ANI) data sent to the Public Safety Answering Point (PSAP) identifies the location of the caller. In some constituencies, legislation requires one ANI (DID) per fixed area, so the physical location of the emergency can be approximated based on the telephone number delivered to the PSAP. The ESA feature has a comprehensive scheme that can be used to convert an extension into an appropriate DID.

If the branch office is relatively small, it can be easier to use a single ANI number for the branch office. For more information on this command, see *Software Input Output Reference—Maintenance (NN43001-711)*.

Routing Emergency Services Access (ESA) calls

ATTENTION

Do not route ESA calls to a node that has no direct ESA trunks.

Ideally, route ESA calls directly over Central Office (CO) trunks to the Public Safety Answering Point (PSAP). In those cases where this routing is not possible, do not route ESA calls to nodes that have no direct ESA trunks.

The implications of routing calls to nodes without direct ESA trunks are as follows:

- At the node without the direct ESA trunks, the node cannot route the ESA call directly to the PSAP. Instead, that node must re-route the call to another node. This re-routing is an unnecessary use of resources.
- If the node is a CS 1000E node, the only tandem trunks are IP Peer trunks. There is no way to specify the appropriate rerouting digits (that is, Prepend Digits) to reroute the ESA call to another node with direct ESA trunks.

Therefore, if unable to route ESA calls directly to the PSAP, the next best practice is to route ESA calls to nodes with direct ESA trunks.

Emergency call routing

A Call Server can provide service to IP phones across multiple emergency jurisdictions. This can also occur with traditional non-IP equipment in the form of remote peripheral equipment (for example, Carrier Remote, Fiber Remote).

An emergency call should be handled by the designated means for the phone location (for example, local security desk or local PSAP). The emergency call should be routed to a service at the current location of the phone.

Configuring ESA for the branch office

For ESA, the main office Call Server forwards the call to the branch office for termination. Calls are redirected over a Virtual Trunk using the NRS. The NRS routes the calls using a special number, referred to in this section as the ESA Special Number.

ESA must be configured and tested on the main office Call Server and the SRG to differentiate between emergency calls originating from IP Phones at each location and calls originating on trunks, which refers to the forwarded emergency call that the SRG receives from the main office for an IP Phone in Normal Mode.

Use the following steps to configure ESA for emergency access at each location:

At the main office:

| Step | Action |
|------|--|
| 1 | Determine the dialing plan (for example, numbering plan) for ESA calls. |
| 2 | Configure the main office emergency trunk (CAMA or PRI). For EMEA, the following trunks are supported: <ul style="list-style-type: none"> • BRIE (Basic Rate Interface–ETSI based) • PRI (Primary Rate Interface per EURO ISDN) • QSIG on PRI • DPNSS • IP tandem trunks on ISDN |
| 3 | Configure the Virtual Trunk at the main office. |
| 4 | Configure ESN at the main office. |
| 5 | Configure ESA at the main office. |
| 6 | Configure the SRG zone on the main office. Configure a zone for each branch office which is used in conjunction with ESA parameters to route an emergency call to the SRG. |
| 7 | Test ESDN using a main office telephone. |
| 8 | Configure the SRG emergency trunk (CAMA or PRI). |
| 9 | Configure the Virtual Trunk at the MG 1000B. |
| 10 | Configure ESN at the branch office. |

-
- 11 Configure ESA at the branch office.
 - 12 Configure the branch office zone on the branch office.
The branch office zone is required for bandwidth management but does not require ESA parameters.
 - 13 Configure the ESN SPN on the branch office.
 - 14 Configure the NRS for the ESA Special Number used.
 - 15 Test ESDN using an analog (500/2500-type) telephone located at the branch office.
 - 16 Test ESDN using an SRG IP Phone in Normal Mode and in Local Mode.

—End—

At the SRG, or branch office:

| Step | Action |
|------|--------|
|------|--------|

- | | |
|---|--|
| 1 | Configure the SRG emergency trunk (CAMA or PRI). |
| 2 | Configure the Virtual Trunk at the MG 1000B. |
| 3 | Configure ESN at the branch office. |
| 4 | Configure ESA at the branch office. |
| 5 | Configure the branch office zone on the branch office. The branch office zone is required for bandwidth management but does not require ESA parameters. |
| 6 | Configure the ESN SPN on the branch office. |
| 7 | Configure the NRS for the ESA Special Number used. |
| 8 | Test ESDN using an analog (500/2500-type) telephone located at the branch office. |
| 9 | Test ESDN using an SRG IP Phone in Normal Mode and in Local Mode. |

—End—

Reregistering to minimally configured branch office

A branch user in Local Mode but who is not physically at the branch can get incorrect emergency service handling.

If the SRG is not provisioned with knowledge of all the ERL in the enterprise, one of two scenarios occurs when an IP Phone reregisters to the branch (either by VO ESA redirection or by fallback to Local Mode):

- If the local TN is provisioned as Manual Update, then the phone inherits the static location data. The static location data probably indicates basic ESA processing (per LD 24) if this is a small branch.
- If the local TN is provisioned as Auto Update, then cached location data in the phone is rejected if undefined locally, and unknown location values (ERL = 0, ECL = 0, LocDesc = Unknown) are assigned. Unknown location indicates default (basic) emergency processing (per LD 24), which is acceptable for a small branch. A system message is also generated to indicate that the phone location data was actually unknown and defaults were used, but emergency calls should be handled correctly.

Minimally configured branches (without LIS support) can be configured as manual update.

Routing configuration for ESA calls on SRG 50

Use the following steps to configure routing for ESA calls for the SRG 50:

| Step | Action |
|------|--|
| 1 | Build a destination code corresponding to the ESA SPN for the branch office. |
| 2 | Configure the destination code to absorb the leading digits for the SPN, leaving just the ESDN. |
| 3 | Configure the destination code to use a public route to the PSTN trunks. |
| 4 | Ensure the Remote access package (00 to 15 under Call Security) assigned to the VoIP trunks has the appropriate Line Pool Access/Bloc for PRI. |
| 5 | Ensure there is a Public Prefix of 911 with a length of 3 to match to outgoing digits. This eliminates any delay. As soon as the 3 digits are collected, the call is sent. |

—End—

Determining the dialing plan for ESA calls

In many jurisdictions of the United States and Canada, the emergency number must be “911”. The call processor cannot have a DN that conflicts with these digits, but since “9” is often used for NARS AC2 (the local call Access Code), this is not usually a problem.

ESA for international deployment must support the standard emergency number 112 and any emergency numbers in use prior to the EU directive.

In general, ESA calls should leave the network through a trunk at the branch office where the originating telephone is located. To enable this, it is necessary for telephones at each branch office to supply a unique identifying prefix to the NRS when the ESA calls are being routed so that the NRS can select a distinct route for each branch office. This prefix can be configured with the zone data for the SRG telephones. The provisioning of this prefix is an enhancement for branch office.

While a variety of numbering schemes are available, Nortel recommends that customers use 0 + the ESN location code of the SRG + ESDN, where ESDN is:

- for North America and CALA—911
- for members of the European Union—112 and any other emergency numbers in use prior to the EU directive

This number, referred to here as the ESA Special Number, is configured as a special number (SPN) in the NRS so that the Virtual Trunk routes the call to the branch office.

Use Element Manager or the Command Line Interface for the following procedure. See *IP Peer Networking Installation and Commissioning (NN43001-313)* for details.

Procedure 15 Configuring the main office

| Step | Action |
|------|--|
| 1 | <p>Configure the main office emergency trunk (CAMA or PRI).</p> <p>Configure either analog CAMA or digital PRI to correctly signal the call identification.</p> <p>ESA overrides all restrictions. Configure the trunk with restrictions so that other features cannot access the trunk.</p> |
| 2 | <p>Configure the Virtual Trunk using the procedure from <i>IP Peer Networking Installation and Commissioning (NN43001-313)</i>.</p> |

The Virtual Trunk must be configured to enable emergency calls originating from SRG IP Phones registered at the main office to reach the branch office.

3 Configure ESN.

ESA uses a route number rather than ESN route list index. However, ESN is required at the branch office.

4 Configure Emergency Services Access (ESA) in LD 24.

LD 24 Configure Emergency Services Access

| Prompt | Response | Description |
|--------------|----------|--|
| REQ: | NEW CHG | Add new data, or change existing data. |
| TYPE: | ESA | Emergency Services Access data block |
| CUST | xx | Customer number as defined in LD 15 |
| ESDN | xxxx | Emergency Services DN (for example, 911). Up to four digits are accepted. |
| ESRT | | ESA route number |
| | 0-511 | Range for Large Systems |
| | 0-127 | Range for MG 1000B |
| DDGT | x...x | Directing Digits (for CAMA Trunks)(for example, 1, 11, or 911). Up to four digits are accepted. |
| DFCL | x...x | Default ESA Calling Number. The input must be the following lengths: <ul style="list-style-type: none"> • On a system that is not FNP equipped, 8 or 11 digits are accepted if the first digit of the input is '1'; otherwise the input must be 7 or 10 digits. • On a system that is FNP equipped, up to 16 digits are allowed. |
| OSDN | x...x | On-Site Notification station DN. The input must be a valid single appearance internal DN. |

You configure OSDN to alert the local security personnel about an emergency call in progress. Leave the ESA route number blank to make test calls without using any trunk resources. If the route number has been configured, remove it by entering "x" at the prompt. Nortel recommends that the system administrator arrange a test call with the Public Services Access Point (PSAP).

5 Test ESDN using a main office telephone to confirm that main office calls exit the main office trunks. The ESA Configuration Audit feature

provides CLID Verification (CLIDVER) reports that determine how an emergency call is routed, without actually routing the call. Use LD 20 to generate a CLIDVER report.

Table 20
LD 20 Generate a CLIDVER report

| Prompt | Response | Description |
|----------|------------|---|
| REQ: | PRT | Print |
| TYPE | CLIDVER | CLID Verification |
| SORTBY | (DN) TN | The output/report is sorted based on this flag. If the response is DN, the overlay prompts the user to enter the DN, and the output is sorted by the DN. If the response is TN, the overlay prompts the user to enter the TN and the output is sorted by the TN. |
| ESA_ONLY | (YES) NO | Flag used to decide if the report should contain information for ESA call type only or for all call types. If the ESA package is restricted, this input prompt does not appear. The report contains non-ESA data only. |
| SHORT | (YES) NO | Flag used to decide if the output report should be a Short report of a Detail report. |
| TN | | Terminal Number |
| | lscu | Format for Large System, where l = loop, s = shelf, c = card, and u = unit |
| CUST | xx | Customer number as defined in LD 15. |
| DN | x...x | Directory Number. If no value is entered, the report includes all supported Directory Numbers. |
| DATE | dd mmm yyy | Date |
| PAGE | (NO) YES | Data printed on a per page basis. |
| DES | d...d | Designator |

For more information about CLIDVER reports, see *Emergency Services Access Fundamentals (NN43001-613)*.

- 6 Configure the branch office zone on the main office.
 - a. Configure the branch office zone ESA dialing information in LD 117.

LD 117 Configure branch office zone ESA route

| Command | Description |
|---|---|
| CHG ZESA <Zone><ESA Route #><AC><ESA Prefix><ESA Locator> | <p>Defines the ESA parameters for the branch office zone, where:</p> <ul style="list-style-type: none"> • Zone = Zone number for the branch office. • ESA Route # = Virtual Trunk route to SRG. • AC = Access Code to add to dialed digits. If no AC is required, enter AC0 in place of AC1 or AC2. • ESA Prefix = Digit string added to start of ESDN. This is a unique prefix in the NRS. Nortel recommends that users use 0 + ESN location code of the branch office node. An example for location code 725 would be: 0725. • ESA Locator = Direct Inward Dial telephone number sent as part of ANI for use by the PSAP to locate the source of the call. |

- b. Enable the branch office zone ESA in LD 117.

ENL ZBR <Zone> ESA

- 7 Configure the ESA Special Number at the main office.

Configure the ESA Special Number in the NRS. Using NRS, configure the ESA Special Number defined for the branch office zone. See *IP Peer Networking Installation and Commissioning (NN43001-313)*.

Nortel recommends that customers use "0" + the ESN Location code + ESDN. An example for location code 725 would be 0725911. The zero is recommended to prevent a collision in the ESN data with the HLOC entry.
- 8 Do the following:
 - a. In LD 86, configure Emergency Service Access Digit Manipulation for AC + ESDN dialing to allow recognition of the ESDN even if AC1 or AC2 is used.

LD 86

| Prompt | Response | Description |
|---|----------|-------------------------------------|
| REQ | NEW CHG | Add, Change |
| CUST | xx | Customer number as defined in LD 15 |
| FEAT | DGT | Digit Manipulation |
| ... | ... | ... |
| DMI | 1- 999 | Digit Manipulation Table numbers. |
| <p>ATTENTION Do not use Digit Manipulation Table 0, as it results in the incorrect call termination treatment.</p> | | |

- b. Configure the system to trap the ESDN within the AC1 and AC2 translation tables to reprocess the ESDN locally.

LD 86 Configure the system to trap the ESDN and reprocess it locally

| Prompt | Response | Description |
|---|----------|--|
| REQ | NEW CHG | Add, Change |
| CUST | xx | Customer number as defined in LD 15 |
| FEAT | RLB | Route List Block |
| ... | ... | ... |
| RLI | xxx | Route List Index to be accessed |
| ENTR | xxx | Entry number for NARS/BARS Route List |
| LTER | YES | Local Termination entry. This allows the AC + ESDN call to be recognized as an Emergency Services Access call. |
| DMI | 1 - 999 | Digit Manipulation Table. Use the table configured in LD 86. This allows the digits after the AC to remain in the call register as a called number. |
| <p>ATTENTION Do not use Digit Manipulation Table 0, as it results in the incorrect call termination treatment.</p> | | |

- c. Configure Emergency Service Access call recognition for AC + ESDN dialing in LD 90.

LD 90

| Prompt | Response | Description |
|--------|----------|--|
| REQ | NEW CHG | Add, Change |
| CUST | xx | Customer number as defined in LD 15 |
| FEAT | NET | Network translation tables |
| TRAN | aaa | |
| TYPE | SPN | |
| - SPN | 911 | AC + ESDN is recognized as an Emergency Service Access call. |
| | 112 | Use the number configured for ESDN. |
| - RLI | xxx | Route List Index. |
| | | Use Route List Index configured in LD 86. |

—End—

Procedure 16**Configuring the branch office zone****Step Action**

- 1 Configure the branch office zone on the branch office.
 In the branch office, only the zone number and bandwidth/codecs selection is configured.

 Use the same zone number between the branch office and main office. The main office configuration ([Procedure 15 "Configuring the main office" \(page 195\)](#), step 6) provides the branch office zone characteristics (local time, local dialing, and ESA).
- 2 Configure the routing tables on the SRG.
 The SRG must recognize the incoming digits on the Virtual Trunk and remove all but the ESDN. The call is routed to a local termination.

—End—

Emergency Services for Virtual Office

The E911 Virtual Office feature allows Virtual Office users, whether they are logged in or logged out of Virtual Office to place an emergency (E911) call to the correct Public Safety Answering Point (PSAP) for their geographical location.

The use of the terms Normal Mode and Local Mode apply to SRG branch user only.

Emergency Services while logged in to Virtual Office

The E911 Virtual Office feature recognizes when a user dials an ESDN and it forces the Virtual Office IP Phone to log out of Normal Mode (into Local Mode) in order to place the emergency call directly from the branch office location to the PSAP.

Emergency Services while logged out of Virtual Office

If 911 is dialed while logged out of Virtual Office the LTPS redirects the 911 call to the local 911 service (PSAP), not the remote Call Server 911 service. The Call Server is provisioned with Emergency Services Access Terminal Numbers (ESTN). The ESTN is used to register the IP Phone with the Call Server. The logged out IP Phone can make ESA calls only.

For more information on emergency services for Virtual Office, see *Emergency Services Access Fundamentals (NN43001-613)* and *Branch Office Installation and Commissioning (NN43001-314)*.

On-Site Notification

The ESA On-Site Notification (OSN) function notifies local security personnel when an emergency call occurs. When an emergency call is placed at the branch office, an external tool traps the notification and records an alarm. This applies to IP Phones that the main office returns in local mode when an emergency call is made, as well as locally connected analog (500/2500-type) telephones.

A LAN port must be enabled on the SRG to support the external tool. For more information, see *SRG50 Configuration Guide (NN40140-500)*.

Configuring the NRS for ESA SPN

The NRS must be configured for the ESA Special Number (SPN). The NRS uses the ESA SPN to route the emergency call from the main office to the branch office.

Nortel recommends that a consistent pattern be followed for all ESA calls. For example, use 0 + ESN Location code of the branch office node + the ESDN. An example for location code 725 would be: 0725911. The zero is recommended to prevent a collision in the ESN data with the HLOC entry.

For more information, see *IP Peer Networking Installation and Commissioning (NN43001-313)*.

Testing the ESDN number

Use [Procedure 17 "Testing ESDN using an SRG telephone"](#) (page 202) to test the ESDN number from any telephone in the branch office.

Procedure 17

Testing ESDN using an SRG telephone

| Step | Action |
|------|--------|
|------|--------|

- | | |
|---|--|
| 1 | <p>For IP Phones:</p> <ol style="list-style-type: none">a. Dial the ESDN on an SRG IP Phone in Local Mode. The calls must go out on the emergency trunk(s) in the branch office.b. Dial the ESDN on an SRG IP Phone in Normal Mode. The calls must tandem over the Virtual Trunk to the branch office and go out on the emergency trunk(s) in the branch office. The following configuration problems can occur:<ul style="list-style-type: none">• The call can receive overflow tones. Use LD 96 to view the digits sent to the Virtual Trunk (ENL MSGO dch#).• If the digits look correct on the main office, the NRS might not be properly configured. If the NRS rejects the call, a diagnostic message is displayed on the NRS console.• If the call makes it to the correct branch office (check that it is not going to the wrong node if the NRS is configured incorrectly), the branch office is probably rejecting it because it does not know the digit string. |
| 2 | <p>For analog (500/2500-type) telephones, dial the ESDN on an SRG analog (500/2500-type) telephone. The calls must go out on the emergency trunk(s) in the branch office.</p> |

—End—

Configuring ESA using Element Manager

To configure Emergency Services Access in Element Manager, see *Element Manager System Reference Administration (NN43001-632)*.

Emergency Service using Special Numbers (SPN)

Determining the dialing plan for emergency access calls is critical.

In many jurisdictions, the emergency number is a fixed number (for example, 112 or 999). The main office Call Server or SRG cannot have a DN that conflicts with these digits.

Access to Emergency Service using SPN should be configured in the following circumstances:

- When the Emergency Service number at the branch office is different from that at the main office.
- When there is more than one number used for accessing Emergency Service; for example, when there are different numbers for Police, Fire, and Ambulance services.
- In markets where the ESA feature is not available (outside of North America, CALA, and EMEA).

To configure Emergency Service using SPN, follow the process outlined in "[Dialing Plan configuration](#)" (page 43). If SRG PSTN access is correctly configured, Emergency Service from the branch office will already be present.

Branch office access to Emergency Service using SPN must be configured and tested the main office Call Server and the SRG to differentiate between emergency calls originating from IP Phones at each location and emergency calls originating on trunks.

The special handling provided by ESA is not available in this scenario, such as OSN and zone-based routing.

For information on emergency services for Virtual Office, see *Emergency Services Access Fundamentals (NN43001-613)*.

Enhanced UNiStim Firmware Download

Contents

This section contains the following topics:

- ["Description" \(page 205\)](#)
- ["Firmware upgrade" \(page 206\)](#)

Description

This section applies to the main office and the following IP Phones:

- IP Phone 2001
- IP Phone 2002
- IP Phone 2004
- IP Phone 2007
- IP Audio Conference Phone 2033
- IP Phone 1110
- IP Phone 1120E
- IP Phone 1140E
- IP Phone 1150E

It does not apply to the IP Softphone 2050 and WLAN 2210/2211/2212/6120/6140.

The redirected IP Phones at the SRG 50 are under the control of the main office Call Server for the majority of the deployment (Normal Mode). Users of the SRG IP Phones receive the features, key layout, and tones of the main office Call Server. Therefore, the version of the IP Phone firmware must align with the requirements of the CS 1000. When an IP Phone requires firmware upgrade, the CS 1000 uses the `umsUpgradeA11` command, or variant, to redirect the IP Phone back to the SRG 50 for upgrading.

For CS 1000 Release 4.5 and later, if the required firmware file does not exist on the SRG 50, or the version of the file is incorrect, the SRG 50 initiates an FTP session to the TPS for the IP Phone to retrieve the required file. The SRG 50 upgrades the IP Phone and redirects the IP Phone back to the CS 1000.

For SRG 50 Release 2.0 and later, if the required firmware does not exist on the SRG 50, or the version is incorrect, the SRG 50 initiates an FTP session to the TPS for the IP Phone to retrieve the required file. The SRG 50 upgrades the IP Phone and redirects the IP Phone back to the CS 1000.

For SRG 50 Release 1.0, the SRG 50 must be patched to the proper firmware level with patch number BCM50.90. For CS 1000 Release 4.0, ensure MPLR21148 is installed on the Signaling Server. Firmware download does not occur when IP Phones register to the TPS by a Virtual Office Login or branch office redirection to the main office. Instead, SRG IP Phones are redirected back to the SRG TPS for firmware files upgrade. This redirection occurs only if the umsUpgradeAll command is issued from the main office TPS, and the current firmware files are missing.

For CS 1000 Release 4.0, ensure MPLR21148 is installed on the Signaling Server.

Firmware download does not occur when IP Phones register to the TPS by a Virtual Office Login or branch office redirection to the main office. Instead, SRG IP Phones are redirected back to the SRG TPS for firmware files upgrade. This redirection occurs only if the umsUpgradeAll command is issued from the main office TPS, and the current firmware files are missing.

If an IP Phone is in use when the umsUpgradeAll command is issued, the call is not interrupted. Its firmware version is checked against the main office TPS firmware policy, and if there is no match, the IP Phone is flagged, then redirected to the MG 1000B TPS when the call is completed. The umsUpgradeAll command has no immediate impact on IP Phones that are logged in or out by Virtual Office. However, the firmware files may be upgraded, if required, when the Virtual Office session is terminated.

For information on Enhanced UNISlim Firmware, see *IP Line Fundamentals (NN43100-500)*.

Firmware upgrade

Use [Procedure 18 "Upgrading firmware" \(page 207\)](#) to upgrade the firmware. For information about upgrading IP Phone firmware, see *IP Line Fundamentals (NN43100-500)*.

Procedure 18
Upgrading firmware

Step Action

- 1 At the Main office, upgrade IP Phone firmware on the Signaling Server. For instructions, see *Signaling Server Installation and Commissioning (NN43001-312)*.
 - 2 Issue the CLI command `umsUpgradeAll` at the main office. IP Phones at the Main office and branch office are upgraded as necessary.
-

—End—

Appendix A

Media Redirection Scenarios

In addition to basic call scenarios, Network Bandwidth Management also supports the following media redirection scenarios:

- Scenario 1: Codec switches correctly during media redirection. See [Table 21 "Codec switches correctly during media redirection" \(page 210\)](#).
- Scenario 2: Call transfer works correctly with IP Phones:
 - Scenario 2.1: Call Transfer from an SRG IP Phone in Normal Mode to main office IP Phone. See [Table 22 "Call transfer from SRG IP Phone in Normal Mode to main office IP Phone" \(page 210\)](#).
 - Scenario 2.2: Call Transfer from main office IP Phone to an SRG IP Phone in Normal Mode. See [Table 23 "Call transfer from main office IP Phone to SRG IP Phone in Normal Mode" \(page 210\)](#).
- Scenario 3: Conference Call works correctly with a branch office:
 - Scenario 3.1: Conference call between branch office and main office, initiated by an SRG IP Phone in Normal Mode. See [Table 24 "Conference call between branch office and main office, initiated by SRG IP Phone in Normal Mode" \(page 211\)](#).
 - Scenario 3.2: Conference call between main office and branch office, initiated by main office IP Phone. See [Table 25 "Conference call between main office and branch office, initiated by main office IP Phone" \(page 212\)](#).

The zone table is examined using the commands in LD 117. See *Software Input Output Reference—Maintenance (NN43001-711)* for more information on these commands.

In these scenarios, consult the zone table at the main office for accurate bandwidth usage information.

Table 21
Codec switches correctly during media redirection

| Event | Result |
|--|--|
| 1 An incoming Direct Inward Dial (DID) call to branch office uses IP Peer to reach the symposium controller Control Directory Number (CDN) in the main office. | <p>The external caller hears music and announcements with a G.729 codec. Bandwidth usage in the main office indicates the call is an interzone call.</p> <p>The external caller is connected to an Automatic Call Distribution (ACD) agent with a G.711 codec. Bandwidth usage in the main office indicates the call is an intrazone call. The ACD agent is an SRG IP Phone registered to the main office.</p> |
| 2 The call is released. | The zone table indicates the bandwidth usage for the call is removed correctly on the main office Call Server and in the branch office. |

Table 22
Call transfer from SRG IP Phone in Normal Mode to main office IP Phone

| Event | Result |
|--|---|
| 1 An SRG TDM telephone calls an IP Phone registered to the main office. | A speech path is established between the SRG TDM telephone and the IP Phone registered to the main office. The zone table indicates intrazone bandwidth usage. |
| 2 The SRG IP Phone registered to the main office initiates a call transfer to a main office IP Phone. | The SRG TDM telephone is put on hold. A speech path is established between the SRG IP Phone registered to the main office and the main office IP Phone. The zone table indicates interzone bandwidth usage. |
| 3 The Call Transfer key on the SRG IP Phone registered to the main office is pressed to complete the call transfer. | A speech path is established between the SRG TDM telephone and the main office IP Phone. The zone table indicates interzone bandwidth usage. |
| 4 The call is released. | The zone table indicates bandwidth usage for the call is unreserved correctly. |

Table 23
Call transfer from main office IP Phone to SRG IP Phone in Normal Mode

| Event | Result |
|--|--|
| 1 An SRG TDM telephone calls a main office IP Phone. | A speech path is established between the SRG TDM telephone and the main office IP Phone. The zone table indicates interzone bandwidth usage. |

| Event | Result |
|--|---|
| 2 The main office IP Phone initiates a call transfer to an SRG IP Phone registered to the main office. | The SRG TDM telephone is put on hold. A speech path is established between the main office IP Phone and the SRG IP Phone registered to the main office. The zone table indicates interzone bandwidth usage. |
| 3 The Call Transfer key on the main office IP Phone is pressed to complete the call transfer. | A speech path is established between the IP Phone registered to the main office and the SRG TDM telephone. The zone table indicates intrazone bandwidth usage. |
| 4 The call is released. | The zone table indicates bandwidth usage for the call is unreserved correctly. |

Table 24
Conference call between branch office and main office, initiated by SRG IP Phone in Normal Mode

| Event | Result |
|--|---|
| 1 An SRG TDM telephone calls an SRG IP Phone registered to the main office. | A speech path is established between the SRG TDM telephone and the SRG IP Phone registered to the main office. The zone table indicates intrazone bandwidth usage. |
| 2 The SRG IP Phone registered to the main office initiates a conference call to a main office IP Phone. | The SRG TDM telephone is put on hold. A speech path is established between the SRG IP Phone registered to the main office and the main office IP Phone. The zone table indicates interzone bandwidth usage. |
| 3 The Conference key on the SRG IP Phone registered to the main office is pressed to complete the conference call. | Speech paths are established among the SRG TDM telephone, the SRG IP Phone registered to the main office, and the main office IP Phone. The zone table indicates interzone and intrazone bandwidth usage. |
| 4 The SRG TDM telephone releases the call. | A speech path is established between the main office IP Phone and the SRG IP Phone registered to the main office. The zone table indicates interzone bandwidth usage. |
| 5 The call is released. | The zone table indicates bandwidth usage for the call is unreserved correctly. |

Table 25
Conference call between main office and branch office, initiated by main office IP Phone

| Event | Result |
|--|---|
| 1 An SRG TDM telephone calls a main office IP Phone. | A speech path is established between the SRG TDM telephone and the main office IP Phone. The zone table indicates interzone bandwidth usage. |
| 2 The main office IP Phone initiates a conference call to an SRG IP Phone registered to the main office. | The SRG TDM telephone is put on hold. A speech path is established between the main office IP Phone and the SRG IP Phone registered to the main office. The zone table indicates interzone bandwidth usage. |
| 3 The Conference key on the main office IP Phone is pressed to complete the conference call. | Speech paths are established among the SRG TDM telephone, the SRG IP Phone registered to the main office, and the main office IP Phone. The zone table indicates interzone and intrazone bandwidth usage. |
| 4 The SRG TDM telephone releases the call. | A speech path is established between the SRG IP Phone registered to the main office and the main office IP Phone. The zone table indicates interzone bandwidth usage. |
| 5 The call is released. | The zone table indicates bandwidth usage for the call is unreserved correctly. |

List of terms

Branch office

An SRG that is remote from the main office. The SRG provides telephony services using the main office servers (for Normal Mode) or local system services when the SRG loses IP communication with the main office (Local Mode).

CDP

Coordinated Dialing Plan. Under the recommended Coordinated Dialing Plan, the Branch User ID can be an extension (for example, 4567). For more information about CDP, see *Dialing Plans Reference (NN43001-283)*.

dialing plan

Each system uses a specific numbering configuration (dialing plan) that determines how calls will be handled over a private or public network.

DSP

Digital Signal Processing, which refers to manipulating analog information, such as sound or photographs that have been converted into a digital form. DSP also implies the use of a data compression technique.

When used as a noun, DSP stands for Digital Signaling Processor, a special type of coprocessor designed for performing the mathematics involved in DSP. Most DSP are programmable, which means that they can be used for manipulating different types of information, including sound, images, and video.

ESA

Emergency Services Access is a feature that places a customer in compliance with federal legislation that requires the Private 911 type of functionality provided by ESA. Please note, however, that the ESA feature is also generally useful for users who are not subject to legislation, and is broad enough to be used in different countries. For example, it will be appreciated by any customer who wants to route emergency calls in a

special manner, or who wants to be notified when a telephone user makes an emergency call. It would also appeal to a customer who wishes to have ESA calls answered on-site,

on the business premises, rather than being forwarded to the Public Services Answering Point (PSAP). See *Emergency Services Access Fundamentals (NN43001-613)* for complete information.

Gatekeeper

The Gatekeeper is a separate application on an IP network that directs IP traffic to all the systems on the network. Parameters for both the main office and SRG must be assigned to all gatekeepers active on the network. If the Gatekeeper is down, the SRG attempts to connect to the Alternate Gatekeeper, if there is one. If the Alternate Gatekeeper is down as well, or there is no Alternate Gatekeeper, the SRG IP Phones remain registered with the main office but calls cannot be sent to the SRG.

gateway

In networking, a combination of hardware and software that links two different types of networks. Gateways between e-mail systems, for example, enable users on different e-mail systems to exchange messages.

H.323

A standard approved by the International Telecommunication Union (ITU) that defines how audiovisual conferences data is transmitted across networks. In theory, H.323 enables users to participate in the same conference even though they are using different video conferencing applications. Although most video conferencing vendors have announced that their products conform to H.323, it is too early to say whether such adherence actually results in interoperability.

IP

Abbreviation of Internet Protocol, pronounced as two separate letters. IP specifies the format of packets, also called datagrams, and the addressing scheme. Most networks combine IP with a higher-level protocol called Transport Control Protocol (TCP), which establishes a virtual connection between a destination and a source.

IP by itself is something like the postal system. It enables you to address a package and drop it in the system, but there's no direct link between you and the recipient. TCP/IP, on the other hand, establishes a connection between two hosts so that they can send messages back and forth for a period of time.

LAN

Local Area Network.

Local Mode

The SRG is in Local Mode when:

- The IP Phones are first installed and not yet reregistered with the main office
- The SRG cannot communicate with the main office and the IP Phones are reregistered with the SRG
- A user deliberately puts the IP Phone in the Test Local Mode condition.

Main office

The CS 1000 system that has been programmed to accept redirection of the SRG IP Phones and provide call service for the SRG in Normal Mode.

NCS

Network Connection Service. It provides a TPS interface to the NRS, allowing the TPS to query the NRS using the UNISTim protocol. It is required to support the main office, branch office, Virtual Office, and Geographic Redundancy features.

Normal Mode

The SRG is in Normal Mode when the IP Phones on the SRG are correctly redirected to the main office Call Server.

NRS

Network Routing Service. The software application where all systems in the network are registered. The NRS consists of the H.323 Gatekeeper and the Network Connection Service (NCS).

PSTN

Public Switched Telephone Network. The international telephone system based on copper wires carrying analog voice data. This is in contrast to newer telephone networks based on digital technologies.

Telephone service carried by the PSTN is often called plain old telephone service (POTS).

QoS

Quality of Service, a networking term that specifies a guaranteed throughput level. One of the biggest advantages of ATM over competing technologies, such as Frame Relay and Fast Ethernet, is that ATM supports QoS levels. This enables ATM providers to guarantee to their customers that end-to-end latency does not exceed a specified level.

There are several methods to provide QoS, as follows:

- high bandwidth

- packet classification
- DiffServ
- IP fragmentation
- traffic shaping
- use of the platform's queuing mechanisms

routing

The process of selecting the correct path for packets transmitted between IP networks by using software-based algorithms. Each packet is processed by the algorithm to determine its destination.

SRG 50

Survivable Remote Gateway 50. This describes the equipment used to create an IP branch office with a CS 1000 system acting as the main office. The base system for SRG is a Business Communication Manager running BCM 3.6 software.

TPS

IP Phone Terminal Proxy Server. This server controls the connection of IP Phones. It resides on the Signaling Server with an emergency backup on the Voice Gateway Media Card.

UDP

Uniform Dialing Plan. Each location within the network is assigned a Location Code, and each telephone has a Directory Number that is unique within the network. Under the UDP, the SRG must include the location code in the Branch User ID (BUID).

VoIP

Voice over IP trunk. This IP pathway between two system IP voice gateways allows the system to exchange telephone calls over the Internet.

WAN

Wide Area Network. A computer network that spans a relatively large geographical area. Typically, a WAN consists of two or more local area networks (LAN).

Computers connected to a wide area network are often connected through public networks, such as the telephone system. They can also be connected through leased lines or satellites. The largest WAN in existence is the Internet.

ZDP

Zone Digit Prefix. This is the number that the main office appends to a local SRG PSTN call dialed from an SRG IP Phone in Normal Mode. This number differentiates the call from a main office PSTN call dialed by the main office telephones. The ZDP routes the call through VoIP trunk to the SRG.

Index

B

Branch office 213
Branch office dialing plan 27

C

Capacity 26
CDP 213
CLID composition 47
CLID verification 47
Configuring ESA for branch office 192
Configuring ESA using Element Manager 202
Configuring the dialing plan using Element Manager 63
Configuring the NRS for ESA SPN 201
Configuring zone parameters using Element Manager 36
Coordinated Dialing Plan 65

D

dialing plan 213
Dialing plan configuration 43
Dialing plan configuration for SRG PSTN access 48
Dialing plan configuration in Normal Mode 48
DSP 213

E

Emergency Service using Special Numbers 202
Emergency Services Access (ESA) 190
Emergency Services configuration 189

Emergency Services for Virtual Office 200
ESN Access Codes 27

G

Gatekeeper 214
Gateway 214

H

H.323 214
Hardware description 14

I

IP 214
IP Phone calls 23, 23

L

Local Mode 215

M

Main office 215
Main office configuration 31
Main office hardware description 14
Main office information required by the SRG 32, 32
Main office requirements 17, 17
Media Redirection Scenarios 209
Music on hold 28

N

NCS 215
Normal Mode 215
Normal Mode and Local Mode overview 19

NRS 215

O

Off-net dialing plan 45
On-net dialing plans 43
Optional features to enhance SRG
functionality 18

P

PSTN 215

Q

QoS 215

R

Routing 216
Routing calls 45
Routing ESA calls 191

S

Signaling Server 15, 15
SIP Redirect Server Network Routing
Service 15
SRG 216
SRG information required by the main
office 31, 31

SRG PSTN to an SRG telephone (DID
call) 45

SRG user call to an SRG PSTN 45
Supported IP Phones 16
Survivable Remote Gateway 11, 11

T

Testing PSTN access 64
Testing the ESDN number 202
Testing the phone in Local Mode 23
Time of Day 24
TPS 216

U

UDP 216
Uniform Dialing Plan 85

V

Virtual Trunks capacity 26
VLAN 216
VoIP 216

Z

ZDP 217
Zone-based digit manipulation 46
Zones 24, 24

Nortel Communication Server 1000

Main Office Configuration Guide for SRG 50

Copyright © 2005-2007, Nortel Networks
All Rights Reserved.

Publication: NN43001-307
Document status: Standard
Document version: 02.02
Document date: 3 December 2007

To provide feedback or report a problem in this document, go to www.nortel.com/documentfeedback.

Sourced in Canada.

The information in this document is subject to change without notice. The statements, configurations, technical data, and recommendations in this document are believed to be accurate and reliable, but are presented without express or implied warranty. Users must take full responsibility for their applications of any products specified in this document. The information in this document is proprietary to Nortel Networks.

Nortel, Nortel (Logo), the Globemark, SL-1, Meridian 1, and Succession are trademarks of Nortel Networks.

All other trademarks are the property of their respective owners.



Free Manuals Download Website

<http://myh66.com>

<http://usermanuals.us>

<http://www.somanuals.com>

<http://www.4manuals.cc>

<http://www.manual-lib.com>

<http://www.404manual.com>

<http://www.luxmanual.com>

<http://aubethermostatmanual.com>

Golf course search by state

<http://golfingnear.com>

Email search by domain

<http://emailbydomain.com>

Auto manuals search

<http://auto.somanuals.com>

TV manuals search

<http://tv.somanuals.com>