



DECT Industrial Handset User Guide



Table of Contents

TABLE OF CONTENTS	2
1 HANDSET INFORMATION.....	4
2 GENERAL	5
2.1 HANDSET.....	5
2.2 DISPLAY	6
3 INSTALLATION.....	7
3.1 INSTALLING THE CHARGER.....	7
3.2 WALL MOUNTING THE CHARGER	7
3.3 CHARGING RACK.....	7
3.5. BATTERY MANAGEMENT	8
3.5.1. <i>Battery Installation / Removal</i>	8
3.5.2. <i>Charge before Use</i>	8
3.6. IMPORTANT BATTERY INFORMATION	8
3.7. OPERATING TIMES	9
3.8. BATTERY CHARGING INFORMATION	9
3.9. CHARGE PROGRESS INDICATION.....	9
3.10. LOW BATTERY WARNING	10
4 INITIAL SETUP.....	11
4.1 INITIAL SETUP AND OPERATION.....	11
4.2 CREATE SUBSCRIPTION	11
4.3 REMOVE SUBSCRIPTION	12
4.4 SELECTING A DECT SYSTEM (ROAMING)	13
5 USING THE HANDSET	14
5.1 OPERATING IN STANDBY MODE.....	14
5.2 HANDSET ON/OFF	14
5.3 KEYPAD LOCK	14
5.4 VOLUME CONTROL	15
5.5 MAKING CALLS	15
5.5.1 <i>On-Hook Dialing</i>	15
5.5.2 <i>Off-Hook Dialing</i>	16
5.5.3 <i>Dial from the Personal Phone Book</i>	16
5.5.4 <i>Redial</i>	17
5.5.5 <i>Caller List (CLIP)</i>	18
5.6 RECEIVING CALLS.....	18
5.7 SILENT MODE	19
5.8 SOS BUTTON.....	19
6 FEATURES DURING CONVERSATION.....	19
6.1 CALL TRANSFER	19
6.2 CALL HOLD	19
6.3 MICROPHONE MUTE.....	20

6.4	PERSONAL PHONE BOOK	20
6.4.1	<i>Add Personal Phone Book Entry</i>	20
6.4.2	<i>Edit a Number in the Personal Phone Book</i>	21
6.4.3	<i>Edit a Name in the Personal Phone Book</i>	22
6.4.4	<i>Delete Personal Phone Book Entry</i>	22
6.5	LANGUAGE SELECTION	23
6.6	MESSAGE WAITING INDICATION FOR VOICE MAIL	23
6.7	USER SETUP (PROFILES).....	24
6.8	SETTINGS.....	25
6.9	RINGER TONE	25
6.10	RINGER VOLUME	26
6.11	KEY CLICK TONE.....	26
6.12	VIBRATOR	27
6.13	AUTOMATIC CALL ANSWERING (B-ANSWER).....	27
6.14	START VOLUME	28
6.15	BACKLIGHTING.....	28
7	OUT OF RANGE	29
8	E2 MESSAGING	29
9	SHORTCUT LIST	30
10	MENU TREE	31

1 HANDSET INFORMATION

This product is classified with IP52 classification as defined in EN60529.

Ensure the adapter voltage is the same as the electrical outlet voltage.

The DECT Industrial Handset uses radio signals and does not guarantee a connection in all circumstances. Do not rely on a cordless telephone to make emergency calls.

Never use your handset:

- in the vicinity of electrical detonators
- in shielded rooms
- in areas where radio transmission is forbidden
- in aircraft

Do not place a handset near:

- water, moisture, or damp areas
- heat sources, direct sunlight, or unventilated areas
- devices that generate strong magnetic fields such as electrical appliances, fluorescent lamps, computers, radios, televisions or fax machines
- areas where the handset can be under ventilated or exposed to liquid, or exposed to the insertion of foreign objects
- areas with excessive vibration, shock, or temperature

Do not open the handset, the charger, or the charger rack.

2 GENERAL

2.1 Handset

The handset has 22 keys which are described as follows:



Voice (short press) & E2 (long press) Message function.



In Menu - Cursor left
After a digit - delete last digit.
Long press - delete all.
In on hook - Redial menu.



In Menu - Cursor right.



Confirmation or jump to next level in the menu.
In off hook - Mute.
Long key press turns the handset OFF.



In off hook - Recall.
In on hook - Enter or exit the menu structure.



On hook/off hook and turn ON handset.

” * ”

Used with  to enable keypad lock. Long press for a pause.

“0-9”

Digits or letters in alphanumeric mode

“ # “

Choose uppercase or lowercase letters in alphanumeric mode.



Telephone book

Blue top key SOS button.

The two keys at the right hand side of the handset are for volume control.

2.2 Display

Three lines, of 12 alphanumeric characters in length, can show text or caller information.

The bottom line displays 5 icons, they are described as follows:



ON – Handset in range
OFF – Handset out of range



ON – New E2 message received
OFF – NO new voice mail or all voice mails read



ON - Handset is **off** hook
OFF – Handset is **on** hook
Flashing – Number being dialed



User can go to next line or step



User can go back to the previous line or step

The display has a backlight which is activated after a key press or on an incoming call. It switches OFF automatically after 10 seconds. Also, the backlight can be switched OFF permanently.

3 INSTALLATION

3.1 Installing the Charger

Connect the power line cable to the back of the charger and then plug the AC adapter into the mains socket outlet.

3.2 Wall Mounting the Charger

- Drill two holes in the wall, with a horizontal spacing of 45 mm and insert the screws.
- Use a screwdriver to remove the two screws in the top plate of the charger.
- Turn the top insert plate 90 degrees in the charger and put the screws back in.
- Plug the power cable into the wall socket.
- Hang the charging unit on the screws in the wall.
- Place the telephone handset on the charger.

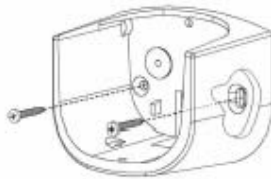

3.3 Charging rack

The charging rack can contain a maximum of 5 chargers. A maximum of 4 charger racks can be connected together, using the same AC adapter, with a maximum current of 5 A.



Installation of the Chargers on the Charging Rack

The chargers can be placed in two different positions, depending on the usage of the chargers. If the chargers are placed on the desktop the chargers should be connected with 2 screws.

When the charging racks are wall-mounted the chargers should be connected as follows:

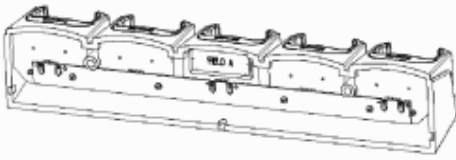

3.5. Battery Management

3.5.1. Battery Installation / Removal

The handsets are equipped with a rechargeable NiMh battery pack. The battery pack is installed in the back of the handset housing.

The batteries can be charged and discharged hundreds of times, but sooner or later they will be worn out. If the operating time is significantly shorter than usual, then it is time to have the batteries replaced.

Note: The batteries should not be removed by the user. This should be carried out by qualified service personnel only.

3.5.2. Charge before Use

The handset is delivered with an almost uncharged battery. The handset has to be placed in a charger or a charging rack and charged for at least 24 hours before use. When the handset is placed in a charger or charging rack, it switches on and the display shows the battery status.

3.6. Important Battery Information

The battery pack consists of a NiMh battery pack, that should not be removed by the user, this action should only be performed by authorized service personnel.

Heat or cold reduces the performance and service life of the batteries.

Preferred operating temperature is between 15° C and 25° C.

3.7. Operating Times

Standby time - up to 90 hours.

Talk time – up to 10 hours.

3.8. Battery Charging Information

The battery capacity can be checked using the menu option. As follows:

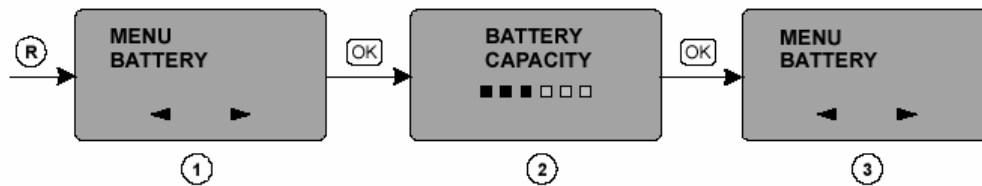

1. Press the key to enter the menu display and use the or keys to select Menu battery.
2. Press the key to enter the battery display. The display will show the battery status.
3. Press the key to go one step back.
4. Press the key to go back to normal mode.

3.9 Charge Progress Indication



When the handset is in the charger, the charging progress is indicated by a flashing red LED on top of the handset. The charge status is also indicated in the display. Completion of the charge cycle is indicated by switching ON the red LED continuously and the display will return to normal mode.

Note: When the handset is placed in the charger, the vibrator and B-answer (auto answer functions are disabled.

3.10 Low Battery Warning

If the battery capacity reaches a certain minimum value:

On-Hook

- The display flashes battery low.

Off-Hook

- The display flashes battery low
- The handset gives 4 short beeps every 5 seconds.

4 INITIAL SETUP

4.1 Initial Setup and Operation

The handset can be operated on a maximum of 10 DECT systems. Before you can make a call via a DECT system, the handset has to be subscribed to the Meridian 1. A pin code is necessary for the subscription process.

A complete **menu tree** is located at the end of this document for reference.

4.2 Create Subscription

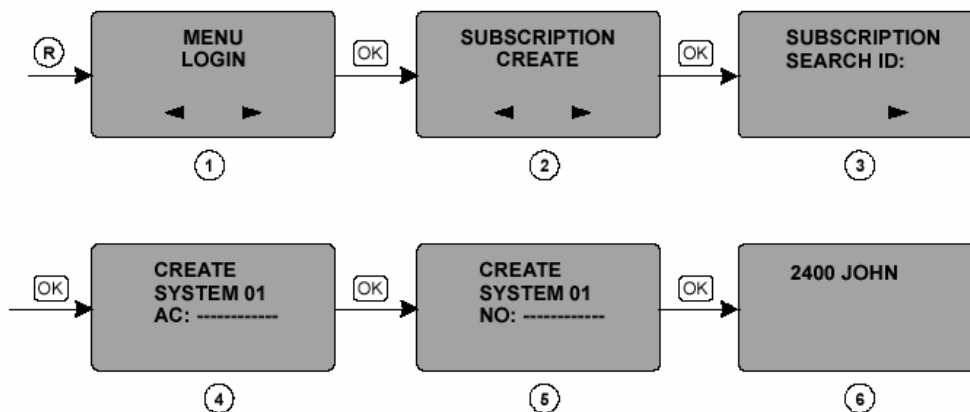

To subscribe a handset to a system:

1. Press the menu **R** key to enter the menu display and use the **◀** or **▶** key to select **menu login**.
2. Press the **OK** key to enter the login display and use the **◀** or **▶** key to select **subscription create**.
3. Press the **OK** key to continue subscription and wait until the **SEARCH.ID (PARK)** is visible in the display. If there is more than one PARK ID available, ensure that the correct PARK is selected.
4. Use the **◀** or **▶** key to select the system number to which the handset has to be subscribed. Press the **OK** key.
Enter the Authentication Code (AC) and press the **OK** key.
5. Enter name and/or number (NO) and press the **OK** key to complete the subscription. The handset name can be edited in the **subscription edit** menu.







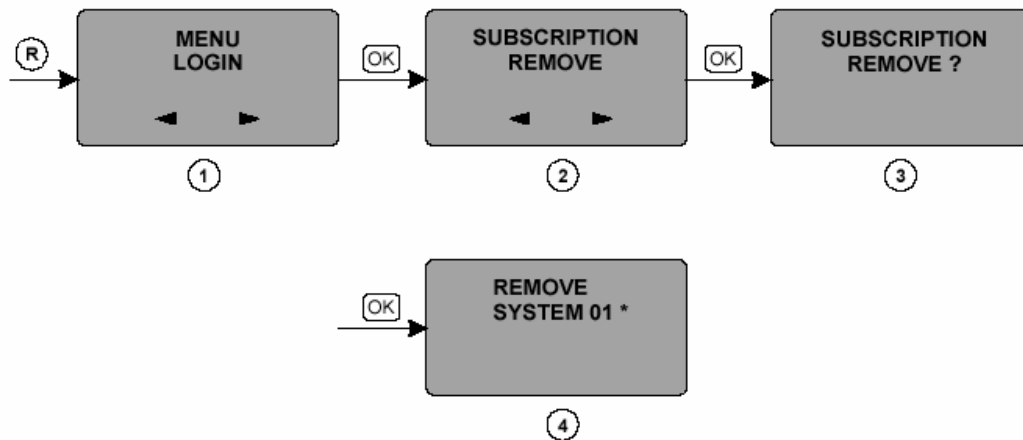



The default handset name 'PHILIPS' is displayed on handsets that are not subscribed.

When the handset cannot be subscribed to the system, the display will show 'subscription failed'. Press the  key to leave the subscription failed display and to return to the stand-by display.

4.3 Remove Subscription



To remove a subscription from the handset:

1. Press the  key to enter the menu display and use the  or  key to select **menu login**.
2. Press the  key to enter the login display and use the  or  key to select **subscription remove**.
3. Press the  key to continue the remove option and use the  or  key to select the system that has to be removed.
4. Press the  key to remove the system from the handset.

Note: If the handset requests a password, enter the appropriate 4 digit password. The default password is 0000. The current selected system is shown with a *

4.4 Selecting a DECT System (Roaming)

Roaming between Meridian 1 systems is only possible when the handset is subscribed to each system.

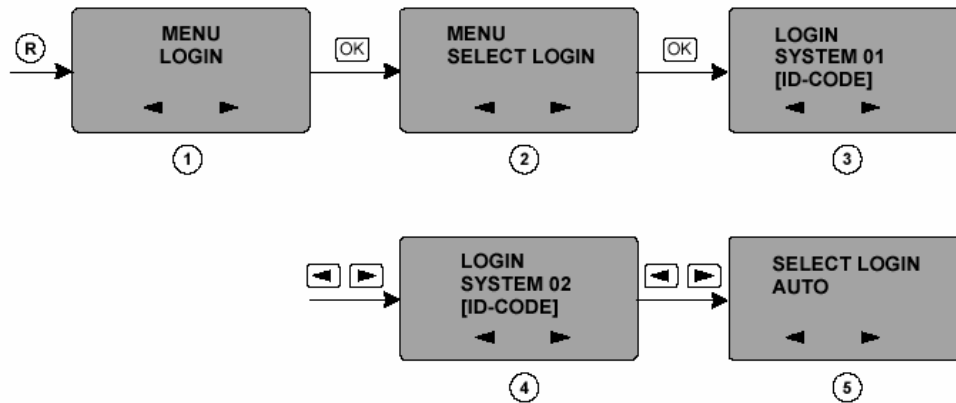

Manual

To switch between DECT systems manually:

1. Press the **R** key to enter the menu display and use the **◀** or **▶** key to select **menu login**.
2. Press the **OK** key to enter the system display and use the **◀** or **▶** key to select **menu select login**.
3. Press the **OK** key to enter the login display. Use the **◀** or **▶** key to select the system to which the handset has to login. The current system is indicated with a *, e.g. **system 01***. Press the **OK** key to login to the selected system. The login option can be cancelled by pressing the **R** key.

Automatic

To switch between DECT systems automatically:

1. Execute the same steps as before, in the last step select **select login auto** with the **◀** or **▶** key instead of e.g. **system 1**. Press the **OK** key to execute. The login option can be cancelled by pressing the **R** key.

Note 1: When a system is manually selected, it is indicated in the menu select login with an *: e.g. **system 01***.

Note 2: When the auto login option is selected, it is indicated in the menu select login with an additional A e.g. **system 01A**.





5 USING THE HANDSET

A complete **menu tree** is located at the end of this document for reference.

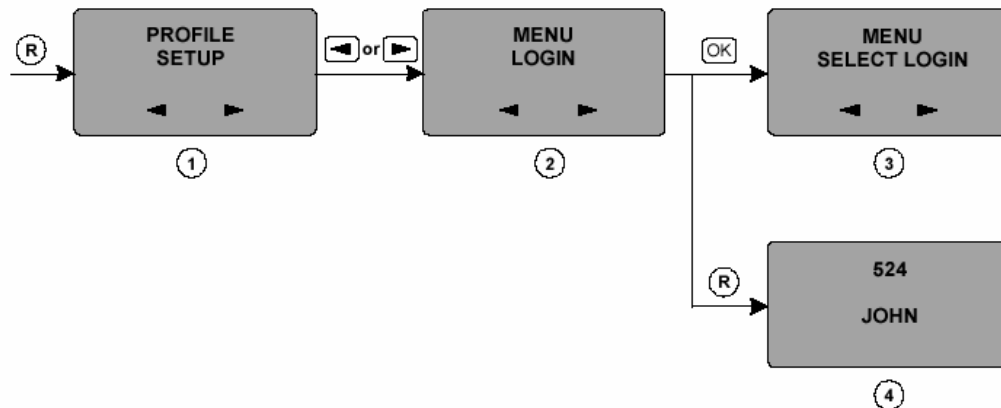
5.1 Operating in Standby Mode

The menu feature operates as follows:



1. Press the  key to enter the menu display.
2. Use the  or  key to select the next or previous option.
3. Press the  key to go to the selected option, e.g. MENU LOGIN.
4. Press the  key to return to the stand-by display.

5.2 Handset ON/OFF

The handset can be switched ON by pressing the  key for a few seconds, or when placed in the charger.

The handset can be switched OFF by pressing the  key for a few seconds.

5.3 Keypad Lock

The keypad lock can be activated by pressing the  key immediately followed by the * key. The same operation is required to deactivate the keypad lock. 'KEY LOCKED' is displayed when the keypad lock is activated.

5.4 Volume Control

The volume switch for the earpiece is located at the right hand side of the handset. When the volume switch is pressed, the display shows the current volume setting. The volume can be increased with the + key, it can be decreased with the - key.

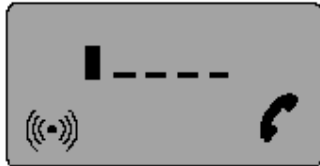

5.5 Making Calls

There are a number of ways to make a phone call:

- On-hook dialing
- Off-hook dialing
- Dial a number from the personal phone book
- Redial numbers.

These methods are described in the following subsections.

5.5.1 On-Hook Dialing

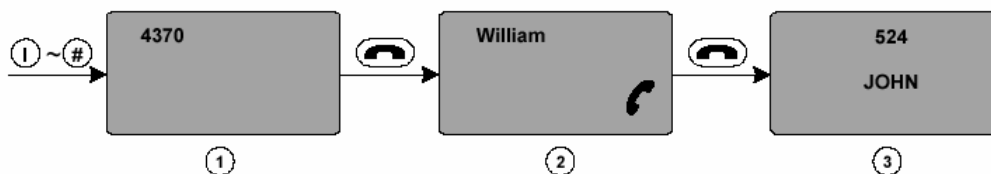

On-hook dialing is used to dial a phone number using the numeric keys. On-hook dialing allows you to check and correct the number before the call is made.



To dial a number while on-hook:



1. Use the numeric keys to type the number that has to be dialed, e.g. 4370.

Numbers entered incorrectly can be deleted with the  key.

Note: When deleting a digit, use the  or  keys to place the cursor on the digit to the right of the digit to be removed. Press the  key for extended duration to remove the digit.

2. Press the  key to dial the number.

3. Press the  key to end the call.

If a space is needed in a number, e.g. to access an external phone line, press the  key for 2 seconds. The display will show a '-'.

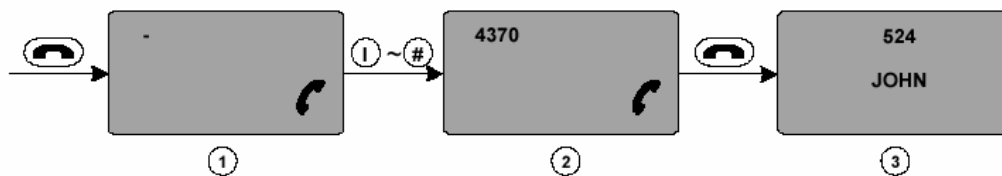

5.5.2 Off-Hook Dialing



To dial a number off-hook:

1. Press the  key to enter the dial display.

2. Use the numeric keys to type the number that has to be dialed, e.g. 4370. The handset automatically dials the number.



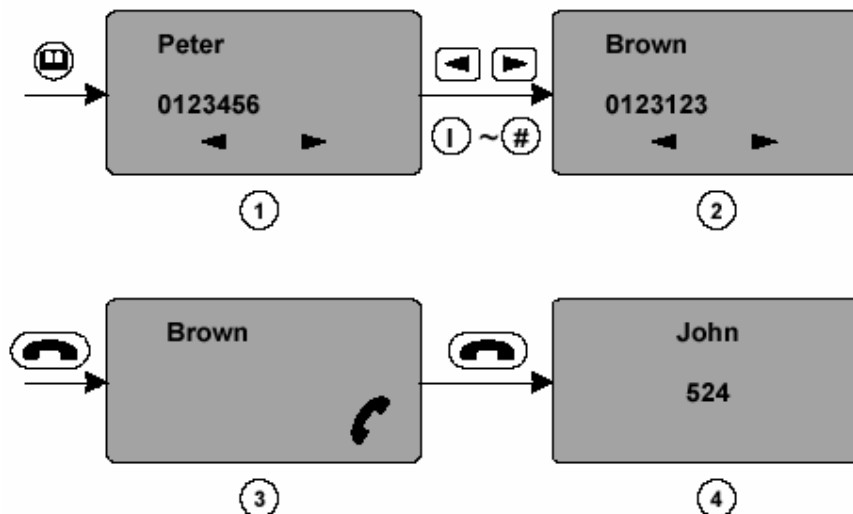

3. Press the  key to end the call and return to the idle display.

5.5.3 Dial from the Personal Phone Book

The personal phone book can contain up to 80 entries.



To dial a number from the personal phone book:







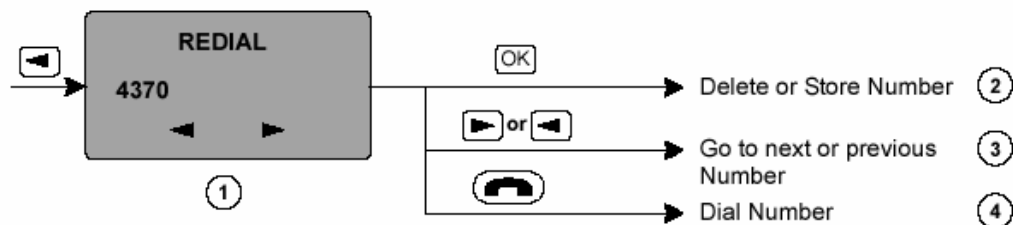

1. Press the  key to enter the Phone Book. The first entry appears in the display. If the phone book is empty, the  key will not function.
2. From this display, there are 2 methods to find a name:
 - Use the  or  key to move through the personal phone book entries.
 - Pressing an alphanumeric key will result in a quick search..
3. Press the  key to dial the person visible in the display, e.g. Mattie.



5.5.4 Redial

The redial option allows you to redial one of the last ten dialed phone numbers.



To use the redial feature:

1. Press the  key from the standby mode to enter the redial display.
2. Press the  or  key to move to various numbers in the redial list.
3. Press the  key to dial the selected number.
4. Press the  key on the selected number to do the following:
 - Delete a number, after DELETE? Press the  key.
 - Store a number in the phone book, after STORE NO? Press the  key.
 - Delete all numbers in the redial list, after DELETE ALL? press the  key.

The Redial Menu can also be entered via the Menu Key, scroll with the  or  key to enter **Menu Redial**.

When a name is available in the Phone book, the name will be shown in the redial menu.

5.5.5 Caller List (CLIP)

When the handset rings and the call is not answered, it will be stored in the Caller list (CLIP). The Caller list contains a maximum of 10 entries. The entries in the Caller list and the Redial list can be accessed the same way. An item in the Caller list can be distinguished from an item in the Redial list as follows: an item in the Caller list will also turn the red LED on at the top of the handset.

When an item in the Caller list has been called back, it will be removed from the list.

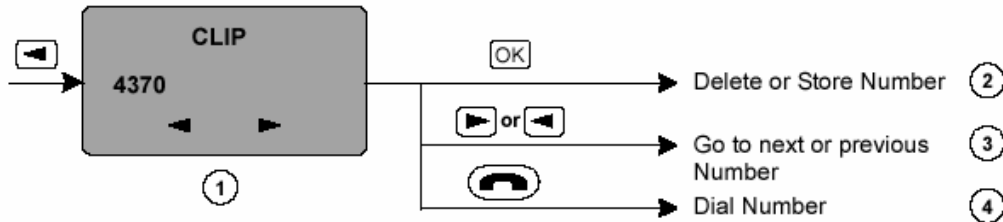

To use the Caller list (CLIP) feature:

1. Press the key to enter the Redial menu. Press the or until the display shows the CLIP display. The LED is also switched on.
2. The display will show the last 10 missed call numbers.
3. Press the key to dial the selected number.
3. Press the key on a selected number to:
 - Delete a number, after DELETE? Press the key.
 - Store a number, after STORE NO.? press the key.
 - All numbers in the redial list can be deleted, after DELETE ALL? press the key.

When an item is viewed in the Redial list, REDIAL is displayed and the LED is switched OFF.

When an item is viewed in the Caller list, it is shown with CLIP and the LED is switched ON.

When there is an item in the Caller list, you will be notified via a flashing red LED on top of the handset.

5.6 Receiving Calls

When a handset receives a phone call it will ring. To accept a call, press the key.

When a conversation has ended press the key again. Mute ringing by pressing the key. The display will show RINGER MUTED.

If automatic call answering is used, the phone call will be accepted automatically. It is not necessary to press the  key.

5.7 Silent Mode

In Silent mode the handset will use the vibrator instead of ringer and bleep sounds.

To switch the Silent mode ON/OFF:

Press the  key immediately followed by the # key to switch the Silent mode ON or OFF. SILENT is displayed when this option is switched on.

5.8 SOS Button

Press the  key to enter Profile Set Up.



Press the  key to enter Set Profile.

Press the  key two times to select SOS Profile.

Press the  key to enter the SOS number.



6 FEATURES DURING CONVERSATION

6.1 Call Transfer

- Press the  key to place the call on hold.
- Dial the number to which the phone call must be transferred
- Inform the person at the other end
- Press the  key.
- The call is transferred

If the called number does not answer, the original phone call can be resumed by pressing the  key again.

6.2 Call Hold

- Press the  key to place the call on hold
- Dial a number.
- Press the  key again to resume the original call

6.3 Microphone Mute

The microphone mute can be activated or deactivated during conversation by pressing the **OK** key. When the microphone mute is active the display shows **MIC. MUTED**.

6.4 Personal Phone Book

Press the  key to enter the Phone Book.

Note: If there is no entry in the phone book, then the  key will not function.

The personal phone book is a list of names and numbers, which can be filled out by the user. This list is stored in the handset and can contain up to 80 entries. The personal phone book enables you to add, edit or delete entries. These features are described in the following sections.

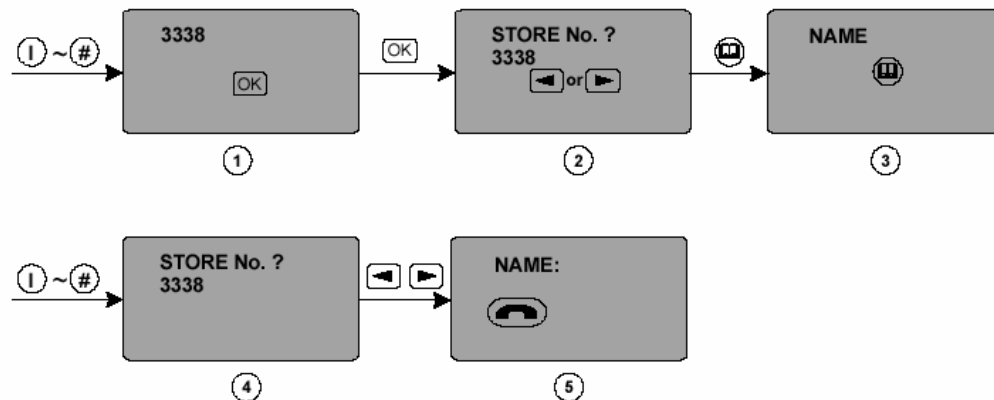

6.4.1 Add Personal Phone Book Entry



If the phone book contains 80 entries, it is not possible to add a new entry.

To add a personal phone book entry:

1. In the stand-by mode (on-hook) enter the number to be stored.
2. Press the  key to enter the number in the phone book, the display shows STORE NO? and the number just typed in.







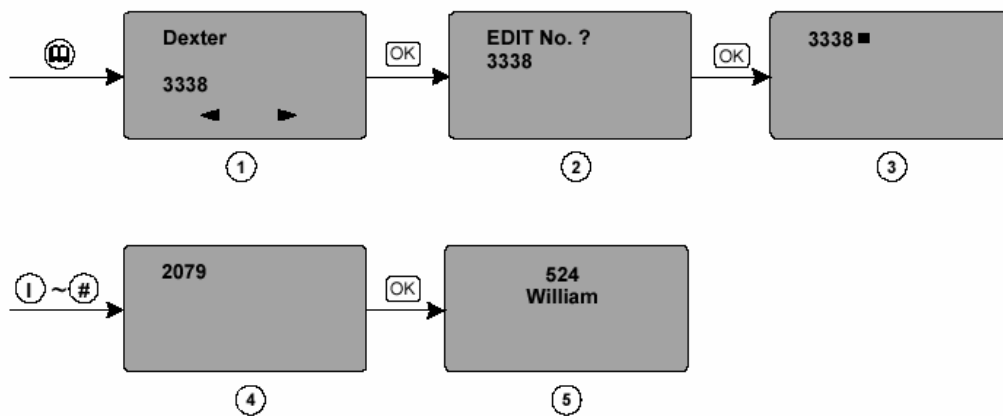



3. Press the  key to enter the number. The display will show NAME:, type in a name using the alphanumeric keys.
4. Press the  key to enter the name in the phone book and return to the stand-by mode again.
5. Pressing the  key at any time cancels and returns to stand-by mode.



Numbers from the Caller list or Redial List can be stored in the personal phone book.

6.4.2 Edit a Number in the Personal Phone Book



To edit a personal phone book entry:







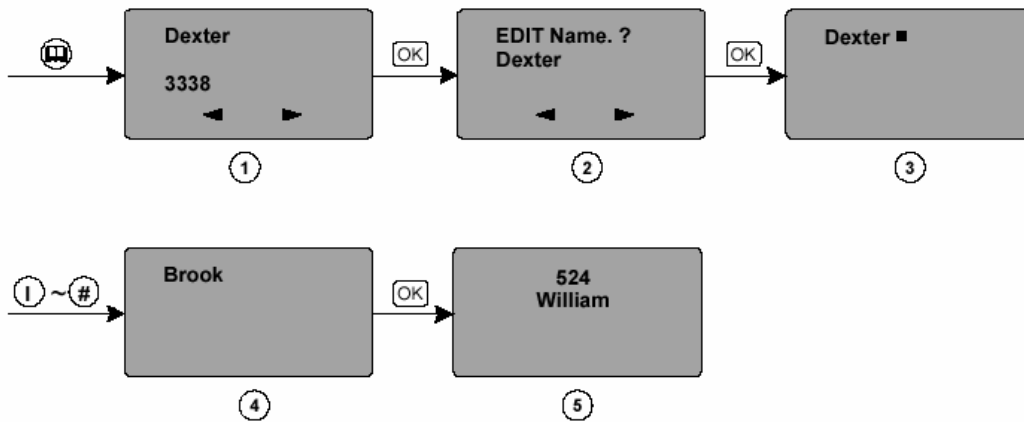



1. Press the  key to enter the phone book and use the  or  key to select the required number.
2. Press the  key when the required number is found. Use the  or  key to select the edit menu. The display will show EDIT NO?
3. Press the  key to edit the number. Use the  key to remove wrong digits.
4. When the correct number is entered press the  key to return to the stand-by mode.
5. Press the  key at any place cancels and returns to stand-by mode.

Note: When deleting a digit, use the  or  keys to place the cursor on the digit to the right of the digit to be deleted. Press the  key for extended duration to remove the digit.

6.4.3 Edit a Name in the Personal Phone Book





To edit a personal phone book entry:

1. Press the  key to enter the phone book and use the  or  key to select the required number
2. Press the  key when the required number is found. Use the  or  key to select the edit menu. The display will show EDIT NAME?
3. Press the  key to edit and use (extended press) the  key to remove wrong characters.
4. When the correct name is entered, press the  key to return to the stand-by mode.
5. Press the  key to cancels or return to stand-by mode.

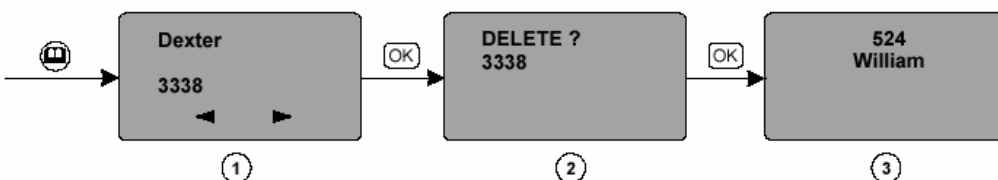
6.4.4 Delete Personal Phone Book Entry



To delete a personal phone book entry:

1. Press the  key to enter the phone book and select the entry to be deleted.
2. Press the  key to select this entry for deletion. The display will show 'DELETE?'
3. Press the  key to confirm deletion and return to the standby mode.

6.5 Language Selection

The handset is designed to contain all the menus in 6 different languages stored in memory. The actual language to be used can be selected via the menus. The following languages are available:

- English
- German
- French
- Italian
- Spanish
- Dutch

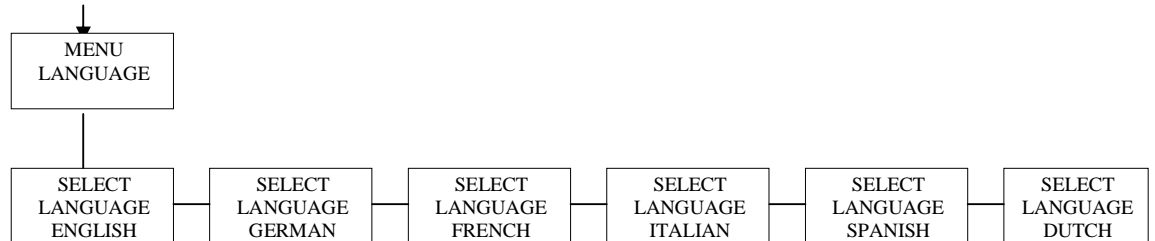





6.6 Message Waiting Indication for Voice Mail

'Voice Mail' is displayed when there is a voice mail. It will be removed when the voice mail is listened to.

It is possible to program the  key to enter voice mail.

To program the  key:

1. Press the  key, then press the  key.
2. Press the  to select Voice Number, then press the  key.
3. Enter the voice mail number followed by #.

4. The DN and password can also be entered to access voice mail directly.

Note 1: It is possible for another party to determine the password of your voice mail if it is programmed.

Note 2: Long press the * for a pause.



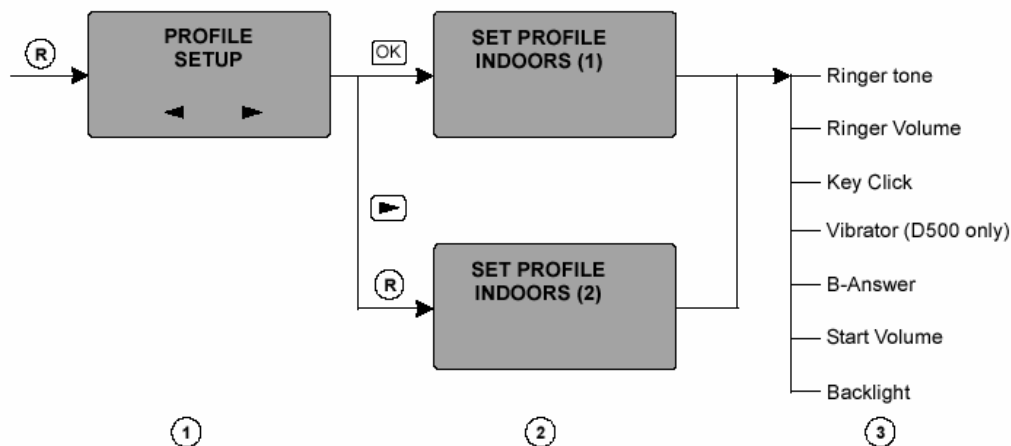

5. Short press the  key to enter voice mail.

6.7 User Setup (Profiles)

There are two user defined profiles. The profiles can be used to select different handset settings. A typical example of where the 2 different profiles may be used is where the user requires different handset settings for indoor and outdoor usage.



To change a User Profile:

1. Press the Menu key to enter the menu **Profile Set Up**.
2. Press the  key to enter this menu. Use the  or  key to select **Set Profile Indoors (1)** or **Profile Outdoors (2)**. Press the  key to enter the selected Profile.
3. The following settings can be changed:

- Ringer Tone
- Ringer Volume
- Key Click
- Vibrator
- B-Answer (Automatic Answering)
- Start Volume (of loudspeaker)
- Backlight

4. Press the  key to return to stand-by mode.

6.8 Settings

Within a profile the user can define several settings. These are described in the following sections. Each setting will have a default as shown in the table below.





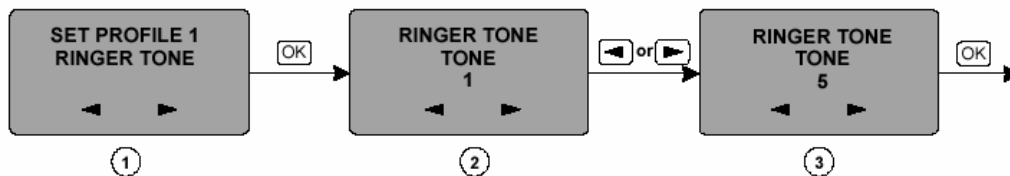

Setting	Choices	Default
Ringer tone	1-9	1
Ringer volume	0-5	3
Key click tone	0-5	3
Vibrator	On/off	On
B-answer	On/off	Off
Start Volume	1-5	3
Backlighting	On/off	Off

6.9 Ringer Tone

There are 9 different ringer tones.



To set a ringer tone:

1. Enter the Set Profile display and use the  or  key to select ringer tone.
2. Press the  key to enter the ringer display. Use the  or  keys to switch between ringer types. The handset will produce the ringer sound when a scroll key is pressed.
3. Press the  key to set the visible ringer type. E.g. ringer tone 5. The handset will return to the Set Profile display.

6.10 Ringer Volume

The 5-step ringer volume option enables users to set the loudness of the bleep and ringing tones.

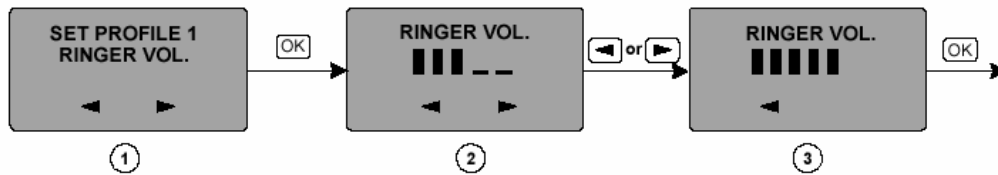

To set the ringer volume:

1. Enter the Set Profile display and use the or key to select **ringer vol.**.
2. Press the key to enter the ringer volume display. Use the or keys to increase or decrease the volume. The handset will produce the ringer sound in the increased or decreased loudness setting. It is also possible to switch the ringer volume OFF in this setting.
3. Press the key to set the volume. The handset will return to the Set profile display.

6.11 Key Click Tone

The key click tone setting determines whether or not the handset beeps every time a key is pressed. The key click tones can be switched ON or OFF.

To switch the key click tones ON/OFF:

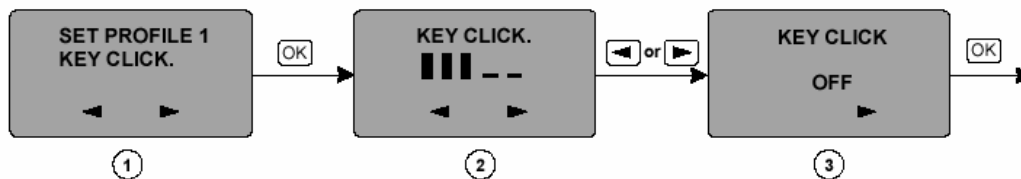

1. Enter the Set Profile display and use the or key to select **key click**.
2. Press the key to enter the key click display and use the or key to select ON or OFF and the loudness of the key click. The display will show the loudness of **key click** or **key click OFF**.
3. Press the key to return to the Set Profile Menu.

6.12 Vibrator

The vibrator functions when the handset is ringing or bleeping, it vibrates in the same pattern as the ringer or bleep sound.

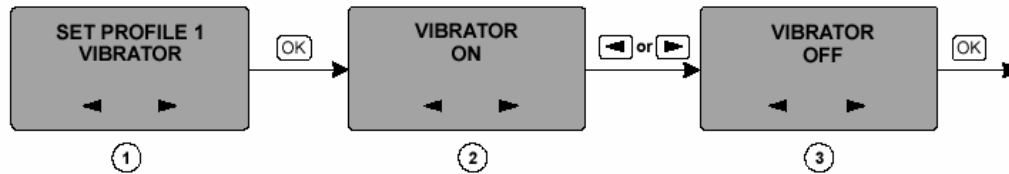

To switch the vibrator ON/OFF:

1. Enter the Set profile display use the or key to select **vibrator**.
2. Press the key to enter the vibrator display and use the or key to select **ON** or **OFF**. The current setting is shown in capitals.
3. To activate or deactivate the vibrator, press the key. The display will show **vibrator on** or **vibrator off** before switching to the Set Profile display.

6.13 Automatic Call Answering (B-answer)

The automatic call answering can be switched ON or OFF with the B-answer item of the settings menu.

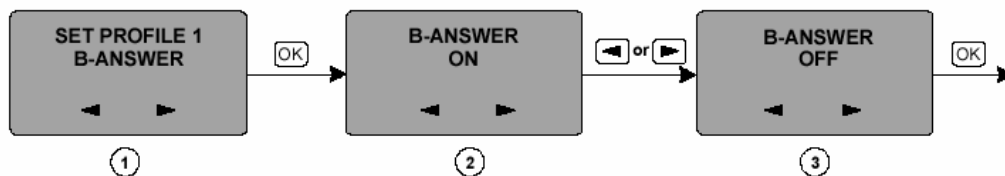

To switch the B-answer ON/OFF:

1. Enter the **Set Profile** display and use the or key to select **B-answer**.
2. Press the key to enter the B-answer display and use the or key to select **ON** or **OFF**. The current setting is shown in capitals.
3. To activate or deactivate the B-answer press the key. The display will show **B-answer ON** or **B-answer OFF** before switching to the Set Profile display.

Note: This function is especially handy when a headset is used.

6.14 Start Volume

The 5-step start volume option enables users to set the loudness of the earpiece to a certain value to start from. Adjustment during conversation can be made with the – and the + keys at the side of the handset. After conversation the volume is set to the start volume setting.

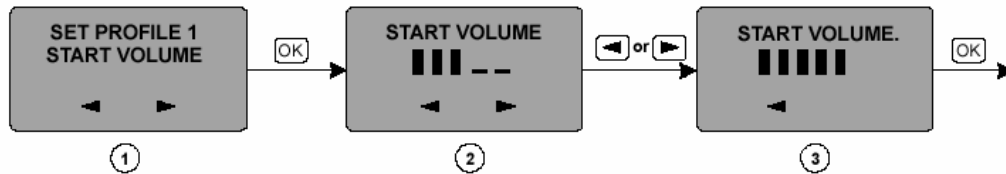

To set the start volume:

1. Enter the **Set Profile** display and use the ◀ or ▶ key to select **start volume**.
2. Press the **OK** key to enter the ringer volume display. Use the ◀ or ▶ keys to increase or decrease the volume. The handset will produce the ringer sound in the increased or decreased loudness setting. It is also possible to switch the ringer volume OFF in this setting.
3. Press the **OK** key to set the volume. The handset will return to the **Set profile** display.

6.15 Backlighting

As soon as a key is pressed or a call is received, the backlighting switches ON. The backlighting switches off automatically to save power.

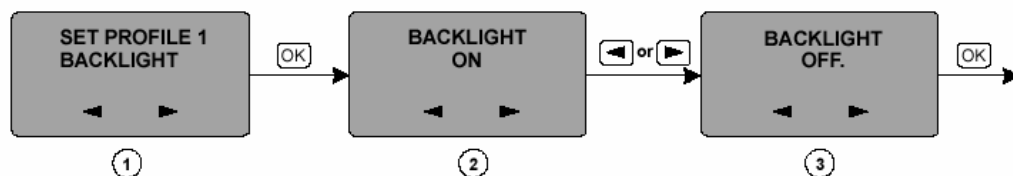

To switch the backlighting ON/OFF:

1. Enter the **Set Profile** display and use the ◀ or ▶ key to select **backlight**.
2. Press the **OK** key to enter the backlight display and use the ◀ or ▶ key to select on or off. The current setting is shown in capitals.
3. To activate or deactivate the backlight feature press the **OK** key. The display will

show **backlight on** or **backlight off** before switching to the Set Profile display.

7 OUT OF RANGE





Each handset is equipped with an out of range detection option. There are three detection mechanism for out of range. They are:





1. Display **OUT OF RANGE** and the disappearance of the  icon.
2. A handset will give 3 short bleeps.
3. The LED on top of the handset will flash for 4 seconds.

When the user re-enters the coverage area, the handset will give one short bleep and all out of range displays are removed.

8 E2 MESSAGING









If there are no messages, then long press the  key to enter New Message menu.

If there are messages, then long press the  key and the  key to select different Messaging operations. Press the  or  keys to select Read, Send, Delete? Delete All? and New Message operations.

Alternatively, press the  key and the  or  keys to select the Message Menu. Press the  key to select the different Messaging operations.

9 SHORTCUT LIST

The following features can be accessed easily via the shortcuts mentioned in the table below.

OPTION	SHORT CUT	DISPLAY SHOWS
Indoors Profile	 key and 1	
Outdoors Profile	 key and 2	PROFILE 2
Silent Mode	 key and #	SILENT
Key Locked	 key and *	KEY LOCKED
Phone book	 key (in standby mode)	
Name search in Phone book	Press the initial letter, while in phone book	
Redial / Caller list	 key (in standby mode)	
Mute for Ringer	 key (while ringing)	
Mute for Microphone	 key (while in conversation)	
Recall	 key	

10 MENU TREE

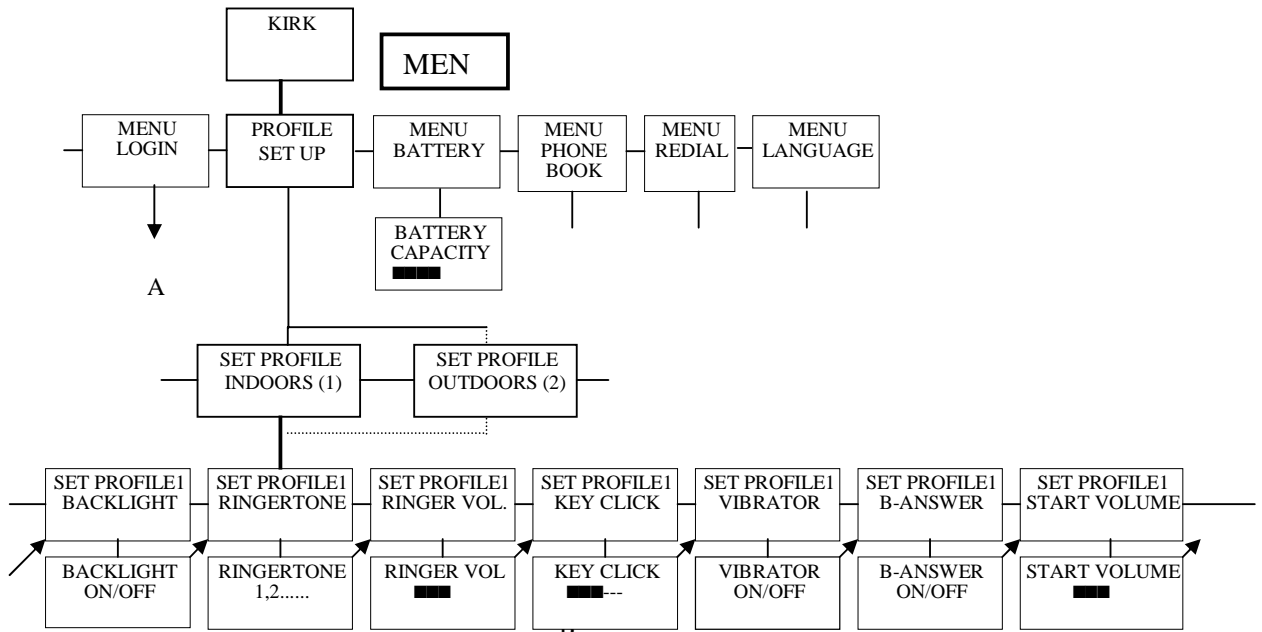

B

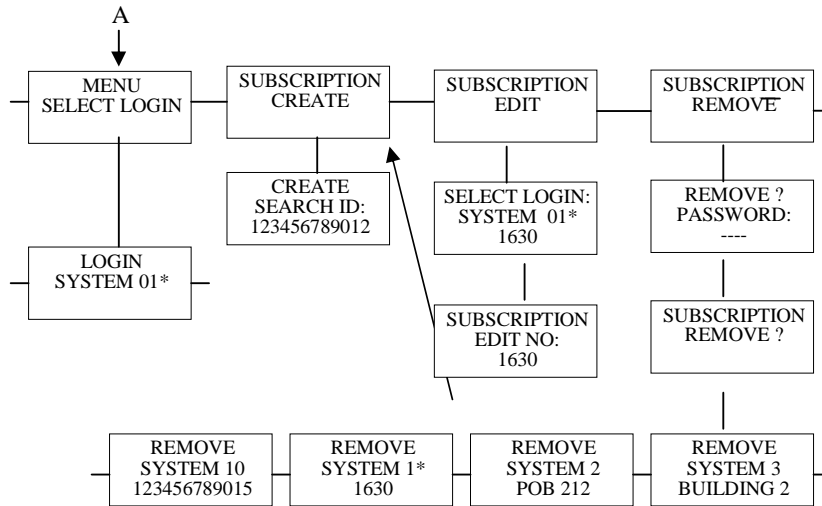

Free Manuals Download Website

<http://myh66.com>

<http://usermanuals.us>

<http://www.somanuals.com>

<http://www.4manuals.cc>

<http://www.manual-lib.com>

<http://www.404manual.com>

<http://www.luxmanual.com>

<http://aubethermostatmanual.com>

Golf course search by state

<http://golfingnear.com>

Email search by domain

<http://emailbydomain.com>

Auto manuals search

<http://auto.somanuals.com>

TV manuals search

<http://tv.somanuals.com>