

Modular ICS 4.0 System Coordinator Guide

Norstar, Meridian and Companion are trademarks of
Northern Telecom

© Northern Telecom 1998

1-800-4 NORTEL
www.nortel.com/norstar
P0881591 Issue 01
Printed in Canada

Table of Contents

Getting started with Norstar 1

- Using this guide 1
 - Understanding programming 2
 - Before you start 3
 - What you'll need to do programming 3
 - Using Buttons 4
 - Using the buttons under the display 5
 - The programming overlay 6
 - A map for working in programming 7
 - Starting and ending a session 11
 - Ending a session 11
-

Frequently used programming operations 13

- Changing the time and date on the display 13
 - Programming Automatic Time and Date 16
 - Adding or changing a system speed dial 17
 - Changing the name of a telephone 20
 - Changing the name of a line 22
 - Making changes to Call Forward No Answer 23
 - Making changes to Call Forward on Busy 25
 - Making Changes to Do Not Disturb on Busy 26
 - What would you like to do next? 28
-

Answering calls 29

- Answering incoming calls with Hunt Groups 29
- Answering an incoming call 29
 - Line buttons 30
 - What line indicators mean 30
 - Rings you may hear 30
- Answering calls at a prime telephone 31
- Using a central answering position (CAP) module 31
 - Customizing your CAP module 32
 - Monitoring telephones with the CAP module 33
- Release button 33

- Hearing aid compatibility 33
- Viewing information about a call on the display 34
 - Using Call Information for a particular call 34
 - Displaying Call Information before or after answering 35
 - Displaying Call Information for a call on hold 35
 - Making Call Display information appear automatically at a telephone 36
 - Changing which information is shown first about a call 36
- Picking up a call ringing at another telephone 37
 - Answering any ringing telephone using Directed Pickup 37
 - Answering any ringing telephone using Group Pickup 38
 - Changing a telephone's pickup group 38
 - Trunk Answer 39
 - Answering a call using Trunk Answer 40
 - Answer buttons 40
- Creating a Conference Call 41
 - Disconnecting one party 42
 - Independently holding two calls 43
 - Putting a conference on hold 43
 - Splitting a conference 43
 - Removing yourself from a conference 44
- Listening to a call as a group 45
 - Canceling Group Listening 45
- Using Handsfree/Mute 45
 - Answering calls without lifting the receiver 45
 - Making calls without lifting the receiver 46
 - Muting Handsfree 46
 - Changing a regular call to handsfree 46
 - Changing a handsfree to a regular call 46
 - Using Handsfree 47
 - Changing Handsfree for a telephone 47
 - Handsfree Answerback 49
- Turning Privacy on or off for a call 49
 - Creating a conference by releasing privacy 50
 - Making a call private 50
- Checking call length using Call Duration Timer 50
- Disconnecting by accident 51
- Time 51

Making calls 53

- Choosing a line using a line button 55
- Line pools 55
 - Using a line pool to make a call 56
 - Programming a memory button with a line pool feature code 56
 - Making calls from an ISDN terminal 57
- Changing how you dial your calls 57
 - Using Standard dial 57
 - Using Automatic dial 58
 - Using Pre-dial 58
- When the internal number you have called is busy 58
 - Priority Call 58
 - Making a priority call 59
 - Giving a telephone the ability to make priority calls 59
 - Using Ring Again 60
 - Turning on Ring Again 61
 - Canceling Ring Again 61

Time savers for making calls 63

- Storing a number on a memory button for Autodial 63
 - Adding an autodial button 63
 - Choosing a line for Autodial 63
 - Using intercom as the line for Autodial 64
- Using Last Number Redial 65
- Preventing a telephone from using Last Number Redial 66
- Using Speed Dial 67
- Making a speed dial call 67
 - Changing and adding System Speed Dials 67
 - Adding or changing User Speed Dial 68
- Using Saved Number Redial 69
 - Saving a number 69
 - Dialing a saved number 70
- Preventing a telephone from using Saved Number Redial 70

Handling many calls at once 73

- Using Hold 73
 - Retrieving a held call 73
 - Holding automatically 73

- Listening on hold 73
 - Holding a call exclusively 74
 - Using Call Queuing 74
-

Transferring calls 75

- Using the transfer feature 75
 - Transferring a call 75
 - Transferring external calls 76
 - Canceling a transfer 76
 - Using Camp-on 78
 - Parking a call 79
 - Retrieving a parked call 80
 - Using Call Park 80
 - Using Callback 82
-

Forwarding your calls 83

- Forwarding your calls to another Norstar telephone 83
 - Canceling Call Forward 83
 - Using Call Forward at your telephone 83
 - Overriding Call Forward 84
 - Changing the automatic Call Forward settings for a telephone 84
 - Changing Forward no answer 84
 - Changing the delay before a call is forwarded 85
 - Forward on busy 85
 - DND on Busy 86
 - Call Forward and Voice Mail 87
 - Line Redirection 87
 - Turning on Line Redirection 88
 - Canceling Line Redirection 89
 - Allowing a telephone to redirect calls 89
 - Turning the redirect ring for a telephone on or off 90
 - How Line Redirection is different from Call Forward 92
 - Using Line Redirection 92
-

Communicating in the office 95

- Paging 95
 - Making a page announcement 95
 - Activating and deactivating the ability to page 96
 - Creating page zones 96
 - Using Page with external paging equipment 98
-

-
- Sending messages 98
 - Sending a message 98
 - Canceling a message you have sent 100
 - Viewing your messages 100
 - Replying to a message 100
 - Replying to a message using an analog telephone connected to an ASM 101
 - Removing items from your message list 102
 - Removing items from your message list using an analog telephone connected to an ASM 102
 - Viewing messages you have sent 103
 - Using Voice Call 104
 - Making a Voice Call 104
 - Muting Voice Call tones 105
 - Answering a Voice Call without touching your telephone 105
 - Preventing Voice Calls to your telephone using Voice Call Deny 105
 - Canceling Voice Call Deny 105

Tracking your incoming calls 107

- Using Call Log 107
 - Call Log options 108
 - Logging a call manually 108
 - Deleting old log items 109
 - Viewing your Call Log 109
 - Viewing a Call Log item 110
 - Erasing log items 110
 - Making a call using Call Log 110
 - Creating a password to your Call Log 111
 - Changing your Call Log password 111
 - Deleting an assigned password 112
 - Programming a telephone to log calls automatically 112
- Using Voice mail 114

Customizing your telephone 115

- Finding out what a button does using Button Inquiry 115
- Making the display darker or lighter using Contrast adjustment 115
- Changing the language on the display 116
 - English 116
 - French 116

- Spanish 116
- Programming a feature code onto a memory button 116
 - Programming feature buttons 117
 - Erasing a feature button 117
- Applying button cap labels 118
 - Types of button caps 119
- Identifying the telephones 119
- Norstar default button assignments 120
- Rules of default button assignment 120
 - M7310 telephone button defaults 121
 - M7324 telephone button defaults 122
 - M7100 telephone button defaults 123
 - M7208 telephone button defaults 123
- Moving line buttons 124
- Changing the type of ring 125
- Adjusting the Ring volume 125
- Hiding the message or calls indication 125
 - Restoring the messages and calls indication 126

User Preferences 127

- Using User Preferences 127
 - Changing button programming 128
 - Changing User Speed Dial 130
 - Changing Call Log options 131
 - Changing how calls are dialed 131
 - Changing the language used on the display 131
 - Making the display lighter or darker 132
 - Changing the telephone's ring 132

Programming Hunt Groups 135

- Adding or removing members from a group 136
 - Moving members of a group 138
- Assigning or unassigning lines to a group 138
- Setting the distribution mode 139
- Setting the hunt delay 141
- Programming busy line setting 142
- Programming the queue time-out 143
- Programming the overflow set 144
- Setting the name 145

Telephone features 147

- Installing Norstar telephones 147
 - Naming a telephone or a line 149
 - Moving telephones 149
 - Stopping calls from ringing at your telephone using Do Not Disturb (DND) 150
 - Stopping calls 150
 - Refusing to answer a call 150
 - Canceling Do Not Disturb 150
 - Using Do Not Disturb 150
 - Using Background Music 151
 - Turning Background Music off 151
-

ISDN PRI and BRI 153

- ISDN PRI 153
- ISDN PRI features 154
 - Network Name Display for PRI 154
 - Name and number blocking for PRI 155
 - Emergency 911 Dialing 155
 - 2-way DID 155
 - Call by Call service selection for PRI 156
 - Dialing Plan and PRI 157
- ISDN BRI 158
 - Line access from an ISDN terminal 159
- ISDN BRI features 159
 - Network Name Display for BRI 159
 - Name and number blocking for BRI 160
- Service provider features 160
 - Call Forward 160
 - Canceling Call Forward 161
 - Calling the number your calls are forwarded to 161
 - Automatic Call Back 161
 - Automatic Recall 161
- ISDN BRI terminals 162
- ISDN applications for BRI and PRI 162
 - Videoconferencing and video telephony 162
 - Desktop conferencing 162
 - File transfer 162
 - Telecommuting 162

- Group 4 fax 163
 - Remote LAN access 163
 - Leased line backup 163
 - LAN to LAN bridging 163
 - Internet and database access 163
-

Using System features 165

- Using alternate or scheduled services 165
 - Preventing certain calls from being made 165
 - Making additional telephones ring 165
 - Changing the lines used by outgoing calls 165
- Turning Services on and off 166
 - An example of how to turn on a Service manually 167
- Turning Services on and off using feature codes 168
 - Viewing the active Services from a two-line display telephone 169
 - Viewing the active Services from a one-line display telephone 169
- Using passwords 171
 - Using a Basic password 172
 - Registration password 173
 - Changing passwords 173
 - Clearing a Call Log password 174
- Using special telephones 174
 - Direct-dial 174
 - Changing the direct-dial telephone assignments 175
 - Hotline 176
 - Bypassing a Hotline 176
 - Making a telephone a hotline telephone 177
 - Control telephone 178
- Using Set lock 178
- Changing Set Lock programming for a telephone 179
- Using an auxiliary ringer 179
 - Turning the auxiliary ringer for a telephone on or off 179
- Using Host System dialing signals 180
 - Link 180
 - Preventing a telephone from using Link 181
 - Pause 181
 - Long Tones 182
 - Programmed Release 183

- Run/Stop 183
 - Wait for Dial Tone 184
 - Using pulse dialing for a call 184
 - Using your Norstar system from an external location 184
 - Controlling access to your Norstar system 185
 - Direct inward system access (DISA) 185
 - Class of Service (COS) 186
 - Maintaining security 186
 - Accessing Norstar remotely over the public network 186
 - Tones 187
 - Using Class of Service (COS) passwords 187
 - Changing your Class of Service 188
 - Programming Automatic Time and Date 189
-

General System features 191

- Set profile 191
 - Line profile 191
 - Pulse or tone dialing 191
 - Disconnect supervision 192
 - Hunt Groups 192
 - Internal numbers 192
 - Line assignment 192
 - Target line 193
 - Line pools 194
 - Overflow call routing 194
 - M7100 telephone 194
 - Memory buttons 195
 - One-line display 195
 - Prime line 196
 - Private lines 196
 - Volume bar 196
 - Wall mounting 197
-

Troubleshooting 199

- Using the alarm telephone 199
 - Reporting and recording alarm codes 199
 - Testing the telephone 199
 - Testing the telephone display 200
 - Testing the telephone buttons 200
-

Testing the speaker in the telephone handset 201

Testing the telephone headset 201

Testing the telephone speaker 201

Testing the power supply to a telephone 202

Common feature displays 203

Index 209

Getting started with Norstar

Your Norstar digital key system has many powerful features that can be customized to keep up with changes in your workplace.

Using this guide

The person who is responsible for adding or moving telephones or making changes to the system is called the system coordinator. This guide is designed to give the system coordinator all the information he or she needs to carry out these kinds of jobs.

The first section contains step-by-step instructions on changing the time and date, deciding how many rings it takes before a call is forwarded and other day-to-day programming. Once you understand these basic steps, you can move on to the many other features described in the second section of the guide, and refer to the first section only from time to time.

You can look at the contents page for an overview of the features that are available, or check the index for specific features or messages displayed on your telephone.

Emergency 911 Dialing

Emergency 911 Dialing is the capability to access a public emergency response system by dialing the digits “9-1-1”.



Emergency 911 Dialing

State and local requirements for support of Emergency 911 Dialing service by Customer Premises Equipment vary. Consult your local telecommunications service provider regarding compliance with applicable laws and regulations.

Understanding programming

When your system is installed, your installer or customer service representative programs it to work with your telephone lines, with your private network, if you have one, and with optional equipment. They customize the system for your office. All programming is recorded in the *Norstar Programming Record*.

You may want to further customize your system. For example, you can change how some features work, or adapt the system to changes in your office. Programming allows you to change settings that probably need to be updated regularly because of staff turnover or new business contacts. You can also assign features and program buttons on individual telephones.

There are four ways to customize and maintain your Norstar system:

- Initial programming is done for you by your installer or customer service representative. It deals mostly with how the system interacts with lines, telephones, and other equipment.
- Your programming as a system coordinator changes how features work for the system, as needed. It requires a system coordinator password.
- A basic programming password is available to allow individuals other than the system coordinator to make changes without giving access to sensitive programming capabilities.
- Personal programming is available to anyone through the Feature button on their Norstar telephone. It allows individuals to change how their telephone works to suit themselves.



Before you start

Before you begin programming, plan what changes you want to make. Record the changes in the *Norstar Programming Record* so that you have the information at hand. For example, if you are going to program system speed dial numbers, fill out the page in the *Norstar Programming Record* so that you have all the numbers and codes handy once you start programming.



What you'll need to do programming

Programming is done using a telephone that can show two lines of information on its display. Examples of telephones with two-line displays are shown on page 4.

You need a programming overlay to show which buttons to press when you are doing programming. See “The programming overlay” on page 6.

When you use a telephone for programming, it is taken out of service. This means it is unable to receive or make calls, and the call forward features do not work. Do not use the main reception telephone for programming because you may lose incoming calls.

Using Buttons

The two-line telephone you use for everyday calling is used for changes and maintenance. Examples of telephones with two-line displays are shown in the illustration.

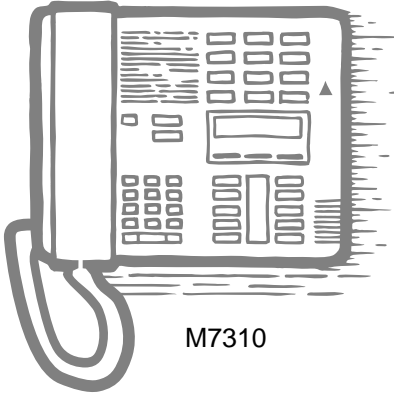

M7310

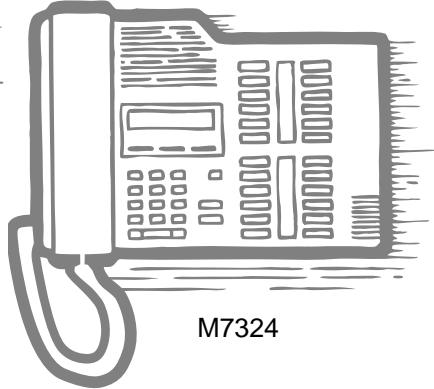

M7324

The next illustration numbers the buttons that are used for both day-to-day communication and programming on the M7310.

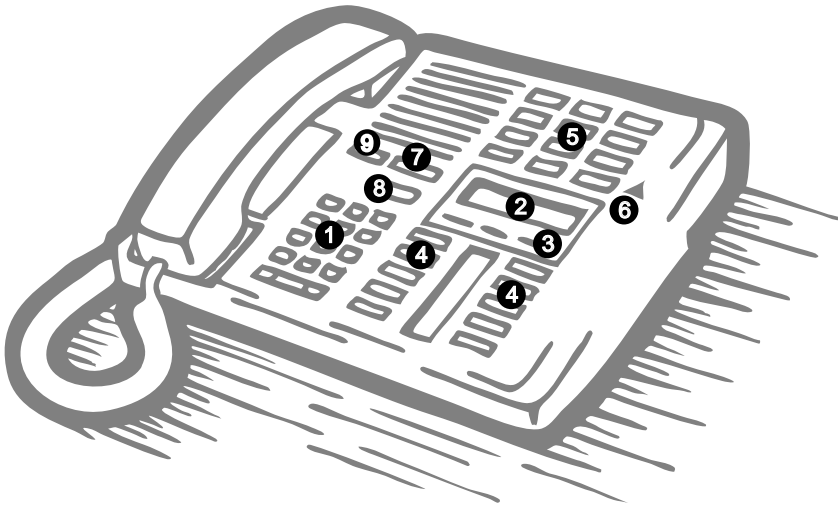

| | |
|-----------------------|--|
| ❶ Dial pad | Used for dialing numbers when you are making calls. It's also used for entering numbers and letters when you're programming. |
| ❷ Display | Shows instructions for everyday calling as well as for programming. |
| ❸ Display buttons | Have a variety of uses. The current use is shown on the display above each button. |
| ❹ Memory buttons | Dial a number or feature code stored on the button. |
| ❺ Dual memory buttons | Can store two numbers or feature codes (used with the shift button). |
| ❻ Shift button | Press the shift button before a dual memory button to activate the second number or feature code stored on a dual memory button. |
| ❼ Feature button | Allows you to enter a feature code while using or programming the telephone. |
| ❽ Hold button | Puts an active call on hold. |
| ❾ Release button | Hangs up an active call or ends programming. |

The M7324 is different from the M7310 in two ways: it does not have dual memory buttons (item 5) or a shift button (item 6).

Using the buttons under the display

The three display buttons are used both for telephone features and programming, but what each button does depends on what the display shows. Some display instructions that you may see when making changes on the system are OK, CHANGE or COPY. In this guide, display button instructions are underlined.

Display buttons

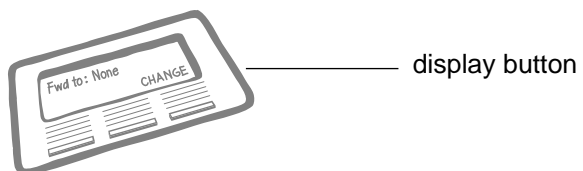

The programming overlay

When you begin programming, a group of buttons on the telephone become the buttons for moving through programming headings and settings. The programming overlay is a paper cutout (found at the back of this guide) that shows the directions the four buttons take you when programming.

Placing the programming overlay

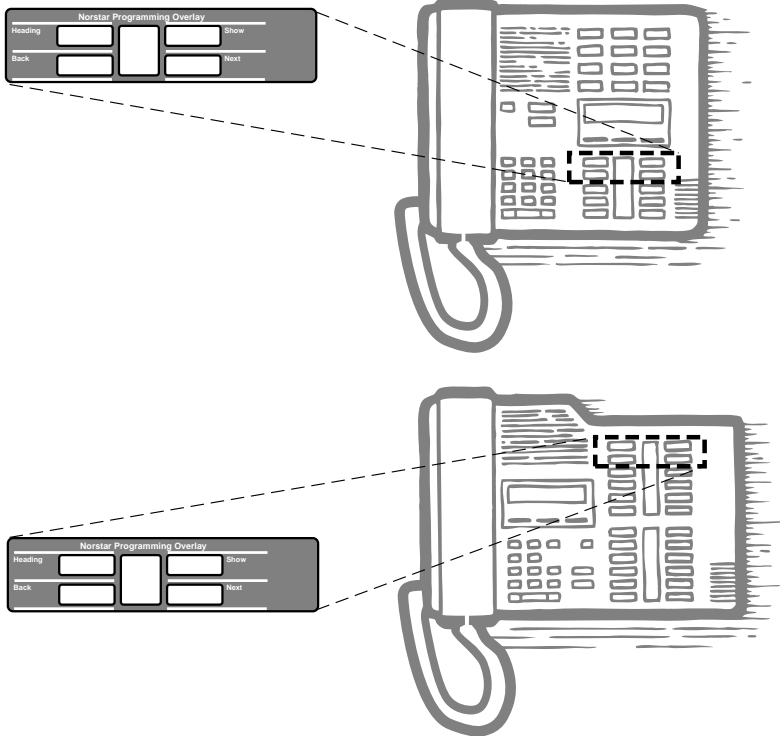

Shows you the heading for the current level

Moves you one item back at the current level



Shows you the first setting within the level

Moves you one item forward at the current level

Programming buttons are active or inactive at different stages of programming. A button is active (meaning you can use that option), when the indicator next to it is lit (◀ or ▶).



A map for working in programming

The programming maps on the following two pages show the headings you'll see when you move through the display menu after pressing `Feature` `*` `*` `C` `O` `N` `F` `I` `G` and entering the password (the default password is `A` `D` `M` `I` `N` or `2` `3` `6` `4` `6`). The maps show you the choices under each menu heading.

Another level of access is provided for special programming instances (the default password is `7` `2` `7` `5` `8` `7` or SCPLUS).

A Basic password can be used with a limited number of feature codes, including `*` `*` `T` `I` `M` `E` and the codes for turning call services on and off. For more information, see "Using passwords" on page 171.

Terminals#Sets

Terminals and sets - Customize the many features used by telephones. You can change where a call is forwarded, give a telephone a name, or allow certain features to be used at a telephone. You can change the button programming on any telephone on the system.

Lines

Lines - Program names for each line.

Services

Services - Turn services on or off. These are Ringing service, (often called night service) that allows additional telephones to ring, Restriction service that blocks certain kinds of calls and Routing Service that decides what lines a call uses.

Sys speed dial

System speed dial - Program up to 70 different telephone numbers so that people in your office can dial them with a two-digit code.

Passwords

Passwords - Change the password you use for programming, or erase a Call log password. On an XC system, you can also change the password for Companion portable telephone registration.

Time&Date

Time and date - Change the time, date, or both.

System prgrming

System programming - On an XC system, you can enable or disable registration for Companion portable telephones.

Key to Navigation:

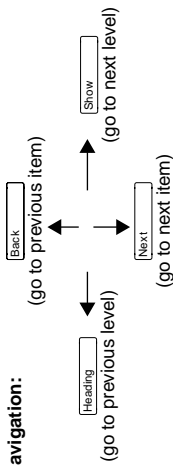

Legend:

Name (grey text) = appears only if needed to complete programming
 Enter *digits* (italic text) = instructions or descriptions
 (grey box) = enter an extension number, line number, or speed dial number
 (black box) = items are in a list

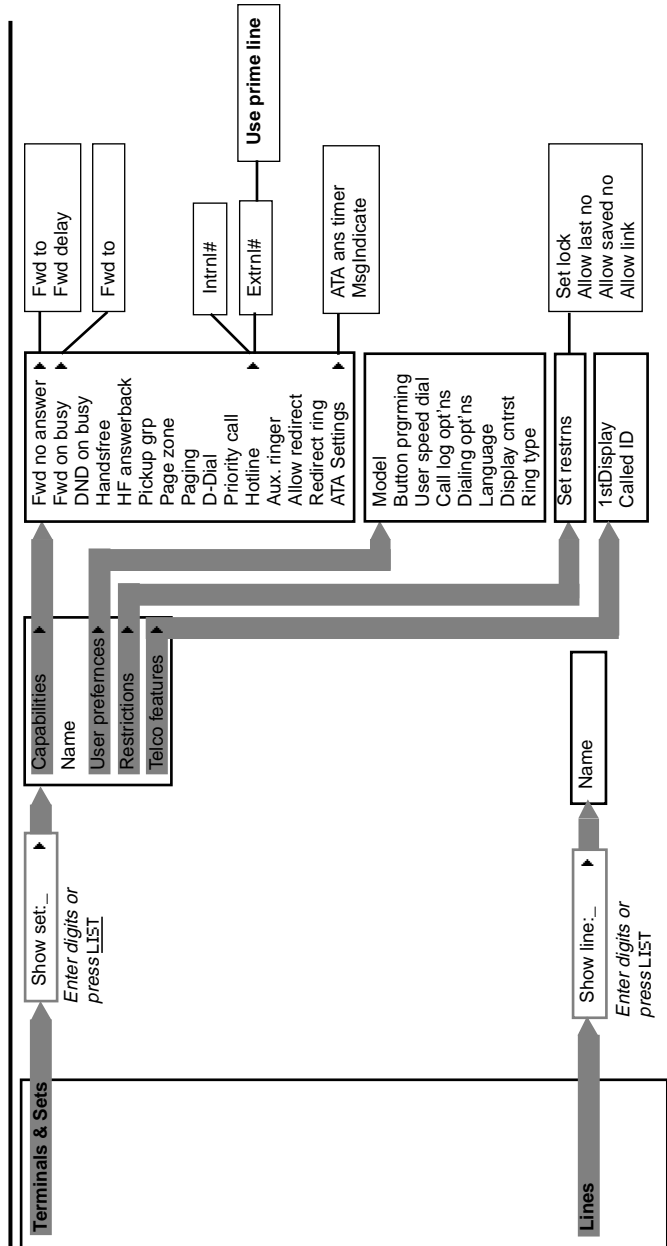

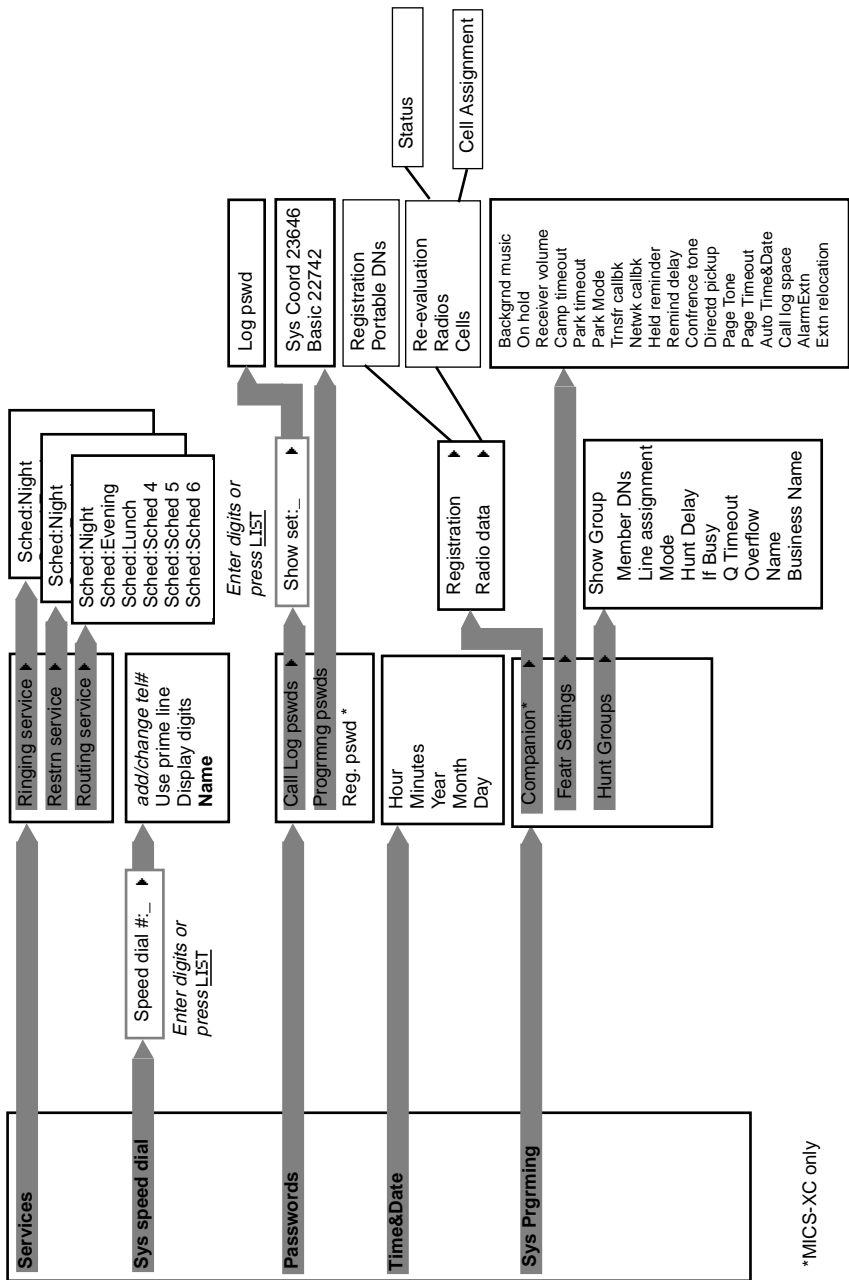

*MICS-XC only

Starting and ending a session

As system coordinator the first steps in making any change to the Norstar system are always the same.

Jan 1 12:00PM Press .

Feature: Press . It's the same as pressing .

Password: Press . Press **RETRY** to re-enter the password if it is entered wrong.

Terminals:Sets The display shows the first of the seven headings available for administration programming.

is the password, unless the password has been changed. Check the *Norstar Programming Record* for the most recent password.

Ending a session

Display digits:Y Press to end the session.

End of session After a few seconds, the time and date reappears on the display.

The system goes ahead with any changes you make to programming as soon as you move away from a setting, either by using the navigation buttons or .

You can see if the changes you have made to telephone programming have taken effect by pressing the UPDATE display key. The display shows you how many telephones have not been updated.

Press DN# to see the specific extensions where programming changes have not taken effect yet. Items disappear from the list as they are updated.

Record any changes you make in the *Norstar Programming Record*. If there is a problem with the system, the installer needs to see a history of the changes you have made. Remember to inform people in your office of any changes you have made that affect them. For example, you may change system speed dial codes or change the number of rings before an unanswered telephone is forwarded.

Frequently used programming operations

The following sections highlight the most frequently used programming operations. To consult these or other programming operations, see either the Table of Contents or the Index.

Changing the time and date on the display

Jan 1 12:00pm Press .

Feature: Press (which is the same as

Password: Press (B A S I C) or (A D M I N)

The passwords can be changed. See "Using passwords" on page 171 for more information.

Entering letters and numbers using the dial pad

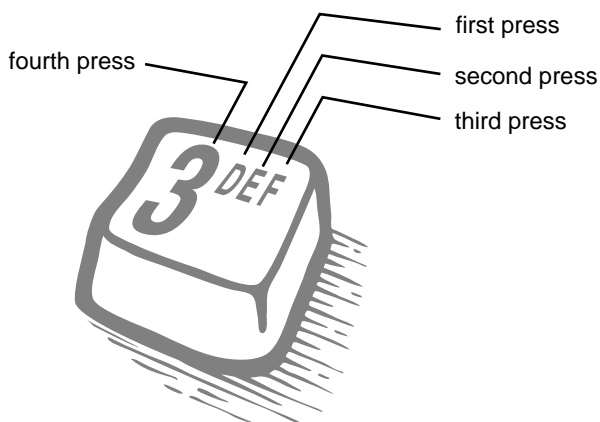

In this example, you are changing the time to 1:30 p.m.

Hour:01
NEXT CHANGE

Press CHANGE.

Hour:___
CANCL

Press the dial pad buttons to enter the hour. Use two digits for all hours. The clock on the display shows either one or two digits.

AM
OK CHANGE

The display prompts you to choose a.m. or p.m. Press CHANGE and OK to select p.m.

Hour:01
NEXT CHANGE

Press NEXT.

Minutes:00
NEXT CHANGE

Press CHANGE.

Minutes:___
CANCL

Press the dial pad buttons to enter the minutes.

If you are only changing the time and not the date, press to end your session.

In this example, you are changing the date to July 15, 1998.

Minutes:30
NEXT CHANGE

Press NEXT.

Year:97
NEXT CHANGE

Press CHANGE.

Year:___
CANCL

Press the dial pad buttons to enter the year.

Year:98
NEXT CHANGE

Press NEXT.

```
Month:01
NEXT      CHANGE
```

Press CHANGE.

```
Month:___
CANCL
```

Press the dial pad buttons to enter the month.

Use numbers for the months: 01 is January; 12 is December.

```
Month:07
NEXT      CHANGE
```

Press NEXT.

```
Day:01
NEXT      CHANGE
```

Press CHANGE.

```
Day:___
CANCL
```

Press the dial pad buttons to enter the day.

```
Day:15
CANCL
```

Press to end your session.

```
End of session
```

The clock controls the schedules used for services such as ringing and routing services.

After a power failure, the clock is behind by the length of time power was lost. For example, if the power is out for two minutes, the clock is two minutes behind.

You can program your Norstar system with the Automatic Time and Date feature to automatically update the time and date. Whenever the clock is out of sync by more than two minutes, as a result of a power failure or a loss of power, the first incoming call updates the clock automatically after two rings.

Note: CLASS Trunks are required for this feature to work. Consult your customer service representative to determine if you have CLASS Trunks.

This feature also allows the automatic changing between North American daylight savings and standard time. Your system uses the time and date information from the first incoming call after two rings to update to daylight savings or standard time.

The Automatic Time and Date feature automatically overrides any manually programmed changes to the time and date in your system.

Note: The year is not included with the time and date information and must be programmed manually if the current year differs from the network time.

Programming Automatic Time and Date

You can program the Automatic Time and Date feature to enable your system to automatically update the time and date after a power failure, and to automatically change between daylight savings and standard time.

Jan 1 12:00pm Press .

Feature: Press * * 2 6 6 3 4 4.

Password: Press 7 2 7 5 8 7.
RETRY

The passwords can be changed. See "Using passwords" on page 171 for more information.

Terminals:Sets▶

Press until the display shows System programming.

Sys programming▶

Press .

Change DNS▶

Press .

Featr settings▶

Press .

Background music:
CHANGE

Press until the display shows AutoTime:Date.

AutoTime:Date:
CHANGE

Press CHANGE to choose Y or N.

Adding or changing a system speed dial

You program a speed dial on your Norstar so that anyone in your office can dial a frequently used number using a two-digit code.

To change a speed dial that already exists, follow the same steps. The new programming overwrites the previous number and settings.

Begin the programming session

Jan 1 12:00PM

Press .

Feature:

Press .

Use Prime line
CHANGE

In this example, the system selects the prime line automatically (the most common choice), to dial speed dial code 01.

If you assign a specific line to a system speed dial number, only telephones with an appearance of that line can use the speed dial number.

Choose what shows up on the display

Use Prime line
CHANGE

Press .

Display digits:Y
CHANGE

Your choices are Yes and No. Yes means the display shows the telephone number. Press CHANGE.

Display digits:N
CHANGE

No means the display shows a name for the code.

Program a name for a speed dial

The system has a standard name to display, so it is not necessary for you to program one. However, if you have chosen not to display the telephone number, you may want a specific name.

Display digits:N
CHANGE

Press .

Name:Sys Spd Di...
CHANGE

Press .

...al 01 ...
CHANGE

This is the name the display shows if you don't change it. Press CHANGE.

Name:____
-->

Decide the name you want to give to the speed dial code.

Press the telephone's numeric dial pad button that has the first letter of the name until the display shows the letter you want.

Name:S
BKSP -->

Press -->.

Name:S_
<-- BKSP -->

Use the dial pad and **-->** until you have the entire name.

The name can be up to 16 characters long, including spaces.
Press # on the numeric dial pad to add spaces.

Name:SAVINGS BANK
<-- BKSP -->

Press **Next** .

Name:SAVINGS BA...
CLR CHANGE

Press **Rls** to end your session.

Or you can press **Heading** , then **Next** to program another speed dial number.

End of session

Changing the name of a telephone

Begin the programming session

Jan 1 12:00PM

Press **Feature** .

Feature:

Press *** * 2 6 6 3 4 4** .

Password:
RETRY

Press **2 3 6 4 6** .

Change the name of a telephone

Terminals*Sets▶

Press **Show** .

Show set:_
LIST

Enter the internal number (DN) of the telephone or voice mail extension. In this example, it's 221.

If the set has already been given a name, it appears after **DN:** on the display.

```
221:221▶
      FIND
```

Press then .

```
Name:221
      CHANGE
```

This is the name the display shows if you don't change it. Press CHANGE.

Decide what name you want to give to the telephone number.

```
Name:_
      -->
```

Press the telephone's numeric dial pad button that has the first letter of the name until the display shows the letter you want.

```
Name:J
      BKSP  -->
```

Press -->.

```
Name:J_
<--      BKSP  -->
```

Use the dial pad and --> until you have the entire name.

```
Name:JEAN B
<--      BKSP  -->
```

Press to use the name you have entered.

The name can be up to 7 characters long, including spaces.

```
Name:JEAN B
CLR      CHANGE
```

Press to end your session.

You can press once to continue programming this telephone, or press twice to return to the Terminals and Sets heading.

```
End of session
```

Changing the name of a line

Begin the programming session

Jan 1 12:00PM Press .

Feature: Press .

Password: Press .

Change the name of a line

Terminals:Sets▶ Press .

Lines▶ Press .

Show line:____ Enter the three-digit number of the line you want to
LIST name. In this example, it's line 002.

This is the name the display shows if you don't change it.

Line002:Line002▶ Press .

Name:Line002 Press CHANGE.
CHANGE

Decide what name you want to give to the line.

Name:____ Press the telephone's numeric dial pad button that
--> has the first letter of the name, until the display
shows the letter you want.

Name:L Press -->.
BKSP -->

Name:
 <-- BKSP -->

Use the dial pad and **-->** until you have the entire name.

The name can be up to 7 characters long, including spaces.

Name: LOCAL
 <-- BKSP -->

Press to use the name you have entered.

Name: LOCAL
 CLR CHANGE

Press to end your session.

You can press once to continue programming this line, or press twice to return to the Lines heading.

End of session

Making changes to Call Forward No Answer

Begin the programming session

Jan 1 12:00PM

Press .

Feature:

Press .

Password:
 RETRY

Press .

Change where a call goes when there is no answer

Terminals: Sets▶

Press .

Show set:
 LIST

Enter the internal number (DN) of the telephone or voice mail extension. In this example, it's 225.

If the set has been given a name, it appears on the display.



Tip - If the Norstar set is a member of a Hunt Group, the Call Forward no answer feature is overridden and the Hunt Group call continues to ring until the hunt time has expired. For more information on Hunt Groups see "Programming Hunt Groups" on page 135.

Making changes to Call Forward on Busy

Begin the programming session

Jan 1 12:00PM Press .

Feature: Press .

Password: Press .

RETRY

Change where a call goes when a telephone is busy

Terminals#Sets Press .

Show set: LIST Enter the internal number (intercom number) of the telephone extension. In this example, it's 225.

If the set has been given a name, it appears on the display.

225:225 Press .

FIND

Capabilities Press .

Fwd no answer Press .

Fwd on busy... Press .

Fwd to:None
CHANGE Press CHANGE and enter the internal number where you want the calls to be sent. In this example, it's 221.

You can press CLR to change the destination back to None.

Fwd to:221
CLR CHANGE Press to end your session.

You can press to continue programming capabilities for this telephone, or press three times to return to the Terminals and Sets heading.

End of session



Tip - *If the Norstar set is a member of a Hunt Group, the Call Forward on busy feature is overridden and the Hunt Group call continues to ring until the hunt time has expired. For more information on Hunt Groups see "Programming Hunt Groups" on page 135.*

Making Changes to Do Not Disturb on Busy

When you are on a call and a second call comes in, your telephone rings softly to alert you to the second call. You can turn this feature on or off for each telephone.

Begin the programming session

Jan 1 12:00PM Press .

Feature: Press .

Password: Press .
RETRY

Change Do Not Disturb on Busy

Terminals#Sets▶ Press .

Show set: _ LIST Enter the internal number (intercom number) of the telephone extension. In this example, it's 225.

If the set has been given a name, it appears on the display.

225:225 Press .
FIND

Capabilities▶ Press .

Fwd no answer▶ Press twice.

DND on Busy: N Press CHANGE to turn the feature on.
CHANGE

DND on Busy: Y A second press turns it off again. Press to end your session.
CHANGE

You can press to continue programming capabilities for this telephone, or press three times to return to the Terminals and Sets heading.

End of session



Tip - *If the Norstar set is a member of a Hunt Group and the set activates this feature, the set does not receive notification of incoming Hunt Group calls while on a call. The DND on busy feature overrides the Hunt Group. For more information on Hunt Groups see “Programming Hunt Groups” on page 135.*

For more information on Call Forward and similar settings, see “Forwarding your calls to another Norstar telephone” on page 83.



What would you like to do next?

Some of the most common programming tasks are listed below. For a comprehensive list of settings and instructions, see either the Table of Contents or the Index.

- | | |
|--|--|
| Redirect calls coming in on a line. | See “Turning on Line Redirection” on page 88. |
| Allow individuals to answer calls that are ringing at another telephone. | See “Picking up a call ringing at another telephone” on page 37. |
| Assign telephones to different zones for paging. | See “Paging” on page 95. |
| Turn the night service on and off. | See “Making additional telephones ring” on page 165. |
| Use a basic password so others can take care of programming such as changing user speed dials, changing names, and changing the time and date. | See “Using passwords” on page 171. |

Answering calls

Answering incoming calls with Hunt Groups

Your Norstar system now allows you to establish Hunt Groups in your system. Hunt Groups are a group of Norstar set DNs that can be called by a single directory number. The Hunt Groups feature ensures calls are easily routed to the appropriate people. You can program

- the members for a Hunt Group
- member position within a Hunt Group
- how calls are distributed
- how long a call spends looking for available members
- what happens if all members are busy

For more information on Hunt Groups see “Programming Hunt Groups” on page 135.

Answering an incoming call

There are three indications of an incoming call: ringing, a line button flashing, and a message on the display. You do not necessarily receive all three indications for any particular call. For example, you may have a line that has been set up not to ring at your telephone. If so, you see only a flashing line button. There are many possible combinations, depending on how your system is set up. See “Choosing a line using a line button” on page 55 for more information on the use of lines.

If you receive a priority call and your telephone has no free internal line buttons, you cannot transfer the priority call, you must accept or release it.

Line buttons

One line button for each line is assigned to your telephone. Press the line button to select the line you want to answer or use to make a call. Having several line buttons gives you immediate access to more than one line.

The M7100 telephone has two intercom paths which are used instead of line buttons to answer and make calls. Each M7100 can be assigned two lines. You can press to switch between two calls, one active and one on hold.

What line indicators mean

- | | |
|---|---|
| ▶ Flashing on and off for equal lengths of time | There is an incoming call on the line. |
| ▶ Flashing on and off more quickly | You have placed a call on hold. |
| ▶ Flashing on for longer than off | Someone else has put a call on hold on that line. |
| ▶ On, not flashing | You are connected to the call on that line or the line is in use elsewhere. |
| Off | The line is free. |

Rings you may hear

- | | |
|---------------------------------|--|
| A double beep every ten seconds | A call has been camped to your telephone. |
| A long single ring | There is an external call on the line for you. |
| A shorter double ring | There is an internal call on the line for you or a call is being transferred to you. |
| A brief single ring | A call is being redirected on one of your redirected lines. You cannot answer this call. |
| Three beeps descending in tone | You are receiving a priority call. |

Answering calls at a prime telephone

Each line in a Norstar system can be assigned a prime telephone. Calls not answered at their normal destinations are transferred to the prime telephone. The prime telephone is usually the attendant's telephone. The installer or customer service representative programs a prime telephone for a line.

Displays

DND from 221

The person at telephone 221 has forwarded a call to you using Do Not Disturb.

DND transfer

The system has transferred a call to you from a telephone with Do Not Disturb turned on.

DRT Line001

Nobody answered this call so the system transferred it to you.

Line001 callback
CALLBACK

Someone has camped, parked or transferred a call on line 001, but no one has answered it. Press **CALLBACK** or the line button to connect to the call.

Line001 to prime

There is no telephone that can receive a call on line 001 so the system has transferred it to you.

Line002>Line052

The call coming in on line 002 was intended for target line 052. Line 052 is busy so the call has come to you.

For other displays, see "Common feature displays" on page 203.

Using a central answering position (CAP) module

A central answering position (CAP) is a Norstar M7324 telephone and a CAP module that your installer or customer service representative programmed as a CAP. You can have five CAPs in a Norstar Modular system. It is best if the CAP is the prime telephone and direct-dial telephone for the lines and telephones it serves.

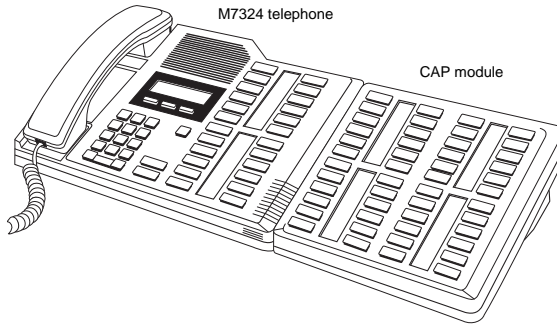

A CAP module is an add-on device that provides 48 extra memory or line buttons. You can connect one or two Norstar CAP modules to the telephone to increase the number of lines it can handle.

When a CAP module is first plugged into your telephone, some of the module buttons are already programmed to dial an internal number.

Customizing your CAP module

If your installer has programmed the CAP module to be the central answering position for your system, you can move external lines onto the CAP module by using

* 8 1 . See “Moving line buttons” on page 124.

Any of the buttons on your CAP module that do not select lines can be programmed to dial internal or external numbers automatically. You can program features onto CAP module buttons. See “Time savers for making calls” on page 63 and “Customizing your telephone” on page 115 for information on programming memory buttons.

Buttons on a CAP module cannot be assigned as answer buttons.

Monitoring telephones with the CAP module

The indicators  beside internal autodial buttons on your CAP module show the status of Norstar telephones.

The indicator is on when the telephone has:

- an active call
- Do Not Disturb turned on



The indicator is off when a telephone has:

- no active call
- a call on hold and no other active call



Tip - You can send up to 30 messages from a CAP.

Release button

Pressing  ends a call. You do not have to put the receiver down.  also ends feature programming.

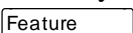
While you are on a call, do not press  to end a feature you are using. If you do, you disconnect the call. Use  instead.

Hearing aid compatibility

The receivers on all Norstar telephones are compatible with hearing aids as defined in the FCC rules, Part 68, section 68.316. Not all hearing aids are optimized for use with a telephone.

Viewing information about a call on the display

If you subscribe to Call Display services from your local telephone company, one line of information about an external caller is displayed after you answer. Depending on the setting and the external information available, either the caller's name or telephone number is displayed.

When you transfer an external call to another Norstar user, this information is displayed on the recipient's telephone.

Call Display information becomes available between the first and second ring of an incoming call. If you answer before the Call Display information is available on your display, and you press , you see only the line number or line name.

To use logging features with Call Display, see "Using Call Log" on page 107.

Using Call Information for a particular call

Call Information allows you to see information about incoming calls. This information is more detailed than the Call Display information you can receive automatically. For external calls, you can display the caller's name, telephone number, and the line name. For an internal call, you can display the caller's name and their internal number. You can see information for ringing, answered, or held calls.

Call Information is available for calls even if they have been transferred, forwarded or rerouted in some way.

Names and numbers for external calls are displayed only if you have subscribed to Call Display services from your telephone company.



Tip - Call Log displays the same information as Call Information, along with the date and time of the call, and the number of times the caller called.

Displaying Call Information before or after answering

To find out who is calling or to display information about your current call:

1. Press .
2. Press or VIEW to display more information about an external call.

Call Display information becomes available between the first and second ring of an incoming call. If you answer before the Call Display information is available on your display, and you press , you see only the line number or line name.

Displaying Call Information for a call on hold

1. Press . The display reads **Select a call**.
2. Select the line on hold. Information about the call is displayed.
3. Press or VIEW to display more information about an external call.



Tip - If your telephone automatically displays Call Display information for a call, you still need to press before you can press or VIEW to display more information about the call.

Making Call Display information appear automatically at a telephone

Each telephone that rings for an external line can display Call Display information for that line. After the call is answered, Call Display information is always shown at the telephone that answered the call. Your installer or customer service representative can program telephones to have automatic Call Display.

This feature is not available to ISDN terminals.

Changing which information is shown first about a call

Depending on the services you subscribe to, Call Display information may contain up to three parts: the name of the caller, the number of the caller, and the name of the line in your Norstar system that the call is on. For each telephone, you can determine which information is displayed first.

You need the programming template found at the front of this guide. See “Getting started with Norstar” on page 1 for more information.

1. Press * * 2 6 6 3 4 4 .
2. Press 2 3 6 4 6 (the default System Coordinator password).
3. Press and enter the internal number of the telephone you want to program.
4. Press .
5. Press four times.
6. Press .
7. Choose a setting at **1stDisplay:** using the **CHANGE** button. The choices are **Name**, **Numbr** or **Line**.

You may see **Unknown name** or **Unknown number** on the display if the information is not available from your telephone company. You may see **Private name** or **Private number** on the display if the caller blocks that information.

Picking up a call ringing at another telephone

You can pick up a call ringing at another telephone by using Directed Pickup or Group Pickup.

Answering any ringing telephone using Directed Pickup

Feature

You can answer any telephone that is ringing in your Norstar system.

1. Press .

2. Enter the internal number of the ringing telephone.

Call Pickup cannot be used to answer private lines.

To use Call Pickup (Directed Pickup), the telephone must be ringing. If, for example, the auxiliary ringer is ringing, but the call is not ringing at a telephone, the call cannot be answered using Directed Pickup. It must be answered normally at a telephone that has a flashing indicator for the call, or by using Trunk Answer. You can answer a call that is ringing because someone has transferred the call to a telephone and the call is ringing on an intercom button.



Tip - Directed pickup can retrieve calls that are ringing on an Answer DN. While you may enter the internal number of the telephone you hear ringing, it may be calls from another telephone you are answering.

Answering any ringing telephone using Group Pickup

Feature 7 5

Your Norstar system can be divided into nine pickup groups. If you are a member of a pickup group, you can pick up a call that is ringing at any telephone in your pickup group.

Press Feature 7 5 .

Group Pickup cannot be used to retrieve a camped call.

If there is more than one incoming call at a telephone in a pickup group, a call ringing on an external line is answered first followed by calls on the prime line and, finally, calls on internal lines.



Tip - A Hunt Group call ringing at a Norstar set DN that is also a member of a call pickup group can be picked up by any Norstar set in that call pickup group. For more information on Hunt Groups see "Programming Hunt Groups" on page 135.

Changing a telephone's pickup group

Telephones can be put into and taken out of pickup groups.

You need the programming template found at the front of this guide. See "Getting started with Norstar" on page 1 for more information.

1. Press Feature * * 2 6 6 3 4 4 .
2. Press 2 3 6 4 6 (the default System Coordinator password).
3. Press Show and enter the internal number of the telephone you want to program.
4. Press Show twice.

5. Press five times.
6. Press **CHANGE** at **Pickup grp:** to assign the telephone to pickup group 1, 2, 3, or 4, 5, 6, 7, 8, 9, or to **None**.

Displays

Already joined

You are already connected to the telephone that made the call you are trying to pick up. This can happen if you are on a call to a co-worker, your co-worker dials the number of a telephone in your pickup group, and you attempt to pick up that call.

Pickup denied

There is no call that you can pick up or the call that was ringing has already been answered.

You have tried to pick up a call on someone else's private line.

Pickup:

Enter the internal number of the telephone that is ringing. (You may use an internal autodial button to do this.)

If you decide not to answer a ringing call after you have activated Directed Pickup, press

.

Trunk Answer

The Trunk Answer feature allows you to answer a ringing call anywhere in the system from any telephone in the system. The line you are answering does not have to appear or ring at the telephone you are using.

Trunk Answer works only with calls that are ringing on lines for which a Ringing Service schedule is active and if Trunk Answer is enabled by your installer or customer service representative.

Answering a call using Trunk Answer

Press .



Tip - *If there is more than one incoming call on lines in a Ringing Service, the Trunk Answer feature picks up the external call that has been ringing the longest.*

Displays

You have tried to pick up a call on someone else's private line.

The call that is ringing is on a line that is not in a Ringing Service.

Answer buttons

You can use an Answer button to monitor calls on another person's telephone. All calls to the monitored Norstar telephone appear on the Answer button.

Answer buttons are useful for attendants who monitor incoming calls for one or several other people. For example, a secretary may have appearances for three different bosses on her answer buttons. Once a call for boss A is answered by the secretary, the appearance stops at that boss' set. This allows for another (simultaneous) call to come in on the same line. The same is true for boss B and boss C. When incoming call traffic becomes high, the calls can then be routed to a Hunt Group to optimize call handling. For more information on Hunt Groups see "Programming Hunt Groups" on page 135.

The Answer button setting in Featr settings programming allows you to determine what types of calls alert at the telephone. Your choices are: Basic, Enhanced and Extended.

See the *Norstar Modular ICS 4.0 Installer Guide* for more information.

M7100N telephones and ISDN terminals cannot be assigned Answer buttons to monitor other sets, but they can be monitored.

You cannot make calls using Answer buttons.

If more than one call is ringing at someone's telephone, the first call appears on the attendant's Answer button. Any subsequent calls appear on intercom buttons, if they are available.



Tip - *More than one attendant may have an Answer button for a single telephone. This allows two or more attendants to handle calls for a busy person.*

Each telephone can handle calls for up to eight other people using a separate Answer button for each person.

Creating a Conference Call

Feature

You can talk to two people at once.

1. Make sure you have two calls, one active and one on hold.
2. Press .
3. Press the appropriate button to retrieve the held call (this is automatic on the M7100 telephone).

You can create a conference when you are on a call.

1. Make a second call.
2. Press .

3. Press the button where the first call is on hold to create a conference.

Only the person who established the conference can process the conference by using the procedures described in this section.



Tip - You can create a conference by releasing privacy on a call. See "Turning Privacy on or off for a call" on page 49.

Disconnecting one party

You can disconnect one party from a conference and continue talking to the other.

On an M7208, M7310 or M7324 telephone:

1. Press the line button of the call that you want to disconnect. The call that you want to keep is automatically put on hold.
2. Press . The call is disconnected.
3. Press the line button of the held call to speak to the remaining person.

On an M7100 telephone:

1. Press , to place one caller on hold. Press again, to put the caller you want to keep on hold.
2. Press . The call is disconnected.
3. Press to speak to the remaining party.

Independently holding two calls

For all Norstar telephones except the M7100 telephone, you can put the two people in a conference call on hold independently so that they cannot talk to each other.

1. Press the line button of one person. The other person is automatically put on hold.
2. Press . The second person is put on hold.

You can re-establish the conference.

1. Take one call off hold.
2. Press .
3. Take the other call off hold.

Putting a conference on hold

You can put a conference on hold, allowing the other two people to continue speaking to each other by pressing .

You can reconnect to the conference by pressing either of the held line buttons. For the M7100 telephone, press .

Splitting a conference

You can talk with one person while the other person is on hold.

On an M7208, M7310 or M7324 telephone

Press the line button of the person you want to speak to.
The other person is automatically put on hold.

On an M7100 telephone:

1. Press . The first party is on hold.
2. Press , if necessary, to switch parties.

You can re-establish the conference.

1. Press .

2. Take the held call off hold. This is not necessary for the M7100 telephone.

Removing yourself from a conference

Feature

You can remove yourself from a conference, and connect the other two callers through your Norstar system.

Enter the Transfer feature code .

When you remove yourself from a conference using the Transfer feature, and both callers are from outside your system, one of the callers must have called you on a disconnect supervised line, or the call is be disconnected.

Displays

3 Parties only

You are trying to add a fourth party to your conference call, or to join two conferences together. Release one call from the conference before adding another, or keep the two conferences separate.

Conf. on hold

You have put a conference call on hold.

Conference busy

You have tried to make a conference call, but your system is already handling its maximum number of conference calls.

Line001 221
TRANSFER

You are on a conference with the two lines or telephones shown. You can drop out of the conference and leave the other two parties connected (Unsupervised Conference) by pressing TRANSFER or entering the Transfer feature code.

Press held line

You have activated the Conference feature with one call active and another on hold. Press the line of the call on hold to bring that person into the conference.

For other displays, see "Common feature displays" on page 203.

Listening to a call as a group

Feature 8 0 2

To allow people in your office to listen in on a call using Group Listening, press Feature 8 0 2.

You hear the caller's voice through your telephone's speaker. Continue to speak to the caller through the telephone receiver. Your telephone's microphone is off, so the caller does not hear people in your office.

Canceling Group Listening

Feature # 8 0 2

Group Listening is canceled automatically when you hang up or when you press Feature # 8 0 2.



Tip - Keep the receiver away from the speaker, or you may hear feedback. The higher the volume, the more the feedback. Press Rls to prevent feedback when hanging up.

Using Handsfree/Mute

The ability to use Handsfree must be turned on or off for each telephone. The type of Handsfree can be changed. See “Changing Handsfree for a telephone” on page 47.

You must turn on Handsfree for a telephone to be able to use a headset.

Answering calls without lifting the receiver

1. Press the line button for the ringing call. (This step is not necessary if you have a prime line assigned to your telephone.)

2. Press . The telephone's internal microphone and speaker are automatically turned on.

Handsfree is not available for an M7100 telephone.



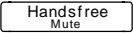

Tip - *Direct your voice toward the telephone. The closer you are to the telephone, the easier it is for the microphone to transmit your voice clearly to your listener.*

Making calls without lifting the receiver

1. Press . (If you don't have a prime line assigned to your telephone, press a line button.)
The telephone's internal microphone and speaker are automatically turned on.
2. Dial your call.
3. Speak normally.

Muting Handsfree

1. Press  to switch off the telephone microphone so that you can speak privately to someone in your office while you are on a handsfree call.
2. Press  to turn the microphone back on again and continue your handsfree call.

Changing a regular call to handsfree

1. Press .
2. Hang up the receiver.

Changing a handsfree to a regular call

Lift the receiver.

Using Handsfree

The indicator next to  is solid when you have Handsfree turned on. It flashes when you mute the microphone.

Wait for your caller to finish speaking before you speak. The microphone and speaker cannot both be on at once. Your caller's voice may be cut off if you both speak at the same time. Noises such as a tapping pencil could be loud enough to turn on your microphone and cut off your caller's speech.

To prevent a possible echo, keep the area around your telephone free of paper and other objects that might screen your microphone. Turning down the microphone's volume (press the left end of ) while speaking) prevents echoes. When you change the volume level, both the microphone and speaker volume are adjusted to prevent feedback problems.

Place the telephone so that any unavoidable local noise (such as an air conditioner) is behind it. This limits the amount of disruptive background noise.



Tip - *In open-concept environments, use the receiver when handsfree communication is not necessary or when you need privacy during a call. Another option is to use a headset.*

Changing Handsfree for a telephone

You can program the type of Handsfree used with each telephone or activate Handsfree Answerback.

You need the programming template found at the front of this guide. See "Getting started with Norstar" on page 1 for more information.

1. Press * * 2 6 6 3 4 4 .
2. Press (the default System Coordinator password).
3. Press and enter the internal number of the telephone you want to program.
4. Press twice.
5. Press three times.
6. Choose a setting at **Handsfree:** using the CHANGE button.

There are three ways to set Handsfree for an individual telephone:

Handsfree:None
CHANGE

Handsfree is not available to the telephone.

Handsfree:Auto
CHANGE

You can make or answer a call without having to pick up the receiver or press . The telephone's internal microphone and speaker turn on automatically when you press a line or intercom button to make or answer a call.

Handsfree:Std
CHANGE

A standard version of Handsfree described "Using Handsfree/Mute" on page 45.

For other displays, see "Common feature displays" on page 203.

Both Auto and standard Handsfree allow you to use a headset with a Norstar telephone.

A Handsfree/Mute button is automatically assigned to a telephone that is programmed with Handsfree and is always located in the lower right-hand corner of the telephone.

Handsfree Answerback

Handsfree Answerback allows you to answer a voice call without lifting the receiver. It is always turned off for an M7100 telephone.

You can turn Handsfree Answerback on or off for a telephone that is programmed to use Handsfree.

You need the programming template found at the front of this guide. See “Getting started with Norstar” on page 1 for more information.

1. Press * * 2 6 6 3 4 4 .
2. Press (the default System Coordinator password).
3. Press and enter the internal number of the telephone you want to program.
4. Press twice.
5. Press four times.
6. Choose a setting (Yes or No) at **HF answerback:** using the **CHANGE** button.

Turning Privacy on or off for a call

Lines in your system can be configured to have automatic privacy. If a line is not programmed with privacy, anyone with the line assigned to their telephone can join your call by pressing the line button. If a line is programmed with privacy, only one person at a time can use the line.

Privacy control cannot be used on internal or conference calls.

When another telephone joins a call, the participants on the call hear a tone, and a message appears on the Norstar display. You cannot join a call without this tone being heard.

Creating a conference by releasing privacy

If a line is programmed with privacy, you can turn privacy off to allow another person with the same line to join in your conversation and form a conference. All the rules applicable to a conference apply except there is only one line in use, instead of the normal two. This means that you cannot split a conference set up using Privacy.

1. Press .
2. Tell the other person to press the line button and join your conversation.

Only two Norstar telephones in addition to the external caller can take part in this kind of conference.

Making a call private

If a line is programmed not to have privacy, you can turn privacy on for a call, preventing other people with the same line from joining your conversation.

Press .

Checking call length using Call Duration Timer

By pressing , you can see how long you spent on your last call, or how long you have been on your present call.

Displays

221 02:47

The display shows the last call you made, or the current call, and the total elapsed time in minutes and seconds.

Line001 01:45

You parked your last call. The display shows the length of time the call was parked. You cannot see the length of time a call was parked unless the call is active at your telephone or has just been released by your telephone.

Disconnecting by accident

If you accidentally drop the receiver back into the telephone cradle while answering a call, you can quickly retrieve the call.



Pick up the receiver again or press within one second to be reconnected to your call.

Time

Press to display the current date and time while you are on a call.

Making calls

There are many ways to make a call, depending on the programming and the type of call, as follows:

- Pick up the receiver and dial. The Norstar system supports three methods of dialing. See “Changing how you dial your calls” on page 57.
- Pick up the receiver, press a line button, and dial (if the call is not on your prime line).
- Press  and dial (to talk without using the receiver). See “Using Handsfree/Mute” on page 45.
- Press , press a line button, and dial (to talk without the receiver and if the call is not on your prime line).
- Press a line button and dial (to talk without the receiver and if Automatic Handsfree is assigned to your telephone).
- Use one of the features that make dialing easier. See “Time savers for making calls” on page 63.

Displays

221 busy
PRIORITY LATER

The telephone you have called has no internal lines available. Press LATER to use the Ring Again or Message features or press PRIORITY to make a priority call.

9_
QUIT BKSP

You are dialing using Pre-dial. To erase an incorrect digit, press the left end of  or BKSP. When the number is complete, select a line or lift the receiver.

95551234
TRANSFER

This prompt remains on your display as long as you are on a call you have dialed. To transfer the call, press TRANSFER.

| | |
|---------------------------------------|---|
| Already joined | Your telephone is already connected to the telephone you are trying to call. Check your active line buttons, and return to that call. |
| Calling 221 PRIORITY LATER | Wait for the telephone to be answered. If no one answers, press <u>LATER</u> to use the Ring Again (page 60) or Message (page 98) feature, or press <u>PRIORITY</u> to make a priority call. |
| Can't ring again | You cannot use Ring Again on your current call. You can only use Ring Again while you have a busy signal on an internal call or line pool request or while an internal call is ringing. |
| Do not disturb PRIORITY LATER | The telephone you are calling has Do Not Disturb turned on. Press <u>LATER</u> to use the Ring Again or Messages features, or press <u>PRIORITY</u> to make a priority call. |
| Expensive route | You have dialed a number, but the least expensive route that the system is programmed to use is busy. Unless you release the call, it goes through on a more expensive route. |
| Hidden number | The last number you dialed or the number you saved for Saved Number Redial was a speed dial number that displayed a name rather than the number. The number is dialed correctly, but you cannot see it. |
| Line denied | You have attempted to use someone else's private line. |
| Line001 TRANSFER | Enter the digits of the number you want to dial. |
| No last number | You have not dialed an external telephone number since the last power interruption or system reset. |
| No line selected | Either you have no prime line or your prime line is busy. Select a line manually before dialing. |

Not in service

You have entered the number of a telephone that is not in service.

On another call
LATER

The telephone you have called is on another call. Press LATER to use the Ring Again or Message features.

Restricted call

The call you are trying to make has been restricted in programming. A possible reason is time-of-day restrictions on certain calls.

Ring Again?
YES NO EXIT

Press YES to use Ring Again. Press NO to send a message. See "Sending messages" on page 98 and "Turning on Ring Again" on page 61.

Select a line

Either you have no prime line, or the prime line is in use, or the line programmed for an autodial number, speed dial number, or Hotline is in use. Select a line and dial again.

Send message?
YES NO

Press YES to send a message. See Messages.

For other displays, see "Common feature displays" on page 203.

Choosing a line using a line button

You have one line button for each line assigned to your telephone. Press the line button to select the line you want to answer or use to make a call. Having several line buttons allows you immediate access to more than one line.

The M7100 telephone has two intercom paths which are used instead of line buttons to answer and make calls. Each M7100 can be assigned two lines. You can press to switch between two calls, one active and one on hold.

Line pools

A line pool is a group of external lines that can be shared by many telephones. You can use a line in a line pool to make an external call.

The Norstar Modular ICS system can have 15 line pools, and a telephone can be programmed to access any number of them.

A line pool access code is a number you dial to get a line pool. The access code can be up to four digits long. You can have several different line pools for your system, each one giving you access to a different set of external lines. It is one way of sharing lines across telephones in a system.

Your installer or customer service representative programs the line pool access codes and gives each telephone access to a line pool.

Everyone in the office should have a list of the line pool access codes for the line pools their telephones can use.

Using a line pool to make a call

Feature

1. Press .
2. Enter a line pool access code.

If you have a free internal line, you can make a call using a line pool without entering the feature code first.

1. Select an internal line (intercom).
2. Dial the line pool access code.



Tip - If no lines are available in the line pool, you can use *Ring Again* at the busy tone. You are notified when a line in the line pool becomes available. See “Using Ring Again” on page 60.

Programming a memory button with a line pool feature code

When you program a button with the line pool feature code, you must enter a line pool access code after the feature code.

The programmed line pool button accesses a specific line pool, not the line pool feature. See “Programming feature buttons” on page 117 for more information.

If you program a button with an indicator to access a line pool, when all the lines in a line pool are busy, the indicator for the line pool button turns on. The indicator turns off when a line becomes available.

Making calls from an ISDN terminal

ISDN terminals do not have line keys or intercom keys as do Norstar telephones. To make an outgoing call from an ISDN terminal, access an external line by entering a line pool code or by using the ARS feature.

Changing how you dial your calls

Feature * 8 2

1. Press * .
2. Press or **NEXT** until the dialing mode you want appears.
3. Press or **OK** to select the displayed dialing mode.

The dialing modes feature code cannot be programmed onto a memory button.

Using Standard dial

Standard dial allows you to make a call by selecting a line and dialing the number. If you have a prime line, it is selected automatically when you lift the receiver or press .

You cannot use Standard dial on an M7100 telephone unless you pick up the receiver first. If you have an M7100 telephone, use the Automatic dial or Pre-dial feature for on-hook dialing.

Using Automatic dial

Automatic dial allows you to dial a number without selecting a line. Your prime line is selected as soon as you start dialing a number.

Automatic dial does not work if your telephone has no prime line or if your prime line is in use.

Telephones connected to an analog terminal adapter (ATA) cannot use Automatic dial.

Using Pre-dial

Pre-dial allows you to enter a telephone number, check it, then change it before actually making the call. The call is not dialed until you select a line or line pool, or pick up the receiver. You can pre-dial both external and internal numbers. You must, however, select the correct type of line (external or internal) for the type of number you have entered.



Tip - If your telephone starts ringing while you are pre-dialing a number, you can stop the ringing by turning on Do Not Disturb (Feature). This does not affect numbers you are entering.

You cannot pre-dial a telephone number if all the lines on your telephone are busy.

When the internal number you have called is busy

Priority Call

Feature

If you get a busy signal or a Do Not Disturb message when you call someone in your office, you can interrupt them. Use this feature for urgent calls only.



Tip - Priority calls cannot be made to Hunt Group DNs. For more information on Hunt Groups see “Programming Hunt Groups” on page 135.

Making a priority call

1. Press .
2. Wait for a connection, then speak.

A person who receives a priority call while on another call has eight seconds to accept or block the call. For information on blocking calls see “Stopping calls” on page 150. If the person does nothing, the priority call feature puts their active call, including conference parties, on Exclusive Hold and connects your call.

Giving a telephone the ability to make priority calls

You need the programming template found at the front of this guide. See “Getting started with Norstar” on page 1 for more information.

1. Press * * .
2. Press (the default System Coordinator password).
3. Press and enter the internal number of the telephone you want to program.
4. Press twice.
5. Press nine times. The display shows **Priority call:**
6. Press **CHANGE** to choose **Y** (Yes) or **N** (No)

Displays

Call blocked

You tried to place a priority call to another Norstar telephone. The person you called has blocked your call. Try to call later.

Please wait

The party you are calling has eight seconds to decide whether to accept or reject your priority call.

Priority denied

The telephone you are calling has already received a priority call or is unable to receive priority calls.

You can make a priority call only while your telephone displays:

221 busy
PRIORITY LATER

Calling 221
PRIORITY LATER

Do not disturb
PRIORITY LATER

On another call
PRIORITY LATER

Using Ring Again

Feature 2

Use Ring Again when you call someone on your Norstar system and their telephone is busy or there is no answer. Ring Again can tell you when they hang up or next use their telephone. You can use Ring Again to tell you when a busy line pool becomes available.



Tip - The Ring Again feature cannot be used when calling a Hunt Group DN. For more information on Hunt Groups see "Programming Hunt Groups" on page 135

Turning on Ring Again

Feature 2

Press Feature 2 before you hang up.

Using Ring Again cancels any previous Ring Again requests at your telephone.

Canceling Ring Again

Feature # 2

Press Feature # 2 to cancel a Ring Again request.

Displays

Can't ring again

You cannot use Ring Again on your current call. You can only use Ring Again while you have a busy signal on an internal call or line pool request, or while an internal call is ringing.

Ring Again?
YES NO EXIT

Press YES to use Ring Again. Press NO if you prefer to send a message.

Time savers for making calls

Storing a number on a memory button for Autodial

You can program memory buttons for one-touch dialing of internal or external telephone numbers.

Buttons used for lines, answer or Handsfree/Mute cannot be used as autodial buttons.

If the power to your Norstar system is off for more than three days, autodial numbers (as well as some other system programming) may be lost from the memory.

Adding an autodial button

* or *

1. Press * to program an external number or * for an internal number.
2. Choose a button and then enter the number as if you were dialing it.

When programming Autodial you can use:

- Last Number Redial
- Saved Number Redial
- destination codes (choose as the line)
- host system signalling

Choosing a line for Autodial

To include a line selection for an external number, press the line or intercom button before you enter the number. To select a line pool, press a programmed line pool button, or press and enter a line pool access code.

If you select a line before pressing the autodial button, the call goes out on the line you have selected instead of the line that is part of the autodialer programming.

For the M7100 telephone, an external autodialer can be programmed only by using a line and not a line pool.



Tip - If you do not include a line selection in an autodial number, the call uses your prime line (if you have one).

Using intercom as the line for Autodial

If you press as the line for an external autodial number, you must include a valid line pool access code or a destination code. If line pool access codes or destination codes are changed, remember to reprogram autodial numbers.

Displays

```
987_
QUIT  BKSP  OK
```

Continue to enter digits until the number is complete. Press or or BKSP to erase an incorrect digit. Press or OK when you are finished.

```
Autodial full
```

The memory allotted to autodial numbers in your Norstar system is full.

```
Button erased
```

While programming external Autodial, you erased the button by pressing or OK before entering any digits.

```
Enter digits
QUIT          OK
```

Enter the number you want to program (choosing the line first if necessary) exactly as if you were making a call.

```
Intercom #: _
QUIT
```

Enter the internal telephone number you want to program.

Invalid number

You are programming an internal autodial button and have entered a number that is not an internal number on your system. Enter a valid internal number. If the number you are entering is a destination code, use external autodial.

**Press a button
QUIT**

Press the memory button you want to program.

Program and HOLD

Enter the number you want to program onto the button, then press .

**Program and OK
QUIT OK**

Enter the number you want to program onto the button, then press or **OK**. You may include a line or line pool selection in an autodial sequence by selecting the line before entering any digits.

Programmed

The number is stored on the button.

For other displays, see "Common feature displays" on page 203.

Using Last Number Redial

Press to redial the last external number you dialed.

Last Number Redial records a maximum of 24 digits.



Tip - If you have a programmed Last Number Redial button, you can use Button Inquiry (*), then press the Last Number Redial button followed by to check the last number before you dial it.

Preventing a telephone from using Last Number Redial

Last Number Redial can be restricted at individual telephones.

You need the programming template found at the front of this guide. See “A map for working in programming” on page 7 for more information.

1. Press * * 2 6 6 3 4 4 .
2. Press 2 3 6 4 6 (the default System Coordinator password).
3. Press and enter the internal number of the telephone you want to program.
4. Press .
5. Press three times. The display shows **Restrictions.**
6. Press twice.
7. Press . The display shows **Allow last no.:**
8. Press **CHANGE** to choose Y (Yes) or N (No).

Displays

Hidden number

The last number you dialed was a speed dial number that displayed a name rather than the number. The number is dialed correctly, but you cannot see it.

No last number

You have not dialed an external telephone number since the last power interruption or system reset.



Tip - You can copy a number onto an autodial button using Last Number Redial.

Using Speed Dial

Norstar provides two types of speed dialing: system and personal. System Speed Dial programming allows you to assign two-digit speed dial codes to the external numbers your co-workers call most frequently. Personal or User Speed Dial programming allows individuals to program their own speed dial numbers.

Speed dial numbers are subject to the same restriction filters as regularly dialed numbers. Your installer or customer service representative can program system speed dial numbers to bypass dialing restrictions.

Speed dial numbers may include host system signaling codes.

Making a speed dial call

Feature

1. Press to quickly dial external telephone numbers that have been programmed onto speed dial codes.
2. Enter the appropriate two-digit speed dial code.

Changing and adding System Speed Dials

System Speed Dial codes are numbered from 01 to 70. The system coordinator assigns numbers to System Speed Dial codes for the entire system. See “Adding or changing a system speed dial” on page 17.



Tip - *There is no difference between using User Speed Dial and using System Speed Dial. They differ only in how you program them.*

Adding or changing User Speed Dial



Feature * 4

To add or change a User Speed Dial number on your telephone:

1. Press Feature * 4 .
2. Enter a two-digit code from 71 to 94 that you want to associate with a telephone number.
3. To include a line selection for this number, press the line or intercom button. To select a line pool, press a programmed line pool button, or press Intercom and enter a line pool access code. For the M7100 telephone, you can select only a line pool.
4. Enter the number you want to program.
5. Press Hold or OK.

Displays

01:9_
CANCL BKSP OK

Continue entering the number you want to program. You can change the number by pressing BKSP or   . When you are finished, press Hold or OK.

Enter digits
QUIT OK

Enter the telephone number you want to program exactly as if you were dialing it normally. When you are finished, press Hold or OK.

Invalid code

You have entered a code outside the code range (01-70 for system, 71-94 for personal).

No number stored

There is no number stored on the speed dial code you have dialed.

Program and HOLD

If you want to program a line or line pool selection for this speed dial number, select the line or line pool. Otherwise, enter the telephone number exactly as if you were dialing it normally. When you are finished, press .

**Program and OK
QUIT OK**

If you want to program a line or line pool selection for this speed dial number, select the line or line pool. Otherwise, enter the telephone number you want to program exactly as if you were dialing it normally. When you are finished, press OK.

Select a line

There is no line associated with the speed dial number you are trying to use. Select a free external line or line pool and enter the speed dial feature code again.

Unknown number

The system cannot dial the number stored. Reprogram the number.

For other displays, see "Common feature displays" on page 203.

Using Saved Number Redial

You can save the number of the external call you are on (provided you dialed the call) so that you can call it again later. Each telephone can save one number at a time with Saved Number Redial, not one number for each line.



Tip - You can copy a number onto an autodial button using Saved Number Redial.

Saving a number

Press while you are on the call.

Saved Number Redial records a maximum of 24 digits.

Dialing a saved number

Press when you are not on a call.

If you have a programmed Saved Number Redial button, you can use Button Inquiry (*) to check the last number before you dial it.

Preventing a telephone from using Saved Number Redial

Saved Number Redial can be restricted at individual telephones.

You need the programming template found at the front of this guide. See “A map for working in programming” on page 7 for more information.

1. Press * * .
2. Press (the default System Coordinator password).
3. Press and enter the internal number of the telephone you want to program.
4. Press .
5. Press three times. The display shows **Restrictions**.
6. Press twice.
7. Press twice. The display shows **Allow saved no.:**
7. Press **CHANGE** to choose Y (Yes) or N (No).

Displays

Hidden number

You have saved a speed dial number that displays a name rather than the number. The number is dialed correctly, but you cannot see it.

No number saved

You have tried to save the number of an incoming call. You can only save numbers that you have dialed yourself.

Handling many calls at once

Using Hold

You can temporarily suspend a call by pressing .

When a call is on hold, its indicator flashes on all telephones that have access to the line. The call can be retrieved from any of these telephones.

On the M7100 telephone, alternates between two lines; one active, one on hold. The M7100 telephone cannot retrieve a call placed on hold by another telephone.



Tip - Answered Hunt Group calls can be placed on hold at the answering Norstar set. For more information on Hunt Groups see "Programming Hunt Groups" on page 135.

Retrieving a held call

You can connect to a call on hold by pressing the flashing line button of the held call.

Holding automatically

If your line has been programmed with full autohold, you can switch from one call to another and have your calls put on hold automatically.

Press the line button of the caller you want to speak to. Your current caller is put on hold automatically.

Listening on hold

If you have been put on hold, you can hang up the receiver while you wait for the other person to return.

1. Press .

2. Hang up the receiver.
3. Press the line button of the call. You may hear indications from the far end that you are on hold (for example, tones or music).
4. When the person you were talking to returns you hear them through your telephone speaker. Lift the receiver and talk.



Tip - If Automatic Handsfree has been assigned to your telephone, you can use the Handsfree/Mute feature instead of Listen on Hold.

Holding a call exclusively

Feature 7 9

You can put a call on Exclusive Hold so that it can be retrieved only at your telephone.

Press Feature 7 9 or Feature Hold . The line appears busy on all other telephones, and the call cannot be picked up by anyone else in the office.

Displays

On hold: LINENAM

You have placed one or more calls on hold. The name of the line that has been held the longest is displayed.

Using Call Queuing

Feature 8 0 1

If you have more than one call ringing at your telephone, you can choose the call that has the highest priority by pressing

Feature 8 0 1 .

Call Queuing answers incoming external calls before callback, camped, and transferred calls.

Transferring calls

Using the transfer feature

Feature

Transfer allows you to direct a call to a telephone in your Norstar system, within the Norstar network, or external to Norstar.

Transferring a call

1. Press .
2. Call the person to whom you want to transfer the call.
3. If you want to talk to the person to whom you are transferring the call, wait for them to answer, and speak to them before proceeding.
4. When you are ready to complete the transfer, press or JOIN.

You cannot use Last Number Redial, Saved Number Redial, a speed dial code, Priority Call or Ring Again to dial the number for a transfer.

Depending on how a private network call is routed, it may not always be possible for the system to return a transferred call to you if the transferred call is not answered. When transferring a call to a private network destination, stay on the line until the person to whom you are transferring the call answers.

You cannot use the Line Pool feature code to access a line pool for a transfer. To use a line pool, use a programmed line pool button, or press and enter a line pool access code.

If you have an auxiliary ringer programmed to ring for calls on an external line, and you transfer a call on that line without announcing the transfer, the auxiliary ringer rings for the transferred call.

Transferring external calls

If an external call is transferred to a busy telephone, or not answered after a few rings, the call automatically rings again at the telephone from which it was transferred, and the display indicates that the telephone was busy or that no one answered.

When transferring an external call to an external number, the external call you are trying to transfer must be an incoming call on a disconnect supervised line.

While on a conference call, you can remove yourself from the conference and connect the other two callers using the Transfer feature. However, if both of the other people are from outside the system, at least one of the outside callers must have called you and both of the outside calls must be on disconnect supervision lines.

Note: Transfer via Hold on DID lines is not supported. Once a call is answered the line appearances on all other sets are free immediately to take other calls. This allows a greater number of calls to be received. Use the Call Park feature to transfer a call.

In certain situations, you may experience lower volume levels when transferring an external call to an external person, or when transferring two external callers from a conference call.

Canceling a transfer

You can reconnect to the person you are trying to transfer at any time before the transfer is complete.

1. Press # 7 0 or **CANCEL**.

2. If you are not reconnected to your original call, press **[Ris]** and then press the line key of the original call, which is now on hold.

Displays

221>222
CANCL RETRY JOIN

You are talking to the person you want to transfer the call to. Press **RETRY** if you decide to transfer the call to someone else. Press **[Ris]** or **JOIN** to transfer the call.

221 no reply
CALLBACK

The person to whom you tried to transfer a call did not answer. Press **CALLBACK** or the flashing line button to reconnect to the call. On the M7100 telephone, lift the receiver.

Do not disturb
CANCL RETRY JOIN

The person to whom you tried to transfer a call has Do Not Disturb active on their telephone. Press **JOIN** to transfer the call anyway. Press **RETRY** to transfer the call to someone else. Press **CANCL** or the flashing line button to reconnect to the call (on the M7100 telephone, press **Feature** **#** **7** **0**).

Invalid number
CANCL RETRY

You entered an invalid internal number. Press **RETRY** and enter the number again.

Line001 hung up

The external caller you were transferring hung up before the transfer was complete.

Line001>221
CANCL RETRY JOIN

Press **JOIN** to transfer the call on line 001 to telephone 221. Press **RETRY** if, after talking to the person at extension 221, you decide to transfer the call to someone else.

Not in service
CANCL RETRY

The telephone to which you are trying to transfer a call is out of service.

Restricted call
CANCL RETRY

You cannot transfer the call because of telephone or line restrictions.

Still in transfer
CANCL RETRY

Complete the transfer in progress before you access a new feature, answer another alerting call or select an outgoing line.

Transfer denied
CANCL RETRY

Your transfer cannot be completed for one of these reasons:

- All the resources needed to perform a transfer are in use. Try again later.
- You have tried to transfer an external call to another external party. Some restrictions apply.
- You cannot transfer your conference call.

Transfer to:2__
CANCL RETRY

Press **RETRY** if you entered the wrong internal number or if the person to whom you are transferring the call is unavailable.

For other displays, see “Common feature displays” on page 203.

Using Camp-on

Feature 8 2

You can transfer an external call to another telephone, even if all of its lines are busy.

1. Press **Feature 8 2**.
2. Dial the number of the telephone you want to camp the call to.

Camped calls appear on a line button on the receiving telephone, if one is available. If there is no line button available, you receive a message on the display and hear Camp tones.

Each Norstar telephone can handle only one camped call at a time.

Displays

221 Camp max
CALLBACK

You tried to camp a call to a telephone that already has a camped call. The call has come back to you. Press the **CALLBACK** button or the line button to reconnect to the call. On the M7100 telephone, just pick up the receiver.

| | |
|----------------------------|--|
| 221 DND CALLBACK | The person to whom you redirected a call has Do Not Disturb active on the telephone. The call has come back to you. Press the <u>CALLBACK</u> button or the line button to reconnect to the call. On the M7100 telephone, just pick up the receiver. |
| Camp denied | You have tried to camp an internal call. You can only camp external calls. |
| Camp to: CANCL | Dial the number of the internal telephone to which the call is sent. |
| Camped: 221 CALLBACK | The telephone to which you camped a call did not answer the call. The call has come back to you. Press <u>CALLBACK</u> or the line button to reconnect to the call. On the M7100 telephone, just pick up the receiver. |
| Line001 hung up | A call you camped has come back to you, but the caller hung up before you could reconnect. |
| Not in service CALLBACK | The telephone to which you have camped a call is out of service or is being used for programming. The call has come back to you. Press <u>CALLBACK</u> or the line button to reconnect to the call. On the M7100 telephone, just pick up the receiver. |
| Release a call | The line that the camped call is on is in use or that line does not appear at your telephone. Release the line or release an internal line. |

For other displays, see “Common feature displays” on page 203.

Parking a call

Feature

You can suspend a call so that it can be retrieved from any telephone in your system.

1. Press .

2. Use the Page feature () or press **PAGE** to announce the retrieval code displayed by your telephone.

Retrieving a parked call

1. Select an internal line. (On the M7100 telephone, pick up the receiver.)
2. Dial the Call Park retrieval code.

Using Call Park

When you park a call, the system assigns one of 25 codes for the retrieval of the call. These codes consist of the Call Park prefix, which may be any digit from 1 to 9, and a two-digit call number between 01 and 25. For example, if the Call Park prefix is 1, the first parked call is assigned Call Park retrieval code 101.

The Norstar system assigns Call Park codes in sequence, from the lowest to the highest, until all the codes are used. This round-robin approach means that a greater variety of codes are used, which makes it easier for a call to reach the right person when more than one incoming call is parked.

The highest call number (the Call Park prefix followed by 25) is used only by analog telephones or devices connected to the system using an analog terminal adapter (ATA) or an Analog Station Module (ASM). Analog telephones or devices cannot use the other Call Park codes.

Your installer or customer service representative programs both the Call Park prefix and the delay before parked calls are returned to the originating telephone. External calls parked for longer than the programmed delay are returned to your telephone.



Tip - Answered Hunt Group calls are parked in the same manner as other calls. For more information on Hunt Groups see “Programming Hunt Groups” on page 135.

Call Park can be disabled by your installer or customer service representative.

Displays

Already parked

The person you were talking to has already parked your call. You cannot park the same call.

No call to park

You have attempted to use Call Park with no active call on your telephone. If the call you want to park is on hold, reconnect to it before you park it.

Invalid number

You have entered an invalid retrieval code.

No call on: 101

There was no call on the retrieval code you entered.

Park denied

You have tried to park a conference call. Split the conference and park the calls separately. The person who retrieves the calls can reconnect the conference.

Parked on: 402
PAGE EXIT

Record the code shown. Use Page () or press **PAGE** to announce the call and its retrieval code.

Parking full

All available retrieval codes are in use. Transfer the call or take a message instead.

For other displays, see “Common feature displays” on page 203.

Using Callback

When you direct a call you have answered to another telephone, the system monitors the call to make sure it is answered. If no one answers the call within a set length of time, the system directs it back to you.

Callback generates a variety of displays. Most occur after a set delay and are listed in the index. Some occur immediately if the telephone to which you are directing a call is out of service or otherwise unavailable. These are listed with the descriptions of the specific features such as Transfer or Camp-on.

Forwarding your calls

Forwarding your calls to another Norstar telephone

Feature 4

Press Feature 4 and enter the number of the internal telephone to which you want your calls forwarded.

Use Line Redirection to forward calls outside the system. Line redirection takes precedence over Call Forward.

Canceling Call Forward

Press Feature # 4 .

Using Call Forward at your telephone

When you use Feature 4 , all calls go to the destination you select, regardless of how Forward on busy and Forward no answer are programmed.



Tip - If your Norstar set is a member of a Hunt Group, the Call Forward all calls setting is overridden by the Hunt Group routing for Hunt Group calls. For more information on Hunt Groups see "Programming Hunt Groups" on page 135.

If the telephone to which you forwarded your calls does not have the same external lines as your telephone, the forwarded calls appear on intercom buttons.

If a call is forwarded, it does not ring but the line indicator flashes on your telephone. You can answer the call by pressing the button next to the flashing indicator.



Tip - *If you are one of a group of people who regularly forward their calls to one another, be aware that it is possible to set up forward loops where a call is forwarded from one telephone to another in a circle, and is never answered anywhere.*

Overriding Call Forward

If you call someone who has their calls forwarded to you, your call rings at that person's telephone even though they are forwarding their calls to you.

Changing the automatic Call Forward settings for a telephone

Call forwarding occurs automatically when a call is not answered or the line is busy. These automatic options are changed in programming.

For step-by-step instructions, see “Change where a call goes when there is no answer” on page 23.

Changing Forward no answer

Forward no answer redirects unanswered calls to another telephone on your Norstar system.



Tip - *If the Norstar set is a member of a Hunt Group, the Call Forward no answer feature is overridden and the Hunt Group call continues to ring until the hunt time has expired. For more information on Hunt Groups see “Programming Hunt Groups” on page 135.*

Line Redirection takes precedence over Forward no answer.

For step-by-step instructions for changing Forward no answer see “Change where a call goes when there is no answer” on page 23.

Changing the delay before a call is forwarded

You can assign the number of times that the incoming call rings at your telephone before the call is forwarded. To estimate the delay time in seconds, multiply the number of rings by six.

For step-by-step instructions, see “Change the number of times the telephone rings before it is forwarded” on page 24.

Forward on busy

Forward on busy redirects your calls to another telephone on your Norstar system when you are busy on a call, or when you have Do Not Disturb activated at your telephone. For step-by-step instructions, see “Making changes to Call Forward on Busy” on page 25.

Line Redirection takes precedence over Forward on busy. Calls that are redirected by Line Redirection are not affected by any Call Forward features or Call Forward programming.

Telephones that have Forward on busy active can receive priority calls. If you are busy on a target line call, another call to that target line is redirected to the prime telephone for that target line.



Tip - *If the Norstar set is a member of a Hunt Group, the Call Forward on busy feature is overridden and the Hunt Group call continues to ring until the hunt time has expired. For more information on Hunt Groups see “Programming Hunt Groups” on page 135.*

DND on Busy

When you are busy on a call and a second call comes in, your telephone rings softly to alert you to the second call. If you find this second ring distracting, you can have the system prevent a second call from disturbing you by assigning Do Not Disturb (DND) on Busy to your extension.

When DND on Busy is turned on for the set, internal and private network callers hear a busy tone instead of ringing when you are on the telephone. External callers are transferred to the prime set used in your system. For step-by-step instructions, see “Making Changes to Do Not Disturb on Busy” on page 26.

If you use DND on Busy, the line indicator for an external incoming call flashes, but your telephone does not ring.

Forward on busy takes priority over DND on Busy.

If an external call uses a target line, the call is processed according to the programming of the target line. If the target line is busy, the caller may hear a busy tone or be routed to the prime set for the target line regardless of the DND on Busy programming for the telephone.



Tip - *If a Norstar set is a member of a Hunt Group and the set activates this feature, the set does not receive notification of incoming Hunt Group calls while on a call. The DND on busy feature overrides the Hunt Group. For more information on Hunt Groups see “Programming Hunt Groups” on page 135.*

Call Forward and Voice Mail

If you want a voice mail system to pick up unanswered calls automatically

- use the internal number of your voice mail as the destination when you program Forward no Answer and Forward on busy
- or
- make the ring delay greater than the delay used by your voice mail system, if your voice messaging system or service automatically retrieves calls

Displays

Forward denied

There are several reasons why you may get this message. For instance, you cannot forward your calls to a telephone that has been forwarded to your telephone.

Forward>221

CANCL

Your calls are being forwarded to telephone 221.

Not in service

Two or more telephones are linked in a forwarding chain, and one of them is out of service or is being used for programming.

For other displays, see “Common feature displays” on page 203.

Line Redirection

Line Redirection allows you to send your external calls to a telephone outside the office. You may choose to redirect all your external lines or only some of them.

Line Redirection takes precedence over the Call Forward feature. If both features are active on a set, incoming external calls on redirected lines are routed to the specified Selective Line Redirection (SLR) external destination. Incoming internal calls are forwarded to the specified Call Forward destination.

You cannot use the Line Redirection feature on either an M7100 telephone or a telephone connected to an ATA.

Turning on Line Redirection

Feature

1. Press .
2. Select the outgoing line to be used for redirected calls.
3. Enter the number to which calls are redirected (the ways you can do this are listed below).
4. Select the lines to be redirected.

Enter the telephone number to which you want to redirect calls, using one of the following methods:

- Press an external autodial button.
- Enter an external telephone number (using no more than 24 digits) then press or **OK**.
- Press or **OK** if the line you have chosen as the outgoing line is a private network line that does not require you to dial digits.

If you use **ALL** to redirect all your lines, it is important that you wait until all the lines on your telephone light up before pressing or **OK**. If you press or **OK** before all the lines light up, those lines not lit are not redirected.



Tip - The line chosen for redirecting calls on other lines can be used normally when it is not busy on a redirected call. To avoid redirection failing because the chosen line is in use, choose a line pool with several lines in it.

The system does not check that the number you give for line redirection is a valid one. If you redirect to an invalid number, redirection fails. Using an autodial button to enter the redirection number helps avoid this possibility. An autodial button used for line redirection must be programmed to use a specific line.

Canceling Line Redirection

Feature # 8 4

1. Press # 8 4 .
2. Select the lines you no longer want to be redirected.

Allowing a telephone to redirect calls

You can turn a telephone's ability to redirect calls on and off.

You need the programming template found at the front of this guide. See "Getting started with Norstar" on page 1 for more information.

1. Press * * 2 6 6 3 4 4 .
2. Press 2 3 6 4 6 (the default System Coordinator password).
3. Press Show and enter the internal number of the telephone you want to program.
4. Press Show twice.
5. Press Back four times. The display reads **Allow redirect.:**

6. Press **CHANGE** to select **Y** (Yes) or **N** (No).

Turning the redirect ring for a telephone on or off

You can program a telephone to ring briefly (200 milliseconds) when a call is redirected on one of its lines.

You need the programming template found at the front of this guide. See “Getting started with Norstar” on page 1 for more information.

1. Press * * 2 6 6 3 4 4 .
2. Press 2 3 6 4 6 (the default System Coordinator password).
3. Press and enter the internal number of the telephone you want to program.
4. Press twice.
5. Press three times. The display reads **Redirect ring:**.
6. Press **CHANGE** to select **Y** (Yes) or **N** (No).



Tip - If a telephone has redirect ring enabled, it rings briefly for redirected calls on one of its lines even if another telephone set up the line redirection.

Displays while redirecting lines

Intercom

You selected the intercom button as the facility to place the call on. Enter a line pool code or a destination code.

Line Redirection
QUIT ADD REMOVE

Press * or **ADD** to begin redirection. Press # or **REMOVE** to cancel a previous redirection.

| | |
|----------------------------|---|
| No line to use | You have one external line on your telephone, but you need a second line to perform line redirection. Redirect your external line using a line pool as the outgoing line. |
| Outgoing line | You are attempting to redirect a line and the line you have chosen is the outgoing line you have selected as a destination. You cannot redirect a line to itself. Select another line. |
| Pool code: _ QUIT | Enter a valid line pool access code. |
| Redir by 221 OVERRIDE | You have attempted to redirect a line, but someone else has already redirected that line. Press <input type="checkbox"/> * or <u>OVERRIDE</u> to override the previous redirection and redirect the line as you want. |
| Redirect denied | You can redirect calls only on individual lines. |
| Select line out QUIT | Select the line that is used to redirect calls out of the system. |
| Select line(s) QUIT ALL | Press the lines to be redirected. To undo a line selection, press it again. Press <u>ALL</u> to redirect all your lines. |
| Select line(s) ALL OK | Continue to press the lines to be redirected. Press <input type="text"/> Hold or <u>OK</u> when you are finished. |
| Unequipped line | The line you are attempting to redirect cannot be redirected because the hardware does not support redirection. |

Displays while canceling redirection

Select line(s)
QUIT ALL

Press the lines that are no longer to be redirected. The lines light up as you press them. Once you cancel redirection for a line you cannot restore it by pressing the line again. Press ALL to cancel redirection for all your lines. When you are finished, press or OK.

Select line(s)
ALL OK

Continue to press the lines that are no longer to be redirected. Press or OK when you are finished.

For other displays, see “Common feature displays” on page 203.

How Line Redirection is different from Call Forward

Call Forward forwards all calls that arrive at a particular telephone to another telephone within the Norstar system. Line Redirection redirects only the lines you specify, no matter which telephones they appear on, to a telephone outside the Norstar system. Line Redirection takes precedence over Call Forward.

Using Line Redirection

You redirect lines at a telephone, but once redirected, the lines are redirected for the entire system.

You can redirect only lines that appear at line buttons on your telephone.

You can answer the telephone if it rings while you are in the middle of programming Line Redirection, but none of the Norstar call handling features are available until the feature times out. If you need to use a Norstar feature to process the call, quit Line Redirection programming by pressing . Do not press or you disconnect the call you are trying to process.

While you are programming Line Redirection you do not receive any indication of calls that do not actually ring at your telephone.

Be careful to avoid redirection loops. If for example, you redirect your lines to your branch office and your branch office redirects its lines to you, you can create a redirection loop. If these calls are long distance, you end up paying charges.

In certain situations, callers may experience lower volume levels when you redirect calls to an external location.

Communicating in the office

Paging

Feature

Paging allows you to make announcements over the Norstar system using the telephone speakers, or your loudspeaker system, if one is available.

Making a page announcement

1. Press .
2. Choose a page type. Page types are:
 - through the telephone speakers (internal page)
 - through an external speaker (external page)
 - both internal and external (combined page)
3. If necessary, choose a zone.
4. Make your announcement.
5. Press .



Tip - Instead of entering the Page feature code followed by the page type, you can enter the following shortcut codes.

Page zone 0 is all zones.

Internal and zone (0 to 6)

External (code 2 has no zones)

Combined and zone (0 to 6)

Activating and deactivating the ability to page

You need the programming template found at the front of this guide. See “Getting started with Norstar” on page 1 for more information.

1. Press * * 2 6 6 3 4 4 .
2. Press 2 3 6 4 6 (the default System Coordinator password).
3. Press and enter the internal number of the telephone you want to program.
4. Press twice.
5. Press seven times. The display reads **Pa9in9**.
6. Press **CHANGE** to select the setting: Y (Yes) or N (No).

Creating page zones

Each telephone can be assigned to one of six zones for receiving pages.



Tip - Hunt Group DNs cannot be included in a page zone. For more information on Hunt Groups see “Programming Hunt Groups” on page 135.

You need the programming template found at the front of this guide. See “Getting started with Norstar” on page 1 for more information.

1. Press * * 2 6 6 3 4 4 .
2. Press 2 3 6 4 6 (the default System Coordinator password).
3. Press and enter the internal number of the telephone you want to program.

4. Press twice.
5. Press six times. The display reads **Page Zone**.
6. Press **CHANGE** to select the setting: **1, 2, 3,4, 5, 6** or **None**.

You can make a telephone part of a page zone only if the telephone has paging set to **Y** (Yes).

A zone is any set of Norstar telephones that you want to group together for paging, regardless of their location. The maximum number of sets in a page zone is 50.

Your installer programs whether a tone sounds before a page begins, and the maximum number of seconds a page can last before it is automatically turned off.



Tip - *Make sure that everyone who needs to make page announcements has a list showing which telephones are in which page zones.*

Displays

Enter zone:

Enter the desired page zone number (0-6) or press **ALL**.

Invalid zone

You have entered a page zone code that is not between 0 and 6.

Page choice:
SETS SPKR BOTH

Select the type of page you want. See the list in "Making a page announcement" on page 95.

Page timeout

The time allotted for paging has expired.

Paging ALL

You are making a page. The display shows the page zone you have chosen. Press or when you are finished.

Paging busy

A page is already being made in the page zone you have requested.

For other displays, see “Common feature displays” on page 203.



Tip - *You can make an announcement to one person by placing a voice call to their telephone.*

Using Page with external paging equipment

When you make a page that uses external paging equipment (external page or combined page), the Long Tones feature is automatically activated for the external paging system only. This allows you to control optional equipment with the Long Tones feature.

Sending messages

The Messages feature allows you to leave a message on the display of another Norstar telephone or to analog telephones connected to an Analog Station Module (ASM). The Messages feature indicates if you have any messages waiting.

The Messages feature uses a message waiting list to keep a record of your internal messages and your (external) voice mail messages (if you subscribe to a voice message service with visual message waiting indication).

Sending a message

Feature 1

You can leave a message on the display of another telephone in your Norstar system.

You can send up to four messages to different telephones, including your voice message center. If your telephone is a direct-dial telephone or a central answering position (CAP), you can send up to 30 messages.

Only the designated direct-dial telephone for an analog telephone connected to an Analog Station Module (ASM) can send messages to analog telephones by pressing

. Depending on the programming setup, the analog telephone provides either a Stuttered Dial Tone or a Message Waiting Lamp to inform the user of messages pending.

If your reply to a message is forwarded or is answered at another telephone using the Call Pickup feature, the message remains on your telephone until you cancel it or successfully contact the telephone that sent the message.

For analog telephones connected to an ASM, the message waiting indicator remains on until the user invokes . If the analog telephone has the Message Reply Enhancement feature set to Yes, the message waiting indicator is turned off automatically after the reply call is answered no matter from where the call is answered.

For more information on the Message Reply Enhancement feature, see the *Norstar Modular ICS 4.0 Installer Guide*.

1. Press .
2. On a telephone with a two-line display, press **ADD**. (This step is not necessary on a telephone with a one-line display.)
3. Enter the internal number of the person to whom you want to send the message. The person's display reads **Message for you**.

4. On analog telephones connected to an Analog Station Module (ASM), the message waiting indicator is activated.

Canceling a message you have sent

1. Press . The display reads **Cancel for:**.
2. Enter the internal number of the person to whom you sent the message.

Viewing your messages

You can receive up to four messages from different telephones, including your voice message center. A single message from your voice message center may pertain to several voice messages.

On a telephone with a one-line display

1. Press . The display shows the first message.
2. Press or to move through your messages.

On a telephone with a two-line display

1. Press **MSG**. The display shows the first message you received.
2. Press **NEXT** to move through your messages.

Replying to a message

You can call the person (or your voice message center) who sent a message while you are viewing the message.

On a telephone with a one-line display

Press .

On a telephone with a two-line display

Press **CALL**.

If you want to call your voice message center using a line other than the programmed line, exit your message list and dial the voice message center telephone number using normal dialing methods.

Replying to a message using an analog telephone connected to an ASM

On an analog telephone connected to an Analog Station Module

Press * 6 5 . The system automatically retrieves and connects the user to the oldest message sender. (The message can originate from either the designated direct-dial telephone or the internal voice mail system.)

If the analog telephone has the Message Reply Enhancement feature set to Yes, and the sender is the designated direct-dial telephone, the message waiting indicator is turned off automatically after the reply call is answered, no matter from where the call is answered.

For analog telephones connected to an ASM, using the Message Waiting Reply feature (* 6 5), retrieves only internal messages sent to the user.

Analog telephones connected to an ASM cannot retrieve external messages by using the Message Waiting Reply feature (* 6 5). For external messages, users must call back the external voice mail center to retrieve their messages. When doing so, the message waiting indicator on the analog telephone is turned off automatically.



Tip - If there is no voice mail system installed, only the designated direct-dial telephone can send messages to an analog telephone connected to an Analog Station Module (ASM) using . The analog telephone can in turn invoke a single digit access code to reach the designated direct-dial telephone and retrieve messages.

If the designated direct-dial telephone of an analog telephone connected to an Analog Station Module (ASM) is changed, messages sent by the previous designated direct-dial telephone are kept in the incoming message list of the analog telephone until they are retrieved.

Removing items from your message list

You can erase a message while you are viewing it in your message list. If the message is from your voice message center, this only erases the message notification at your telephone. You need to erase the voice message at your voice message center. Refer to your voice message center documentation.

On a telephone with a one-line display

Press .

On a telephone with a two-line display

Press **ERASE**.

Removing items from your message list using an analog telephone connected to an ASM

To remove both internal and external messages on an analog telephone connected to an Analog Station Module

Press to invoke the Cancel Message Waiting feature.

On analog telephones connected to an ASM, the Cancel Message Waiting feature cancels the oldest message received.

The system no longer provides either a Stuttered Dial Tone or a Message Waiting Lamp if there are no messages pending.

Viewing messages you have sent

Feature 1

On a telephone with a two-line display, you can view the messages you have sent.

1. Press **Feature** **1**.
2. Press **SHOW** to display your first sent message.
3. Press **NEXT** to move through your sent messages.

Displays

Cancel denied

You have entered an invalid number when attempting to cancel a message.

Cleared>LINENAM
NEXT

You have cleared an external message from your message waiting list. The message itself exists in your voice message center until you erase it there.

In use: 221

You are trying to call from your message waiting list. The line that you are trying to use is being used by the identified Norstar user.

L001:LINENAMMsg
NEXT CALL CLEAR

You are viewing your message list. The display shows the number and name of the line that was used for your voice mail message.

Message denied

You have tried to send a message to an invalid internal number or to a telephone that is out of service.

Message list
SHOW ADD EXIT

SHOW appears only if you have outstanding messages. Press SHOW to review messages you have sent. Press ADD to send a new message.

Message to:

Enter the internal number of the telephone to which you want to send a message.

Messages #: Calls
MSG CALLS

You have one or more messages and one or more new Call Logs. Press

Feature [8] [0] [6] to change the first line of the display to the current time and date.

No button free

You have no line button free with which to reply to a message.

No number stored

There has been no number programmed for the voice message center. Contact your voice messaging service provider.

Start of list
NEXT

You are at the beginning of your list of messages. Press NEXT to move through your messages.

Their list full

You are trying to send a message to a user whose message waiting list is full.

Your list full

You have tried to send a message but your telephone's list of sent messages is full. Cancel one of the messages you have sent, if possible, or wait until you have received a reply to one of those messages.

For other displays, see "Common feature displays" on page 203.

Using Voice Call

Feature [6] [6]

You can make an announcement or begin a conversation through the speaker of another telephone in the system.



Tip - Hunt Groups cannot accept voice calls. Answer buttons have no appearances for voice calls, and the set does not ring for voice calls. For more information on Hunt Groups see "Programming Hunt Groups" on page 135. For more information on Answer buttons see "Answer buttons" on page 40.

Making a Voice Call

Press Feature [6] [6] .

Muting Voice Call tones

When a voice call begins at your telephone, you hear a beep every 15 seconds as a reminder that the microphone is on.

To stop it from beeping, pick up the receiver or press



Answering a Voice Call without touching your telephone

If Handsfree Answerback is assigned to your telephone, you can respond to a voice call without touching the telephone.

Handsfree Answerback is not available to the M7100 telephone.

When someone makes a voice call to you, simply start talking. Your telephone's microphone picks up your voice.

Once you have answered a voice call, you can put it on hold, transfer it, or otherwise treat it as a normal call.

Preventing Voice Calls to your telephone using Voice Call Deny

Press . Voice calls ring like regular internal calls. Your other calls proceed normally.

Canceling Voice Call Deny

Press .

Displays

Dial voice call

Dial the internal number or press the internal autodial button of the person to whom you want to speak.

Microphone muted

Your handsfree microphone is muted. Press or pickup your receiver to respond to the voice call.

No voice call

The telephone receiving the call cannot accept voice calls for one of the following reasons: it is active or ringing with another call; Call Forward is turned on; Do Not Disturb is turned on; Voice Call Deny is turned on; it is not a Norstar telephone. Your call proceeds automatically as a regular ringing call.

Voice call

The line is open for you to speak.

Tracking your incoming calls

Using Call Log

Telephones can automatically log Call Display information for calls on an external line. The line must appear on that telephone but it does not have to be a ringing line.

If your system is equipped with the appropriate equipment and you have subscribed to the call information feature supplied by your service provider, you are able to capture information about incoming callers in your call log. The same feature is supplied by an ISDN service package that comes with calling line identification (CLID).

Call Log creates a record of incoming external calls. For each call the log can contain:

- sequence number in the Call Log
- name and number of the caller
- indication if the call was long distance
- indication if the call was answered (and identity of who answered it)
- time and date of the call
- number of repeated calls from the same source
- name of the line that the call came in on

Call Log can help you to

- keep track of abandoned or unanswered calls
- track patterns for your callers (for example volume of calls and geographical location of calls)

- record caller information quickly and accurately
- build a personal telephone directory from log items

The long distance indicator and the caller's name and number, may not be shown in the log, depending on the Call Display services provided by your local telephone company and the caller's local telephone company.

To use the features on the following pages, your telephone must have spaces available in its Call log. Your installer or customer service representative programs each telephone with an appropriate number of spaces.

Call Log options

Feature * 8 4

You can select the type of calls to be stored in your Call Log. Choose from four Autolog options: **No one answered**, **Unanswered by me**, **Log all calls**, **No autologging**.

1. Press Feature * 8 4 . The display shows the current option.
2. Press # or **NEXT** to change the option.
3. Press Feature or **OK** to select the display option.

Logging a call manually

Feature 8 1 3

If your calls are not automatically logged, you can manually log call information when you are connected to an external call. Storing information for your current call can be helpful in many situations. For example, you may want to

- record a caller's information without using paper and pencil

- record only selected calls that you choose, as opposed to using Call Log automatically
- quickly record caller information before a caller hangs up

Press to log an external call manually.

Deleting old log items

Your log has a set number of items that it can hold. When it becomes full, new calls cannot be logged. When your log is full, Autobumping automatically deletes the oldest Call Log item when a new call is logged.

Press to enable autobumping.

Press to disable autobumping.



Viewing your Call Log

To view your log:

1. Press . The display shows the number or previously read items (old) and the number of new, unread items (new) in the log.
2. Press or **OLD** to view old items; press or **NEW** to view new items.
3. Press or **RESUME** to display the last item you viewed, the last time you viewed your Call Log.



Names and numbers for external callers are displayed only if you have subscribed to Call Display services from your local telephone company.

Viewing a Call Log item

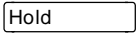

Press   or **MORE** to view the information for a call log item.

Erasing log items

You should routinely erase log items that you've read, to make space for new items in your log.

1. Display the item you want to erase.
2. Press  or **ERASE**.
3. Press  to exit.

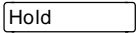

If you accidentally erase an item, you can retrieve it.

1. Press  or **UNDO** immediately after accidentally erasing an item.
2. Press  to exit.

Making a call using Call Log

You may find it helpful to place calls from within your Call Log. The number stored for each call may vary depending on the type of call. For example, if the call was placed from a Centrex or PBX system, the first few numbers may need to be trimmed before you can make the call. If the number you want to call is long distance, or if you want to use a line pool, you may need to add numbers.

To place a call:

1. Display the log item for the call you want to place.
2. Display the associated telephone number.
3. Press   or **TRIM**, once for every digit that you want to remove.
4. Dial any extra digits required.
5. Press an external line or line pool button.

- Lift the receiver. (This is not necessary if Handsfree is programmed at your telephone.) The displayed number is dialed.

Creating a password to your Call Log

Feature * 8 5

To access your Call Log through a password:

- Press Feature * 8 5. The display reads **New Password:**.
- Enter your four-digit password. The display reads **Repeat New:**.
- Re-enter your four-digit password. The display reads **Password changed**, which confirms that your password has been assigned.

To enter Call Log using your password:

- Press Feature 8 1 2 to enter Call Log. If you have programmed a password, the display reads **Password:**.
- Enter your four-digit password.

If you forget your Call Log password, it can be deleted in programming. See “Using passwords” on page 171.

Changing your Call Log password

Feature * 8 5

- Press Feature * 8 5. The display reads **Old Password:**.
- Enter your old password. The display reads **New Password:**.
- Enter your new four-digit password. The display reads **Repeat New:**.

4. Re-enter your password. The display reads **Password changed**, which confirms that your password has been changed.

Deleting an assigned password

Feature * 8 5

1. Press * 8 5 . The display reads **Old Password:**.
2. Enter your old password. The display reads **New Password:**.
3. Press or **OK**. The display reads **No Pswd assigned**, which confirms that your password has been deleted.

Programming a telephone to log calls automatically

Your installer or customer service log representative can program each telephone to automatically log calls coming in on a line.

Displays

1:Unknown name

The caller's name is unavailable.

1:Unknown number

The caller's number is unavailable.

12:KATE SMITH
NEXT ERASE MORE

_ indicates a new item.

12)KATE SMITH
NEXT ERASE MORE

) indicates that the call was answered.

12\$KATE SMITH
NEXT ERASE MORE

\$ indicates a long distance call.

49/1234567890123
NEXT ERASE MORE

✓ indicates that the stored number has been shortened to its final 11 digits. Press or MORE to display additional information about the call.

Call(s) bumped

One or more log entries have been deleted by the Autobumping feature while you are looking at the Call Log.

Hold or release

Hold or release your active call before entering Call Log.

In use: SETNAME

The external line is in use.

Jan 4 9:00a 3X
NEXT ERASE MORE

The repeat call counter, shown along with time and date, indicates the number of calls you have received from the same caller.

Line001)227
NEXT ERASE MORE

This call was answered at another telephone (227).

Line001)Logit
NEXT ERASE MORE

This call was logged manually.

Line001
NEXT ERASE MORE

This call was not answered.

Messages & Calls
MSG CALLS

There are one or more items in your message waiting list, and there are one or more new items in your Call Log. Press 8 0 6 to change the first line of the display to the current time and date.

New calls begin

You have viewed your last old log item and now view your new log items.

No info to log

No information is available for the call.

No log assigned

No log space has been assigned to the telephone.

No resume item

The resume item has been removed because of Autobumping, repeat call update, or log reallocation while you are looking at the Call Log.

For other displays, see “Common feature displays” on page 203.

Using Voice mail

If you subscribe to a voice message service outside your office, you can access that service through your Norstar system. Your installer or customer service representative programs your Norstar telephone to indicate when you have a voice message waiting on a particular line.

To find out if your external voice message service works with Norstar, or if you have any problems with your service, contact your voice message service provider.

Customizing your telephone

Finding out what a button does using Button Inquiry

Feature * 0

You can check the function of any line, intercom, or programmed button on your Norstar telephone by pressing Feature * 0 . On the M7100 telephone Button Inquiry shows your internal number followed by the function assigned to your single memory button.

Displays

```
001 <LINENAME>
      SHOW      OK
```

The display shows the number and name of the line. Press SHOW to view the redirection status of the line.

```
123456789012345...
      VIEW→     OK
```

Press # or press VIEW→ or ←VIEW to view a number that is too long to fit on the display. Press Hold or OK when you are done.

```
221 <SETNAME>
NEXT  VIEW→
```

The display shows the directory number of the telephone, and the assigned name. Press NEXT to see the first line assigned to ring at the intercom button.

```
<Feature name>
      SHOW      OK
```

The name of the feature assigned to a button is displayed when you press the button. Press # or SHOW for additional information.

```
Press a button
EXIT
```

Press the button you want to check. Press Feature or EXIT when you are finished.

For other displays, see "Common feature displays" on page 203.

Making the display darker or lighter using Contrast adjustment

Feature * 7

1. Press Feature * 7 .

2. Press a number on the dial pad to choose the contrast level you prefer.

On a two-line telephone, you can use the **UP** and **DOWN** display buttons to adjust the contrast. The number of contrast levels available varies from one telephone model to another.

Changing the language on the display

You can select the language used on the display of each Norstar telephone. Norstar supports three languages: English, French and Spanish. Button caps are available for each language. When your system is first installed, all telephones use English.

If you program * 5 0 1 on to a memory button, you can press that button until the language you want appears on the display. You cannot program

* 5 0 2 or * 5 0 3 onto a memory button.

English

Press * 5 0 1 .

French

Press * 5 0 2 .

Spanish

Press * 5 0 3 .

Programming a feature code onto a memory button

You can program a feature code onto a memory button. In some cases, pressing the button a second time cancels the feature.

Programming feature buttons

Feature * 3

Any memory button not programmed as an external or internal line, target line, Answer button, or Handsfree/Mute button, is available for features.

1. Press Feature * 3 .
2. Press the memory button you want to program with a feature.
3. Enter the appropriate feature code you want to assign onto the button.

The following feature codes cannot be programmed onto a memory button: Long Tones and any code beginning with * except Feature * 5 0 1 (Language Choice) and Feature * 7 (Contrast Adjustment).



Tip - When you program a button with the line pool feature code, you must enter a line pool access code after the feature code. The programmed line pool button accesses a specific line pool, not the line pool feature.

Erasing a feature button

1. Press Feature * 1 .
2. Press the feature button.
3. Press Hold or **OK** to erase the button.

Displays

<Feature name>
SHOW OK

The name of the feature assigned to a button is displayed when you press the button. **SHOW** appears when there is more information available. Press # or **SHOW** for additional information.

Enter code:

If you are checking a speed dial button, enter the two-digit speed dial code that you want to check.

F_
QUIT CLEAR

Enter the feature code, or press **RIS** or **QUIT** to quit programming or **CLEAR** to clear the numbers you have entered. The system accepts the entry as soon as you enter a valid feature code.

Feature code:
QUIT

Press and enter the feature code you want to assign to the button. You cannot enter invalid codes.

Feature moved

You have programmed a button with a feature that was already programmed onto another button. The feature has moved to the button you just programmed. Its original button is now blank.

Press a button
EXIT

Press the button you want to check. Press or **EXIT** when you are finished.

Program and HOLD

Enter the number you want to program and press . To erase the button, just press .

Program and OK
QUIT OK

Enter the number you want to program and press **OK**. To erase the button, just press or **OK**.

For other displays, see “Common feature displays” on page 203.

Applying button cap labels

Before you apply button labels, activate the Button Inquiry feature (* 0) to verify the button functions, and to avoid activating features as you put the labels onto the buttons. For more information refer to “Finding out what a button does using Button Inquiry” on page 115.



Tips - Keep the extra labels and button caps with each Norstar telephone.

Types of button caps

- **Unlabeled, clear button caps**
with appropriate green or grey paper for typing in line numbers, telephone numbers, and features
- **Pre-printed, colored button caps**
in green or grey

Some examples of pre-printed button caps

| Green caps | Grey caps |
|-------------------|------------|
| Line 1 | Last No. |
| Handsfree Mute | Speed Dial |



Tips - To make identification of line types easier, use preprinted green button caps for lines that support incoming and outgoing calls. Use clear button caps for target lines that are incoming only.

Identifying the telephones

1. Write the individual telephone numbers on the labels and attach them to the appropriate Norstar telephones.
2. Write the telephone number and the internal number on the appropriate *Norstar Receiver Card* for each type and color of telephone that is to be installed.

3. Cover the *Norstar Receiver Card* underneath the receiver of each telephone with the plastic lens.

Norstar default button assignments

During Startup, the Norstar installer chooses one of the available templates. Default features are assigned automatically to the programmable buttons on Norstar telephones, and vary with the template and the telephone. The default features are listed in the following tables in this chapter.



Tips - *Norstar telephones are shipped from the factory with the button caps in place for the Square template.*

Please consult your customer service representative to determine the type of template programmed into your system before applying button assignments.

Rules of default button assignment

Line and Intercom buttons are assigned by default templates and can be changed in programming. Handsfree/Mute and answer buttons are not assigned by default. If these features are defined, however, they are automatically assigned to specific buttons, as described on this and the following page. None of these buttons can be assigned to M7100 telephones.

The Handsfree/Mute feature appears on the bottom right-hand button (the bottom button on the M7208 telephone), moving the Intercom button(s) up one position.

Each telephone can have up to eight Intercom buttons. They appear above the Handsfree/Mute button at the bottom right-hand position on your telephone (the bottom button on the M7208 telephone).

Each telephone can have up to four answer buttons. They appear above Intercom buttons in the right column and continue up from the bottom in the left column, replacing the features on those buttons. (On the M7208 telephone, answer buttons appear above Intercom buttons and below external line buttons in a single column.)

External line buttons appear in ascending line order, starting at the top button in the left column (the top button on the M7208 telephone). If more than five external lines are assigned to an M7310 telephone, or more than 12 to an M7324 telephone, assignment continues down the buttons on the right column, erasing the features on those buttons. Line buttons have priority over feature access buttons but not Handsfree/Mute, Intercom, or answer buttons.

M7310 telephone button defaults

The default button assignments for the M7310 telephone depend on the template applied. The exception is the default numbering for the dual memory buttons. Refer to “Using Buttons” on page 4.

Dual memory buttons

| | | |
|---------|---------|---------|
| Set 233 | Set 237 | Set 241 |
| Set 221 | Set 225 | Set 229 |
| Set 234 | Set 238 | Set 242 |
| Set 222 | Set 226 | Set 230 |
| Set 235 | Set 239 | Set 243 |
| Set 223 | Set 227 | Set 231 |
| Set 236 | Set 240 | Set 244 |
| Set 224 | Set 228 | Set 232 |

This example shows defaults for a system with three-digit internal numbers. The defaults do not actually exist on any telephone, as no telephone has an autodial button for itself. The position that would be taken by the autodial button for itself, is blank.

Template button assignments

| Square | | Centrex | | Hybrid | |
|----------|------------|----------|------------|-----------|------------|
| Line 1 | Conf/Trans | Line<xx> | Conf/Trans | Line 1 | Conf/Trans |
| Line 2 | Last No. | Transfer | Last No. | Line pool | Last No. |
| Call Fwd | Voice Call | Call Fwd | Voice Call | Call Fwd | Voice Call |
| Pick-Up | Intercom | Pick-Up | Intercom | Pick-Up | Intercom |
| Page | Intercom | Link | Intercom | Page | Intercom |

| PBX | | DID | |
|----------|------------|----------|------------|
| DND | Conf/Trans | Line<xx> | Conf/Trans |
| Transfer | Last No. | Transfer | Last No. |
| Call Fwd | Voice Call | Call Fwd | Voice Call |
| Pick-Up | Intercom | Pick-Up | Intercom |
| Page | Intercom | Page | Intercom |

M7324 telephone button defaults

The default button assignments for the M7324 telephone depend on the template applied. Refer to “Using Buttons” on page 4.

| Square | | Centrex | | Hybrid | |
|--------|------------|-----------|------------|-----------|------------|
| Line 1 | Call Fwd | Line<xx> | Call Fwd | Line 1 | Call Fwd |
| Line 2 | Speed Dial | blank | Speed Dial | Line pool | Speed Dial |
| blank | Last No. | blank | Last No. | blank | Last No. |
| blank | Saved No. | blank | Link | blank | Saved No. |
| blank | Conf/Trans | blank | Conf/Trans | blank | Conf/Trans |
| blank | Transfer | blank | Transfer | blank | Transfer |
| blank | DND | blank | DND | blank | DND |
| blank | Pick-Up | blank | Pick-Up | blank | Pick-Up |
| blank | Voice Call | blank | Voice Call | blank | Voice Call |
| blank | Page | bla nk | Page | blank | Page |

| | | | | | |
|-------|---------------------------------------|-------|---------------------------------------|-------|---------------------------------------|
| blank | <input type="text" value="Intercom"/> | blank | <input type="text" value="Intercom"/> | blank | <input type="text" value="Intercom"/> |
| blank | <input type="text" value="Intercom"/> | blank | <input type="text" value="Intercom"/> | blank | <input type="text" value="Intercom"/> |

| PBX | | DID | |
|-------|---|---|---|
| blank | <input type="text" value="Call Fwd"/> | <input type="text" value="Line<xx>"/> | <input type="text" value="Call Fwd"/> |
| blank | <input type="text" value="Speed Dial"/> | <input type="text" value="Transfer"/> | <input type="text" value="Speed Dial"/> |
| blank | <input type="text" value="Last No."/> | blank | <input type="text" value="Last No."/> |
| blank | <input type="text" value="Saved No."/> | blank | <input type="text" value="Saved No."/> |
| blank | <input type="text" value="Conf/Trans"/> | blank | <input type="text" value="Conf/Trans"/> |
| blank | <input type="text" value="Transfer"/> | blank | <input type="text" value="Transfer"/> |
| blank | <input type="text" value="DND"/> | blank | <input type="text" value="DND"/> |
| blank | <input type="text" value="Pick-Up"/> | blank | <input type="text" value="Pick-Up"/> |
| blank | <input type="text" value="Voice Call"/> | blank | <input type="text" value="Voice Call"/> |
| blank | <input type="text" value="Page"/> | blank | <input type="text" value="Page"/> |
| blank | <input type="text" value="Intercom"/> | blank | <input type="text" value="Intercom"/> |
| blank | <input type="text" value="Intercom"/> | blank | <input type="text" value="Intercom"/> |

M7100 telephone button defaults

For all templates, the one programmable button on the M7100 telephone is .

M7208 telephone button defaults

The default button assignments for the M7208 telephone depend on the template applied.

| Square | Centrex | Hybrid | PBX | DID |
|---|---|---|---|---|
| <input type="text" value="Line 1"/> | <input type="text" value="Line<xx>"/> | <input type="text" value="Line 1"/> | <input type="text" value="Pick-Up"/> | <input type="text" value="Line<xx>"/> |
| <input type="text" value="Line 2"/> | <input type="text" value="Transfer"/> | <input type="text" value="Line pool"/> | <input type="text" value="Transfer"/> | <input type="text" value="Transfer"/> |
| <input type="text" value="Last No."/> | <input type="text" value="Last No."/> | <input type="text" value="Last No."/> | <input type="text" value="Last No."/> | <input type="text" value="Last No."/> |
| <input type="text" value="Page"/> | <input type="text" value="Link"/> | <input type="text" value="Page"/> | <input type="text" value="Page"/> | <input type="text" value="Page"/> |
| <input type="text" value="Conf/Trans"/> | <input type="text" value="Conf/Trans"/> | <input type="text" value="Conf/Trans"/> | <input type="text" value="Conf/Trans"/> | <input type="text" value="Conf/Trans"/> |
| <input type="text" value="Speed Dial"/> | <input type="text" value="Speed Dial"/> | <input type="text" value="Speed Dial"/> | <input type="text" value="Speed Dial"/> | <input type="text" value="Speed Dial"/> |

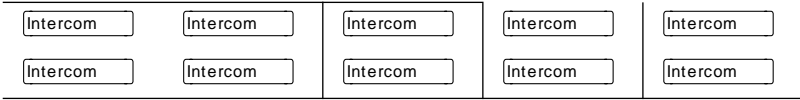

Tips - The default Page button activates the External Page option (Feature).

Moving line buttons

Feature *

You can move external lines to different buttons on your telephone to arrange your lines in the way that makes the most sense to you.

You cannot move intercom, answer or Handsfree/Mute buttons onto a CAP module.

1. Press Feature * .
2. Press the button you want to move the line from.
3. Press the button you want to move the line to.

Displays

Exchanged

The two buttons you selected have exchanged position.

Invalid location

You have tried to move a line to a button that cannot be used as a line button, such as an intercom button, Handsfree/Mute button, or an answer button.

Move line from:
QUIT

Press the button of the line you want to move. Press Feature or **QUIT** when you have finished moving lines.

Move line to:
QUIT

Press the button you want to move the line to. Neither of the buttons is erased. The lines, or the line and feature, simply switch places.

Press a line

The button you are trying to move is not a line button. If you are trying to switch a line and a feature, move the line to the feature button and not the feature button to the line.

Changing the type of ring



Feature * 6

You can choose one of four distinctive rings for your telephone. This makes it easier to identify your telephone in an open office.

1. Press Feature * 6 .
2. Press 1 , 2 , 3 , 4 , or **NEXT**. You hear the selected ring for two seconds.
3. Repeat until you hear the ring you prefer, then press Hold or **OK**.

Adjusting the Ring volume

Feature * 8 0

1. Press Feature * 8 0 . The telephone rings.
2. Press    to adjust the volume; left end for lower and right end for higher.

Hiding the message or calls indication

Feature 8 0 6

The display that shows you have messages or calls can be replaced with the current time and date. You can retrieve your message and call information by using the display buttons that appear on the second line of the display.

If you are using a telephone with a single-line display, the message or call indication is hidden.

1. Press . The current time and date appears on the top line of the display.
2. Press MSG or to see your messages, or press CALLS or to see your calls.

Restoring the messages and calls indication

Press .

User Preferences

The User Preferences section of programming allows you to program memory buttons, speed dial codes and other settings for any Norstar telephone on the system.

For example, an employee may want to have the Do Not Disturb feature programmed onto a memory button or create a speed dial code. Instead of programming from the employee's telephone, you can go into programming on the telephone nearest you to make the change.

Using User Preferences

Feature * * 8 7 3 7

1. Press Feature * * U S E R
(Feature * * 8 7 3 7).
2. Enter your System Coordinator or Basic password (the default passwords are 2 3 6 4 6 and 2 2 7 4 2).

By using a Basic password, it is possible to have someone else do day-to-day upkeep of people's telephones without giving out access to sensitive programming. See "Using passwords" on page 171.

After you enter the proper password, the display shows you the telephone with the lowest internal number followed by its name (For example, **221:Reception**).

1. Press Next to move through all the telephones on the system.
2. Press Show when you see the telephone you want to change. The display reads the model number of the

telephone at the extension.

The display shows **Connect set** if no telephone is connected at that internal number.

You cannot make changes if the model is **Other**.

3. Press to move through all the subheadings in User Preferences.

User Preferences programming is available under the heading **User Preferences** in **Terminal Sets** in the main body of programming.

Sub-headings in User Preferences

| User preferences |
|------------------|
| Model |
| Button prgrming |
| User speed dial |
| Call log opt'ns |
| Dialing opt'ns |
| Language |
| Display cntrst |
| Ring type |

Changing button programming

Press at **Button prgrming**. The display shows the number of buttons on the telephone (an example is shown in Displays at the end of this section).

If the telephone has a CAP module, you can press **CAP1** to see the buttons on the module.

Press to move through all the buttons on the telephone.

Button numbering used with User Preferences programming

M7100 telephone

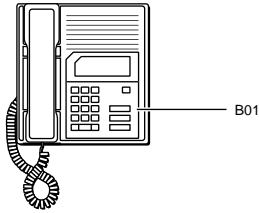

M7310 telephone

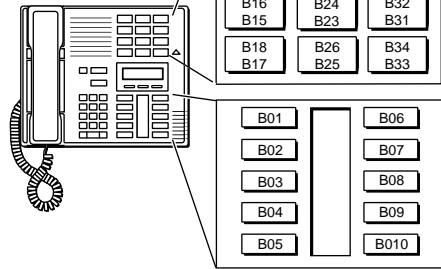

M7208 telephone

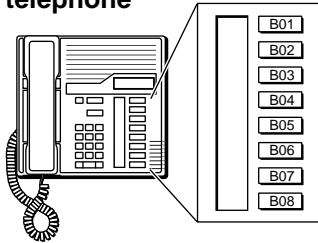

M7324 telephone

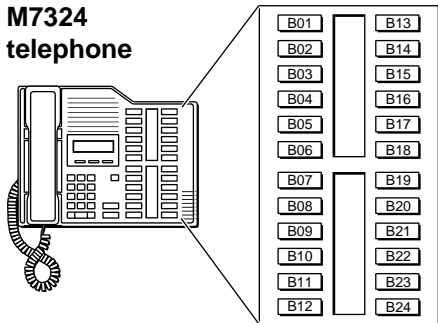

CAP module

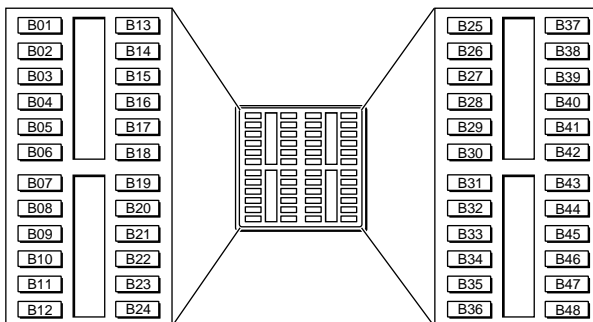

Use the display buttons to change the programming for a button. User Preferences programming cannot change the buttons that are used by lines, intercom, and the handsfree feature.

The display buttons used in button programming.

- CANCL Moves you out of a setting without making any changes to it.
- CLR Erases the button.
- TEL# Programs the key as an autodial number for an internal or an external number. If it is an external autodial number, you must choose a line, line pool, or the routing table for the call to use.
- CHANGE Used when you are setting up an external autodial number. Press CHANGE until you see the type of line or pool you want the number to use.
- FEATR Press to store a feature code on the button.
- FIND Locates a specific button on a telephone by entering its number. Button numbers are shown in the illustrations.
- LIST Takes you to a list of feature codes. Press to move through the list and press OK when you see the feature you want to program on the button.

Information about individual displays is described on page 132.

Changing User Speed Dial

1. Press at **User Speed Dial**. The display shows the number of speed dial codes that are available.
2. Press to see the first speed dial code (71).
3. Press to move through all the speed dial codes.
4. Press at the code you want to change.
5. Press CHANGE and enter the telephone number the same way you would dial it on the telephone.
6. Press OK.

7. Press and choose the line (or enter a code for a line pool) the speed dial code should use.

Use the line pool code to select a particular line pool for use with Speed Dial. If you select **Use routing tbl1**, a line or pool is chosen by the routing programming according to the initial digits in the number.

The route you choose for a User Speed Dial code must be one that the telephone can use. For example, if the telephone does not have access to Line Pool B and you use that pool code with the speed dial code, the code does not work.

To change a system speed dial code, see “Adding or changing a system speed dial” on page 17.

Changing Call Log options

1. Press at **Call log opt'ns...**
2. Press **CHANGE** until you see the option you want to use. See “Call Log options” on page 108.

Changing how calls are dialed

1. Press at **Dialing opt'ns...**
2. Press **CHANGE** until you see the option you want to use.

Descriptions for dialing options are found on the *Telephone Feature Card*, or see “Changing how you dial your calls” on page 57.

Changing the language used on the display

Press **CHANGE** at **Language:** until you see the language you want to use. See “Changing the language on the display” on page 116.

Making the display lighter or darker

Press **CHANGE** at **Display contrast** until you see the value you want to use.

The display contrast on the telephone you are using for the programming session does not change when you are programming another telephone.

Changing the telephone's ring

At **Ring type**, press **CHANGE** until you see the option you want to use.

Descriptions for ringing options are found on the *Telephone Feature Card* or in “Changing the type of ring” on page 125.

Displays

```
10+24 buttons
FIND
```

There are ten memory buttons and twelve dual memory buttons on the telephone you are viewing. Press to begin looking at what's on each button.

```
B01:L06:Line 001
FIND
```

A line appears on the button. You cannot store a feature or number on it.

```
B02:#Reply M59...
CLR TEL# FEATR
```

A feature is stored on this button. Press to see the feature code. A full list of names and codes for features is included in the index.

```
Code:F#65...
CLR TEL# FEATR
```

Shows the feature code stored on a button. Press to see the button number and feature name.

```
B03:160455512...
CLR TEL# FEATR
```

The button has a telephone number stored on it. Press to see the rest of the number.

```
Extern1 tel #...
CLR TEL# FEATR
```

The autodial is an external number. Press to see what line or pool the call is programmed to go out on.

Internl tel #...
CLR TEL# FEATR

The autodial is an internal number. Press to see more information.

B04:Intercom...
FIND

The button is used for intercom. Press to see more information about the button. You cannot store a feature or number on it.

B05:Ansr 93
FIND

The button is used for an Answer DN. You cannot store a feature or number on it.

B06:Blank button
CLR TEL# FEATR

Either nothing is stored on the button or you have just cleared the button by pressing CLR.

B10:Handsfree
FIND

The button is occupied by the Handsfree feature. You cannot store a feature or number on it.

For other displays, see “Common feature displays” on page 203.

Programming Hunt Groups

The Hunt Groups feature allows a group of Norstar sets to be called by a single directory number ensuring that calls are easily routed to the appropriate group.



The Incoming Line Group (ILG) functionality is now accomplished through the Hunt Group feature. When upgrading to Modular ICS 4.0 any lines previously belonging to an ILG are not automatically converted to broadcast Hunt Groups, they must be programmed. Please refer to “Assigning or unassigning lines to a group” on page 138.

Hunt Groups are used in situations where a group of people performing the same task are required to answer a number of related phone queries. Some typical uses of Hunt Groups are:

- a sales department answering questions on product prices or availability
- a support department answering questions concerning the operation of a product
- an emergency department answering calls for help.

Hunt Groups can be used to route calls to a support service such as a Help Line for a software company. Specialists dealing with Product A can be in one group, and specialists dealing with Product B can be in another group. Incoming calls hunt for the next available set in the group. If no set is available, the call can be placed in a queue or routed to an overflow set.

The Hunt Groups subheading in system programming is the area where programming changes are made to the following:

- members of a group
- member position in a group
- what lines are assigned to a group
- how incoming calls are distributed
- how long the system looks for available members
- where a call goes if all members are busy

Note: Videophones should not be programmed as members of a Hunt Group. Hunt Groups allow one B channel connection at a time and videophones use two B channels.

Features affected by Hunt Groups include:

- Call Forward All Calls
- Call Forward No Answer
- Call Forward on Busy
- Group Pickup
- Transfer via Hold
- Priority Call
- Line Redirection
- Page Zones
- Voice Call

Adding or removing members from a group

Modular ICS 4.0 supports 30 groups programmed with up to 40 members per group to a maximum of 600 members system-wide. For the recommended configuration please refer to the Modular ICS Installer Guide. Members of the group can be any Norstar set, CTA 500dm, ISDN terminal, or portables. A

Norstar set can be in more than one Hunt Group but is considered a member in each Hunt Group, increasing the total number of members in the system.

There can be only one appearance of the same Hunt Group on a set. Hunt Group DNs cannot be members of other Hunt Groups. A DN can be associated with a member of a Hunt Group and is called a member DN.

Consult your customer service representative to determine your Hunt Group number range.

1. Place the programming overlay on any M7310 or M7324 telephone.
2. Press * * 2 6 6 3 4 4 (CONFIG). The display shows **Password:**.
3. Press (SCPLUS). The display shows **Terminals#Sets.**
4. Press until the display shows **System programming.**
5. Press . The display shows **Hunt groups.**
6. Press . The display shows **Show group.**
7. Enter the Hunt Group number you want to program (1-30).
8. Press . The display shows **Member DNs:**. (There are no member DNs if none are programmed.)
9. Press . The display shows the members for that group.
10. Press **ADD** to add a member or press **REMOVE** to remove a member from the group.
11. Press to exit or to continue programming.

Moving members of a group

Member order within a Hunt Group is important. The member order determines how a call is routed through a Hunt Group.

1. Place the programming overlay on any M7310 or M7324 telephone.
2. Press * * 2 6 6 3 4 4 (CONFIG). The display shows **Password:**.
3. Press (SCPLUS). The display shows **Terminals:Sets.**
4. Press until the display shows **System Programming.**
5. Press . The display shows **Hunt Groups.**
6. Press . The display shows **Show Group.**
7. Enter the Hunt Group number you want to program (1-30).
8. Press . The display shows **Member DNs:**.
9. Press . The display shows the members for that group.
10. Press **MOVE** to move an existing member to another place within the Hunt Group. The display shows the member number followed by an arrow.
11. Enter the new position number for the extension.
12. Press to exit or to continue programming.

Assigning or unassigning lines to a group

Configure the prime set for a Hunt Group's line to None to avoid delayed ring transfer of external Hunt Group calls to the prime set before the Hunt Group can receive the call.

A line can be assigned to only one group.

1. Place the programming overlay on any M7310 or M7324 telephone.
2. Press * * 2 6 6 3 4 4 (CONFIG). The display shows **Password:**.
3. Press (SCPLUS). The display shows **Terminals:Sets.**
4. Press until the display shows **System programming.**
5. Press . The display shows **Hunt groups.**
6. Press . The display shows **Show group.**
7. Enter the Hunt Group number you want to program (1-30).
8. Press . The display shows **Member DNs:**.
9. Press . The display shows **Line assignment.**
10. Press . The display shows **Show line:**.
11. Enter the line number you want to program and press SCAN to go to the first line assigned to this group, or press LIST to go to the first line in the system.
12. Press CHANGE to program the line as **Unassigned** or **Assigned**.
HGnn means the line is assigned to another Hunt Group.
13. Press to exit or to continue programming.

Setting the distribution mode

There are three modes of call distribution:

- **Broadcast**—rings each set in the group simultaneously. Calls are handled one at a time; other calls are queued. As soon as a call is picked up, the call next in the queue is presented to the Hunt Group without having to wait for queue time-out.

In Broadcast mode, a single incoming call rings simultaneously at all the sets in a group. This way, all receptionists in the group can share the load of answering large volumes of calls. All sets automatically display the calling line identification (CLID), if available. A familiar example is a fund-raising campaign where a group of operators are waiting to take each call as it comes in.

- Sequential—starts the call at the first set in the Hunt Group and distribution is complete when the first free set has been found. Simultaneous calls can be presented. Distribution is order based.

In Sequential mode, you can program your top salesperson to be the first member of the group to receive incoming calls.

- Rotary—the call starts at the set after the one which answered the last call. Distribution is complete when the next free set has been found. Simultaneous calls can be presented. Distribution is order based.

In Rotary mode, you can ensure that all your helpline people are receiving calls on an equal basis, rather than one person receiving the majority of calls. The call rings at one set at a time in a round robin fashion.

If a Hunt Group has available members but nobody answers the call, the call is routed through the Hunt Group list until either someone answers the call or the queue time-out occurs. In the latter case, the call is routed to the overflow position. Once a call goes to the overflow position it is no longer a Hunt Group call.

1. Place the programming overlay on any M7310 or M7324 telephone.
2. Press * * 2 6 6 3 4 4 (CONFIG). The display shows **Password:**.

3. Press (SCPLUS). The display shows **Terminals#Sets.**
4. Press until the display shows **System programming.**
5. Press . The display shows **Hunt groups.**
6. Press . The display shows **Show group.**
7. Enter the Hunt Group number you want to program (1-30).
8. Press . The display shows **Member DNs:**
9. Press until the display shows **Mode.**
10. Press **CHANGE** to set the mode: **Sequential, Rotary, Broadcast.**
11. Press to exit or to continue programming.

Setting the hunt delay

This setting allows you to program the number of rings the system permits at a Hunt Group set before moving on to the next set in the Hunt Group.

1. Place the programming overlay on any M7310 or M7324 telephone.
2. Press * * (CONFIG). The display shows **Password:**
3. Press (SCPLUS). The display shows **Terminals#Sets.**
4. Press until the display shows **System programming.**
5. Press . The display shows **Hunt groups.**
6. Press . The display shows **Show group.**
7. Enter the Hunt Group number you want to program (1-30).

8. Press . The display shows **Member DNs:**.
9. Press until the display shows **Hunt delay**.
10. Press **CHANGE** to select the setting: **1, 2, 3, 4, 5, 6, 7, 8, 9, 10**.
11. Press to exit or to continue programming.

Programming busy line setting

A Hunt Group is considered busy if one of two scenarios exists:

- all of its members are being presented an incoming Hunt Group call
- all of its members are active on a Hunt Group call

There are three routing options if all members are busy:

- BusyTone—the caller gets a busy tone
 - Overflow—the call is routed to an overflow position
 - Queue—the call stays in the system for a period of time. Within this period of time, the call is presented to a member if one becomes available. When the time-out occurs, the call is presented to an overflow position.
1. Place the programming overlay on any M7310 or M7324 telephone.
 2. Press * * 2 6 6 3 4 4 (CONFIG). The display shows **Password:**.
 3. Press (SCPLUS). The display shows **Terminals:Sets**.
 4. Press until the display shows **System Programming**.
 5. Press . The display shows **Hunt Groups**.

6. Press . The display shows **Show group**.
7. Enter the Hunt Group number you want to program (1-30).
8. Press . The display shows **Member DNs:**.
9. Press until the display shows **If busy:**.
10. Press **CHANGE** to set the mode: **BusyTone, Overflow, Queue**.
11. Press to exit or to continue programming.

Programming the queue time-out

This setting allows you to program the number of seconds a call remains in the Hunt Group queue before it is routed to the overflow position.

1. Place the programming overlay on any M7310 or M7324 telephone.
2. Press * * 2 6 6 3 4 4 (CONFIG). The display shows **Password:**.
3. Press (SCPLUS). The display shows **Terminals#Sets**.
4. Press until the display shows **System programming**.
5. Press . The display shows **Hunt groups**.
6. Press . The display shows **Show group**.
7. Enter the Hunt Group number you want to program (1-30).
8. Press . The display shows **Member DNs:**.
9. Press until the display shows **Q Timeout:**.
10. Press **CHANGE** to set the queue time-out: **15, 30, 45, 60, 120, 180**.
11. Press to exit or to continue programming.

Programming the overflow set

This setting allows you to program the overflow set to which the Hunt Group calls are to be routed. Unless the overflow position is a Hunt Group set, the call ceases to be a Hunt Group call. If the overflow set is a Hunt Group set, the call is treated as a new call and goes to the bottom of the queue.

The overflow set can be a set DN number associated with a voice mailbox.

1. Place the programming overlay on any M7310 or M7324 telephone.
2. Press * * 2 6 6 3 4 4 (CONFIG).
The display shows **Password:**.
3. Press (SCPLUS). The display shows **Terminals:Sets.**
4. Press until the display shows **System Programming.**
5. Press . The display shows **Hunt Groups.**
6. Press . The display shows **Show Group.**
7. Enter the Hunt Group number you want to program (1-30).
8. Press . The display shows **Member DNs:**.
9. Press . The display shows **Overflow:**.
10. Press . The display shows **Overflow:HGr.**
11. Press **CHANGE** to change the overflow position.
12. Enter the new overflow position.
13. Press to exit or to continue programming.

Setting the name

This setting allows you to program the Hunt Group name, such as SERVICE or SALES. The name can be up to seven characters in length.

1. Place the programming overlay on any M7310 or M7324 telephone.
2. Press * * 2 6 6 3 4 4 (CONFIG). The display shows **Password:**.
3. Press (SCPLUS). The display shows **Terminals:Sets.**
4. Press until the display shows **System Programming.**
5. Press . The display shows **Hunt groups.**
6. Press . The display shows **Show group.**
7. Enter the Hunt Group number you want to program (1-30).
8. Press . The display shows **Member DNs:**.
9. Press . The display shows **Name:**.
10. Press **CHANGE**.
11. Using the dialpad, enter the name of the Hunt Group.
12. Press to store the name.
13. Press to exit or to continue programming.

Telephone features

Installing Norstar telephones

If you are connecting a Norstar telephone for the first time, refer to the illustrations below and use as a guideline.

Installing a Norstar telephone

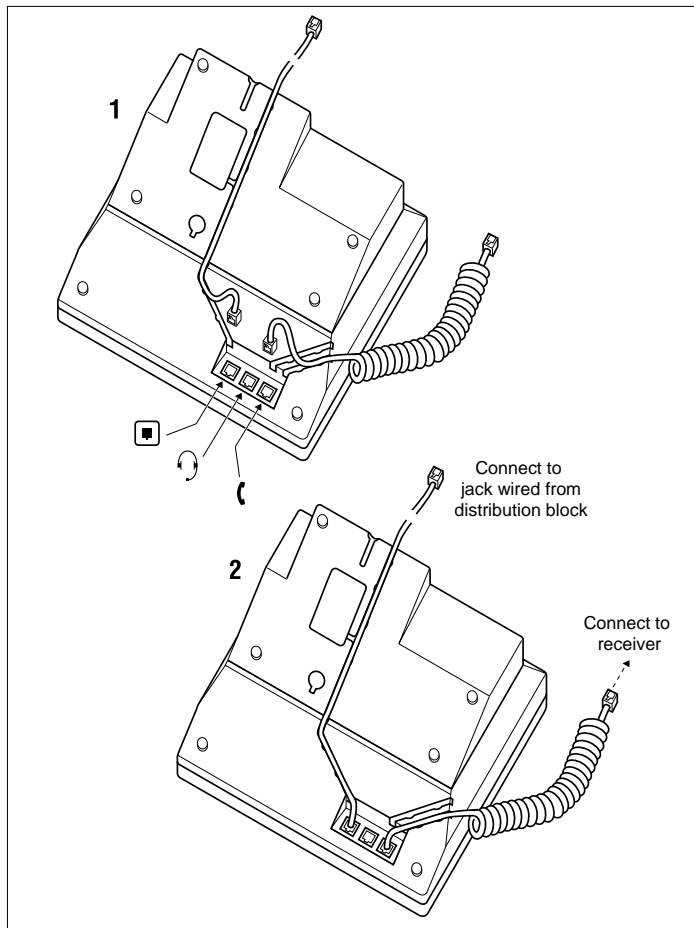

Mounting a Norstar telephone on the wall

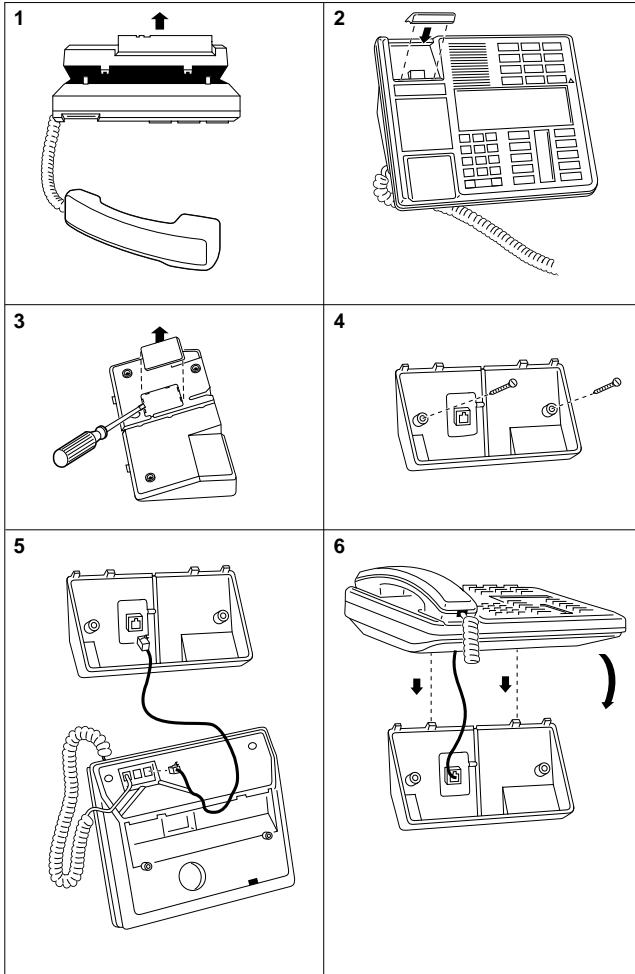

Naming a telephone or a line

You can assign names to identify external lines, target lines, and your co-workers' telephones. During a call, the name (if programmed) is shown on the telephone display instead of the external line number or internal telephone number of the caller. Step-by-step instructions for adding or changing the name of a telephone or a line are in "Changing the name of a telephone" on page 20.

Telephone names and line names can contain both letters and numbers, but cannot be longer than seven characters. You cannot use the # and * symbols.



Tip - *You can give the same name to two or more telephones, or to a telephone and a line in your system. To avoid confusion, avoid such duplication. Use initials, abbreviations, or even nicknames to give each telephone a unique name.*

If automatic telephone relocation is turned on, the name and internal number of a telephone are saved if the telephone is moved within your system.

Moving telephones



You may be required by law to report any telephone moves to your local telecommunications carrier or 911 service provider. For further details, consult your local carrier, your local 911 service provider, and/or your local telecommunications service provider.

If automatic telephone relocation is enabled in programming by your installer or customer service representative, you can move your telephone from one Norstar jack to another without losing any of its custom programming.

Stopping calls from ringing at your telephone using Do Not Disturb (DND)

Feature 8 5

Stopping calls

Press Feature 8 5 to stop calls from ringing at your telephone.

Only priority calls ring at your telephone. A line button flashes when you receive a call, but the call does not ring.

Refusing to answer a call

While you are on a call, you can refuse to answer a second call (including a priority call).

Press Feature 8 5 while your telephone is ringing.

Canceling Do Not Disturb

Feature # 8 5

Press Feature # 8 5 .

Displays

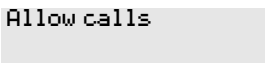
Allow calls

Your telephone receives calls normally.

Using Do Not Disturb

Once you turn Do Not Disturb on, calls are forwarded to the prime telephone only if there is no other telephone on which the line appears. If there is another telephone that shares the same line, the call may be answered by that person. (The Delayed Ring Transfer feature transfers all unanswered calls to the prime telephone after a specified time.)

Do Not Disturb prevents voice calls from alerting at your telephone. Voice calls are presented as normal intercom calls.



Tip - Norstar sets that are members of a Hunt Group can temporarily leave a Hunt Group by activating this feature. Hunt Group calls arriving while a set is in Do Not Disturb mode are routed to the next member in the Hunt Group. For more information on Hunt Groups see "Programming Hunt Groups" on page 135.

Using Background Music

Feature 8 6

Listen to music through your telephone speaker by pressing

Feature 8 6 .

Your installer or service representative makes this feature available to all telephones in programming. You need to supply a music source, such as a radio, and have it attached to your ICS.



In accordance with U.S. copyright law, a license may be required from the American Society of Composers, Authors and Publishers or a similar organization if radio or TV broadcasts are transmitted through the Background Music feature of this telecommunication system. Northern Telecom Inc. hereby disclaims any liability arising out of the failure to obtain such a license.

Turning Background Music off

The music stops automatically if you make or answer a call or if you press Feature # 8 6 .

ISDN PRI and BRI

Integrated Services Digital Network (ISDN) technology provides a fast, accurate and reliable means of sending and receiving data, image text and voice information through the telephone system.

By using Primary Rate Interface (PRI) or Basic Rate Interface (BRI), your ISDN service allows for faster transmission speeds and the addition of a variety of powerful business applications, including remote LAN access, videoconferencing, file transfer and Internet access.

Your installer configures your ISDN services and terminal equipment.

ISDN PRI

PRI is economical because separate analog trunks and data circuits are not needed for Direct Inward Dialing (DID), Direct Outward Dialing (DOD) and data transfer.

With PRI there is greater flexibility because B channels can be dynamically reconfigured to accommodate changes in traffic with the Call by Call feature. For more information see “Call by Call service selection for PRI” on page 156.

PRI offers fast information access because channel usage is optimized to allow you the full benefit of available bandwidth and real-time connectivity.

PRI lines are configured as DID lines. Incoming calls on a PRI line can appear on a DID button or on an intercom button depending on how your Norstar set has been configured. Outgoing calls are made from the intercom buttons.

PRI lines can be accessed from all devices such as Norstar sets, ISDN sets, and wireless sets.

ISDN PRI features

Selected ISDN network features can be used from a Norstar telephone. Your central office switch (ISDN network) determines which features are available to you.

Network Name Display for PRI

Your Norstar system displays the name of an incoming call when it is available from the service provider. Name information can be displayed on a Norstar set but not on an ISDN terminal. If the Calling Party Name has the status of “private” it may be displayed as “Private name”. If the Calling Party Name is unavailable it may be displayed as “Unknown name”.

Your Norstar system displays the name of the called party on an outgoing call, when it is provided by your service provider.

Your Norstar system sends the Business Name concatenated with the set name on an outgoing call but only after the Business Name has been programmed.

The available features include:

- Receiving Connected Name
- Receiving Calling Name
- Receiving Redirected Name
- Sending Connected Name
- Sending Calling Party Name

Consult your customer service representative to determine which of these features is compatible with your service provider.

Name and number blocking for PRI

When activated, allows you to block the outgoing name and/or number on a per-call basis. Name and number blocking can be used with a Norstar set but not with an ISDN terminal.

Consult your customer service representative to determine whether or not this feature is compatible with your provider.

Emergency 911 Dialing

Modular ICS 4.0 with the ISDN PRI feature is capable of transmitting the telephone number and internal extension number of a calling station dialing 911 to the Public Switched Telephone Network. State and local requirements for support of Emergency 911 Dialing service by Customer Premises Equipment vary. Consult your local telecommunications service provider regarding compliance with applicable laws and regulations.

If transmission of internal extension numbers is not required or desired, then it is recommended that the System Coordinator maintain a site map or location directory that allows emergency personnel to rapidly locate a Norstar set given its DID number. This list should be kept up to date and readily available, and can be included in the Programming Record.

2-way DID

With PRI the same lines can be used for receiving direct inward dialing (DID) and for making direct outward dialing (DOD) calls.

The dialing plan configured by your customer service representative determines how calls are routed.

Consult your customer service representative to determine whether or not this feature is compatible with your service provider.

Call by Call service selection for PRI

PRI lines can be dynamically allocated to different service types with the Call by Call feature. PRI lines do not have to be pre-allocated to a given service type.

Call types that may be available, depending on your service provider are:

Public

Public calls connect your Norstar set with a Central Office (CO). DID and DOD calls are supported.

Private

Private calls connect your Norstar set with a Virtual Private Network. DID and DOD calls are supported. A private dialing plan may be used.

Tie

Tie lines are private incoming and outgoing lines that connect Private Branch Exchanges (PBX) such as Norstar.

FX (Foreign Exchange)

FX calls connect your Norstar set to a remote CO. It provides the equivalent of local service at the distant exchange.

Outwats

Outwats is for outgoing calls. This allows you to originate calls to telephones in a specific geographical area called a zone or band. Typically a flat monthly fee is charged for this service.

Inwats

Inwats is a type of long distance service which allows you to receive calls originating within specified areas without a charge to the caller. A toll-free number is assigned to allow for reversed billing.

Consult your customer service representative to determine whether or not this feature is compatible with your provider.

Dialing Plan and PRI

The Dialing Plan supports PRI connectivity to public and private networks. The dialing plan is a collection of features responsible for processing and routing incoming and outgoing calls. All PRI calls must go through a dialing plan.

The Dialing Plan

- allows incoming calls to be routed to sets based on service type and digits received
- allows Enbloc dialing by buffering user-dialed digits until a complete DN has been dialed
- provides the ability to map user-dialed digits to a service type on a Call by Call basis
- allows long distance carrier selection via user-dialed Carrier Access Codes

Consult your customer service representative to determine how your dialing plan is configured.

ISDN BRI

Modular ICS 4.0 supports a maximum of 30 ISDN sets on the system.

The following ISDN services are supported:

- incoming calls
- outgoing calls
- Calling Line Identification Presentation
- Sub-addressing
- bearer capabilities
- teleservices

The Call Forward All Calls feature can be used from ISDN terminals connected to Modular ICS.

Note: Norstar sets can accept voice calls only. Video and data calls do not alert at a Norstar set.

Although an ISDN S-loop or LT-loop can support up to eight devices, the loop has a limit of two B-channels. If both B-channels are in use, other devices on that loop cannot make or receive calls until a B-channel is available, or until both B-channels are available in the case of a video terminal. Thus, the number of terminals installed must take into account whether you require dedicated access for the terminals on that loop.

Note: Norstar set features, other than Transfer and Call Forward All Calls, are not available to ISDN terminals. In addition, you cannot retrieve a parked call, or reach a Direct-Dial set by using the Direct-Dial digit from an ISDN terminal.

Line access from an ISDN terminal

ISDN terminals do not have line keys or intercom keys as do Norstar telephones. To make an outgoing call from an ISDN terminal, access an external line by entering a line pool code or by using the ARS feature.

ISDN BRI features

Selected ISDN network features can be used from a Norstar telephone. Your central office switch (ISDN network) determines which features are available to you.

Network Name Display for BRI

Your Norstar system displays the name of an incoming call when it is available from the service provider. Name information can be displayed on a Norstar set but not on an ISDN terminal. If the Calling Party Name has the status of “private” it may be displayed as “Private name”. If the Calling Party Name is unavailable it may be displayed as “Unknown name”.

Your Norstar system displays the name of the called party on an outgoing call, when it is provided by your service provider.

As with PRI, your Norstar system sends the Business Name concatenated with the set name on an outgoing call but only after the Business Name has been programmed.

The available features include:

- Receiving Connected Name
- Receiving Calling Name
- Receiving Redirected Name
- Sending Connected Name
- Sending Calling Party Name

Consult your customer service representative to determine whether or not this feature is compatible with your service provider.

Name and number blocking for BRI

When activated, allows you to block the outgoing name and/or number on a per-call basis. Name and number blocking can be used with a Norstar set but not with an ISDN terminal.

Consult your customer service representative to determine whether or not this feature is compatible with your service provider.

Service provider features

Consult your customer service representative to determine if the new ISDN features are supported with your service provider.

Call Forward

Call Forward allows you to forward your calls to an external telephone number.

1. Select an ISDN line by selecting a line button, a line pool, or the Handsfree button, or by lifting the handset (if an ISDN line is your prime line).
2. Consult your service provider for the appropriate feature code to enter on your dial pad. Listen for three tones followed by dial tone.
3. Enter the internal number of the telephone to which you want your calls forwarded. If the call is answered, stay on the line for at least five seconds to activate the Call Forward feature.

Canceling Call Forward

1. Select an ISDN line by selecting a line button, a line pool, or the Handsfree button, or by lifting the handset (if an ISDN line is your prime line).
2. Consult your service provider for the appropriate feature code to enter on your dial pad. Listen for a series of tones.
3. Press .

Calling the number your calls are forwarded to

1. Select an ISDN line by selecting a line button, a line pool, or the Handsfree button, or by lifting the handset (if an ISDN line is your prime line).
2. Consult your service provider for the appropriate feature code to enter on your dial pad.

Automatic Call Back

If you call a number and it is busy, enter the appropriate feature code designated by your service provider to receive a distinctive ring at your set when the line becomes available for calls.

Automatic Recall

Automatic Recall allows you to automatically dial the number of the last call you received. You may not see the number on the display if the information is not available from your service provider, or you do not have Caller ID as part of your ISDN service.

Consult your service provider for the appropriate feature code to enter on your dial pad.

ISDN BRI terminals

Your Modular ICS allows connection of eight Basic Rate Access loops (four 2B+D channels) that can be used for fully digital connections to ISDN networks and devices. Loops are connections between the ICS and devices or between the ICS and the network.

Each loop provides two separate B-channels that can be used to make two simultaneous voice or data calls, or one data call and one voice call.

ISDN applications for BRI and PRI

ISDN terminal equipment delivers a wide range of powerful business applications:

Videoconferencing and video telephony

Video conferencing offers instant visual and audio contact between distant parties using either studio-based or desktop ISDN terminals.

Desktop conferencing

ISDN allows computer users in distant locations to share and edit any image, data or text file on their own computer screens while they discuss the information.

File transfer

The ISDN network allows you to transfer files containing data, text, images, data, or audio clips, faster and cheaper than with a conventional modem.

Telecommuting

Convenient retrieval, processing and storage of files is possible for the employee working at home by using ISDN lines to give high-speed access to information resources at the office.

Group 4 fax

ISDN fax applications save money by increasing both transmission speed and the quality of resolution.

Remote LAN access

ISDN provides an affordable and fast means for employees at remote sites (at home or branch offices) to access local area networks (LANs).

Leased line backup

Essential backup for leased lines can be provided using ISDN as required, rather than duplicating costly permanent leased lines.

LAN to LAN bridging

Local area network (LAN) bridge/routers allow flexible interconnection between LANs using ISDN, with charges incurred only when information is actually transmitted.

Internet and database access

The fast call set up and high bandwidth of ISDN are ideal for accessing information services such as the Internet and databases.

Using System features

Using alternate or scheduled services

There are three types of Services to make your Norstar system handle calls differently on different days and at different times of the day: Ringing service, Restriction service and Routing service.

Each of the three services, and the six schedules available to each service, are customized for you by your installer or customer service representative. They program which telephone is used to turn Services on and off, and display what Services are in use. This is called the control telephone.

Preventing certain calls from being made

Restriction service prevents a user from making certain kinds of calls from a telephone or from lines that are available at the telephone. The restrictions are programmed by your installer or customer service representative.

Making additional telephones ring

Ringing service makes additional telephones ring for incoming calls on external lines. For instance, all incoming external calls can ring at a security guard's telephone during the night, or calls to one attendant can ring at another attendant's telephone during lunch. It does not suppress your normal ringing assignment.

Changing the lines used by outgoing calls

Routing service allows you to assign alternate routes to calls. In this way you can take advantage of lower costs available on particular routes on certain days and at certain times. Both the regular and alternate routes are programmed by your installer or customer service representative.

Turning Services on and off

The master control for how different services and their schedules are used by your system is in programming. There are three settings: Manual, Automatic and Off.

- Manual allows you to turn the service on and off at any time from a control telephone using a feature code.
- Automatic allows you to use the preassigned stop and start time for a service. You are able to start and stop the service by entering the appropriate feature code at a control telephone. If you select this setting, you use the start and stop times programmed by your installer or customer service representative.
- Off prevents the service from being activated.

You need the programming template found at the front of this guide. See “Getting started with Norstar” on page 1 for more information.

1. Press * * 2 6 6 3 4 4 .
2. Press 2 3 6 4 6 (the default System Coordinator password).
3. Press twice.
4. Press at **Services**.
5. Press until you see the Service you want to program.
6. Press and until you see the schedule you want to program.
7. Press and use **CHANGE** to select the setting that works best for your office: **Off**, **Manual** or **Automatic**.

Each schedule can have its own configuration of a Service which works independently of automatic start and stop times.

For example, there may be a version of Restriction service called Night Schedule that prevents anyone from making long distance calls. But calling it Night Schedule does not mean it can only be used with a schedule. You can turn the Night Schedule for Restriction Service on or off as needed any time of the day or night. If you decide to run a service on a schedule, the system uses the start and stop times used for that schedule.

An example of how to turn on a Service manually

You may have Ringing service (your night service) set up to run according to the Night Schedule. You may decide you want that ringing arrangement to come into effect only when it is turned on and off manually.

You need the programming template found at the front of this guide. See “Getting started with Norstar” on page 1 for more information.

1. Press * * 2 6 6 3 4 4 .
2. Press (the default System Coordinator password).
3. Press twice.
4. Press at **Services**. The display reads **Ringing Service▶**.
5. Press . The display reads **Sched:Night▶**.
6. Press and use **CHANGE** to set the Service to **Manual**.

Night Schedule for Ringing Service no longer follows the schedule but can be turned on and off by using the feature code and selecting Night Ringing. See “Turning Services on and off using feature codes” on page 168.

Turning Services on and off using feature codes

The master control for services is in programming. See “Turning Services on and off” on page 166. Day-to-day use of Services is controlled using the following feature codes.

Feature

Turns on Ringing service. When used at the direct-dial telephone, it activates the alternate direct-dial telephone (extra-dial telephone).

Feature

Turns off Ringing service.

Feature

Turns on Restriction service.

Feature

Turns off Restriction service.

Feature

Turns on Routing service.

Feature

Turns off Routing service.

To turn a Service on:

1. Enter the appropriate feature code from a control telephone.
2. For Restriction and Routing service you have to enter the System Coordinator or Basic password.
3. Press **NEXT** to move through the schedules until the display shows the version of the service you want to be turned on.
4. Press **OK** to select the setting, or press **QUIT** to exit the feature without making any changes.

To turn a Service off:

1. Enter the appropriate feature code from a control telephone.
2. For Restriction and Routing service you have to enter the System Coordinator or Basic password.



Do not confuse activating Normal service with canceling a Service.

Setting a Service to Normal is not the same as canceling a Service using a feature code. If you set the Service to Normal, the normal version of a Service overrides any automatic schedule and remains in effect until you manually cancel it. If you cancel the Service, you return to the automatic schedule.

Viewing the active Services from a two-line display telephone

When a Service is active, the control telephone display reads **Services ON**.

1. Press **LIST**. The display shows the first active Service and the schedule that is in use.
2. If there are several active Services, press **NEXT** to see them all.
3. Press **EXIT** to exit the feature.

Viewing the active Services from a one-line display telephone

1. Press **Feature** **8** **7** **0**. The display shows the first active Service.
2. Press **#** to move through the active schedule.
3. Press **Rls** to exit.

Displays

```
<Sched> Restr'n
EXIT          NEXT
```

You are viewing the active Services. Press **#** or **NEXT** to see the other active Services. Press **Rls** or **EXIT** to quit.

```
<Sched> Restr'n
QUIT   OK   NEXT
```

The name of the current Restriction service schedule is displayed. Press **#** or **NEXT** to see the other Ringing service schedules. Press **Hold** or **OK** to select the desired schedule.

```
<Sched> Ringing
EXIT          NEXT
```

You are viewing the active Services. Press **#** or **NEXT** to see the other active Services. Press **Rls** or **EXIT** to quit.

```
<Sched> Ringing
QUIT   OK   NEXT
```

The name of the current Ringing service schedule is displayed. Press **#** or **NEXT** to see the other Ringing service schedules. Press **Hold** or **OK** to select the desired schedule.

```
<Sched> Routing
EXIT          NEXT
```

You are viewing the active Services. Press **#** or **NEXT** to see the other active Services. Press **Rls** or **EXIT** to quit.

```
<Sched> Routing
QUIT   OK   NEXT
```

The name of the current Routing service schedule is displayed. Press **#** or **NEXT** to see the other Routing service schedules. Press **Hold** or **OK** to select the desired schedule.

```
<Sched> until *
QUIT   OK   NEXT
```

Press **Hold** or **OK** to select this schedule, **#** or **NEXT** to see the next available schedule, or **Rls** or **QUIT** to exit. If you select this schedule, it is in effect until the next automatic schedule takes effect.

```
No services ON
```

You have entered the Show Services feature code and there is no active Service.

```
Services      ON
              LIST
```

There is a Service active in your system. Press ***** or **LIST** to view the active Services.

For other displays, see "Common feature displays" on page 203.

Services that have been turned on automatically are indicated by an asterisk (*) before the name on the display. You can neither manually activate nor cancel scheduled services, although you can override them by manually turning on another schedule.

The control telephone can override Services that are turned on and off according to a schedule at any time by entering a Services feature code, and selecting a different schedule. This override remains in effect until it is canceled. If you select a schedule with an asterisk (*), the next automatic service schedule comes into effect at the programmed time.

Direct-dial calls to a direct-dial telephone ring at the extra-dial telephone (the extra-dial telephone is designated by your installer or customer service representative) only when you enter the Ringing service feature code () at that direct-dial telephone. Note that only the extra-dial telephone is activated, not the actual Ringing service (unless that direct-dial telephone is a control telephone).



Tip - *Norstar provides six service schedules named Night, Lunch, Evening, Sched 4, Sched 5, and Sched 6. Your installer or customer service representative can change these names to suit your business.*

Using passwords

Your passwords prevent unauthorized or unintentional changes to your Norstar system. To keep your telephone service secure, distribute the password only to selected personnel or make use of the basic password described below. Record your password in a secure place and change it periodically.

If you forget the administration or basic passwords, you cannot do any programming. Call your customer service representative to assign a new password.

The password is a one to six-digit number. It is advised to make your password at least six digits long for security reasons. If you press **CHANGE** but do not enter a new password, the existing password is erased. Anyone can then access programming without a password.

The default System Coordinator password is **A D M I N**, which is the same as **2 3 6 4 6**.

One password cannot be a subset of another one. For example, you cannot have 123 and 12345.

Using a Basic password

In addition to a System Coordinator password, there is a Basic password. This allows you to delegate some of the duties of being a system coordinator to someone else without allowing access to sensitive programming.

The default Basic password is **B A S I C** or **2 2 7 4 2**.

You can enter the Basic password after the following feature codes:

- **Feature** * * **U S E R** (User Preferences)
- **Feature** * * **T I M E** (to change the system time and date)

Because the Basic password can be used to change the time, you should give it out with care and change it when necessary (for example, when an employee leaves the company). If restrictions, routing or other services operate on a schedule, changing the time can allow someone to bypass the programming.

Registration password

The Registration password is used to control the registration of Companion portables to the Norstar system. See the *MICS-XC Norstar-Companion System Coordinator Guide* for more information.

Changing passwords

You need the programming template found at the front of this guide. See “Getting started with Norstar” on page 1 for more information.

1. Press * * 2 6 6 3 4 4 .
2. Press (the default System Coordinator password).
3. Press four times.
4. Press at **Passwords**.
5. Press until you see **Programing Pswds** ▶.
6. Press .
7. Press until you see the name of the password you want to change.
8. Use , **CHANGE** and the dial pad to enter the new password. Press **OK** to accept the new password.

You cannot erase or eliminate the ability to program passwords.

Clearing a Call Log password

If an individual has forgotten their Call Log password, you can clear it in programming. The individual can then enter a new password from his or her telephone.

You need the programming template found at the front of this guide. See “Getting started with Norstar” on page 1 for more information.

1. Press * * 2 6 6 3 4 4 .
2. Press (the default System Coordinator password).
3. Press four times.
4. Press at **Passwords**.
5. Press until the display reads **Call log Pswds**.
6. Press and enter the internal telephone number of the telephone where you want to clear the Call Log password.
7. Press , then press **CLR** to clear the password.

Using special telephones

Direct-dial

You can reach the direct-dial telephone by dialing a single digit. The direct-dial telephone is usually in a central location, such as a attendant’s desk. You can have up to five direct-dial telephones for your Norstar system. It is usually the prime telephone or the central answering position (CAP).

The direct-dial telephone can send up to 30 messages and can invoke Services to activate the extra-dial telephone.

You cannot forward calls to a direct-dial telephone that is outside your Norstar system. See “Making changes to Call Forward No Answer” on page 23.

Note: ISDN terminals cannot use the Direct-Dial digit to reach a Direct-Dial set.

Changing the direct-dial telephone assignments

Your installer or customer service representative sets up the direct-dial telephone.

You can change which direct-dial telephone a telephone is assigned to, or assign it no direct-dial telephone.

You need the programming template found at the front of this guide. See “Getting started with Norstar” on page 1 for more information.

1. Press * * 2 6 6 3 4 4 .
2. Press (the default System Coordinator password).
3. Press at **Terminals#Sets**.
4. Enter the internal number of the telephone you want to program and press . The display reads **Capabilities**.
5. Press .
6. Press until the display reads **D-Dial**.
7. Press **CHANGE** to select **Set1, Set2, Set3, Set4, Set5** or **None**.

Any number of telephones can be assigned to call the direct-dial telephone.



Tip - *The digit you dial in order to get the direct-dial telephone to ring can be programmed by your installer or customer service representative.*

The Norstar system cannot verify that the number you assign as an external direct-dial telephone is valid. Check the number before assigning it as a direct-dial telephone, and call the direct-dial telephone after you've assigned it in order to test it.

Hotline

A hotline telephone calls a preset internal or external telephone number when you pick up the receiver (or press ).



Tip - *Label the telephone to inform anyone using it that Hotline is active.*

Bypassing a Hotline

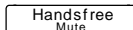
Press a line button, or use the Pre-Dial or Automatic Dial feature before you pick up the receiver or press  on a hotline telephone. See the *Telephone Feature Card* or see “Changing how you dial your calls” on page 57.

Making a telephone a hotline telephone

You can set up a telephone as a hotline.



Tip - A Hunt Group set DN can be specified as a Hotline telephone. For more information on Hunt Groups see "Programming Hunt Groups" on page 135.

You need the programming template found at the front of this guide. See "Getting started with Norstar" on page 1 for more information.

1. Press * * 2 6 6 3 4 4 .
2. Press (the default System Coordinator password).
3. Press at **Terminals#Sets**.
4. Enter the internal number of the telephone you want to program and press . The display reads **Capabilities**.
5. Press .
6. Press until the display reads **Hotline**.
7. Press **CHANGE** to select the type of call the hotline makes: **None**, **Intrnl**, or **Extrnl**.

Internl assigns an internal number.

External assigns an external number. If you select an external number, you can select the line on which the call is made: the prime line, an external line, a line in a line pool, or a line selected by the routing table. If you select a line pool, you must specify the line pool access code. If you select the routing table, the number dialed is treated as a destination code and is routed according to the routing tables.

A telephone's prime line, line pool access codes, and access to a line pool can be programmed by your installer or customer service representative.

Control telephone

The control telephone allows you to place the telephones and external lines for which it has responsibility into and out of service schedules. See "Using alternate or scheduled services" on page 165.

Using Set lock

Set lock limits the ways in which you can customize your telephone. There are three levels of Set Lock: Full, Partial, and None. None allows you to access all features on your telephone.

Partial prevents:

- | | |
|--|---|
| <ul style="list-style-type: none"> • programming autodial buttons • programming user speed dial numbers • programming feature buttons • moving line buttons • changing the display language | <ul style="list-style-type: none"> • changing dialing modes (Automatic Dial, Pre-Dial, and Standard Dial) • using Voice Call Deny • saving a number with Saved Number Redial |
|--|---|

Full, in addition to the restrictions outlined for Partial lock, prevents:

- | | |
|--|---|
| <ul style="list-style-type: none"> • changing Background Music • changing Privacy • changing Do Not Disturb • using Ring Again | <ul style="list-style-type: none"> • using Call Forward all calls • using Send Message • using Trunk Answer • activating Services |
|--|---|

Changing Set Lock programming for a telephone

You need the programming template found at the front of this guide. See “Getting started with Norstar” on page 1 for more information.

1. Press * * 2 6 6 3 4 4 .
2. Press (the default System Coordinator password).
3. Press at **Terminals#Sets** and enter the internal number of the telephone you want to program.
4. Press .
5. Press until the display reads **Restrictions**.
6. Press twice.
7. Press until the display reads **Set lock**.
8. Use **CHANGE** to select one of the three options: **None**, **Partial** and **Full**.

Using an auxiliary ringer

An auxiliary ringer is a separate device that has to be connected to Norstar.

Turning the auxiliary ringer for a telephone on or off

You need the programming template found at the front of this guide. See “Getting started with Norstar” on page 1 for more information.

1. Press * * 2 6 6 3 4 4 .
2. Press (the default System Coordinator password).
3. Press at **Terminals#Sets**.

4. Enter the internal number of the telephone you want to program and press . The display reads **Capabilities**.
5. Press .
6. Press until the display reads **Aux. ringer**.
7. Use **CHANGE** to select **Y** (Yes) or **N** (No).

Your installer or customer service representative can program the auxiliary ringer to start ringing for incoming lines as part of Ringing Service.

Using Host System dialing signals

You can access host systems, such as private branch exchanges (PBX) from Norstar by using host system signaling features (known as end-to-end signaling). These features either send a special signal to the host system or allow you to program delays required by host systems in external autodial or speed dial sequences.

Link

If your Norstar system is connected to a private branch exchange (PBX), you can use a Link signal to access special features. On some telephones, Link is called FLASH.

The Link signal can be included as part of a longer stored sequence on an external autodial button or in a speed dial code. The Link symbol (**☐☐**) uses two of the 24 spaces in a dialing sequence.

Preventing a telephone from using Link

Link can be restricted at individual telephones. You need the programming template found at the front of this guide. See “Getting started with Norstar” on page 1 for more information.

1. Press * * 2 6 6 3 4 4 .
2. Press (the default System Coordinator password).
3. Press and enter the internal number of the telephone you want to program.
4. Press .
5. Press three times. The display reads **Restrictions.**
6. Press twice.
7. Press three times. The display reads **Allow link.**
8. Press **CHANGE** to choose Y (Yes) or N (No).



Tip - If your Norstar system is connected to a private branch exchange (PBX), program Link onto a memory button for one-touch access.

Pause

The Pause feature enters a 1.5 second delay in a dialing sequence on an external line. This is often required for signaling remote devices, such as answering machines, or when reaching through to PBX features or host systems.

You can program more than one pause in an external autodial or speed dial sequence.

The Pause symbol (⏸) uses one of the 24 spaces in a dialing sequence.

For pulse dialing, [*] inserts a 1.5 second pause into the dialing sequence.

Long Tones

Feature [8] [0] [8]

The Long Tones feature allows you to control the length of a tone so that you can signal devices such as fax or answering machines which require tones longer than the standard 120 milliseconds.

1. While on a call, press Feature [8] [0] [8] .
2. Press the dial pad buttons to produce the appropriate tones. Each tone sounds for as long as you hold down the button.

Long tones can be used on any call except a conference call. You can use internal lines of the Norstar system to activate a device connected to an analog terminal adapter (ATA) in another area of your office, or external lines to access devices outside the Norstar system.

Displays

Long Tones:

At the appropriate time, press any dial pad button. Hold each button down for as long as necessary. Press Feature [8] [0] [8] or Hold [8] to cancel Long Tones.

Programmed Release

Feature * 8 9

The Programmed Release feature performs same function as Rls in a programmed dialing sequence. When the system encounters Programmed Release in a dialing sequence, it stops dialing and hangs up the call.

The Programmed Release symbol () takes up two of the 24 spaces in a programmed dialing sequence.

The system ignores any digits or commands that follow a Programmed Release in a programmed dialing sequence.

Run/Stop

Feature * 9

Run/Stop inserts a break point into a sequence of dialed numbers or characters used for automatic dialing. This may be necessary when you are connecting to a PBX or similar host system.

For example, you can call a company with an automated attendant that instructs you to dial the internal number you need. You can program the company number, a Run/Stop, then the internal number on one external autodial button. Press the autodial button once to dial the company number. When you hear the automated attendant, press the autodial button again to dial the internal number.

The Run/Stop symbol () uses one of the 24 spaces in an autodial or speed dial sequence.

You can include up to three Run/Stop commands in a dialing string. The system ignores a fourth Run/Stop, and any digits or commands that follow it in a programmed dialing sequence.

Wait for Dial Tone

Feature

Wait for Dial Tone causes a sequence of numbers to pause until dial tone is present on the line before continuing to dial. This is useful if you must dial a remote system and then wait for dial tone from that system before dialing the rest of your number.

The Wait for Dial Tone symbol (**85**) uses two of the 24 spaces in an autodial or speed dial sequence.

Displays

Invalid code

You have entered a code that can be used only in a programmed autodial or speed dial sequence, not on a call you dial directly. Programmed Release and Run/Stop are for use in programmed dialing sequences only.

Using pulse dialing for a call

If your external telephone lines use pulse dialing, you can temporarily switch to tone dialing by pressing after selecting the line. Tone dialing allows your Norstar telephone communicate with devices and services that respond to tone signals, such as automatic switchboards, and fax or answering machines.

Using your Norstar system from an external location

You can use the lines and some of the features of a Norstar system from outside the system. You can do this over the public telephone network when you are away from the office, or you can call from another system, over a private network.

An example of how remote access works is a sales representative who spends a lot of time out of the office needs to make long distance calls to the European office. Your Norstar system has a leased line to Europe with reduced

transatlantic charges. You provide the sales representative with a Class of Service password that gives access to the transatlantic line. The sales representative can then telephone into the Norstar system from a hotel, enter their Class of Service password, and use the leased transatlantic line to make calls.

Remote users can access Norstar lines, line pools, the page feature, and remote administration (if enabled through Software Keys). The exact facilities available to you through remote access vary depending on how your installer or customer service representative set up your system.



Tip - *If the loop start line used for remote access is not supervised, auto-answer does not function and the caller hears ringing instead of a stuttered tone or the system dial tone.*

Controlling access to your Norstar system

It is important to maintain the security of your Norstar system by limiting access to authorized users and limiting those users to the features they need.



Remote users can make long distance calls.

Remember that a remote user can make long distance calls that are charged to your company and can make page announcements in your office.

Direct inward system access (DISA)

Control access to your Norstar system with direct inward system access (DISA). Access to your Norstar system from the public telephone network should always be controlled with DISA. If your installer or customer service representative programs the line used for remote access to answer a call automatically and wait for a DISA internal number, callers

hear a stuttered dial tone and must enter a Class of Service password before they are allowed into the system.

Class of Service (COS)

To control the level of telephone service a remote user can access, your installer can assign a remote filter and remote package to the line used for remote access. The remote filter restricts the numbers that can be dialed on the line, and the remote package restricts the use of line pools and the page feature. To change the restrictions for the line, the user can enter their Class of Service (COS) password when the system answers with DISA, or can dial the DISA internal number and enter their Class of Service password.

Maintaining security

To maintain the security of your system, the following practices are recommended:

- Warn anyone to whom you give the remote access number, to keep it confidential.
- Change Class of Service passwords often.
- Warn anyone to whom you give a Class of Service password, to remember it and not to write it down.
- Remove the Class of Service password of anyone who leaves your company.

Accessing Norstar remotely over the public network

1. Dial the Norstar system's remote access number.
2. When you hear a stuttered dial tone, enter your COS password.
3. Wait for the system dial tone.

To use the system remotely, you must use a telephone with tone dialing to call the system.

Remote access is possible only on lines that your installer or customer service representative programs to auto-answer calls.

To use features on a remote Norstar system, press followed by the feature code. Even if you are calling from a Norstar system, press instead of .

In certain situations, you may experience lower volume levels when using Norstar remotely.

Tones

You may hear some of the following tones while accessing Norstar remotely.

| Tone | What it means |
|--------------------------|--|
| Busy tone | Dialed a busy line pool access code. You hear system dial tone again after 5 seconds. |
| Norstar system dial tone | You may use the Norstar remotely. |
| Fast busy tone | You have done one of the following <ul style="list-style-type: none"> • Entered an incorrect COS password. Your call is disconnected after five seconds. • Taken too long while entering a COS password. Your call is disconnected after five seconds. • Tried to use a line pool or feature not permitted by your Class of Service. You hear system dial tone again after five seconds. • Dialed a number in the Norstar system which does not exist. Your call is disconnected after five seconds. |
| Stuttered dial tone | Enter your COS password. |

Using Class of Service (COS) passwords

Class of Service passwords permit controlled access to a system's resources both by internal and remote users. When you enter a Class of Service password at a telephone, the restriction filters associated with your Class of Service

password apply, rather than the normal restriction filters. Similarly, when a remote user enters a Class of Service password on an incoming auto-answer line, the restriction filters and remote package associated with their Class of Service password apply, rather than the normal restriction filters and remote package. COS passwords are programmed by either your customer service representative or installer.

Users should memorize their COS passwords instead of writing them down. Employees' COS passwords should be deleted when they leave the company. Typically, each user has a separate password. Several users can share a password or one user can have several passwords.

Changing your Class of Service

Feature 6 8

You must enter a Class of Service password each time you want to make a call that is normally restricted on a line or telephone.

To change the restriction filters on a line or telephone:

1. Press Feature 6 8.
2. Enter your six-digit COS password.

COS passwords allow you to define individual passwords and determine the restriction filters, and remote package associated with each.



Tip - *If you use your Norstar system from outside the office, you may have to enter a Class of Service password to gain access to the system. See "Using your Norstar system from an external location" on page 184.*

Displays



(Blank display) Enter your password. It is not shown on the display.

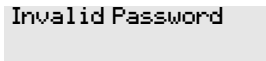

You have entered a password that is not programmed into your system.

Programming Automatic Time and Date

You can program your Norstar system with the Automatic Time and Date feature to automatically update the time and date.

Whenever the clock is out of sync by more than two minutes, as a result of a power failure or a loss of power, the first incoming call updates the clock automatically after two rings.

Note: CLASS Trunks are required for this feature to work. Consult your customer service representative to determine if you have CLASS Trunks.

This feature also allows the automatic changing between North American daylight savings and standard time. Your system uses the time and date information from the first incoming call after two rings to update to daylight savings or standard time.

The Automatic Time and Date feature automatically overrides any manually programmed changes to the time and date in your system.

Note: The year is not included with the time and date information and must be programmed manually if the current year differs from the network time.

1. Place the programming overlay on any M7310 or M7324 telephone.
2. Press * * 2 6 6 3 4 4 (CONFIG).
The display shows **Password:**.

3. Press (SCPLUS). The display shows **Terminals#Sets.**
4. Press until the display shows **System programming.**
5. Press . The display shows **Change DNS.**
6. Press . The display shows **Featr settings.**
7. Press . The display shows **Back9rnd music:.**
8. Press until the display shows **AutoTime#Date.**
9. Press **CHANGE** to choose Y (Yes) or N (No).
10. Press to exit or to continue programming.

General System features

The following features are available for the entire Norstar system.

Set profile

Set profile allows you to view but not change the programming settings for each Norstar set. You can access Set Profile from any M7310 or M7324 telephone, even while you are on a call.

1. Press * * S E T .
2. Enter the internal number of the telephone whose programming you want to review.
3. Use BACK, SHOW and NEXT to navigate through the settings.

Line profile

Line profile allows you to view but not change the programming settings for each Norstar line. You can access Line Profile from any M7310 or M7324 telephone, even while you are on a call.

1. Press * * L I N E .
2. Enter the number of the line whose programming you want to review.
3. Use BACK, SHOW and NEXT to navigate through the settings.

Pulse or tone dialing

If your external lines use pulse dialing, you can switch temporarily to tone dialing to communicate with devices such as answering machines, to access the features that PBX systems may offer, or to use another Norstar system remotely.

Press while on an active line. Once you hang up, your telephone returns to pulse dialing.

Disconnect supervision

When Disconnect Supervision is assigned to a line, the Norstar system monitors it to detect if an external caller hangs up. This allows the system to release the line for other uses. Your installer or customer service representative assigns disconnect supervision.

Hunt Groups

Your Norstar system now allows you to establish Hunt Groups in your system. Hunt Groups are a group of Norstar sets that can be called by a single directory number. The Hunt Groups feature ensures calls are easily routed to the appropriate people. For more information on Hunt Groups see “Programming Hunt Groups” on page 135.

Internal numbers

Each telephone in the Norstar system has its own internal number. The length of internal numbers in your system can be from two to seven digits on a non-expanded system, and three to seven digits on an expanded system. All numbers in your system are the same length. Your installer or customer service representative sets the length of internal numbers (called the DN length). The default DN length is three.

To find out your internal number, use the Button Inquiry feature (*) on an intercom button. On the M7100 telephone, Button Inquiry shows your internal number followed by the function assigned to your single-memory button.

Line assignment

Any of the lines in your system can be assigned to any of your telephones. Your installer or customer service representative assigns lines to telephones in Configuration programming.

Lines can be assigned to appear only, appear and ring, or to ring only.

Usually, only the lines that are appropriate for a particular person appear at that person's telephone. When a line is assigned to a telephone it is automatically given a line button on that telephone, if a button is available. The M7100 telephone has no line buttons for its lines.

Calls on lines that ring but do not appear at a telephone are presented at an intercom button.

You may be able to answer a call on a line that does not appear or ring at your telephone. To pick up such a call, use Call Pickup, Call Park, or Trunk Answer.

A telephone may have buttons assigned for lines 001 to 003, but have only lines 001 and 002 programmed to ring as well. An incoming call on any of the three lines causes a line button indicator to flash, and the telephone can be used to answer the call. This is especially useful for people who monitor other telephone lines, but want only their own lines to ring.

Target line

A target line is used to route a call directly to a particular telephone or group of telephones. Target lines are used only for incoming calls. A single incoming line may provide connections to several different target lines. This allows each person or department in the office to have their own number without having a separate external line for each number.



Tip - *The maximum number of target lines available in the fully expanded XC system is 192, and 128 on a DR 3.0 system.*

Line pools

A line pool allows each telephone access to external lines from a group (or pool) of external lines. You can access such lines by pressing an intercom button and entering a line pool access code or by pressing a memory button programmed with the line pool feature code and a line pool access code.

Overflow call routing

If a call comes in for a target line that is busy, Norstar routes the call to the prime telephone for that target line. If there is no prime telephone assigned to the target line or if a call cannot be directed to a target line, the call goes to the prime telephone for the external line used.

Overflow routing for incoming calls is used with the Routing Service programmed by your installer. A Service must be active for overflow routing to be in effect. Overflow routing is not available in normal service.



Tips - *When you make a call and the programmed route is busy, you hear the expensive route warning tone and see a display indicating that an expensive route is being used. To avoid using the normal, expensive route, release your call.*

Because overflow routing directs calls using different line pools, a call may be affected by different line filters when it is handled by overflow routing.

M7100 telephone

Because the M7100 telephone does not have line buttons, it sometimes works slightly differently from other Norstar telephones. Where other telephones can require that you select a line button to answer a call, on the M7100 telephone you simply pick up the receiver. Where other telephones require

you to select a line button to take a call off hold, you press  on the M7100 telephone.

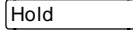
On M7100 telephones, you can answer a second call by pressing . Your active call is put on hold and you are connected to the waiting call. You can have no more than two calls at a time.

The M7100 telephone cannot have a  button. When applicable, special instructions for the M7100 telephone are included with each feature description.



Memory buttons

Memory buttons are the buttons with indicators on the M7208, M7310, and M7324 telephones, and the dual buttons without indicators on the M7310 telephone. There is a single memory button, without an indicator, on the M7100 telephone.

Memory buttons can be used as answer, autodial, line, and programmed feature buttons. Line, intercom and answer buttons must have indicators.









One-line display

The M7100 and M7208 telephones have a one-line display. Other Norstar telephones have a second line on the display which shows the functions of the three buttons directly below it.

Some display buttons, such as TRANSFER and ALL, are simply shortcuts which are not available on a one-line display.

Other display buttons, such as OK and SHOW, perform essential functions. For a one-line display telephone, use the following buttons instead of these display buttons.

Substitutes for display buttons

| Display button | Dial pad button |
|-----------------|--|
| <u>OK</u> | Hold  |
| <u>QUIT</u> | Rls  |
| <u>ADD</u> | *  |
| <u>SHOW</u> | #  |
| <u>CANCEL</u> | #  |
| <u>VIEW</u> | #  |
| <u>OVERRIDE</u> | #  |
| <u>BKSP</u> |  |

All displays listed in this book are shown as they appear on the two-line display.

Prime line

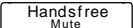
Your telephone can be programmed to select an internal or external line or a line pool automatically whenever you lift the receiver or press . This is your prime line.

Private lines

A private line is exclusive to a particular telephone. Calls that are put on hold or left unanswered on a private line cannot be picked up at any telephone except the prime telephone.

Volume bar

The volume bar controls the volume of the receiver, telephone ringer, handsfree speaker, and headset. Press either end of the volume bar  to adjust the volume.

Wall mounting

Norstar telephones can be mounted on a wall. Contact the installer or customer service representative if you want to have any telephones in your system wall-mounted.

Troubleshooting

Using the alarm telephone

An alarm telephone displays Norstar's system alarm codes, should they occur. It is a Norstar telephone with a two-line display (M7310 or M7324 telephones) that the installer or customer service representative has assigned as an alarm telephone.

Reporting and recording alarm codes

If an alarm message appears on the alarm telephone's display:

1. Record the alarm number.
2. Press **TIME** and record the time displayed.
3. Call your installer or customer service representative and report the alarm code.
4. After speaking to your installer or customer service representative, press **CLEAR**.

Displays

| | |
|--------|--------|
| Alarm: | 61-4-2 |
| TIME | CLEAR |

Report this alarm and the time it occurred to your installer or customer service representative.

Testing the telephone

If you suspect something is wrong with a button, the speaker, the displays, or some other part of the Norstar telephone hardware, you can do a quick test to see which part of the telephone is broken.



Tip - Ensure that the function of a button matches its label by pressing * 0 and then the button to see its function.

You can end the telephone testing session anytime by pressing or unless you are testing those buttons. The test feature times-out after 30 minutes of no activity.

Testing the telephone display

Use a display test if you suspect that one of the indicators on the telephone is not working.

1. Press 8 0 5 . The display reads **Display test.**
2. Press **TEST** or to go ahead with a display test.
3. Adjust the contrast for the telephone display so you are able to see the test results clearly. Enter a number to change the contrast or press **DOWN** and **UP**.
4. Press **OK** or to go ahead with the test.

During the test, the display should be filled with solid, dark blocks and all the indicators next to the buttons on the telephone should be turned on. Any Busy Lamp Field (BLF) or CAP modules that are attached to the telephone should be completely lit. You lose any information that was showing on the BLF before the test started.

Pressing any button ends the test.

Testing the telephone buttons

1. Press 8 0 5 , then # or **NEXT**.
2. Press **TEST** or to go ahead with a button test.

3. Press button to see its function. If the button you pressed uses an indicator, it should turn on when you test the button.
4. Pressing the **Rls** button puts **Rls button** on the display briefly and returns you to the **Button test** display.

Testing the speaker in the telephone handset

The handset test is not available if you have a headset plugged into the telephone.

1. Press **Feature** **8** **0** **5**, then **#** or **NEXT** twice. The display reads **Handset test**.
2. Press **TEST** or **Hold** to go ahead with a handset test.
3. Pick up the handset and listen. You should hear dial tone through the handset at a maximum volume. The volume is reset to maximum only while the test is going on.

Pressing any button or hanging up ends the test.

Testing the telephone headset

The headset test is not available to telephones that do not have a headset jack or a headset plugged in.

1. Press **Feature** **8** **0** **5**, then **#** or **NEXT** until the display reads **Headset test**.
2. Press **TEST** or **Hold** to go ahead with a headset test.

You should hear dial tone through the headset. The volume is reset to a default level during the test.

Pressing any button ends the test.

Testing the telephone speaker

1. Press **Feature** **8** **0** **5**, then **#** or **NEXT** until the display reads **Speaker test**.
2. Press **TEST** or **Hold** to go ahead with a speaker test.

You should hear page tone through the telephone speaker at the maximum volume. The volume returns to its previous setting when you end the test.

Pressing any button ends the test.

Testing the power supply to a telephone

1. Press , then or NEXT until the display reads **Power test**.
2. Press TEST or to go ahead with a power supply test.

You should see all the indicators on the telephone go on and hear ringing at maximum volume. When the test has ended, the display should briefly show **Power OK**.

The test lasts for five seconds or until you press a button.

Common feature displays

You may see the following displays when you use a feature.

Access denied

Someone is already using programming, or the feature you are trying to use is not compatible with the configuration of the telephone or line.

Denied in admin

You have tried to use a feature, but you have not been given access to it in administration programming.

Feature timeout

You have taken more than 15 seconds to press a button in response to a display.

Inactive feature

You have entered a feature code that is used by an application program that your system does not have.

Invalid code

You have entered an invalid feature code.

Not available

You have tried to use a feature that is not available in the present setup of your Norstar system.

Set locked

You cannot use the feature you have chosen because your telephone is locked. See "Using Set lock" on page 178.

1234567890123...
VIEW→ OK

Press **#** or press **VIEW→** or **+VIEW** to view a number that is too long to fit on the display. Press **Hold** or **OK** when you are finished.

§

This indicates a long distance call. (May be available with Call Display services.)

239>221

You are receiving an internal call from telephone 239 forwarded by telephone 221 or you have an Answer button for telephone 221 and an internal call from 239 is ringing on 221.

| | |
|-------------------------|--|
| 221 TRANSFER | You are connected to an internal call. Press <u>TRANSFER</u> to transfer the call. |
| 221 calling | You are receiving a call from telephone 221. |
| Call 221? YES NO | You have received a Ring Again offer for a call to an internal telephone. Press the flashing internal line button or <u>YES</u> to call the number again. On the M7100 telephone, just lift the receiver. Otherwise, press <u>NO</u> or wait 30 seconds for the Ring Again offer to expire. For an explanation of Ring Again, see "Using Ring Again" on page 60. |
| Camped: 221 CALLBACK | The person to whom you camped the call did not answer it. The call has come back to you. Press the line button or <u>CALLBACK</u> to reconnect to the call. |
| Line001 TRANSFER | You are connected to an external call. Press <u>TRANSFER</u> to transfer the call. |
| Line001>221 | You are receiving an external call forwarded from telephone 221 or you have an answer button for telephone 221 and an external call is ringing on that telephone. |
| Line001 transfer | The call on line 001 is being transferred to you by someone else in your Norstar system. |
| Line001 waiting | A camped call is waiting. Press the line button or use Call Queuing to answer the call. Press <input type="text" value="Hold"/> if you have an M7100 telephone. |
| No calls waiting | You tried to use Call Queuing but no call was ringing at your telephone. |
| No line selected | There is no call ringing at your telephone. If you have a flashing line button but your telephone is not ringing, press the line button to answer the call on that line. |

Not in service

The telephone to which you directed a call is not in service or is otherwise unavailable. The call is returned to your telephone.

Parked call

CALLBACK

No one answered the call you parked. The call has come back to you.

Pick up receiver

You have used the Call Queuing feature without picking up the receiver. Auto Handsfree has not been assigned to your telephone. You must use the receiver or  to answer a call.

Priority> 221
BLOCK

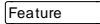
You are receiving a priority call. If you are on another call, inform the person you are speaking to that you are about to put the call on hold. Press the flashing line indicator of the priority call or wait until the call connects automatically (in eight seconds). The priority call goes through when you hear the next beep. Your active call is placed on Exclusive Hold. It is reconnected automatically when the priority call ends (unless you transfer the priority call, in which case you must press the line button of your original call to reconnect). Use DND ( 8 5) or press BLOCK to reject a priority call.

Release a call

You have no free line buttons on which to receive a call. Release one of your current calls and try again to answer the incoming call.

Use line pool?

YES NO

You have received a Ring Again offer for a line pool. Press the flashing internal line button or YES to use the line pool. On the M7100 telephone, just lift the receiver. Otherwise, press NO or wait 30 seconds for the Ring Again offer to expire.

Hold or release

You cannot program a feature button while you are on a call.

Release calls

You have tried to use a feature while you were on a call or had calls on hold. Release the call or calls, before using the feature.

| | |
|--------------------|---|
| Line in use | The line is in use. Make the call using normal methods or wait until the line is free. |
| No button free | You have tried to make, receive or pick up a call when no line button was available. Some features require you to have a button free. Releasing calls can free up line buttons. |
| Make calls first | The feature you tried to use requires you to be on an active call at your telephone. This display appears when information about a call has been cleared by a system reset. |
| No free lines | All the lines or line pools available to the telephone are in use. This display appears when you have tried to dial an external number or use a feature that conflicts with the lines, line pools or prime line used by the telephone. This must be corrected by your customer service representative or installer. |
| No line selected | The telephone has been set up to dial an external number on a prime line but the telephone does not have a prime line. This must be corrected by your customer service representative or installer. |
| In use:221 | You have tried to program redirection while someone else is programming redirection. Only one person can program line redirection at a time. |
| Incoming only | The line you are trying to use for redirecting calls is for incoming calls only. Choose an outgoing line. |
| 9_ QUIT BKSP OK | Continue entering digits. Press <input type="text"/> or <u>BKSP</u> to delete incorrect digits. Press <input type="text"/> or <u>OK</u> when you are finished. |
| Invalid number | You have entered an invalid line pool code or an invalid destination code. |
| Line denied | You have selected a line that is private to another telephone. |

Restricted call

The destination you have chosen for line redirection is restricted.

Index

Symbols

- ☎ Long Distance symbol 203
 - 📡 Link symbol 180
 - ⏸ Pause symbol 182
 - 📡 Programmed Release symbol 183
 - ⏹ Run/Stop symbol 183
 - 📡 Wait for Dial Tone symbol 184
- 911 1, 149, 155

A

access

- Class of Service 187
- external lines 194
- Norstar from outside the system 184
- remote 186
- using a COS 186
- using a DISA 185

Access denied 203

ADD 196

administration password (see System Coordinator password)

administration programming 2

Alarm 61-4-2 199

alarm codes, reporting and recording 199

alarm telephone 199

Allow calls 150

allow redirect

- programming 89

Already joined 39, 54

Already Parked 81

alternate services 165

analog telephone

- replying to a message 101, 102

analog telephones

- sending messages 98

analog terminal adapter (see ATA)

announcement

- paging 95
- Voice Call 104

Answer button 40

answering calls

- Answer button 40
- Call Display services 34
- Call Duration Timer 50
- Call Pickup 37
- CAP 31
- Conference Calls 41
- Group Listening 45
- Handsfree 45
- hearing aid compatibility 33
- prime telephone 31
- Privacy 49
- Trunk Answer 39
- using line buttons 30
- using the Release button 33
- Voice Call 105

apply button cap labels 118

ATA (analog terminal adapter)

- dialing signals 182
- using dialing modes 58

Auto Call information (see Caller ID set)

Autodial

- for M7100 64
- line selection 64
- programming 63
- storing number on a memory
 - button 63
- using intercom line for 64
- using Last Number Redial 66

Autodial full 64

automatic

- Call information 36
- Call Log 107
- dial 58
- Handsfree 48
- Hold 73
- release of a line (see Disconnect Supervision)

Automatic Call Back, ISDN

- terminal feature 161

Automatic Call Forward

- changing settings 84

Automatic Recall

- ISDN terminal feature 161

Automatic Telephone Relocation 149, 192

Automatic Time and Date 15, 16, 189

auxiliary ringer 179

B

Background Music 151

- turning off 151

Basic password 2, 127, 172

BKSP 196

blocking calls (see Do Not Disturb)

busy 53, 60

busy tone, fast 187

button cap labels 118

- applying 118
- button caps 119
- button defaults
 - M7100 telephone 123
 - M7208 telephone 123
 - M7310 telephone 121
 - M7324 telephone 122
- Button erased 64
- Button Inquiry 115
- buttons
 - Answer button 40
 - Button Inquiry 115
 - changing programming 128
 - display 5
 - dual memory 5
 - erasing programmed features 117
 - Feature 5
 - Handsfree/mute 48
 - Hold 5
 - Last Number Redial 65
 - memory 5, 63, 195
 - moving line 124
 - numbering on all telephone types 128
 - programming features on 116
 - Release 5, 33
 - Saved Number Redial 70
 - shift 5
 - testing 200
 - using a line button 55
 - using buttons 4

bypassing

- a Hotline telephone 176

C

call

- overflow 194

- ways to make a 53
- Call 221? 204
- Call blocked 60
- Call Display information 34
- Call Duration Timer 50
- Call Forward
 - and Line Redirection, differences 92
 - automatic, changing settings 84
 - Call Forward No Answer 23
 - Call Forward on Busy 25, 85
 - canceling 83
 - Forward no answer 84
 - ISDN terminal feature 160
 - overriding 84
 - programming 23, 84, 85
 - to voice mail 87
 - using 83
- Call information
 - automatic 36
 - changing what is shown first 36
 - displaying information 34
 - getting information for a call on hold 35
 - getting information for a current call 35
- Call Log 107
 - Autobumping 109
 - automatic 107
 - calling from within 110
 - deleting log items 109
 - logging a call manually 108
 - options 108, 131
 - password 111–112
 - canceling 112
 - changing 111
 - set 107
 - using 107
- Call Park 80
- Call Pickup
 - Directed Pickup 37
 - Group Pickup 38
- Call Queuing 74
- Call Transfer 75–78
- Call(s) bumped 113
- Callback 82
- Caller ID set 36
- Calling 60
- CAMP denied 79
- CAMP max 78
- CAMP to 79
- CAMPed 79, 204
- camping calls (see Camp-on)
- Camp-on 78
- Can't ring again 54, 61
- CANCEL 196
- Cancel denied 103
- canceling
 - a transfer 76
 - Call Forward 83
 - Do Not Disturb 150
 - Group Listening 45
 - Line Redirection 89
- CAP (central answering position)
 - answering calls 31
 - customizing 32
 - M7324 telephone 31
 - monitoring calls 33
 - sending messages 99
 - telephone 31, 174
 - using 31
- central answering position (see CAP)
- Centrex template 123
- changing settings
 - automatic Call Forward 84

- Class of Service
 - changing 188
 - using a password 186, 187
- Cleared>LINEHAM 103
- communicating in the office
 - paging 95–98
 - sending messages using display 98
- Voice Call 104
- Conf. on hold 44
- Conference busy 44
- Conference Call
 - by releasing privacy 50
 - disconnecting from 44
 - removing yourself from 44
 - splitting 43
 - using the Conference feature 41
- contrast adjustment 116
- control telephone 168, 169, 178
- customizing CAP 32
- customizing your telephone
 - adjusting ring volume 125
 - Button Inquiry 115
 - changing ring type 125
 - contrast adjustment 116
 - User Preferences 127

D

- date and time
 - changing 13
 - displayed instead of messages 125
 - displaying 51
 - length of a call 50
- defaults
 - button assignments 120
- deleting
 - Call Log items 109

- messages from list 102
- programmed features 117
- Denied in admin 203
- desktop conferencing using ISDN 162
- dial pad
 - description 5
 - entering numbers and letters 19
- dial tone
 - Norstar system 187
 - stuttered 187
- Dial voice call 105
- dialing
 - automatic dial 58
 - modes 57
 - options 131
 - pre-dial 58
 - saved number 70
 - signal
 - Link 180
 - Long Tones 182
 - Pause 181
 - Programmed Release 183
 - run/stop 183
 - switching from pulse to tone 184
 - Wait for Dial Tone 184
- standard dial 57
- switching from pulse to tone 184
- DID (Direct Inward Dial)
 - template 123
- digital connections, to ISDN networks and devices 162
- direct inward system access (DISA) 185
- direct-dial telephone programming 175

Directed Pickup 37
 DISA (see direct inward system access)
 disconnect
 from conference 44
 releasing a call, accidentally 51
 Supervision 192
 display
 button equivalents for one-line display 196
 buttons 5
 Call information 35
 changing the language 116, 131
 contrast 132
 making darker or lighter 115
 one-line 195
 testing 200
 time and date 51
 distinctive rings 125
 DN (see internal numbers)
 DND 79
 DND from 31
 DND transfer 31
 DNs 12
 Do Not Disturb 150
 canceling 150
 on Busy 26, 86
 using 150
 Do not disturb 54, 60, 77
 DRT 31
 dual memory button 5
E

Emergency 911 1, 155
 ending a call 33
 Enter code 118
 Enter digits 64, 68

Enter zone 97
 entering names and numbers 19
 erasing
 Call Log items 110
 messages from list 102
 programmed features 117
 Evening Sched 171
 Exchanged 124
 Exclusive Hold 59, 74
 Expensive route 54
 external
 access to Norstar 184
 autodial, programming 63
 Call Forward (see Line Redirection)
 page 95
 paging equipment 98
 extra-dial telephone 171

F

Feature

Autobumping
 canceling # 8 1 5 109
 using 8 1 5 109
 autodial button
 external * 1 63, 65
 internal * 2 63
 Background Music
 canceling # 8 6 151
 turning on 8 6 151
 Button Inquiry * 0 70, 115, 192, 200
 Call Duration Timer 7 7 50
 Call Forward
 canceling # 4 83
 using 4 83

- Call
 - Information
 - 34, 35
- Call Log
 - entering 111
 - external calls
 - 109
 - options 108
 - password 112
 - password 111
 - viewing 109
- Call Park 79
- Call Pickup 38
- Call Queuing 74
- Call Transfer
 - canceling 76, 77
 - using 44, 75
- Camp-on 78
- Class of Service 188
- Conference Call
 - M7100 telephone
 - 42, 43
 - using 41, 43
- Contrast Adjustment
 - 115
- Dialing Modes 57
- Directed Pickup 37
- Do Not Disturb
 - canceling 150
 - turning on 58, 150
- Exclusive Hold 74
- Feature Button
 - programming 117
- Group Listening
 - canceling 45
 - using 45
- Hide message
 - display 126
- Host System Dialing Signals
 - Link 180
- Long Tones 182
- Pause 181
- Programmed
 - Release 183
 - Run/Stop 183
 - Wait for Dial
 - Tone 184
- Language
 - English 116
 - French 116
 - Spanish 116
- Last Number Redial 65
- Line Pool Access 56
- Line Redirection
 - canceling 89
 - using 88
- Message
 - canceling 100
 - sending 99, 102
 - viewing ones you sent
 - 103
 - viewing 100
- Page
 - combined zone 95
 - external zone 95
 - internal zone 95
 - using 80, 81, 95
- Password
 - Basic 13,
 - 172
 - Call Log 111,
 - 112
 - System
 - Coordinator
 - 11, 13, 18, 20, 21,
 - 22, 23, 24, 25, 26, 27,
 - 172
- Priority Call 59
- Privacy 50
- Restriction Service

- turning off # 8 7 2 0
 - 168
- turning on 8 7 2 0 168
- Ring Again
 - canceling # 2 61
 - using 2 61
- Ring Type * 6 125
- Ring Volume * 8 0 125
- Ringing Service
 - turning off # 8 7 1 0
 - 168
 - turning on 8 7 1 0 168
- Routing Service
 - turning off # 8 7 3 0
 - 168
 - turning on 8 7 3 0 168
- Saved Number Redial 6 7 0
 - 69, 70
- Services, viewing 8 7 0 0
 - 169
- Speed Dial
 - adding user * 4 68
 - making calls 0 67
- Static Time and
 - Date 8 0 6 104
- Testing
 - display 8 0 5 200
 - power supply 8 0 5 202
 - telephone
 - buttons 8 0 5 200
 - telephone
 - handset 8 0 5 201
 - telephone
 - headset 8 0 5 201
 - telephone
 - speaker 8 0 5 201
- Time and
 - Date * * T I M E 13, 172
- Time 7 7 51
- Trunk Answer 8 0 0 40
- User Preferences * *
 - U S E R 127, 172
- Voice Call Deny
 - canceling # 8 8 105
 - using 8 8 105
- Voice Call 6 6 104
- fast busy tone 187
- Feature button 5
- Feature code 118
- Feature moved 118
- Feature timeout 203
- features
 - adjusting ring volume 125
 - Autobumping 109
 - autodial 63
 - auxiliary ringer 179
 - Background Music 151
 - Button Inquiry 115
 - Call Display 34
 - Call Duration Timer 50
 - Call Forward 83
 - Call Information 34
 - Call Log 107
 - Call Park 79
 - Call Pickup 37
 - Call Queuing 74
 - Call Transfer 75
 - Callback 82
 - Camp-on 78
 - changing ring type 125
 - Class of Service password 188
 - Conference Calls 41
 - contrast adjustment 116
 - dialing modes 57
 - dialing signal
 - Link 180
 - Long Tones 182

- Pause 181
- Programmed Release 183
- run/stop 183
- Wait for Dial Tone 184
- Do Not Disturb 150
- Do Not Disturb on Busy 86
- Exclusive Hold 74
- Group Listening 45
- Handsfree 45
- hiding the message or calls display 125
- Hold 73
- language choice 116
- Last Number Redial 65
- line pools 55
- Line Redirection 87–93
- Messages 98
- moving line buttons 124
- one button access 33
- paging 95–98
- priority call 58
- Privacy 49
- Restriction service 165
- Ring Again 60
- ring type 125
- Ringing service 165
- Routing service 165
- Saved Number Redial 69
- sending messages using analog telephones 98
- sending messages using display 98
- Set Lock 178
- Speed Dial 67
- Test a Telephone 199–202
- Time and Date 172
- Trunk Answer 39
- User Preferences 127
- Voice Call 104

- Voice Call Deny 105
- file transfer using ISDN 162
- Forward denied 87
- Forward> 87
- forwarding calls 23
 - Call Forward 83
 - Call Forward delay 85
 - Call Forward No Answer 84
 - Call Forward on Busy 85
 - Do Not Disturb on Busy 86
 - Line Redirection 87–93

G

- Group 4 fax using ISDN applications 163
- Group Listening 45
 - canceling 45
- Group Pickup 38

H

- handling many calls at once
 - Call Queuing 74
 - Hold 73
- handset, speaker testing 201
- handset, testing 201
- Handsfree
 - making calls 46
 - muting 46, 48
- Handsfree Answerback programming 49
 - Voice Call 105
- headset
 - Handsfree requirement 48
 - testing 201
- hearing aid compatibility 33
- Hidden number 66, 70
- Hidden number 54
- Hold

- automatic 73
 - button 5
 - Conference Call 43
 - exclusive 74
 - getting information for a call
 - on 35
 - listening while on hold 73
 - retrieving call 73
 - Hold or release 113, 205
 - host system signaling
 - Link 180
 - Pause 181
 - Programmed Release 183
 - run/stop 183
 - Wait for Dial Tone 184
 - Hotline
 - bypassing 176
 - setting up the telephone 177
 - Hunt Groups 25, 26, 28, 29, 38, 40, 59, 61, 73, 81, 83, 84, 85, 86, 96, 104, 135, 151, 177, 192
 - Adding members 136
 - Assigning lines 138
 - Broadcast mode 139
 - Distribution modes 139
 - Moving members 138
 - Programming busy line
 - setting 142
 - Programming the overflow
 - set 144
 - Programming the queue
 - time-out 143
 - Removing members 136
 - Rotary mode 140
 - Sequential mode 140
 - Setting the hunt delay 141
 - Setting the name 145
 - Unassigning lines 138
 - Hybrid template
 - button defaults 123
-
- I**
-
- In use 103, 206
 - In use SETNAME 113
 - Inactive feature 203
 - incoming call indicator 29
 - Incoming Line Groups (ILG) 135
 - Incoming only 206
 - indicator
 - incoming call 29
 - Installer programming 2, 11
 - Integrated Services Digital Network (see ISDN)
 - Intercom 90
 - intercom
 - using as the line for Autodial 64
 - Intercom # 64
 - internal numbers
 - length of 192
 - internal page 95
 - Internet access using ISDN
 - applications 163
 - Invalid code 68
 - Invalid code 184, 203
 - Invalid location 124
 - Invalid number 65
 - Invalid number 77, 81, 206
 - Invalid zone 97
 - ISDN (Integrated Services Digital Network)
 - applications 162–163
 - connecting to 162
 - description 153
 - desktop conferencing using 162
 - equipment 162–163

- file transfer using 162
- Group 4 fax using 163
- Internet access using 163
- LAN access using 163
- LAN to LAN bridging using 163
- leased line backup using 163
- telecommuting using 162
- videoconferencing and video telephony using 162

ISDN PRI 153

L

LAN

- access using ISDN applications 163
- router 163
- to LAN bridging ISDN applications 163

language, changing on the display 116, 131

Last Number Redial programming 66

Last Number Redial, using 65

leased line backup using ISDN applications 163

length of call, timing 50

length of internal numbers 192

letters, entering with dial pad 19

limiting

- access to Norstar 185
- telephone feature use 178
- telephone programming 178
- using alternate or scheduled services 165

line

- assignment 192
- button

- moving 30, 124
- button, using to choose a line 55
- changing the name 22, 149
- indicators, description 30
- pool 55–57, 194
- profile 191
- Redirection
 - canceling 89
 - using 87–93
- Redirection, and Call Forward, differences 92
- target 193

Line 001 waiting 204

Line denied 40, 54, 206

Line hung up 79

Line in use 206

Line Redirection 90

Line001 callback 31

Line001 hung up 77

Line001 to Prime 31

Line001 transfer 204

Link

- using 180

Link, programming 181

LIST 130

listening on hold 73

log space

- programming 112

logging a call manually 108

Logit (see Call Log)

long distance call

- indicator 203

- using COS password 184

Long Tones 182

Lunch Sched 171

M

M7100 telephone

- Autodial 64
- button defaults 123
- Button Inquiry 115
- Call Conference 41
- Call Park 80
- Call Queuing 204
- Call Transfer 77
- CallBack 79
- camping a call 78
- Conference Call 43
- Conference Call on hold 43
- Hold 73
- Incoming Line Group button 30, 55
- internal numbers 192
- line assignment 193
- line buttons 194
- Line Redirection 88
- memory buttons 195
- one-line display 195
- Ring Again 204, 205
- Speed Dial 68
- standard dial 57
- Transferring a call 77
- Voice Call 105
- M7208 telephone
 - button defaults 123
 - Conference Call 42
 - memory buttons 195
 - one-line display 195
 - splitting a Conference Call 43
- M7310 telephone 4, 5
 - button defaults 121
 - Conference Call 42
 - memory buttons 195
 - splitting a Conference Call 43
 - troubleshooting 199
- M7324 telephone 4, 5
 - button defaults 122
 - CAP 31
 - Conference Call 42
 - memory buttons 195
 - splitting a Conference Call 43
 - troubleshooting 199
- maintaining security 186
- Make calls first 206
- making calls
 - dialing modes 57
 - priority call 58
 - using a line button 55
 - using line pools 55
 - using Ring Again 60
 - with automatic Handsfree 48
- memory buttons 5, 63, 195
- Message denied 103
- Message list 103
- Message to 103
- Messages
 - canceling a sent message 100
 - hiding display 125
 - removing from list 102
 - sending, using the display 98
 - viewing 100
- Messages & Calls 104, 113
- Microphone muted 105
- monitoring
 - calls 40, 193
 - with CAP 33
 - line pool status 60
 - lines (see also Disconnect Supervision) 192
 - telephone status 60
 - transferred calls 82

mounting telephones on wall
197

Move line from 124

Move line to 125

moving

telephones 149

music, background 151

muting voice call tones 105

N

Name and Number blocking

BRI 160

PRI 155

names

spelling out 19

Network Name Display

BRI 159

PRI 154

New calls begin 113

night control phone (see control
telephone)

Night Sched 171

Night Service (see services)

9. 53, 206

No button free 104, 206

No call on 81

No call to Park 81

No calls waiting 204

No free lines 206

No info to log 113

No last number 66

No last number 54

No line selected 54, 204, 206

No line to use 91

No log assigned 114

No number saved 71

No number stored 68, 104

No resume item 114

No services ON 170

No voice call 106

Norstar Programming Report 2

Norstar system dial tone 187

Norstar telephones

installing 147

mounting on a wall 148

Not available 203

Not in service 55, 77, 79, 87,
205

numbers, entering with dial pad
19

O

OK 196

On another call 55, 60

On hold 74

one button access to features 33

one button dialing (see Autodial)

Outgoing line 91

overflow call routing 194

OVERRIDE 196

overriding

Call Forward 84

P

page

external equipment 98

programming 96

shortcut codes 95

types 95

zones, programming 96

Page choice 97

Page timeout 97

Paging ALL 97

Paging busy 98

Park denied 81

Parked call 205

- Parked on 81
- parking a call
 - retrieving 80
- Parking full 81
- password
 - Basic 127, 172
 - Call Log 111–112
 - canceling 112
 - changing 111
 - changing 171
 - Class of Service 187
 - clearing Call Log 174
 - entering 11
 - System Coordinator 2, 171, 172
 - user preferences 127
- Pause 181
- pause in a sequence of numbers (see Wait for Dial Tone)
- PBX template 123
- Pick up receiver 205
- Pickup 39
- Pickup denied 39, 40
- pickup group 38
- Please wait 60
- Pool code 91
- power off, effect on memory
 - buttons 63
- power supply, testing 202
- pre-dial 58
- Press a button 65, 115, 118
- Press a line 125
- Press held line 44
- prime
 - line 177, 178
 - telephone 31
- prime line 196
- priority call (see also Call Queuing) 29, 58
- Priority denied 60
- Priority>223 205
- Privacy
 - changing status 49
- private
 - branch exchange, accessing from Norstar (see also host system dialing signals) 180
 - call 50
 - line 196
- Program and HOLD 65, 69, 118
- Program and OK 65, 69, 118
- Programmed 65
- Programmed Release 183
- programming
 - basics
 - administration
 - programming 2
 - Basic password 2
 - customizing your Norstar 2
 - entering passwords 11
 - installer programming 2
 - personal programming 2
 - programming indicator ◀
 - 7
 - programming indicator ▶
 - 7
 - programming map 7–11
 - programming overlay 6
 - recording changes 2
 - starting and ending a session 11–12
 - understanding programming 2
 - changes, planning 3
 - features on buttons 116
 - Installer 11
 - lines

- changing the name of a line 149
- log space 112
- overlay 3, 6
- system features
 - Call Forward 23, 26
 - changing the name of a line 22
 - changing the name of a telephone 20
 - Restriction service 165, 166
 - Ringing service 165
 - Routing service 165
 - System Speed Dial 17, 67
 - time and date 13
- telephones
 - allowing Line Redirection 89
 - auxiliary ringer 179
 - Call Display 36
 - Call Forward 23, 26
 - Call Forward delay 85
 - Call Pickup 37
 - changing number of rings before forwarding call 24
 - changing the name of a telephone 20, 149
 - direct-dial telephones 175
 - Do Not Disturb 150
 - Do Not Disturb on Busy 26
 - external autodial button 63
 - Forward no answer 84
 - Forward on busy 85
 - Handsfree 47
 - Handsfree Answerback 49
 - Hotline 177
 - page zone 96
 - paging 96
 - priority call 58
 - Redirect ring 90
 - Set lock 178
 - User Speed Dial 67, 68
 - using a telephone for 3
- programming telephones
 - Last Number Redial 66
 - Link 181
 - Saved Number Redial 70

Q

QUIT 196

R

- recording programming 2
- redialing
 - external number 65
- ~~Redir by~~ 91
- Redirect ring
 - programming 90
- ~~Redirect denied~~ 91
- redirection loops, avoiding 93
- refusing to answer second call 150
- ~~Release a call~~ 79, 205
- Release button 5, 33
- ~~Release calls~~ 205
- releasing
 - accidentally 51
 - from conference 44
- remote access 184–187
- remote use
 - Class of Service password 188
 - security 185

- using lines and features
 - from outside the system
 - 184
- replying to a message 100
 - analog telephone 101, 102
- reporting and recording alarms 199
- Restr'n 170
- Restricted call 55, 77, 207
- restricting
 - access to Norstar 185
 - feature use (see Set Lock)
 - telephone feature use 178
 - telephone programming 178
 - using alternate or scheduled services 165
- Restriction service 165
- retrieval codes
 - Call Park 80
- retrieving
 - held call 73
 - parked call 80
- ring
 - auxiliary ringer 179
 - changing ring type 125, 132
 - changing the number of rings before call is
 - forwarded 24
 - description of types 30, 125
 - ring volume 125
 - Ringling service 167
- Ring Again 60
- Ring Again? 55, 61
- Ringling 170
- Ringling service 165
- RLS button 33
- Routing 170
- Routing service 165
- run/stop signal 183

S

- Saved Number Redial
 - using 69
- Saved Number Redial, programming 70
- saving a number (see Saved Number redial)
- Sched 4 171
- Sched 5 171
- Sched 6 171
- scheduled services 165
- security
 - recommendations 186
 - system 185
- Select a line 55, 69
- Select line out 91
- Select line(s) 91, 92
- Send message? 55
- Service Modes (see Services)
- Service Modes ON 170
- Service provider features
 - Automatic Call Back 161
 - Automatic Recall 161
 - Call Forward 160
 - calling the number your calls are forwarded to 161
 - canceling Call Forward 161
- Service Schedules
 - Evening Sched 171
 - Lunch Sched 171
 - Night Sched 171
 - Sched 4 171
 - Sched 5 171
 - Sched 6 171
- Services
 - overriding 171
 - Restriction service 165
 - Ringling service 165

- Routing service 165
 - Trunk Answer 39
 - turning off and on using feature codes 168
 - viewing active schedules 169
 - Set Lock 178–179
 - set lock 179
 - Set locked 203
 - Set profile 194
 - shift button 5
 - SHOW 196
 - signal
 - Link 180
 - Long Tones 182
 - Pause 181
 - Programmed Release 183
 - run/stop 183
 - Wait for Dial Tone 184
 - special telephones 174
 - Speed Dial
 - adding or changing 17
 - changing User Speed Dial 130
 - choosing a system code 18
 - choosing the display 19
 - host system signaling codes 67
 - making a call 67
 - programming 17
 - programming for User 68
 - selecting a line 18
 - splitting a Conference Call 43
 - Square template
 - button defaults 123
 - standard dial 57
 - Start of list 104
 - Still in transfer 77
 - stopping calls from ringing at your telephone 150
 - stuttered dial tone 187
 - suspending a call (see also Call Park and Hold)
 - System Coordinator
 - password 2
 - system dial tone 187
 - System Speed Dial 67
- ## T
-
- target line 193
 - changing the name 149
 - telecommuting using ISDN applications 162
 - telephone
 - alarm 199
 - Call Display information 36
 - CAP 31, 174
 - changing the name 149
 - control 168, 178
 - difference between M7310 and M7324 telephones 5
 - direct-dial 174
 - extra-dial 168, 171, 174
 - Hotline 176
 - log calls automatically 107
 - M7100, illustration 194
 - M7310, illustration 4
 - M7324, illustration 4
 - mounting on wall 197
 - moving 149
 - prime 174
 - prime telephone 31
 - testing 199–202
 - testing
 - buttons 200
 - display 200
 - ending a session 200

handset 201
 headset 201
 power supply 202
 telephone 199
 telephone speaker 201
Their list full 104
3 Parties only 44
 time and date
 changing 13
 displayed instead of
 messages and calls 125
 displaying 51
 Feature
 * * T I M E 13, 172
 Feature 8 0 6 104
 length of a call 50
 time savers
 autodial 63
 Saved Number Redial 69
 Speed Dial 67
 tone
 camped call tones 78
 controlling length 182
 remote access tones 187
 voice call 105
 tracking incoming calls
 Call Log 107
 transfer (see Call Transfer)
Transfer denied 78
 transferring calls 75
 Callback 82
 parking a call 79
 using Camp-on 78
 troubleshooting
 reporting and recording
 alarms 199
 testing
 the headset 201
 the power supply 202

the speaker in the
 handset 201
 the telephone buttons
 200
 the telephone display 200
 the telephone speaker
 201
 using the alarm telephone
 199

Trunk Answer 39

U

understanding programming 2

Un-equipped line 91

Unknown name 112

Unknown number 69

until * 170

UPDATE 12

Use line Pool? 205

User Preferences 127–133

Feature * *

U S E R 172

User Speed Dial 67, 130

using Call Forward 83

using Do Not Disturb 150

using Norstar remotely 184–187

using this guide 1

V

videoconferencing and video
 using ISDN applications 162

VIEW 196

viewing

 active Services 169

 Call Log 109

 messages 100, 103

Voice Call 104–106

Voice call 106

voice mail

accessing your Norstar
system 114
using Call Forward 87

volume

bar 196
control 196

W

Wait for Dial Tone 184
wall mounting telephones 197

Y

Your list full 104

Tell us what you think...

This is your document. Nortel wants it to work well for you.

Please take a few minutes to answer the questions on the other side of this page. Fax it back to us at the number provided, or mail it to the address below.

Your comments will be used to make improvements.

Thank you. We appreciate your time and consideration.

Enterprise Networks Training and Documentation

Return mail address:

Documentation User Comments Survey
Enterprise Networks Training and Documentation
P.O. Box 833858
M/S H300
Richardson, TX 75083-3858
USA

Fax to:

Documentation User Comments Survey
Enterprise Networks Training and Documentation
1-972-684-8699

Please circle the most appropriate number on the scale for each question.

1. Overall, are you satisfied with this document?

Yes 7 6 5 4 3 2 1 No

2. Is it easy to find information in this document?

Yes 7 6 5 4 3 2 1 No

3. Have you found the information in this document to be technically accurate?

Yes 7 6 5 4 3 2 1 No

4. Is this document clearly written?

Yes 7 6 5 4 3 2 1 No

5. Is the information in this document complete for its purpose?

Yes 7 6 5 4 3 2 1 No

6. Does this document help you do your job?

Yes 7 6 5 4 3 2 1 No

Comments:

Optional: Your name _____ Fax _____
Company _____



After you have finished programming, store your Norstar Programming Overlay in the slots provided on the back cover.

Après avoir terminé la programmation, rangez la grille Norstar dans les fentes prévues à cet effet à la fin de ce guide.

Cuando haya terminado de programar, inserte en estas ranuras su Plantilla de programación Norstar que se encuentra en la contra tapa.

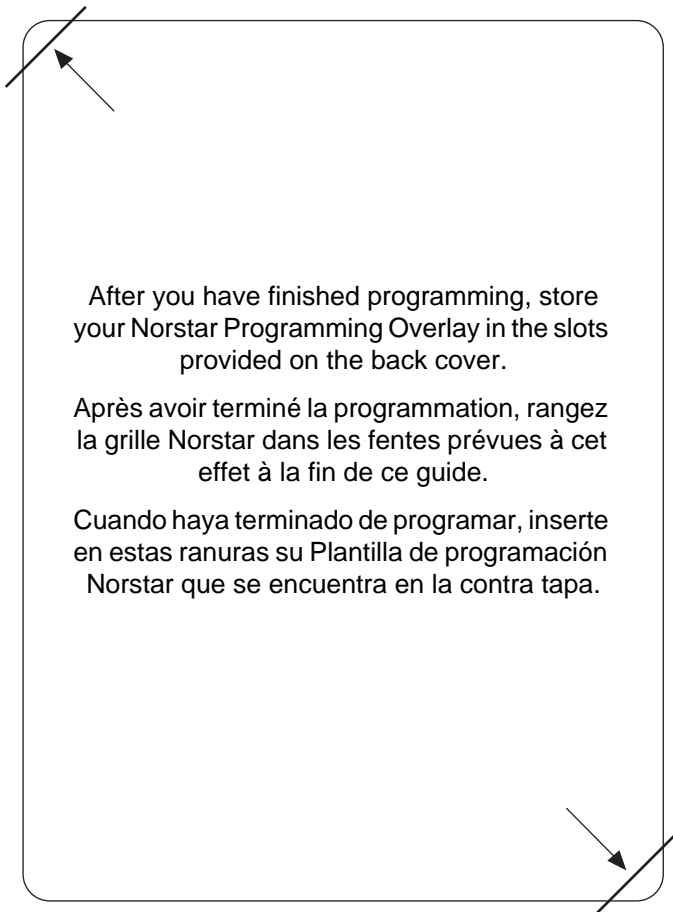

Free Manuals Download Website

<http://myh66.com>

<http://usermanuals.us>

<http://www.somanuals.com>

<http://www.4manuals.cc>

<http://www.manual-lib.com>

<http://www.404manual.com>

<http://www.luxmanual.com>

<http://aubethermostatmanual.com>

Golf course search by state

<http://golfingnear.com>

Email search by domain

<http://emailbydomain.com>

Auto manuals search

<http://auto.somanuals.com>

TV manuals search

<http://tv.somanuals.com>