



Nostalgia Products Group, LLC  
1471 Partnership Dr.  
Green Bay, WI 54303-5685

Visit us online at  
[www.nostalgielectrics.com](http://www.nostalgielectrics.com)

©2009 Nostalgia Products Group LLC

Rev. 8/18/09

# **KEGORATOR™**

## **KRS-2000 SERIES**

### **INSTRUCTION MANUAL**

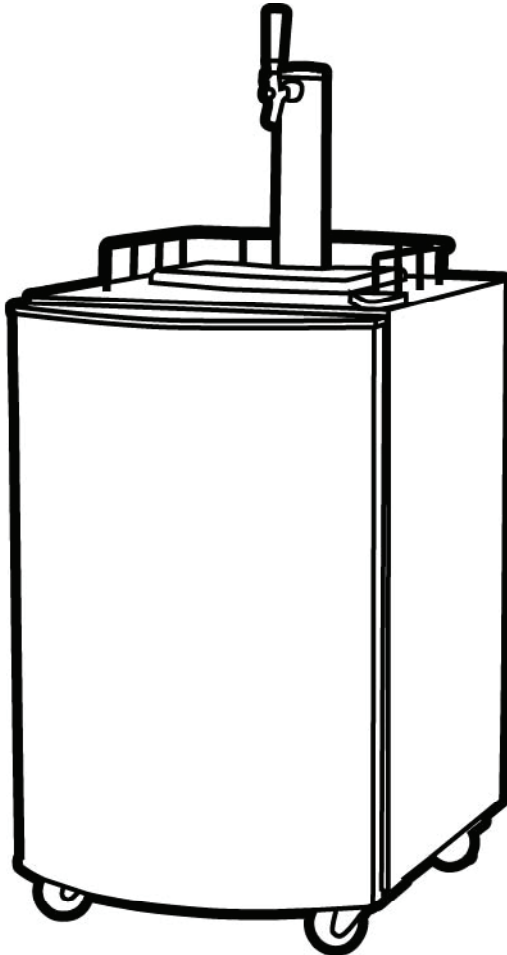

**FOR HOUSEHOLD USE ONLY  
READ THESE INSTRUCTIONS BEFORE USING THIS  
UNIT!  
SAVE THESE INSTRUCTIONS!**

## Safety Precautions

Read all of the instructions before using this appliance. When using this appliance, always exercise basic safety precautions, including the following:

1. Use this appliance only for its intended purpose as described in this operation manual.
2. This appliance must be properly installed in accordance with the installation instructions before it is used. See the installation section for more details.
3. This appliance must be connected to a proper electrical outlet with the correct electrical supply.
4. Proper grounding must be ensured to reduce the risk of shock and fire. Do not cut or remove the grounding plug! If you do not have a three-prong electric receptacle outlet in the wall, have a certified electrician install the proper outlet. The wall receptacle must be properly grounded.
5. Never unplug your appliance by pulling on the power cord. Always grasp the plug firmly and pull straight out from the outlet.
6. Immediately replace worn power cords, loose plugs and power outlets.
7. To reduce the risk of electric shock or fire, do not use extension cords or adapters to connect the unit to an electrical power source.
8. Unplug your appliance before cleaning or making any repairs.
9. We suggest that a certified technician perform the service if for any reason this product requires service.
10. If your old appliance is being discarded, we recommend that you remove the door and leave the shelves in place. This will reduce the possibility of danger to children.
11. This appliance should not be recessed or built into an enclosed cabinet. It is designed for freestanding installation only.
12. Do not operate your appliance in the presence of explosive fumes.
13. Do not tamper with the controls.
14. Do not operate this appliance when parts are missing or broken.
15. Do not use this appliance for commercial use.
16. This appliance is designed for indoor use only and should not be used outdoors.
17. To reduce is the risk of injury, do not allow children to play in or on the appliance. Close supervision is necessary when the appliance is used near children.
18. The appliance door must be closed during operation. Do not leave the door open when children are near the dispenser.
19. DO NOT not attempt to operate this unit with a damaged cord or plug.
20. DO NOT roll the KEGORATOR™ with loaded beer kegs on carpet floor.
21. This appliance is not intended for use by young children or infirm persons without supervision.
22. This appliance is NOT A TOY!
23. Young children should be supervised to ensure that they do not play with this appliance.

## Important Safety Precautions of CO<sub>2</sub> (Carbon Dioxide) Gas

1. CO<sub>2</sub> gas can be dangerous! CO<sub>2</sub> cylinders contain high-pressure compressed gas, which can be hazardous if not handled properly. Make sure you read and understand all the procedures for the CO<sub>2</sub> cylinders before installation.
2. Always connect the CO<sub>2</sub> cylinder to a regulator! Failure to do so may cause an explosion resulting in possible death or injury when the cylinder valve is opened,
3. Never connect the CO<sub>2</sub> cylinder directly to the beer keg.
4. Always follow the correct procedures when changing the CO<sub>2</sub> cylinder.
5. Never drop or throw a CO<sub>2</sub> cylinder.
6. Always keep CO<sub>2</sub> cylinders away from heat. Store extra cylinders in a cool place (preferably 70° F). Secure fasten with a chain in an upright position when storing.
7. Always ventilate and leave the area immediately if CO<sub>2</sub> leakage has occurred!
8. There are two safety devices in the pressure system in the form of a valve. One safety feature is on the CO<sub>2</sub> bottle. The second is on the regulator.
9. Never attempt to refill CO<sub>2</sub> cylinder yourself. CO<sub>2</sub> tanks can be refilled at locations such as welding supply shops, party stores, or wherever kegs are purchased.

**NOTE:** If the refrigerator has been placed in a horizontal or tilted position for any period of time wait 24 hours before plugging the unit in.

### **DANGER!**

**Risk of child entrapment! Before throwing away your old appliance, remove the door so that children may not easily become trapped inside.**

**SAVE THESE INSTRUCTIONS  
For Future Use**

## Introduction

- To ensure that your KEGORATOR™ works to the maximum efficiency it was designed for, keep it in a location where there is proper air circulation and electrical outlets.
- Choose a location where the KEGORATOR™ will be away from heat and will not be exposed to direct sunlight.
- This KEGORATOR™ is designed for **indoor use only** -- it should not be used outdoors.
- This KEGORATOR™ is a freestanding design and should not be placed in a built-in or recessed area.
- Your KEGORATOR™ comes with a 2.5 lb. CO<sub>2</sub> bottle, which should be able to dispense four 15 gallon kegs of beer.
- KEGORATOR™ capacity:  
4.6 cu. ft.
- KEGORATOR™ unit dimensions:  
20.3" W x 32.10" H x 26.20" D
- The following dimensions are recommended for clearances around the KEGORATOR™:  
Sides ..... ¾" (19 mm)  
Back ..... 1" (25 mm)
- KEGORATOR™ unit weight:  
77.6 lbs
- KEGORATOR™ Specs:  
115V 50Hz 1.5A (max amps = 6A)

## Use of Extension Cords

- Avoid using an extension cord because of potential safety hazards in certain conditions. If it is necessary to use an extension cord, use only a 3-wire extension cord that has a 3-blade grounding plug. The cord must be equal to or greater than the electrical rating of the appliance.

## Compatible Keg Types

The KEGORATOR™ can hold one Full Size Keg, or one Pony Keg, or Two 5 Gallon Kegs.

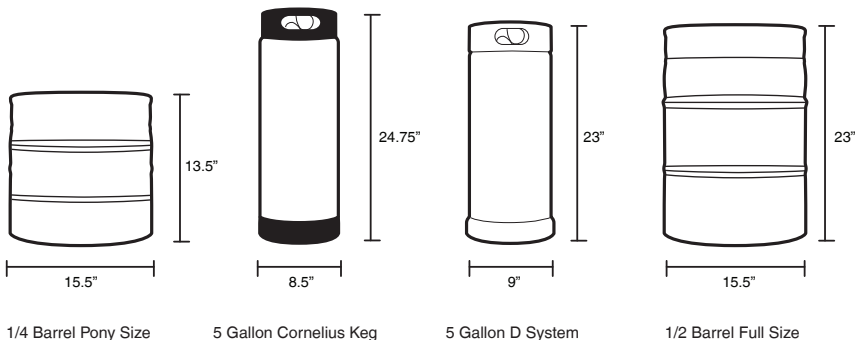

# Parts & Assembly

Read assembly instructions carefully to ensure that you understand all installation instructions before installing the KEGORATOR™. If after completing the process you are still unsure whether the KEGORATOR™ has been properly installed, we recommend that you contact a qualified installer.

**Note:** Allow the KEGORATOR™ to stand in an upright position for about 8 hours before turning on the power. This is very important! Once the unit is laid on it's side, the Freon in the refrigeration unit is shifted. The Freon in the refrigeration unit needs to stabilize before the power is turned on.

## Accessories List

ACCESSORIES	QUANTITY
1. KEG COUPLER	1
2. BACK FLOW STOPPER	1
3. RUBBER WASHER	1
4. CO2 RUBBER DIRECTIONAL WASHER	1
5. BEER TOWER WASHER	1
6. BEER TOWER TAP/BEER HOSE ASSEMBLY	1
7. CO2 REGULATOR	1
8. HIGH PRESSURE WASHER	1
9. CO2 TANK VALVE	1
10. GUARD RAIL	1
11. DRIP PAN TOP	1
12. DRIP PAN	1
13. RUBBER FOOT	4
14. KEG BASE BOARD	1
15. METAL WASHER	4
16. KEGORATOR CASTERS BRAKE	2
17. KEGORATOR CASTERS	2
18. CO2 TANK STRAP	1
19. AIR HOSE WING NUT WASHER	1
20. AIR HOSE	1
21. AIR HOSE CONNECTOR WASHER	1
22. BEER TAP WRENCH	1
23. REGULATOR WRENCH	1
24. BEER TOWER HOLE COVER	1
25. EXTRA WASHERS (3, 4, 8, 19 & 21)	1

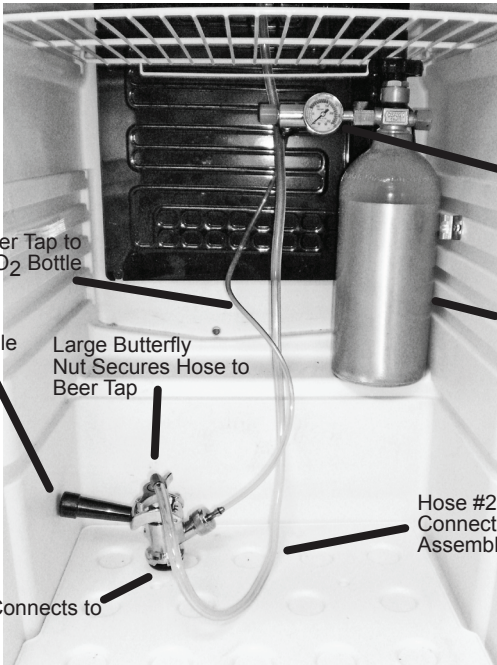
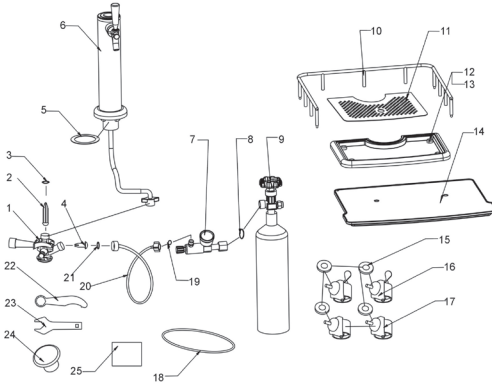

Hose #1  
Connecting Beer Tap to  
Regulator & CO<sub>2</sub> Bottle

CO<sub>2</sub> Bottle  
Regulator

Beer Tap Handle

Large Butterfly  
Nut Secures Hose to  
Beer Tap

CO<sub>2</sub> Bottle

Hose #2  
Connects Dispenser  
Assembly to Beer Tap

Part Connects to  
Keg

# Regulator

The regulator works the Co2 Tank Valve and measures PSI (pounds per square inch), as well as the volume of the Co2 gas in the Cylinder.

**Output Pressure Gauge (0-60 PSI)** for measuring PSI of CO<sub>2</sub> in tank.

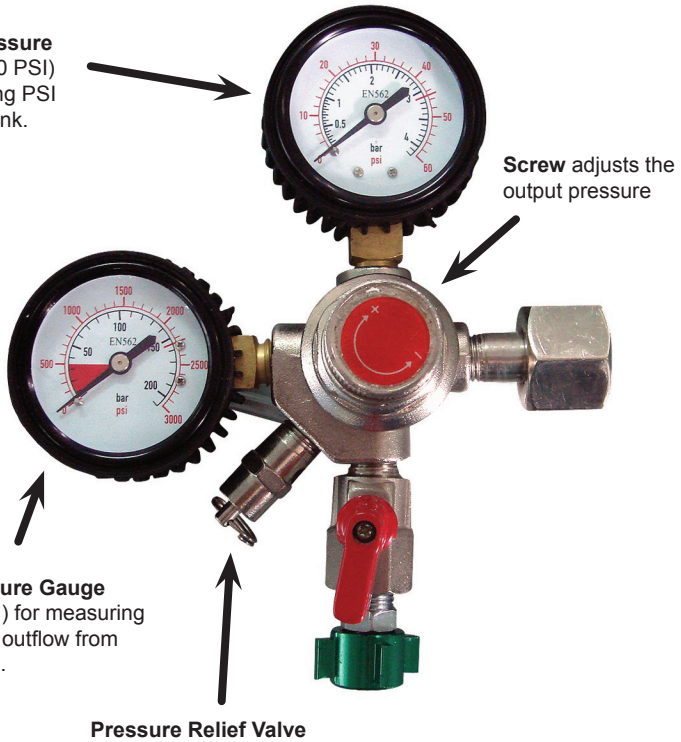

# Installing the CO2 Regulator and the CO2 Cylinder

Follow these steps to safely install the CO<sub>2</sub> regulator and CO<sub>2</sub> cylinder. You must read and understand the following procedures for the CO<sub>2</sub> cylinders before installation.

**NOTE:** If all your rubber washers & O-rings are not pre-installed, please refer to your parts list (pg. 6).

**NOTE:** Your CO<sub>2</sub> cylinder has DOT (USA Department of Transportation) approval, however the cylinder has been shipped empty to avoid any possible accidents during transportation. When you purchase the first keg of beer, you must also have your CO<sub>2</sub> cylinder filled at your local supplier. (see page 2, item 9 for suggested locations within your community)



**STEP 1**  
High pressure washer installed into CO<sub>2</sub> regulator (may already be installed).



**STEP 2**  
Attach regulator to CO<sub>2</sub> tank connector.



Some units may come with this attachment. It is not needed and should be removed from the coupler prior to **STEP 3**.



**STEP 3**  
The CO<sub>2</sub> rubber directional washer goes into the coupler.



**STEP 4**  
Connect the CO<sub>2</sub> line from the regulator to the coupler.



**STEP 5**  
Put one of the backflow stoppers in the coupler (the torpedo goes in with rounded side down).



There are three different possible backflow stoppers.

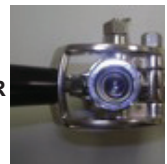



## Installation, contin.



### STEP 6

After the backflow stopper has been inserted, there is a washer that should be placed on top of the coupler.



### STEP 7

After the tap tower has been placed on the refrigerator and the hose line feeds through the bottom, attach the wing nut to the coupler.

## Washers

Below are pictures of some of the extra washers that are included with the KEGORATOR™ and where they belong.

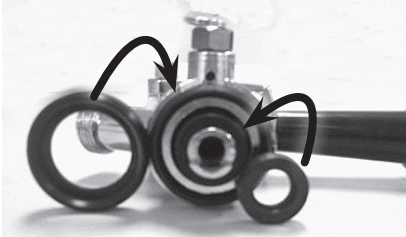

O-rings on the CO<sub>2</sub> line



CO<sub>2</sub> line to regulator



CO<sub>2</sub> line to coupler



O-ring for coupler



O-ring for regulator



O-ring for tap



Tap tower washer goes in between refrigerator and tap tower.



CO<sub>2</sub> tank band

## Installing the Casters

Follow the steps below to install the casters.

1. Empty the inside of the cabinet completely and lay the KEGORATOR™ down on its side. We recommend that you place a piece of cardboard or cloth underneath the cabinet to prevent dents or scratches.
2. Insert the casters into the holes on the bottom corners of the cabinet. Tighten each caster by turning the nut clockwise with a wrench (not provided in the kit).
3. Once all four casters have been tightened, stand the cabinet in its upright position.

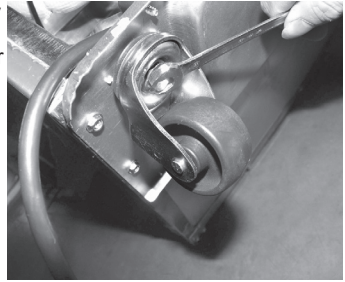

**Note:** Two of the casters include locking mechanisms to ensure the unit does not slide on hard floors. These two locking casters should be fastened at the front end of the unit, with the unlocked casters fastened on the rear end.

## Installing the Beer Tap

Follow the steps below to install the beer tap.

1. Remove the cabinet plug located on the work top. Firmly grasp the cabinet plug, twist and pull upward.

**Note:** Keep this plug in a safe place -- it will be required when using the KEGORATOR™ as a refrigerator without a beer keg in use.

2. There are notches on the bottom of the draft arm assembly that line up with grooves inside the opening in the top of the KEGORATOR™. Align the draft arm with the opening in the top of the unit, then place inside and twist until secure. No screws are necessary, it locks into place simply. The thin black gasket is not mandatory for assembly.

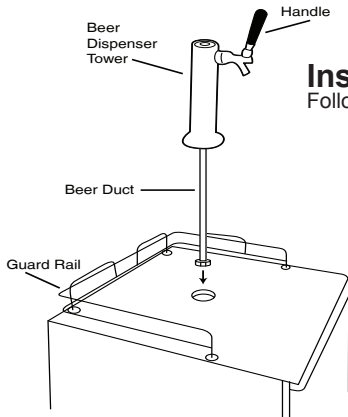
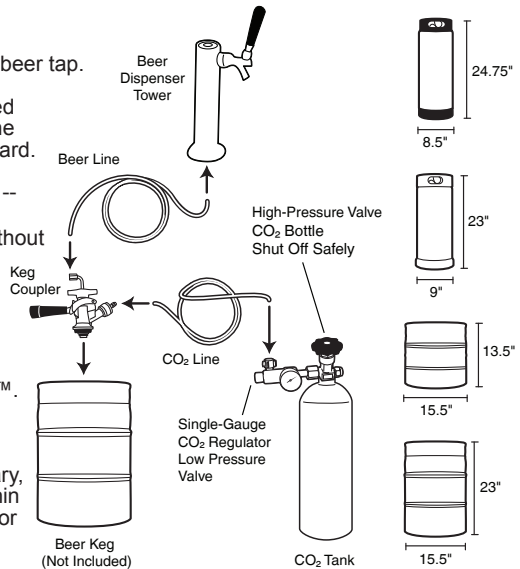

## Installing the Guardrail

Follow these steps below to install the guardrail.

1. Place the guardrail on top of the cabinet.
2. Align all holes of the guardrail with the holes of the cabinet.
3. Secure the guardrail to the cabinet by placing inside corresponding rubber holes.

## Tapping the Beer Keg (Single-Valve Type Barrel)

Follow these steps below to tap the beer keg.

1. Make sure the black pull handle of the coupler is in the closed (up) position before installing it on the keg (Fig. 1 - below). Insert the keg coupler into the locking neck of the beer keg and turn clockwise until it locks into position (Fig. 2 - below). This means that it is secured to the keg.
2. When connecting the beer line to the top of the coupler, it is very important that the wingnut tightens completely. This must be completed prior to inserting the backflow stopper into the coupler.
3. Before attaching the CO<sub>2</sub> line, be sure to insert the rubber directional washer into the side of the coupler. Attach the CO<sub>2</sub> line (see step 3 on pg. 5) and hand-tighten firmly. Secure the tank with CO<sub>2</sub> tank strap.
4. Make sure the beer tower faucet is in the closed (handle pointing straight back) position before connecting the coupler to the keg. To secure the tank connection, pull the coupler handle out and push down until it locks into position. Listen for the "click" of the pull handle when it shifts into the final downward position (Fig. 4 - below). This will open the beer and CO<sub>2</sub> gas valves. The keg is now tapped.
5. Carefully tilt the keg and rest the edge on the keg base board on the bottom of the interior cabinet. Slide the beer keg slowly, ensuring that it is properly located (Fig. 5) and carefully close the door.

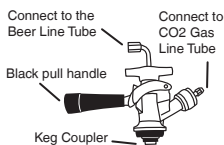
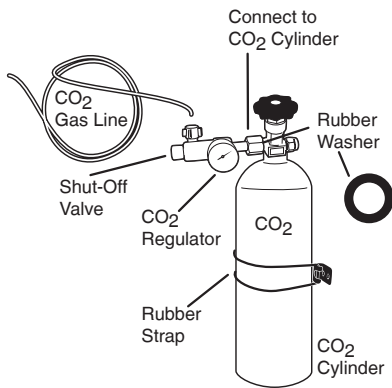

fig. 1

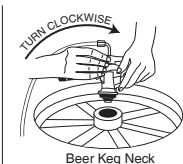

fig. 2



fig. 3

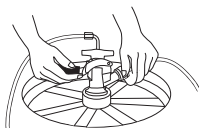

fig. 4

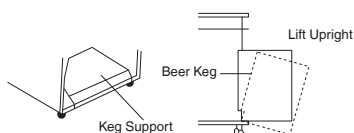

fig. 5

### DANGER!

**CO<sub>2</sub> can be dangerous! CO<sub>2</sub> cylinders contain high-pressured gas, which can be hazardous if handled improperly. They must be handled with care.**

# Operating Your KEGORATOR™

## Dispensing Beer

Follow the steps below to dispense beer.

1. Make sure that the KEGORATOR™ is plugged in properly to a 120V, 60Hz, 15Amps grounded AC outlet.
2. Place the drip tray under the beer faucet to avoid messes from excess beer.
3. Open the beer faucet by pulling the tap towards you to dispense the beer.

**NOTE:** If for any reason the beer does not come out of the tap, please refer to the **Tapping the Beer Keg** section.

4. Increase the pressure if the beer runs too slowly.
5. Hold the glass steady at a 45° angle. When it is 2/3 full, straighten the glass. Proper foam should be a tight creamy head and the collar on an average glass should be ¾" to 1" high, ideally.

**NOTE:** Only open the CO<sub>2</sub> tank 1/4 turn to begin with and then use the regulator to adjust to desired pour. If it is not enough, continue to open the CO<sub>2</sub> tank by 1/4 turn and use regulator until desired setting is reached.

**NOTE:** It is normal to see condensation form on the faucet. It is caused by the difference in temperature between the cold beer and the inside of the faucet when beer is flowing through the line.

## Cleaning & Maintenance

### Flushing the tubes

Follow the steps below to clean the keg tap and hoses. (see illustration below)

1. Turn off CO<sub>2</sub> completely before attempting to clean.
2. Remove the hose from the coupler and carefully twist the dispenser faucet off the top of the KEGORATOR™.
3. Ensure that the dispenser handle is in the down position before flushing the hose. If this is not set correctly, water cannot flow through. Hold the open end of the hose under running water for 3-5 minutes, while the beer dispenser faucet drains into the sink. This will clear any excess beer that is trapped inside, helping to prevent any bacteria or mold that could accumulate inside.
4. In order to clean and remove any excess beer that may leak into the unit space inside the door, remove the black rubber insulation and wipe with a wet towel as needed.

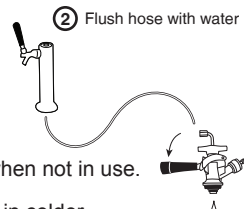
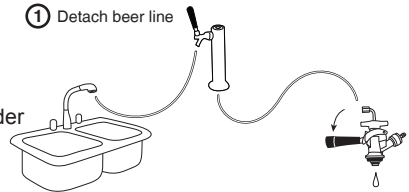

## Storage & Care

Follow the guidelines below to care for your KEGORATOR™ when not in use.

- Please adjust the temperature control dial to MID or LOW in colder environments because this unit does not self-defrost and ice may build up inside the unit. The temperature control dial is located on the back side of the KEGORATOR™ inside the cut out area at the bottom to the lower left.
- Always rinse the beer line if you do not intend to use your KEGORATOR™ for a period of time. First, turn off the CO<sub>2</sub> and dispense beer until it stops. This will release pressure in the keg so that the coupler can safely be detached.
- To avoid permanent damage to the unit, never use sharp objects inside the KEGORATOR™.

# RETURNS & WARRANTY INFORMATION

**SHOULD YOUR UNIT NOT WORK OR IS DAMAGED WHEN YOU FIRST TAKE IT OUT OF THE BOX PLEASE RETURN IT TO THE PLACE OF PURCHASE IMMEDIATELY.**

Should you have any questions, please contact us via email or at the customer service number listed below between the hours of 8:00 AM and 5:00 PM, Monday through Friday, Central Standard Time.

Distributed by:  
Nostalgia Products Group, LLC  
1471 Partnership Dr.  
Green Bay, WI 54304-5685

## **Customer Service**

Phone: (920) 347-9122  
Web: [www.nostalgiaelectrics.com](http://www.nostalgiaelectrics.com)

## **Customer Service Inquiry**

To submit a Customer Service inquiry, go to [www.nostalgiaelectrics.com](http://www.nostalgiaelectrics.com) and fill out the **Customer Service Inquiry** form and click the Submit button. A representative will contact you as soon as possible.

KEGORATOR™  
KRS-2000 Series  
Limited Warranty

This appliance is designed and built to provide many years of satisfactory performance under normal household use. The distributor pledges to the original owner that should there be any defects in material or workmanship during the first 90 days of purchase, we will repair or replace the unit at our option. Our pledge does not apply to damages caused by shipping, mishandling or unit being dropped. A product deemed defective either from manufacturing or being mishandled is up to the distributor's discretion. In order to obtain service under this warranty, please contact Nostalgia Products Group, LLC at the telephone number listed above or by filling out the Customer Service Inquiry Form located at [www.nostalgiaelectrics.com](http://www.nostalgiaelectrics.com).

This warranty does not apply to re-manufactured merchandise.

Please read these instructions carefully. Failure to comply with these instructions, damages caused by improper replacement parts, abuse or misuse will void this pledge to you and is being made in place of all other expressed warranties.









## Free Manuals Download Website

<http://myh66.com>

<http://usermanuals.us>

<http://www.somanuals.com>

<http://www.4manuals.cc>

<http://www.manual-lib.com>

<http://www.404manual.com>

<http://www.luxmanual.com>

<http://aubethermostatmanual.com>

Golf course search by state

<http://golfingnear.com>

Email search by domain

<http://emailbydomain.com>

Auto manuals search

<http://auto.somanuals.com>

TV manuals search

<http://tv.somanuals.com>