



A Precise Positioning Technology Company



# SMART-MR10/15™ User Manual

OM-20000130 Rev 5

---

## SMART-MR10/15 User Manual

**Publication Number:** OM-20000130  
**Revision Level:** 5  
**Revision Date:** March 2012  
**Firmware Version:** SMART-MR10: OEMV 3.900, SmartAgApp 1.201  
SMART-MR15: OEMV 3.900, SmartAgApp 1.302

### Proprietary Notice

Information in this document is subject to change without notice and does not represent a commitment on the part of NovAtel Inc. The software described in this document is furnished under a licence agreement or non-disclosure agreement. The software may be used or copied only in accordance with the terms of the agreement. It is against the law to copy the software on any medium except as specifically allowed in the license or non-disclosure agreement.

No part of this manual may be reproduced or transmitted in any form or by any means, electronic or mechanical, including photocopying and recording, for any purpose without the express written permission of a duly authorized representative of NovAtel Inc.

The information contained within this manual is believed to be true and correct at the time of publication.

ALIGN, GLIDE, NovAtel, OEMV, and RT-20 are registered trademarks of NovAtel Inc.

OEMV-3, RT-2, SMART-MR10, SMART-MR15 and SPAN are trademarks of NovAtel Inc.

The *Bluetooth*® word mark and logos are registered trademarks owned by Bluetooth SIG, Inc. and any use of such marks by NovAtel Inc. is under license. All other brand names are trademarks of their respective holders.

Manufactured and protected under U.S. Patents:

#5,101,416	#6,445,354 B1
#5,390,207	#6,452,560 B2
#5,414,729	#6,466,177 B1
#5,495,499	#6,608,998 B1
#5,734,674	#6,664,923 B1
#5,736,961	#6,728,637 B2
#5,809,064	#7,250,916
#6,184,822 B1	#7,738,536
#6,243,409 B1	#7,738,606



© Copyright 2012 NovAtel Inc. All rights reserved. Unpublished rights reserved under International copyright laws. Printed in Canada on recycled paper. Recyclable.

# Table of Contents

<b>Proprietary Notice</b>	<b>2</b>
<b>Notices</b>	<b>8</b>
<b>Terms and Conditions</b>	<b>11</b>
<b>Software License</b>	<b>13</b>
<b>Warranty</b>	<b>16</b>
<b>Foreword</b>	<b>17</b>
<b>Customer Support</b>	<b>19</b>
<b>Firmware Updates and Model Upgrades</b>	<b>20</b>
<b>1 Introduction</b>	<b>21</b>
1.1 Features.....	21
1.1.1 SMART-MR10 .....	21
1.1.2 SMART-MR15 .....	22
1.2 Box Contents .....	22
1.2.1 SMART-MR10 .....	22
1.2.2 SMART-MR15 .....	22
1.3 Accessories.....	23
1.3.1 SMART-MR15-Specific Accessories .....	23
1.4 Models .....	24
1.4.1 SMART-MR10 .....	24
1.4.2 SMART-MR15 .....	25
1.5 Installing the PC Utilities .....	25
<b>2 Installation</b>	<b>26</b>
2.1 Additional Equipment Required .....	26
2.1.1 Mounting Kits.....	26
2.2 Mounting the SMART-MR10/15.....	31
2.3 Cabling the SMART-MR10/15 .....	31
2.3.1 Connecting the Power Supply .....	36
2.3.2 Status Indicators.....	37
2.3.3 Debugging Guidelines: .....	39
2.3.4 Connecting Data Communications Equipment.....	40
2.4 Additional Installation Information .....	40
2.4.1 MKI and PPS Strobes.....	40
2.4.2 Emulated Radar (ER) .....	40
2.4.3 Controller Area Network (CAN) .....	41
2.4.4 SMART-MR15 CELLULAR ANTENNA INSTALLATION.....	41
2.4.5 SMART-MR15 - Installation Details for Cellular Activation.....	43
<b>3 Operation</b>	<b>46</b>
3.1 Communications with the Receiver.....	46
3.1.1 Serial Port Default Settings .....	46
3.1.2 Communicating Using a Remote Terminal.....	47
3.1.3 Communicating With a Computer.....	47

3.2 Getting Started .....	47
3.2.1 Starting the Receiver .....	48
3.3 Transmitting and Receiving Corrections.....	48
3.3.1 Base Station Configuration .....	50
3.3.2 Rover Station Configuration.....	51
3.3.3 GPS + GLONASS Base and Rover Configuration.....	52
3.3.4 Configuration Notes .....	52
3.3.5 SBAS (Satellite-Based Augmentation Systems).....	53
3.4 GL1DE®.....	54
3.5 ALIGN®.....	54
3.5.1 ALIGN Heading Master and Remote Configurations .....	54
3.6 Emulated Radar (ER) .....	55
3.7 NTRIP Client .....	55
3.8 Recommended Configuration.....	56
<b>4 PC Utilities</b> .....	<b>57</b>
4.1 Connect/Convert4 Installation .....	57
4.2 Connect .....	58
4.3 Convert4 .....	59
4.3.1 RINEX Format.....	59
4.3.2 Convert4 Command Line Switches.....	61
4.4 Firmware Updates and Model Upgrades.....	62
4.4.1 Updating or Upgrading Using the WinLoad Utility.....	62
4.4.2 Upgrading Using the AUTH Command.....	66
<b>5 Bluetooth® Configuration</b> .....	<b>68</b>
5.1 Enable Bluetooth wireless technology on the receiver.....	68
5.2 Set Up a Computer/Laptop with a Bluetooth Adaptor .....	70
5.3 Locate a SMART-MR10 or SMART-MR15 with Bluetooth wireless technology in range.....	70
5.4 Communicate with the SMART-MR10 or SMART-MR15 Using Bluetooth wireless technology.....	71
5.5 Stop Communicating with SMART-MR10 or SMART-MR15 Using Bluetooth wireless technology.....	73
<b>A Technical Specifications</b> .....	<b>74</b>
SMART-MR10/15 Receiver Performance .....	74
SMART-MR10 Specifications .....	75
SMART-MR15 Specifications .....	79
Connector Cables .....	83
Evaluation Cable (Part Number 01018515) .....	83
Streamlined Cable (Part Number 01018526) .....	85
Custom Connector and Cable Requirements .....	87
<b>B Commands</b> .....	<b>88</b>
Syntax Conventions .....	89
BTCONTROL Enable/Disable Bluetooth wireless technology .....	90
CELLACTIVATE Activate CDMA modem for specific carrier .....	91
CELLSET Set the APN name .....	92
COM Configure COM Port .....	93

FRESET Clear Selected Data from NVM and Reset .....	96
LOG Request Logs from the Receiver .....	97
NTRIPCASTER Set NTRIP caster .....	99
NTRIPCLIENT Mount or unmount NTRIP client .....	100
PDPFILTER Enable, disable or reset the PDP filter .....	102
PDPMODE Select the PDP mode and dynamics .....	103
RADARCFG Configure the ER output .....	104
RESET Performs a hardware reset .....	106
SBASCONTROL Set SBAS test mode and PRN .....	107
SETCANNNAME Sets the CAN name fields .....	109
<b>C Logs</b>	<b>110</b>
NMEA Logs .....	110
NovAtel Position Logs .....	112
CELLINFO Cellular Modem and Network Information .....	113
CELLSOCKETSTATUS Modem Call Status Information .....	114
CELLSTATUS Cellular Modem and Network Status Information .....	115
NTRIPSOURCETABLE Source Table Records from Current Caster .....	117
NTRIPSTATUS Status of NTRIP Connection .....	118
RADARSIGNAL ER Signal and Position Information .....	119
VERSION HW & SW Versions and Serial Numbers .....	122
<b>D Replacement Parts</b>	<b>126</b>
SMART-MR10/15 .....	126
Accessories .....	126
Cellular Accessories .....	126
<b>Index</b>	<b>127</b>

# Figures

1	SMART-MR10 Receiver .....	24
2	SMART-MR15 Receiver (GSM/GPRS/HSDPA version) .....	25
3	SMART-MR10/15 Mounting Kit, Quick Release Plate (01018625) .....	27
4	SMART-MR10/15 Mounting Kit, Quick Release Assembly (01018578) .....	28
5	SMART-MR10/15 Mounting Kit, AG GPS 262 (01018623) .....	29
6	SMART-MR10/15 Mounting Kit, 5/8 Inch Adapter (01018624) .....	30
7	SMART-MR10/15 Connector .....	31
8	SMART-MR10 Streamlined Cabling .....	32
9	SMART-MR15 Streamlined Cabling .....	33
10	Cellular Antenna Placement .....	42
11	SIM Cover .....	44
12	SIM Being Installed .....	44
13	SIM Correctly Installed .....	44
14	SIM Ready for Removal .....	44
15	Basic Differential Setup .....	49
16	NTRIP Client Configuration .....	55
17	Convert4 Screen Examples .....	59
18	Convert4 Command Line Arguments .....	61
19	Main Screen of WinLoad .....	64
20	WinLoad's Open Dialog .....	64
21	Open File in WinLoad .....	65
22	COM Port Setup .....	65
23	Searching for Card .....	65
24	Authorization Code Dialog .....	66
25	Upgrade Process Complete .....	66
26	Bluetooth Configuration (SMART-MR10) .....	68
27	Bluetooth Configuration (SMART-MR15) .....	69
28	Bluetooth Adapter for Computer/Laptop .....	70
29	Bluetooth Standby: White .....	70
30	Bluetooth Error: Red .....	70
31	My Bluetooth Places Window .....	71
32	Bluetooth PIN Code Request .....	72
33	Computer/Laptop COM3 Port Assignment .....	72
34	Bluetooth Connected: Green .....	73
35	COM21 Disconnect? .....	73
36	SMART-MR10/15 Evaluation Cable .....	83
37	SMART-MR10/15 Streamlined Cable .....	85

# Tables

1	SMART-MR10 Controller Models.....	24
2	SMART-MR15 Controller Models.....	25
3	SMART-MR10 Connector Pin-Out.....	34
4	SMART-MR10 Use of MODE Pin.....	34
5	SMART-MR15 Connector Pin-Out.....	35
6	SMART-MR15 Use of MODE Pin.....	35
7	SMART-10 LED Status Indicators.....	37
8	SMART-MR15 LED Indicators.....	38
9	Available CAN Signals on SMART-MR10/15 23-pin Tyco Connector.....	41
10	NovAtel Logs for RINEX Conversion.....	60
11	Evaluation Cable Pinouts.....	84
12	Streamlined Cable Pinouts.....	86
13	Mating Connectors.....	87
14	Recommended Fuses.....	87
15	Commonly Used SMART-MR10/15 Commands in Alphabetical Order.....	88
16	COM Serial Port Identifiers.....	94
17	Parity.....	94
18	Handshaking.....	94
19	FRESET Target.....	96
20	Response Modes.....	105
21	Commonly Used SMART-MR10/-MR15 Logs in Alphabetical Order.....	110
22	Position or Velocity Type.....	120
23	Solution Status.....	121
24	Component Type.....	122
25	Model Designators.....	124
26	VERSION Log: Field Formats.....	125

# Notices

The SMART-MR10 and SMART-MR15 are designed for and intended to be used in fixed and mobile applications. "Fixed" means that the device is physically secured at one location and is not able to be easily moved to another location. "Mobile" means that the device is designed to be used in other than fixed locations. These products are not designed to be used as "Portable" devices in applications where they would be closer than 20 cm (8 inches) to the user or any other personnel.

In the case of the SMART-MR15, it is important to follow any special regulations regarding the use of radio equipment due in particular to the possibility of radio frequency (RF) interference. Please follow the safety advice given below carefully.

The following notices apply, as appropriate, to the SMART-MR10 and SMART-MR15.



Changes or modifications to this equipment not expressly approved by NovAtel Inc. could result in violation of FCC, Industry Canada and CE Marking rules and void the user's authorization to operate this equipment.

## Safety



Personnel must be at least 20 cm (8 inches) from the SMART-MR15 cellular antenna. The SMART-MR15 cellular antenna must be mounted such that personnel are never closer than 20 cm (8 inches) to it. For antenna installations on non-metallic vehicle cab roofs, users should exercise extra care that the 20 cm separation distance between the antenna and personnel inside the vehicle will be maintained on the basis of an imaginary line passing through the roof between the antenna and the body of the operator or any passengers.



Switch OFF your SMART-MR10/15 when around gasoline or diesel-fuel pumps and before filling your vehicle with fuel. Respect restrictions on the use of radio equipment in fuel depots, chemical plants or where blasting operations are in progress.



There may be a hazard associated with the operation of your SMART-MR10/15 close to inadequately protected personal medical devices such as hearing aids and pacemakers. Consult the manufacturers of the medical device to determine if it is adequately protected.



Operation of your SMART-MR10/15 close to other electronic equipment may also cause interference if the equipment is inadequately protected. Observe any warning signs and manufacturers' recommendations.





To comply with FCC and Industry Canada regulations limiting both maximum RF output power and human exposure to RF radiation, the maximum system gain (antenna gain minus system loss) must not exceed 0.9 dBi in the U.S. Cellular band and 3.0 dBi in the PCS band for the GSM/GPRS/HSDPA variant, and 6.0 dBi in the Cellular band and 6.0 dBi in the PCS band for the CDMA variant. System loss is the total of external cable and connector losses and SMART-MR15 internal losses. For reference and system gain calculation purposes, the SMART-MR15 has internal losses of 0.6 dB for the 800 MHz Cellular band and 1.8 dB for the 1900 MHz PCS band.

## FCC

This device complies with part 15 of the FCC Rules. Operation is subject to the following two conditions: (1) this device may not cause harmful interference, and (2) this device must accept any interference received, including interference that may cause undesired operation.

SMART-MR10 and SMART-MR15 have been tested and found to comply with the emission limits for a Class B digital device. The Class B limits are designed to provide reasonable protection against harmful interference in a residential installation. SMART-MR10 and SMART-MR15 have been certified by FCC for use in the 2400 MHz - 2483.5 MHz band (FCC ID # UTU01018518).

There are two versions of the SMART-MR15 - a CDMA version and a GSM/GPRS/HSDPA version. The CDMA version (NovAtel part number 01018606) contains FCC ID # RI7CC864-DUAL and the GSM/GPRS/HSDPA version (NovAtel part number 01018712) contains FCC ID # RI7UC864G.

This equipment generates, uses, and can radiate radio frequency energy and, if not installed and used in accordance with the instructions, may cause harmful interference to radio communications. However, there is no guarantee that interference will not occur in a particular installation. If this equipment does cause harmful interference to radio or television reception, which can be determined by turning the equipment off and on, the user is encouraged to try to correct the interference by one or more of the following measures:

- Re-orient or relocate the SMART-MR10/15
- Increase the separation between the equipment and the SMART-MR10/15
- Connect the equipment to an outlet on a circuit different from that to which the SMART-MR10/15 is connected
- Consult the dealer or an experienced radio/TV technician for help



In order to maintain compliance as a Class “B” digital device, shielded cables must be used for the RS-232 serial data ports (Belden 1036A or equivalent) and twisted pair cable should be used for the CAN port (note: shielded twisted pair will also improve CAN performance in electrically harsh environments). I/O signals should be referred to one of the two signal grounds (connector pin 9 or connector pin 15) and not power ground (connector pin 2). If I/O signals route to different areas of the vehicle, dedicated signal grounds for I/O should be spliced into a common connection to one of the two signal grounds (pin 9 or pin 15), at a point close to the SMART-MR10/15.

## Industry Canada

SMART-MR10 and SMART-MR15 Class B digital apparatuses comply with Canadian ICES-003.

SMART-MR10 et SMART-MR15 appareils numérique de la classe B est conforme à la norme NMB-003 du Canada.

## A-tick Marking

The SMART-MR15-HSPA carries the A-tick compliance mark.

## CE Marking

SMART-MR10 and SMART-MR15 enclosures carry the CE mark.

“Hereby, NovAtel Inc. declares that the SMART-MR10 and SMART-MR15 comply with the essential requirements and other relevant provisions of the R&TTE Directive 1999/5/EC and of the EMC Directive 2004/108/EC.”

## WEEE

If you purchased your OEMV® family product in Europe, please return it to your dealer or supplier at the end of its life. The objectives of the European Community's environment policy are, in particular, to preserve, protect and improve the quality of the environment, protect human health and utilise natural resources prudently and rationally. Sustainable development advocates the reduction of wasteful consumption of natural resources and the prevention of pollution. Waste electrical and electronic equipment (WEEE) is regulated by the EU WEEE Directive 2002/96/EC and amendment 2003/108/EC. Where the generation of waste cannot be avoided, it should be reused or recovered for its material or energy. WEEE products may be recognized by their wheeled bin label . <sup>1</sup>

## RoHS

The SMART-MR10 and SMART-MR15 comply with the European Union (EU) Restriction of Hazardous Substances (RoHS) Directive 2002/95/EC.

## Bluetooth®

The SMART-MR10 and SMART-MR15 contain *Bluetooth*® wireless technology. **Bluetooth QD (Qualified Design) ID B015463.**

---

1. Please visit the NovAtel website at [www.novatel.com/products/weee-and-rohs/](http://www.novatel.com/products/weee-and-rohs/) for more information.

# Terms and Conditions

## Standard Terms and Conditions of Sales

**1. PRICES:** All prices are Firm Fixed Price, FCA 1120 - 68th Avenue N.E., Calgary, Alberta. All prices include standard commercial packing for domestic shipment. All transportation, insurance, special packing costs and expenses, and all Federal, provincial and local excise, duties, sales, and other similar taxes are the responsibility of the Purchaser.

**2. PAYMENT:** Terms are prepayment unless otherwise agreed in writing. Interest shall be charged on overdue accounts at the rate of 18% per annum (1.5% per month) from due date. To expedite payment by wire transfer to NovAtel Inc.: Bank - HSBC Bank of Canada

Bank:	HSBC Bank of Canada	US Account #	788889-002
	407 - 8 Avenue S.W.	CDN Account #	788889-001
	Calgary, AB, Canada T2P 1E5	EURO Account #	788889-270
		Transit #	10029-016
		Swift	HKBCCATTCAL

**3. DELIVERY:** Purchaser shall supply shipping instructions with each order. (Ship to and bill to address, NovAtel Quotation #, Preferred carrier and account #, Custom broker/freight forwarder including name and contact #) In the absence of specific instructions, NovAtel may select a carrier and insure Products in transit and charge Purchaser accordingly. NovAtel shall not be responsible for any failure to perform due to unforeseen circumstances or causes beyond its ability to reasonably control. Risk of loss, damage or destruction shall pass to Purchaser upon delivery to carrier. Goods are provided solely for incorporation into the Purchaser's end product and shall not be onward delivered except as incorporated in the Purchaser's end product.

**4. COPYRIGHT AND CONFIDENTIALITY:** Copyright in any specification, drawing, computer software, technical description and other document supplied by NovAtel under or in connection with the Order and all intellectual property rights in the design of any part of the Equipment or provision of services, whether such design be registered or not, shall vest in NovAtel absolutely. The Buyer shall keep confidential any information expressed or confirmed by NovAtel in writing to be confidential and shall not disclose it without NovAtel's prior consent in writing to any third party or use it other than for the operation and maintenance of any Equipment provided.

**5. GENERAL PROVISIONS:** All Purchase Orders are subject to approval and acceptance by NovAtel. Any Purchase Order or other form from the Purchaser, which purports to expand, alter or amend these terms and conditions, is expressly rejected and is and shall not become a part of any agreement between NovAtel and the Purchaser. This agreement shall be interpreted under the laws of the Province of Alberta.

**6. LIMITED WARRANTY AND LIABILITY:** Warranty Period: Products - 1 year; Accessories - 90 days (in each case from the date of invoice). NovAtel warrants that during the Warranty Period that (a) the Product will be free from defects in material and workmanship and conform to NovAtel specifications; (b) the software will be free from error which materially affect performance; and (c) if applicable as defined in the User's Manual, be eligible for access to post contract support and software updates when available. **THESE WARRANTIES ARE EXPRESSLY IN LIEU OF ALL OTHER WARRANTIES, EXPRESS OR IMPLIED, INCLUDING, WITHOUT LIMITATION, ALL IMPLIED WARRANTIES OF MERCHANTABILITY AND FITNESS FOR A PARTICULAR PURPOSE. NOVATEL SHALL IN NO EVENT BE LIABLE FOR SPECIAL, INDIRECT, INCIDENTAL, OR CONSEQUENTIAL DAMAGES OF ANY KIND OR NATURE DUE TO ANY CAUSE.**

Purchaser's exclusive remedy for a claim under this warranty shall be limited to the repair or replacement at NovAtel's option and at NovAtel's facility, of defective or nonconforming materials, parts or components or in the case of software, provision of a software revision for implementation by the Buyer. All material returned under warranty shall be returned to NovAtel prepaid by the Buyer and returned to the Buyer, prepaid by NovAtel. The foregoing warranties do not extend to (i) nonconformities, defects or errors in the Products due to accident, abuse, misuse or negligent use of the Products or use in other than a normal and customary manner, environmental conditions not conforming to NovAtel's specifications, or failure to follow prescribed installation, operating and maintenance procedures, (ii) defects, errors or nonconformities in the Products due to modifications, alterations, additions or changes not made in accordance with NovAtel's specifications or authorized by NovAtel, (iii) normal wear and tear, (iv) damage caused by force of nature or act of any third person, (v) shipping damage, (vi) service or repair of Product by the Purchaser without prior written consent from NovAtel, (vii) Products designated by NovAtel as beta site test samples, experimental, developmental, preproduction, sample, incomplete or out of specification Products, (viii) returned Products if the original identification marks have been removed or altered or (ix) Services or research activities.

**7. EXCLUSION OF LIABILITY:** If a Party would, but for this paragraph (7), have concurrent claims in contract and tort (including negligence) such claims in tort (including negligence) shall to the extent permitted by law be wholly barred, unenforceable and excluded.

NovAtel shall not be liable to the Buyer by way of indemnity or by reason of any breach of the Order or of statutory duty or by reason of tort (including but not limited to negligence) for any loss of profit, loss of use, loss of production, loss of contracts or for any financing costs or for any indirect or consequential damage whatsoever that may be suffered by the Buyer.

In the event and to the extent that NovAtel shall have any liability to Buyer pursuant to the terms of the Order, NovAtel shall be liable to Buyer only for those damages which have been foreseen or might have reasonably been foreseen on the date of effectivity of the Order and which are solely an immediate and direct result of any act or omission of NovAtel in performing the work or any portion thereof under the Order and which are not in the aggregate in excess of ten (10%) percent of the total Order price.

# Software License

**BY INSTALLING, COPYING, OR OTHERWISE USING THE SOFTWARE PRODUCT, YOU AGREE TO BE BOUND BY THE TERMS OF THIS AGREEMENT. IF YOU DO NOT AGREE WITH THESE TERMS OF USE, DO NOT INSTALL, COPY OR USE THIS ELECTRONIC PRODUCT (SOFTWARE, FIRMWARE, SCRIPT FILES, OR OTHER ELECTRONIC PRODUCT WHETHER EMBEDDED IN THE HARDWARE, ON A CD OR AVAILABLE ON THE COMPANY website) (hereinafter referred to as "Software").**

**1. License:** NovAtel Inc. ("NovAtel") grants you a non-exclusive, non-transferable license (not a sale) to, where the Software will be used on NovAtel supplied hardware or in conjunction with other NovAtel supplied software, use the Software with the product(s) as supplied by NovAtel. You agree not to use the Software for any purpose other than the due exercise of the rights and licences hereby agreed to be granted to you.

**2. Copyright:** NovAtel owns, or has the right to sublicense, all copyright, trade secret, patent and other proprietary rights in the Software and the Software is protected by national copyright laws, international treaty provisions and all other applicable national laws. You must treat the Software like any other copyrighted material except that you may make one copy of the Software solely for backup or archival purposes (one copy may be made for each piece of NovAtel hardware on which it is installed or where used in conjunction with other NovAtel supplied software), the media of said copy shall bear labels showing all trademark and copyright notices that appear on the original copy. You may not copy the product manual or written materials accompanying the Software. No right is conveyed by this Agreement for the use, directly, indirectly, by implication or otherwise by Licensee of the name of NovAtel, or of any trade names or nomenclature used by NovAtel, or any other words or combinations of words proprietary to NovAtel, in connection with this Agreement, without the prior written consent of NovAtel.

**3. Patent Infringement:** NovAtel shall not be liable to indemnify the Licensee against any loss sustained by it as the result of any claim made or action brought by any third party for infringement of any letters patent, registered design or like instrument of privilege by reason of the use or application of the Software by the Licensee or any other information supplied or to be supplied to the Licensee pursuant to the terms of this Agreement. NovAtel shall not be bound to take legal proceedings against any third party in respect of any infringement of letters patent, registered design or like instrument of privilege which may now or at any future time be owned by it. However, should NovAtel elect to take such legal proceedings, at NovAtel's request, Licensee shall co-operate reasonably with NovAtel in all legal actions concerning this license of the Software under this Agreement taken against any third party by NovAtel to protect its rights in the Software. NovAtel shall bear all reasonable costs and expenses incurred by Licensee in the course of co-operating with NovAtel in such legal action.

**4. Restrictions: You may not:**

- (a) copy (other than as provided for in paragraph 2), distribute, transfer, rent, lease, lend, sell or sublicense all or any portion of the Software except in the case of sale of the hardware to a third party;
- (b) modify or prepare derivative works of the Software;
- (c) use the Software in connection with computer-based services business or publicly display

visual output of the Software;

- (d) transmit the Software over a network, by telephone or electronically using any means (except when downloading a purchased upgrade from the NovAtel website); or
- (e) reverse engineer, decompile or disassemble the Software.

You agree to keep confidential and use your best efforts to prevent and protect the contents of the Software from unauthorized disclosure or use.

**5. Term and Termination:** This Agreement and the rights and licences hereby granted shall continue in force in perpetuity unless terminated by NovAtel or Licensee in accordance herewith. In the event that the Licensee shall at any time during the term of this Agreement: i) be in breach of its obligations hereunder where such breach is irremediable or if capable of remedy is not remedied within 30 days of notice from NovAtel requiring its remedy; then and in any event NovAtel may forthwith by notice in writing terminate this Agreement together with the rights and licences hereby granted by NovAtel. Licensee may terminate this Agreement by providing written notice to NovAtel. Upon termination, for any reasons, the Licensee shall promptly, on NovAtel's request, return to NovAtel or at the election of NovAtel destroy all copies of any documents and extracts comprising or containing the Software. The Licensee shall also erase any copies of the Software residing on Licensee's computer equipment. Termination shall be without prejudice to the accrued rights of either party, including payments due to NovAtel. This provision shall survive termination of this Agreement howsoever arising.

**6. Warranty:** NovAtel does not warrant the contents of the Software or that it will be error free. The Software is furnished "AS IS" and without warranty as to the performance or results you may obtain by using the Software. The entire risk as to the results and performance of the Software is assumed by you. See product enclosure, if any for any additional warranty.

**7. Indemnification:** NovAtel shall be under no obligation or liability of any kind (in contract, tort or otherwise and whether directly or indirectly or by way of indemnity contribution or otherwise howsoever) to the Licensee and the Licensee will indemnify and hold NovAtel harmless against all or any loss, damage, actions, costs, claims, demands and other liabilities or any kind whatsoever (direct, consequential, special or otherwise) arising directly or indirectly out of or by reason of the use by the Licensee of the Software whether the same shall arise in consequence of any such infringement, deficiency, inaccuracy, error or other defect therein and whether or not involving negligence on the part of any person.

**8. Disclaimer and Limitation of Liability:**

- (a) **THE WARRANTIES IN THIS AGREEMENT REPLACE ALL OTHER WARRANTIES, EXPRESS OR IMPLIED, INCLUDING ANY WARRANTIES OF MERCHANTABILITY OR FITNESS FOR A PARTICULAR PURPOSE. NovAtel DISCLAIMS AND EXCLUDES ALL OTHER WARRANTIES. IN NO EVENT WILL NovAtel's LIABILITY OF ANY KIND INCLUDE ANY SPECIAL, INCIDENTAL OR CONSEQUENTIAL DAMAGES, INCLUDING LOST PROFITS, EVEN IF NovAtel HAS KNOWLEDGE OF THE POTENTIAL LOSS OR DAMAGE.**
- (b) NovAtel will not be liable for any loss or damage caused by delay in furnishing the Software or any other performance under this Agreement.
- (c) NovAtel's entire liability and your exclusive remedies for our liability of any kind (including liability for negligence) for the Software covered by this Agreement and all other performance or non-performance by NovAtel under or related to this Agreement are to the remedies specified by this Agreement.

**9. Governing Law:** This Agreement is governed by the laws of the Province of Alberta, Canada. Each of the parties hereto irrevocably attorns to the jurisdiction of the courts of the Province of Alberta.

**10. Customer Support:** For Software UPDATES and UPGRADES, and regular customer support, contact the NovAtel GPS Hotline at 1-800-NOVATEL (U.S. or Canada only), or +1-403-295-4900, Fax +1-403-295-4901, email to support@novatel.ca, website: <http://www.novatel.com> or write to:

NovAtel Inc. Customer Service Department  
1120 - 68 Avenue NE  
Calgary, Alberta, Canada T2E 8S5

# Warranty

NovAtel Inc. warrants that its products are free from defects in materials and workmanship, subject to the conditions set forth below, for the following periods of time, from the date of sale:

SMART-MR10 and SMART-MR15	One (1) Year
Antenna	One (1) Year
Cables and Accessories	Ninety (90) Days
Computer Discs	Ninety (90) Days
Software Warranty	One (1) Year

Date of sale shall mean the date of the invoice to the original customer for the product. NovAtel's responsibility respecting this warranty is solely to product replacement or product repair at an authorized NovAtel location, or in the case of software, provision of a software revision for implementation by the customer.

Determination of replacement or repair will be made by NovAtel personnel or by technical personnel expressly authorized by NovAtel for this purpose.

**THE FOREGOING WARRANTIES DO NOT EXTEND TO (I) NONCONFORMITIES, DEFECTS OR ERRORS IN THE PRODUCTS DUE TO ACCIDENT, ABUSE, MISUSE OR NEGLIGENT USE OF THE PRODUCTS OR USE IN OTHER THAN A NORMAL AND CUSTOMARY MANNER, ENVIRONMENTAL CONDITIONS NOT CONFORMING TO NOVATEL'S SPECIFICATIONS, OR FAILURE TO FOLLOW PRESCRIBED INSTALLATION, OPERATING AND MAINTENANCE PROCEDURES, (II) DEFECTS, ERRORS OR NONCONFORMITIES IN THE PRODUCTS DUE TO MODIFICATIONS, ALTERATIONS, ADDITIONS OR CHANGES NOT MADE IN ACCORDANCE WITH NOVATEL'S SPECIFICATIONS OR AUTHORIZED BY NOVATEL, (III) NORMAL WEAR AND TEAR, (IV) DAMAGE CAUSED BY FORCE OF NATURE OR ACT OF ANY THIRD PERSON, (V) SHIPPING DAMAGE; OR (VI) SERVICE OR REPAIR OF PRODUCT BY THE DEALER WITHOUT PRIOR WRITTEN CONSENT FROM NOVATEL. IN ADDITION, THE FOREGOING WARRANTIES SHALL NOT APPLY TO PRODUCTS DESIGNATED BY NOVATEL AS BETA SITE TEST SAMPLES, EXPERIMENTAL, DEVELOPMENTAL, PREPRODUCTION, SAMPLE, INCOMPLETE OR OUT OF SPECIFICATION PRODUCTS OR TO RETURNED PRODUCTS IF THE ORIGINAL IDENTIFICATION MARKS HAVE BEEN REMOVED OR ALTERED. THE WARRANTIES AND REMEDIES ARE EXCLUSIVE AND ALL OTHER WARRANTIES, EXPRESS OR IMPLIED, WRITTEN OR ORAL, INCLUDING THE IMPLIED WARRANTIES OF MERCHANTABILITY OR FITNESS FOR ANY PARTICULAR PURPOSE ARE EXCLUDED. NOVATEL SHALL NOT BE LIABLE FOR ANY LOSS, DAMAGE, EXPENSE, OR INJURY ARISING DIRECTLY OR INDIRECTLY OUT OF THE PURCHASE, INSTALLATION, OPERATION, USE OR LICENSING OF PRODUCTS OR SERVICES. IN NO EVENT SHALL NOVATEL BE LIABLE FOR SPECIAL, INDIRECT, INCIDENTAL OR CONSEQUENTIAL DAMAGES OF ANY KIND OR NATURE DUE TO ANY CAUSE.**

There are no user serviceable parts in the NovAtel receiver and no maintenance is required. When the status code indicates that a unit is faulty, replace with another unit and return the faulty unit to NovAtel Inc.

Before shipping any material to NovAtel or Dealer, please contact Customer Support. You can e-mail [support@novatel.com](mailto:support@novatel.com) or visit our website at [www.novatel.com](http://www.novatel.com) and log in through *Support | Helpdesk & Solutions | E-Service*.

When Customer Support confirms the faulty equipment needs to be returned, you will be referred to the repair group where you will be given an RMA number and be advised of proper shipping procedures to return any defective product.



## Congratulations!

Congratulations on your purchase. Your smart antenna is capable of receiving GPS L1+L2, GLONASS L1+L2, and L-band signals, with exceptional flexibility and performance. The SMART-MR15 also includes an integrated cellular modem for access to wireless RTK corrections with minimal effort.

NovAtel is an industry leader in state-of-the-art Global Navigation Satellite Systems (GNSS) receiver design. We believe that our product will meet your high expectations, and are working hard to ensure that future products and enhancements maintain this level of satisfaction.

This is your primary hardware and software reference.

## Scope

This manual provides sufficient detail to allow you to effectively integrate and fully operate your SMART-MR10/15. The information in this manual is a companion to the information in the *OEMV Firmware Reference Manual* and the *OEMV Installation and Operation User Manual*.

After the addition of accessories and a power supply, your smart antenna is ready to go.

SMART-MR10/15 utilize a comprehensive user-interface command structure, which require communication through communications (COM) ports. The manual describes commands and logs specific to the SMART-MR10/15, For more information, see *Commands* starting on *page 88* and *Logs* starting on *page 110*.

Other supplementary manuals are available on the accompanying CD and on our website at [www.novatel.com/support/firmware-software-and-manuals/product-manuals-and-doc-updates/](http://www.novatel.com/support/firmware-software-and-manuals/product-manuals-and-doc-updates/), to aid you in using the other commands and logs available in the OEMV family of receivers.

PC Utilities are also described, see *Chapter 4* starting on *page 57*. Integrated with Connect software, these utilities provide graphical user interfaces for logging to a PC/laptop, upgrading, and converting data types.

## Prerequisites



The installation chapters of this document provide information concerning installation requirements and considerations for SMART-MR10/15. To run the PC software supplied, your personal computer must meet or exceed this minimum configuration:

- Windows-compatible mouse or pointing device and SVGA display

Although previous experience with Windows is not necessary to use Connect, familiarity with certain actions that are customary in Windows will assist in the use of the program. This manual has been written with the expectation that you already have a basic familiarity with Windows.

## Conventions

The following conventions are used in this manual:

	Note that provides information to supplement or clarify the accompanying text.
	Caution that a certain action, operation or configuration may result in incorrect or improper use of the product.
	Warning that a certain action, operation or configuration may result in regulatory noncompliance, safety issues or equipment damage.

Log and command conventions include the following:

- The letter H in the *Offset* columns of the commands and logs tables represents the header length for that command or log. Refer to the *OEMV Family Firmware Reference Manual* for ASCII and binary header details.
- The number following 0x is a hexadecimal number.
- Command descriptions' brackets, [ ], represent the optionality of parameters.
- In tables where values are missing, they are assumed to be reserved for future use.
- Status words are output as hexadecimal numbers and must be converted to binary format (and in some cases then also to decimal). For an example of this type of conversion, please refer to the RANGE log in the *OEMV Family Firmware Reference Manual*.
- Conversions and their binary or decimal results are always read from right to left

See also *Section B.1, Syntax Conventions* on *page 89* for additional log and command conventions.

## NovAtel Knowledge Database

If you have a technical issue, try the NovAtel knowledge database on the NovAtel website at [www.novatel.com](http://www.novatel.com) through Support | Helpdesk & Solutions | Search Known Solutions. Through the knowledge database, you can keyword search for general information about GNSS, information about NovAtel hardware and software, installation and operation issues, and general technology.

## Before Contacting Customer Support

Before contacting NovAtel Customer Support about a software problem perform the following steps:

1. Log the following data to a file on your PC for 15 minutes

```
RXSTATUSB once
RAWEPHEMB onchanged
RANGEB ontime 1
BESTPOSB ontime 1
RXCONFIGA once
VERSIONB once
CELLSTATUSA onchanged [SMART-MR15 only]
```

To run these logs you can connect to one of the COM ports, then use NovAtel Connect, described in *Connect on page 58*, through Tools | Logging Control Window, or terminal software.

2. Send the file containing the logs to NovAtel Customer Support using the [support@novatel.com](mailto:support@novatel.com) e-mail address.
3. You can also issue a factory reset (FRESET) to the receiver to clear any unknown settings.



The FRESET command will erase all user settings. You should know your configuration and be able to reconfigure the receiver before you send the FRESET command.

If you are having a hardware problem, send a list of the troubleshooting steps taken results.

## Contact Information

Phone: 1-800-NOVATEL (U.S. & Canada) or +1-403-295-4900 (international)	
Fax: +1-403-295-4901 E-mail: <a href="mailto:support@novatel.com">support@novatel.com</a> Website: <a href="http://www.novatel.com">www.novatel.com</a>	Write: NovAtel Inc. Customer Support Department 1120 - 68 Avenue NE Calgary, AB Canada, T2E 8S5

## Firmware Updates and Model Upgrades

Firmware *updates* are firmware releases, which include fixes and enhancements to the receiver functionality. Firmware updates are released on the website as they become available. Model *upgrades* enable features, such as RTK and ALIGN, on the receiver and may be purchased through NovAtel authorized dealers.

Contact your local NovAtel dealer first for more information. To locate a dealer in your area visit our website at [www.novatel.com/where-to-buy/dealers/](http://www.novatel.com/where-to-buy/dealers/) or contact NovAtel Customer Support directly.

Refer to *PC Software and Firmware, Firmware Upgrades* in the *OEMV Family Installation and Operation User Manual* for instructions on using the WinLoad program to upgrade your OEMV receiver.

The SMART-MR10/15 are rugged dual-constellation, dual-frequency smart antennas designed for on-machine applications in the agricultural, construction and industrial market segments. They both consist of a high-performance GNSS receiver and antenna, capable of receiving and tracking different combinations of GPS+GLONASS L1+L2 code and carrier signals, and L-band signals, on a maximum of 72 channels. Once you connect the SMART-MR10 or SMART-MR15 to a vehicle, they begin operating as a fully functional GNSS system.

The SMART-MR10/15 support the following position modes:

- Autonomous
- SBAS (Satellite Based Augmentation Systems), including WAAS, EGNOS, and MSAS.
- DGPS
- OmniSTAR VBS/HP/XP
- CDGPS
- NovAtel GLIDE®, RT-20®, RT-2™ and RT-2L

For more information about the above, refer to the Support page on the NovAtel website at: [www.novatel.com](http://www.novatel.com).

## 1.1 Features

### 1.1.1 SMART-MR10

The main features of the SMART-MR10 are as follows:

- Enhanced high performance GPS+GLONASS L1+L2 and L-band receiver (NovAtel OEMV-3™)
- High performance GPS+GLONASS L1+L2 and L-band antenna
- Emulated Radar output
- CAN port
- Three (3) RS-232 COM ports, one of which can be configured with flow control, or user-switched to RS-422
- Rugged, water and dust tight enclosure, consisting of a cast aluminum base and plastic radome
- *Bluetooth* version 2.0
- Three (3) daylight viewable status LED indicators
- Range of installation options, including a quick-release mounting plate and a 5m power/data cable with tinned/tagged wires

## 1.1.2 SMART-MR15

The main features of the SMART-MR15 are as follows:

- Cellular communication connectivity options including Carrier Division Multiple Access (CDMA) and Global System for Mobile Communications/General Packet Radio Service / High Speed Downlink Packet Access (GSM/GPRS/HSDPA)
- Enhanced high performance GPS+GLONASS L1+L2 and L-band receiver (NovAtel OEMV-3™)
- Embedded NTRIP v2.0 client
- High performance GPS+GLONASS L1+L2 and L-band antenna
- Emulated Radar output
- CAN port
- Two (2) RS-232 COM ports, one of which can be configured with flow control, or user-switched to RS-422
- Rugged, water and dust tight enclosure, consisting of a cast aluminum base and plastic radome
- *Bluetooth* version 2.0
- Three (3) daylight viewable status LED indicators
- Range of installation options, including a quick-release mounting plate and a 5m power/data cable with tinned/tagged wires

## 1.2 Box Contents

### 1.2.1 SMART-MR10

The following are provided with your SMART-MR10:

- 1 - SMART-MR10 Quick Start Guide
- 1 - CD containing:
  - An installation program for NovAtel's Connect graphical user interface software
  - Product documentation
- 1 - User Manual postcard for requesting printed manuals

### 1.2.2 SMART-MR15

The following are provided with your SMART-MR15:

- 1 - SMART-MR15 Quick Start Guide
- 1 - SMART-MR15 Cellular Activation Quick Start Guide
- 1 - CD containing:
  - An installation program for NovAtel's Connect graphical user interface software
  - Product documentation
- 1 - User Manual postcard for requesting printed manuals

## 1.3 Accessories

The following interface cables can be ordered as accessories:

- Evaluation cable (NovAtel part number 01018515) with a 23-pin connector on one end and three DB-9 connectors and exposed tinned wires for power, ER, ground, MKI, MODE, PPS and CAN, on the other. This cable is designed to allow the rapid deployment and evaluation of your receiver on a construction or agricultural vehicle. All signals are wired out in this cable. Refer to *Appendix A.4, Connector Cables* starting on *page 83* for details.
- Streamlined cable (NovAtel part number 01018526) with two DB-9 connectors, and exposed tinned wires for power, ground and ER. This cable provides connection for power, two serial ports, and emulated radar. It has been designed for permanent installation. The cable material is capable of withstanding a wide temperature range and will not be damaged by exposure to chemicals. See *Appendix A.4.2, Streamlined Cable (Part Number 01018526)* starting on *page 85* for details.

Four mounting plates are available for the SMART-MR10 and the SMART-MR15, and these can also be ordered as accessories:

- Universal mounting plate (70023085)
- AG GPS 262 layout mounting plate (70023086)
- Pole-mount (70023087)
- Quick-release kit (01018578)

For more information about the mounting plates, see *Section 2.1.1, Mounting Kits on Page 26*.

### 1.3.1 SMART-MR15-Specific Accessories

In addition to the above cable and mounting accessories, the following accessories are available for the SMART-MR15:

- CDMA Antenna, 2.2 / 4 dBi, 824-896 MHz / 1850-1990 MHz, NMO [NovAtel part number 12023296] (USE with 12023301 Mount)
- CDMA Antenna Mount, NMO Magnetic Base, 30 cm cable [NovAtel part number 12023301] (DO NOT USE with 12023303 Antenna)
- GSM/GPRS/HSDPA Antenna, 3 / 4 dBi, 806-960 MHz / 1710-2500 MHz, NMO [NovAtel part number 12023303]. (DO NOT USE with 12023301 Base. Use this antenna with the 12023300 mount only.)
- GSM/GPRS/HSDPA Antenna Mount, NMO Magnetic Base, 3.65 m cable [NovAtel part number 12023300] (USE with 12023303 Antenna)
- Antenna Ground Plane Kit, for use on non-metallic mounting surfaces [NovAtel part number 01018684]

## 1.4 Models

### 1.4.1 SMART-MR10

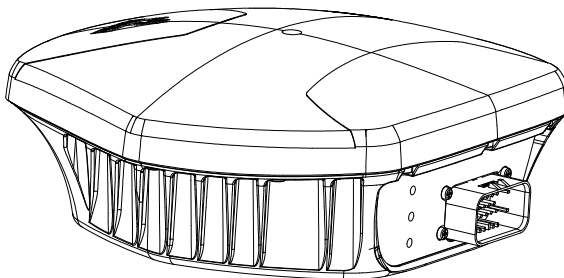

**Figure 1: SMART-MR10 Receiver**

Figure 1 shows the SMART-MR10 without connecting cables. The SMART-MR10 is available in several different firmware models whose configurations may include additional features. Table 1 summarizes the available models. Contact your NovAtel dealer to get up-to-date information on available models. For a list of dealers in your area, visit the NovAtel website at [www.novatel.com/where-to-buy/dealers/](http://www.novatel.com/where-to-buy/dealers/).

**Table 1: SMART-MR10 Controller Models**

Model Name	Firmware Feature
SMART-MR10-RT2-G	GPS plus GLONASS 1 cm real-time kinematic positions, RT-2 corrections and raw data, code positions and DGPS, OmniSTAR HP/XP/VBS, CDGPS, SBAS, 20 Hz
SMART-MR10-HP-G	GPS plus GLONASS dual-frequency code positions, SBAS, DGPS, OmniSTAR G2/HP/XP/VBS, CDGPS, 20 Hz
SMART-MR10-SBAS-PVT1-G	GPS plus GLONASS single-frequency code positions, SBAS, DGPS, 20 Hz
SMART-MR10-G-Z	GPS plus GLONASS heading vector, including heading and separation between master and remote; 10 Hz; must be paired with another receiver, DGPS



## 1.4.2 SMART-MR15

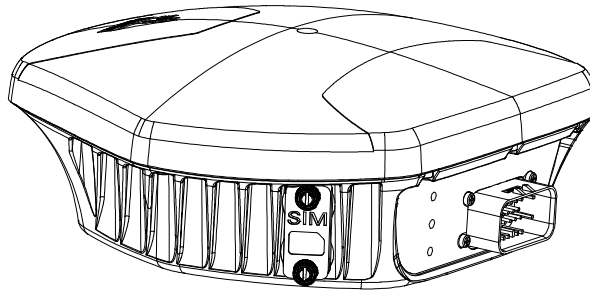

**Figure 2: SMART-MR15 Receiver (GSM/GPRS/HSDPA version)**

Figure 2 shows the SMART-MR15 without connecting cables. The SMART-MR15 is available in several different firmware models whose configurations may include additional features. Table 2 summarizes the available models. Contact your NovAtel dealer to get up-to-date information on available models. For a list of dealers in your area, visit the NovAtel website at [www.novatel.com/where-to-buy/dealers/](http://www.novatel.com/where-to-buy/dealers/).

**Table 2: SMART-MR15 Controller Models**

Model Name	Firmware Feature
SMART-MR15-RT2-G	GPS plus GLONASS 1 cm real-time kinematic positions, RT-2 corrections and raw data, code positions and DGPS, OmniSTAR HP/XP/VBS, CDGPS, SBAS, 20 Hz

## 1.5 Installing the PC Utilities

The first thing you need to do is install the PC utilities on the computer you will use to configure the unit. The utilities include Connect, a graphical user interface program, and Convert4, for converting data file formats.

1. Start up the PC/laptop.
2. Insert the accompanying CD in the CD-ROM drive of the computer.



You can obtain the latest Connect (and PC utilities) version from the NovAtel website at [www.novatel.com/support/firmware-software-and-manuals/firmware-software-updates/](http://www.novatel.com/support/firmware-software-and-manuals/firmware-software-updates/).

3. Select *Install NovAtel's PC Utilities* from the window that is automatically displayed.



If the window does not automatically open when the CD is inserted, select *Run* from the *Start* menu and select the *Browse* button to locate *Setup.exe* on the CD drive.

4. Install the PC Utilities by advancing through the steps provided in the *NovAtel PC Utilities* setup program.

This chapter contains instructions for mounting and cabling your SMART-MR10/15.

## 2.1 Additional Equipment Required

The following additional equipment is required:

- Mounting kit (see *Section 2.1.1, Mounting Kits* for details of mounting kits available for the SMART-MR10/15)
- SMART-MR10/15 cable (see *Appendix D Replacement Parts* starting on *page 126* for part numbers). Refer to *Figure 8, SMART-MR10 Streamlined Cabling on page 32* for COM and power connections.
- A fused power supply (user-supplied)

### 2.1.1 Mounting Kits



When you are using your own mounting plate, adhere to the following guidelines for maximum and minimum mounting-screw length:

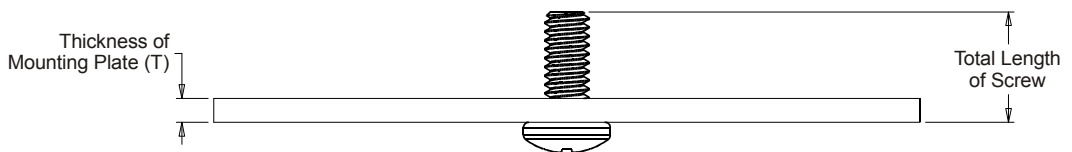

To ensure proper installation of your mounting plate to the SMART-MR10 and SMART-MR15 units, the total length of the mounting screws must be:

- $[T" + 0.45"]$  maximum and  $[T" + 0.25"]$  minimum for 1/4-20 screws or
- $[Tmm + 11.5mm]$  maximum and  $[Tmm + 7mm]$  minimum for M6x1 screws.

Several NovAtel mounting kits are available, all of which come with four 1/4-20 screws for mounting the SMART-MR10/15 to the mounting plate:

- Mounting Kit, Quick Release Plate (part number 01018625), shown in *Figure 3 on page 27*.
- Mounting Kit, Quick Release Assembly (part number 01018578), shown in *Figure 4 on page 28*.



The Mounting Kit, Quick Release Assembly (part number 01018578) includes a Mounting Kit, Quick Release Plate (part number 01018625).

- Mounting Kit, AG GPS 262 (part number 01018623), shown in *Figure 5 on page 29*.
- Mounting Kit, 5/8 Inch Adapter (part number 01018624), shown in *Figure 6 on page 30*.

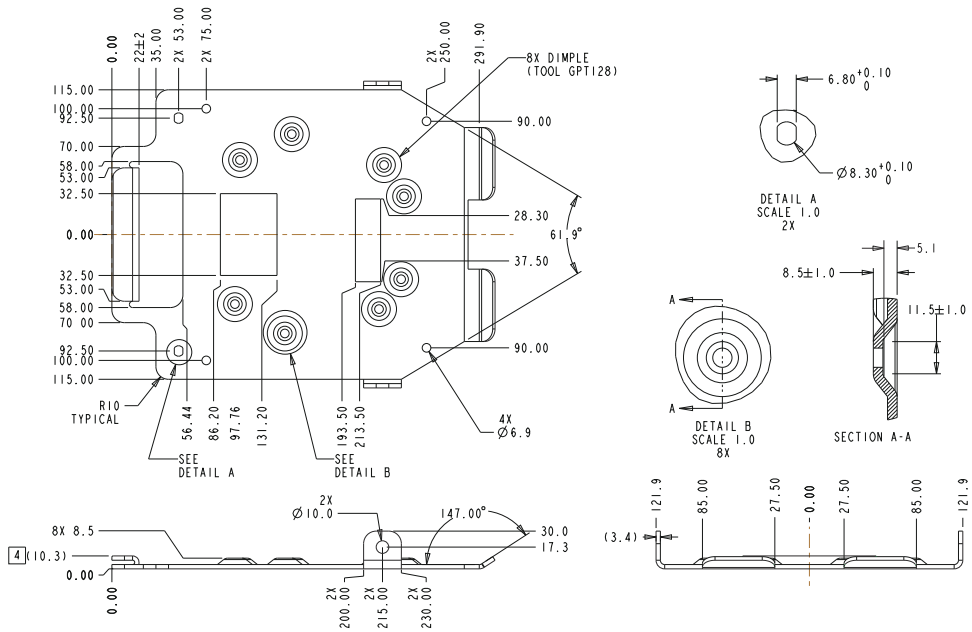

NOTE: THE 01018625 MOUNTING KIT INCLUDES FOUR 1/4-20 SCREWS AND TWO QUICK RELEASE LATCHES (PART NUMBER 24023026).

Note: Dimensions shown are in millimetres.

**Figure 3: SMART-MR10/15 Mounting Kit, Quick Release Plate (01018625)**



All measurements are in millimetres unless otherwise specified.

The 01018625 mounting kit can be used in several configurations:

- Stand-alone plate that is hard-mounted onto the implement
- Hard-mounted or quick-release mounted onto an intermediate plate
- As part of Mounting Kit, Quick Release Assembly, NovAtel part number 01018578



The mounting holes in the SMART-MR10/15 will align with the dimple locations in the mounting plate. The 1/4-20 holes form a rectangular pattern. The M6x1 holes form a trapezoidal pattern. Refer to the mechanical drawings in *Appendix A.2 SMART-MR10 Specifications* starting on page 75 and *Appendix A.3 SMART-MR15 Specifications* starting on page 79 for further information.



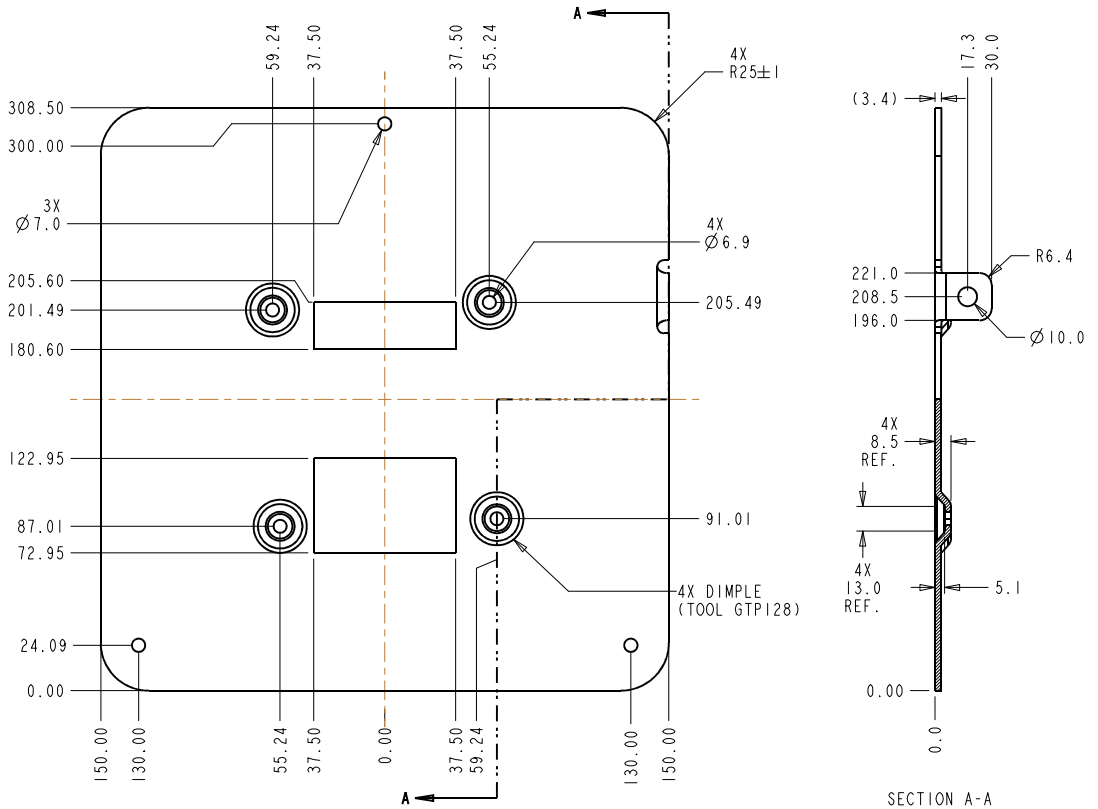

**Figure 5: SMART-MR10/15 Mounting Kit, AG GPS 262 (01018623)**

- 

• All measurements are in millimetres unless otherwise specified.

• The 1/4-20 mounting holes in the SMART-MR10/15 will align with the dimple locations in the Mounting Kit, AG GPS 262 mounting plate. Refer to the mechanical drawings in *Appendix A.2 SMART-MR10 Specifications* starting on page 75 and *Appendix A.3 SMART-MR15 Specifications* starting on page 79 for further information.



## 2.2 Mounting the SMART-MR10/15

When installing the SMART-MR10 or SMART-MR15:

- Choose a location that has a clear view of the sky so that each satellite above the horizon can be tracked without obstruction.
- Mount the SMART-MR10 or SMART-MR15 on a secure, stable structure capable of safe operation in the specific environment. A typical installation is on the vehicle roof.

## 2.3 Cabling the SMART-MR10/15

1. Connect the cable to the SMART-MR10 or SMART-MR15 connector, shown in *Figure 7 below*. Route the cable to the other system components and secure it. If you are using the NovAtel streamlined cable, the system is as illustrated in *Figure 8, SMART-MR10 Streamlined Cabling on page 32* and *Figure 9, SMART-MR15 Streamlined Cabling on page 33*. The pinouts for the SMART-MR10/15 connector are described in *Table 3, SMART-MR10 Connector Pin-Out on page 34* and *Table 5, SMART-MR15 Connector Pin-Out on page 35*.

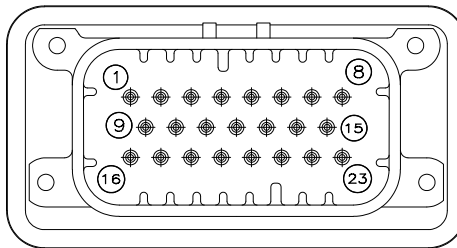

**Figure 7: SMART-MR10/15 Connector**

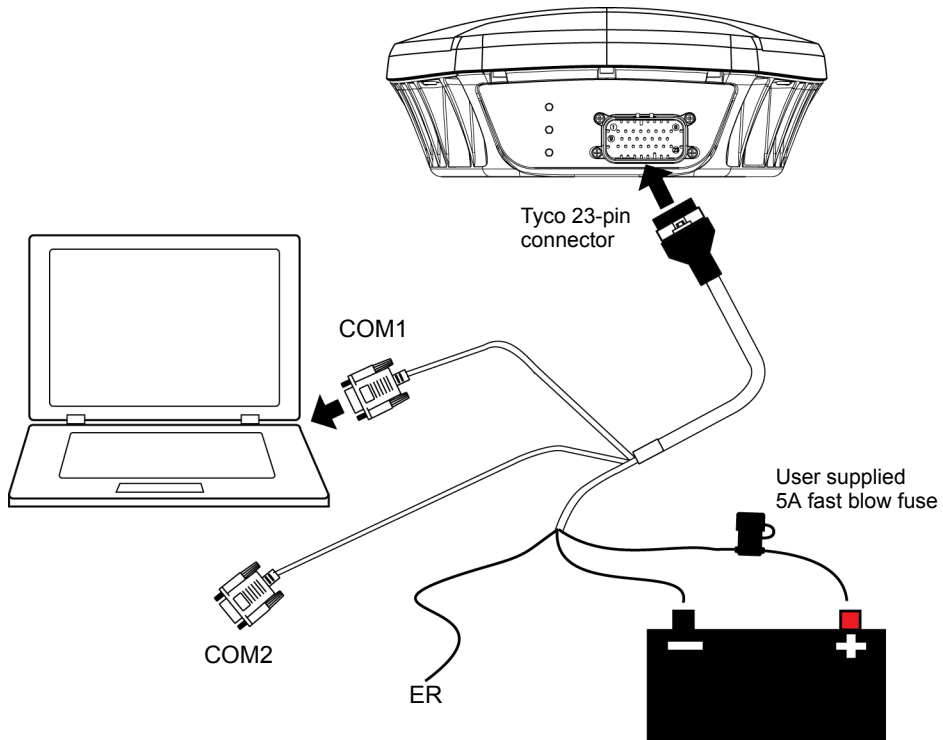

**Figure 8: SMART-MR10 Streamlined Cabling**



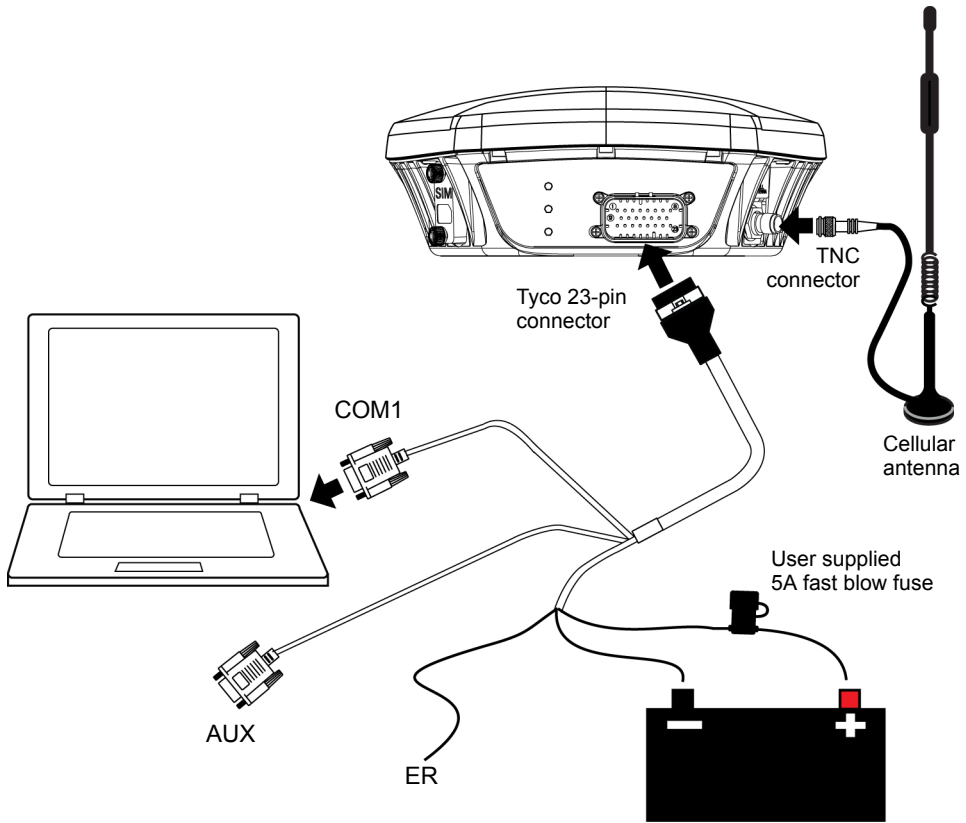

Figure 9: SMART-MR15 Streamlined Cabling

**Table 3: SMART-MR10 Connector Pin-Out**

Pin	Use	Pin	Use
1	PWR+	13	RESERVED
2	PWR-	14	CHASSIS GROUND
3	CAN1-	15	SIGGND1
4	CAN1+	16	MKI
5	TXD2	17	PPS
6	RXD2	18	ER
7	TXD1/TXD1+ <sup>a</sup>	19	MODE <sup>a</sup>
8	RTS1/AUXTX/TXD1- <sup>a</sup>	20	RESERVED
9	SIGGND2	21	RESERVED
10	RESERVED	22	CTS1/AUXRX/RXD1- <sup>a</sup>
11	RESERVED	23	RXD1/RXD1+ <sup>a</sup>
12	RESERVED		

a. The SMART-MR10/15 is RS-232/RS-422-selectable through pin 19 MODE, as shown in *Table 4*.

**Table 4: SMART-MR10 Use of MODE Pin**

MODE Pin	Result	Pin-out
Open	Pins 8 and 22 provide RS-232 access to the AUX port TX and RX lines. COM1 flow control and COM1 RS-422 TX- and RX- signals are not available in this configuration.	Pin 7: TXD1 Pin 8: AUXTX Pin 22: AUXRX Pin 23: RXD1 (2 COM ports, no flow control)
Tied Low (connected to ground)	Pins 8 and 22 provide TXD1- and RXD1- for COM1 RS-422, and the AUX port (AUXRX, AUXTX) is not available.	Pin 7: TXD1+ Pin 8: TXD1- Pin 22: RXD1- Pin 23: RXD1+ (RS-422 only)
Tied High (connected to positive side of battery through a fuse)	Pins 8 and 22 provide RTS1 and CTS1 for COM1 flow control, and the AUX port (AUXTX, AUXRX) is not available.	Pin 7: TXD1 Pin 8: RTS1 Pin 22: CTS1 Pin 23: RXD1 (1 COM port with flow control)

**Table 5: SMART-MR15 Connector Pin-Out**

Pin	Use	Pin	Use
1	PWR+	13	RESERVED
2	PWR-	14	CHASSIS GROUND
3	CAN1-	15	SIGGND1
4	CAN1+	16	MKI
5	AUXTX	17	PPS
6	AUXRX	18	ER
7	TXD1/TXD1+ <sup>a</sup>	19	MODE <sup>a</sup>
8	RTS1/TXD1- <sup>a</sup>	20	RESERVED
9	SIGGND2	21	RESERVED
10	RESERVED	22	CTS1/RXD1- <sup>a</sup>
11	RESERVED	23	RXD1/RXD1+ <sup>a</sup>
12	RESERVED		

a. The SMART-MR15 is RS-232/RS-422-selectable through pin 19 MODE, as shown in *Table 6*.

**Table 6: SMART-MR15 Use of MODE Pin**

MODE Pin	Result	Pin-out
Open or tied High (connected to positive side of battery through a fuse)	Pins 8 and 22 provide RTS1 and CTS1 for COM1 flow control, and the AUX port (AUXTX, AUXRX) is not available.	Pin 7: TXD1 Pin 8: RTS1 Pin 22: CTS1 Pin 23: RXD1 (1 COM port with flow control)
Tied Low (connected to ground)	Pins 8 and 22 provide TXD1- and RXD1- for COM1 RS-422, and the AUX port (AUXRX, AUXTX) is not available.	Pin 7: TXD1+ Pin 8: TXD1- Pin 22: RXD1- Pin 23: RXD1+ (RS-422 only)



If the MODE pin is tied high, it must be tied high through a fuse. In this case, MODE can be tied to the same fuse as the red power lead, as illustrated in *Figure 8, SMART-MR10 Streamlined Cabling on page 32*. It is never acceptable to connect wiring directly to the positive side of the power source.

- Turn on the power supply to the SMART-MR10/15. The power LED  on the back of the receiver lights red when the SMART-MR10/15 is properly powered.



Minimum conductor size for all wiring is 0.5 mm / 20 AWG. While the AMPSEAL connector can accommodate X mm / 20 AWG wire electrically, in order to ensure IP67 performance, the wire insulation diameter needs to be no less than 2.2 mm / 0.0826 inches.

### 2.3.1 Connecting the Power Supply

The SMART-MR10/15 requires +9 to +36 VDC for the input power to the receiver. See *Appendix A.2* starting on *page 75* for SMART-MR10 power supply specifications, and *Appendix A.3* starting on *page 79* for SMART-MR15 power supply specifications.



Fuse/holder recommendations can be found in *Table 14, Recommended Fuses* on *page 87*.

The SMART-MR10/15 cable provides power in (with a BATT+ label) and power ground (with a BATT- label) bare wires for connections from the SMART-MR10/15 to a vehicular power system protected by a user-supplied fuse. NovAtel recommends an automotive blade-type fuse, rated for 5A with an operating voltage of more than 36V. For cable details, refer to *Appendix A.4.3, Custom Connector and Cable Requirements* starting on *page 87*.



The SMART-MR10/15 power source must be protected by a 5A fuse or damage to wiring may result (not covered by warranty). If the voltage supplied is above or below the specified range, the receiver will suspend operation. If the voltage supplied is above 48V, the receiver may be permanently damaged, voiding your warranty.

Once you apply power, the SMART-MR10/15 status lights will light as described in *Status Indicators* starting on *page 37*.



### 2.3.2 Status Indicators

LED indicators on the SMART-MR10/15 provide receiver status information:

- Power
- Position Status
- Position Type

Table 7 and Table 8 show the meaning of the LED states in the expected sequence after power is applied.



**Table 7: SMART-10 LED Status Indicators**

Red 	Yellow 	Green 	Condition
Off	Off	Off	Power is not available. (Red indicator may also not be lit if a boot failure has occurred.)
On	Off	Off	Power available but no satellites are being tracked
On	Flashing	Off	Tracking at least one satellite but not a valid position
On	On	Off	Position valid in basic autonomous mode
On	On	Flashing	SBAS tracking, but not enough data for enhanced solution.
On	On	On	Position valid in an enhanced accuracy mode <sup>a</sup> (WAAS/EGNOS/MSAS/DGPS, OmniSTAR VBS/XP/HP, or RTK)
On	Flashing	Flashing	Fixed position with bad integrity <sup>a</sup>

a. When acting as a reference receiver, all lights on solid indicates a good fixed position.

Flashing means that the LED is turning on and off at a 1 Hz rate - 0.5 seconds on and 0.5 seconds off.

Table 8: SMART-MR15 LED Indicators

Red 	Yellow 	Green 	Condition
Off	Off	Off	Power is not available (Red indicator may also not be lit if a boot failure has occurred).
Flashing	Any	Off	A SIM card error is present or the SIM may not be installed. Applies only to GSM/GPRS/HSDPA version of SMART-MR15.
On	Off	Off	Power available, but no satellites are being tracked. No cellular network connection.
On	Flashing	Off	Tracking at least one satellite, but not a valid position. No cellular network connection.
On	On	Off	Position valid in basic autonomous mode. No cellular network connection.
On	On	Flashing	Connected to cellular network, but not receiving RTK corrections over NTRIP.
On	Flashing	Flashing	Tracking at least one satellite, but not a valid position. Connected to cellular network, but not receiving RTK corrections over NTRIP.
On	On	On	The following conditions are true: <ul style="list-style-type: none"> <li>• A valid position is available</li> <li>• The NTRIP client is in a STREAMING state</li> <li>• An RTK solution is available over NTRIP</li> </ul>

Flashing means that the LED is turning on and off at a 1 Hz rate - 0.5 seconds on and 0.5 seconds off.

### 2.3.3 Debugging Guidelines:

- If the power is on but the yellow LED does not flash within one minute, no satellites are being tracked. There may be excessive blockage or the unit may be defective. Make sure the unit has an unobstructed view of the sky. Try power cycling the unit.
- If the yellow LED does not flash within one minute and power cycling the unit does not fix the problem, once you have a computer or terminal connected, request a VERSION log to ensure that the auth code is correct.

Example of a receiver loaded with an incorrect auth code:

```
<OK
[COM1]<VERSION COM1 0 94.5 UNKNOWN 0 156.357 004c0001 3681 5010
<3
< GPSCARD "invalid authcode" "DHC09401037" "MCAGTP-1.00-22B" "3.710" "3.002" "2009/Nov/30" "11:08:19"
< DB_USERAPPAUTO "SmartAg" "0" "" "1.100" "" "2009/Nov/27" "13:22:29"
< USERINFO "LMX9830" "0212" "002166000001" "" "" "" ""
[COM1]
```

- **Applies to MR10/15** – If the yellow LED is flashing but does not progress to solid yellow within one minute, then insufficient satellites are being tracked or the signal quality is poor and ephemeris data can't be received. Normally, four satellites are sufficient for a valid position as long as they are widely distributed in the sky. If it is stuck on blinking yellow, there may be excessive blockage or the unit may be defective. Make sure the unit has an unobstructed view of the sky. Try power cycling the unit.
- **Applies to MR10** – If the yellow LED is on and the green LED does not turn on within five minutes, no SBAS or DGPS positions are available. If you are using SBAS, make sure SBAS is available in your area and that the unit is configured to enable SBAS positions (SBASCONTROL ENABLE). For DGPS, make sure the unit is configured with the correct serial port parameters and to accept the DGPS protocol your area uses and that your data modem is connected and working.
- **Applies to MR15** – The green LED blinks when the MR15 authenticates with a cellular network. The LED stays off if a cellular network connection is impossible for any reason.
- **Applies to MR15** – If the green LED doesn't go solid after mounting an NTRIP Caster, verify the NTRIP Client configuration. The green LED only turns on if three conditions are met:
  1. The NTRIP Client enters the STREAMING state
  2. A valid position is available (the amber LED is on)
  3. An RTK solution is available

For example, if the MR15 NTRIP Client is configured to receive RTCMV3 corrections but is receiving RTCA corrections, only conditions 1) and 2) apply, so the green LED will remain flashing.

Applies to MR15 (HSPA only). If the red LED is flashing, the SIM card is not inserted or improperly inserted. Refer to Figure 11, Figure 12 and Figure 13 on page 44 for correct insertion.

### 2.3.4 Connecting Data Communications Equipment

To communicate with the receiver so that you can send commands to and obtain logs from the SMART-MR10/15, you will need to connect it to a terminal or computer. For further information about the data communications connector and pin-out details for the evaluation and streamlined cables, see *Table 11, Evaluation Cable Pinouts* on page 84 and *Table 12, Streamlined Cable Pinouts* on page 86 respectively. Once you are connected, you will be able to carry out the operations outlined in *Chapter 3, Operation* starting on page 46, *Appendix B Commands* starting on page 88, and *Appendix C Logs* starting on page 110.

## 2.4 Additional Installation Information

This section provides additional installation and configuration information that relate to specific applications of the SMART-MR10/15.

### 2.4.1 MKI and PPS Strokes

Input (MKI) and output (PPS) strobes provide status and synchronization signals. PPS is a 3.3V CMOS output; MKI is a 5V-tolerant input. PPS and MKI are referenced to SGND. Pin-out information can be found on *Table 11, Evaluation Cable Pinouts* on page 84.

MKI can be used in conjunction with the MARKTIME and MARKPOS logs. For information about these logs, refer to *OEMV Family Firmware Reference Manual*, available on the NovAtel website at [www.novatel.com/support/firmware-software-and-manuals/product-manuals-and-doc-updates/](http://www.novatel.com/support/firmware-software-and-manuals/product-manuals-and-doc-updates/).

### 2.4.2 Emulated Radar (ER)

The SMART-MR10/15 output an emulated radar signal via the bare wires labeled SGND and ER OUT on the SMART-MR10/15 cable. See *Table 11, Evaluation Cable Pinouts* on page 84 or *Table 12, Streamlined Cable Pinouts* on page 86 for the pin-out details of your cable.

The ER outputs:

- Logic high: Minimum of supply voltage minus 0.5V
- Logic low: Maximum of 0.5V
- Minimum load: 3k ohms
- Rise and fall time: Less than 1 ms.

The ER output is referenced to signal GND and provides logic low output until its speed is greater than 1 km/hr. ER can be configured to operate at one of three distinct frequencies (26.11, 28.12 or 36.11 Hz/km/hr, with 36.11 Hz/km/hr being the default value) and with an effective velocity range from 1 km/hr to 55 km/hr for near-horizontal applications. See *Appendix B.12 RADARCFG Configure the ER output* starting on page 104 for more information.



### 2.4.3 Controller Area Network (CAN)

NMEA 2000 is a CAN standard created by the National Marine Electronics Association and designed to support networking in marine applications. It functions over a longer physical distance, and supports more physical nodes than ISO 11783. The relationship between NMEA 2000 and SAE J1939 is that J1939 *is* the standard, while the NMEA 2000 group has added new messages (called PGNs or Parameter Group Numbers) and a new transport protocol called FastPacket. NMEA 2000 compliant, for all intents and purposes, means J1939 compliant *plus* support for new NMEA 2000 messages. In other word, one cannot have NMEA 2000 without J1939 support as well. J1939 is additionally “harmonized” with ISO 11783, a standard for the agriculture industry.

The CAN module is activated when a SETCANNNAME command is entered, and after a SAVECONFIG, the CAN module is activated immediately on all subsequent start-ups. The module supports the following NMEA 2000 Parameter Group Messages (PGN):

- PGN 129029 GNSSPositionData (1 Hz)
- PGN 129025 GNSSPositionRapidUpdate (10 Hz)
- PGN 129026 COGandSOGRapidUpdate (4 Hz)

**Table 9: Available CAN Signals on SMART-MR10/15 23-pin Tyco Connector**

CAN	Pins
CAN1-	Pin 3
CAN1+	Pin 4

### 2.4.4 SMART-MR15 CELLULAR ANTENNA INSTALLATION

The SMART-MR15 has a cellular antenna port to facilitate the connection of an external cellular antenna. An external antenna must be connected to this port in order to use the integrated cellular modem.



To comply with FCC regulations limiting both maximum RF output power and human exposure to RF radiation, the maximum system gain (antenna gain minus system loss) must not exceed 1.4 dBi in the U.S. Cellular band and 3.0 dBi in the PCS band for the GSM/GPRS/HSDPA variant, and 6.0 dBi in the Cellular band and 6.0 dBi in the PCS band for the CDMA variant. System loss is the total of external cable and connector losses and SMART-MR15 internal losses. For reference and system gain calculation purposes, the SMART-MR15 has internal losses of 0.6 dB for the 800 MHz Cellular band and 1.8 dB for the 1900 MHz PCS band.



- Do not connect a CDMA antenna to a GSM/GPRS/HSDPA version of the SMART-MR15 as this creates a safety hazard.
- Do not shorten the cable lengths provided with any particular antenna type as this creates a safety hazard.
- Do not connect a GSM/GPRS/HSDPA antenna type to a CDMA version of the SMART-MR15 as cellular performance is degraded.

1. Connect an appropriate antenna type to the SMART-MR15: Specific antenna types are available from NovAtel for the GSM/GPRS/HSDPA or CDMA versions of the SMART-MR15.
2. Ensure the cellular antenna is installed at least 30 cm away from the SMART-MR15, as shown in *Figure 10*. GNSS positioning accuracy may be degraded if this is not observed, particularly for operation in the EU “1800 MHz” band.

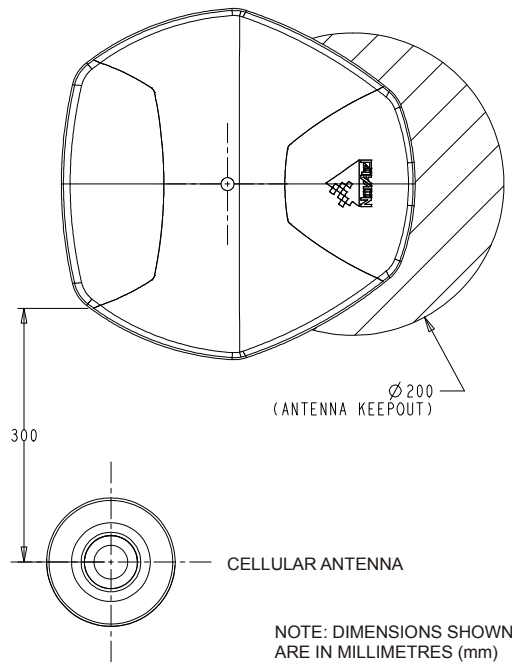

**Figure 10: Cellular Antenna Placement**

3. Ensure the cellular antenna is installed at least 20 cm away from the *Bluetooth* antenna area of the SMART-MR15, as shown in *Figure 10*.

4. Antennas must be installed on a “ground plane”. A vehicle with a metal roof is inherently a ground plane. For vehicles with a non-metallic roof a metal ground plane (available from NovAtel) must be used.

When installing the antenna on a metallic roof, it is recommended that the antenna be installed no closer than 10 cm, (4 inches) from the edge of the rooftop, to avoid adversely affecting the antenna performance due to distortion of the antenna pattern.

The NovAtel ground plane accessory for use on non-metallic vehicle cab roofs is designed to provide a sufficient symmetrical ground plane around the antenna to guarantee optimal antenna performance.

5. Secure the RF connector to the SMART-MR15 ensuring a “hand tight” connection.



- Do not use pliers or other tool types to over-tighten the RF connector as damage to the connector will occur.
- Ensure the RF connectors (male and female) are clean and dry before mating. Low pressure compressed air can be used to clean the connectors (that is, compressed air available in aerosol can format). Do not use a high pressure compressed air as moisture seals in the connector can be damaged. If the SMART-MR15 is moved between multiple vehicles each with its own cellular antenna, some means of sealing the unmated RF connectors should be used. Cellular radio frequencies are much higher than older forms of radio communications; the effects of moisture and/or dust will have a greater effect on performance.

## 2.4.5 SMART-MR15 - Installation Details for Cellular Activation

### GSM/GPRS/HSDPA

The GSM/GPRS/HSDPA modem is not “locked” to any particular carrier. To activate your SMART-MR15 on a GSM/GPRS/HSDPA network, please follow these steps:

1. Contact your preferred GSM/GPRS/HSDPA cellular service provider.
2. Obtain an active account and SIM card providing GSM/GPRS/HSDPA data services (recommended data plans for Network RTK are 5GB/Month Rate Plans). You may need to provide:
  - a. Product Name: SMART-MR15 GSM/GPRS/HSDPA [Part Number: 01018712]
  - b. Modem Serial Number (IMEI): Modem serial number from SMART-MR15 product label



Your cellular provider may provide an activation procedure with the SIM card.

- Remove the SIM cover (shown in *Figure 11*) by loosening the two screws that secure the cover.



When you are replacing the SIM cover, make sure it is installed straight or you may inadvertently cause the SIM card to eject.

- Install the SIM following the orientation shown on the SIM cover (notch up and in, as shown in *Figure 12*). The SIM connector is a push-in/push-out type. If the SIM is correctly installed, its outside edge will be essentially flush with the surrounding enclosure metal surface, as shown in *Figure 13*.



To remove the SIM push it in slightly and it should then be partially ejected by the SIM holder, as shown in *Figure 14*.

The modem will not work if the SIM is in the partially ejected “ready for removal” position. Ensure the SIM door is properly aligned, then secure it in place.



**Figure 11: SIM Cover**



**Figure 12: SIM Being Installed**



**Figure 13: SIM Correctly Installed**



**Figure 14: SIM Ready for Removal**



Secure the SIM cover to the base using a flat-head screwdriver. Screws should be torqued to 4-6 in-lb, to ensure the unit does not leak.

- To register with the cellular network, issue the following commands with data provided by the carrier:

```
cellset apn <apn_name> {always required}
```

```
cellset user <user_name> {if provided by carrier}
```

```
cellset password <password> {if provided by carrier}
```

6. Your product is ready for use.



Cellular data consumption and service charges are dependent on the configuration of your SMART-MR15 receiver and data logging rates.

## CDMA

To activate your SMART-MR15 on the Verizon network:

1. Obtain a Verizon Wireless Account. You will need to provide:
  - a. Product Name: SMART-MR15 CDMA (Verizon) [Part Number: 01018606]
  - b. Modem Serial Number (MEID) from the SMART-MR15 product label
2. Activate the modem with Verizon:
  - a. Apply power and establish a serial connection with your product.
  - b. Send the following logs and commands:

NovAtel Command	Guidance
LOG CELLSTATUSA ONCHANGED	Check the number of bars to confirm signal strength OK.
CELLACTIVATE verizon	This will provision the module on the Verizon network

Before operating the SMART-MR10 or SMART-MR15 for the first time, ensure that you have followed the installation instructions in *Chapter 2 Installation* starting on *page 26*. The following instructions are based on a COM port configuration such as that shown in *Figure 15* on *page 49*. It is assumed that a personal computer (PC), or laptop, is used during initial operation and testing for greater ease and versatility.

## 3.1 Communications with the Receiver

Communication with the receiver typically consists of issuing commands through the communication ports from an external serial communications device. This could be either a terminal or PC/laptop that is directly connected to the receiver serial port using a DB-9 connector on the SMART-MR10 or SMART-MR15 multi-cable. If you are using a radio, it connects to another DB-9 connector on the same multi-cable by means of the radio serial cable supplied with the radio. It is recommended that you become thoroughly familiar with the commands and logs detailed in the *OEMV Family Firmware Reference Manual* to ensure maximum utilization of the receiver's capabilities.

### 3.1.1 Serial Port Default Settings

The receiver communicates with your PC/laptop or terminal via an RS-232 serial port. For communication to occur, both the receiver and the operator interface have to be configured properly. The receiver's COM1, COM2 and AUX default port settings are configured as follows:

- 9600 bps, no parity, 8 data bits, 1 stop bit, no handshaking, echo off

Changing the default settings requires use of the *COM* command. See *Appendix B.5, COM Configure COM Port* starting on *page 93* for details.



SMART-MR15 COM2 is restricted to internal use by the cellular radio. Do not modify the settings for this port.



COM1 can be configured as RS-422. It can also be configured with flow control. AUX is not available if COM1 flow control is enabled or if COM1 is configured as RS-422. The configuration using the Mode pin is summarized in *Table 5, SMART-MR15 Connector Pin-Out* on *page 35*.

The data transfer rate you choose determines how fast information is transmitted. Take for example a log whose message byte count is 96. The default port settings allows 10 bits/byte (8 data bits + 1 stop bit + 1 framing bit). It therefore takes 960 bits per message. To get 10 messages per second then requires 9600 bps. Also remember that even if you set the bps to 9600 the actual data transfer rate is lower and depends on the number of satellites being tracked, data filters in use, and idle time. It is suggested that you leave yourself a margin when choosing a data rate (115200 is recommended for most applications).



Data rates below 9600 bps are not recommended.

### 3.1.2 Communicating Using a Remote Terminal

One method of communicating with the receiver is through a remote terminal. The receiver has been pre-wired to allow proper RS-232 interface with your data terminal. To communicate with the terminal, the receiver only requires the RX, TX, and GND lines to be used. Request to Send (RTS)/Clear to Send (CTS) hardware handshaking is not available. Ensure the terminal's communications set-up matches the receiver's RS-232 protocol.

### 3.1.3 Communicating With a Computer

A computer can be set up to emulate a remote terminal as well as provide the added flexibility of creating multiple-command batch files and data logging storage files. Any standard communications software package that emulates a terminal can be used to establish bidirectional communications with the receiver, for example, HyperTerminal or our own graphic user interface (GUI) program, Connect. All data is sent as raw 8-bit binary or ASCII characters.

## 3.2 Getting Started

Included with your receiver are NovAtel's Connect and Convert4 programs. Connect is a Windows-based GUI which allows you to access the receiver's many features without the need for communications protocol or to write special software. To learn how to use Connect with a NovAtel receiver, press F1 or click the NovAtel button and select Help.

The Convert4 utility is a Windows-based utility that allows you to convert receiver logs between ASCII and binary formats, and strips unwanted records for data file compilation. If you have not already installed these utilities, see *Section 1.5, Installing the PC Utilities on page 25*.

### 3.2.1 Starting the Receiver

When first powered, the SMART-MR10/15 undergoes a complete self-test. If an error condition is detected during a self-test, the self-test status word changes. This self-test status word can be viewed in the header of any data output log. Refer to the chapter on *Messages* in the *OEMV Family Firmware Reference Manual* for header information. If a persistent error develops, please contact your local NovAtel dealer first. If the problem is still unresolved, please contact NovAtel directly through any of the methods listed in the *Customer Support* section at the beginning of this manual on *page 19*.

## 3.3 Transmitting and Receiving Corrections

RTK or DGPS corrections can be transmitted from a base station to a rover station to improve position accuracy. The base station is the GNSS receiver, which is acting as the stationary reference. It has a known position and transmits correction messages to the rover station. The rover station is a GNSS receiver which can be sent correction messages from a base station to calculate differential GNSS positions. The SMART-MR10/15 can be used as base receivers to transmit RTK or DGPS corrections, or as rovers to receive the same corrections. An example of a differential setup is given in *Figure 15* on *page 49*.



While the setup described in the following sections may work on a SMART-MR15, the SMART-MR15 is designed to receive corrections over a cellular modem on COM2 via NTRIP caster, in which case, the NTRIPCASTER and NTRIPCLIENT commands will take care of all interface mode configuration and corrections. Users should not change the COM2 interface settings manually or the receiver will no longer be able to communicate with the cellular modem.



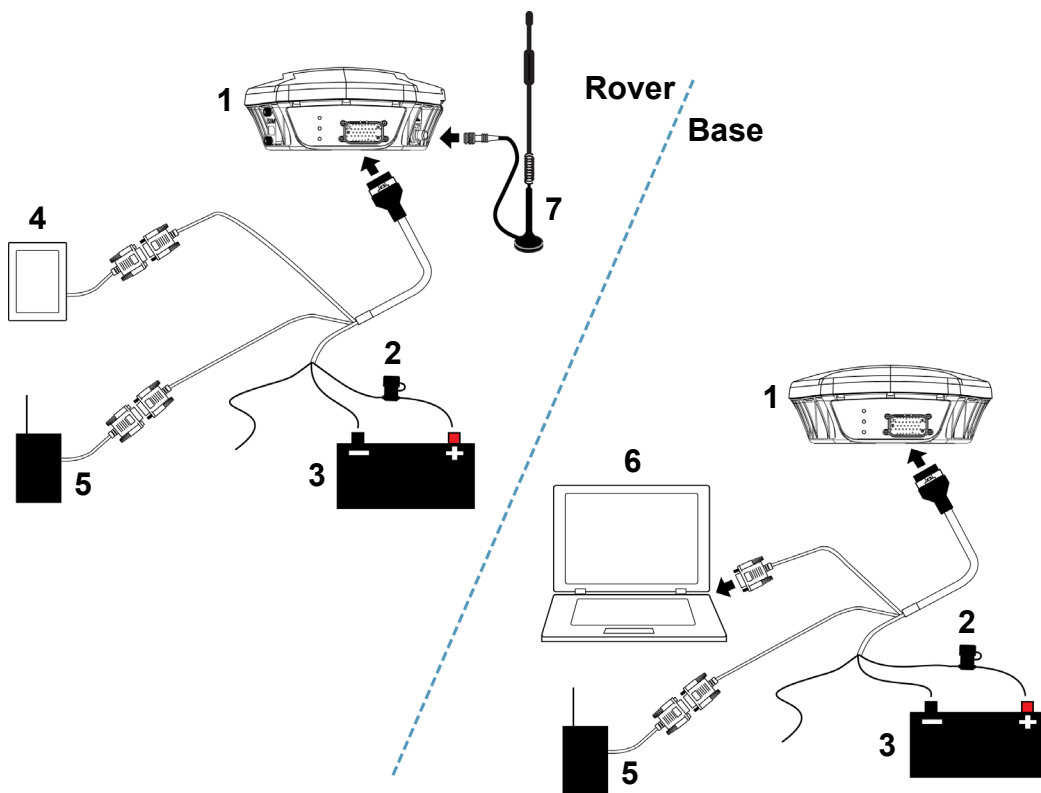

**Figure 15: Basic Differential Setup**

Reference	Description
1	Receiver
2	User-supplied 5A fuse
3	User-supplied power supply, for example a battery
4	User-supplied device to COM1
5	User-supplied radio device to COM2 (SMART-MR10 only)
6	User-supplied PC/laptop, for setting up and monitoring, to COM1
7	Cellular Antenna (SMART-MR15 only)

System biases can introduce errors. Refer to the Support page on the NovAtel website at [www.novatel.com](http://www.novatel.com) for more information. In most cases you need to provide a data link between the base station and rover station (two NovAtel receivers) in order to receive corrections. The application of SBAS corrections to a single receiver are an exception to the base/rover concept. Generally, a link capable of data throughput at a rate of 9600 bits per second, and less than 4.0 s latency, is recommended.

Once your base and rover are set up, you can configure them as outlined in the configuration examples in 3.3.1, *Base Station Configuration* on page 50 and 3.3.2, *Rover Station Configuration* on page 51.

### 3.3.1 Base Station Configuration

At the base station, enter the following commands:

```
interfacemode port rx_type tx_type [responses]
com com2 115200 N 8 1 N off
fix position latitude longitude height
log port message [trigger [period]]
```

Examples of these commands include the following:

```
RTCA      interfacemode com2 none rtca off
           fix position 51.11358042 -114.04358013 1059.4105
                                           (enter your own lat, lon, hgt)

           log com2 rtcaobs ontime 1
           log com2 rtcaref ontime 10
           log com2 rtca1 ontime 5         (optional, enable code-dgps coverage)
           log com2 rtcaephem ontime 10 1 (optional)
```

```
RTCAOBS2 interfacemode com2 none rtca off
(recommended) fix position 51.11358042 -114.04358013 1059.4105
                                           (enter your own lat, lon, hgt)

           log com2 rtcaobs2 ontime 1
           log com2 rtcaref ontime 10
```

```
RTCM V2.3 interfacemode com2 none rtcm off
           fix position 51.11358042 -114.04358013 1059.4105
                                           (enter your own lat, lon, hgt)

           log com2 rtcm3 ontime 10
           log com2 rtcm22 ontime 10 1
           log com2 rtcm1819 ontime 1
           log com2 rtcm1 ontime 5        (optional)
```

```
RTCM V3  interfacemode com2 none rtcmv3 off
           fix position 51.11358042 -114.04358013 1059.4105
                                           (enter your own lat, lon, hgt)

           log com2 rtcm1002 ontime 1    (for L1 only models)
           log com2 rtcm1004 ontime 1
           log com2 rtcm1006 ontime 10
           log com2 rtcm1019 ontime 120
```

```

RTCM V3 with GLONASS      interfacemode com2 none rtcmv3 off
(recommended)  fix position 51.11358042 -114.04358013 1059.4105
                                                    (enter your own lat, lon, hgt)
log com2 rtcml002 ontime 1      (for L1 only models)
log com2 rtcml004 ontime 1      (for L1/L2 models)
log com2 rtcml010 ontime 1      (for L1 only models)
log com2 rtcml012 ontime 1      (for L1/L2 models)
log com2 rtcml006 ontime 10
log com2 rtcml033 ontime 10
log com2 rtcml019 ontime 120
log com2 rtcml020 ontime 120

```

```

CMRPLUS (CMR+)      interfacemode com2 none cmr off
fix position 51.11358042 -114.04358013 1059.4105
                                                    (enter your own lat, lon, hgt)
log com2 cmrobs ontime 1
log com2 cmrglobs ontime 1
log com2 cmrplus ontime 1      (important to use ontime 1 with cmrplus)

```

```

CMR                  interfacemode com2 none cmr off
fix position 51.11358042 -114.04358013 1059.4105
                                                    (enter your own lat, lon, hgt)
log com2 cmrobs ontime 1
log com2 cmrglobs ontime 1
log com2 cmrref ontime 10
log com2 cmrdesc ontime 10 1      (optional)

```

### 3.3.2 Rover Station Configuration

At the rover station, enter:

```
interfacemode port rx_type tx_type (responses)
```

For example:

```

RTCA                  interfacemode com2 rtca none off
RTCAOBS2             interfacemode com2 rtca none off
RTCM V2.3            interfacemode com2 rtcml none off
RTCM V3              interfacemode com2 rtcmv3 none off
RTCM V3 with GLONASS
                        interfacemode com2 rtcmv3 none off
CMR+                 interfacemode com2 cmr none off
CMR                  interfacemode com2 cmr none off      (same as CMR+)

```

### 3.3.3 GPS + GLONASS Base and Rover Configuration

This section shows you how to set up your base and rover OEMV GPS + GLONASS-enabled receivers for GPS + GLONASS RTK operation:

#### Base Station:

```
fix position lat lon hgt           (enter your own lat, lon, and hgt values)
com com2 115200 N 8 1 N off
interfacemode com2 none rtca off
log com2 rtcaref ontime 10
log com2 rtcaobs2 ontime 1
log com2 rtca1 ontime 5           (optional, enable code-DGPS coverage)
saveconfig                       (optional, save configuration to non-volatile memory)
```

#### Rover Station:

```
com com2 115200 N 8 1 N off
interfacemode com2 rtca none off
log com1 bestposa ontime 1       (optional, view position information)
saveconfig                       (optional, save configuration to non-volatile memory)
```

### 3.3.4 Configuration Notes

For compatibility with other GNSS receivers, and to minimize message size, it is recommended that you use the standard form of RTCA, RTCM, RTCMV3 or CMR corrections as shown in the base and rover examples above. This requires using the INTERFACEMODE command to dedicate one direction of a serial port to only that message type. When the INTERFACEMODE command is used to change the mode from the default, NOVATEL, you can no longer use NovAtel format messages.

If you want to mix NovAtel format messages and RTCA, RTCAOBS2, RTCM, RTCMV3, CMR+ or CMR messages on the same port, you can leave the INTERFACEMODE set to NOVATEL and log out variants of the standard correction messages with a NovAtel header. ASCII or binary variants can be requested by simply appending an “A” or “B” to the standard message name. For example on the base station:

```
interfacemode com2 novatel novatel
fix position 51.11358042 -114.04358013 1059.4105
log com2 rtcm1b ontime 2
```



Using the receiver in this mode consumes more CPU bandwidth than using the native differential messages shown in *Section 3.3.1, Base Station Configuration on page 50*.

At the rover station you can leave the INTERFACEMODE default settings (interfacemode com2 novatel novatel). The rover receiver recognizes the default and uses the corrections it receives with a

NovAtel header.

The PSRDIFFSOURCE and RTKSOURCE commands set the station ID values which identify the base stations from which to accept pseudorange or RTK corrections respectively. They are useful commands when the rover station is receiving corrections from multiple base stations.



All PSRDIFFSOURCE entries fall back to SBAS (even NONE) for backwards compatibility.

At the base station it is also possible to log out the contents of the standard corrections in a form that is easier to read or process. These larger variants have the correction fields broken out into standard types within the log, rather than compressed into bit fields. This can be useful if you wish to modify the format of the corrections for a non-standard application, or if you wish to look at the corrections for system debugging purposes. These variants have “DATA” as part of their names (for example, RTCADATA1, RTCMDATA1, CMRDATAOBS, and more). Refer also to the *OEMV Family Firmware Reference Manual*, which describes the various message formats in more detail.



Information on how to send multiple commands and log requests using DOS or Windows, can be found on our website at [www.novatel.com](http://www.novatel.com) through Support | Help Desk & Solutions | Search Known Solutions.

### 3.3.5 SBAS (Satellite-Based Augmentation Systems)

A Satellite-Based Augmentation System (SBAS) is a type of geostationary satellite system that improves the accuracy, integrity, and availability of the basic GNSS signals. Accuracy is enhanced through the use of wide area corrections for GNSS orbits and ionospheric errors. Integrity is enhanced by the SBAS network quickly detecting satellite signal errors and sending alerts to receivers to not use the failed satellite. Availability is improved by providing an additional ranging signal to each SBAS geostationary satellite.

OEMV family receivers, including the SMART-MR10/15, are capable of SBAS positioning. This positioning mode is enabled using the SBASCONTROL command. The following command is used to automatically track and use the SBAS service available in the area of operation, for example, WAAS or EGNOS:

```
sbascontrol enable auto
```

For further information on SBASCONTROL, refer to the *OEMV Family Installation and Operation User Manual*, available from the NovAtel website at [www.novatel.com/support/firmware-software-and-manuals/product-manuals-and-doc-updates/](http://www.novatel.com/support/firmware-software-and-manuals/product-manuals-and-doc-updates/).

### WAAS (Wide-Area Augmentation System)

The US Federal Aviation Administration (FAA) has developed a Wide Area Augmentation System (WAAS) to provide accurate positioning to the aviation industry. As well as providing the industry with this high quality service, it is available to all other civilian users and markets in North America, free of charge. Future developments to this system will encompass the L5 signal.

## EGNOS (European Geostationary Navigation Overlay Service)

EGNOS has been developed to work with existing satellite navigation systems to improve the accuracy of navigation signals. The EGNOS signal is transmitted by two geostationary satellites and covers all of Europe. EGNOS transmits a signal containing information on the reliability and accuracy of the positioning signals sent out by GPS.

At the time of this writing, the signal broadcast by the EGNOS satellites AOR-E (PRN120) and the ESA ARTEMIS satellite (PRN 124) is used for EGNOS Operations. The EGNOS satellite IOR-W (PRN 126) is currently used by Industry to perform various tests on the system.

More information on EGNOS can be found at [www.esa.int/egnoss](http://www.esa.int/egnoss).

## 3.4 GLIDE®

SMART-MR10/15 contain NovAtel's GLIDE, a positioning algorithm for single frequency GPS and GPS/GLONASS applications. GLIDE produces a smooth position output tuned for applications where optimal time relative (pass-to-pass) accuracy is more important than absolute accuracy, making it well suited for agricultural applications.

Multipath signals tend to induce time-varying biases and increase the measurement noise on the L1 pseudorange measurements. Carrier phase measurements are much less susceptible to the effects of multipath. The GLIDE algorithm combines the information from the L1 code and the L1 phase measurements into a Position-Time-Velocity (PVT) solution.

GLIDE includes settings for a dynamic mode, a static mode, and an "auto" mode, where the filtering parameters are automatically adjusted as vehicle velocity varies between stationary and dynamic states.

Refer to the NovAtel white papers on the NovAtel website at [www.novatel.com/support/knowledge-and-learning/published-papers-and-documents/white-papers/](http://www.novatel.com/support/knowledge-and-learning/published-papers-and-documents/white-papers/) for more information on GLIDE. Refer also to the application note "APN-038 Pseudorange/Delta-Phase (PDP) and GLIDE Filters" on the NovAtel website at [www.novatel.com/support/knowledge-and-learning/published-papers-and-documents/application-notes/](http://www.novatel.com/support/knowledge-and-learning/published-papers-and-documents/application-notes/).

## 3.5 ALIGN®

### 3.5.1 ALIGN Heading Master and Remote Configurations

For information about how to set up a master station with an ALIGN-capable remote receiver for applications that require relative heading and pitch output, refer to *APN-048*. This Application Note is available from the NovAtel website at [www.novatel.com/support/knowledge-and-learning/published-papers-and-documents/application-notes/](http://www.novatel.com/support/knowledge-and-learning/published-papers-and-documents/application-notes/).

### 3.6 Emulated Radar (ER)

A typical radar sensor emits radio beams that bounce off the ground, and computes ground speed based on the speed at which objects are passing in front of the sensor. The output of the sensor is a digital pulse, the frequency of which is proportional to the vehicle’s ground speed. This is often used in agricultural applications such as planting and spraying. The SMART-MR10/15 eliminate the need for separate ground-sensing radar equipment by converting the GPS-derived velocity to proportional frequency output. The following emulated radar signal parameters can be configured by the customer:

- Frequency Step: Specifies how the frequency output relates to the vehicle speed.
- Signal Update Rate: Specifies how often the frequency output is updated to match the vehicle speed.
- Response Mode: Specifies how quickly changes in velocity are reflected in the frequency output. Setting a slower response mode reduces spikes (noise) in the velocity but increases latency. Setting a higher response mode reduces latency, but may result in noisier frequency output. Refer to *Appendix B.12, RADARCFG Configure the ER output* starting on page 104 for more detailed information.

Once it is configured using the RADARCFG command (see page 104), Emulated Radar (ER) pulses are output through the SMART-MR10/15 cables (see *Table 11 on page 84*) and the RADARSIGNAL log (see page 119).

### 3.7 NTRIP Client

In this configuration, shown in *Figure 16*, a vehicle-mounted SMART-MR15 acts as a rover using network RTK via NTRIP. To access NTRIP servers, the SMART-MR15 uses a built-in TCP/IP-capable cellular modem and NTRIP client software.

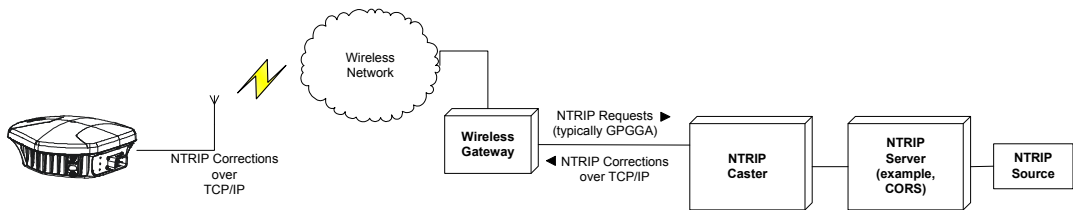

**Figure 16: NTRIP Client Configuration**

The following are examples of connecting to NTRIP clients:

Connecting to www.igs-ip.net (no GPGGA logs):

```
ntripcaster www.igs-ip.net 80
ntripclient mount prds0 userid password rtcmv3
```

Connecting to www.igs-ip.net

```
ntripcaster www.igs-ip.net 80
ntripclient mount prds0 userid password rtcmv3 10
(and send one GPGGA log to the NTRIP server every ten seconds)
```

## 3.8 Recommended Configuration

The following command is recommended to enable CAN:

```
setcanname 305
```

The following command is recommended to enable SBAS (WAAS/EGNOS/MSAS) corrections:

```
sbascontrol enable
sbascontrol enable EGNOS 0 zerototwo
```

The following commands are recommended to enable GLIDE:

```
pdpfilter enable
pdpmode relative auto
```

The cellular modem (SMART-MR15 only) is automatically enabled on start up. To set up the NTRIP corrections, the following commands are recommended:

```
ntripcaster <address> <port>
ntripclient mount <mountpoint> <username> <password>
<correctiontype>
```

NovAtel has registered manufactured ID code 305 with J1939. When complete, your configuration can be saved with the SAVECONFIG command. Refer to the *OEMV Family Firmware Reference Manual* for further details on these commands.



Visit NovAtel's website at [www.novatel.com/support/firmware-software-and-manuals/firmware-software-updates/](http://www.novatel.com/support/firmware-software-and-manuals/firmware-software-updates/) for the most recent versions of the PC software and receiver firmware.

## 4.1 Connect/Convert4 Installation

The accompanying CD contains the Microsoft Windows applications Connect and Convert4. They are installed via a standard Install Shield set-up application. Also included on the CD is sample source code, to aid development of software for interfacing with the receiver, and product documentation.

These applications utilize a database in their operations so the necessary components of the Borland Database Engine (BDE) are installed as well as the necessary database tables and an alias for the database. The install set-up application does all this automatically so you have only to select where you would like the applications installed on the computer. You must close all applications before installing Connect and Convert4. You must close any applications that may be using the BDE before installing. The install set-up modifies the BDE configuration so that it can recognize the new Connect and Convert4.

The software operates from your computer's hard drive:

1. Start Microsoft Windows.
2. Place the NovAtel CD in your CD-ROM drive. If the setup utility is not automatically accessible, follow these steps:
  - a. Select Run from the Start menu.
  - b. Select the Browse button.
  - c. Locate Setup.exe on the CD drive and select Open.
  - d. Select OK to run the setup utility.
3. Advance through the steps provided by the setup utility.

When the installation is complete, click on a program icon to launch the application



The latest version of NovAtel Connect is available to download from our website at [www.novatel.com/support/firmware-software-and-manuals/firmware-software-updates/](http://www.novatel.com/support/firmware-software-and-manuals/firmware-software-updates/).

## 4.2 Connect

**Connect** is a 32-bit Windows application. The application provides a graphical user interface (GUI) to allow you to set-up and monitor the operation of the NovAtel receiver by providing a series of windows. A help file is included with **Connect**. To access the file, select *Contents* from the *Help* menu.

Most windows have a popup menu accessible by right clicking on the window with the mouse. They provide a way to customize the window by changing the font or to print the window contents. Some of the windows have access to the Options dialog which contains further settings for certain windows. Refer to the Connect utility's online help for specific details.



Refer to the Quick Start Guide for instructions for using NovAtel Connect to open a connection.

## 4.3 Convert4

Convert4 is a 32-bit Windows application. It is shown in *Figure 17*. Convert4 will accept GPS file formats and convert them to ASCII, Binary or RINEX format. The application also allows the user to screen out particular logs by selecting the desired logs from the list of available logs. This feature is useful for screening particular logs out of large data files in either ASCII or Binary formats.

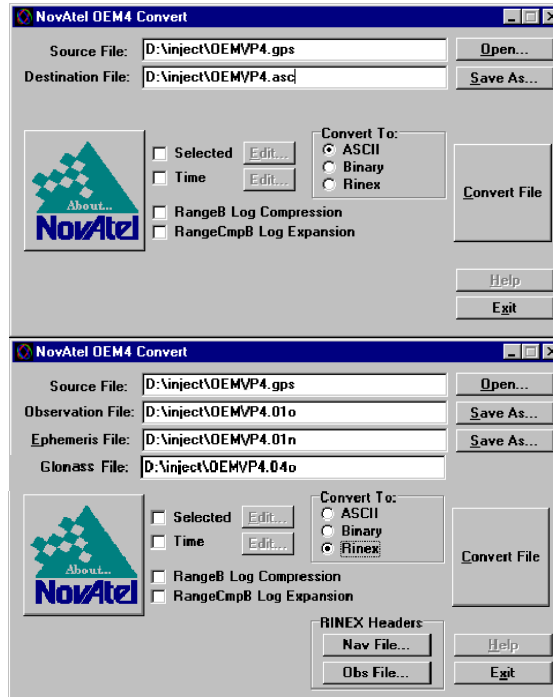

Figure 17: Convert4 Screen Examples

### 4.3.1 RINEX Format

The Receiver-Independent Exchange (RINEX<sup>1</sup>) format is a broadly-accepted, receiver-independent format for storing GPS data. It features a non-proprietary ASCII file format that can be used to combine or process data generated by receivers made by different manufacturers.

The Convert4 utility can be used to produce RINEX files from NovAtel receiver data files.



Although RINEX is intended to be a receiver-independent format, there are many optional records and fields. Keep this in mind when combining NovAtel and non-NovAtel RINEX data.

1. For further information on RINEX Version 2.10 file descriptions, you may wish to consult the U.S. National Geodetic Survey website at [www.ngs.noaa.gov/CORS/general\\_info.shtml](http://www.ngs.noaa.gov/CORS/general_info.shtml).

When converting to RINEX, two files are produced - a RINEX observation file and a RINEX navigation file. A third GLONASS file is produced if the data contains GLONASS observations. The default names of these files conform to the RINEX Version 2.10 recommended naming convention of sssddd.f.yyt, where:

sss	4 character station name - Convert4 uses the first four characters of the <infile> parameter as the station ID
ddd	day of year
f	file sequence number within the day - Convert4 sets this to zero
t	file type: o for the observation and n for the navigation file

Selecting the RINEX field, see *Figure 17, Convert4 Screen Examples on page 59*, in the Convert4 To section causes the:

1. *Destination File:* field to be replaced by the *Observation File:* and *Ephemeris File:* fields. Note that Observation File refers to the RINEX OBS file while Ephemeris File refers to the RINEX NAV file.
2. *RINEX Headers* buttons to appear allowing you to supply additional information that appears in the header records of the RINEX output files (for example, Company Name, Marker Name and Marker Number).

For best results, the NovAtel receiver input data file should contain the logs as in *Table 10, NovAtel Logs for RINEX Conversion on page 60*.

**Table 10: NovAtel Logs for RINEX Conversion**

NovAtel OEMV Family Log	Recommended Trigger
RANGEA/B, or RANGECMPA/B	ontime 1
BESTPOSA/B, or PSRPOSA/B, or RTKPOSA/B, or MARKPOSA/B	once
IONUTCA/B	onchanged
RAWEPHEMA/B	onchanged
GLORAWEPHEMA/B	onchanged
VERSIONA/B <sup>a</sup>	once

- a. Information from this log overrides data entered into the Receiver Number, Type and Version fields using the OBS file button of the RINEX Headers section, see *Figure 17 on page 59*.

### 4.3.2 Convert4 Command Line Switches

Convert4 supports several command-line switches to facilitate batch processing. To access its Command Line Arguments window, open a command prompt window (select Accessories | Command Prompt from the Start menu). Change directory (cd) to the directory on the hard drive on which Convert4 is stored. Type the following: `convert4 -h`

The Convert4 Command Line Arguments window appears as shown in *Figure 18*.

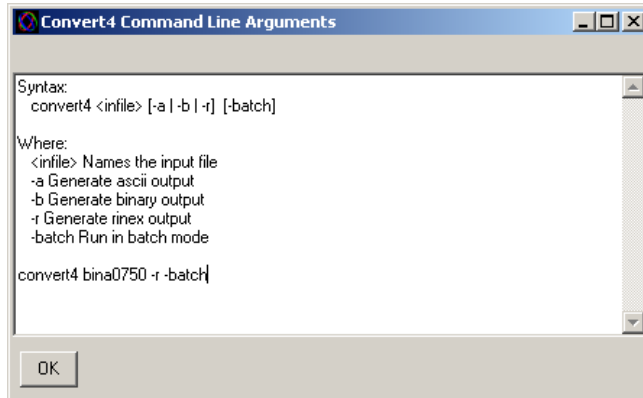

**Figure 18: Convert4 Command Line Arguments**

The name of the output file is the same as the input file when converting to ASCII or binary formats. The file extension, however, is altered to indicate the format of the data:

- \*.asc            for ASCII
- \*.bin            for binary

When converting to RINEX, the output files are named according to the RINEX Version 2.10 naming convention, see *Section 4.3.1, RINEX Format on page 59*.

The `-batch` arguments suppress the window display and convert the specified file automatically.



When converting to RINEX in batch mode, the navigation and observation file header information from the most recent interactive Convert4 session is used.

## 4.4 Firmware Updates and Model Upgrades

Firmware updates are firmware releases that include fixes and enhancements to the receiver functionality. Firmware updates are released occasionally on the NovAtel website as they become available. New firmware must be loaded into the receiver through one of the COM ports. After this is done, the receiver will reboot and start operating with the new firmware.

Model upgrades enable purchased receiver features. The receiver stores its firmware in non-volatile memory, which allows you to perform model upgrades without having to return the receiver to the dealer.

The first step in upgrading the model of your receiver is to contact your local NovAtel dealer. Your dealer will assist you in selecting the upgrade option that best suits your GNSS needs. If your needs cannot be resolved with your dealer then contact NovAtel Customer Support directly as outlined on *page 19*.

When you call, be sure to have your receiver model number, serial number, and firmware version. This information can be determined by entering the LOG VERSION command.

Customers must purchase the model through their sales channel. Once the order is approved, Customer Support will generate and provide you with the auth-code. The auth-code is required to unlock the features on your new model type.

To upgrade to a new model with the same firmware version, you can use the AUTH command with the issued auth-code, as outlined in *4.4.1, Updating or Upgrading Using the WinLoad Utility*.

To upgrade to a new model with a higher firmware version, you will need to load the new firmware into the SMART-MR10 or SMART-MR15 using the WinLoad utility program. As WinLoad and the update file are generally provided in a compressed file format, you may also be given a decompression password. WinLoad and the update files can be found on NovAtel's website at [www.novatel.com/support/firmware-software-and-manuals/firmware-software-updates/](http://www.novatel.com/support/firmware-software-and-manuals/firmware-software-updates/).

Your local NovAtel dealer can provide you with all the information that you require to upgrade or update your receiver.

### 4.4.1 Updating or Upgrading Using the WinLoad Utility

WinLoad is required when updating previously released firmware with a newer version of firmware. You can also upgrade to a new model in the same WinLoad session, as long as you have the required auth-code.

WinLoad is a Windows utility program designed to facilitate firmware updates and model upgrades. Once WinLoad is installed and running, it will allow you to select a host PC serial port, bit rate, directory path, and file name of the new firmware to be transferred to the OEMV family receiver via one of its COM ports. The port chosen must have an RS-232 interface to the PC.

## Transferring Firmware Files

To proceed with the update, you must first acquire the latest version of firmware from the NovAtel Support website. The firmware update file will be one of two types:

- Update (UPDT) version - The update version includes the authorization codes for all OEMV receivers and receiver model upgrades purchased before the cut-off date. The update version will be named UPDTXXXX.EXE, where XXXX is the firmware version, for example, updt3701.exe. If you purchased your receiver or model upgrade after the cut-off date, the authorization code will not appear in the UPDT file, and you will have to use the OEM version instead.
- OEM version - Use the OEM version if you purchased your receiver or model upgrade after the cut-off date. When you use the OEM version, NovAtel Customer Support can generate and provide you with the required authorization code. Authorization codes are also available from the NovAtel website at [www.novatel.com](http://www.novatel.com) through Support | Access Online Services.

The OEM version will be named OEMXXXX.EXE, where XXXX is the firmware version, for example, oem3701.exe.

These update files are available from NovAtel's website at [www.novatel.com/support/firmware-software-and-manuals/firmware-software-updates/](http://www.novatel.com/support/firmware-software-and-manuals/firmware-software-updates/) or via e-mail ([support@novatel.com](mailto:support@novatel.com)). If electronic transfer is not possible, the file can be mailed to you on a CD. For more information on how to contact NovAtel Customer Support see *page 19* at the beginning of this manual.

For convenience, you may wish to copy the update file to a GNSS sub-directory (for example, C:\GNSS\LOADER).

If the firmware update file is password protected, Customer Support will provide you with the required password. After copying the file to your computer, its contents must be extracted, as follows:

Syntax:            [filename] [password]

where filename is the name of the compressed file (but not including the .EXE extension) and password is the password required to allow extraction.

Example:           oem3701 12345678

A Windows-based dialog box prompts you to enter the password.

The self-extracting archive will then extract the following files:

winload.exe	WinLoad utility program
howto.txt	Instructions on how to use the WinLoad utility
whatsnew.rtf	Information on the changes made in the firmware since the last revision
xxxx.hex	Firmware version upgrade file, where xxxx = version level (for example, 3701.hex)

The files are extracted to unzip/program files/NovAtel Inc/x.xxx Full Update Disk, where x.xxx is the firmware version.

## Using the WinLoad Utility

WinLoad is a Windows-based program used to download firmware to OEMV family cards. The main screen is shown in Figure 19.

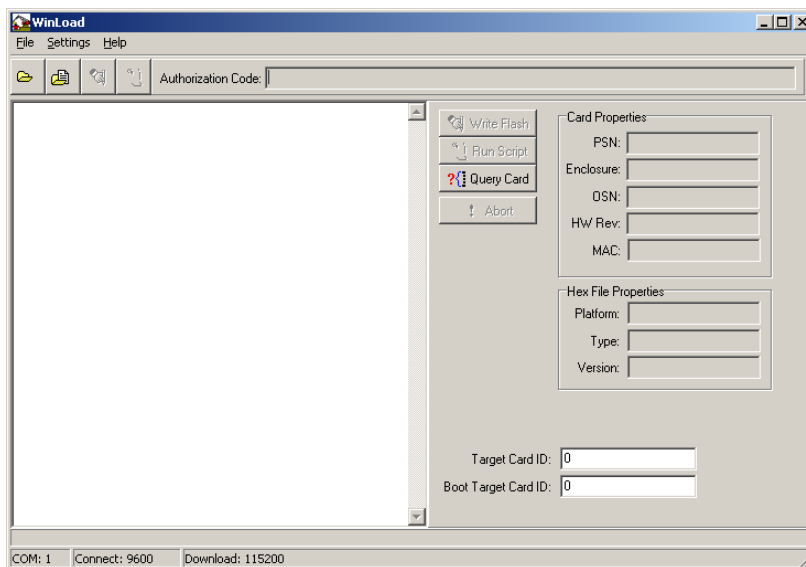
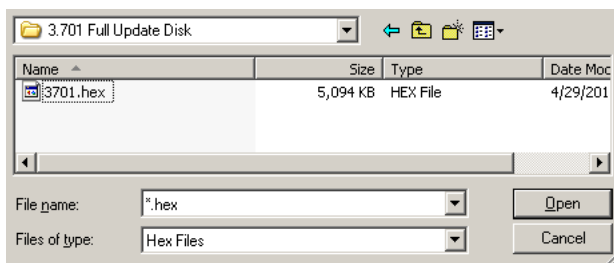

**Figure 19: Main Screen of WinLoad**

If you are running WinLoad for the first time you will need to make sure the file and communications settings are correct.

### Open a File to Download

From the file menu select Open. Use the Open dialog to browse for your file, see *Figure 20*.



**Figure 20: WinLoad's Open Dialog**



Once you have selected your file and clicked Open, the name of the file appears in the main WinLoad display area and in the title bar, see *Figure 21*.

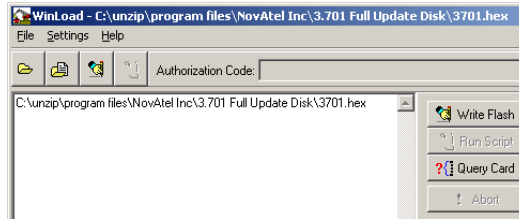

**Figure 21: Open File in WinLoad**

## Communications Settings

To set the communications port and baud rate, select COM Settings from the Settings menu. Choose the port on your PC from the Com Port drop-down list and the baud rate from the Download Baudrate drop-down list. The baud rate should be as high as possible (the default of 115200 is preferred).

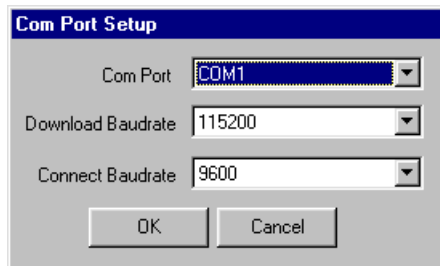
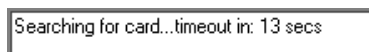

**Figure 22: COM Port Setup**

## Downloading firmware

To download firmware follow these steps:

1. Set up the communications port as described in *Communications Settings* above.
2. Select the file to download, see *Open a File to Download* on page 64.
3. Make sure the file path and file name are displayed in main display area, see *Figure 21, Open File in WinLoad* on page 65.
4. Click Write Flash to download the firmware.
5. Power down and then power up the receiver when “Searching for card” appears in the main display, see *Figure 23*.



**Figure 23: Searching for Card**

6. When the Authorization Code dialog opens, see *Figure 24*, enter the auth code then click OK.

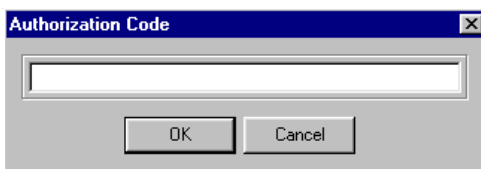

**Figure 24: Authorization Code Dialog**

7. The receiver should finish downloading and reset. The process is complete when “Done.” is displayed in the main display area, see *Figure 25*.

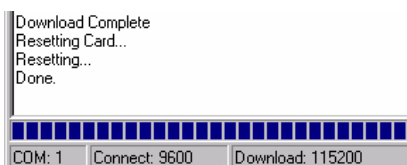

**Figure 25: Upgrade Process Complete**

8. Close WinLoad.

This completes the update/upgrade procedure.

#### 4.4.2 Upgrading Using the AUTH Command

The AUTH command authorizes the enabling (unlocking) of model features. Use this command when upgrading to a new OEMV family model that is available with the same firmware version as your current model. This command only functions in conjunction with a valid auth-code assigned by Customer Support.

The upgrade can be performed directly through the Connect command line, or from any other communications program. The procedure is as follows:

- 1) Power-up the OEMV family receiver and establish communications over a serial port (see *Chapter 3, Operation on Page 46*)
- 2) Issue the LOG VERSION command to verify the current model, firmware version, and serial number.
- 3) Issue the AUTH command, followed by the auth-code and model type. The syntax is as follows:

Syntax:

```
auth auth-code
```

where auth is a command that enables model upgrades, and auth-code is the upgrade authorization code, expressed as hhhh,hhhh,hhhh,hhhh,hhhh,model#

where the h characters are in ASCII hexadecimal code, and the model# is in ASCII text.

Example:

```
auth 17CB,29AF,3D74,01EC,FD34,L12LRV
```

Once the AUTH command has been executed, the OEMV family receiver will reboot. Issuing the LOG VERSION command will confirm the new upgrade model type and firmware version number.

If communicating using Connect, the communication path needs to be closed and re-opened using the Device menu.

*Bluetooth* is a wireless radio communication standard designed for use over short ranges (within 10 m). SMART-MR10/15 support *Bluetooth* 2.0. This chapter describes how to:

- Enable *Bluetooth* wireless technology on the receiver
- Set up a computer/laptop with a *Bluetooth* adaptor
- Locate a SMART-MR10 or SMART-MR15 with Bluetooth wireless technology in range
- Communicate with the SMART-MR10 or SMART-MR15 using *Bluetooth* wireless technology
- Stop communicating with the SMART-MR10 or SMART-MR15 using *Bluetooth* wireless technology

## 5.1 Enable *Bluetooth* wireless technology on the receiver

The *Bluetooth* configuration for the SMART-MR10 is illustrated in *Figure 26* and for the SMART-MR15 is illustrated in *Figure 27*:

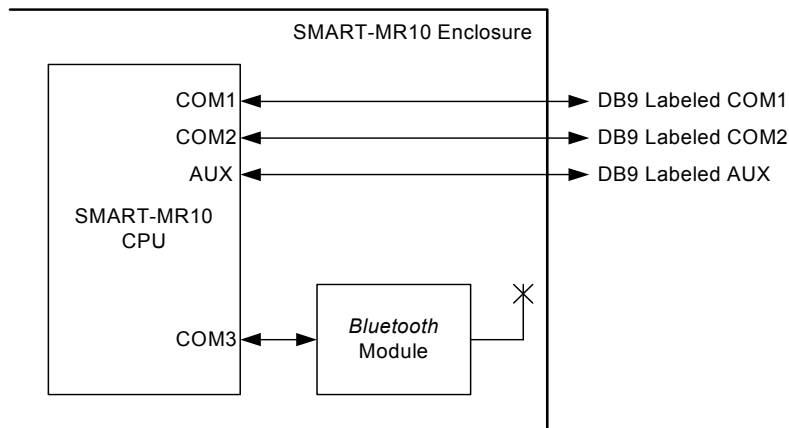

**Figure 26: Bluetooth Configuration (SMART-MR10)**

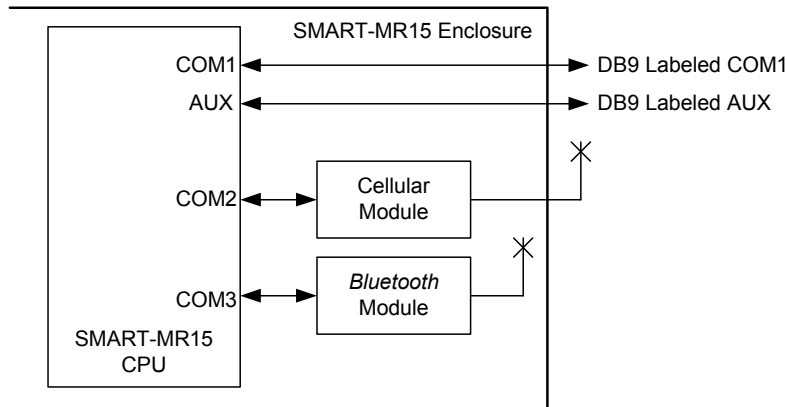

**Figure 27: Bluetooth Configuration (SMART-MR15)**

*Bluetooth* wireless technology is configured on the SMART-MR10 or SMART-MR15 COM3 port and, by default, is enabled.



If the SMART-MR10 or SMART-MR15 is turned off (or power is removed) then turned back on, the *Bluetooth* mode is returned to the state it was in before power-down, as long as the SAVECONFIG command was issued before the unit was powered off. When you issue a FRESET command, COM3 defaults to *Bluetooth* mode.

If *Bluetooth* wireless technology has been disabled, you will need to enable it before you can use it. From a computer/laptop, connect to a SMART-MR10 or SMART-MR15 serial port. Open communication with the receiver using HyperTerminal or Connect. See *Appendix B.2, BTCONTROL Enable/Disable Bluetooth wireless technology* starting on page 90 for further information. Once your computer/laptop is configured for *Bluetooth* operation, you will be able to communicate with the SMART-MR10 or SMART-MR15 through *Bluetooth* wireless technology.

## 5.2 Set Up a Computer/Laptop with a *Bluetooth* Adaptor

If your computer/laptop is already equipped with *Bluetooth* wireless technology and ready, proceed to *Section 5.3, Locate a SMART-MR10 or SMART-MR15 with Bluetooth wireless technology in range* on *Page 70*

1. With the computer/laptop powered on, install the driver(s) from the disc that came with your *Bluetooth* adapter.
2. Connect the *Bluetooth* adapter. An example of a *Bluetooth* USB adapter is shown in *Figure 28*:



**Figure 28: *Bluetooth* Adapter for Computer/Laptop**

Within two minutes of connecting the USB adapter, the *Bluetooth* icon appears in the Windows task bar as shown in *Figure 29*.



**Figure 29: *Bluetooth* Standby: White**

Continue on to the next section when you see the white *Bluetooth* icon. If the *Bluetooth* icon is red, as shown in *Figure 30*, the *Bluetooth* installation on your computer/laptop is incorrect and you should return to step #1.



**Figure 30: *Bluetooth* Error: Red**

## 5.3 Locate a SMART-MR10 or SMART-MR15 with *Bluetooth* wireless technology in range



Ensure your computer/laptop is equipped with a built in, or external-plug-in, *Bluetooth* adapter and is already configured with the appropriate *Bluetooth* driver.

1. Power on the SMART-MR10 or SMART-MR15.
2. Double-click the *Bluetooth* icon in the task bar, as shown in *Figure 29*, or select *Programs | My Bluetooth Places* from the *Start* menu in Windows. The *My Bluetooth Places* window opens.
3. Click the *Search for devices in range* option from the *Bluetooth Tasks* side bar on the left of the *My Bluetooth Places* window. Devices with *Bluetooth* wireless technology enabled within range appear in the *Entire Bluetooth Neighborhood* folder, as shown in *Figure 31*.

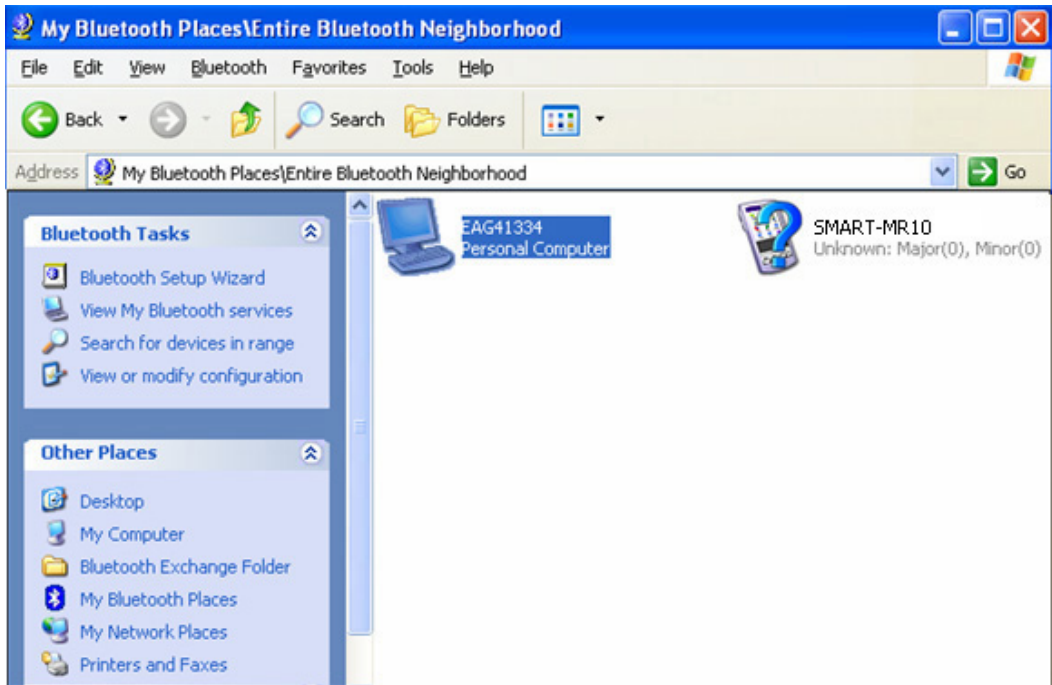
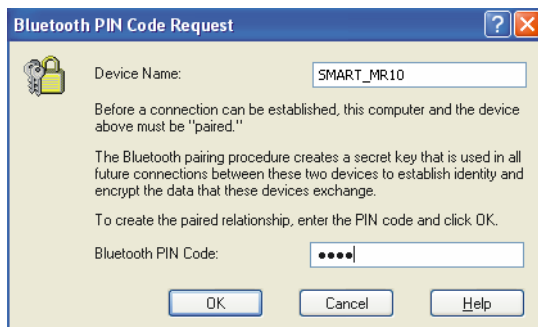

Figure 31: My *Bluetooth* Places Window

## 5.4 Communicate with the SMART-MR10 or SMART-MR15 Using *Bluetooth* wireless technology

1. Double-click the SMART-MR10 or SMART-MR15 device icon in the *Entire Bluetooth Neighborhood* window, as shown in *Figure 31*. The PC/laptop searches for available services. If *Bluetooth* is working properly, a COM port service appears.
2. Double-click the COM3 icon. To use the serial COM port, the SMART-MR10 or SMART-MR15 must be “paired” with the computer/laptop to use the COM3 port. The *Bluetooth* PIN Code Request dialog appears.
3. Enter the SMART-MR10 or SMART-MR15 default pin number of four zeroes (0000), as shown in *Figure 32*:



**Figure 32: Bluetooth PIN Code Request**

If the code is correct, a new *COM* dialog opens, showing the computer/laptop COM port that has been assigned to the *Bluetooth* link. For example, in *Figure 33*, the computer/laptop port is COM21.

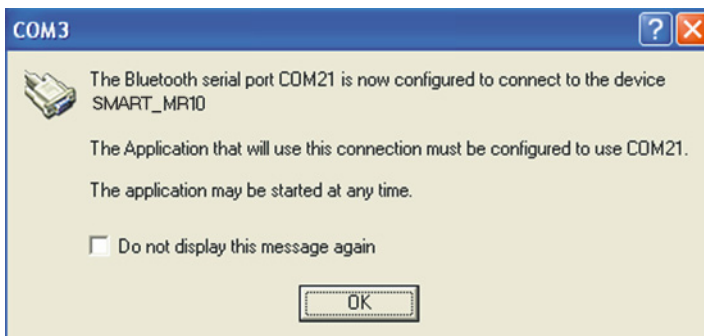

**Figure 33: Computer/Laptop COM3 Port Assignment**

4. Open a terminal program (HyperTerminal, for example) and configure it to the serial port specified in the *Bluetooth* configuration utility. In the above example, the terminal program must be configured to connect through COM21.
5. Configure the port settings as follows:
  - 9600 bps, no parity, 8 data bits, 1 stop bit, no handshaking, echo off
6. Through the terminal program, connect to the *Bluetooth* serial port, and verify the connection.
7. Type the following VERSION log request into the command prompt to ensure that the connection works:

```
LOG VERSION
```

The *Bluetooth* icon in the task bar turns green when it is connected, as shown in *Figure 34*.

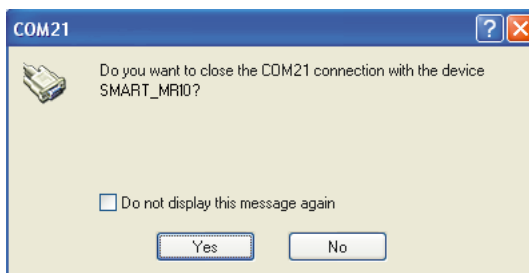



Figure 34: *Bluetooth Connected: Green*

## 5.5 Stop Communicating with SMART-MR10 or SMART-MR15 Using *Bluetooth* wireless technology

1. Double-click the *Bluetooth* icon in the task bar, as shown in *Figure 29* on page 70, or select *Programs | My Bluetooth Places* from the *Start* menu in Windows. The *My Bluetooth Places* window opens.
2. Click the *Search for devices in range* option from the *Bluetooth Tasks* side bar on the left of the *My Bluetooth Places* window. Devices with *Bluetooth* wireless technology enabled within range appear in the *Entire Bluetooth Neighborhood* folder, as shown in *Figure 31* on page 71.
3. Double-click the SMART-MR10 or SMART-MR15 device icon in the *Entire Bluetooth Neighborhood* window. The computer/laptop searches for available services. If *Bluetooth* wireless technology is working properly, COM port service appears.
4. Right-click the *COM21* icon then select the *Disconnect Serial COM Port* option. A *COM21* dialog box appears, as shown in *Figure 35*, requesting confirmation that you want to disconnect.

Figure 35: *COM21 Disconnect?*

5. Click *Yes* in the *COM21* dialog. The SMART-MR10 or SMART-MR15 *Bluetooth* wireless technology is unpaired from your computer/laptop. When the SMART-MR10 or SMART-MR15 and computer/laptop *Bluetooth* wireless technology are unpaired, the *Bluetooth* icon in the task bar appears white, as shown in *Figure 29* on page 70.

# Appendix A Technical Specifications

## A.1 SMART-MR10/15 Receiver Performance

<b>PERFORMANCE</b>			
<b>Channel Configuration</b>	14 GPS L1, 14 GPS L2 12 GLONASS L1, 12 GLONASS L2 (optional) 2 SBAS <sup>a</sup> 1 L-band		
<b>Horizontal Position Accuracy (RMS)<sup>b</sup></b>	Autonomous (L1)	1.5 m	
	Autonomous (L1/L2)	1.2 m	
	SBAS <sup>a</sup>	0.6 m	
	CDGPS	0.6 m	
	DGPS	0.4 m	
	OmniSTAR		
	VBS	0.6 m	
	XP	0.15 m	
	HP	0.1 m	
	RT-20™ <sup>c</sup> (optional)	0.2 m	
	RT-2™ <sup>c</sup> (optional)	1 cm+1 ppm	
<b>Measurement Precision</b>		GPS	GLONASS
	L1 C/A Code	4 cm RMS	15 cm RMS
	L1 Carrier Phase	0.5 mm RMS	1.5 mm RMS
	L2 P(Y) Code	8 cm RMS	8 cm RMS
	L2 Carrier Phase	1.0 mm RMS	1.5 mm RMS
<b>Maximum Data Rate<sup>d</sup></b>	Measurements	20 Hz	
	Position	20 Hz	
<b>Time to First Fix</b>	Cold Start <sup>e</sup>	65 s	
	Hot Start <sup>f</sup>	35 s	
<b>Signal Reacquisition</b>	L1	0.5 s (typical)	
	L2	1.0 s (typical)	
<b>Time Accuracy</b>	20 ns RMS		
<b>Velocity Accuracy<sup>b</sup></b>	0.03 m/s RMS		
<b>Velocity<sup>b</sup></b>	515 m/s RMS		

- Satellite Based Augmentation Systems (SBAS) include WAAS (North America), EGNOS (Europe) and MSAS (Japan).
- Typical values. Performance specifications subject to GPS and GLONASS system characteristics, US DOD operational degradation, ionospheric and tropospheric conditions, satellite geometry, baseline length, multipath effects and the presence of intentional or unintentional interference sources. Export licensing restricts operation to a maximum velocity of 515 metres per second.
- Expected accuracy after convergence. RT-20 is independent of GL1DE.
- Model specific. Contact NovAtel customer support prior to using 20 Hz data rates.
- Typical value. No almanac or ephemerides and no approximate position or time.
- Typical value. Almanac and recent ephemerides saved and approximate time entered. For more information, Please refer to the "SETAPPROXTIME" command in the *OEMV Family Firmware Reference Manual* found on our website at [www.novatel.com/support/firmware-software-and-manuals/product-manuals-and-doc-updates/](http://www.novatel.com/support/firmware-software-and-manuals/product-manuals-and-doc-updates/).

## A.2 SMART-MR10 Specifications

<b>INPUT/OUTPUT CONNECTORS</b>	
SMART-MR10 Power	+9 to +36 V DC at 2.5 W (typical while logging) <sup>a</sup> For the cable pinouts and drawings, see <i>Connector Cables starting on page 83</i> and <i>Streamlined Cable (Part Number 01018526) starting on page 85</i> .
Serial Com Ports	Using the MODE pin (refer to <i>Table 3 on page 34</i> ), SMART-MR10 can be configured with 2 or 3 serial ports. COM1 is available in RS-232 with and without flow control or as RS-422. COM2 is available with no flow control. AUX is available only when COM1 is used as RS-232 with no flow control. All ports are configurable to a maximum of 230,400 bps.
CAN	SAE J1939/ ISO 11783/ ISO 11898 Compliant (at 250 kbps)
Emulated Radar Output	ER operates on distinct frequencies (26.11, 28.12 or 36.11 Hz/km/hr, with 36.11 Hz/km/hr being the default value), with an effective range from 1 km/hr to 55 km/hr for near-horizontal applications. Refer to <i>Emulated Radar (ER) on page 40</i> for further information.
PPS Output	3.3 V CMOS Logic Compatible
MKI Input	3.3 V CMOS Logic/ 5 V Tolerant
<b>EMI/EMC</b>	
Emissions	FCC, CE, Industry Canada
Immunity	CE, ISO 7637, ISO 15003
<b>LED INDICATORS</b>	
More details can also be found in <i>Section 2.3.2, Status Indicators starting on page 37</i>	
<b>PHYSICAL</b>	
Size	233 mm x 223 mm x 90 mm height
Weight	1.9 kg maximum
<b>ENVIRONMENTAL</b>	
Operating Temperature	-40°C to +70°C
Storage Temperature	-55°C to +90°C
Humidity	Not to exceed 95% non-condensing
Immersion	MIL-STD-810G Method 512.5, IEC 60529 IPX7

*Continued on the following page*

**ENVIRONMENTAL (continued)**

UV Protection	IEC 60950-22 Section 5.8.2 Test Method IEC 68-2-5
Salt Fog	IEC 60950-22 Section 8.3
Sand and Dust	MIL-STD-810G Method 510.5, IEC 60950-22 Section 9.3
Vibration <sup>b</sup>	Random            MIL-STD-202G Method 214A Condition A Sinusoidal        ASAE EP455 Section 5.15.2 Level 1
Shock	Shock            MIL-STD-810G Method 516.6
Chemical Resistance	ASAE EP455 Section 5.8.2 (Brush Exposure)
Water Jets	IEC 60529 IPX6
Blowing Rain	MIL-STD-810G Method 506.5 Procedure 1
Altitude	ASEA EP455 Section 5.2

- a. When tracking GPS satellites.
- b. See also the *Notice* section of this manual starting on *Page 8*.

## DIMENSIONS

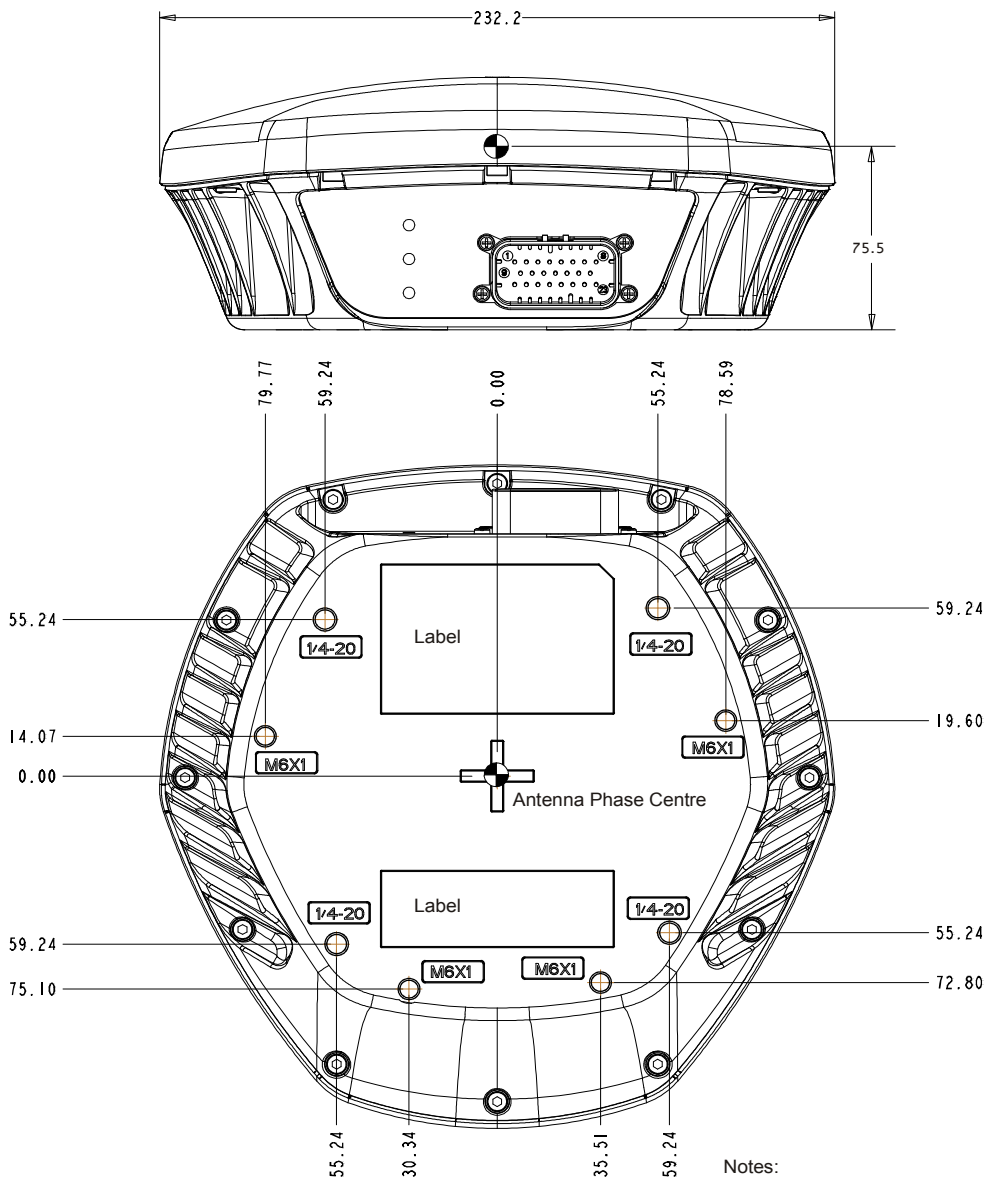

 Antenna Phase Centre

- Notes:
1. All dimensions are in millimetres
  2. Mounting holes are labelled according to their size and thread.

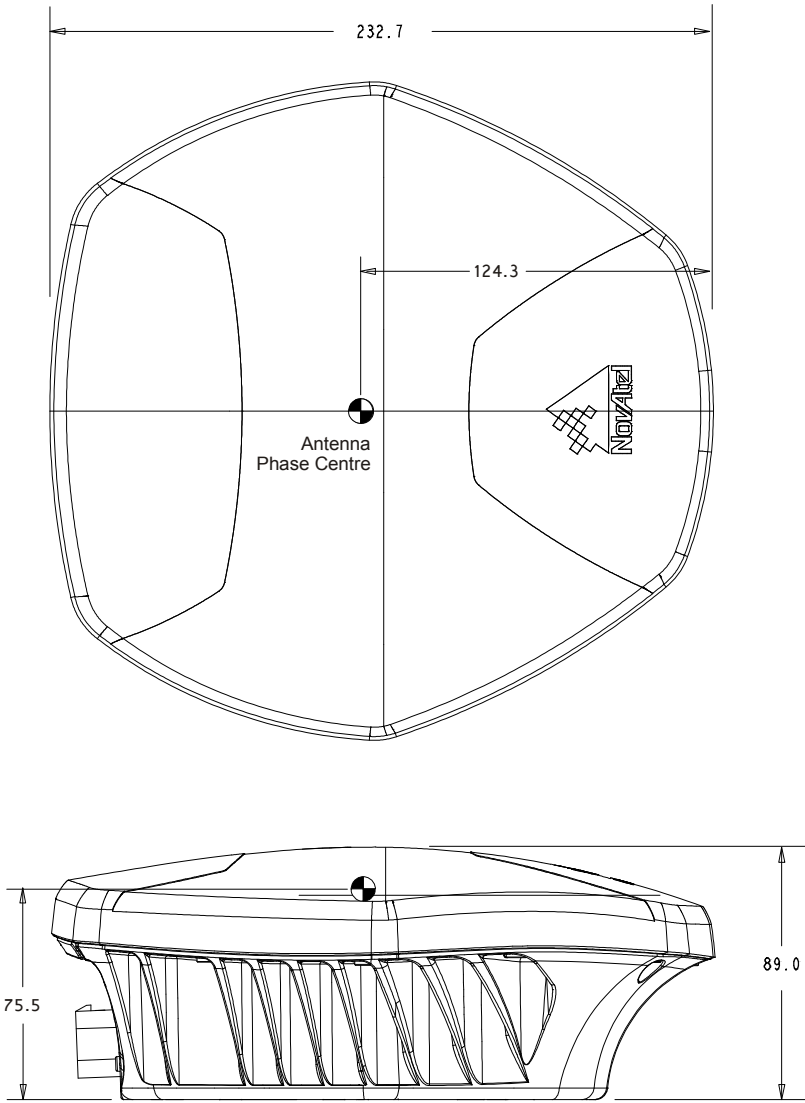

 Antenna Phase Centre

Note: All dimensions are in millimetres.

## A.3 SMART-MR15 Specifications

<b>INPUT/OUTPUT CONNECTORS</b>	
SMART-MR15 Power	+9 to +36 V DC at 4.5 W (typical) <sup>a</sup> For the cable pinouts and drawings, see <i>Connector Cables</i> starting on page 83 and <i>Streamlined Cable (Part Number 01018526)</i> starting on page 85.
Serial Com Ports	Using the MODE pin (refer to <i>Table 5</i> on page 35), SMART-MR15 can be configured with two serial ports. COM1 is available as RS-232 with flow control or as RS-422. AUX is available as RS-232 with no flow control. All ports are configurable to a maximum of 230,400 bps.
Cellular modules	CDMA and GSM/GPRS/HSDPA
CAN	SAE J1939/ ISO 11783/ ISO 11898 Compliant (at 250 kbps)
Emulated Radar Output	ER operates on distinct frequencies (26.11, 28.12 or 36.11 Hz/km/hr, with 36.11 Hz/km/hr being the default value), with an effective range from 1 km/hr to 55 km/hr for near-horizontal applications. Refer to <i>Emulated Radar (ER)</i> on page 40 for further information.
PPS Output	3.3 V CMOS Logic Compatible
MKI Input	3.3 V CMOS Logic/ 5 V Tolerant
<b>EMI/EMC</b>	
Emissions	FCC, CE, Industry Canada
Immunity	CE, ISO 7637, ISO 15003
<b>LED INDICATORS</b>	
More details can also be found in <i>Section 2.3.2, Status Indicators</i> starting on page 37	
<b>PHYSICAL</b>	
Size	233 mm x 223 mm x 90 mm height
Weight	2.1 kg maximum
<b>ENVIRONMENTAL</b>	
Operating Temperature	-40°C to +65°C (CDMA) -40°C to +65°C (GSM/GPRS/HSDPA)
Storage Temperature	-40°C to +85°C
Humidity	Not to exceed 95% non-condensing
Immersion	MIL-STD-810G Method 512.5, IEC 60529 IPX7
UV Protection	IEC 60950-22 Section 5.8.2 Test Method IEC 68-2-5
Salt Fog	IEC 60950-22 Section 8.3

*Continued on the following page*

---

**ENVIRONMENTAL (continued)**

Sand and Dust	MIL-STD-810G Method 510.5, IEC 60950-22 Section 9.3
Vibration <sup>b</sup>	Random            MIL-STD-202G Method 214A Condition A Sinusoidal        ASAE EP455 Section 5.15.2 Level 1
Shock	Shock            MIL-STD-810G Method 516.6
Chemical Resistance	ASAE EP455 Section 5.8.2 (Brush Exposure)
Water Jets	IEC 60529 IPX6
Blowing Rain	MIL-STD-810G Method 506.5 Procedure 1
Altitude	ASEA EP455 Section 5.2

- a. When tracking GPS satellites.
- b. See also the *Notice* section of this manual starting on *Page 8*.



## DIMENSIONS

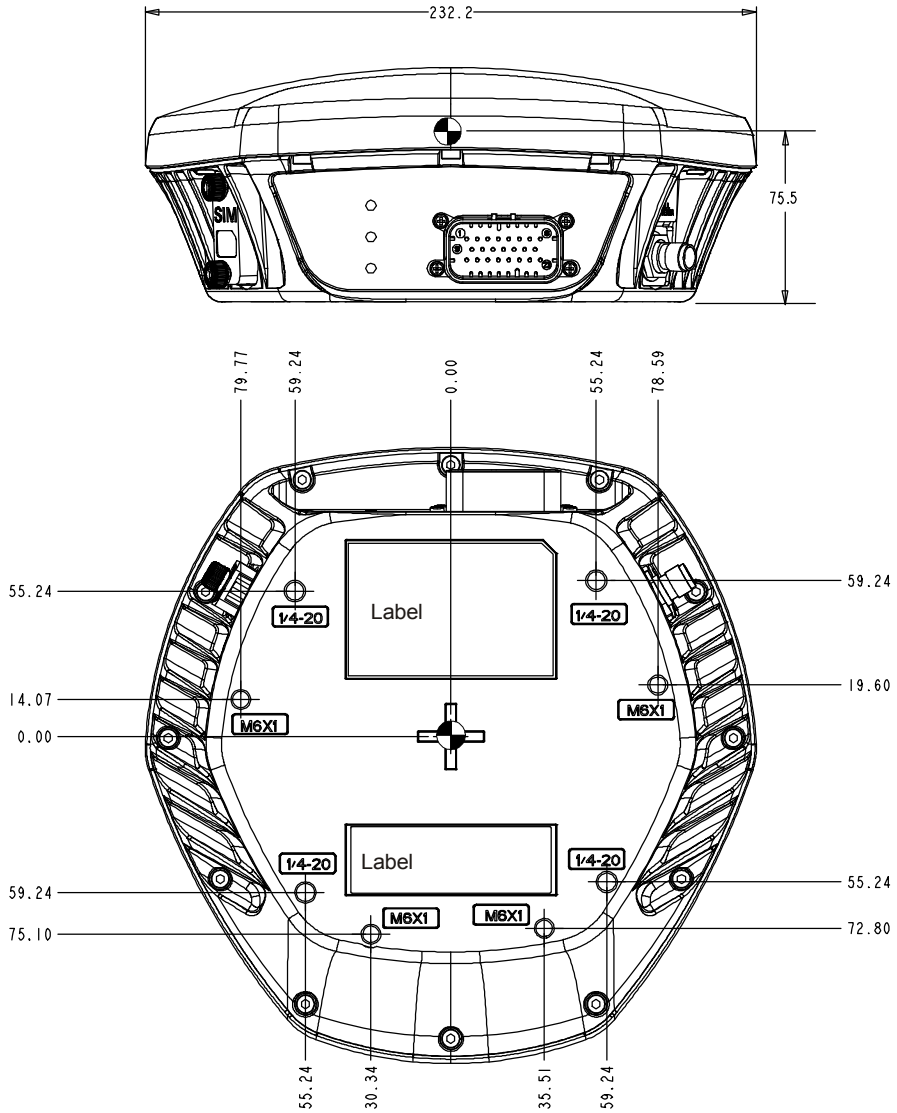

 Antenna Phase Centre

**Notes:**

1. All dimensions are in millimetres.
2. Mounting holes are labelled according to their size and thread.

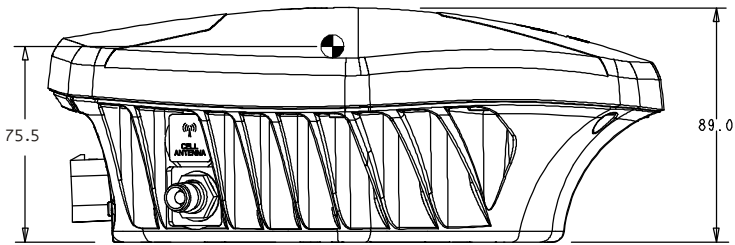
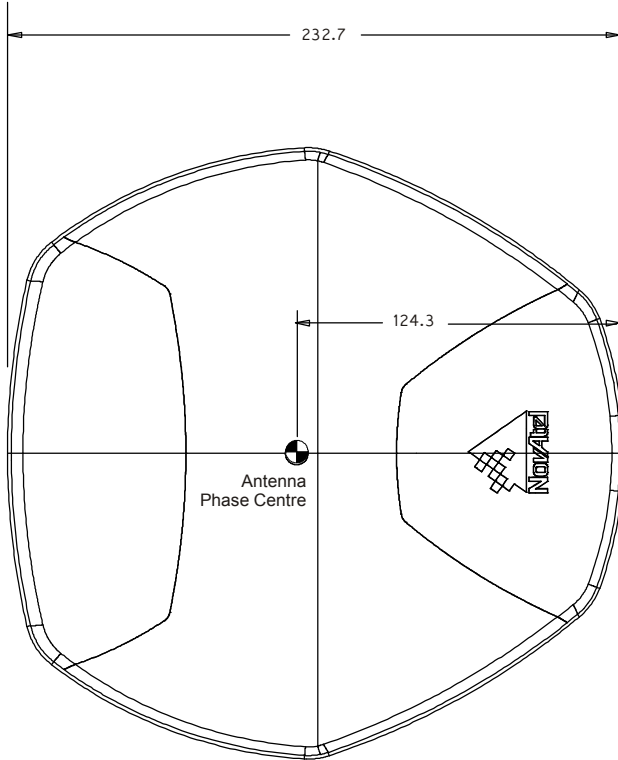

Antenna Phase Centre

Note: All dimensions are in millimetres

## A.4 Connector Cables

### A.4.1 Evaluation Cable (Part Number 01018515)

The SMART-MR10/15 evaluation cable provided with Development Kit, is illustrated in *Figure 36* and equipped as follows:

- Exposed power wires (red for positive and black for negative) are connected to a 12 or 24V vehicular power circuit (or equivalent), which must be protected by a user-supplied 5A fuse (NovAtel recommends an automotive blade-type fuse rated for 5A with an operating voltage of more than 36 V).
- Three DB-9 connectors. One of these is normally connected to a PC/laptop serial (RS-232) communication port and another to a modem or radio transmitter, to propagate differential corrections (refer to your user-supplied modem or radio transmitter user guide for more information).
- Four pairs of bare wires, where the outer insulation is cut away but the wires beneath are intact. These are provided for emulated radar, MKI, PPS, and CAN bus. See *Table 11* on *page 84* for their pinouts and use. For more information on mating connectors and part numbers, see *Table 13* on *page 87*.
- Some COM port pin-out differences exist between the SMART-MR10 and the SMART-MR15. Note cable labels.

This cable is RoHS compliant.

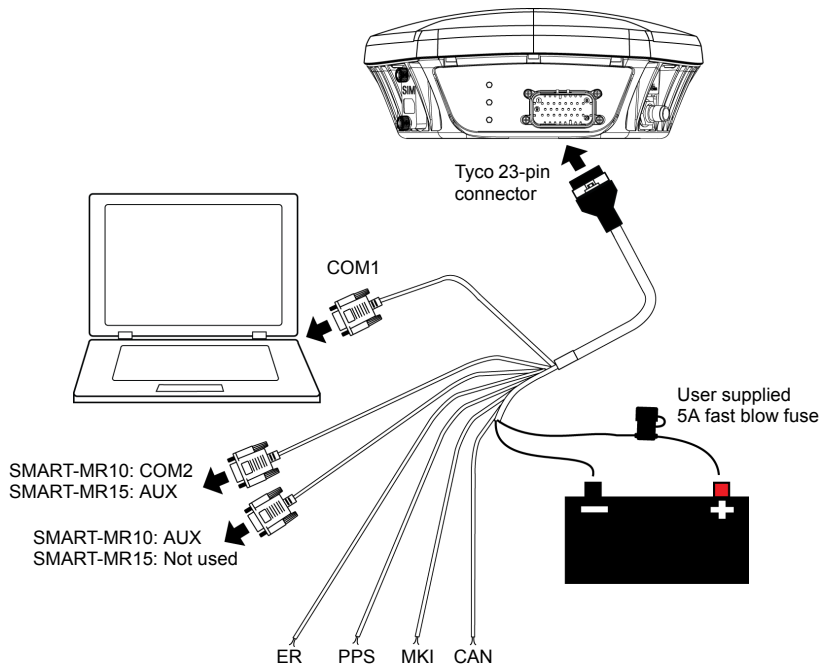

**Figure 36: SMART-MR10/15 Evaluation Cable**

**Table 11: Evaluation Cable Pinouts**

<b>TYCO 23-PIN</b>	<b>COM1 D-SUB</b>	<b>COM2 D-SUB</b>	<b>AUX D-SUB</b>	<b>TINNED LEAD</b>	<b>SIGNAL NAME</b>
1				PWR+ (red)	PWR+
2				PWR- (black)	PWR-
3				CAN- (green)	CAN-
4				CAN+ (yellow)	CAN+
5		2			TXD2 (SMART-MR10) AUXTX (SMART-MR15)
6		3			RXD2 (SMART-MR10) AUXRX (SMART-MR15)
7	2				TXD1/TXD1+
8			2		RTS1/AUXTX/TXD1- (SMART-MR10) RTS1 (SMART-MR15)
9				SIGGND2 (white/black)	SIGGND2
10	RESERVED				
11	RESERVED				
12	RESERVED				
13	RESERVED				
14	CHASSIS GROUND <sup>a</sup>				
15	5	5	5	SIGGND1 (white/black)	SIGGND1
16				MKI (white)	MKI
17				PPS (orange)	PPS
18				ER (blue)	ER
19				MODE (violet)	MODE
20	RESERVED				
21	RESERVED				
22			3		CTS1/AUXRX/RXD1- (SMART-MR10) CTS1 (SMART-MR15)
23	3				RXD1/RXD1+

a. Pin 14 is connected to cable shields.

## A.4.2 Streamlined Cable (Part Number 01018526)

The SMART-MR10/15 streamlined cable, chemical resistant, designed for reduced size and weight, and increased flexibility, provides:

- Connection to a battery while operating in the field. The exposed wires (red for positive and black for negative) can be connected to a 12 or 24V vehicular power circuit (or equivalent), which must be protected by a user-supplied 5A fuse (NovAtel recommends an automotive blade-type fuse rated for 5A with an operating voltage of more than 36 V).
- Two DB-9 connectors. One of these is normally connected to a PC/laptop serial (RS-232) communication port and the other to a modem or radio transmitter to propagate differential corrections (refer to your user-supplied modem or radio transmitter user guide for more information on its connectors).
- One pair of bare wires, where the outer insulation is cut away but the wires beneath are intact, are provided for emulated radar. See *Table 12* on *page 86* for their pinouts. For more information on mating connectors and part numbers, see *Table 13* on *page 87*.

This cable is RoHS compliant.

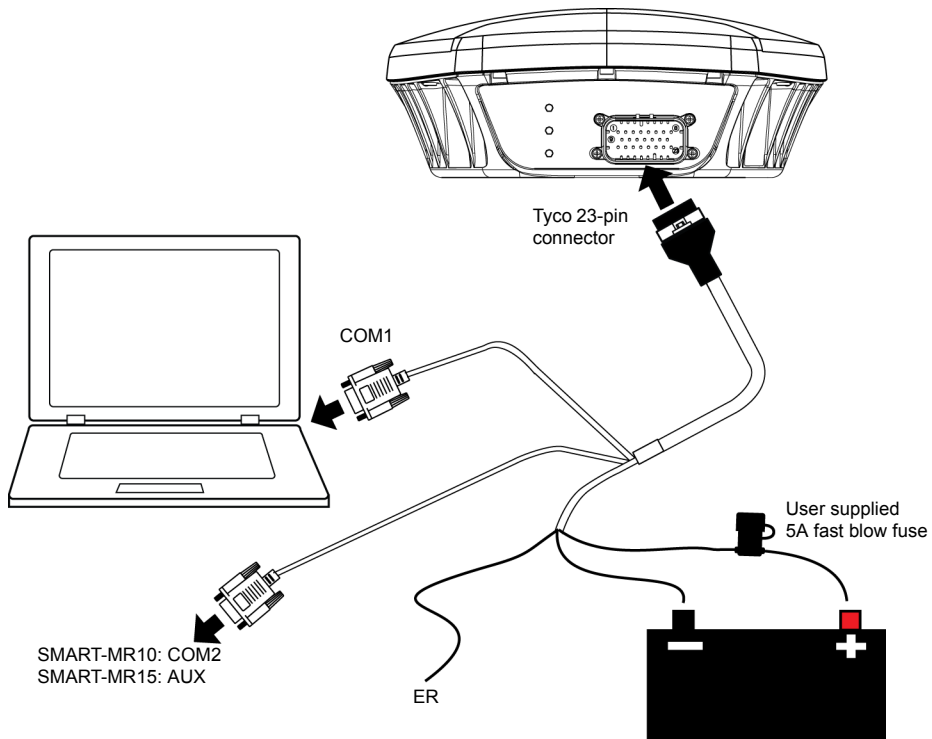

**Figure 37: SMART-MR10/15 Streamlined Cable**

**Table 12: Streamlined Cable Pinouts**

<b>TYCO 23-PIN</b>	<b>COM1 D-SUB</b>	<b>COM2 D-SUB</b>	<b>TINNED LEAD</b>	<b>SIGNAL NAME</b>
1			PWR+ (red)	PWR+
2			PWR- (black)	PWR-
3	RESERVED			
4	RESERVED			
5		2		TXD2 (SMART-MR10) AUXTX (SMART-MR15)
6		3		RXD2 (SMART-MR10) AUXRX (SMART-MR15)
7	2			TXD1
8	RESERVED			
9			SIGGND2 (white/black)	SIGGND2
10	RESERVED			
11	RESERVED			
12	RESERVED			
13	RESERVED			
14	CHASSIS GROUND <sup>a</sup>			
15	5	5	SIGGND1 (white/black)	SIGGND1
16	RESERVED			
17	RESERVED			
18			ER (blue)	ER
19	RESERVED			
20	RESERVED			
21	RESERVED			
22	RESERVED			
23	3			RXD1

a. Pin 14 is connected to cable shields.

### A.4.3 Custom Connector and Cable Requirements

Custom cables for installing your SMART-MR10 or SMART-MR15 can be created using the following guidelines:

- Conductor size must be 20 AWG (0.032 inches, 0.81 mm in diameter) to 16 AWG (0.051 inches, 1.29 mm in diameter)
- Wire outside diameter, including insulation, must be between 0.086 in. (2.2 mm) and 0.098 in. (2.5 mm) in diameter
- Insulator material must have a smooth finish
- Batt + connection must be protected by a user-supplied fuse. NovAtel recommends an automotive blade-type fuse, rated for 5A with an operating voltage of more than 36V.
- Serial data signals (TxD, RxD, signal ground) must be run in shielded cable. Connect shields to ground at the SMART-MR end only
- CAN signal conductors must be twisted (40 twists/m, 12 twists/ft)
- Use only the recommended mating connectors listed below. Use only gold plated pins



Failure to observe the given cable construction requirements in this section will result in damage to the wiring (not covered by warranty).

The connector used in the SMART-MR10/15 is an “AMPSEAL” dust and water sealed type produced by Tyco. The following part numbers pertain to the mating connector required to make connections to the SMART-MR10/15. These numbers are provided for information only and are not available from NovAtel as separate parts.

**Table 13: Mating Connectors**

Product	Part Description	Company	Part Number
SMART-MR10 mating connector (see <i>Figure 36, SMART-MR10/15 Evaluation Cable on Page 83 and Figure 37, SMART-MR10/15 Streamlined Cable on Page 85</i> )	23-pin sealed receptacle housing black	Tyco/AMP	770680-1
Gold plated pins for SMART-MR10/15 connector/ loose	Pins, loose piece	Tyco/AMP	770854-3
Gold plated pins for SMART-MR10/15 connector/strip	Pins, strip (reel)	Tyco/AMP	770520-3

*Table 14* details the part numbers for recommended fuses. These numbers are provided for information only and are not available from NovAtel as separate parts.

**Table 14: Recommended Fuses**

Fuse Type	Recommended	
Blade Fuse 58V 5A	Littelfuse	142.6185.450
Mini Blade Fuse 58V 5A	Littelfuse	0997005

## Appendix B Commands

The SMART-MR10/15 firmware implements the OEMV family command set, documented in *OEMV Family Firmware Reference Manual*. For convenience, commonly used SMART-MR10/15 commands are summarized in Table 15 and documented in this appendix.

**Table 15: Commonly Used SMART-MR10/15 Commands in Alphabetical Order**

ASCII Command	Message ID	Description
BTCONTROL	8205	Enable/disable <i>Bluetooth</i> wireless technology.
CELLACTIVATE <sup>a</sup>	8215	Activate the CDMA cellular mode for a specified carrier
CELLSET <sup>a</sup>	8212	Set the APN name and pin, and whether roaming is enabled
COM	4	Configure the receiver's asynchronous serial ports communications drivers.
FRESET	20	Clear data stored in non-volatile memory and reset.
LOG	1	Request logs from the receiver.
NTRIPCASTER <sup>a</sup>	8230	Set the NTRIP caster that the receiver will mount to. (SMART-MR15 only)
NTRIPCLIENT <sup>a</sup>	8231	Configure the NTRIP client to receive (or stop receiving) corrections from the caster.
PDPFILTER <sup>b</sup>	424	Enable, disable or reset the PDP (Pseudorange Delta-Phase) filter.
PDPMODE <sup>b</sup>	970	Select the PDP filter mode and dynamics.
RADARCFG	8192	Configure the ER signal output.
RESET	18	Perform a hardware reset.
SBASCONTROL	652	Set SBAS test mode and PRN.
SETCANNAME	1091	Set the CAN name fields.

a. Only available in the SMART-MR15.

b. For use with GL1DE.

The arguments for each of these commands are described in the following sections.

For a complete listing and description of the other commands that the SMART-MR10 or SMART-MR15, OEMV-3G based receivers, are capable of processing, refer to the *OEMV Family Firmware Reference Manual*.



---

## B.1 SYNTAX CONVENTIONS

The following rules apply when entering commands, at the command prompt, from a keyboard.

1. `Courier` font is used to illustrate program output or user input.
2. References to other commands, logs or any of their fields are shown in *italics*.
3. The commands are not case sensitive. For example, you could type either `RESET` or `reset`.
4. Except where noted, either a space or a comma can separate commands and their required entries. For example, you could type either `fix position 51.11358042 -114.04358013 1059.4105` or `fix position 51.11358042, -114.04358013, 1059.4105`.
5. At the end of a command, a carriage return is required. For example, press <Enter> or <Return> on your keyboard.
6. Responses are provided to indicate whether or not an entered command was accepted. The format of the response depends on the format of the command. Refer to the *OEMV Family Firmware Reference Manual* for more information.
7. Optional parameters are indicated by square brackets ( [ ] ). For commands that contain optional parameters, the value used if the optional parameter is not specified is given in the syntax table for the command.
8. Data format definitions, as specified in the “Format” field, are detailed in the *OEMV Family Firmware Reference Manual*. Note that all binary data is little-endian byte-ordered.

## B.2 BTCONTROL Enable/Disable *Bluetooth* wireless technology

The BTCONTROL command enables or disables the *Bluetooth* module. To ensure no possibility of interference, when the module is disabled it is completely powered down.

**Abbreviated ASCII Syntax:**

**Message ID: 8205**

```
BTCONTROL switch
```

**Factory Default:**

The *Bluetooth* module is enabled by default.

**Example 1 to disable *Bluetooth* wireless technology:**

```
btcontrol disable
```

**Example 2 to enable *Bluetooth* wireless technology:**

```
btcontrol enable
```

Field	Data	Description	Binary Bytes	Binary Format	Binary Offset
1	BT CONTROL header	This field contains the command name or the message header depending on whether the command is abbreviated ASCII, ASCII or binary, respectively.	-	-	0
2	switch	Enable or disable <i>Bluetooth</i> wireless technology 0 = ENABLE 1 = DISABLE (default = ENABLE)	4	Enum	H



1. If users want the current state of the *Bluetooth* module to persist across receiver resets and power-ups, they should issue a saveconfig command.
2. Changing the *Bluetooth* wireless technology from disabled to enabled takes several seconds to execute. This means that, even though the user will get an immediate “OK>” response followed by the COM prompt, the *Bluetooth* module may not be ready for communication.

## B.3 CELLACTIVATE Activate CDMA modem for specific carrier

This command allows the user to activate the CDMA cellular modem for a specified carrier. Since the GSM/GPRS/HSDPA SIM cards are pre-activated, this command is only used with SMART-MR15s with CDMA modems.

**Abbreviated ASCII Syntax:**

**Message ID: 8215**

CELLACTIVATE carrier [mdn] [meid] [username] [password]

Field	Data	Description	Binary Bytes	Binary Format	Binary Offset
1	CELL ACTIVATE header	This field contains the command name or the message header depending on whether the command is abbreviated ASCII, ASCII or binary, respectively.	-	-	0
2	carrier	Name of wireless carrier (for example, verizon) [mandatory]	12	Char	H
3	MDN	Modem Directory Number (phone number)	12	Char	H+12
4	MEID	Mobile Equipment Identifier	12	Char	H+24
5	username	User name, if required	12	Char	H+36
6	password	Password, if required	12	Char	H+48

### ASCII Example:

Activate on Verizon:

```
cellactivate verizon
```

## B.4 CELLSET Set the APN name

This command allows the user to set the APN name (SMART-MR15 GSM/GPRS/HSDPA only). The APN (Access Point Name) identifies the IP packet data network (PDN) with which the mobile data user wants to communicate. Once a context and IP address are acquired, changing the APN through the CELLSET command won't force that context to be dropped. The modem needs to be reset through a receiver RESET command for the new APN to take effect.

**Abbreviated ASCII Syntax:**

**Message ID: 8212**

CELLSET [parameter] [value]

Field	Data	Description	Binary Bytes	Binary Format	Binary Offset
1	CELLSET header	This field contains the command name or the message header depending on whether the command is abbreviated ASCII, ASCII or binary, respectively.	-	-	0
2	parameter	Parameter name (APN name, User name or Password) [mandatory]	12	Char	H
3	value	Parameter value (APN name, User name or Password)	100	Char	H+12

### ASCII Examples:

Set the APN name. The factory default APN name is blank.

```
cellset apn internet.com
```

Set the user name, if provided by the carrier. The factory default user name is blank.

```
cellset user <user_name>
```

Set the password, if provided by the carrier. The factory default password is blank.

```
cellset password <password>
```

## B.5 COM Configure COM Port

This command permits you to configure the receiver's asynchronous serial port communications drivers.

The current COM port configuration can be reset to its default state at any time by sending it two hardware break signals of 250 milliseconds each, spaced by fifteen hundred milliseconds (1.5 seconds) with a pause of at least 250 milliseconds following the second break. This will:

- Stop the logging of data on the current port (see *UNLOGALL* command in the *OEMV Family Firmware Reference Manual*).
- Clear the transmit and receive buffers on the current port.
- Return the current port to its default settings (see Factory Defaults section in Chapter 2 Commands of the *OEMV Family Firmware Reference Manual*).
- Set the interface mode to NovAtel for both input and output (see *INTERFACEMODE* command in the *OEMV Family Firmware Reference Manual*).



Baud rates higher than 115,200 bps are not supported by standard PC hardware. Special PC hardware may be required for higher rates, including 230400 bps, 460800 bps and 921600 bps. Also, some PC's have trouble with baud rates beyond 57600 bps.

### Abbreviated ASCII Syntax:

Message ID: 4

```
COM [port] bps [parity[databits[stopbits[handshake[echo[break]]]]]]]
```

### Factory Default:

```
com com1 9600 n 8 1 n off on
com com2 9600 n 8 1 n off on
com aux 9600 n 8 1 n off on
```



- Do not alter the COM3 port configuration, since COM3 is reserved for *Bluetooth* wireless technology.
- On the SMART-MR15, do not alter the COM2 port configuration, since COM2 is reserved for the cellular modem.

### ASCII Example:

```
com com1,57600,n,8,1,n,off,on
```



Watch for situations where the COM ports of two receivers are connected together and the baud rates do not match. Data transmitted through a port operating at a slower baud rate may be misinterpreted as break signals by the receiving port if it is operating at a higher baud rate. This is because data transmitted at the lower baud rate is stretched relative to the higher baud rate. In this case, configure the receiving port to have break detection disabled using the COM command.



Use the COM command before using the *INTERFACEMODE* command on each port. Turn break detection off using the COM command to stop the port from resetting because it is interpreting incoming bits as a break command.

Altering the serial communication settings of the COM2 and COM3 ports may adversely affect Bluetooth wireless technology and/or cellular radio link functionality.

**Table 16: COM Serial Port Identifiers**

Binary <sup>a</sup>	ASCII	Description
1	COM1	COM port 1
2	COM2	COM port 2 (SMART-MR15 cellular radio link)
3	COM3	COM port 3 (available over <i>Bluetooth</i> wireless technology)
6	THISPORT	Current COM port
16	AUX	AUX port

- a. This table lists the commonly used SMART-MR10/15 COM ports. For a complete list of COM ports, refer to the COM Serial Port Identifiers table in the COM command section of the *OEMV Family Firmware Reference Manual*.

**Table 17: Parity**

Binary	ASCII	Description
0	N	No parity (default)
1	E	Even parity
2	O	Odd parity

**Table 18: Handshaking**

Binary	ASCII	Description
0	N	No handshaking (default)
1	XON	XON/XOFF software handshaking
2	CTS	CTS/RTS hardware handshaking

Field	Field Type	ASCII Value	Binary Value	Description	Binary Format	Binary Bytes	Binary Offset
1	COM header	-	-	This field contains the command name or the message header depending on whether the command is abbreviated ASCII, ASCII or binary, respectively.	-	H	0
2	port	See <i>Table 16, COM Serial Port Identifiers on Page 94</i>		Port to configure. (default = THISPORT)	Enum	4	H
3	bps/ baud	300, 600, 900, 1200, 2400, 4800, 9600, 19200, 38400, 57600, 115200, or 230400		Communication baud rate (bps). Bauds of 460800 and 921600 are also available on COM1 of OEMV-2-based products.	ULong	4	H+4
4	parity	See <i>Table 17, Parity on Page 94</i>		Parity	Enum	4	H+8
5	databits	7 or 8		Number of data bits (default = 8)	ULong	4	H+12
6	stopbits	1 or 2		Number of stop bits (default = 1)	ULong	4	H+16
7	handshake	See <i>Table 18, Handshaking on Page 94</i>		Handshaking	Enum	4	H+20
8	echo	OFF	0	No echo (default)	Enum	4	H+24
		ON	1	Transmit any input characters as they are received			
9	break	OFF	0	Disable break detection	Enum	4	H+28
		ON	1	Enable break detection (default)			

## B.6 FRESET Clear Selected Data from NVM and Reset

This command is extended to include SMART-MR10/15 features. An additional target field, *userdata* (value = 10), resets only the SMART-MR10 (or SMART-MR15) user data NVM, thereby resetting all parameters indicated in this document as “Stored in NVM” to factory defaults. Issuing the FRESET command with the “target” field set to *standard*, resets the userdata NVM as well as OEMV parameters as indicated in the *OEMV Family Firmware Reference Manual*.



If you issue the FRESET command without any parameters, it is the same as issuing a FRESET STANDARD command.

Field	Field Type	ASCII Value	Binary Value	Description	Binary Format	Binary Bytes	Binary Offset
1	FRESET header	-	-	This field contains the command name or the message header depending on whether the command is abbreviated ASCII, ASCII or binary, respectively.	-	H	0
2	target	See Table 19		Data to be reset by the receiver	Enum	4	H

**Table 19: FRESET Target**

Binary	ASCII	Description
0	STANDARD	Resets commands, ephemeris, and almanac (default). Also resets all L-band related data except for subscription information.
1	COMMAND	Resets the stored commands (saved configuration)
2	GPSALMANAC	Resets the stored GPS almanac
3	GPSEPHEM	Resets the stored GPS ephemeris
4	GLOEPHEM	Resets the stored GLONASS ephemeris
5	MODEL	Resets the currently selected model
10	USERDATA	Reset SMART-MR10-only commands
11	CLKCALIBRATION	Resets the parameters entered using the CLOCKCALIBRATE command
20	SBASALMANAC	Resets the stored SBAS almanac
21	LAST_POSITION	Resets the position using the last stored position
31	GLOALMANAC	Resets the stored GLONASS almanac



## B.7 LOG Request Logs from the Receiver

Many different types of data can be logged using several different methods of triggering the log events. Every log element can be directed to any combination of available ports. Refer to *Appendix A.2, SMART-MR10 Specifications* on page 75 and *Appendix A.3, SMART-MR15 Specifications* on page 79 for information about ports available on the SMART-MR10/15 respectively. The *ONTIME* trigger option requires the addition of the *period* parameter. See the *OEMV Family Firmware Reference Manual* for further information and a complete list of data log structures. The *LOG* command tables in this section show the ASCII command format.

The optional parameter [hold] prevents a log from being removed when the *UNLOGALL* command, with its defaults, is issued. To remove a log which was invoked using the [hold] parameter requires the specific use of the *UNLOG* command. To remove all logs that have the [hold] parameter, use the *UNLOGALL* command with the *held* field set to 1.

The [port] parameter is optional. If [port] is not specified, [port] is defaulted to the port that the command was received on.



1. The OEMV family of receivers can handle 30 logs at a time. If you attempt to log more than 30 logs at a time, the receiver responds with an Insufficient Resources error. Each COM port already has *RXSTATUSEVENT* log associated with it. This means that with 3 serial ports, 7 logs are already accounted for, as shown below:
  - *RXSTATUSEVENT* on COM1, COM2, and COM3
  - *TRACKSTAT*, *BESTVEL*, and *PSRXYZ* on XCOM1See the example on the next page.
2. Maximum flexibility for logging data is provided to the user by these logs. The user is cautioned, however, to recognize that each log requested requires additional CPU time and memory buffer space. Too many logs may result in lost data and degraded CPU performance. Receiver overload can be monitored using the idle-time field and buffer overload bits of the Receiver Status in any log header.
3. Polled log types do not allow fractional offsets or *ONTIME* rates faster than 1Hz.
4. Use the *ONNEW* trigger with the *MARKTIME*, *MARK2TIME*, *MARKPOS* or *MARK2POS* logs.
5. Only the *MARKPOS*, *MARK2POS*, *MARKTIME* or *MARK2TIME* logs, and 'polled' log types are generated 'on the fly' at the exact time of the mark. Synchronous and asynchronous logs output the most recently available data.
6. If you do use the *ONTIME* trigger with asynchronous logs, the time stamp in the log does not necessarily represent the time the data was generated, but rather the time when the log is being transmitted.

---

**Abbreviated ASCII Syntax:****Message ID: 1**

LOG [port] message [trigger [period [offset [hold]]]]

**Factory Default:**

```
log com1 rxstatuseventa onnew 0 0 hold
log com2 rxstatuseventa onnew 0 0 hold
log com3 rxstatuseventa onnew 0 0 hold
log aux rxstatuseventa onnew 0 0 hold
log usb1 rxstatuseventa onnew 0 0 hold
log usb2 rxstatuseventa onnew 0 0 hold
log usb3 rxstatuseventa onnew 0 0 hold
```

**Abbreviated ASCII Example 1:**

```
log com1 bestpos ontime 7 0.5 hold
```

The above example shows *BESTPOS* logging to COM port 1 at 7 second intervals and offset by 0.5 seconds (output at 0.5, 7.5, 14.5 seconds and so on). The [hold] parameter is set so that logging is not disrupted by the *UNLOGALL* command.

To send a log only one time, the trigger option can be ignored.

**Abbreviated ASCII Example 2:**

```
log com1 bestpos once 0.000000 0.000000 nohold
```

Refer to the *Command Formats* section of the *OEMV Family Firmware Reference Manual* for additional examples.



1. In Connect there are two ways to initiate data logging to the receiver's serial ports. You can either enter the LOG command in the *Console* window, or use the interface provided in the *Logging Control* window. Ensure the Power Settings on your PC are not set to go into Hibernate or Standby modes. Data is lost if one of these modes occurs during a logging session.
2. Only the ASCII/Abbreviated ASCII log table is included in this manual. Please refer to the *LOG* command in the *OEMV Family Firmware Reference Manual* for binary log details.

---

## B.8 NTRIPCASTER Set NTRIP caster

This command sets the NTRIP caster that will provide corrections to the receiver (SMART-MR15 only).

**Abbreviated ASCII Syntax:**

**Message ID: 8230**

ntripcaster <address> <port>

Field	Data	Description	Binary Bytes	Binary Format	Binary Offset
1	NTRIP CASTER header	This field contains the command name or the message header depending on whether the command is abbreviated ASCII, ASCII or binary, respectively.	-	-	0
2	address	IP address or domain name of caster [mandatory]	32	Char	H
3	port	Caster port (default 2101)	4	Ulong	H+32

**ASCII Example:**

```
ntripcaster www.igs-ip.net 80
```

## B.9 NTRIPCLIENT Mount or unmount NTRIP client

This command configures the NTRIP client to receive (or stop receiving) corrections from the caster (SMART-MR15 only). This command also initiates or terminates the transmission of GPGGA messages to the caster.



The caster must have been previously set using the *NTRIPCASTER* command.

**Abbreviated ASCII Syntax:**

**Message ID: 8231**

ntripclient <switch> <mountpoint> <user> <password> <corr\_type> <nmea\_period> <auth\_type>

Field	Data	Description	Binary Bytes	Binary Format	Binary Offset
1	NTRIP CLIENT header	This field contains the command name or the message header depending on whether the command is abbreviated ASCII, ASCII or binary, respectively.	-	-	0
2	switch	Mount switch: - MOUNT to enable NTRIP corrections - UNMOUNT to disable NTRIP corrections [mandatory]	8	Char	H
3	mountpoint	Caster mount point (case-sensitive)	100	Char	H+8
4	user	Username (case-sensitive)	32	Char	H+108
5	password	Password (case-sensitive)	32	Char	H+140
6	corr_type	Type of corrections to expect from caster: - RTCM - RTCA (default) - CMR - RTCMV3 - FKP - OMNISTAR	4	Enum	H+172
7	nmea_period	Period for transmitting NMEA position logs (GPGGA) to caster. If the period is 0 (default), GPGGA logs are not sent to caster.  Note: This information would be sent to support network RTK positioning systems.	4	Float	H+176
9	auth_type	HTTP authentication type - BASIC  Note: Currently, "BASIC" is the only authentication method supported.	8	Char	H+180



The parameters `mountpoint`, `user`, `password`, `corr_type`, `nmea_period` and `auth_type` are all ignored if `switch` is set to `UNMOUNT`.

### ASCII Examples:

#### Request NTRIP corrections from caster without transmitting nmea location to the caster:

```
ntripclient mount example_mount_point ntrip secret
```

#### Request NTRIP corrections from caster and transmit GPGGA position messages to the caster every 10 seconds:

```
ntripclient mount example_mount_point ntrip secret rtcmv3 10
```

#### Stop receiving NTRIP corrections:

```
ntripclient unmount
```

## B.10 PDPFILTER Enable, disable or reset the PDP filter

This command enables, disables or resets the Pseudorange/Delta-Phase (PDP) filter. The main advantages of the Pseudorange/Delta-Phase (PDP) implementation are:

- Smooths a jumpy position
- Bridges outages in satellite coverage (the solution is degraded from normal but there is at least a reasonable solution without gaps)



- Enable the PDP filter to output the PDP solution in BESTPOS, BESTVEL and NMEA logs.
- Refer to the *Operation* chapter of the OEMV Installation and Operation Manual for a section on configuring your receiver for PDP or GLIDE operation.

### GL1DE Position Filter

GLIDE is a mode of the PDP<sup>1</sup> filter which optimizes the position for consistency over time rather than absolute accuracy. GLIDE uses the GPS L1 and does not use GLONASS. This is ideally in clear sky conditions where the user needs a tight, smooth, and consistent output. The GLIDE filter functions autonomously, and with CDGPS or WAAS. The PDP filter is smoother than a least squares fit but is still noisy in places. The GLIDE filter produces a very smooth solution with consistent rather than absolute position accuracy. There should be less than 1 cm difference typically from epoch to epoch. GLIDE also works in single point, DGPS and OmniSTAR VBS modes. See also the PDPMODE command on *page 103*.

**Abbreviated ASCII Syntax:**

**Message ID: 424**

PDPFILTER switch

Field	Field Type	ASCII Value	Binary Value	Description	Binary Format	Binary Bytes	Binary Offset
1	PDPFILTER header	-	-	This field contains the command name or the message header depending on whether the command is abbreviated ASCII, ASCII or binary, respectively.	-	H	0
2	switch	DISABLE	0	Enable/disable/reset the PDP filter. A reset clears the filter memory so that the pdp filter can start over.	Enum	4	H
		ENABLE	1				
		RESET	2				

**Factory Default:**

```
pdpfilter disable
```

**ASCII Example:**

```
pdpfilter enable
```

1. Refer also to our application note on *Pseudorange/Delta-Phase (PDP) and GL1DEE Filters (APN-038)*, available on our website at <http://www.novatel.com/support/knowledge-and-learning/published-papers-and-documents/application-notes/>.

## B.11 PDPMODE Select the PDP mode and dynamics

This command allows you to select the mode and dynamics of the PDP filter.



1. You must issue a *PDPFILTER enable* command before the PDPMODE command. See *PDPFILTER Enable, disable or reset the PDP filter starting on page 102*.
2. If you choose RELATIVE mode (GLIDE) while in WAAS or CDGPS mode:
  - With an L1-only receiver model, you must force the iono type to GRID in the *SETIONOTYPE* command.
  - With an L1/L2 receiver model, you must force the iono type to AUTO in the *SETIONOTYPE* command.

### Abbreviated ASCII Syntax:

Message ID: 970

```
pdpmode mode dynamics
```

Field	Field Type	ASCII Value	Binary Value	Description	Binary Format	Binary Bytes	Binary Offset
1	PDPMODE header	-	-	This field contains the command name or the message header depending on whether the command is abbreviated ASCII, ASCII or binary, respectively.	-	H	0
2	mode	NORMAL	0	In relative mode, GLIDE, performance is optimized to obtain a consistent error in latitude and longitude over time periods of 15 minutes or less rather than to obtain the smallest absolute position error. See also <i>GLIDE Position Filter on Page 102</i> .	Enum	4	H
		RELATIVE	1				
3	dynamics	AUTO	0	Auto detect dynamics mode	Enum	4	H+4
		STATIC	1	Static mode			
		DYNAMIC	2	Dynamic mode			

### Factory Default:

```
pdpmode normal auto
```

### ASCII Example:

```
pdpmode relative
```

## B.12 RADARCFG Configure the ER output

Use this command to configure the Emulated Radar (ER) output. ER is available through the SMART-MR10/MR15 multi-cable, see *page 84* for pin-out details.

### Syntax

Message ID = 8192

```
radarcfg switch freq_step update_rate resp_mode threshold
```

Field	Data	Description	Bytes	Format	Units	Offset
1	Header	This field contains the command name or the message header depending on whether the command is abbreviated ASCII, ASCII or binary, respectively.		-	-	0
2	switch	Enable or disable radar emulation 0 = ENABLE 1 = DISABLE (default = enable)	4	Enum	none	H
3	freq_step	Frequency step per kilometre per hour. Range: 26.11, 28.12 or 36.11 (default = 36.11)	8	Double	Hz/ kph	H+4
4	update_rate	Specify how often to update radar output Range: 1, 2, 5, 10, 20 (default = 10) <sup>a</sup>	4	Integer	Hz	H+12
5	resp_mode	Specify the time, response mode, over which to average velocity samples, see <i>Table 20</i> . (Default = 500) <sup>a</sup>	4	Integer	none	H+16
6	threshold	The threshold is only applicable when the response mode is set to 2. The response time is 1000 ms when the velocity is greater than this value, otherwise, it is 500 ms. Range: 2-50 kph (default = 5 kph)	8	Double	kph	H+20

- a. The number of samples used for smoothing depends on both the `update_rate` and `resp_mode` parameters. For instance, if the `update_rate` is 5 Hz and the `resp_mode` is 2000ms, the number of samples used will be 10.



---

**Table 20: Response Modes**

Mode	Description	
2000	2000 ms	The time period over which to smooth velocity samples
1000	1000 ms	
500	500 ms (default)	
2	Automatically switches between 1000 and 500 ms	
1	Performs no smoothing	

**Example 1 to disable radar emulation:**

```
radarcfg disable 26.11 1 1 2
```

**Example 2 to set the frequency step to 36.11 Hz/kph,  
update rate to 1 Hz and no smoothing:**

```
radarcfg enable 36.11 1 1 2
```

## B.13 RESET Performs a hardware reset

This command performs a hardware reset. Following a RESET command, the receiver initiates a cold-start boot up. Therefore, the receiver configuration reverts either to the factory default, if no user configuration was saved, or the last *SAVECONFIG* settings.

The optional delay field is used to set the number of seconds the receiver is to wait before resetting.

### Abbreviated ASCII Syntax:

Message ID: 18

```
reset [delay]
```



The RESET command can be used to erase any unsaved changes to the receiver configuration.

Field	Field Type	ASCII Value	Binary Value	Description	Binary Format	Binary Bytes	Binary Offset
1	RESET header	-	-	This field contains the command name or the message header depending on whether the command is abbreviated ASCII, ASCII or binary, respectively.	-	H	0
2	delay			Seconds to wait before resetting. (default = 0)	Ulong	4	H

### Example

```
reset 120
```

---

## B.14 SBASCONTROL Set SBAS test mode and PRN

This command allows you to dictate how the receiver handles Satellite Based Augmentation System (SBAS) corrections.

To enable the SBAS position solution corrections, you must issue the SBASCONTROL ENABLE command. The GNSS receiver does not attempt to track any SBAS satellites until you use the SBASCONTROL command to tell it to use either WAAS, EGNOS, or MSAS corrections.

When the system parameter is set to AUTO mode, if the receiver is outside the defined satellite system's corrections grid, it reverts to ANY mode and chooses a system based on other criteria.

Once tracking satellites from one system in ANY or AUTO mode, it does not track satellites from other systems. This is because systems such as WAAS, EGNOS and MSAS do not share broadcast information and send corrections relevant to their specific geographic region.

The "testmode" parameter in the example is to allow SBAS operation while SBAS systems are in test mode. At the time of printing, the testmode parameter of NONE is recommended for all SBAS systems.

When you use the SBASCONTROL command to direct the GNSS receiver to use a specific SBAS system, the GNSS receiver begins to search for and track the relevant SBAS PRNs for that correction type only.

You can force the GNSS receiver to track a specific PRN using the *ASSIGN* command. You can force the GNSS receiver to use the corrections from a specific SBAS PRN using the SBASCONTROL command.

Disable stops the corrections from being used.

### Abbreviated ASCII Syntax:

**Message ID: 652**

```
sbascontrol keyword [system] [prn] [testmode]
```

---

**Factory Default:**

```
sbascontrol disable auto 0 none
```

**Abbreviated ASCII Example 1:**

```
sbascontrol enable waas 0 zerototwo
```



NovAtel's OEMV receivers work with SBAS systems including EGNOS (Europe), MSAS (Japan) and WAAS (North America).

**System Types**

ASCII	Binary	Description
NONE	0	Don't use any SBAS satellites
AUTO	1	Automatically determine satellite system to use (default)
ANY	2	Use any and all SBAS satellites found
WAAS	3	Use only WAAS satellites
EGNOS	4	Use only EGNOS satellites
MSAS	5	Use only MSAS satellites

## B.15 SETCANNAME Sets the CAN name fields

This commands sets the CAN device name fields.

**Abbreviated ASCII Syntax:**

setcanname

**Message ID: 1091**

Field	Field Type	ASCII Value	Binary Value	Description	Binary Format	Binary Bytes	Binary Offset
1	SETCANNAME header	-	-	This field contains the command name or the message header depending on whether the command is abbreviated ASCII, ASCII or binary, respectively.	-	H	0
2	ManufacturerCode			CAN module's Manufacturer Code	ULong	4	H
3	IndustryGroup			Industry group number (default = 2)	ULong	4	H+4
4	DeviceClass			11783-5 Device class (default = 0)	ULong	4	H+8
5	DeviceClassInstance			11783-5 Device class instance (default = 0)	ULong	4	H+12
6	Function			11783-5 Function (default = 23)	ULong	4	H16
7	FunctionInstance			11783-5 Function instance (default = 0)	ULong	4	H+20
8	ECUInstance			11783-5 ECU Instance (default = 0)	ULong	4	H+24
9	PreferredAddress			Device default address on start up (default=28)	ULong	4	H+28
10	Reserved				ULong	4	H+32

The SMART-MR10/15 firmware generate NMEA logs, position logs as well as the logs in *Table 21*, in addition to those of the OEMV Family log set. Refer to the *OEMV Family Firmware Reference Manual*, which also contains procedures and explanations related to data logging and is available from our website at:

[www.novatel.com/support/firmware-software-and-manuals/product-manuals-and-doc-updates/](http://www.novatel.com/support/firmware-software-and-manuals/product-manuals-and-doc-updates/)



SMART-MR10 and SMART-MR15 are capable of logging at 1 Hz, 5 Hz, 10 Hz, and 20 Hz. NovAtel recommends logging at the lowest data rate suitable for your application. Should your application require 20 Hz data rates, please contact NovAtel customer support for guidance.

**Table 21: Commonly Used SMART-MR10/-MR15 Logs in Alphabetical Order**

Message ID	ASCII Log	Description
8214	CELLINFO <sup>a</sup>	Radio information, including modem type
8213	CELLSOCKETSTATUS <sup>a</sup>	Display radio call status information
8209	CELLSTATUS <sup>a</sup>	Display radio status information
8232	NTRIPSOURCETABLE <sup>ab</sup>	Display source table records from current caster
8233	NTRIPSTATUS <sup>a</sup>	Display status of NTRIP connection
8193	RADARSIGNAL	Radar signal and position information
37	VERSION	Hardware versions, software versions, and serial numbers

a. SMART-MR15 only.

b. SMART-MR15 GSM/GPRS/HSDPA version only.

## C.1 NMEA Logs

The NMEA logs (receiver outputs) supported by the SMART-MR10/15 are summarized in Chapter 3 of the *OEMV Family Firmware Reference Manual* in section "NMEA Standard Logs". The available logs include:

- GPGGA, which outputs a log of position system fix data and undulation. There are variants of GPGGA, specifically:
  - GPGGARTK, which has greater precision than GPGGA but with the loss of the undulation field
  - GPGGALONG, which has both greater precision and the undulation field

- GPVTG, which outputs track made good and ground speed

Each of the available NMEA standard logs is described in more detail in its own section of Chapter 3 of the *OEMV Family Firmware Reference Manual*.

The steps for configuring the receiver output, through the command line are:

1. Configure the communication port using the COM command, described in *Appendix B.5, COM Configure COM Port* on page 93. Configure the AUX port as follows:

Bit Rate	9600
Parity	none
Data Bits	8
Stop Bits	1
Handshaking	None
Echo	Off
Break	On

enter the following string:

```
com aux 9600 n 8 1 n off on
```

2. Select and configure the NMEA string that you want to output. The information is described in Chapter 3 Data Logs of the *OEMV Family Firmware Reference Manual*, in the section for the particular log. For example, to log gpgga (position system fix data and undulation) at 2 Hz, enter the following string:

```
log gpgga ontime 0.5
```

You can configure the log to output at various frequencies, as described in *Appendix B.7, LOG Request Logs from the Receiver* on page 97.

The above command line operations can also be carried out through the Connect. Information about configuring the communication port can be found in the Connect online help in Contents > Getting Started > Connecting to the receiver. Information about logging data can be found in Getting Started > Logging Data. The procedure for adding a NMEA log through the Connect is summarized as follows:

1. In the **Logging control** window, click *Logging to one or more of the receiver's serial ports*. The **Add Log** window displays.
2. Beside **Select list**, select *Complete List* or *NMEA List*.
3. Beside **Log to file**, select the NMEA log you want to add.
4. Select the port.
5. Configure the remaining fields then click *Add*.

---

## C.2 NovAtel Position Logs

In addition to NMEA logs, NovAtel supports a range of non-NMEA position logs, described in the *OEMV Family Firmware Reference Manual*, including:

- **BESTPOS:** This log contains the best available position (GPS and GLONASS if available), computed by the receiver, for example:  
log bestposa ontime 0.5
- **BESTXYZ:** This log contains the receiver's best available position and velocity in ECEF coordinates, for example:  
log bestxyza ontime 1



## C.3 CELLINFO Cellular Modem and Network Information

This log displays general information about the cellular modem and network settings.

**Message ID:** 8214

**Log Type:** Polled

**Recommended Input:**

log cellinfoa once

Field #	Field Type	Data Description	Format	Binary Bytes	Binary Offset
1	CELLINFO header	Log header		H	0
2	make	Modem make	Char	20	H
3	manufacturer	Modem manufacturer	Char	20	H+20
4	serial	For GSM/GPRS/HSDPA, International Mobile Equipment Identifier (IMEI). For CDMA, Mobile Equipment Identifier (MEID)	Char	20	H+40
5	version	Modem SW version	Char	20	H+60
6	mdn	Mobile Director Number (MDN), the modem phone number.	Char	20	H+80
7	msid	For GSM/GPRS/HSDPA, Mobile Subscriber Identifier (MSID)	Char	20	H+100
8	apn	For GSM/GPRS/HSDPA, Access Point Name (APN)	Char	36	H+120
9	user name	For GSM/GPRS/HSDPA, APN user name	Char	36	H+156
10	password	For GSM/GPRS/HSDPA, APN password	Char	36	H+192
11	reserved	Reserved	Char	20	H+228

**ASCII Example:**

```
#CELLINFOA,AUX,0,50.5,FINESTEERING,1625,430661.552,00000000,  
ba12,6371;"UC864-G","Telit","356265020679881","08.01.127","+0000000000","",  
"internet.com","","","*917eb090
```



If necessary, the cellinfo fields may be truncated with a ~ symbol appearing in place of any content beyond the maximum size.

## C.4 CELLSOCKETSTATUS Modem Call Status Information

This log displays the current status of connected and disconnected sockets. The statistics for the previous call are maintained in the DISCONNECTED state until a new call is made using this socket. Only one active socket is currently supported.

**Message ID:** 8213

**Log Type:** Asynch

**Recommended Input:**

log cellsocketstatusa onchanged

Field #	Field Type	Data Description	Format	Binary Bytes	Binary Offset
1	CELLSOCKET STATUS header	Log header		H	0
2	socket count	Number of active sockets	Uint	4	H
3	socket id	Socket identifier	Uint	4	H+4
4	status	CLOSED / OPEN / CONNECTING / DISCONNECTING / CONNECTED / LISTENING	Char	20	H+8
5	ip address/port	IP address and port of remote end (for example, "some-caster:80")	Char	32	H+28
6	rx bytes	Total number of bytes received	Uint	4	H+60
7	tx bytes	Total number of bytes transmitted	Uint	4	H+64
8	up time	Total connection time (seconds)	Uint	4	H+68
9-39	Fields 3-8 repeated per active socket.				

**ASCII Example:**

```
#CELLSOCKETSTATUSA,AUX,0,44.5,FINESTEERING,1652,254238.759,0000000  
0,c369,6981;1,1,"CONNECTED","hera.novatel.ca:2101",8582,181,21,2,"CLOSED",  
0,0,0,3,"CLOSED",0,0,0,4,"CLOSED",0,0,0,5,"CLOSED",0,0,0,6,"CLOSED",  
0,0,0*5a6029e7
```

## C.5 CELLSTATUS Cellular Modem and Network Status Information

This log displays the current status of the cellular modem and the network connection.

**Message ID:** 8209  
**Log Type:** Asynch

**Recommended Input:**

log cellstatusa onchanged

Field #	Field Type	Data Description	Format	Binary Bytes	Binary Offset
1	CELLSTATUS header	Log header		H	0
2	status	Current modem status	Char	16	H
3	net status	Registration status of the modem on the network.	Char	16	H+16
4	ip address	Network-assigned IP address (for example, 10.0.0.1)	Char	16	H+32
5	signal	Signal strength as number of bars (1-4)	Uint	4	H+48
6	rsi	RSSI (dBm)	Int	4	H+52
7	network	Network identification string or NID (example "Verizon", "125")	Char	20	H+56
8	cellid	Base station cell identifier	Uint	4	H+76
9	Reserved				
10	disconnects	Number of socket disconnects since startup	Uint	4	H+96
11	temperature	Modem temperature, if available, otherwise 0	Int	4	H+100
12	last error <sup>a</sup>	Last recorded modem error	Char	40	H+104

- a. The last error field is cleared when the cellular modem:
- enters the ENABLED state,
  - enters the PROVISIONING state or
  - changes from the BOOTING state to the CONFIGURING state.
- The last error message persists until one of these state changes occurs.

For CME error explanations, refer to:

CDMA [www.telit.com/en/products/cdma.php?p\\_ac=show&p=16](http://www.telit.com/en/products/cdma.php?p_ac=show&p=16) (Telit CC864 DUAL AT Reference Guide rev. 4) or

HSPA [www.telit.com/en/products/umts-hsdpa.php?p\\_ac=show&p=13](http://www.telit.com/en/products/umts-hsdpa.php?p_ac=show&p=13) (Telit UC864 AT Reference Guide rev. 8)

---

**ASCII Example:**

```
#CELLSTATUSA,AUX,0,45.0,FINESTEER-  
ING,1652,254341.980,00000000,c87c,6981;"ENABLED","HOME","75.254.88.54",4,-  
74,"12/3",8823,"",3,0,""*ffa4c4a5
```

## C.6 NTRIPSOURCETABLE Source Table Records from Current Caster

This log provides information about the NTRIP sources available from the caster. Each record from the caster's sourcetable appears in a separate NTRIPSOURCETABLE log. The log containing the last record of the sourcetable will contain "ENDSOURCETABLE".



This log is only supported by the GSM/GPRS/HSDPA version of the SMART-MR15.



Issuing the *NTRIPCASTER* command while this log is requested causes the NTRIP client to establish a connection to the caster and request the source table. Issuing the *NTRIPCLIENT MOUNT* command while the source table is being downloaded interrupts the output of the NTRIPSOURCETABLE log while NTRIP corrections are being streamed to the receiver. After a subsequent *NTRIPCLIENT UNMOUNT* command, the output of the NTRIPSOURCETABLE logs resumes.

**Message ID:** 8232  
**Log Type:** Asynch

### Recommended Input:

```
log ntripsourcetablea onnew
```

Field #	Name	Description	Format	Binary Bytes	Binary Offset
1	NTRIPSOURCETABLE header	Log header		H	0
2	record	A record from the caster's sourcetable. If the record transmitted by the caster is longer than 256 bytes, it will be truncated.	Char	256	H
3	sequence	Record sequence number	Uint	4	H+256

### ASCII Example:

#### NTRIPSOURCETABLE logs containing 143 sourcetable records from www.igs-ip.net:

```
#NTRIPSOURCETABLEA,AUX,0,47.0,FINESTEER-  
ING,1625,427566.855,00000000,2dad,6371;  
"STR;WSRT0;Westerbork;RTCM 3.0;1004(1),1006(10),1008(10);2;GPS;IGS;NLD;  
52.91;6.60;0;0;AOA SNR-12 ACT;none;B;N;1300;NRCan",93*293d7ff0
```

## C.7 NTRIPSTATUS Status of NTRIP Connection

This log provides information about the NTRIP client.

**Message ID:** 8233

**Log Type:** Asynch

**Recommended Input:**

log ntripstatusa onchanged

Field	Name	Description	Type	Binary Bytes
1	Header	Log header	H	
2	Mode	NTRIP operation mode	Char	8
3	Status	Operating status	Char	24
4	Caster Address	IP address or domain name of caster	Char	32
5	Caster Port	Caster port	UNIT	4
6	Mountpoint	Caster Mountpoint	Char	32
7	Correction Type	Type of correction expected from caster	Enum	4
8	NMEA Period	Period for transmitting GPGGA logs to caster	Float	4
9	Rx Bytes	Bytes received from caster	UNIT	4
10	Tx Bytes	Bytes sent to caster	UNIT	4
11	Up Time	Connection duration	UNIT	4
12	Info	Extra information about current status	Char	32



If necessary, the mountpoint and info fields may be truncated with a ~ symbol appearing in place of any content beyond the maximum size.

**ASCII Example:**

**NTRIPSTATUS logs while connecting to a caster:**

```
#NTRIPSTATUSA,AUX,0,45.5,FINESTEERING,1652,254702.229,00000000,a9c3,69  
81,"Client","STREAMING","hera.nova-  
tel.ca",2101,"novatel_rtcmv3",RTCMV3,0.00,0,0,0,""*5f915546
```

## C.8 RADARSIGNAL ER Signal and Position Information

This log contains position and Emulated Radar (ER) signal information.

**Message ID:** 8193

**Log Type:** Asynch

**Recommended Input:**

log radarsignala unchanged

Field #	Field type	Data Description	Format	Binary Bytes	Binary Offset
1	RADAR-SIGNAL header	Log header		H	0
2	sol status	Solution status, see <i>Table 23, Solution Status on Page 121</i>	Enum	4	H
3	vel type	Velocity type, see <i>Table 22, Position or Velocity Type on Page 120</i>	Enum	4	H+4
4	speed	Speed over ground (m/s)	Double	8	H+8
4	varf freq	External VARF output frequency (Hz)	Double	8	H+16
5	radar freq	Radar signal frequency (Hz) as output by the Emulated Radar Out signal. See <i>SMART-MR10/15 Evaluation Cable starting on Page 83</i> .	Double	8	H+24
6	xxxx	32-bit CRC (ASCII and Binary only)	Hex	4	H+32
7	[CR][LF]	Sentence terminator (ASCII only)	-	-	-

**ASCII Example 1 (stationary SMART-MR10):**

```
#RADARSIGNALA,AUX,0,56.5,FINESTEERING,1625.430959.616,00000000,dc8e,6371;  
SOL_COMPUTED,DOPPLER_VELOCITY,0.0177,0.00,0.00*a08c8d41
```

**ASCII Example 2 (moving SMART-MR10):**

```
#RADARSIGNALA,COM1,0,34.5,FINESTEERING,1556,345809.700,00000000,3dbe  
,4903;SOL_COMPUTED,WAAS,3.0104,4527.491387,282.968212*6a90388e
```

**Table 22: Position or Velocity Type**

Type (binary)	Type (ASCII)	Description
0	NONE	No solution
1	FIXEDPOS	Position has been fixed by the <i>FIX POSITION</i> command
2	FIXEDHEIGHT	Position has been fixed by the <i>FIX HEIGHT/AUTO</i> command
8	DOPPLER_VELOCITY	Velocity computed using instantaneous Doppler
16	SINGLE	Single point position
17	PSRDIFF	Pseudorange differential solution
18	WAAS	Solution calculated using corrections from an SBAS
19	PROPAGATED	Propagated by a Kalman filter without new observations
32	L1_FLOAT	Floating L1 ambiguity solution
33	IONOFREE_FLOAT	Floating ionospheric-free ambiguity solution
34	NARROW_FLOAT	Floating narrow-lane ambiguity solution
48	L1_INT	Integer L1 ambiguity solution
49	WIDE_INT	Integer wide-lane ambiguity solution
50	NARROW_INT	Integer narrow-lane ambiguity solution



**Table 23: Solution Status**

Solution Status		Description
(Binary)	(ASCII)	
0	SOL_COMPUTED	Solution computed
1	INSUFFICIENT_OBS	Insufficient observations
2	NO_CONVERGENCE	No convergence
3	SINGULARITY	Singularity at parameters matrix
4	COV_TRACE	Covariance trace exceeds maximum (trace > 1000 m)
5	TEST_DIST	Test distance exceeded (maximum of 3 rejections if distance > 10 km)
6	COLD_START	Not yet converged from cold start
7	V_H_LIMIT	Height or velocity limits exceeded (in accordance with export licensing restrictions)
8	VARIANCE	Variance exceeds limits
9	RESIDUALS	Residuals are too large
10	DELTA_POS	Delta position is too large
11	NEGATIVE_VAR	Negative variance
12	Reserved	
13	INTEGRITY_WARNING	Large residuals make position unreliable
14-17	Reserved for SPAN-capable receivers	
18	PENDING	When a <i>FIX POSITION</i> command is entered, the receiver computes its own position and determines if the fixed position is valid <sup>a</sup>
19	INVALID_FIX	The fixed position, entered using the <i>FIX POSITION</i> command, is not valid
20	UNAUTHORIZED	Position type is unauthorized - HP or XP on a receiver not authorized for it

- a. PENDING implies there are not enough satellites being tracked to verify if the *FIX POSITION* entered into the receiver is valid. The receiver needs to be tracking two or more GPS satellites to perform this check. Under normal conditions you should only see PENDING for a few seconds on power up before the GNSS receiver has locked onto its first few satellites. If your antenna is obstructed (or not plugged in) and you have entered a *FIX POSITION* command, then you may see PENDING indefinitely.

## C.9 VERSION HW & SW Versions and Serial Numbers

The Component Type of the VERSION log, described in the *OEMV Family Firmware Reference Manual*, is extended to include SMART-MR10/15 information, as shown in *Table 24*.

**Table 24: Component Type**

Binary Value <sup>a</sup>	ASCII Value	Description
0	UNKNOWN	Unknown component
1	GPSCARD	OEMV GPSCard component
3	ENCLOSURE	SMART-MR10 /15 receiver
8	USERINFO	User-application information component
981073925 (0x3A7A0005)	DB_USERAPPAUTO	Auto-starting user-application firmware

a. Unused numbers are reserved for future use.

### ASCII Example (SMART-MR15):

```
[COM1]<VERSION COM1 0 72.0 COARSESTEERING 1618 322692.103 00480000 3681 6371
< 3
< GPSCARD "L12RVA" "DAB10400051" "OEMV3G-5.01-X2T" "3.804A1"
"3.000" "2010/DEC/ 1" "11:02:24"
< DB_USERAPPAUTO "SmartAg" "0" "" "1.300" "" "2011/JAN/06"
"16:31:14"
< USERINFO "LMX9830" "0212" "SMART-MR15" "1.000" "" "" ""
```

In the above example, the firmware is shown as 3.804A1 and the SMART-MR15 application is shown as 1.300.

Field #	Field type	Data Description	Format	Binary Bytes	Binary Offset
1	VERSION header	Log header		H	0
2	# comp	Number of components (cards, and so on)	Long	4	H
3	type	Component type (see <i>Table 24, Component Type on Page 122</i> )	Enum	4	H+4
4	model	A base model name plus designators where there are 4 possible base names: L12: 20 Hz positions and measurements, RT2/20 base, 14 GPS L1/L2 and 2 SBAS channels L1: 20 Hz positions and measurements, RT20 base, 14 GPS L1 and 2 SBAS channels N12: 20 Hz positions, no measurements, 14 GPS L1/L2 and 2 SBAS channels N1: 20 Hz positions, no measurements, 14 GPS L1 and 2 SBAS channels The model designators are shown in <i>Table 25, Model Designators on Page 124</i> .	Char[16]	16	H+8
5	psn	Product serial number	Char[16]	16	H+24
6	hw version	Hardware version, see <i>Table 26, VERSION Log: Field Formats on Page 125</i>	Char[16]	16	H+40
7	sw version	Firmware software version, see <i>Table 26 on Page 125</i>	Char[16]	16	H+56
8	boot version	Boot code version, see <i>Table 26 on Page 125</i>	Char[16]	16	H+72
9	comp date	Firmware compile date, see <i>Table 26 on Page 125</i>	Char[12]	12	H+88
10	comp time	Firmware compile time, see <i>Table 26 on Page 125</i>	Char[12]	12	H+100
11...	Next component offset = H + 4 + (#comp x 108)				
variable	xxxx	32-bit CRC (ASCII and Binary only)	Hex	4	H+4+ (#comp x 108)
variable	[CR][LF]	Sentence terminator (ASCII only)	-	-	-

**Table 25: Model Designators**

Designator	Description
G	12 L1 or 12 L1/L2 GLONASS channels, frequencies to match GPS configuration
R	Receive RT2 and/or RT20 corrections
I	Synchronized Position Attitude Navigation (SPAN)
J	SPAN supporting 200 Hz IMUs and IGI higher rate IMU (256.144 Hz)
S	Reduces positions and measurement rates to 5 Hz, disables VARF and EVENT signals
A	Application Program Interface (API)
B	1 L-band channel with CDGPS and OmniSTAR VBS capability
L	1 L-band channel with CDGPS and OmniSTAR HP/XP capability
NL	1 L-band channel with OmniSTAR enabled and no position, velocity, time (PVT) or raw data output
F	50 Hz output
Z	<b>ALIGN:</b> This heading feature generates separation and bearing data between a base and one or multiple rovers.
K	Receiver RT2 <b>L1TE:</b> The L1 GG RTK feature is a fixed integer GPS+GLONASS L1-only RTK solution that works with RTCAOBS and RTCAOBS2 correction types. Centimetre-level (RT2 <b>L1TE</b> ) accuracy is possible with fix times in the order of 60 s, depending on visibility, number of satellites, and so on. Since it is an L1-only solution, the operational baseline is limited to 3 km to minimize ionospheric errors. Outside of the baseline threshold (3 km), the receiver outputs RT20 instead.

**Table 26: VERSION Log: Field Formats**

Field Type	Field Format (ASCII)	Description
hw version	P-RS-CCC	P = hardware platform (for example, OEMV) R = hardware revision (for example, 3.00) S = processor revision (for example, A) <sup>a</sup> CCC = COM port configuration (for example, 22T) <sup>b</sup>
sw version, boot version	VV.RRR[Xxxx]	VV = major revision number RRR = minor revision number X = Special (S), Beta (B), Internal Development (D, A) xxx = number
comp date	YYYY/MM/DD	YYYY = year MM = month DD = day (1 - 31)
comp time	HH:MM:SS	HH = hour MM = minutes SS = seconds

- a. This field may be empty if the revision is not stamped onto the processor.
- b. One character for each of the COM ports 1, 2, and 3. Characters are: 2 for RS-232, 4 for RS-422, T for LV-TTL, and X for user-selectable (valid for COM1 of the OEMV-2 only). Therefore, the example is for a receiver that uses RS-232 for COM 1 and COM 2 and LV-TTL for COM 3.

# Appendix D Replacement Parts

The following replacement parts are available for your NovAtel SMART-MR10 or SMART-MR15 receiver. If need assistance or additional components, contact your local NovAtel dealer or Customer Support representative.

## D.1 SMART-MR10/15

Part Description	NovAtel Part
SMART-MR10	01018518
SMART-MR15 CDMA (Verizon)	01018606
SMART-MR15 GSM/GPRS/HSDPA	01018712

## D.2 Accessories

Part Description	NovAtel Part
OEMV Family Compact Disc with PC utilities including Connect	01018235
OEMV Family Installation and Operation User Manual	OM-20000093
OEMV Family Firmware Reference Manual	OM-20000094
Full connectivity cable [23-pin socket to 3 DB-9 connectors, twisted CAN I/O pair, and other bare wire connectors (see <i>Connector Cables starting on Page 83</i> )]	01018515
Streamlined cable	01018526
Mounting Kit, Quick Release Assembly	01018578
Mounting Kit, Quick Release Plate	01018625
Mounting Kit, AG GPS 262	01018623
Mounting Kit, 5/8 Inch Adapter	01018624
Mounting Plate, Universal	70023085
Mounting Plate, AG GPS 262 Layout	70023086
Mounting Plate, 5/8 Inch Adapter	70023087



The above accessories are also available through the NovAtel website at [www.novatel.com](http://www.novatel.com)

### D.2.1 Cellular Accessories

Part Description	NovAtel Part
CDMA Antenna, 2.2 / 4 dBi, 824-896 MHz / 1850-1990 MHz, NMO (USE with 12023301 Mount)	12023296
CDMA Antenna Mount, NMO Magnetic Base, 30 cm cable (DO NOT USE with 12023303 Antenna)	12023301
GSM/GPRS/HSDPA Antenna, 3 / 4 dBi, 806-960 MHz / 2500-1990 MHz, NMO (DO NOT USE with 12023301 Mount)	12023303
GSM/GPRS/HSDPA Antenna Mount, NMO Magnetic Base, 3.65 m cable (USE with 12023303 Antenna)	12023300
Antenna Ground Plane Kit	01018684

# Index

## A

- accessories, 23
  - SMART-MR15, 23
- accuracy
  - position, 48, 74
  - velocity, 74
- ALIGN, 54
- almanac, 96
- antenna
  - internal, 21
  - specifications, 75, 79
- ascii, 59
- AUTH command, 66
- authorization, 66
- AUX port
  - identifier, 94

## B

- base station, 53
- baud rate, 46
- baud rate, *see* bps
- BESTPOS log, 112
- BESTXYZ log, 112
- bidirectional communication, 47
- bit rate, *see* bps
- Bluetooth, 32–33
  - configuration, 68–73
  - power-down, 69
- bps, 95
- break, 93, 95
- bridge, 102
- BTCONTROL, 90
- buffer, 97

## C

- cable
  - customer interface, 83
  - serial, 46
  - warranty, 16
- cable requirements, 87

- CAN, 41
- CAN. *See* Controller Area Network
- CDMA
  - activation, 45
  - antenna, 42
- CDU software, 98, 126
- CELLACTIVATE command, 91
- CELLINFO log, 113
- CELLSET command, 92
- CELLSOCKETSTATUS log, 114, 117
- CELLSTATUS log, 115
- Cellular
  - activation, 43
  - antenna activation, 41
- CMR, 52
- cold start, 74
- COM command, 93
- COM port, 98
- command
  - communication, 46
  - interface, 52
  - multiple, 53
  - port, 46
  - pre-configure, 50
  - RTK, 53
- commands
  - in CDU, 62
- communication
  - bidirectional, 47
  - Bluetooth, 68
  - CDU, 69
  - getting started, 47
  - notice, 9
  - operation, 46
  - PC/laptop, 47
  - port, 40, 46
  - remote terminal, 47
- COMVOUT command, 93
- conductor size, 87
- configuration
  - additional equipment, 26
  - base station, 50
  - Bluetooth, 68–73

- port, 46, 93
- receiver, 106
- reset, 106
- rover station, 51
- RTK, 52
- typical hardware, 46
- Connect, 57
- connector
  - input/output, 75, 79
  - mounting bracket, 36
  - specifications, 75, 79
- Controller Area Network, 41
- Controller Area Network. See CAN
- Convert4 software, 59
- copyright, 2
- CPU
  - requirements, 97
- customer interface cable, 83
- customer support, 62
- D**
- data
  - Bluetooth, 68
  - collect, 37
  - erase, 96
  - format, 89
  - L-band, 96
  - link, 49
  - log, 97–98
  - NVM, 96
  - port, 40, 46
  - start, 48
  - storage device, 49
  - terminal, 47
- DC power, 75, 79
- dealer, 62
- default
  - Bluetooth, 69, 71
  - factory, 96, 106
  - interface mode, 52
  - log, 98
  - port, 46, 97–98
  - reset, 96
- differential
  - configuration note, 52
  - corrections, 48, 83, 85
  - serial cable, 83, 85
- directional communication, 47
- distance exceeded, 121
- dynamics, 103
- E**
- echo, 95
- EGNOS, 54
- EGNOS (European SBAS), 108
- e-mail, 19
- Emulated Radar (ER), 40, 104, 119
  - operation, 55
- enable Bluetooth, 68
- F**
- factory default
  - reset, 106
  - setting, 93
- features, 24–25, 47, 62, 66
- filter, 102–103
- firmware updates, 20, 62, 66
- FRESET command, 96
- G**
- gaps, 102
- GLIDE, 54, 103
- GLONASS
  - RINEX files, 60
- GPGGA log, 110
- GPRS
  - antenna, 42
- GPVTG log, 111
- graphical user interface, 58
- GSM
  - activation, 43
  - antenna, 42
- H**
- handshaking, 46, 94–95
- hardware
  - Bluetooth, 70
  - enclosure, 24–25
  - replace, 126
  - required, 26
  - reset, 106
  - setup, 32–33, 49



header, 18  
 height limit, 121  
 hexadecimal, 18  
 hibernate mode, PC, 98  
 hold, 97

## I

idle time, 47  
 input
 

- connector, 75, 79
- differential, 50–51
- power, 36
- syntax, 89

 install, 17  
 installation, 57  
 insulator requirement, 87  
 integration, 17  
 interface
 

- base or rover, 50–51
- Bluetooth, 68
- communication, 47
- graphical, 25
- serial, 46

 introduction, 21

## L

laptop power settings, 98  
 LED
 

- power, 35, 37

 log, 52, 97–98, 110  
 LOG command, 97

## M

MKI strobes, 40  
 MODE pin, 35  
 model upgrades, 20, 62  
 models
 

- SMART-MR10, 24–25
- SMART-MR15, 25

 mounting kits, 26  
 mounting plates, 36  
 MSAS (Japanese SBAS), 108

## N

NMEA logs, 110

note, logging, 97  
 Notices, 8  
 NovAtel Inc., 2  
 NovAtel position logs, 112  
 NTRIP client, 55  
 NTRIPCASTER command, 99  
 NTRIPCLIENT command, 100  
 NTRIPSOURCETABLE log, 117

## O

operation, 46  
 optionality, 18  
 outages, 102  
 output
 

- connector, 75, 79
- convention, 18
- log, 97–98
- status, 48
- syntax, 89

 overload, 97

## P

parity, 46, 94–95  
 PC power settings, 98  
 PDPFILTER command, 102  
 period, 97  
 port
 

- Bluetooth, 71
- COM, 46, 52
- configuration, 93, 95
- identifier, 94
- interface mode, 50–51
- log, 97–98
- settings, 46–47

 position
 

- accuracy, 48
- base, 50
- best, 119
- command, 52

 position logs, 112  
 power, 36  
 power-down, 69  
 PPS strobes, 40  
 pseudorange, 53  
 pseudorange/delta-phase (PDP), 102–103

**R**

RADARSIGNAL log, 118–119  
receiver outputs, 110  
receiver status, 97  
relative pseudorange/delta phase, 103  
replacement parts, 126  
reset

- FRESET command, 96
- hardware, 106
- option, 96
- target, 96

RESET command, 106  
RINEX, 59  
rover station, 52

- configuration, 51

RTCA, 52  
RTCM, 52  
RTCM1819, 50  
RTCMV3, 50, 52

**S**

satellite, 31, 47

- coverage, 102

SBAS

- control, 107
- system type, 108

SBASCONTROL command, 107  
self-test, 48, 97  
serial

- cable, 46
- number, 62
- port, 52

SIM, 44  
sleep

- Bluetooth, 69

SMART-MR10

- box contents, 22
- features, 21
- models, 24–25
- specifications, 75

SMART-MR15

- accessories, 23
- box contents, 22
- features, 22
- models, 25
- specifications, 79

smooth, 102

specifications

- SMART-MR10, 75
- SMART-MR15, 79

standby mode, PC, 98  
static mode, 103  
status, receiver, 97  
strobes, 40  
support, 16, 19  
syntax, 89

**T**

technical specifications, 74  
time, 97  
transmit, 95  
trigger, log, 97–98

**U**

update firmware, 62, 66

**V**

velocity limit, 121  
Verizon, 45  
version, 67

**W**

WAAS (North American SBAS), 108  
WAAS (Wide Area Augmentation System), 53  
Warning

- CE, 10
- FCC, 9
- voltage, 36

warranty, 16

- antenna, 16

Web site, 19  
windows in CDU, 58  
WinLoad, 62  
wire size, 87





## Free Manuals Download Website

<http://myh66.com>

<http://usermanuals.us>

<http://www.somanuals.com>

<http://www.4manuals.cc>

<http://www.manual-lib.com>

<http://www.404manual.com>

<http://www.luxmanual.com>

<http://aubethermostatmanual.com>

Golf course search by state

<http://golfingnear.com>

Email search by domain

<http://emailbydomain.com>

Auto manuals search

<http://auto.somanuals.com>

TV manuals search

<http://tv.somanuals.com>