

NUVŌ®

The Sound of LiVing.

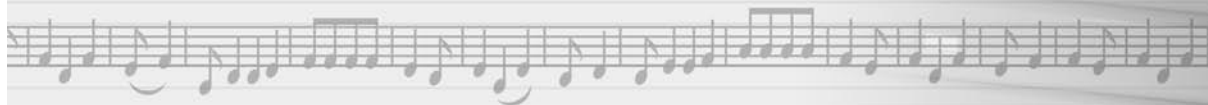

NV T2 DF Installation Manual

Preliminary

NuVo Technologies
4940 Delhi Pike
Cincinnati, Ohio, 45238 USA
www.nuvotechnologies.com

ENGLISH

Danger

Exposure to extremely high noise levels may cause a permanent hearing loss. Individuals vary considerably to noise induced hearing loss but nearly everyone will lose some hearing if exposed to sufficiently intense noise for a sufficient time. The U.S. Government's Occupational Safety and Health Administration (OSHA) has specified the following permissible noise level exposures:

DURATION PER DAY (HOURS)	8	6	4	3	2	1
SOUND LEVEL (dB)	90	93	95	97	100	103

According to OSHA, any exposure in the above permissible limits could result in some hearing loss. Ear plugs or protectors in the ear canal or over the ears must be worn when operating this amplification system in order to prevent a permanent hearing loss. If exposure in excess of the limits as put forth above, to insure against potentially harmful exposure to high sound pressure levels, it is recommended that all persons exposed to equipment capable of inducing high sound pressure levels, such as this amplification system, be protected by hearing protectors while this unit is in operation.

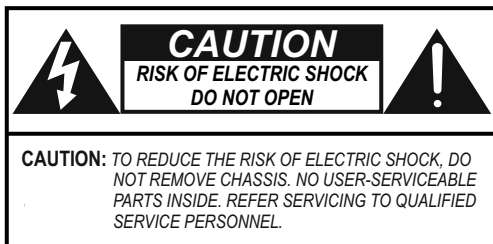

AVIS: RISQUE DE CHOC ELECTRIQUE-NE PAS OUVRIR.



THIS SYMBOL IS INTENDED TO ALERT THE USER TO THE PRESENCE OF NON-INSULATED "DANGEROUS VOLTAGE" WITHIN THE PRODUCT'S ENCLOSURE THAT MAY BE OF SUFFICIENT MAGNITUDE TO CONSTITUTE A RISK OF ELECTRIC SHOCK TO PERSONS.



THIS SYMBOL IS INTENDED TO ALERT THE USER TO THE PRESENCE OF IMPORTANT OPERATING AND MAINTENANCE (SERVICING) INSTRUCTIONS IN THE LITERATURE ACCOMPANYING THE UNIT.



APPARATUS SHALL NOT BE EXPOSED TO DRIPPING OR SPLASHING AND THAT NO OBJECTS FILLED WITH LIQUIDS, SUCH AS VASES, SHALL BE PLACED ON THE APPARATUS.

IMPORTANT SAFETY INSTRUCTIONS

1. Read all safety and operating instructions before using this product.
2. All safety and operating instructions should be kept for future reference.
3. Read and understand all warnings listed on the operating instructions.
4. Follow all operating instructions to operate this product.
5. This product should not be used near water, i.e. Bathtub, sink, swimming pool, wet basement, etc.
6. Only use dry cloth to clean this product.
7. Do not block any ventilation openings, It should not be placed flat against a wall or placed in a built-in enclosure that will impede the flow of cooling air.
8. Do not install this product near any heat sources ;such as,radiators, heat registers, stove or other apparatus (including heat producing amplifiers) that produce heat.
9. Do not defeat the safety purpose of the polarized or grounding-type plug. A polarized plug has two blades with one wider than the Other.A grounding-type plug has two blades and a third grounding prong. The wide blade or the third prong are provided for your safety If the provided plug does not fit into your outlet, consult an electrician for replacement of the obsolete outlet.
10. Protect the power cord being walked on or pinched, particularly at Plugs, convenience receptacles and the point where they exit from the apparatus. Do not break the ground pin of the power supply cord.
11. Only use attachments specified by the manufacturer.
12. Use only with the cart, stand, tripod, bracket, or table specified by the manufacturer or sold with the apparatus. When a cart is used, use caution when moving cart/apparatus combination to avoid injury from tip-over.
13. Unplug this apparatus during lightning storms or when unused for long periods of time.
14. Care should be taken so that objects do not fall and liquids are not spilled into the unit through the ventilation ports or any other openings.
15. Refer all servicing to qualified service personnel. Servicing is required when the apparatus has been damaged in any way; such as, power-supply cord or plug is damaged, liquid has been spilled or objects have fallen into the apparatus, the apparatus has been exposed to rain or moisture, does not operate normally or has been dropped.
16. **WARNING:** To reduce the risk of fire or electric shock, do not expose this apparatus to rain or moisture.

Precautions

For U.S. Models

Note to CATV system installer:

This reminder is provided to call the CATV system installer's attention to Section 820-40 of the NEC, which provides guidelines for proper grounding and, in particular, specifies that the cable ground shall be connected to the grounding systems of the building, as close to the point of cable entry as practical.

FCC Information for the User

Caution:

Changes or modifications by the user that are not expressly approved by the party responsible for compliance could void the user's authority to operate the equipment.

NOTE:

This equipment has been tested and found to comply with the limits for a class B digital device, pursuant to part 15 of the FCC rules. These Limits are designed to provide reasonable protection against harmful interference in a residential installation. This equipment generates, uses and can radiate radio frequency energy and, if not installed and used in accordance with the instructions, may cause harmful interference to radio communications. However, there is no guarantee that interference will occur in a particular Installation. If this equipment does cause harmful interference to radio or television reception, which can be determined by turning the equipment off and on, the user is encouraged to try to correct the interference by one or more of the following measures:

- 1) Reorient or relocate the receiving antenna.
- 2) Increase the separation between the equipment and the receiver.
- 3) Connect the equipment into an outlet on a circuit different from that to which the receiver is connected.
- 4) Consult the dealer or an experienced radio/TV technician for help.

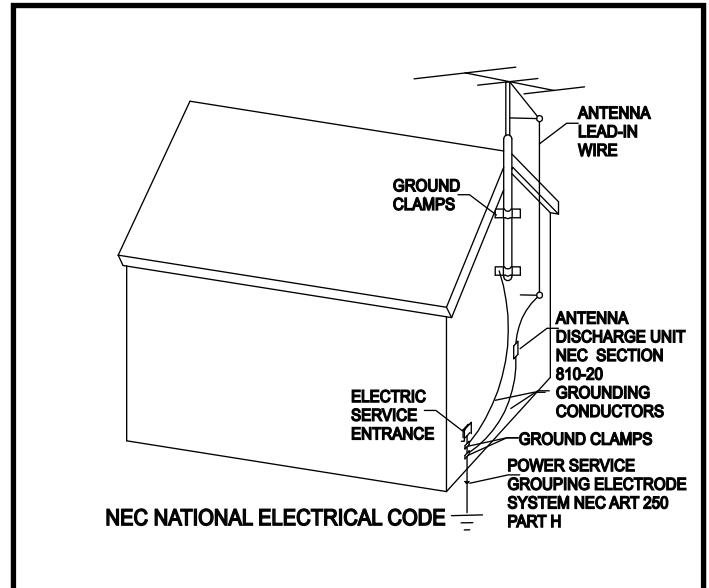

NV-T2DF Wiring Diagram

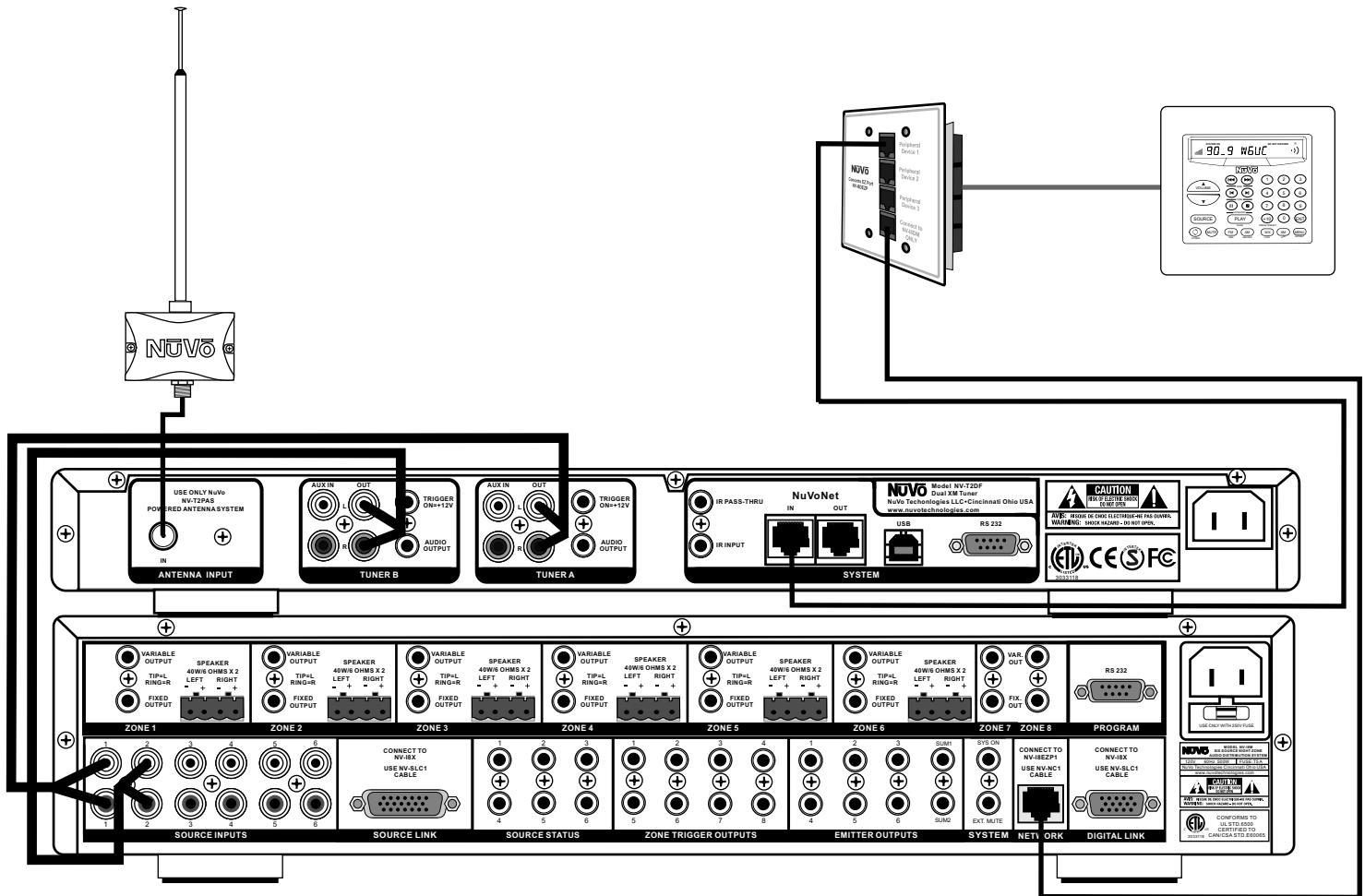
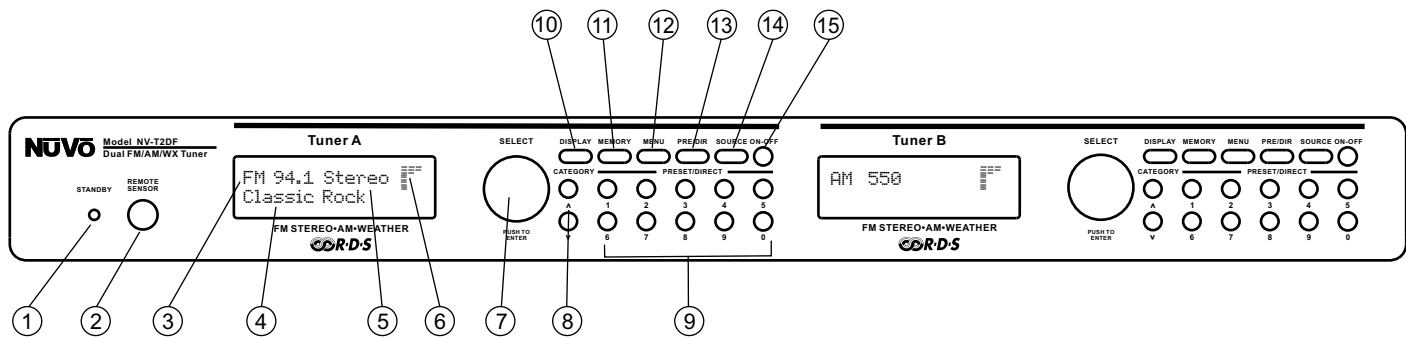
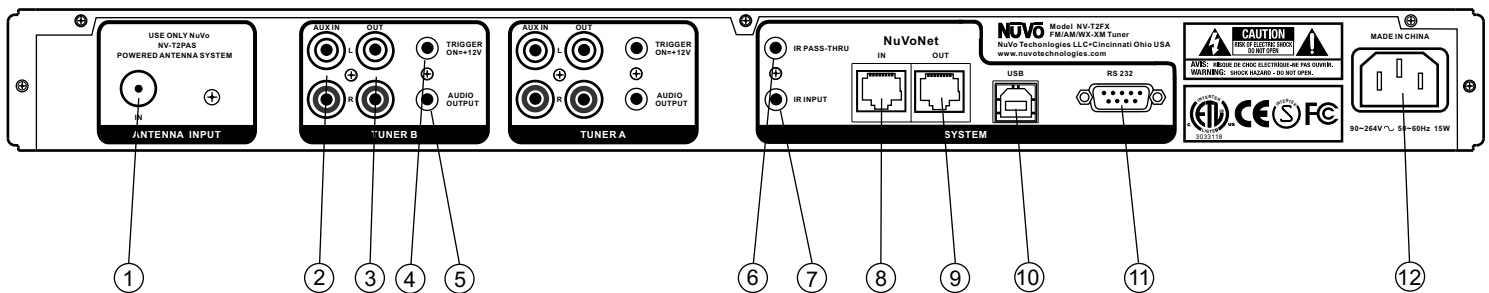

Diagram is shown with the NuVo Concerto System and NuVoNet.



Front Panel

1. Stand-by LED: This LED (Light Emitting Diode) indicates that the T2 is plugged into an AC power source.
2. Remote Sensor: This IR (Infrared) receiver allows wireless remote control of the T2 functions. This IR input is active, even when it is used in conjunction with the direct IR input on the back panel.
3. Frequency and Band Display: The display indicates the band AM, FM, or WX (Weatherband) and station frequency.
4. Preset/ RDS Display: This is a display of customized preset information, or RDS (Radio Data Service) information transmitted with the station's broadcast. NuVoNet allows this to scroll automatically on the Concerto Display Pads (pg. 17).
5. Stereo: This indicates whether the signal reception is stereo. No display indicates mono. The T2 software allows a station preset to be set in mono mode (pg. 21).
6. Signal Strength: This indicates the level of signal being received at the tuned frequency.
7. Select Knob: Turning the knob scrolls through the T2 menu options; pressing the knob selects the displayed menu option. When not in menu mode, the Select knob tunes up and down. Pushing the knob selects the station.
8. Category Up and Down: This function requires the use of the T2 installation software. Categories allow station selection to be set up according to specific listening genres.
9. Numeric Buttons: These buttons are programmable for direct station preset access. Customized alphanumeric strings can be defined in the setup software (pg. 21). They can also be used for direct frequency tuning. These custom strings are displayed on the Display Pads of an integrated Concerto system whenever a preset is accessed.
10. Display Button: This button toggles between RDS information on and off.
11. Memory Button: The memory button provides you with a personal "notepad" to store and recall artist and song information originating from RDS data for future reference.
12. Menu: This button enters and exits the menu mode (pg. 11).
13. Pre/Dir: This toggles between numeric preset selection and direct station input.
14. Source: This button toggles between the available modes, AM, FM, WX (Weather Band), and Aux input if it has been enabled through the advanced menu.
15. On/Off: Turns each individual tuner on and off.



Back Panel

1. Antenna Input: Coax "F" connector brings in the signal input from the NuVo NV-T2PAS antenna (pg. 10).
2. Aux. Input: This stereo RCA connector is enabled through the advanced menu options (pg. 14), and allows an additional audio source to be connected and accessed through the tuner source selection.
3. Audio Output: A Stereo RCA output allows the tuner audio signal to be connected to an amplifier source, such as the NuVo Simplese, Essentia, and Concerto audio distribution systems.
4. Trigger ON: The voltage output provides a constant 12 volts when the Tuner is turned on.
5. Audio Output: This is a second stereo output designed to work with a tip, ring, sleeve 3.5mm stereo connection.
6. IR Pass-Thru: This 3.5mm connection is used to link IR control between two or more components used in the same installation.
7. IR Input: The single IR Input accepts a mono 3.5mm patch cable for receiving IR information from an external IR receiver without the use of an external IR emitter.
8. NuVoNet In: This RJ45 connection is used with one of the Peripheral Device inputs on the Concerto EZ Port (see pg. 17) to enable direct one-to-one communication with the Concerto Display Pads.
9. NuVoNet Out: This RJ45 jack is used to link the NuVoNet communication between multiple NuVo Peripheral Devices such as the T2 Tuners in a single installation.
10. USB: The USB port is used for downloading a configuration from your computer (see pg. 17).
11. RS232: This 9-pin DB9 connection allows serial communication with an external RS232 system. This may also be used for downloading a configuration from your computer.
12. AC Power: This connects the T2 with an AC power source. When plugged into a live AC outlet the blue power LED (Light Emitting Diode) on the T2's front panel will remain lighted. When neither tuner is on, the T2 is in standby mode and draws less than 2 watts of power.

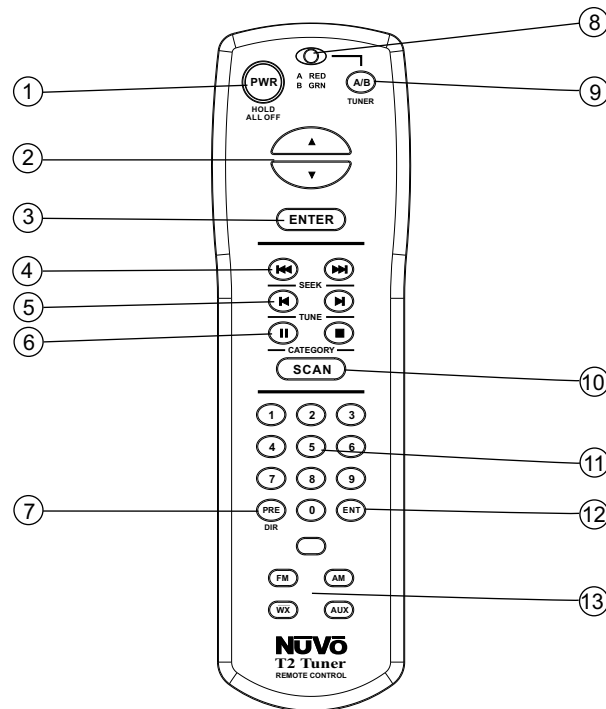

NV-T2RC3 Remote Control

1. Power: The power button turns the selected tuner on and off.
2. Scroll Buttons: These buttons are the equivalent of turning the front panel Select knob. The top button is the equivalent of turning the knob clockwise, and the bottom button is the equivalent of counterclockwise.
3. Enter: This button is the equivalent of pushing the Select knob on the front panel (see Front Panel #7).
4. Seek Up and Down: The seek buttons will tune to the next available station with the required signal strength. The signal threshold can be adjusted higher or lower using the T2 Configurator software (see pg. 22), or through the advanced menu options on the front panel (see pg. 12).
5. Tune Up and Down: The tune function steps through each station frequency regardless of the frequency signal strength.
6. Category Up and Down: The category buttons step through each of the defined genre categories. Categories must be defined in the advanced settings of the T2 Configurator software (see pg. 24).
7. Pre/Dir: The T2 allows up to 10 preset stations in each of up to 10 preset banks. This button scrolls through each of the defined banks and then to direct tuning. In direct tuning, you can use the numeric buttons to access a specific station frequency. Presets are selected by a single push of numeric button 0-9.
8. Tuner A & B LED: This LED glows red when Tuner A is selected and green when Tuner B is selected. This LED glows only momentarily when a button is pushed.
9. Tuner Selector: This button toggles between Tuner A and Tuner B operation.
10. Scan: The scan button tunes up to the next station with a signal strength above the programmed threshold and waits 5 seconds before automatically tuning to the next station. This uses the same signal level as the seek function.
11. Numeric Buttons: These buttons (0-9) are used to access a specific station frequency or choose a pre-defined station preset.
12. Source Buttons: These four buttons select each of the four available audio sources within the T2.

I. Installing the NV-T2DF Dual Tuner

Stereo Audio Connections

Each tuner has two audio output jacks. One is a stereo RCA connection, and the other is a stereo 3.5mm mini. The RCA output is an individual left and right channel connection made with a standard RCA cable. The other end is connected to the corresponding audio input on the back panel of the audio amplifier. An example of this is one of the source inputs on the back panel of a NuVo audio distribution system, fig. 1.

The 3.5mm stereo output labeled "AUDIO OUTPUT" is also available for system connection. Compatible cables are available with the male mini connection on each end, or with a stereo RCA connection on one end, fig. 2.

Fig. 1

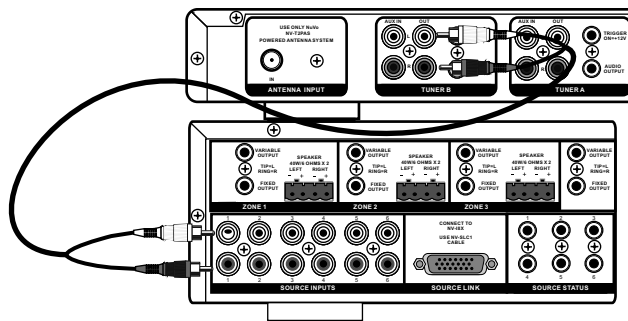
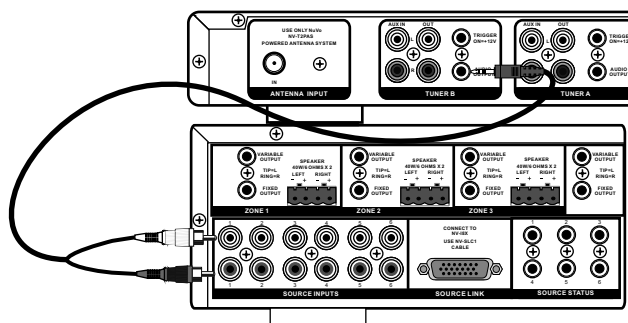

Fig. 2



Direct IR Control

The T2 is designed for IR control via IR received by an audio distribution system. In the NuVo Simplese or Essentia audio distribution systems, the IR emitter outputs act as a repeater to IR signals incident on the system keypads. The T2's wired IR connector is a 3.5mm two-conductor (mono) jack labeled "IR INPUT." Using a mono mini-to-mini patch cable, connect the IR emitter output of a Simplese or Essentia Main Unit to the IR INPUT on the T2. The two tuners in the T2 respond to separate IR codes, so the direct IR input replaces the need for external IR emitters placed over the IR receiver windows on the front of the unit, fig. 3. This connection is not used when using the Concerto NuVoNet system. The NuVo Essentia and Simplese systems are used for example, but the T2 is compatible with any audio system that is capable of repeating IR.

Fig. 3

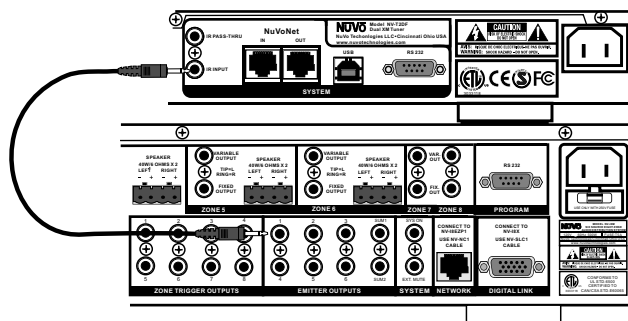

IR Pass-Thru

The mini jack labeled "IR pass-thru" mini connection is used for connecting forwarded IR signals to an audio component connected to the auxiliary audio input.

Using the Aux. Input

The T2 is equipped with an auxiliary audio input labeled "AUX IN." This will accept an audio signal from an external component. This is most useful as an additional local source, or an additional source in a multi-zone audio system.

The auxiliary input is a stereo RCA connection and requires a standard RCA cable for the connection, fig. 4. This must be enabled through the advanced menu, which is accessed through the "Select Knob" on the face of the T2 (see Menu Controls, AUX Input pg. 14) or in the T2 Configurator software (see Using the T2 Configurator Software pg. 22). An additional advanced feature is the ability to set the gain of the auxiliary signal to match the output signal level of the T2.

Once the auxiliary input is enabled, it is selected from the remote using the "AUX" button, fig. 5, or by pressing the "Source" button for either Tuner A or Tuner B on the face of the T2 and stepping through FM, AM, and WX (Weather Band) to Aux., fig. 6.

Fig . 4

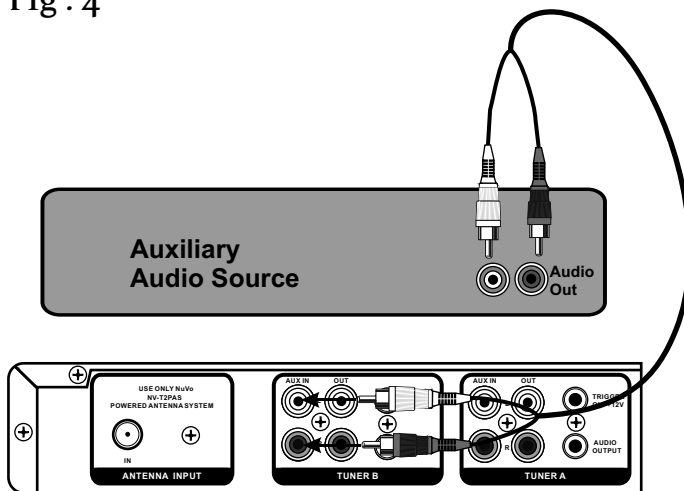

Fig . 5

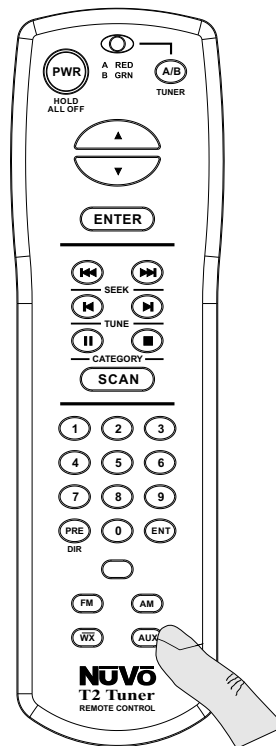
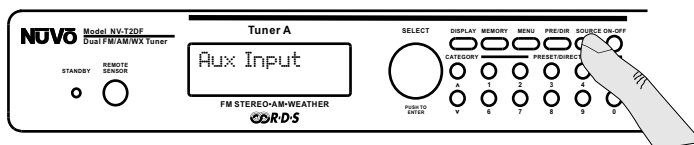

Fig . 6



Antenna Input

The T2 ships with a proprietary amplified AM/FM antenna. This antenna is designed to work only with the NuVo T2 series tuners. It can be located up to 200 feet from the tuner location, and we recommend 75-ohm RG 6 coaxial cable with a standard F style connector on each end. Simply attach the cable to the connector at the bottom of the antenna, and into the "Antenna Input" on the T2, fig. 7. Once connected, the T2 should immediately receive broadcast signals and RDS (Radio Data Service) when it is available.

We recommend placing the antenna inside in an attic or as high as possible for the best possible AM and FM reception, fig. 8. A 2 meter (6 foot) pre-terminated coaxial cable is provided with the tuner package for testing the antenna connection or if you choose to place the antenna close to the tuner location.

Fig . 7

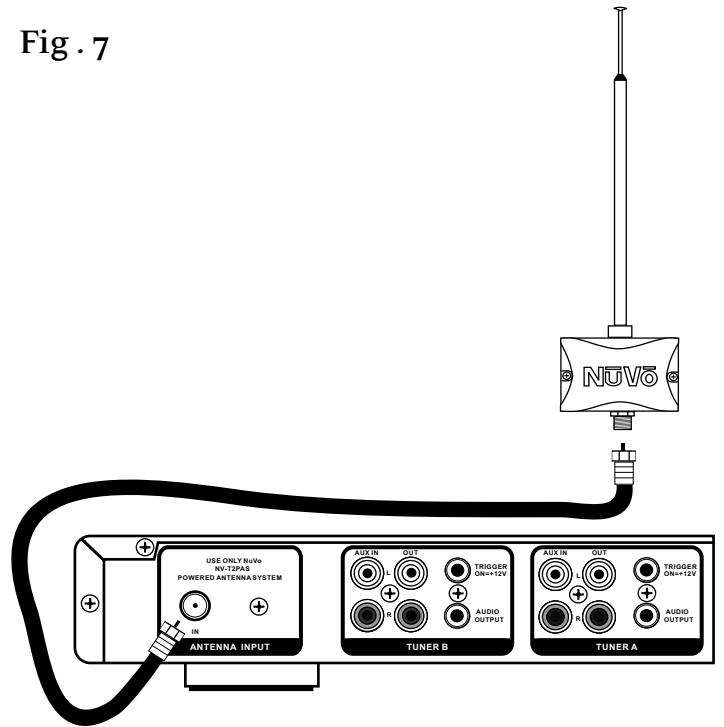

Fig . 8

USB and RS232 Communication

The T2 has two serial communication ports. These allow for complete control of the T2 functions by RS232 control devices. The necessary protocol for RS232 control is available through the NuVo Website Prozone at www.nuvotechnologies.com/prozone.



II. Front Panel Menu Controls

The T2 has many settings available in the menus. This allows for many specialized set up options for basic tuner operation. The menu is accessed from the front panel by pressing and holding the "MENU" button. Once in menu mode, you can scroll through the menu options by turning the "Select" knob clockwise (CW) to move forward and counterclockwise (CCW) to move backward. As the Select knob moves through the menu, the choices appear on that tuner's display. The top line contains the name of the current menu selection. The bottom line shows the menu choices. When the desired menu option appears on the display, pressing the Select knob enters the menu choice. When the desired menu setting is made, pressing the Select knob saves it (see menu option tree, fig.9.) Pressing the MENU button once while you are in the menu options moves you up one level. Pressing and holding the MENU button exits the menu mode.

Exit Menu: When you first enter the menu choices, the first choice is to exit the menu, which takes you back to normal tuner operation.

Force Mono: This is a useful feature when a stereo pair of speakers is not available, or if the signal of a station is weak. Forcing the signal to mono eliminates a weak station from flipping in and out of stereo reception. If RDS display is OFF or if there is no valid RDS data, the display will indicate "MONO."

Brightness: This changes the intensity of each tuner's display. The level choices range from 1- 8. The default level is the brightest level 8, fig 10.

Info:

Version: This tells you what firmware version is currently loaded on the T2.

Test Status: This is for factory diagnostic use only.

Fig. 9: Menu Option Tree

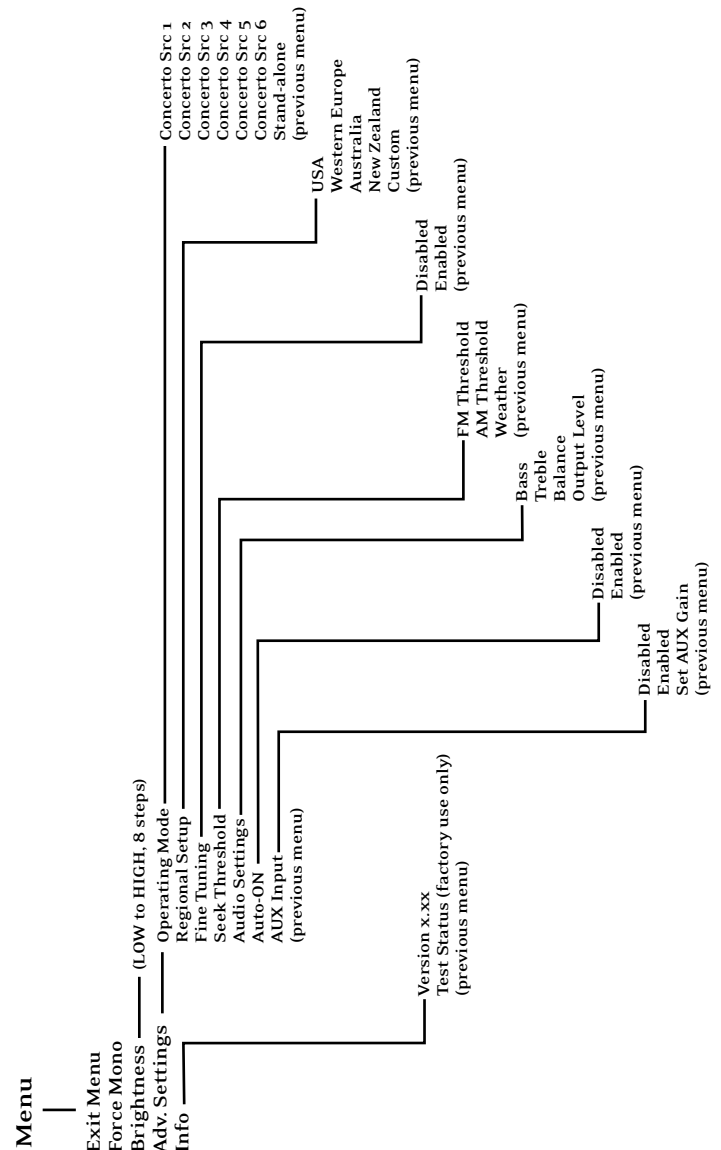
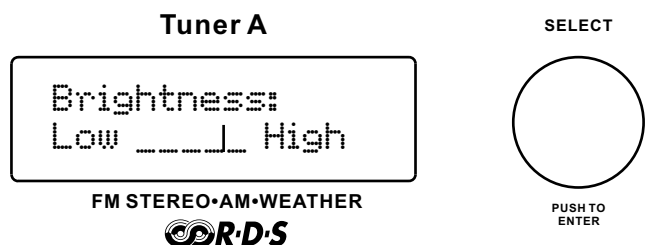

Fig. 10



Advanced Settings

The following menu selections are not necessary for standard tuner operation, but do provide a deeper level of control for those who need it. When you scroll to "Advanced Settings" in the menu, pressing the Select knob then accesses the following menu options:

Operating Mode

Concerto Source 1-6: This must be set for the appropriate NuVo Concerto source input, if the T2 is going to be used with Concerto's NuVoNet control network (see pg. 17 Using the T2 with Concerto and NuVoNet).

Stand-alone: Stand-alone must be set when the T2 is being used with any system other than the NuVo Concerto audio distribution system.

Regional Setup

USA: This setting is optimized for the United States and Canada.

European (Western): This setting is optimized for Western Europe.

Australia: This setting is optimized for all of Australia.

New Zealand: This setting covers all of New Zealand.

These four settings cover most of the worldwide tuning standards. For operation in countries outside of these geographic regions, you may need to use the advanced settings in the T2 Configurator software for customizing the regional tuning standard (see pg. T2 Configuration Software, Advanced Settings).

Fine-Tuning

The fine-tuning feature enables tuning with a smaller frequency step to include more station frequency possibilities, which may be used in areas allowing many low-power broadcast stations.

FM: The standard tuning for North America and Australia is .200 MHz steps, and the standard for Europe and New Zealand is .100 MHz steps. Fine-tuning automatically drops the tuning steps to .05 MHz increments.

AM: The North America standard for AM tuning is in 10 kHz steps and Europe is 9 kHz. AM fine tuning goes in 1 kHz steps.

Seek Threshold

This sets the effective station signal strength for seek and scan tuning. With either of these modes, the tuner will automatically tune up until it receives a good signal. You can set the definition a good signal with the seek threshold feature, fig. 11.

FM, AM, WX (Weather Band): All three available bands are set the same way, but are adjusted individually. Scroll with the Select knob to the desired band and press the knob to select it. Once selected, you can choose between five different levels. High means the station needs to have a very strong signal for the tuner to react. Low causes the tuner to stop at any station with the slightest measurable signal. The default is the middle setting. This is an adjustment of the signal threshold. It sets the minimum signal level necessary for tuning using Seek or Scan.

Fig. 11

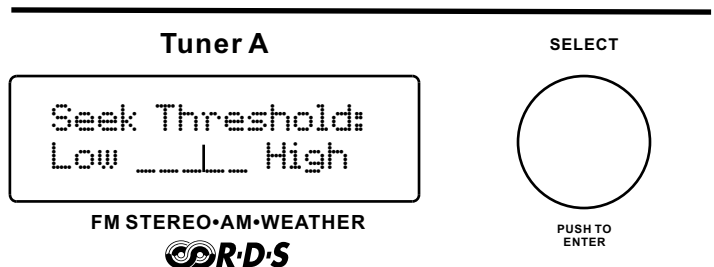

Audio Settings

These selections are intended for some stand-alone applications. They should be left at default settings for NuVo audio systems. These systems allow identical audio control on a per-zone basis.

Bass EQ: Bass output can be adjusted +12 dB or down to -12 dB. The default setting is flat. This feature is useful for stand-alone use with an amplifier that does not have bass EQ control. If you are using the T2 with a NuVo audio distribution system, or another system that allows for EQ control, you should leave the T2 set at 0 dB (flat), fig. 12.

Treble EQ: Treble can be adjusted the same as bass. The level ranges from -12 dB to +12 dB and defaults at 0 dB. As with the bass setting, this should not be used unless there is no external EQ capability, fig. 13.

Balance: Left and Right channel output can be adjusted if desired. As with the EQ adjustments, this feature should not be used when the T2 is used with an audio system that already has EQ and balance adjustment capability, fig. 14.

Output Level: The signal level from the T2 can be adjusted up or down to match the input gain characteristics of other audio equipment in the system. The default setting is 0 dB and the range is -6 dB to +12 dB, fig. 15.

Auto-ON

Enable/Disable: The T2 can be set to turn the tuner displays on automatically when power is applied. This is a good feature for stand-alone use. In the event of a power outage or anytime AC power is lost and restored, the T2 tuners will automatically turn back on with the last-used settings without having to use the ON/OFF button on the front panel.

This selection is not necessary when using the T2 with the NuVo Concerto system, because the built-in power management system between the T2 and Concerto will automatically turn on the tuners when the Power button is pressed on any of the Concerto's Display Pads.

Fig. 12

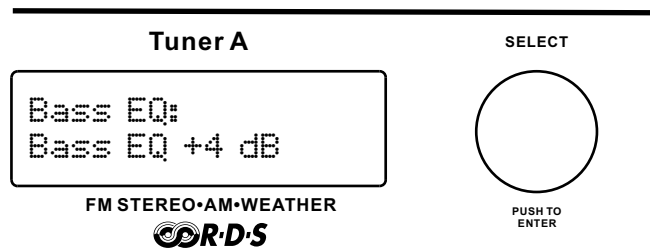

Fig. 13

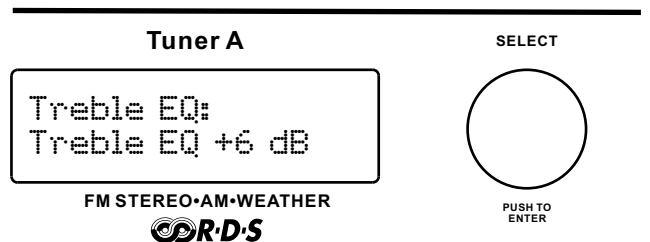

Fig. 14

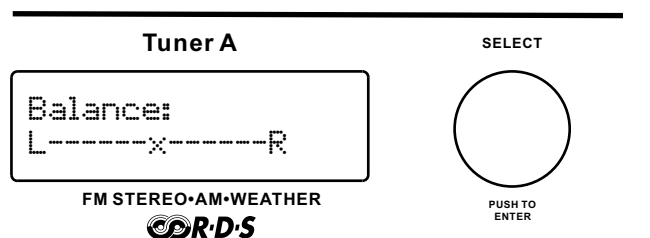
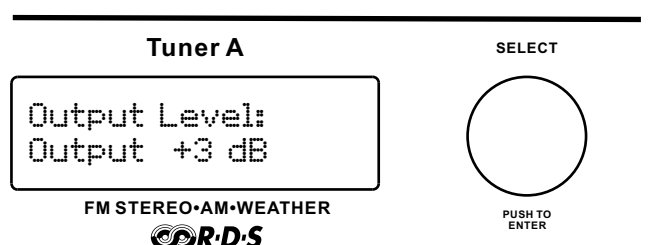

Fig. 15



AUX Input

Disable/Enable: The T2 has an auxiliary audio input that allows access through either of the tuners to an additional audio source. To use this you must first enable the input in the menu options.

AUX Gain: The audio input from an auxiliary source can be adjusted to match the output of the T2's Tuner A and Tuner B. AUX Gain is selected by using the Select knob to scroll to that choice and press to enter. Once AUX Gain is selected, amount of input up and down is then controlled and set by using the Select knob to adjust up or down, and then pressing the knob when the desired gain setting has been reached, fig. 16.

Noise Blanking

Disable/Enable: The T2 default setting is to have noise blanking (partial to complete muting of weak noise signals) Enabled. For areas of T2 operation having a very low interference level, it may be desirable to select this menu item and set Disabled in order to listen to very distant, weak stations.

Fig. 16

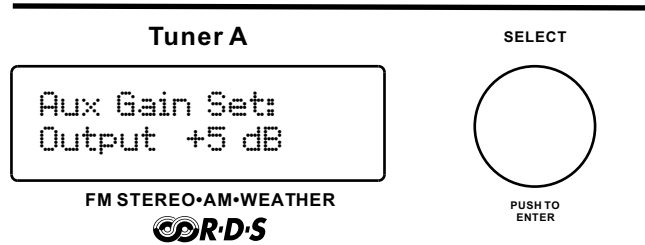

III. Stand-alone Front Panel Use of the T2

Tuning a Desired Station: Pressing the Select knob cycles through the tuning modes.

Step Tune Mode: Each of the T2's tuners default to step tune mode. When the Select knob is turned clockwise (CW), the tuner will tune within the preset tuning standard (see Advanced Menu Settings, Regional Setup, pg. 12), and counter clockwise (CCW) to tune down.

Seek Tune Mode: The seek tunes up when the Select knob is turned CW and down when the Select knob is turned CCW. In seek tune mode, the tuner will automatically stop at the next available station signal. It will stay at that selection until you tune to a new station.

Scan Tune Mode: Scan tune works like Seek Tune, except the tuner will only stay on a station for 5 seconds and then continue to the next signal. To retain a selection, press the Select knob before the tuner resumes scanning for frequencies.

Tuning by Categories: A unique feature is the ability to group station frequencies into specific genre categories. The desired frequencies for each category must be assigned in the T2 Configurator software (see NV-T2DF Configurator software, Assigning Categories). Once you have decided on the categories you want to use and assigned specific station frequencies, you will always have that template for future use. To enter Category tuning, press the "Category up or down keys." This will scroll to the next assigned category with each push. When a category is selected, turning the Select knob will step through all the frequencies within that category, fig. 17.

Direct Numeric Tuning: The T2 allows for direct numeric entry. To get to the Direct mode, press the PRE/DIR button until "DIRECT TUNE" appears on the display. Then pressing the numeric buttons in sequence for the desired frequency and pressing the Select knob will tune to that station.

Fig. 17

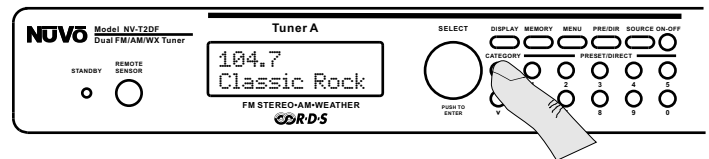

Preset Tuning: The T2 is able to store 10 preset stations in each of up to 10 banks of presets. This allows a total of 100 presets. The factory default is two banks of presets, but more banks can be added or deleted in the T2 Configurator software. Saving a preset is done simply by tuning to a desired station and pressing and holding one of the numeric buttons until the display reads "Preset Saved." Once a preset is saved, banks of presets are accessed by pressing the PRE/DIR button, and then pressing the appropriate number button accesses the desired preset.

Radio Data Service (RDS) Information and Display Modes

The Radio Data Service is a format broadcasters can use to send artist and song information with their broadcast. Although this service is gaining in popularity, all stations do not yet use it. If a station is broadcasting RDS, the T2 will automatically scroll what is being received. The Program Status Name (PSN) data field (up to 8 characters) will appear in the upper right of the display. This was intended by RDS system architects to display a station name, such as a call sign. The Radiotext field (up to 64 characters) will be displayed on the second line and will scroll if it exceeds 16 characters. The Radiotext message will be displayed on Display Pads in an integrated Nuvo Concerto system. Radiotext was intended for display of artist and title information.

Actual use of these data fields is not regulated, and they may vary significantly in content between stations. If you choose not to have RDS information displayed, pressing the "Display" button will then indicate "RDS receive OFF". In this state, Stereo indication and a signal strength indicator will replace the PSN field on the top line, and only the station frequency will be displayed on a connected zone's Display Pad. Pressing the button again will restore RDS and display "RDS receive ON." Each press of the "Display" button toggles between on and off.

Signal Strength/Stereo Indicator

The signal strength indicator responds to the field strength of the received carrier signal, fig. 18. This indicator has seven discrete levels, with a single point at the bottom of the character space indicating a signal just detectable by the tuner, and a very strong signal indicated by four lines of increasing length above 3 dots. Stereo indication is also provided when the tuner is successfully decoding FM Multiplex stereo stations. The field will be blank if stereo reception is not possible due to weak signal conditions or if the station is broadcasting in monaural (mono). The field will display MONO if Force Mono is enabled from the MENU. This indicator and Stereo lock information will be displayed upon tuning to a new station. If RDS Receive is ON (see previous section), then the indicator and Stereo lock information will be displayed momentarily until valid RDS PSN data has been received; then it will be replaced by that data.

Using the Memory Feature

Memory is used to store a specific display for future reference. This is useful for referencing specific RDS information later. It can be used for viewing a song title and artist that you might need to recall at a later date. By pressing the "Memory" button with a single tap, whatever information is scrolling on the display at that time will automatically be saved in the first memory position.

Pressing and holding the Memory button puts the T2 in memory recall mode. Turning the Select knob will scroll up through the saved displays, starting with the most recently saved. The T2 has the ability to save up to 10 displays. When a new display is saved, it will automatically place that information in the first slot, and bump all previously saved displays down one. Display number 10 will automatically drop off the list, fig. 19.

Source Switching

Pushing the "Source" button scrolls between AM, FM, WX (Weather Band), and Auxiliary (Aux.) modes. The auxiliary mode is optional and must be turned on through the T2 Configuration software (see NV-T2DF Configuration software, advanced settings, pg.) or through the advanced settings menu accessed at the front panel (see Front Panel Menu Controls).

Fig. 18

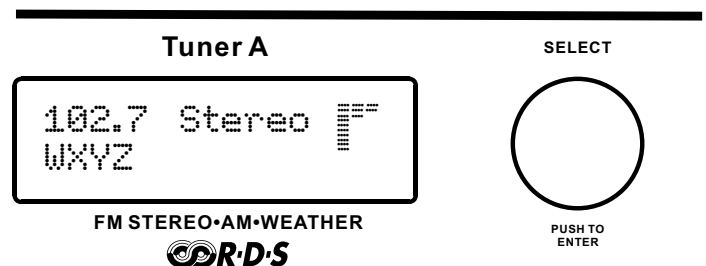
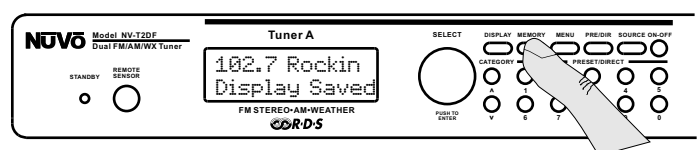

Fig. 19



IV. Using the T2 with the Concerto NuVoNet

Setting Up the Tuner for NuVoNet

The T2 must be set for one of the Concerto source inputs 1-6. This can be done at the front panel when the tuner is first turned on, in the T2 Configurator software, or through the front panel advanced menu. The best way to utilize the T2 with NuVoNet is to set up the T2 options in the included Configurator software, and then download the configuration through the rear-panel USB port, using the supplied USB cable, fig. 20.

Making Sure Your Concerto Is Ready for NuVoNet Use

Your Concerto System must be updated with at least software version 1.40 for proper NuVoNet communication with the T2. To check what Configurator version you currently have, open the Concerto Configurator software on your computer by double-clicking on the Configurator icon on the desktop. You will see a splash screen appear before the software opens. This lists the current software version. If you do not have version 1.40 or later, go to www.nuvotechnologies.com/prozone. There you can log onto the Download page and download the latest version.

When this is done, open the applicable configuration from your configuration files or retrieve the configuration from the Concerto main unit. Once the appropriate configuration is opened, go to the Source tab and place the T2 IR library in the appropriate source locations 1-6. Once you have added the T2 as two of the Concerto sources, you can then download the configuration to the Concerto through the USB port or the RS232 port on the back of the Concerto, fig. 21. When the download is complete, your system is ready for NuVoNet Communication.

Making the Connection

Prior to connecting to NuVoNet, the Concerto must have the correct Configuration version downloaded with the T2 representing two of the audio sources. Making the NuVoNet connection is done simply by connecting the "NuVoNet" output on the T2 to one of the "Peripheral Device" inputs on the Concerto EZ Port, fig., 22. This connection will then enable bi-directional NuVoNet communication with the Display Pads.

Fig. 20

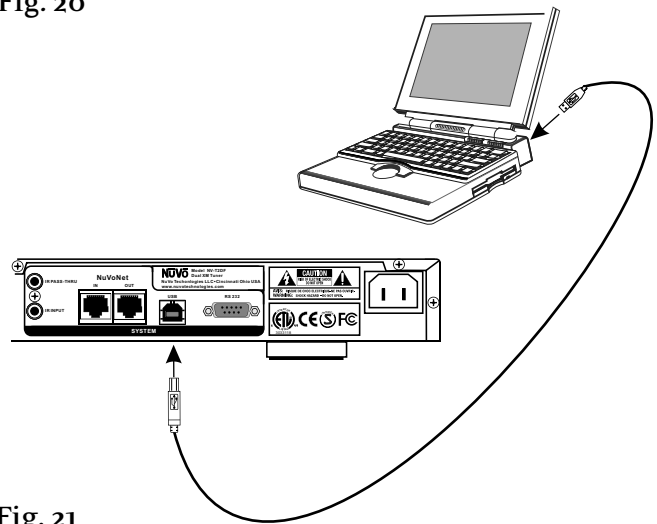

Fig. 21

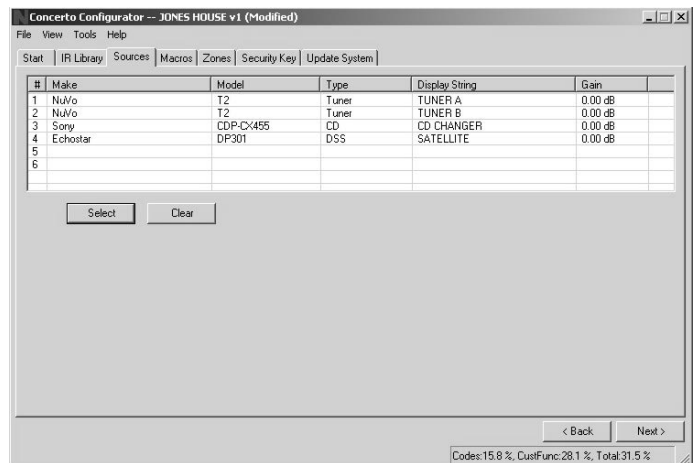
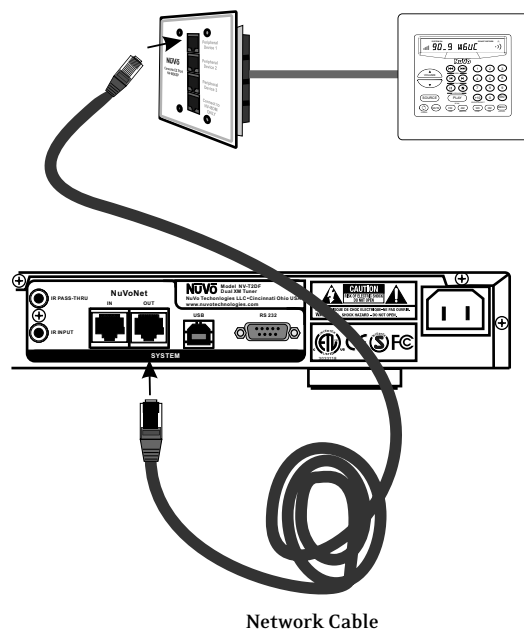

Fig. 22



Operating the T2 with the Concerto Display Pad

By following the previous steps you should now be able to operate the T2 from any of the Concerto Display Pads. The Concerto Display Pads have secondary tuner functions silk-screened on the bezel below the associated keys. They appear under the appropriate function buttons, fig. 23

Step Tune: Basic step tuning is done by pressing the left or right arrows labeled Tune.

Seek Tune: Seek tuning automatically seeks to the next frequency that meets the set signal strength threshold (see T2 Configuration Software, Advanced Settings, Tuning Parameters pg. 22). This is done by pressing the left and right arrows labeled Seek (see fig. 23).

Scan Tune: Scan tuning automatically tunes to the next available station frequency that meets the signal threshold (as described above in the Seek Tune Mode). Scan tune allows the T2 to settle on a frequency for 5 seconds and then automatically go to the next frequency. To select the station, push the "ENT" button before the T2 resumes station scanning. Scan tuning is initiated by pressing the "PLAY" button, also labeled "Scan" (see fig. 23).

Tuning by Categories: The provided genre categories are defined in the T2 Configuration software (see NV-T2DF Configuration Software, Advanced Settings, Categories, pg. 24). You can use the stop and pause buttons, also labeled "Categories," to scroll up or down through the defined categories. Once you have chosen a category, the Seek up and Seek down buttons will automatically tune through any frequency within that category selection. Again, the categories and the frequencies within each category must be first assigned within the T2 Configuration software.

Radio Data Service: The Display Pad will scroll received Radiotext data if the tuned station is broadcasting it and if signal strength is sufficient. When a defined preset is selected, the name of that preset will appear on the display momentarily. If Radiotext RDS data is being broadcast, it will then automatically begin scrolling. This takes a few moments while the information buffers.

Fig. 23

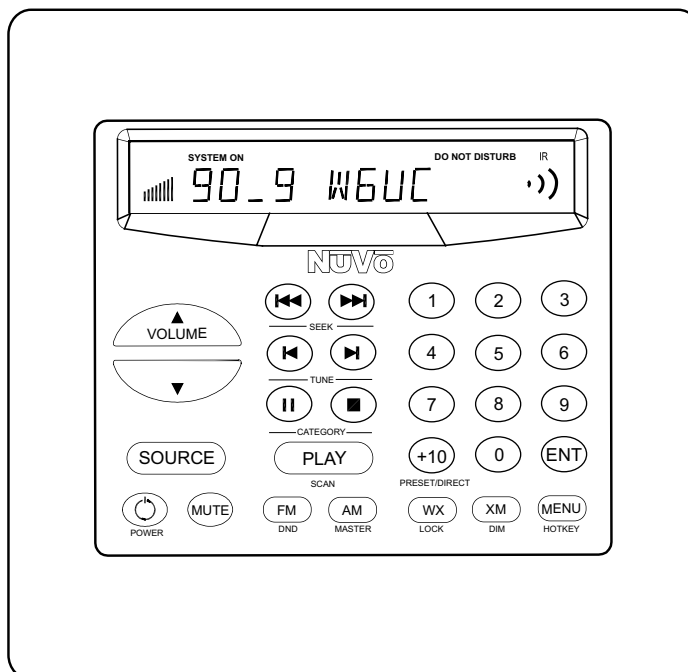

Direct Numeric Entry Tuning: Accessing direct tuning is done by pressing the +10 button (see fig. 23). This toggles between banks of presets (the T2 Configurator software allows for 10 banks each with 10 presets) and direct tune. When Direct Tune appears on the display, a frequency can be numerically entered using the numeric keypad on the Display Pad. When you are entering a frequency number, it is not necessary to enter the decimal, i.e. 102.7. The entered numbers will appear on the display. When the ENT button is pressed, the T2 will tune to that station.

Source Switching (radio band, aux input): The bottom row of buttons on the Concerto Display Pad are assigned FM, AM, WX (Weather Band), and Aux. Changing the T2 source is done simply by pressing one of those four buttons, (see fig. 23).

T2 Configuration Software

Basic setup and operation of the T2 is easily done from the front panel, the included T2RC3 remote, or the Concerto Display Pad. The T2 package includes the T2 Configurator setup software designed to quickly move you through the Tuners' setup options in a methodical fashion, and allow access to the more advanced setup features. Configurations are saved as files in the software's "Config" folder. Once complete, configurations can be used as templates for future installations.

1.0 Start

The start tab allows you to load an existing configuration, or create a new one. You can also retrieve a configuration from the T2 and edit it.

1.0 Start

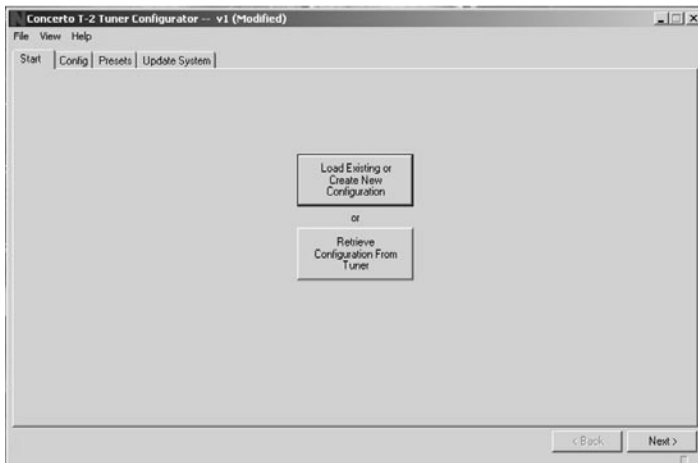

1.1 After you have opened a configuration, the next step is the Config Tab.

1.1 New Config

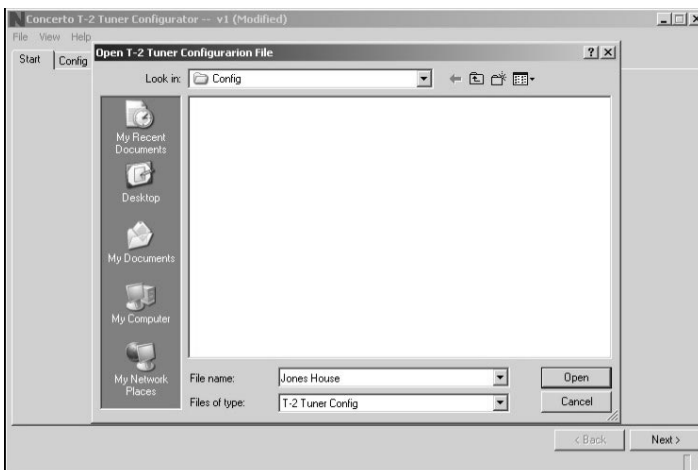

2.0 Config

The Config tab is for the initial setup, which determines basic tuner operation.

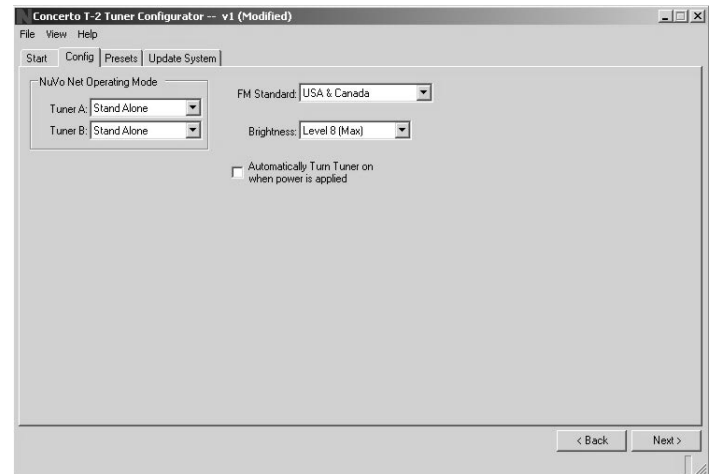

2.1 NuVoNet Operating Mode: This drop down menu allows you to select between "Stand-alone" or as a Concerto source 1- 6. If you are using the T2 as NuVoNet source for Concerto, you must select a unique, dedicated source input for each Tuner (A or B) being configured.

2.1 NuVoNet Operating Mode

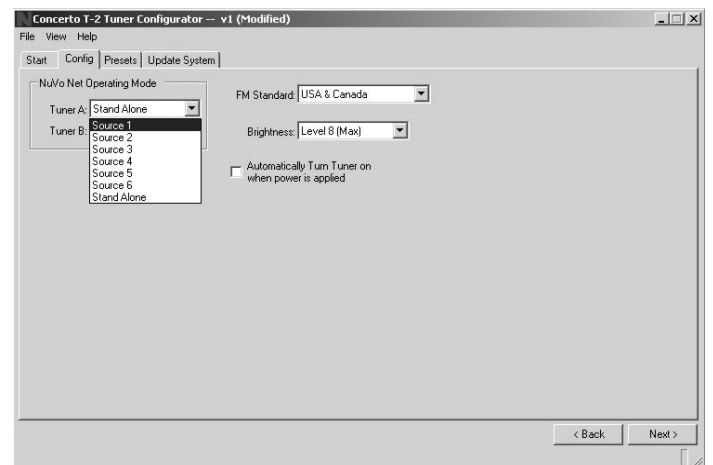

2.2 Regional Setup: Depending on your geographic location, the tuner needs to be set for the proper tuning standard. The choices are USA and Canada, Western Europe, Australia, and New Zealand. Countries outside these geographic locations need the advanced custom setting (see Advanced Settings: 4.1 Custom Regional Setup).

2.2 Regional Setup

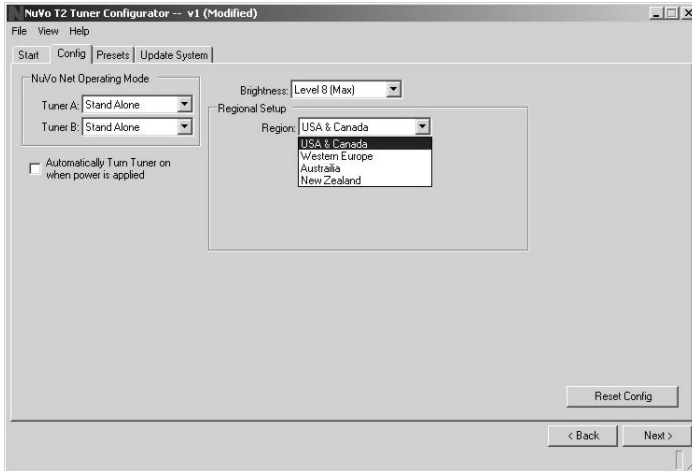

2.3 Brightness: This sets the intensity of the displays for each tuner. The factory default is the maximum level 8.

2.3 Brightness

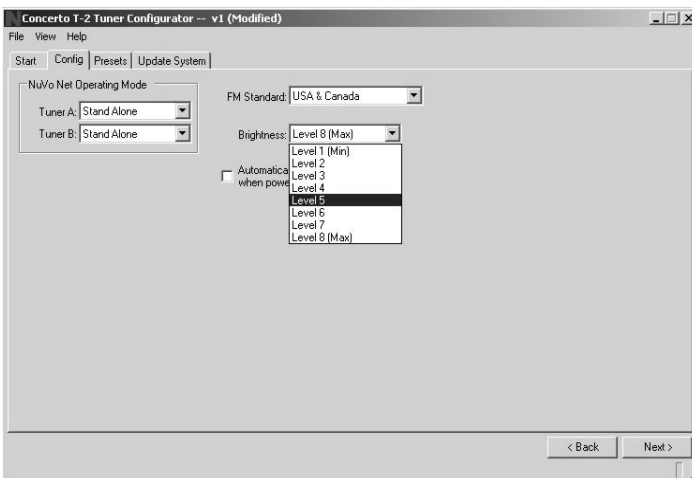

2.4 Auto-On: In the event of loss of power, or if the T2 is unplugged, the tuners can be set with this check box to automatically turn on when power is returned.

2.4 Auto-On

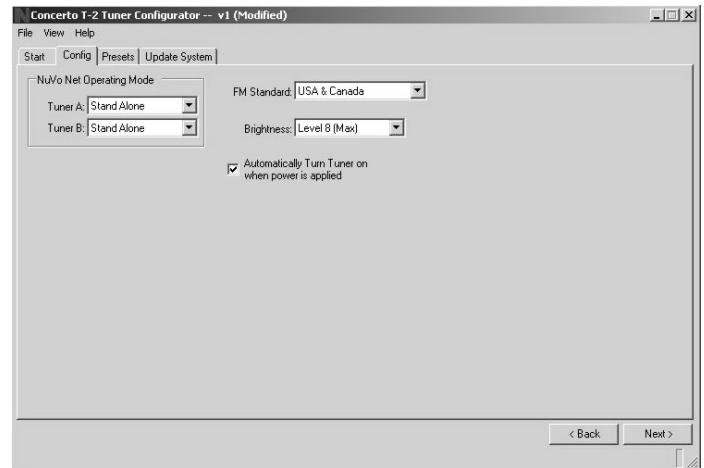

3.0 Presets

3.1 Preset Information: This section provides a display name, band and tuning frequency for each preset. As the Preset information fields are populated, the same information will automatically fill the highlighted fields to the left. Each bank of presets will hold 10 presets, and up to 10 banks can be assigned. Three buttons at the bottom of the tab are designated to assigning preset banks.

3.1 Preset Information

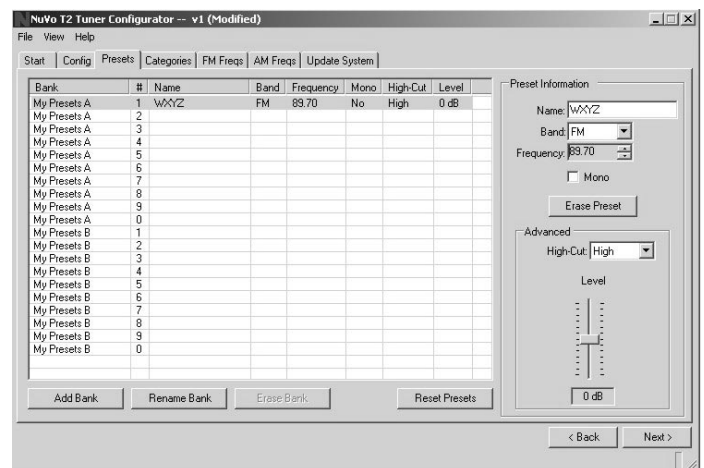

3.2 Add Bank: If you want to add a bank of 10 presets, the "Add Bank" button will bring up a window that allows you to name the bank and automatically add it to the T2's presets.

3.2 Add Bank

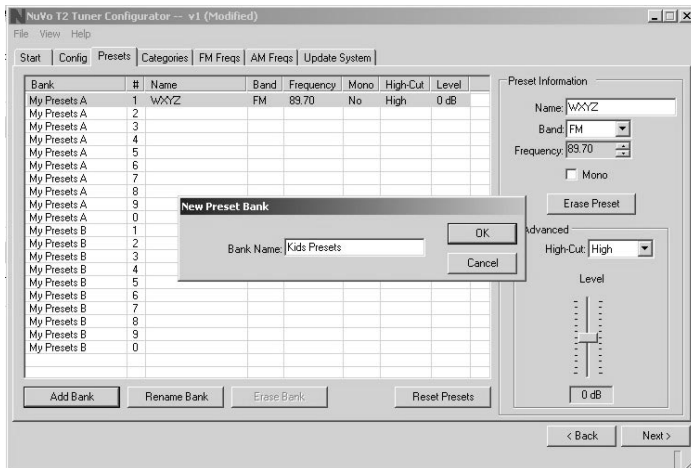

3.3 Rename Bank: This button allows you to give a bank of presets a customized name.

3.3 Rename Bank

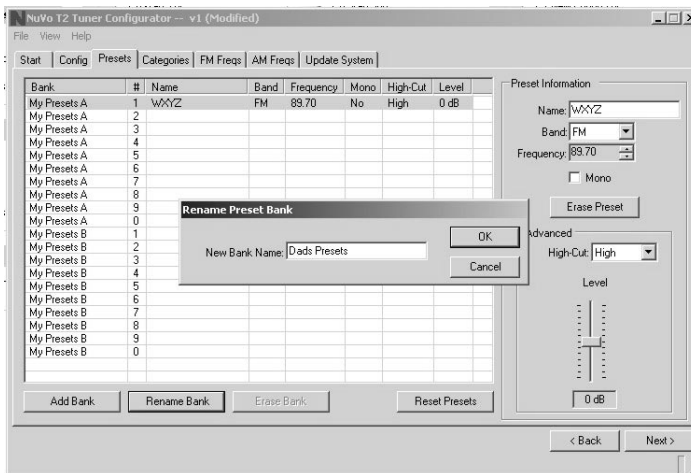

3.4 Erase Bank: All preset banks, with the exception of the first bank, can be erased one bank at a time. You cannot erase the first bank of ten presets.

3.4 Erase Bank

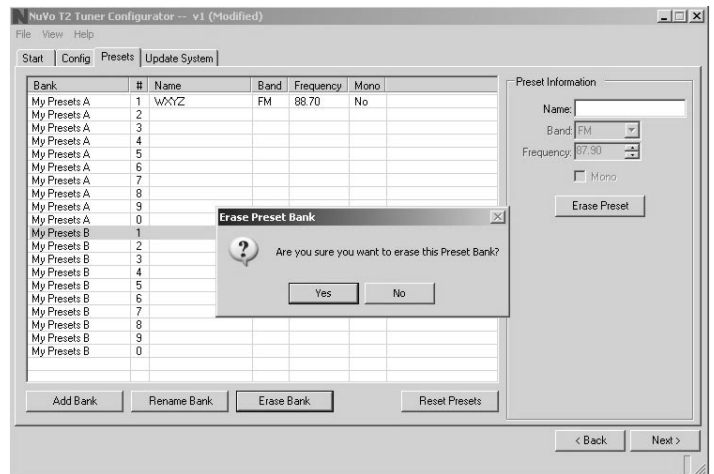

Advanced Settings

The T2 software contains several specialized settings for more advanced setup. Clicking on view and selecting "Advanced" will expand the tabs as discussed in the next section to allow access to this functionality.

4.0 Advanced Config

The T2 software allows for more advanced settings that if necessary allow you to tweak the tuner's operation.

4.0 Advanced Config

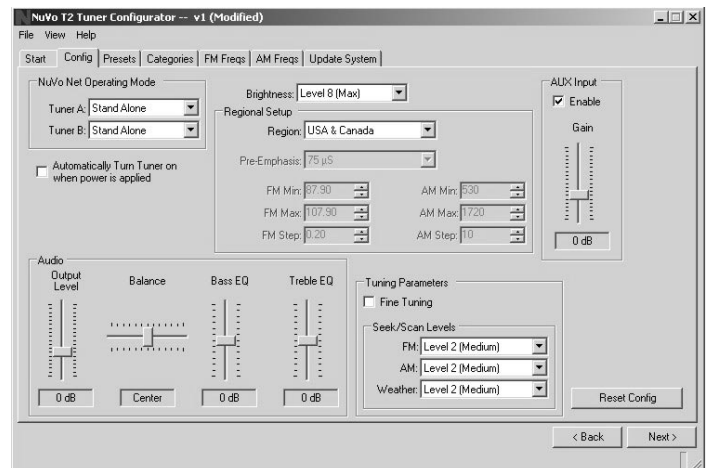

4.1 Custom Regional Setup: Some countries operate at a tuning standard outside the four preset regions. The Custom setting allows specific parameters. One determining factor for tuning is the "Pre-emphasis". The two choices for this are 50µS (microseconds) and 75µS. The custom setting also allows for specific setting of the minimum and maximum tuning capability and the individual tuning steps for FM and AM.

4.1 Custom Regional Setup

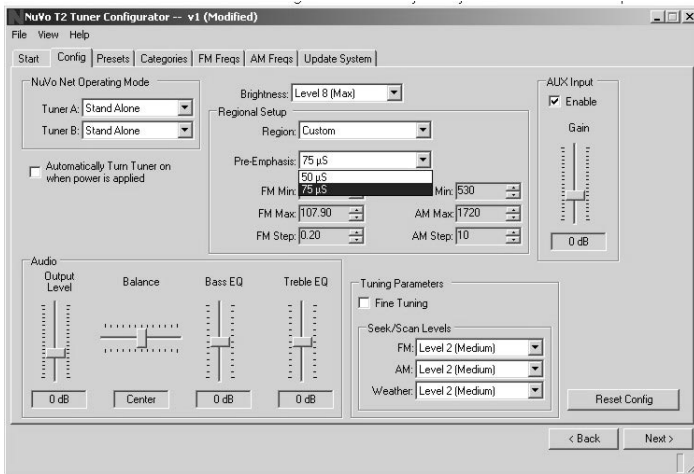

4.2 Tuning Parameters: This section determines how the T2 tunes up and down. Seek/Scan Levels for each band, FM, AM, and Weatherband sets the signal strength parameter for searching stations. The lowest level 0 causes the tuner to stop at any frequency with a very low signal. Level 4 (High), stops only when a very strong signal is detected. The factory default is Level 2 (Medium), which searches for a moderate signal. This setting changes the necessary signal threshold, which is the minimum signal level required for the T2 to recognize it and lock on to the frequency.

4.2 Tuning Parameters

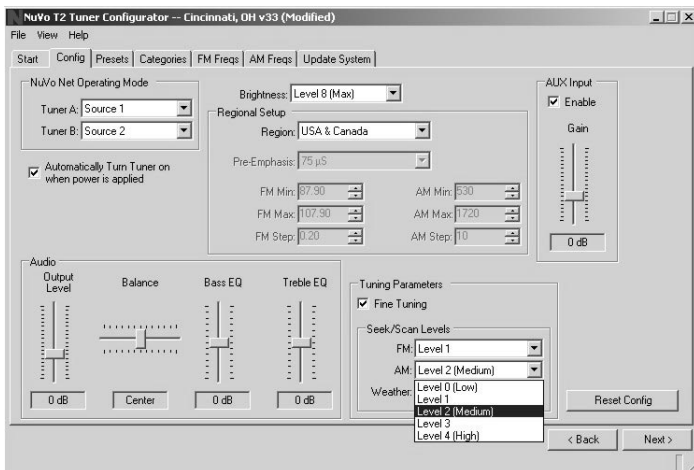

4.3 Fine Tuning: When checked, Fine Tuning changes the tuning standard for FM from the default tuning to .05 MHz step tuning, and AM will tune by single kHz increments, rather than the default 10 kHz for USA and Canada, and 9 kHz for Europe. The smaller tuning steps allow access to all station frequencies.

4.3 Fine Tuning

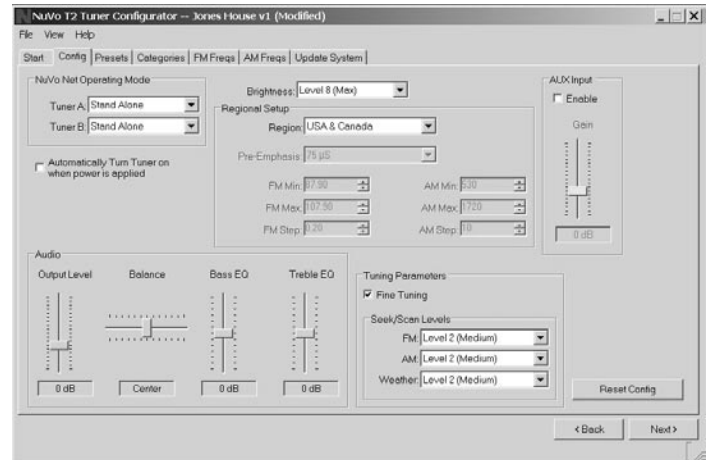

4.4 Audio: Output Level increases or decreases the level of signal from the audio output of each tuner. This setting and balance, treble, and bass are best left at the default settings for use with an audio distribution system such as NuVo systems, that have built-in equalization capability. You may want to make adjustments when the T2 is being used as a stand-alone component with an amplifier.

4.4 Audio Output Level

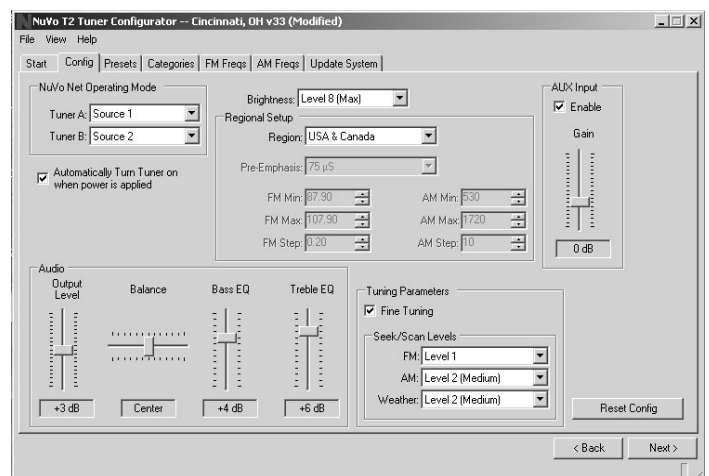

4.5 AUX Input: The T2 has an additional input that allows an external device to be controlled through the T2's IR pass through. When this input is enabled, the level of the signal input can be adjusted up or down to match the tuners' signal output level.

4.5 AUX Input

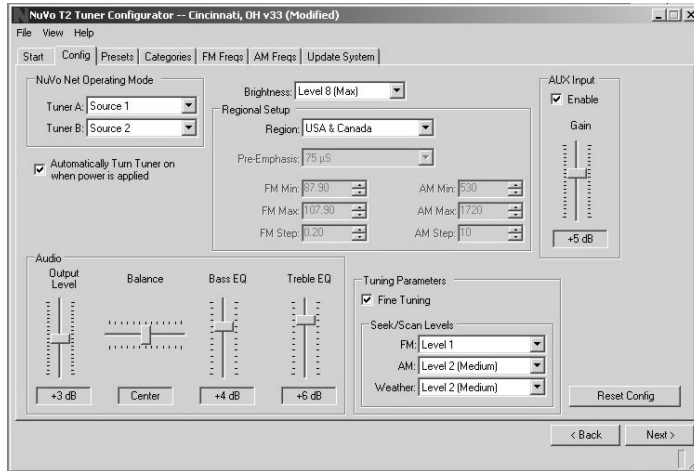

5.2 Level: This slider changes the signal level of the station. This is especially useful for stations, such as many Public Broadcasting System affiliates, that broadcast an uncompressed signal with lower volume level than other stations. This makes it possible for all stations to have the same volume level as the user accesses presets.

5.1 Level

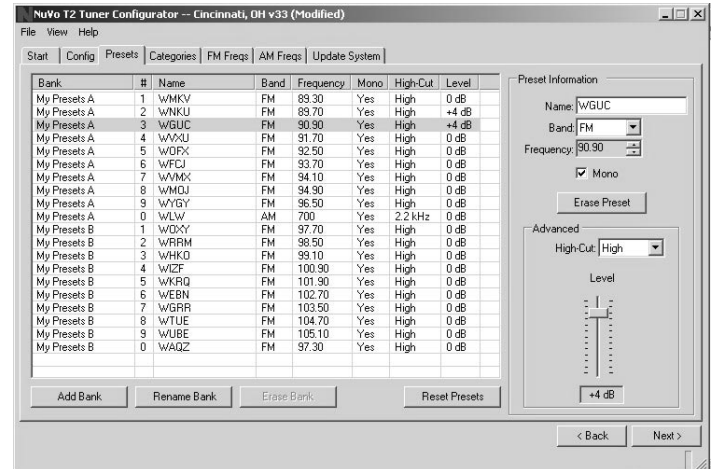

5.0 Advanced Presets

The preset tab in the advanced settings has additional features for specific preset setup.

5.1 High Cut: High-Cut is rarely used, but it can be a useful function for a weaker AM signal that tends have high-frequency hiss. This drop down menu allows you to select a frequency cut-off for high-frequency reception. Any audio above the chosen frequency will be filtered with a gentle roll-off response.

5.1 High Cut

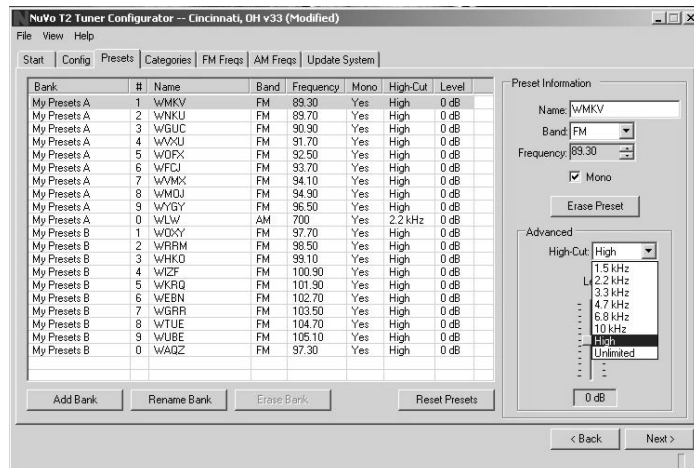

6.0 Categories

A unique feature of the T2 is the ability to set up categories of listening. These are genre selections that automatically tune through stations within that genre. Typical categories are sports, talk, rock, classical. The T2 software has 38 preloaded categories available. These are easily turned off if you do not intend to use them, or new categories can be added to best fit the user's needs.

6.1 Categories Tab: By highlighting categories within the categories tab, you can then click on the On/Off button to turn that category off. This prevents unused categories from being displayed when scrolling through the category selections. If you know you will not use a category, you can delete it all together, or add a specific category that is not listed. Any of the categories can be given a customized name by clicking on the rename button.

6.1 Categories Tab

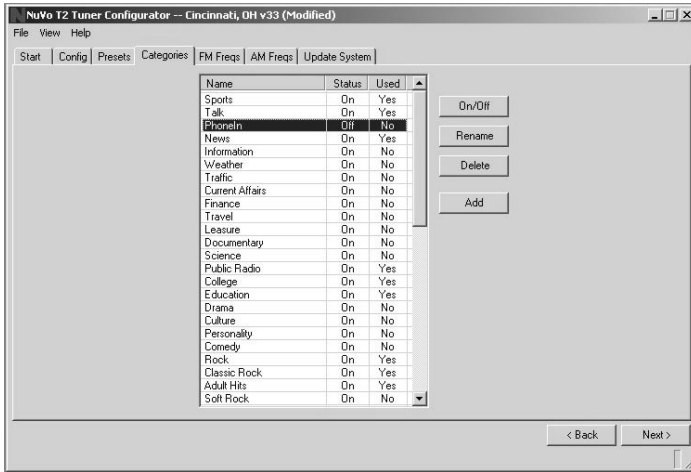

6.3 AM Freqs

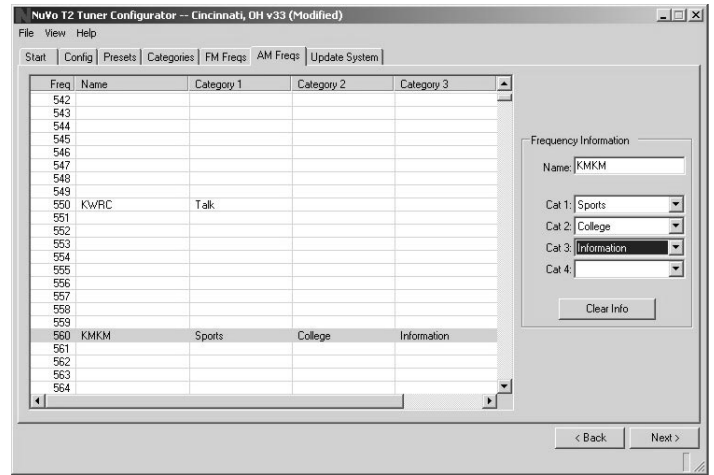

6.2 FM Freqs: This tab lists all the available frequencies within the FM band. When highlighted, the Frequency Information on the right side of the tab allows you to name and categorize each desired frequency in up to four different categories. The Category drop down menus will only display the categories you have turned on.

6.2 FM Freqs

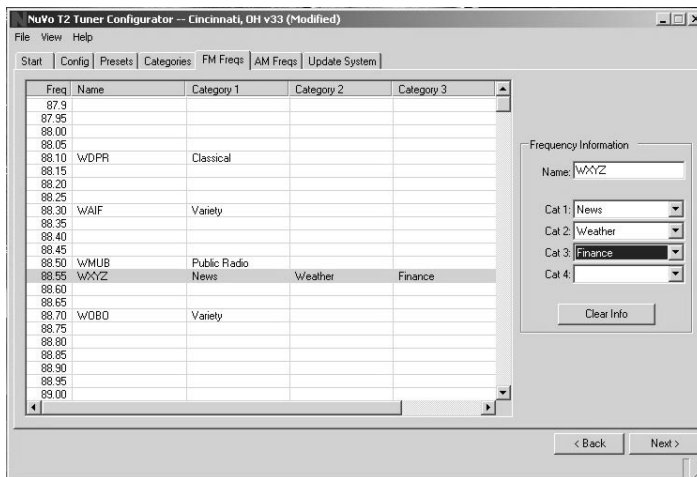

6.3 AM Freqs: This tab is identical in function to the FM Freqs tab, but categorizes the AM frequencies.

When the desired frequencies have been categorized, the Category tab will update to show the Categories you have turned on and whether or not each category is used.

7.0 Update System

7.1 Download Configuration: The final step in the setup is to download the configuration to the T2 via either its Rs232 serial port, or the USB port. At download the system gives three options: Download configuration to both tuners, or to either Tuner A or Tuner B. When you select an option, a window will appear with a download progress bar.

7.1 Download Configuration

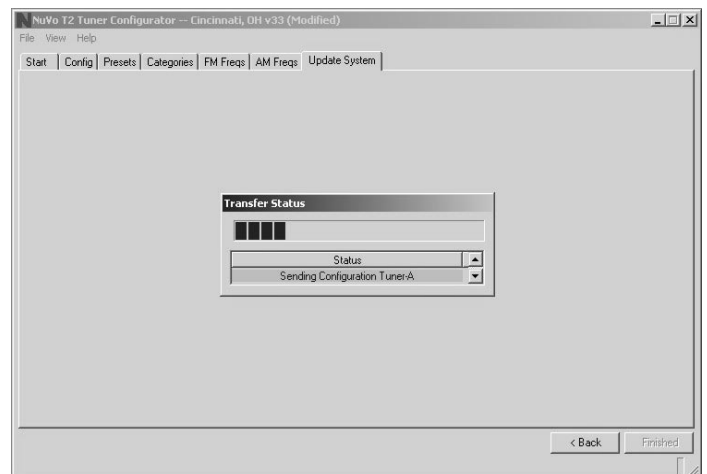

7.2 Successful Download: When the download is complete a final window will appear indicating that all the information has downloaded successfully. Actual download time will vary based on your computer's processing capabilities.

7.2 Successful Download

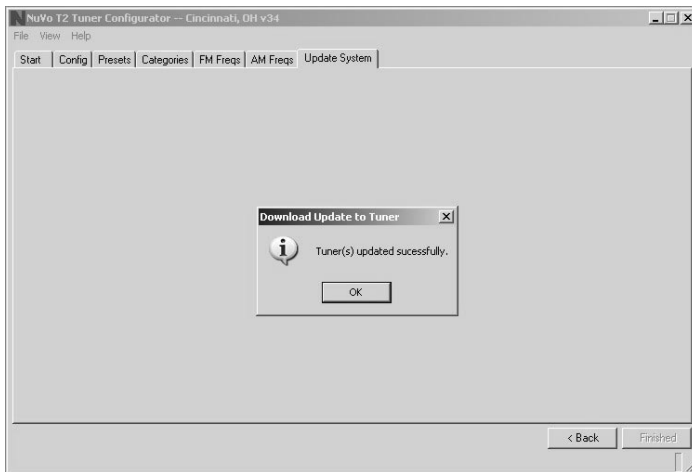

NV-T2DF Specifications

FM Section

Tuning Range	87.5 to 108 MHz
IF Frequency	10.7 MHz
Usable Sensitivity, 30 dB S/N	14 dB ?V
Auto Scan Sensitivity	Adjustable
Image Rejection	50 dB Min.
Limiting Sensitivity	10 dB ?V

Physical Specifications

Unit Size Millimeters	44 x 430 x 270
Unit Size Inches	1.75 x 17 x 10.625
Foot Height	11mm / .433 in.
Shipping Size Millimeters	110 x 520 x 345
Shipping Size Inches	4.33 x 20.48 x 4.33
Unit Weight Kilograms	3.4
Unit Weight Pounds	7.5
Shipping Weight Kilograms	4.5
Shipping Weight Pounds	10

AM Section

Tuning Range	522 to 1720 kHz
IF Frequency	450 kHz
Usable Sensitivity	25 dB S/N
Auto Scan Sensitivity	Adjustable
Image Rejection	50 dB Min.

Audio Section

Output level/Impedance	Adjustable/560 ohms
------------------------	---------------------

General

Input Voltage	90-264V/ 50/60 Hz
Power Consumption, operating	10W Max
Power Consumption, standby	3W Max.
Memory Backup	Indefinite

Infrared Section

Input Voltage	3 - 15 V
Input Carrier Frequency	38 kHz nominal
Polarity	Active High

Free Manuals Download Website

<http://myh66.com>

<http://usermanuals.us>

<http://www.somanuals.com>

<http://www.4manuals.cc>

<http://www.manual-lib.com>

<http://www.404manual.com>

<http://www.luxmanual.com>

<http://aubethermostatmanual.com>

Golf course search by state

<http://golfingnear.com>

Email search by domain

<http://emailbydomain.com>

Auto manuals search

<http://auto.somanuals.com>

TV manuals search

<http://tv.somanuals.com>