

NUVO®

TECHNOLOGIES

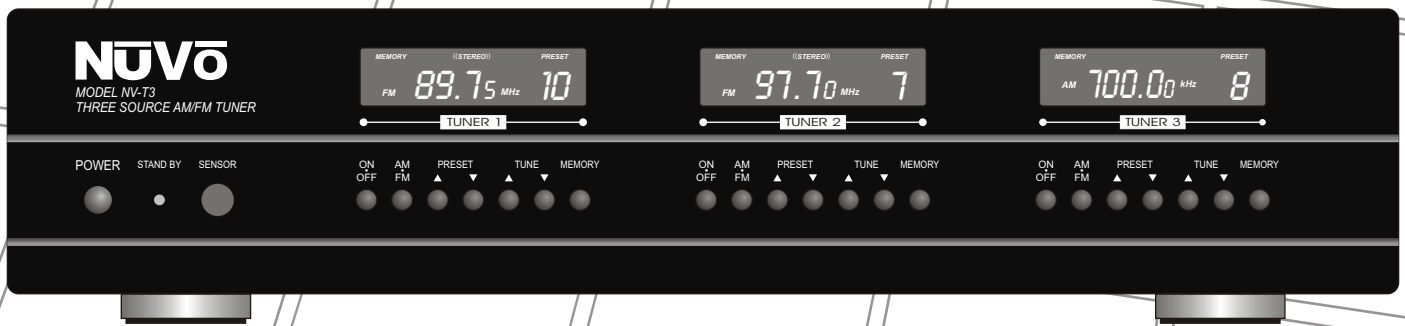

NUVO NV-T3 3-IN-1 AM/FM TUNER OWNER'S MANUAL

Safety Instructions

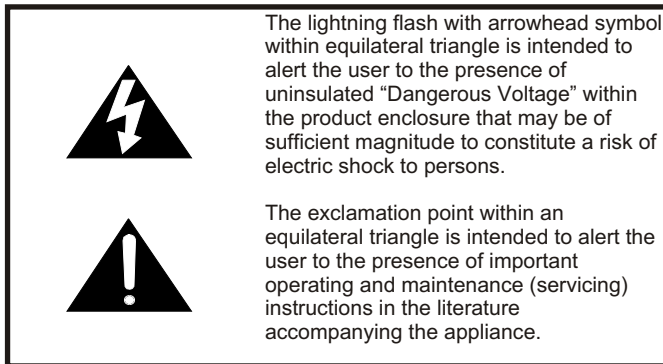
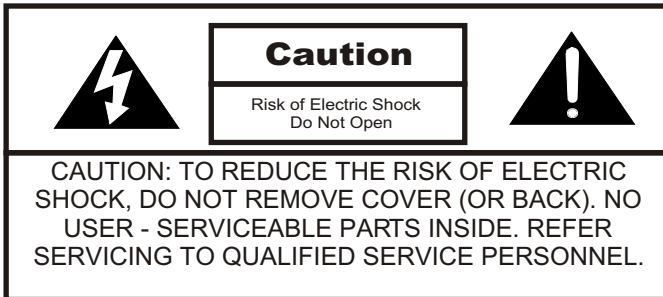

- 1) Read instructions- All the safety and operating instructions should be read before the unit is operated.
- 2) Retain instructions - The safety and operating instructions should be retained for future reference.
- 3) Heed warnings - All warnings on the unit and in the operating instructions should be heeded.
- 4) Follow instructions - All operating and other instructions should be followed.
- 5) Water and moisture - The unit should not be used near water - for example, near a bathtub, washbowl, kitchen sink, laundry tub, in a wet basement, or near a swimming pool, etc.
- 6) Wall or ceiling mounting - Unit should be mounted to a wall or ceiling only as recommended by the manufacturer.
- 7) Cleaning - The unit should be cleaned only as recommended by the manufacturer.
- 8) Ventilation - The unit should be situated so that its location or position does not interfere with its proper ventilation. For example, the unit should not be situated on a bed, sofa, rug, or similar surface that may block the ventilation openings; or placed in a built-in installation, such as a bookcase or a cabinet that may impede the flow of air through the ventilation openings.
- 9) Heat - The unit should be situated away from heat sources such as radiators, stoves, or other appliances that produce heat.
- 10) Power sources - The unit should be connected to a power supply only of the type described in the operating instructions or as marked on the unit.
- 11) Power cord protection - Power-supply cords should be routed so that they are not likely to be walked on or pinched by items placed upon or against them, paying particular attention to cords at plugs, convenience receptacles, and the point where they exit from the unit.
- 12) Nonuse periods - The power cord of the unit should be unplugged from the outlet when left unused for long periods of time.
- 13) Object and liquid entry - Care should be taken so that objects do not fall into or liquids spilled into the inside of the unit.
- 14) Servicing - The user should not attempt to service the unit beyond those means described in the operating instructions. All other servicing should be referred to qualified service personnel.
- 15) Damage requiring service - The unit should be serviced by a qualified service personnel when:
 - A. The power supply cord or the plug has been damaged; or
 - B. Objects have fallen, or liquid has spilled into the unit; or
 - C. The unit has been exposed to rain; or
 - D. The unit does not appear to operate normally or exhibits a marked change in performance; or
 - E. The unit has been dropped, or the cabinet has been damaged .
- 16) Power lines - An outdoor antenna should be located away from power lines.
- 17) Grounding or polarization - Precautions should be taken so that the grounding or polarization is not defeated.

Precautions

For U.S. Models

Note to CATV system installer:

This reminder is provided to call the CATV system installer's attention to Section 820-40 of the NEC, which provides guidelines for proper grounding and, in particular, specifies that the cable ground shall be connected to the grounding systems of the building, as close to the point of cable entry as practical.

FCC Information for the User

Caution:

Changes or modifications by the user that are not expressly approved by the party responsible for compliance could void the user's authority to operate the equipment.

NOTE:

This equipment has been tested and found to comply with the limits for a class B digital device, pursuant to part 15 of the FCC rules. These Limits are designed to provide reasonable protection against harmful interference in a residential installation. This equipment generates, uses and can radiate radio frequency energy and, if not installed and used in accordance with the instructions, may cause harmful interference to radio communications. However, there is no guarantee that interference will occur in a particular installation. If this equipment does cause harmful interference to radio or television reception, which can be determined by turning the equipment off and on, the user is encouraged to try to correct the interference by one or more of the following measures:

- 1) Reorient or relocate the receiving antenna.
- 2) Increase the separation between the equipment and the receiver.
- 3) Connect the equipment into an outlet on a circuit different from that to which the receiver is connected.
- 4) Consult the dealer or an experienced radio/TV technician for help.

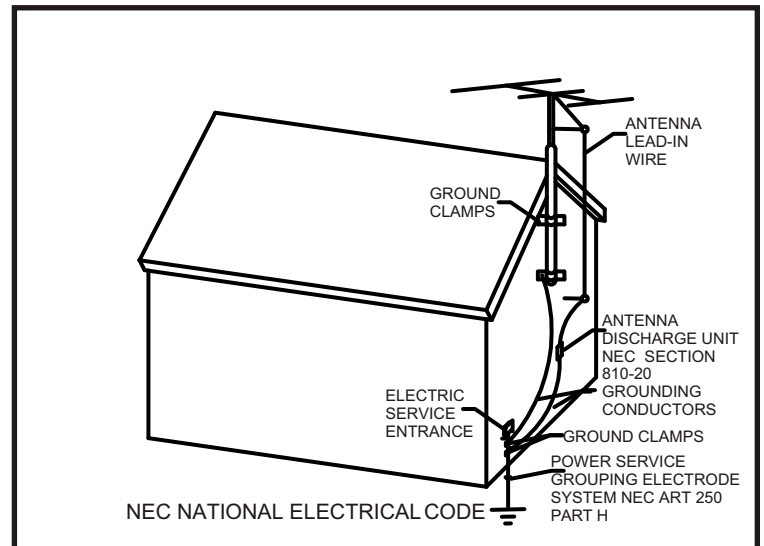

Warranty

NUVO Technologies warrants this product to be free of defects in workmanship or materials for a period of three (3) years from the original date of purchase. This warranty applies to the original purchaser only and is not transferable. This warranty is subject to the following conditions and exclusions.

- Defects caused by wear and tear, misuse, or neglect are not covered by this warranty.
- This warranty will be void if:
 - a. The unit has been altered or modified.
 - b. The serial number has been removed or defaced.
 - c. Original purchase is not from an Authorized NUVO Dealer.
 - d. The warranty card is not completely filled out and mailed within 10 days of the original purchase.

Neither NUVO Technologies nor NUVO dealers are liable for any incidental or consequential damages resulting from any defect in or failure of NUVO Technologies products. This warranty gives the original owner of NUVO Technologies products specific legal rights, and he or she may also have other rights which vary from state to state. This warranty is expressly in lieu of all other agreements and warranties, expressed or implied, except as may be otherwise required by law.



Model NV-T3

3-in-1 AM/ FM Tuner

Introduction

Imagine the capability to enjoy AM news in the den ... soft rock FM in the kitchen ... and a smooth jazz FM station in the bedroom ... all at the same time *and* without having to purchase three separate tuners. With the introduction of the NUVO™3-IN-1 AM/FM tuner, this dream is now a reality.

The NUVO™3-in-1 provides three independent AM/FM tuners in one convenient and affordable package. Using the handy NUVO™ RC1 remote, you can easily control the 3-in-1 from anywhere in your home. With separate IR (infrared) codes for each tuner, it's simple to choose preset stations, adjust volume levels, switch from AM to FM, mute a specific tuner, and more - all with one NUVO™ remote control. There's no need for multiple remotes!

The NUVO™3-in-1 Tuner can be used with most any audio system. But when combined with a NUVO™ or Kustom multi-source, multi-zone system, you get complete control, convenience, and flexibility. *That's* the magic of NUVO™.

List of Supplied Accessories	Part #		PART #
1) One NV-RC1 Remote Control	NV-RC1	4) Three Indoor AM Antennas	MV-AM1
2) Two AAA Batteries	N/A	5) One Power Cord	N/A
3) Three Indoor FM Antennas	NV-FM1	6) Three Audio Cables	NV-AC1

Table of Contents

Page 1)	Front Cover
Page 2)	Safety Page
Page 3)	Precautions Page
Page 4)	Introduction, List of Supplied Accessories, Table of Contents
Page 5)	LCD Display
Page 6)	Work Sheet
Page 7)	Front Panel Controls and Their Functions
Page 8)	Remote Control
Page 9)	Rear Panel Connections
Page 10)	Troubleshooting
Page 11)	Remote AM/FM Antenna Configurations
Page 12)	Specifications

LCD Display

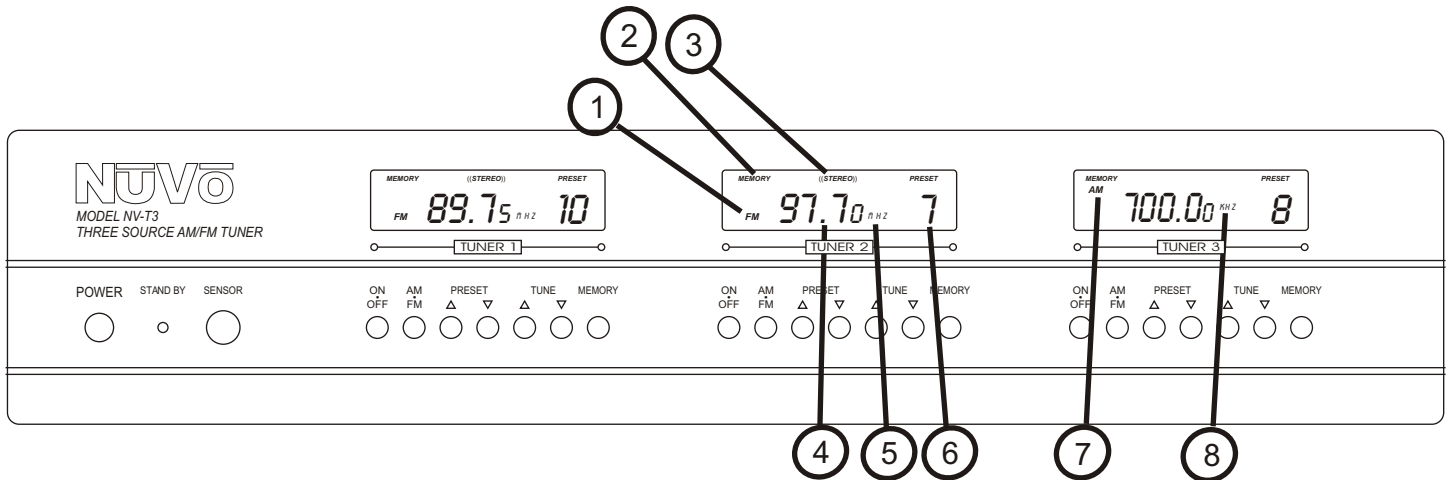

1) FM

Frequency Modulation

2) Memory

Lights when programming the tuner.

3) Stereo

This display shows the tuner is capable of receiving stereo broadcasts.

If the display reads ((STEREO)), the tuner is receiving a stereo broadcast.

If the display is off, the tuner is in the mono mode and can be changed only from the remote control.

Please refer to page for more information on the remote control.

4) Numerical Display

This display shows to what frequency the tuner is tuned.

5) MHz

Megahertz

6) Preset Numbers

This display shows what preset is currently being used by the tuner.

7) AM

Amplitude Modulation

8) kHz

Kilohertz

Important

Please use this work sheet before attempting to program the NUVO NV-T3.

We recommend this web site for radio programming in your area. This will help filling out your work sheet.

www.radio-locator.com

Filling out your work sheet

Choose AM or FM; fill in the space.

Fill in the frequency space.

Each preset can be AM or FM and the frequency does not have to be in any particular order.

Programming the tuner for the first time.

Programming from the front panel is recommended. Programming from the remote control is not recommended. Turn the unit on and power up all three tuners.

Program one tuner at a time.

1) Press preset \odot \ominus until desired preset number is displayed.

2) Choose AM or FM.

3) Tune to desired station by pressing the tune-up or tune-down arrows.

4) Press and hold the memory button until the preset number blinks.

5) Repeat the process for each preset.

NUVO Tuner 1			NUVO Tuner 2			NUVO Tuner 3		
Preset Number	AM or FM	Station Frequency	Preset Number	AM or FM	Station Frequency	Preset Number	AM or FM	Station Frequency
0			0			0		
1			1			1		
2			2			2		
3			3			3		
4			4			4		
5			5			5		
6			6			6		
7			7			7		
8			8			8		
9			9			9		
10			10			10		
11			11			11		
12			12			12		
13			13			13		
14			14			14		
15			15			15		
16			16			16		
17			17			17		
18			18			18		
19			19			19		

Front Panel Controls and Their Functions

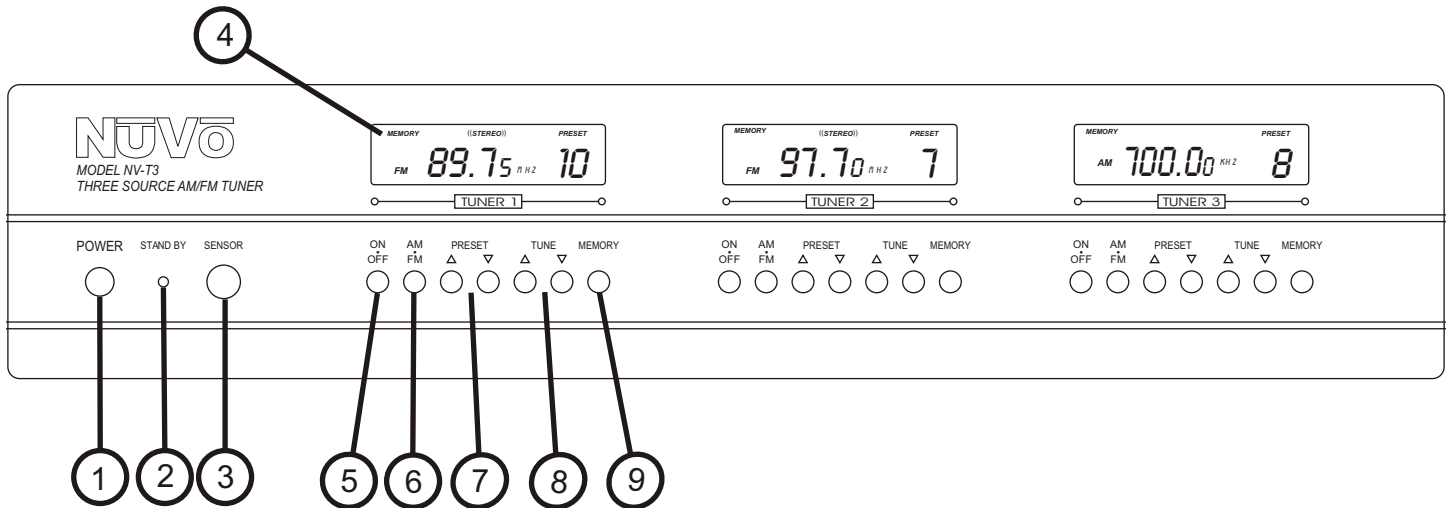

1) Power Button

Press switch on for stand by power.
This switch was designed to be left on all the time.

2) Stand by LED

Lights when the power switch is engaged.

3) Remote control sensor

This receives signals from the remote control.

4) Display

This shows various information (refer to page 5 for details).

5) On/Off

This turns power on and off for that specific tuner.

6) AM/FM

This changes reception band between AM and FM.

7) Preset

This changes the preset stations.

8) Tune

This button is used for tuning. Press Δ button to tune to higher frequencies. Press ∇ button to tune to lower frequencies.

9) Memory

This button is used to store radio station frequencies. Refer to page 6 for more information.

Remote Control Model NV-RC1

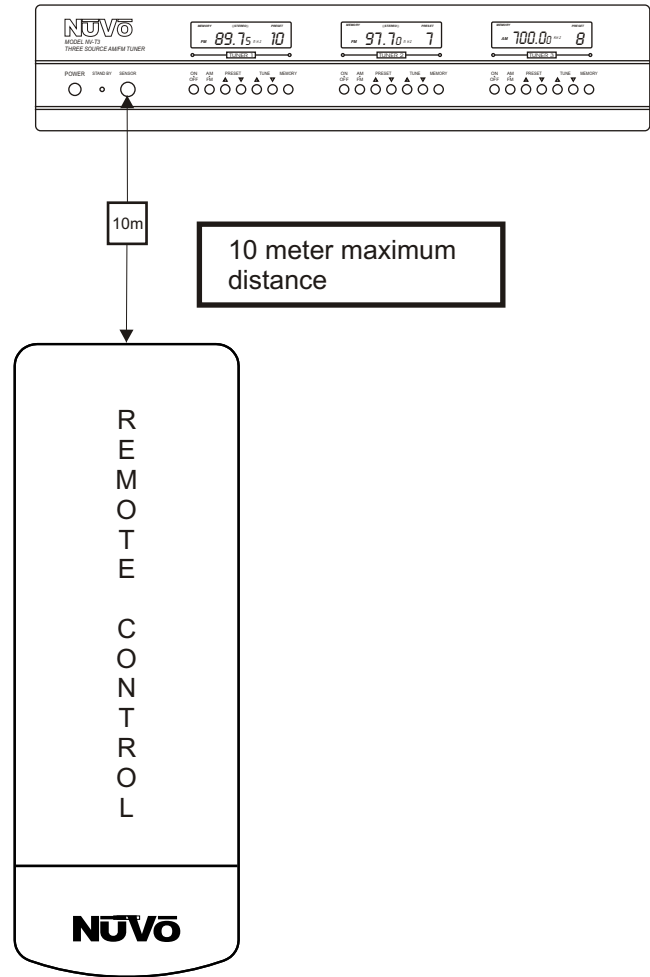
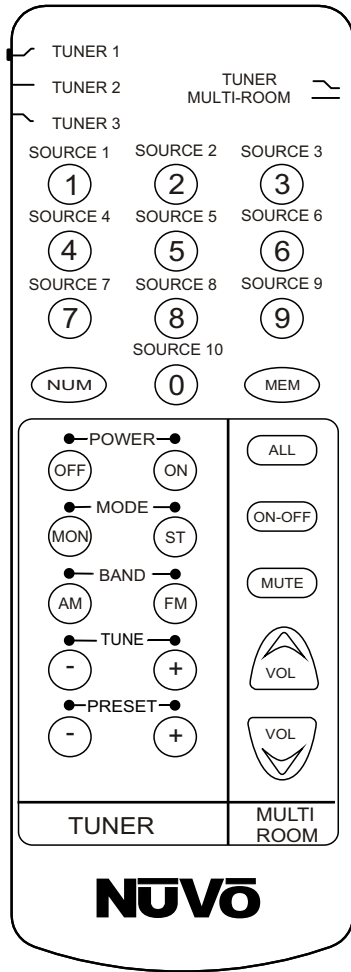

RC-1 Tuner remote	
KEY	Function
POWER OFF	This turns tuner off
POWER ON	This turns tuner on
MODE MONO	Selects FM mono
MODE ST	Selects FM stereo
BAND AM	Selects AM band
BAND FM	Selects FM band
TUNE +	Tunes up in frequency
TUNE -	Tunes down in frequency
PRESET +	Advances presets forward
PRESET -	Advances presets backward

NUM	Numeric Display	This button is for direct tuning. Example: If 97.7 FM is the desired station, press NUM and then press 977 in that order.
0 THRU 9	Selects a tuner preset 1 through 20 with "0" = 1st preset and "19" = last preset.	Press "0" through "9" To select presets 0 through 9, press 11 through 19 and that preset will be displayed.
MEM	Programs selected stations in selected presets	See page 6.

Rear Panel Connections

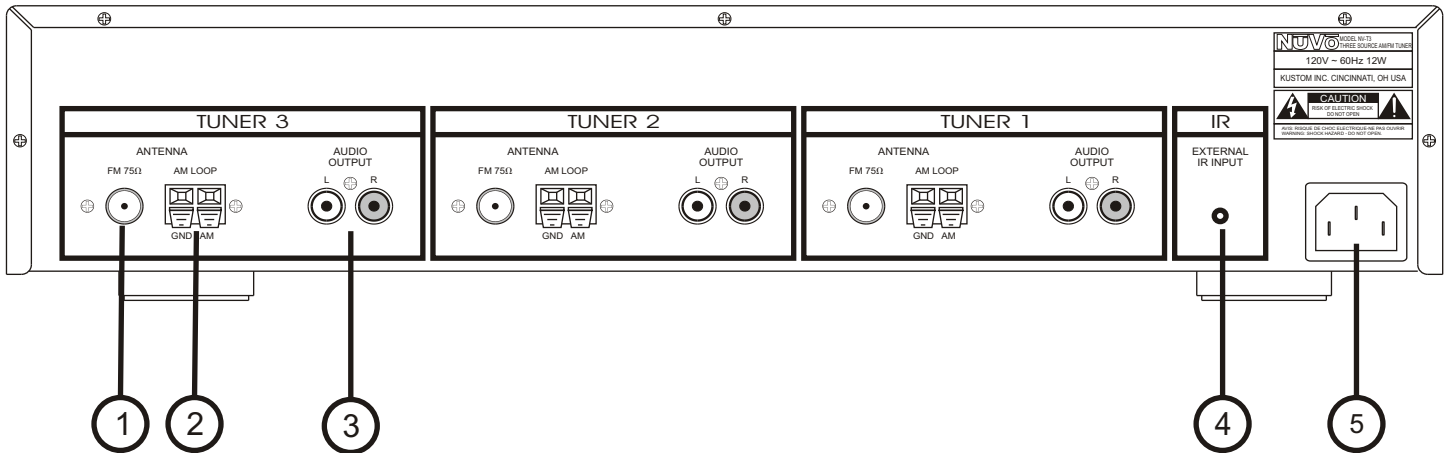

1) FM Antenna connection

75-ohm cable connections.

If using an outdoor antenna (not supplied), do not connect the supplied indoor antenna.

If using a 300-ohm cable, a 300-ohm to 75-ohm antenna adapter must be used (not included).

2) AM Antenna connection

AM loop antenna connection.

If using an outdoor AM antenna, also connect the loop antenna for better performance.

3) Audio out

Connect RCA-type audio cables from the tuner to the amplifier.

Connect white to the left channel; connect red to the right channel.

4) IR (Infrared) external connection

IR input connection for external equipment

(This is typically used with a NUVO multi-room audio system.)

Refer to specifications for more information.

5) AC power connection

IEC-type power cord connection to AC wall outlet.

Only connect to voltage specified on the back of tuner!

Troubleshooting

	SYMPTOM	CAUSE	REMEDY
FM	Noisy reception Crackling sounds.	Noise from other electrical equipment, ignition noise from passing vehicles.	The FM antenna should be put up as high as possible. Install a noise suppressor on the equipment causing the noise.
	Stereo indicator (()) flickers.	Insufficient antenna input.	Try using a directional antenna.
	FM Stereo reception is noisy.	Transmitter too far away, antenna is not in direct line of sight with transmitter tower.	Check all antenna connections. Try using a directional antenna. Use manual tuning.
	There is distortion and clear reception cannot be obtained even with a good antenna.	Multipath interference.	Try different antenna positions.
	Cannot tune station using automatic tuning, no stereo operation	Station is too weak. The tuning mode is set to manual tuning.	Use manual tuning mode . Try using a directional antenna.
	Preset stations can no longer be tuned in.	The T-3 has been unplugged for a long period of time. No AC power at the wall outlet for a long period of time.	Reprogram the tuner.
AM	Cannot tune station using automatic tuning.	Weak signal.	Use manual tuning mode.
	There are continuous crackling and hissing noises.	These noises result from certain atmospheric conditions. All types of electrical equipment cause noise in AM reception.	Use an outdoor antenna and a good ground wire. Note: It is very difficult to eliminate all noise.
	There are buzzing and whining noises (especially in the evening).	A TV set is in use nearby. Another station is interfering with the received station.	Relocate the NV-T3 or the TV.

Remote AM / FM Antenna configurations

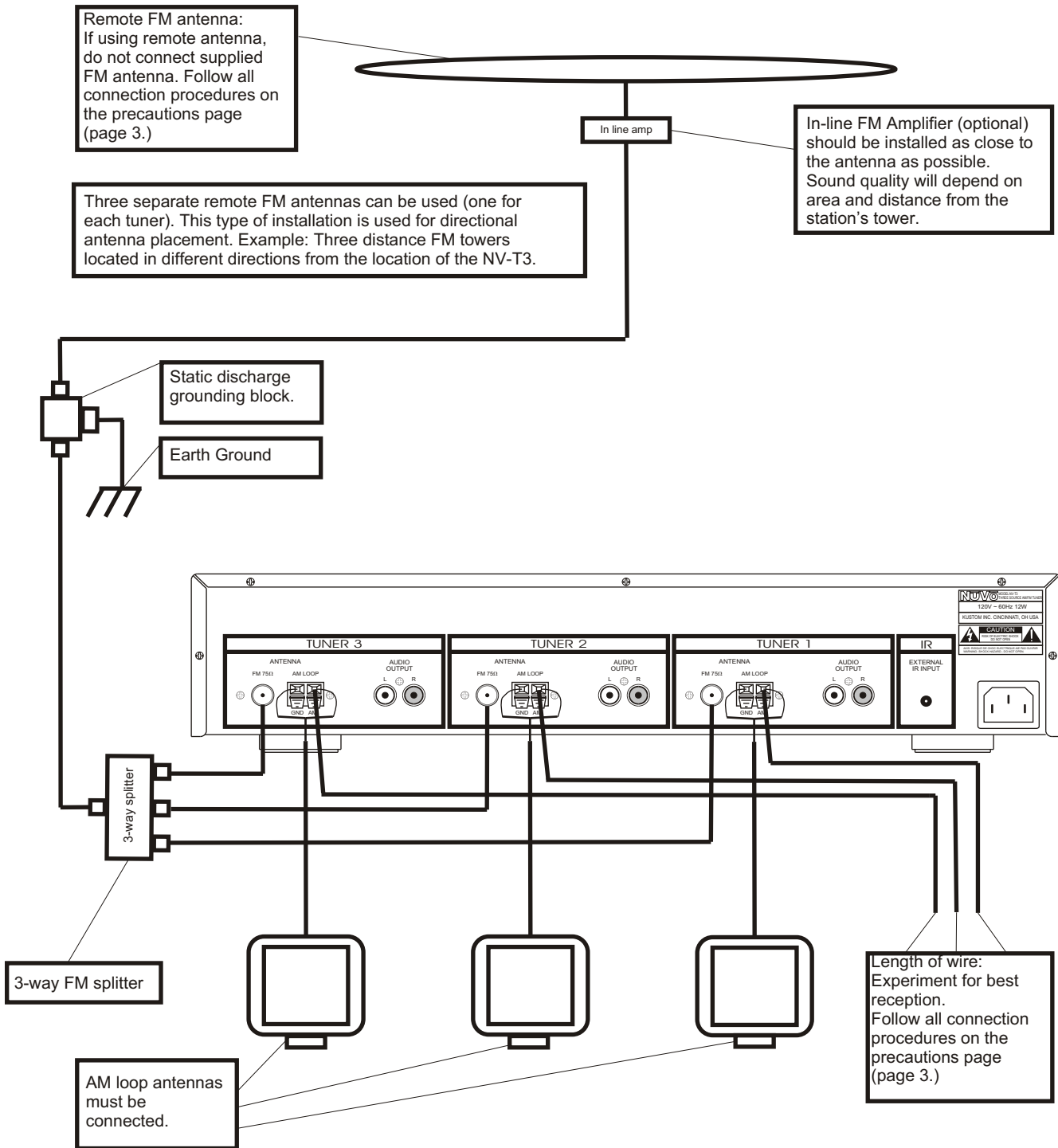

- Recommended Parts**
- 1) Outdoor FM antenna.....**TERK® FM PRO** (includes in-line amplifier)
 - 2) 3-way splitter.....Any brand that will pass 88 to 108 MHz
 - 3) Static Discharge Grounding Block.....Any brand

Specifications*

FM Section

Tuning Range	87.5 to 108 MHz
IF Frequency	10.7 MHz
Usable Sensitivity, 30 dB S/N	13 dB
Auto Scan Sensitivity.....	23 dB
IF Rejection.....	72 dB Max.
Image Response.....	45 dB Max.
AM Rejection.....	44 dB AM 60dB/M/30/% Modulation
Limiting Sensitivity.....	55 dB REF. I/P/-3 db
Frequency Response.....	12HZ to 13.1kHz REF. I/P/-3
Harmonic Distortion.....	0.01%
Strong Signal Distortion.....	0.39%
AF Output.....	430mV
Noise, Hum.....	150mV Max.
Modulation Hum.....	42 dB
Stereo Indicator.....	30 dB (Just on)
Channel Separation.....	35/34 dB

AM Section

Tuning Range	520 to 1710 kHz
IF Frequency	450 kHz
Usable Sensitivity, 20 dB S/N	60 dB/M
Auto Scan Sensitivity.....	66 dB/M
IF Rejection.....	48 dB Max.
Image Rejection.....	17 dB Max.
Frequency Response.....	50HZ to 12.1kHz REF. I/P/-3
Harmonic Distortion.....	0.5% 94dB/M
Strong Signal Distortion.....	1.1% 94dB/M / 80% Modulation
AF Output.....	1200mV 94dB/M / 80% Modulation
Noise, Hum.....	3.8mV Max.
Modulation Hum.....	43dB

Audio Section

Output level/Impedance (fixed)	
FM (100% Modulation 1kHz)	900mV/2.2k-ohms
AM (30% Modulation 1kHz)	150mV/2.2k-ohms

Infrared Section

Input Voltage.....	3-15 Volts
Input Carrier Frequency.....	40 kHz nominal
Polarity.....	Active High

General

USA and Canada Models.....	120V, 60HZ
Power Consumption.....	12W
Memory Backup.....	72 hours
Dimensions(W x H x D).....	430x95x340mm (16-15/16"x3-3/4"x13-3/8")
Weight.....	4.8kg (10.6 lb)

*Specifications subject to change without notice.

NUVO TECHNOLOGIES · 4940 DELHI PIKE · CINCINNATI OHIO · 45238
TEL: 1-866-796-4904 · FAX: 1-800-451-4944
www.nuvotechnologies.com
E-mail: sales@nuvotechnologies.com

Free Manuals Download Website

<http://myh66.com>

<http://usermanuals.us>

<http://www.somanuals.com>

<http://www.4manuals.cc>

<http://www.manual-lib.com>

<http://www.404manual.com>

<http://www.luxmanual.com>

<http://aubethermostatmanual.com>

Golf course search by state

<http://golfingnear.com>

Email search by domain

<http://emailbydomain.com>

Auto manuals search

<http://auto.somanuals.com>

TV manuals search

<http://tv.somanuals.com>