

BMG7011 and BMG7012

Broadband Media Gateway

User's Guide



Oki Network Technologies

Revision 1.9 Preliminary

Document Revision History

Title:		BMG7011 and BMG7012 Broadband Media Gateway User's Guide	
Document No.:		P/N BMG12-UG	
Author:		Oki Network Technologies	
Revision #	Revision Date	Reason for Update	Updated by:
0.9	11/22/03	First draft	J. Yaya
1.3	11/29/03	Corrections and additions	J. Yaya
1.5	11/21/03	Screen Cap Updates	M.Rosenbaum
1.6	12/2/03	Corrections and additions	J. Yaya
1.7	12/10/03	Corrections and additions	M. Rosenbaum
1.8	3/18/04	Corrections and additions	
1.8	4/12/04	Corrections to Text	M.Rosenbaum
1.9	4/14/04	Addition of Improved Installation Procedures	Z. Mohseni, M. Rosenbaum

Copyrights Notice

The BMG7011 and BMG7012 Broadband Media Gateways are products of Oki Network Technologies

Rights to reproduce this manual are restricted by the Copyright{ XE "Copyright" } Act.

No part of this document may be reproduced, stored on a retrieval system, or transmitted in any form by any means, electronic, mechanical, imaging, recording or otherwise, without the express written permission of Oki Network Technologies.

Information in this document is subject to change without notice.

The contents of this document have been prepared with the utmost care. However, if you should notice an ambiguous point or omission, please contact an authorized agent. Oki Network Technologies assumes no responsibility with respect to consequences resulting from the use of these products and/or the content and interpretation of the information contained in this manual.

© 2004, Oki Network Technologies. All rights reserved.

First edition: November 2003

Ethernet is a registered trademark of Xerox Corporation. Other companies and product names mentioned in this manual are the registered trademarks or services of their respective companies.

Revision 1.8

© Copyright, 2004 Oki Network Technologies. All Rights Reserved

Contents

1. OVERVIEW	1
1.1 PACKAGE CONTENTS	1
1.2 SYSTEM REQUIREMENTS	1
1.3 FEATURES	1
2. HARDWARE INSTALLATION	3
2.1 FRONT VIEW (LEDS)	3
2.2 REAR VIEW (PORTS)	4
2.3 INITIAL INSTALLATION PROCEDURES FOR ADSL AND CABLE NETWORKS	5
2.3.1 <i>Configuring TCP/IP Protocol for Your PC</i>	5
2.4 CONFIGURING THE BMG7011 AND BMG7012 VOIP GATEWAYS	6
2.4.1 <i>Configuring via Web Browser</i>	6
2.4.2 <i>Setting your BMG to communicate through PPPoE</i>	7
2.4.3 <i>Setting your BMG to communicate through DHCP</i>	9
2.4.4 <i>Setting your BMG to communicate through a Static IP address</i>	11
2.5 INSTALLATION OVERVIEW FOR ADSL AND CABLE NETWORKS	12
3. STATUS	15
3.1.1 <i>System Status:</i>	15
3.1.2 <i>Port Status:</i>	16
3.1.3 <i>DHCP Status:</i>	17
3.1.4 <i>PPPoE Status:</i>	18
3.1.5 <i>PPPoE Configuration:</i>	19
3.2 DHCP SERVER CONFIGURATION	20
3.2.1 <i>DHCP Configuration</i>	20
3.3 WAN CONFIGURATION	21
3.3.1 <i>WAN IP</i>	21
3.3.2 <i>Remote Provisioning</i>	22
3.3.3 <i>Device Mode</i>	23
3.4 NTP	24
3.4.1 <i>NTP</i>	24
3.5 NAPT CONFIGURATION	25
3.5.1 <i>Port Forwarding</i>	25
3.5.2 <i>IP Filtering</i>	26
3.5.3 <i>DMZ</i>	27
3.6 QoS	28
3.6.1 <i>QoS Configuration</i>	28
3.6.2 <i>DSCP Configuration</i>	29
3.6.3 <i>VLAN Configuration</i>	30
3.7 MAC CLONING	31
3.8 PSTN CONFIGURATION	32

3.8.1	<i>Switch Key</i>	32
3.8.2	<i>Digit Map</i>	33
3.9	PROVISION CONFIGURATION	34
3.10	SYSLOG CONFIGURATION	35
3.11	EMS CONFIGURATION.....	36
3.11.1	<i>EMS</i>	36
3.11.2	<i>SNMP Community</i>	37
3.11.3	<i>SNMP Trap Target</i>	38
3.12	VOIP CONFIGURATION	39
3.12.1	<i>Protocol</i>	39
3.12.2	<i>User</i>	40
3.12.3	<i>MGCP</i>	41
3.12.4	<i>SIP</i>	42
3.12.5	<i>H.323</i>	44
3.12.6	<i>CODEC</i>	46
3.12.7	<i>Caller ID</i>	48
3.12.8	<i>RTP</i>	49
3.12.9	<i>Tone</i>	50
3.12.10	<i>FAX</i>	52
3.12.11	<i>STUN</i>	53
3.12.12	<i>Speed Dial</i>	54
3.12.13	<i>Call Features</i>	55
3.12.14	<i>Phone book</i>	56
3.13	PASSWORD CONFIGURATION	57
3.13.1	<i>Supervisor Password</i>	57
3.13.2	<i>User Password</i>	58
3.14	UPGRADE CONFIGURATION	59
3.14.1	<i>Firmware</i>	59
3.14.2	<i>Configuration</i>	60
3.15	SAVE	61
3.15.1	<i>Save Configuration</i>	61
3.15.2	<i>Load Default Settings</i>	62
3.15.3	<i>Reboot</i>	63
APPENDIX A: TROUBLESHOOTING		64
APPENDIX B: SPECIFICATIONS		65

1. Overview

The BMG7011 and BMG7012 are external standalone devices that can provide cost effective voice communication over an IP Network. The BMG7011 and BMG7012 gateways are available in one and two channel models (respectively). Both models connect directly to analog phones, fax machines, and the IP Networks without the need for additional equipment. With the Ethernet interface of the VoIP gateways connected to another device with a WAN interface (e.g. xDSL, cable modem...), the BMG7011 and BMG7012 VoIP gateways provide toll quality voice communication and reliability for the user.

1.1 Package Contents

Carefully unpack the shipping package containing the VoIP gateway and make sure that you have the following items. If you find anything missing, mismatched or damaged, promptly contact your dealer who you purchased your product from for assistance.

- One VoIP Residential Gateway
- One RJ-11 telephone line for first telephone
- One RJ-11 telephone line for second telephone (optional)
- One RJ-11 telephone line for PSTN backup use (optional)
- One RJ-45 Ethernet cable
- One power adapter with power plug
- One package contents sheet

1.2 System Requirements

- One RJ-45 Broadband Internet connection via cable, ADSL, or wireless modem, etc.
- One PC with 10Mbps, 100Mbps, or 10/100 Mbps Ethernet card installed or Ethernet port for unit management purposes.
- TCP/IP protocol for each PC
- Microsoft Internet Explorer 4.0 or later (5.0 is strongly recommended for web configuration)
- One or two standard touch-tone telephone(s)

1.3 Features

KEY FEATURES

- BMG7011 - 1 Channel
- BMG7012 - 2 Channel
- Integrated Routing Capabilities
- Call Control Protocols H.323, SIP, MGCP

- Caller ID Indication with FSK Modem/ DTMF
- Outward Speed Dial
- Automatic Call Routing To PSTN For Specific Numbers
- Backup Life Line Access To PSTN By Switch-Code
- Custom Country Tone Definitions
- Internal Call Routing Table
- H.450 Call Supplementary Services
- H.235 Security Gatekeeper Authentication
- Configurable CODEC With Flexible Packet Size
- Support For T.38 Real Time Facsimile Transmission

QoS FEATURES

- Adaptive Jitter Buffer
- G.168 Echo Cancellation
- Voice Activity Detection (VAD)
- Comfortable Noise Generation (CNG)
- IP Packet ToS Field Bit Management
- IEEE 802.1p/Q Priority Tag, VLAN Support
- Internal Voice Priority Control To LAN/ WAN Port

MANAGEMENT FEATURES

- Support Static, PPPoE And DHCP IP Address Assignment
- Automatic Provisioning Mechanism For Telephone Number Assignment, Configuration Uploads, And Firmware Upgrades
- Web-Based Configuration Management
- TELNET Command Line Interface
- TFTP Configuration And Firmware Automatic Provisioning
- SYSLOG Status Monitoring And Fault Management
- SNMP v2/ MIB2
- Multiple Level Password Security
- NTP Time Management
- UNIX/Windows Based Element Management System (EMS) -Optional

INTEGRATED ROUTING FEATURES

- Bridge/ Gateway Mode
- NAPT
- DHCP Server
- DMZ
- IP Filtering/ Port Forwarding

2. Hardware Installation

2.1 Front View (LEDs)



Figure 1 - The front panel of the BMG7011 and BMG7012 VoIP gateways

LED	Color	Status	Description
PWR	Green	On	When the BMG7011 and BMG7012 VoIP gateways is powered on
		Off	No power provided
WAN	Green	Blinking	When data is being transmitted or received
		On	When WAN Link is established
		Off	When WAN Link is not established
LAN	Green	Blinking	When data is being transmitted or received
		On	When LAN Link is established
		Off	When LAN Link is not established
ONLINE	Green	On	When VoIP telephone service is ready
		Off	When VoIP telephone service is not ready. Phone line is connected directly to PSTN
LINE LINE1 & LINE2	Green	Blinking	When there is an incoming call (the telephone is ringing)
		On	When the telephone is in use
		Off	When telephone is not in use
WAN/LAN/ONLINE	Green	All Blinking	Momentary blinking indicating gateway Reboot
ONLINE/LINE(s)	Green	All Blinking	Simultaneous blinking indicates Firmware upload in progress

2.2 Rear View (Ports)



Figure 2 - The rear panel of the BMG7011 and BMG7012 VoIP gateways

- **LINE:** RJ-11 connector, connected to PSTN back-up line
- **PHONE1 & PHONE2:** RJ-11 connectors, connected to analog telephones or Fax machines
- **PWR:** Power connector, connected to the power adapter packaged with the BMG unit
- **ENET:** Ethernet RJ-45 connector, connected to PC using a RJ-45 Ethernet cable (optional)
- **WAN:** Ethernet RJ-45 connector, connected to WAN access device, such as the cable modem or ADSL modem

2.3 Initial Installation Procedures for ADSL and Cable Networks

Prior to installing the BMG7011/7012 into the network, the units must be setup to work within either a PPPoE, DHCP, or Static IP environment. This is accomplished prior to placement of the unit into the network.

1. [Configuring TCP/IP Protocol for your PC allowing for entry into web based setup screens](#) Steps involved with configuring the BMG7011 and BMG7012 VoIP gateways in Supervisor Mode
2. [Setting your BMG to communicate through PPPoE](#)
3. [Setting your BMG to communicate through DHCP](#)
4. [Setting your BMG to communicate through a Static IP address](#)

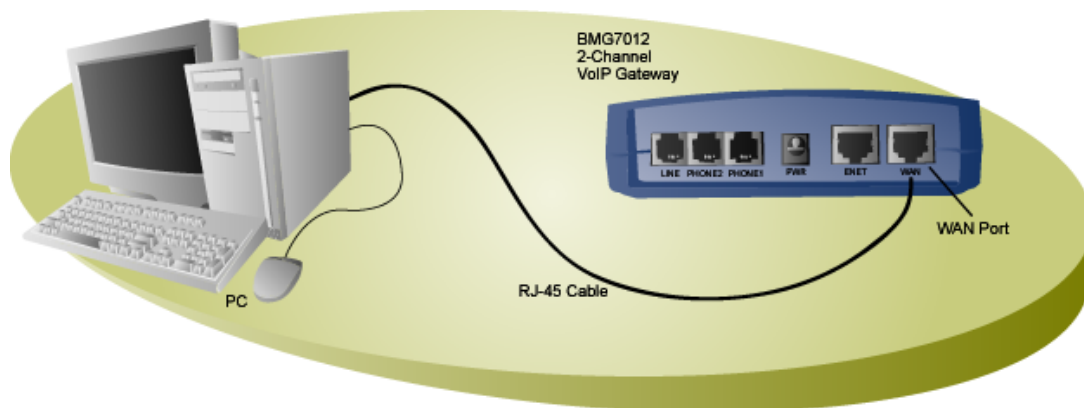

2.3.1 Configuring TCP/IP Protocol for Your PC

To communicate with and configure this device, you will need to set your PC 's IP protocol to the default BMG IP Address. If you enable static IP addressing, make sure your PC resides in the same subnet with this device's LAN IP Address (default IP Address: 192.168.100.1, default subnet mask: 255.255.255.0).

For Windows 98/Me

1. From the **Start** menu, click **Settings**, and then click **Control Panel**.
2. Double-click **Network**.
3. On the **Configuration** tab, check if TCP/IP protocol is installed on the components list.
4. If yes, go to Step 8. If no, then click **Add**.
5. Highlight **Protocol** and click **Add**.
6. Select **Microsoft** from the Manufactures list and select **TCP/IP** from the Network Protocols list.
7. Click **OK**. You will see **TCP/IP** displayed on the network components list.
8. Highlight **TCP/IP** and click **Properties**.
9. Select the **IP Address** tab and check **Specify an IP address**.
10. Set **IP address** as 192.168.100.100, **Subnet mask** as 255.255.255.0 and press **OK**.

For Windows 2000/XP

1. From the **Start** menu, click **Settings**, and then click **Network and Dial-up Connections**.

2. Double-click **Local Area Connection**.
3. Click **Properties**.
4. Click **Internet Protocol (TCP/IP)** and then click **Properties**.
5. Check **Use the following IP address**.
6. Set **IP address** as 192.168.100.100, **Subnet mask** as 255.255.255.0 and press **OK**.

For Windows NT

1. From the **Start** menu, click **Settings**, and then click **Control Panel**.
2. Double-click **Network**.
3. On the **Protocol** tab, check if TCP/IP protocol is installed on the components list.
4. If yes, go to Step 7. If no, then click **Add**.
5. Highlight **TCP/IP Protocol** and click **OK**.
6. When asked to use DHCP, click **No**.
7. Select **TCP/IP Protocol** and click **Properties**.
8. When Information Message appears, click **OK**.
9. On the **IP Address** tab, check **Specify an IP address**.
10. Set **IP address** as 192.168.100.100, **Subnet mask** as 255.255.255.0 and press **OK**.
11. When asked to restart your computer, click **Yes**.

For Linux

1. In command line interface, enter **netconf**.
2. Highlight and click **Host name and IP network devices**.
3. Set **IP address** as 192.168.100.100, **Subnet mask** as 255.255.255.0.
4. Highlight and click **Accept** to save the configuration.

2.4 Configuring the BMG7011 and BMG7012 VoIP gateways

Oki has integrated a powerful Web based server within the BMG7011 and BMG7012 gateways for quick and easy verification of connection status and device configuration.

2.4.1 Configuring via Web Browser

Once your PC is properly configured, please proceed the following steps:

1. Start the web browser.
2. Enter the default IP address **192.168.100.1** of this device in the Address box to access the web configuration menu.

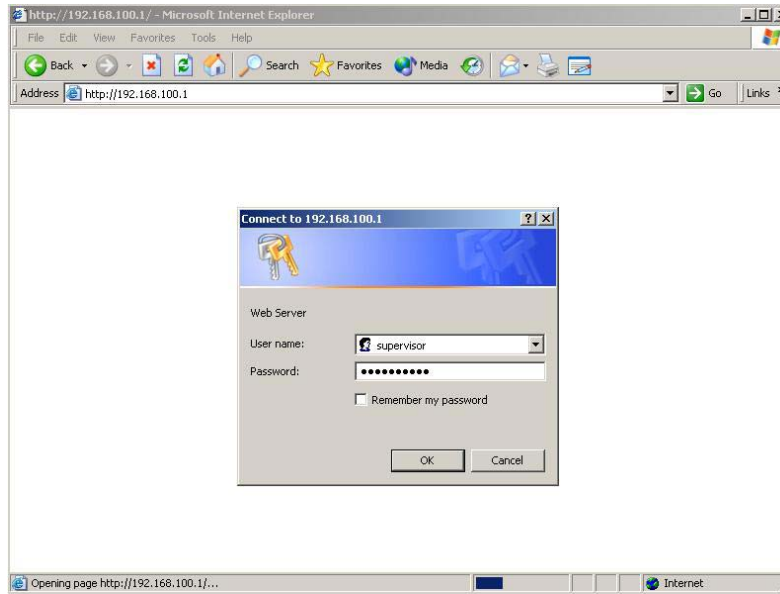

3. The web configuration menu provides two operation modes: [Supervisor Mode](#) and [User Mode](#). The web [configuration menu](#) varies according to different operation mode.

Supervisor Mode:

When the following window pops up, enter the predefined user name as **supervisor** and password as **okiconnect** and then press **OK** key.

User Mode:

For User mode login, enter “user” in the User Name entry cell “guest” in the Password entry cell – press OK.

2.4.2 Setting your BMG to communicate through PPPoE

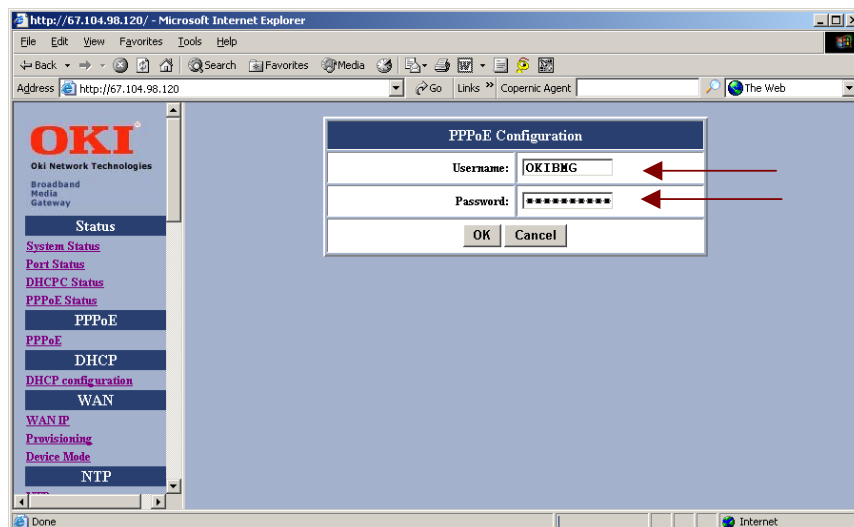

Enter Username and Password (supplied by Service Provider) in the PPPoE Configuration setup screen.

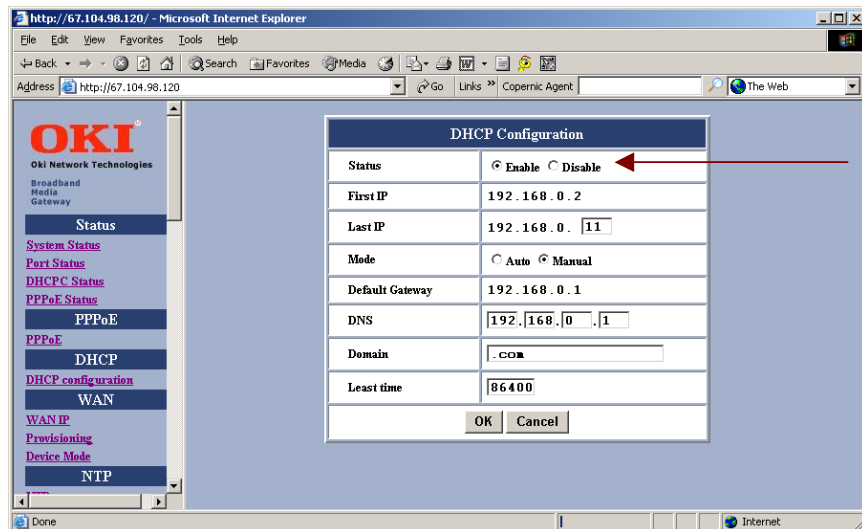

If communicating over PPPoE, you must select <Disable> in the DHCP Configuration setup screen.

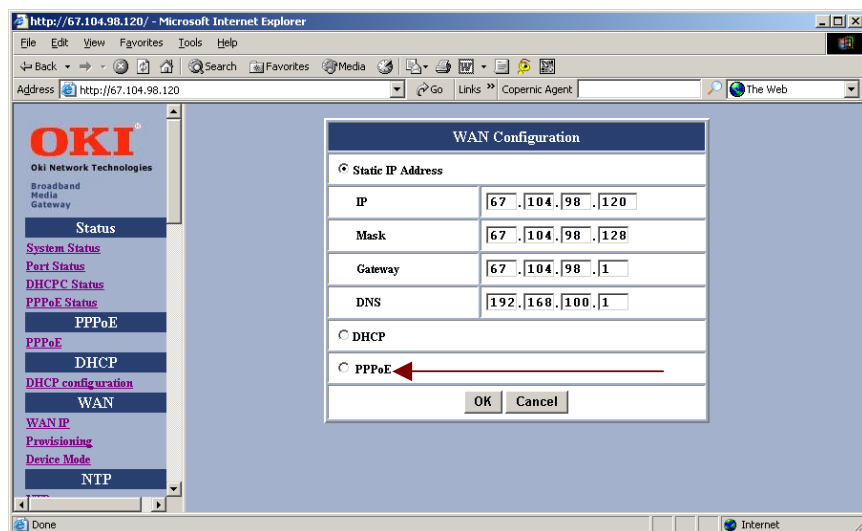

Select PPPoE within the WAN Configuration setup screen.

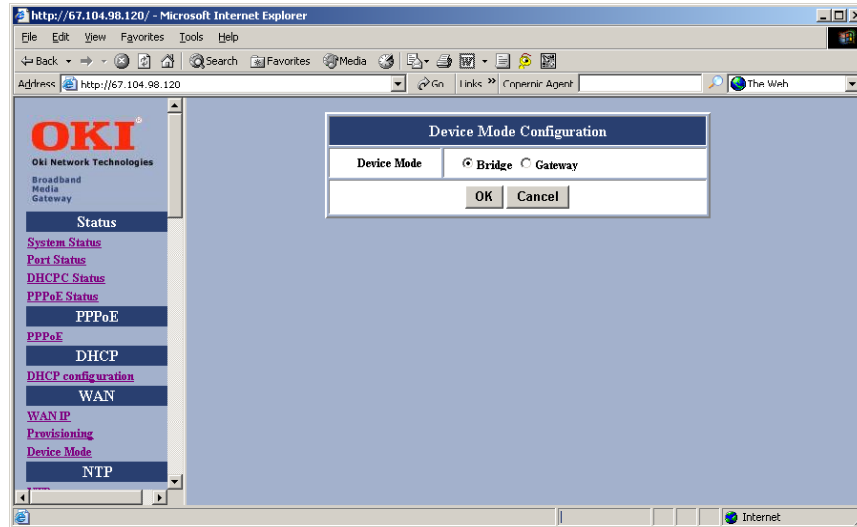

Finally, select either <Bridge> or <Gateway> within the Device Mode Configuration setup screen.

SAVE configuration settings.

2.4.3 Setting your BMG to communicate through DHCP

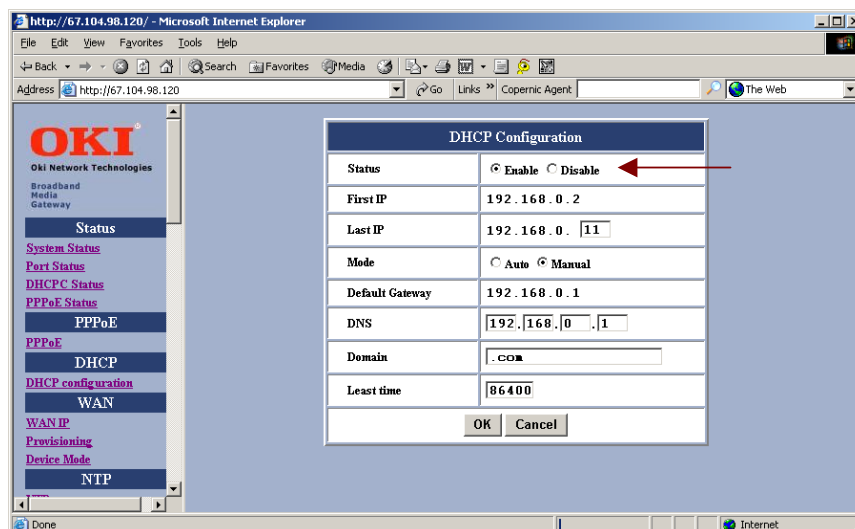

If communicating over DHCP, you must select <Enable> in the DHCP Configuration setup screen.

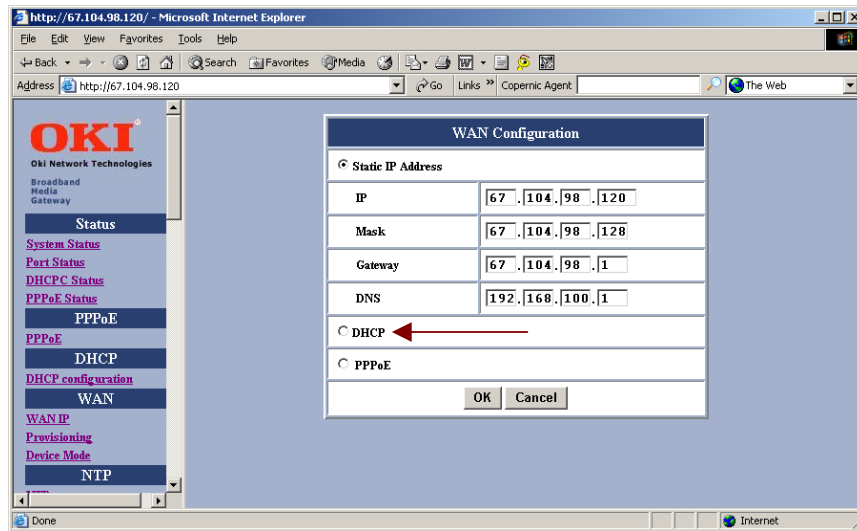

Select DHCP within the WAN Configuration setup screen.

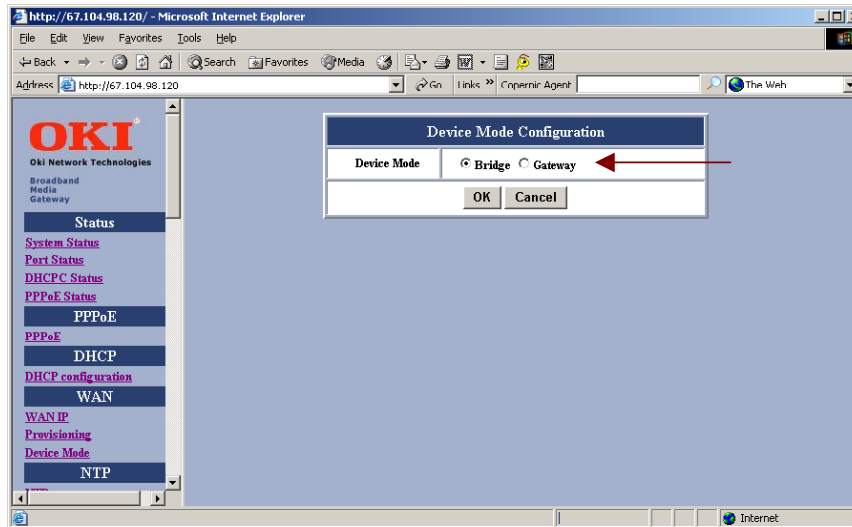

Finally, select either <Bridge> or <Gateway> within the Device Mode Configuration setup screen. SAVE configuration settings.

2.4.4 Setting your BMG to communicate through a Static IP address

The BMG7011 and BMG7012 VoIP Gateways can be setup to communicate over a Static IP address.

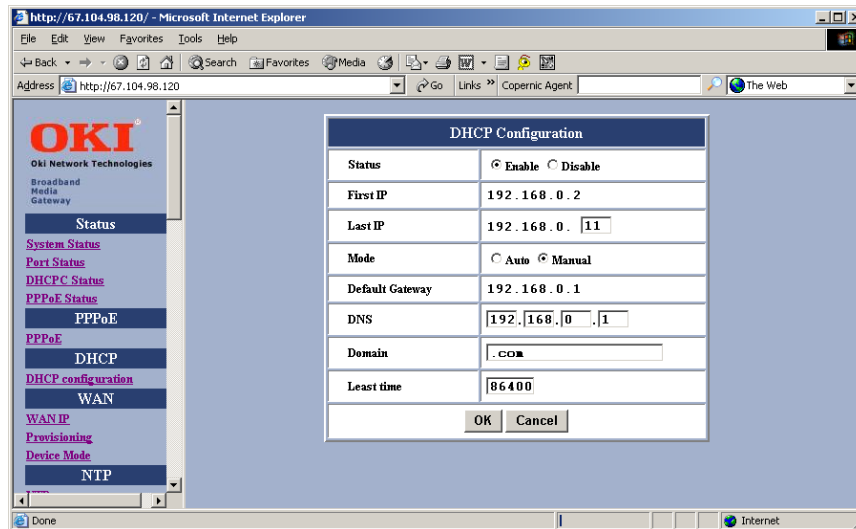

If communicating with a Static IP address then <disable> DHCP.

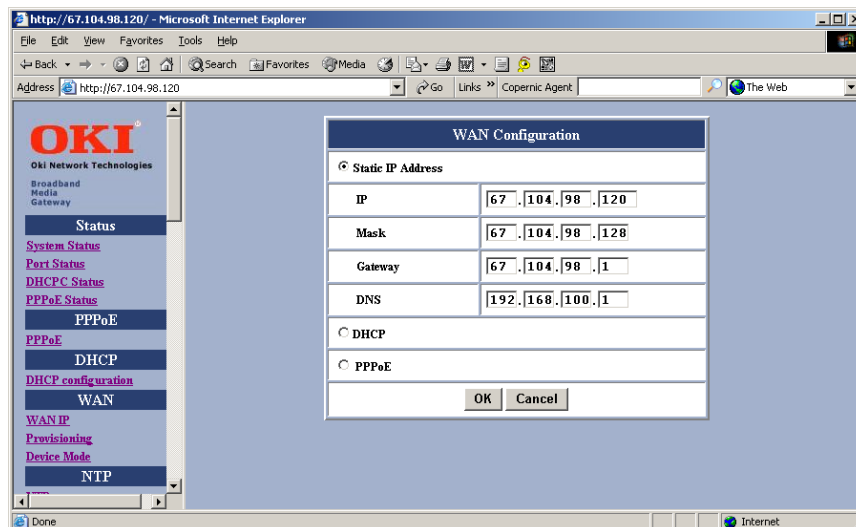

Select Static IP Address. Enter IP, Mask, Gateway, and DNS addresses supplied by Service Provider.

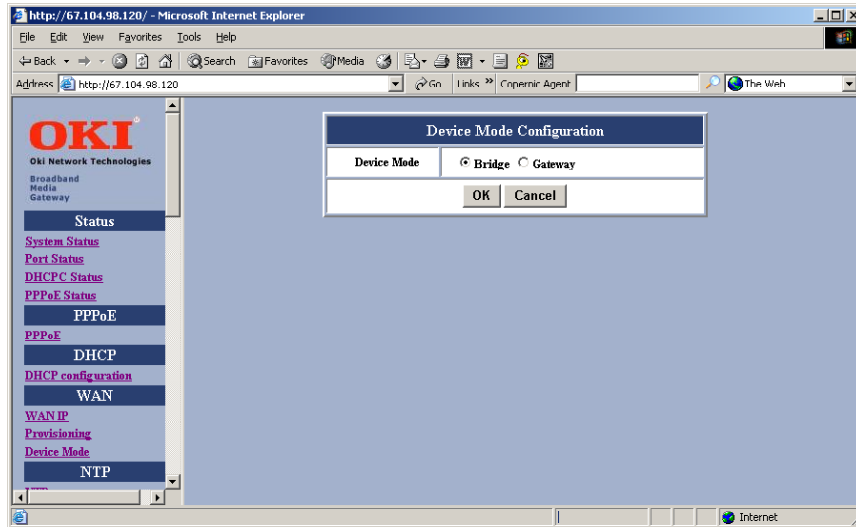

Finally, select either <Bridge> or <Gateway> within the Device Mode Configuration setup screen. SAVE configuration settings.

2.5 Installation Overview For ADSL and Cable Networks

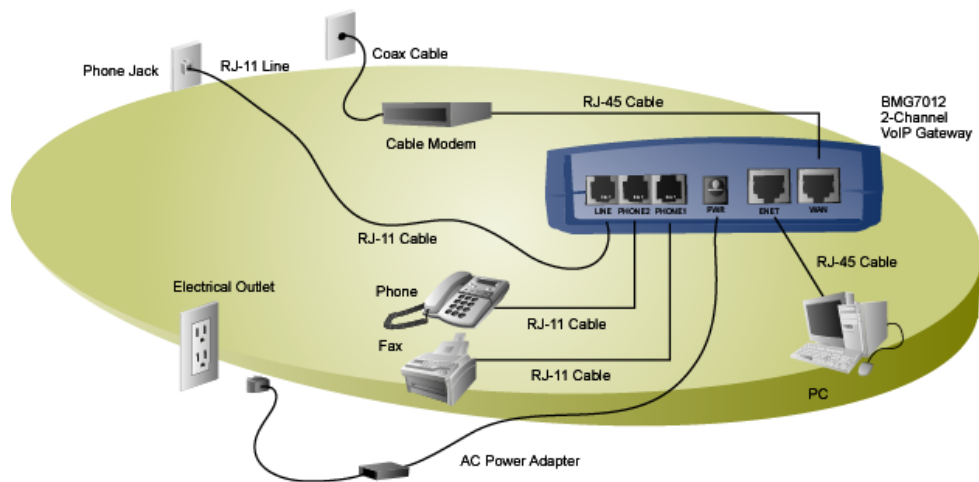

Example DSL installation

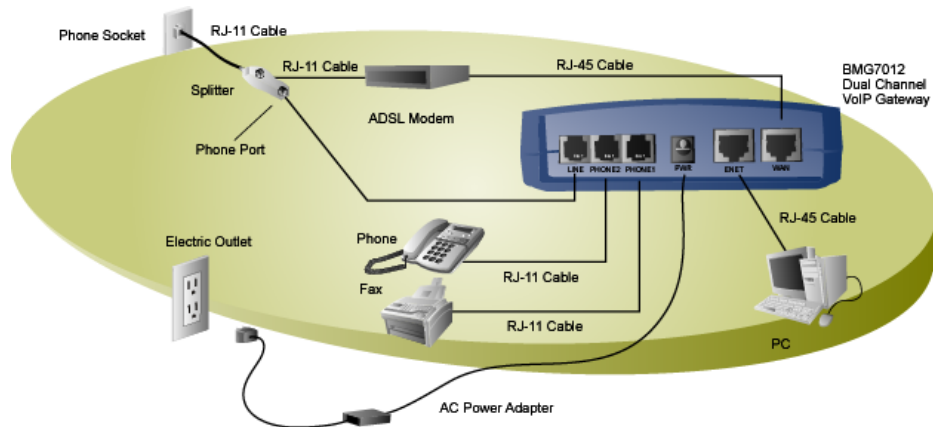

Example Cable installation

Figure 3: Installation Diagrams

1. **WAN:** Plug one end of the RJ-45 Ethernet cable into the WAN port and plug the other end into the Ethernet port of the Internet service device, such as the cable modem or ADSL modem. Then connect the cable modem or ADSL modem to the modem port of the splitter using a RJ-11 telephone line.
2. **PHONE1 & PHONE2:**
Plug one end of the RJ-11 telephone cable into the PHONE1 or PHONE2 port and plug the other end into the phone socket on a telephone set.
3. **LINE:** (optional)
ADSL: Plug one end of the RJ-11 telephone cable into the LINE port and plug the other end into the phone port of the splitter. Then connect the splitter to the phone socket in the wall using a RJ-11 telephone cable.
Cable: Plug one end of the RJ-11 telephone cable into the LINE port and plug the other end into the phone socket in the wall.

The LINE port is for back-up use allowing for direct connection to the PSTN (Public Switched Telephone Network). If the BMG7011 and BMG7012 VoIP gateways lose WAN connection or the VoIP function is not available, the BMG7011 and BMG7012 will allow the analog telephone to access the PSTN service.
4. **ENET:** (optional)
Plug one end of the RJ-45 Ethernet cable into the ENET port and plug the other end into the Ethernet socket of NIC on your PC. (Optional for the PC to connect to the Internet.)
5. **PWR:**
Plug one end of the power adapter into the PWR port and plug the other end into an electric outlet on the wall.

3. Web Interface Screen Descriptions

The following pages contain brief descriptions of each web page and its functions within the web based configuration web server. To apply any setting altered on any page, click **OK**. To clear values entered on the screen, click **Reset**. Changing to another screen without clicking **OK** will not save the settings you have made. Remember to click **OK** before browsing screens or your configuration will be ignored.

Note: After making all necessary settings, you need to save the configurations and then reboot the BMG to make the new settings take effect.

Resetting to Default (firmware v01.04.01 or higher)

To reset BMG settings to “default” settings, or to reset a password and if your firmware is version 01.04.01 or higher, you can use the Keypad (Analog phone connect to first port) to Reset-To-Default (dial *#123).

3.1 Status

3.1.1 System Status:

The setup screen, example below, will be displayed when you first connect. This screen contains Board ID, Firmware Version, Web UI Version, and MAC Address.

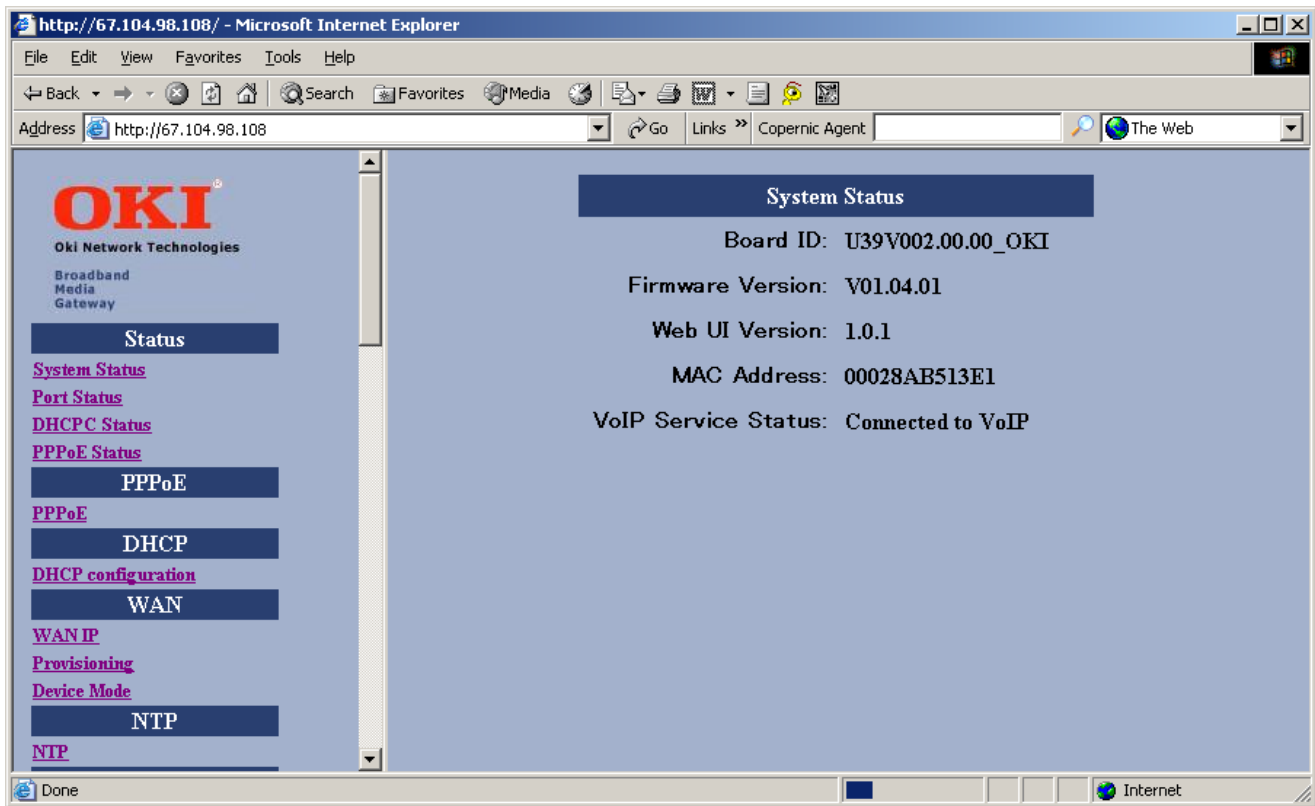

Figure 4 – System Status Window

Item	Description
Board ID	Board ID is used to identify the unit and upgrade the firmware
Firmware Version	Specifies the installed firmware version.
Web UI Version	Specifies the current Web User Interface version.
MAC Address	Specifies the unique hardware address of the BMG7011 and BMG7012 VoIP Gateways. Used for automated provisioning
VoIP Service Status	Specifies VoIP service status

3.1.2 Port Status:

You can check the status of all I/O ports by clicking **Port Status**.

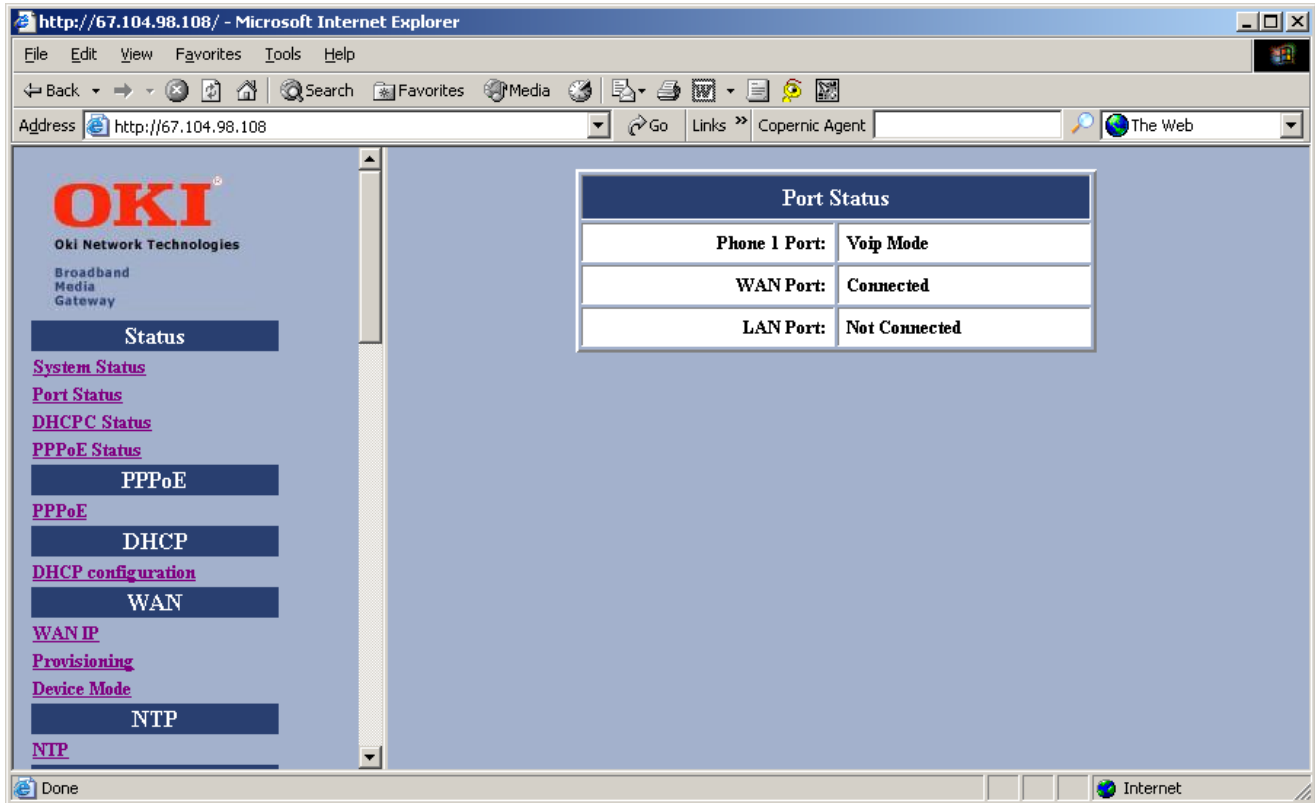

Figure 5 – Port Status Window

Item	Description
Phone 1 Port	Shows phone status either VoIP mode or PSTN mode (PSTN mode when VoIP is not available)
Phone 2 Port	Shows phone status either VoIP mode or PSTN mode (PSTN mode when VoIP is not available)
WAN Port	Shows WAN Link status either connected or not connected
LAN Port	Shows LAN Link status either connected or not connected

3.1.3 DHCP Status:

If you enable **DHCP** mode, you can see the status by clicking **DHCP Status** (“C”-connection).

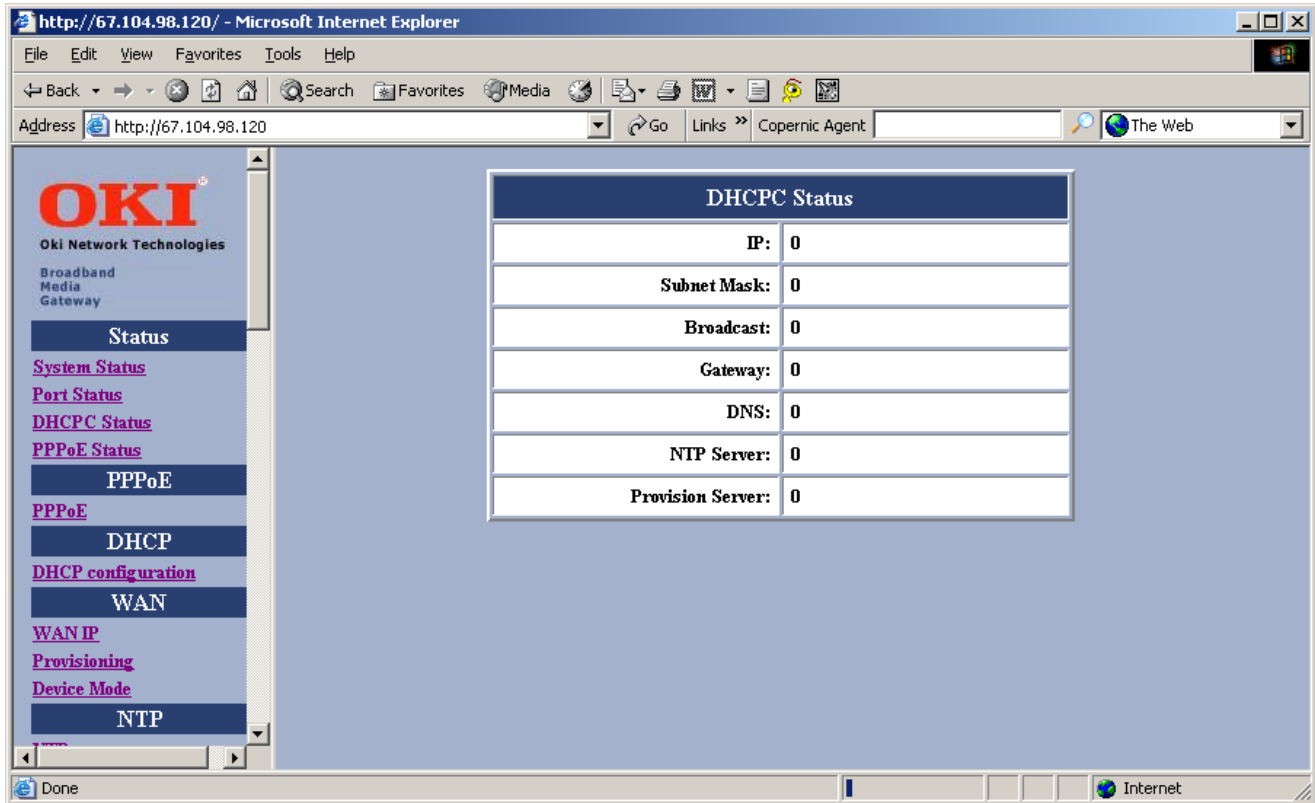

Figure 6 – DHCP Status Window

Item	Description
IP	Assigned IP Address assigned by DHCP server for this unit
Subnet Mask	Subnet Mask
Broadcast	Broadcast
Gateway	Default Gateway
DNS	DNS Address
NTP Server	IP Address of NTP Server.
Provision Server	IP Address of Provision Server.

3.1.4 PPPoE Status:

If you enable **PPPoE** mode for WAN, you can see the status by clicking **PPPoE Status**.

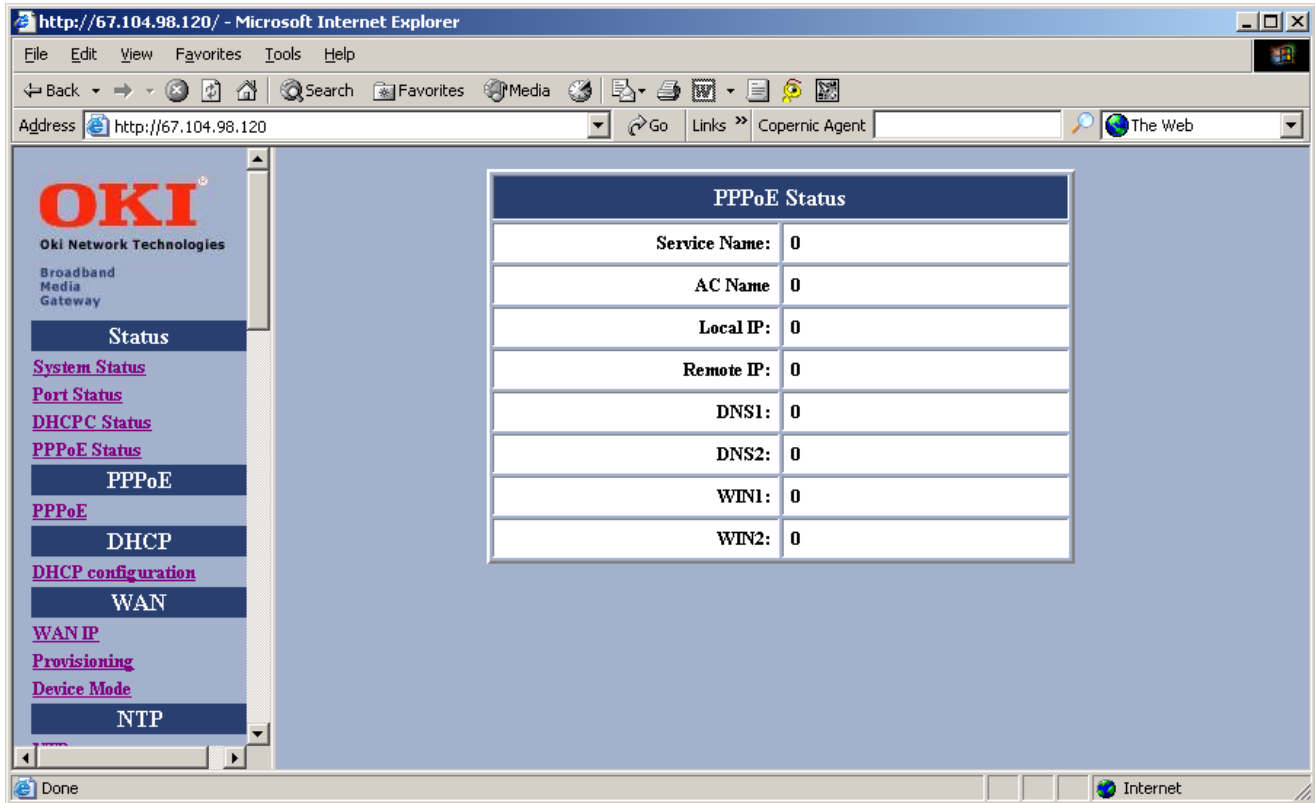

Figure 7 – PPPoE Status Window

Item	Description
Service Name	Service name assigned by PPPoE for this unit
AC Name	Server name assigned by PPPoE for this unit
Local IP	IP address
Remote IP	Server IP address.
DNS1	DNS IP address (Primary)
DNS2	DNS IP address (Secondary)
WIN1	WIN address (Primary)
WIN2	WIN address (Secondary)

3.1.5 PPPoE Configuration:

If you select **PPPoE** to get WAN IP Address of the BMG7011 and BMG7012 VoIP gateways, you need to enter the **User name** and **Password** provided by your ISP.

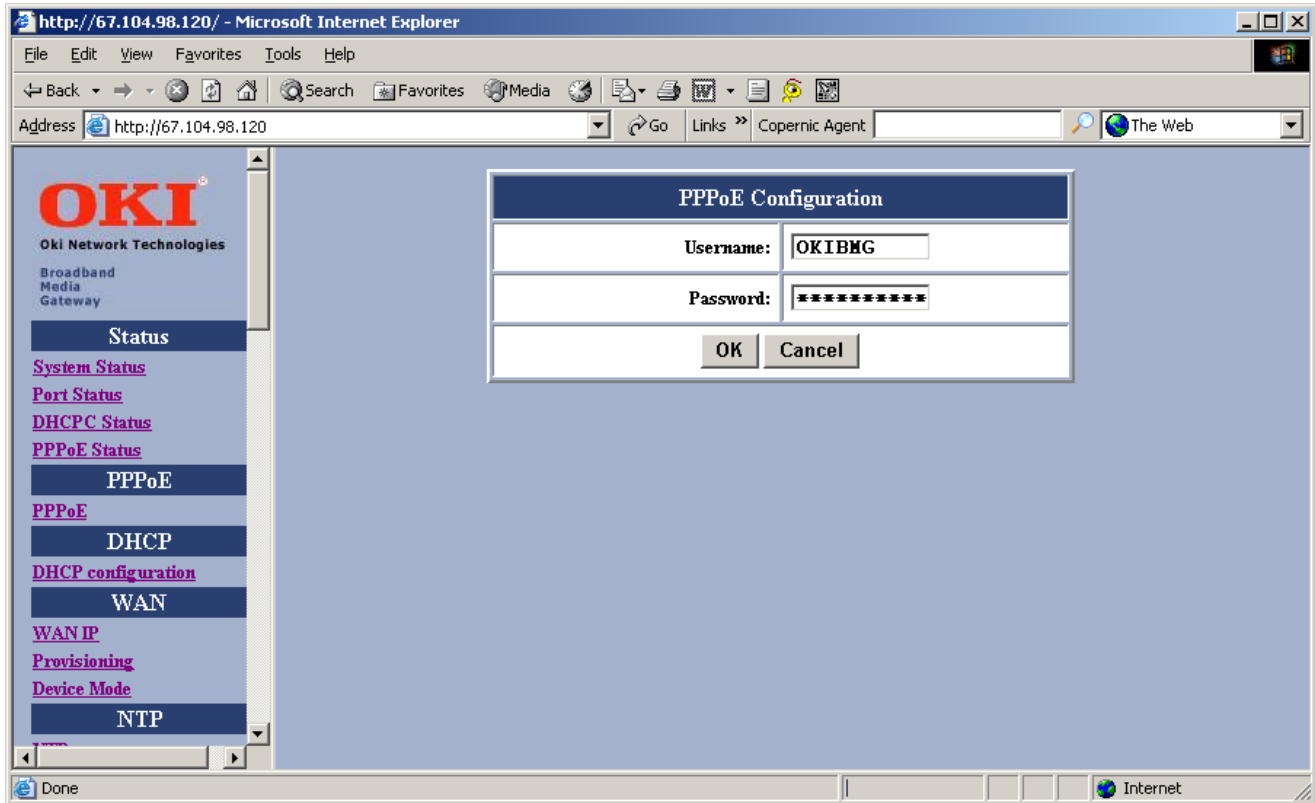

Figure 8 – PPPoE Configuration Window

Item	Description
Username	Provide username obtained from your ISP
Password	Provide password obtained from your ISP

3.2 DHCP Server Configuration

3.2.1 DHCP Configuration

If the device mode is gateway mode, we support DHCP Server on LAN side to assign IP address, etc. to the PC(s) connected to the LAN port. You can set the Status, Last IP and Mode etc. on this page. After you make the settings, click **OK** for the settings to immediately take effect.

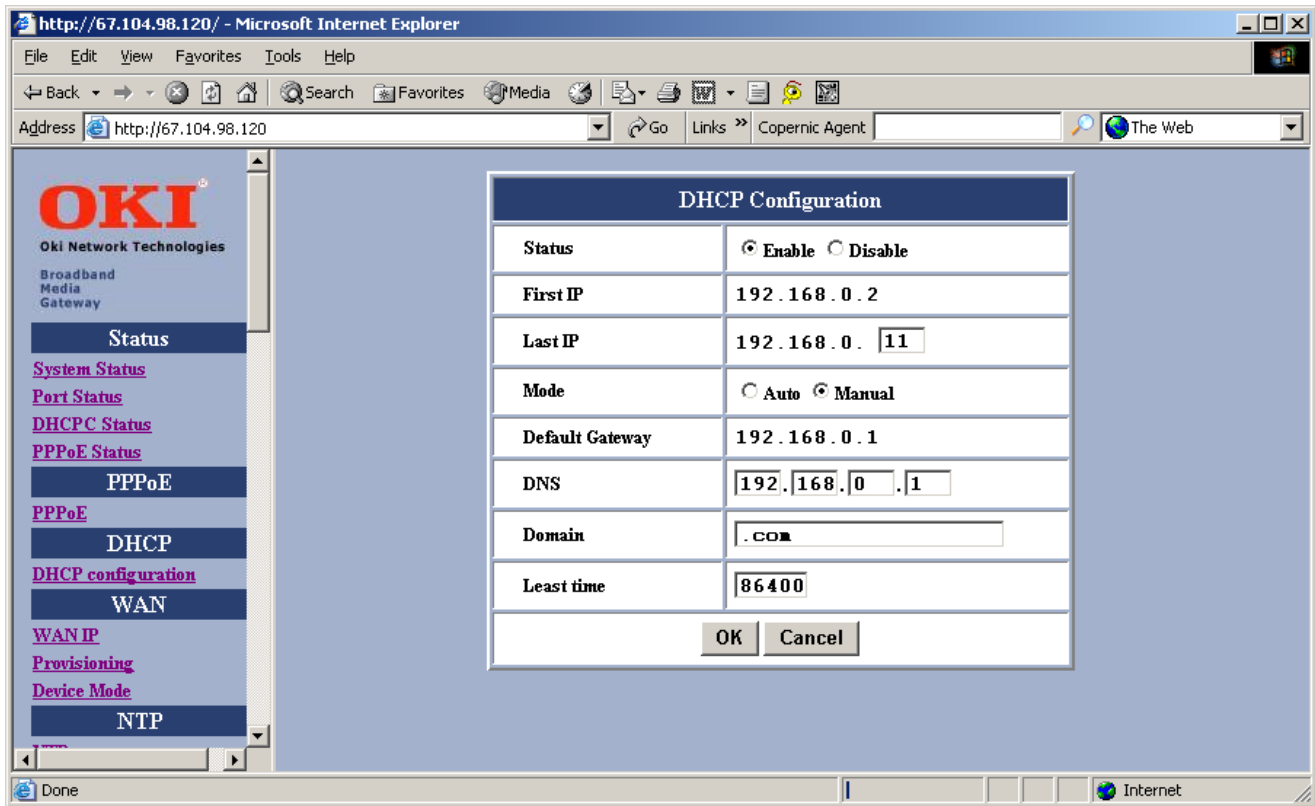

Figure 9 – DHCP Configuration Window

Item	Description
Status	The DHCP Server is enabled or disabled.
Last IP	The last IP can be assigned by the DHCP server.
Mode	The network settings assigned to the DHCP Client is Auto mode or Manual Mode. In Auto mode, the DNS settings are from the WAN side. In Manual mode, the DNS settings are from the user's input in this page.
DNS	You can manually set the value in Manual mode or it takes the value from WAN side in Auto mode.
Domain	You can manually set the value in Manual mode or it takes the value from WAN side in Auto mode.
Least time	The least time of the DHCP client to holding the network settings. The value is useful in Auto mode.

3.3 WAN Configuration

3.3.1 WAN IP

You can select the method to obtain the IP address of the VoIP Gateway by selecting one of the following modes. After the BMG is rebooted, the settings you have made will take effect.

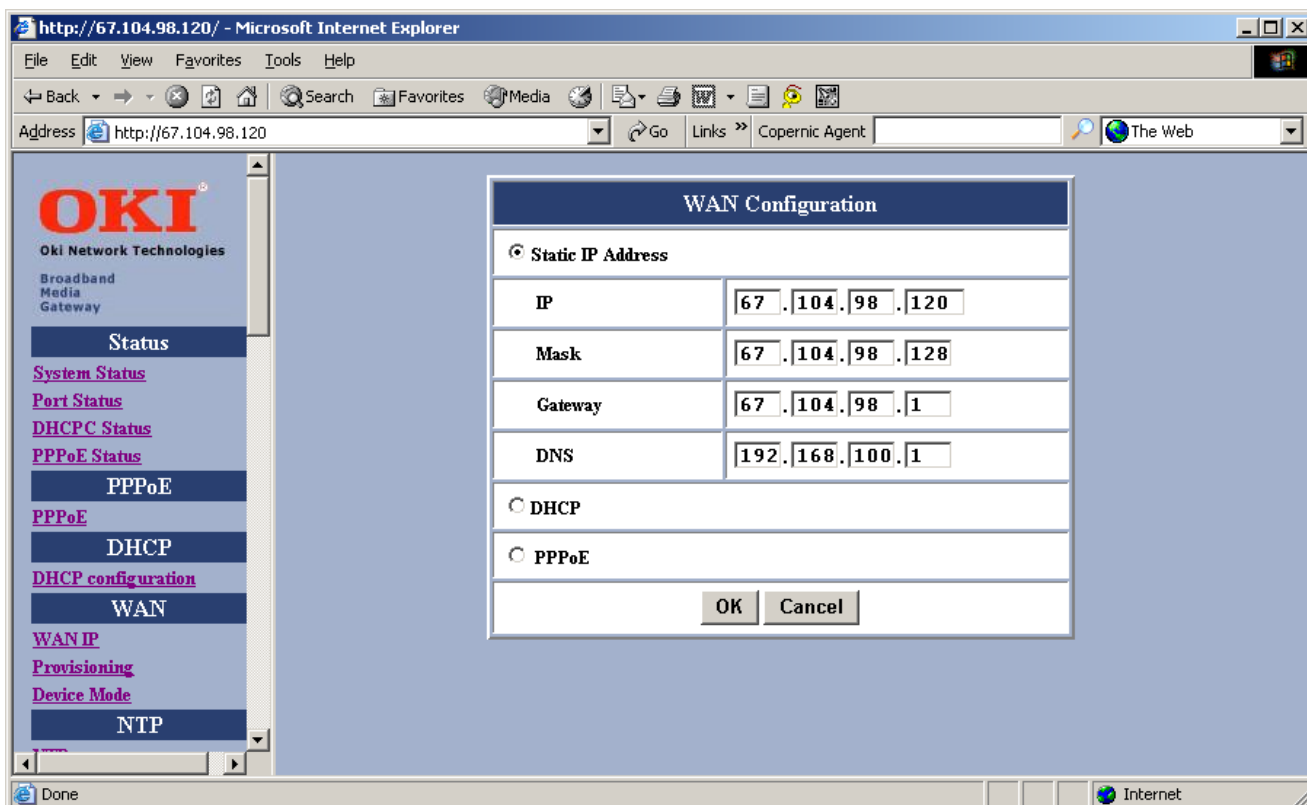

Figure 10 – WAN Configuration Window

Item	Description
Static IP Address	The IP address of the WAN side is assigned by the user.
IP	The IP address of the WAN side for static IP assignment
Mask	The subnet mask of the WAN side for static IP assignment
Gateway	The IP address of the default Gateway of WAN side for static IP assignment
DNS	The IP Address of Domain Name Server of WAN side for static IP assignment
DHCP	The IP Address of the WAN side is assigned by the ISP's DHCP server
PPPoE	The IP Address of the WAN side is assigned by ISP's PPPoE server

3.3.2 Remote Provisioning

If the **Provisioning** is **off**, telnet and http access from WAN port is blocked. This function is only active in gateway mode.

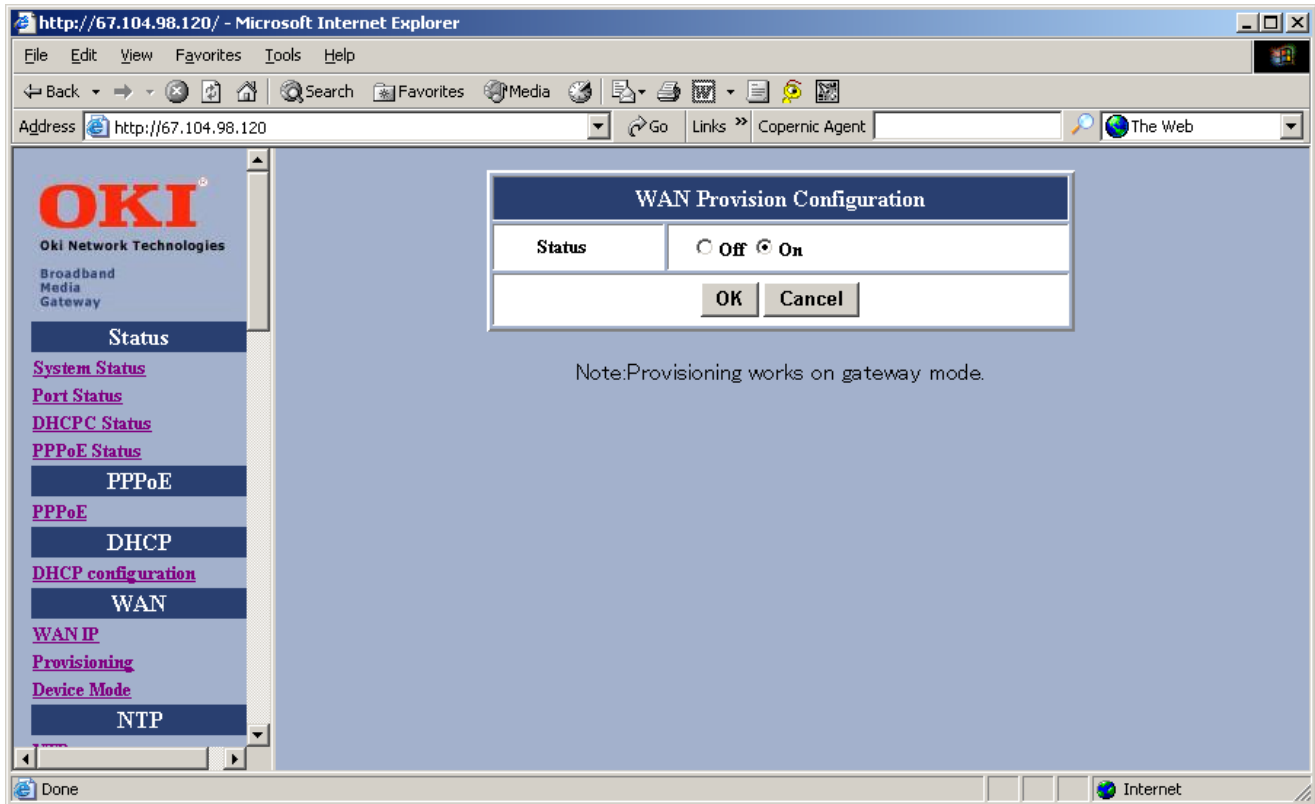

Figure 11 – Provisioning Configuration Window

Item	Description
Status	Turn Off or On remote provisioning
	Caution: Be careful, once remote provisioning is turned “Off”, there is no way to login to the unit remotely. The only option to login to the unit is from the LAN port using default IP address 192.168.0.1

3.3.3 Device Mode

If the **Device Mode** is set to **Gateway**, NAPT is enabled. On the contrary, if **Device Mode** is set to **Bridge**, NAPT is disabled.

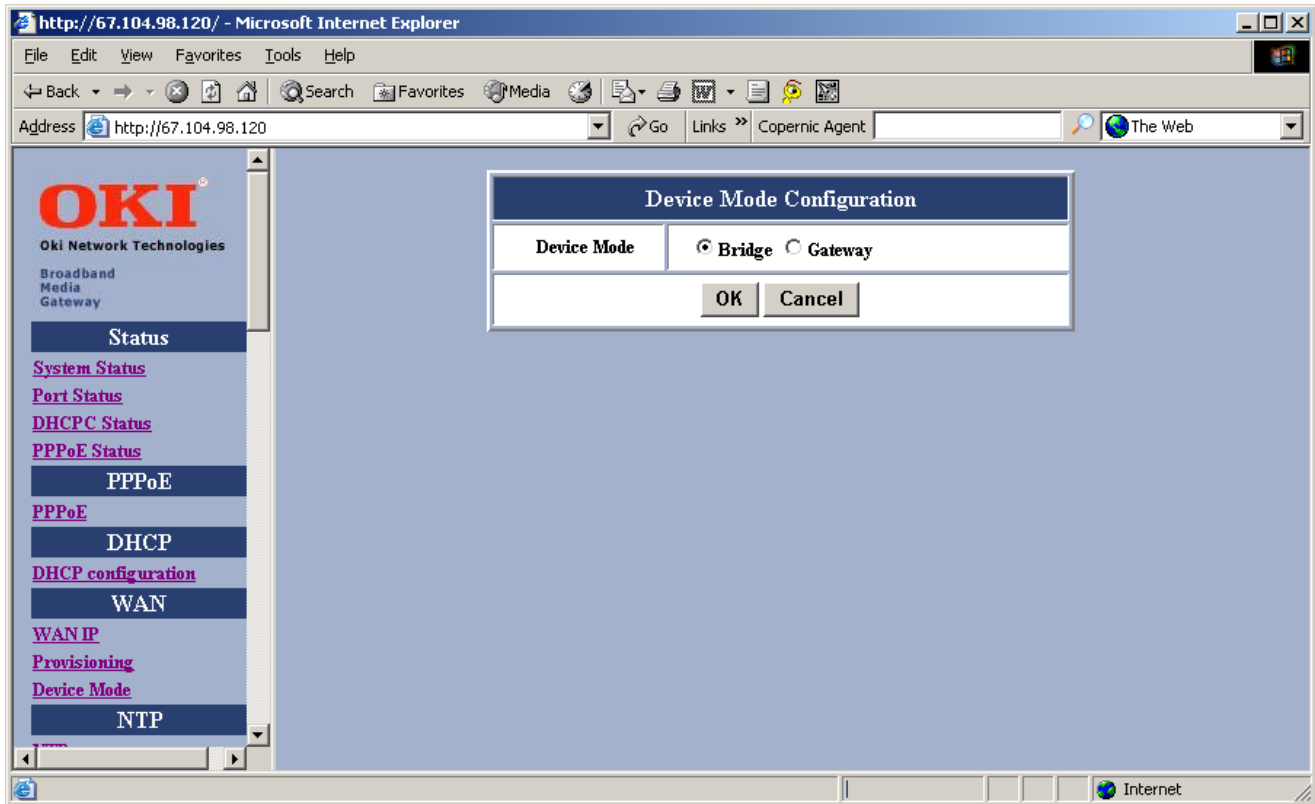

Figure 12 – Device Mode Configuration Window

Item	Description
Device Mode	Select Bridge mode or Gateway mode

3.4 NTP

3.4.1 NTP

Network Time Protocol used for setting gateway configurations to obtain time information from a public network timeserver. (example: 198.123.30.132)

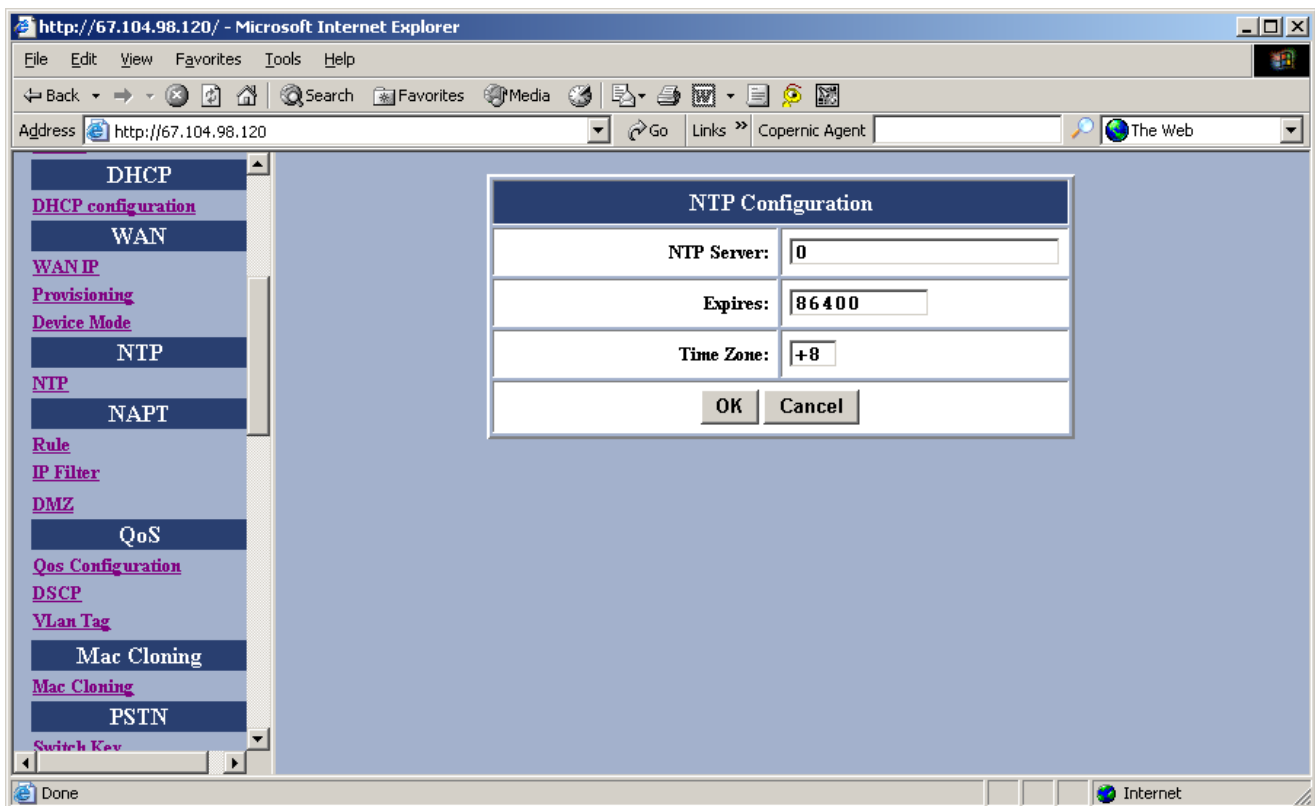

Figure 13 – Device Mode Configuration Window

Item	Description
NTP Server	Set IP Address
Expires	Time designated for re-query. Expiration set in seconds
Time Zone	Geographical time zone based on GMT

3.5 NAPT Configuration

3.5.1 Port Forwarding

You can add or delete **Port Forwarding Rule** to the device in **Gateway mode**. When the packet travels through the gateway, if the port of the packet matches the port of port-forwarding rule, then packet will be forwarded to the private IP address configured of the matched rule.

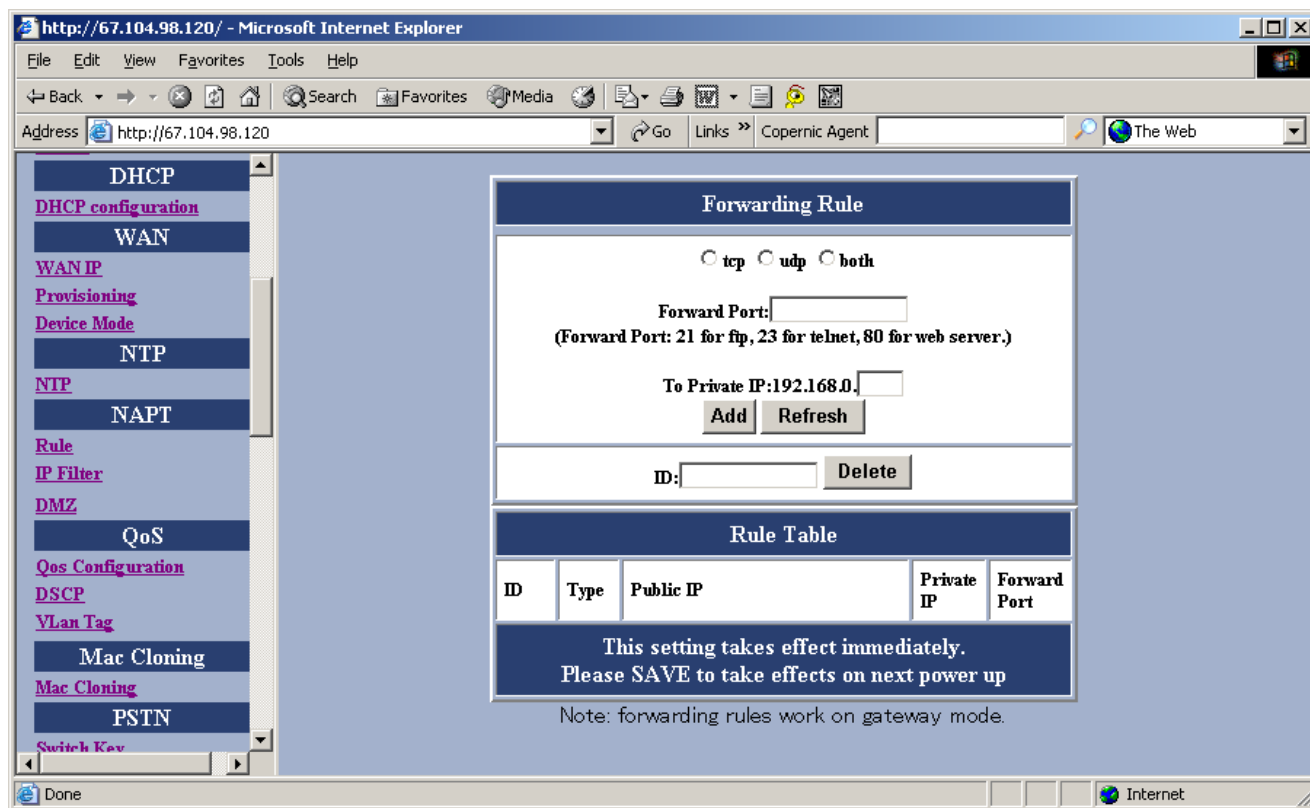

Figure 14 – Port Forwarding Rule/Rule Table Window

Item	Description
Tcp/udp/both	Select if you want to forward the packet based on tcp, udp or both
Forward Port	The tcp or udp port number for which you want to forward
To Private IP	The IP Address of the pc in the LAN side is forwarding to
ID	The ID of the port forwarding rule is to be deleted
Rule Table	Maximum of 10 forwarding together with IP Filtering can be specified

3.5.2 IP Filtering

You can add or delete **IP Filter Rule** to the device in **Gateway mode**. When the packet enters the VoIP Gateway, the packet will be blocked if the source IP of the packet matches the rule of IP Filter.

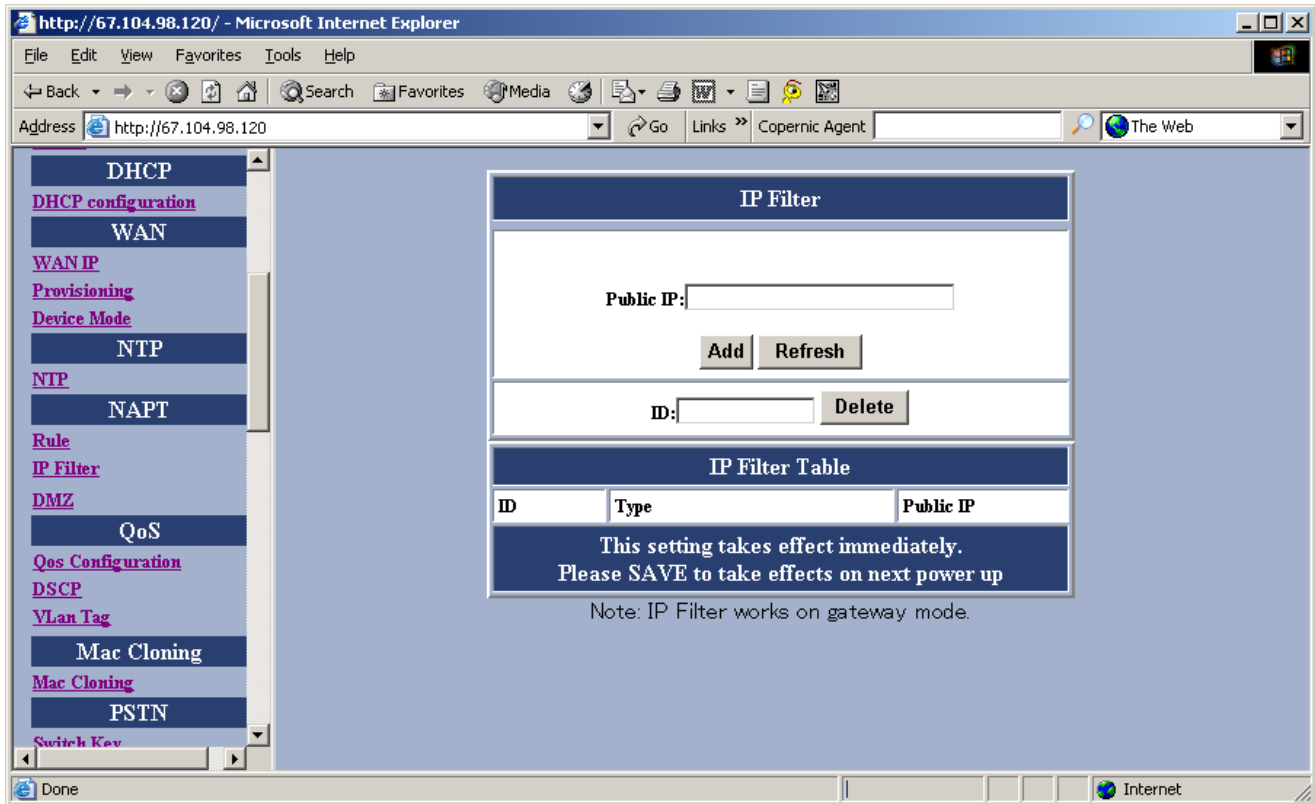

Figure 15 – IP Filter Configuration Window

Item	Description
Public IP	The Public IP Address is to be filtered.
ID	The ID of the IP Filter rule is to be deleted.
IP Filter Table	Maximum of 10 entries together with Port Forwarding can be specified.

3.5.3 DMZ

You can **enable or disable** DMZ and specify the **IP address** of DMZ in **Gateway mode**. When an unfiltered packet enters the VoIP Gateway it will be transferred to the DMZ, not port-forwarded, and not matched for the NAPT binding.

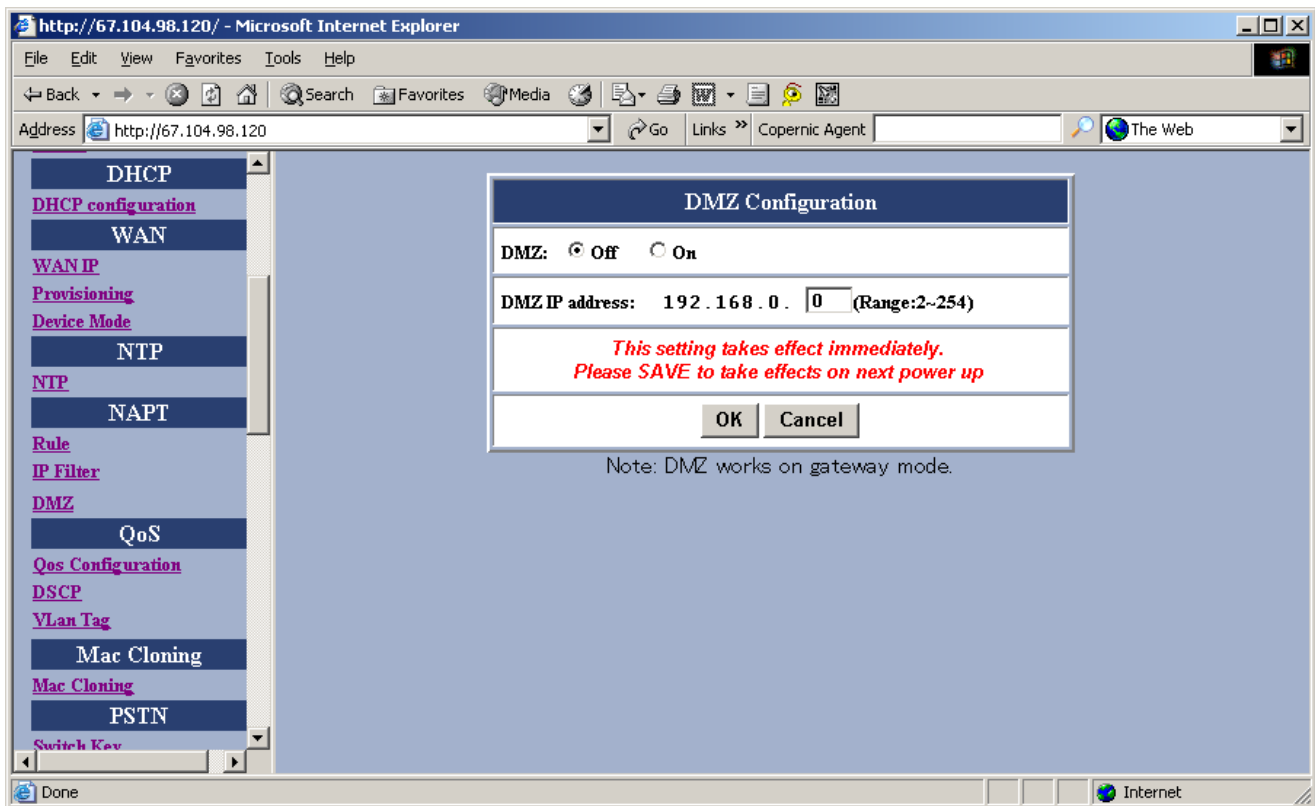

Figure 16 – DMZ Configuration Window

Item	Description
DMZ	The DMZ is disabled or enabled.
DMZ IP address	The IP address of the DMZ.

3.6 QoS

3.6.1 QoS Configuration

You can decide the **QoS type** of the packets sent out of the BMG VoIP gateway. If the type of **QoS** is DiffServ, you can also specify the different values for **Signal DSCP** and **Media DSCP**. Both ToS and DSCP QoS are supported for VoIP packets sent out from the BMG VoIP Gateway.

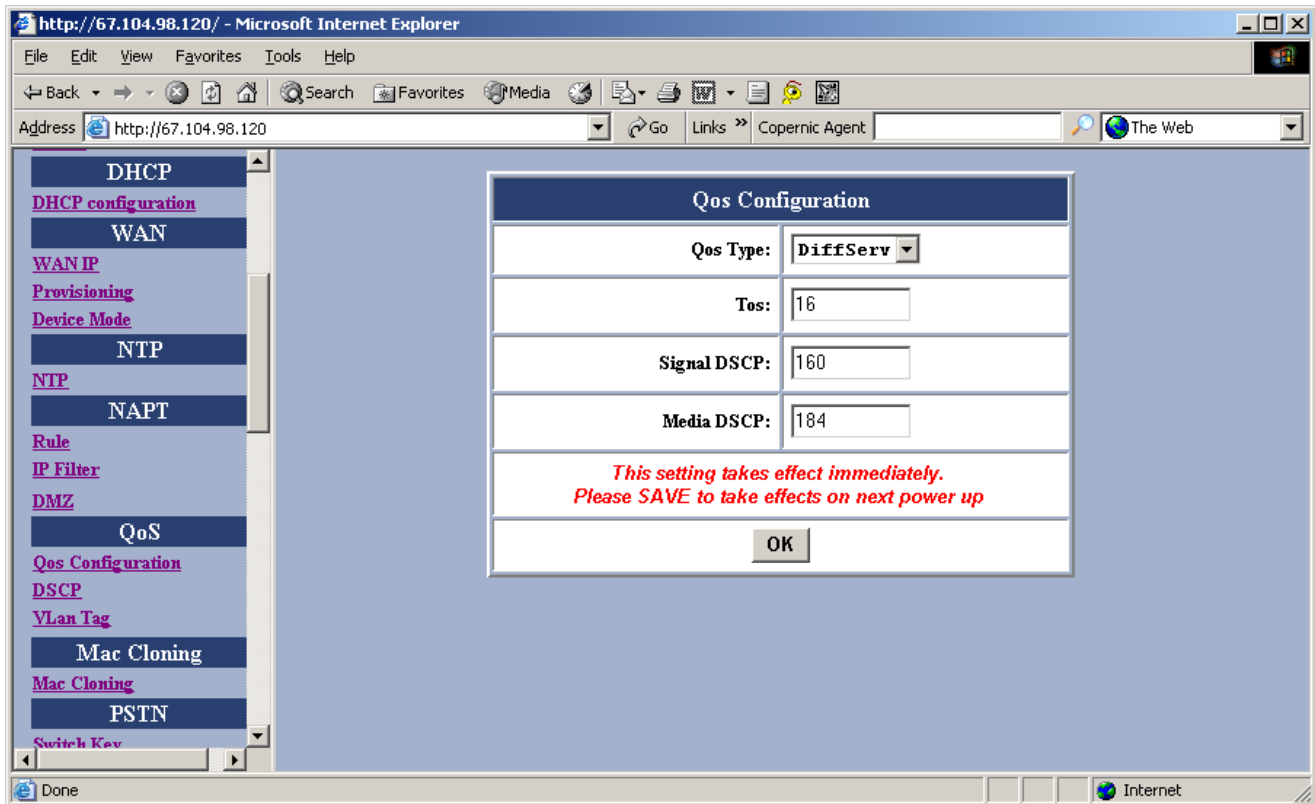

Figure 17 – QoS Configuration Window

Item	Description
QoS Type	The type of QoS can be disabled, DiffServ, or ToS.
ToS	The value of ToS is usually between 8~120.
Signal DSCP	The value of Differentiated Services Code Point for Signal. (4~255)
Media DSCP	The value of Differentiated Services Code Point for Media. (4~255)

3.6.2 DSCP Configuration

You can set the **DSCP mode** to **Trusted** or **Un-Trusted**. The **DSCP mode** of operations is supported for PC data traffic through the LAN interface. If it is set to **Trusted Mode**, the BMG will preserve the DSCP settings from the LAN interface. If it is set to **Un-Trusted mode**, the BMG will remark to DSCP **DE** before forwarding to Uplink interface.

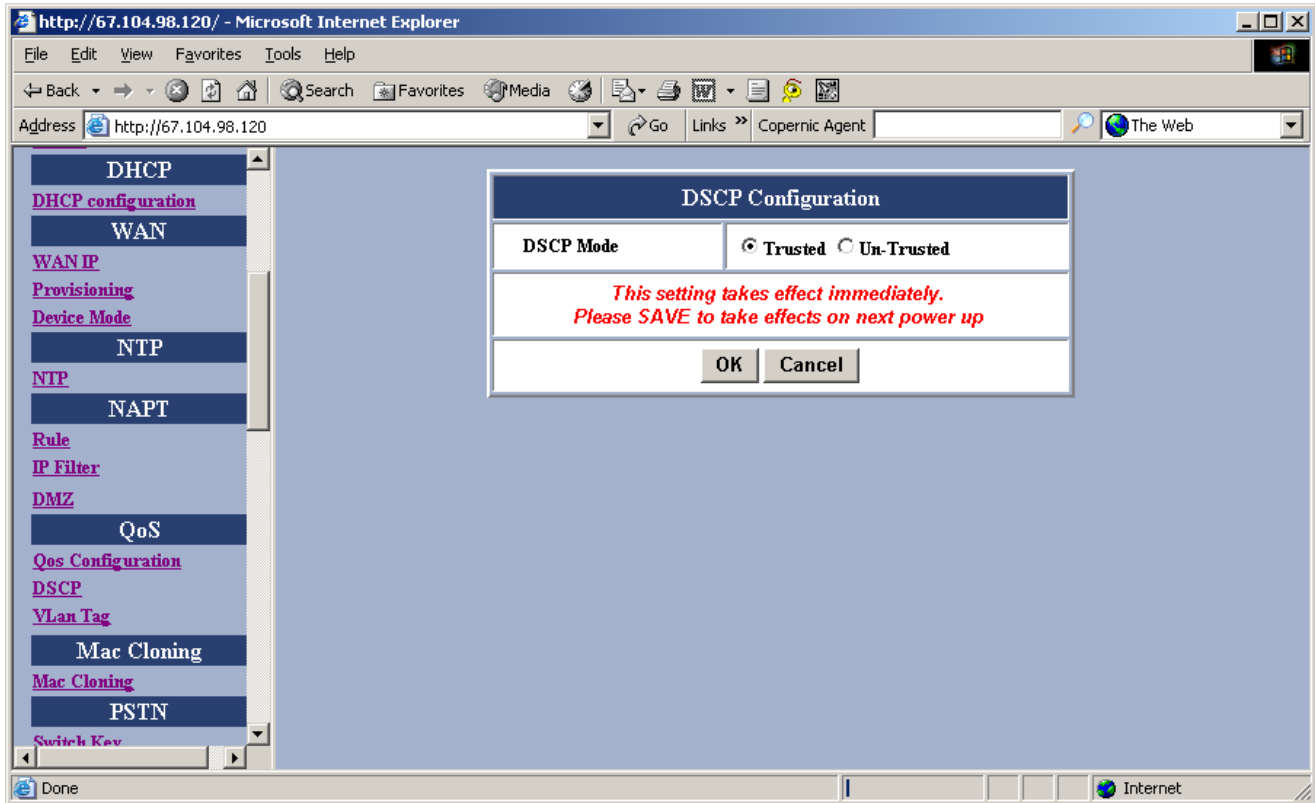

Figure 18 – DHCP Configuration Window

Item	Description
DSCP Mode	Select Trusted mode or Un-trusted mode

3.6.3 Vlan Configuration

You can enable the Vlan tag with Vlan ID and priority for Data and Voice.

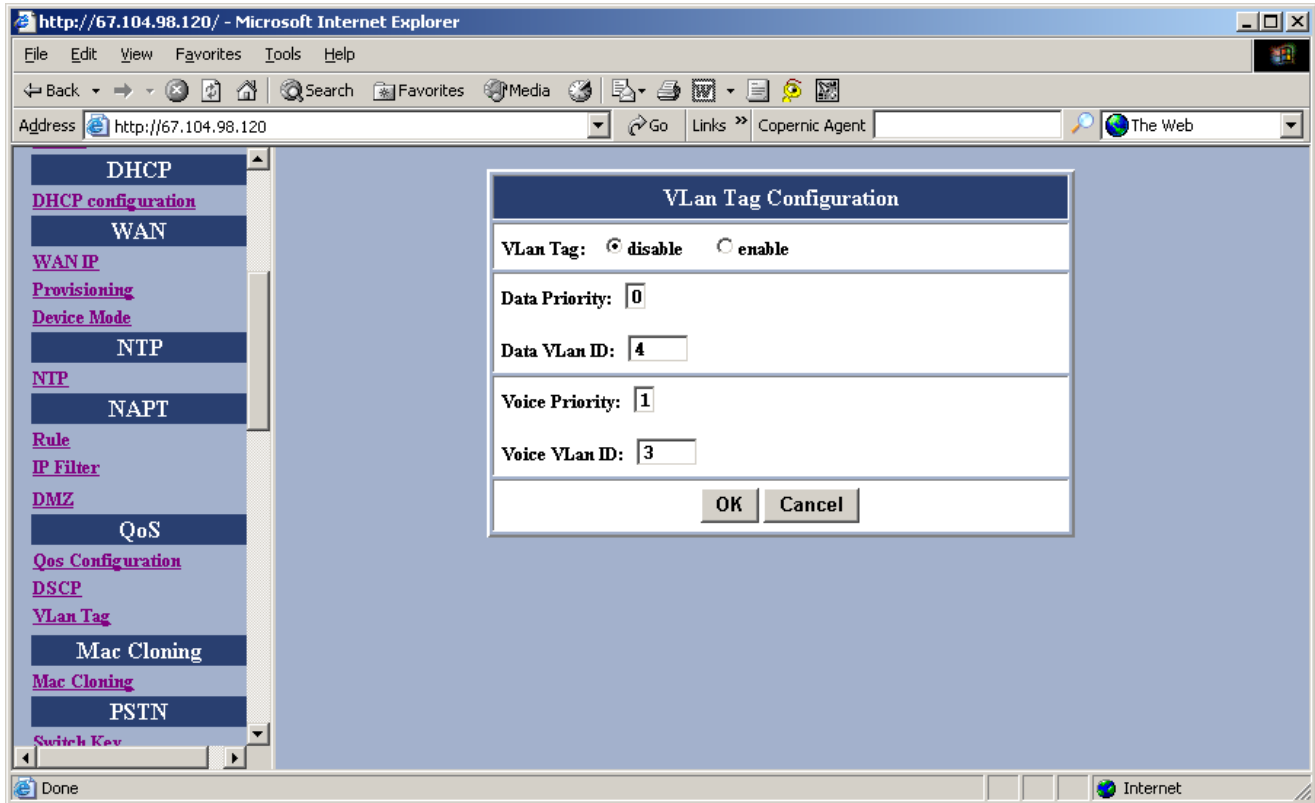

Figure 19 – DHCP Configuration Window

Item	Description
Vlan Tag	Enable VLAN mode or disable VLAN mode
Data Priority	Set Data priority between 0-7
Data Vlan ID	Set Data VLAN ID between 2~4094
Voice Priority	Set Voice priority between 0-7
Voice Vlan ID	Set Voice VLAN ID between 2~4094

3.7 Mac Cloning

This function is intended mainly for users connecting through a cable modem connection. Some ISPs require the MAC address registration of the computer behind the cable modem before connections can be established. The BMG takes the place of the computer behind the modem, and the local user can use the MAC Cloning option to enter the original PC MAC address without the need to contact the ISP.

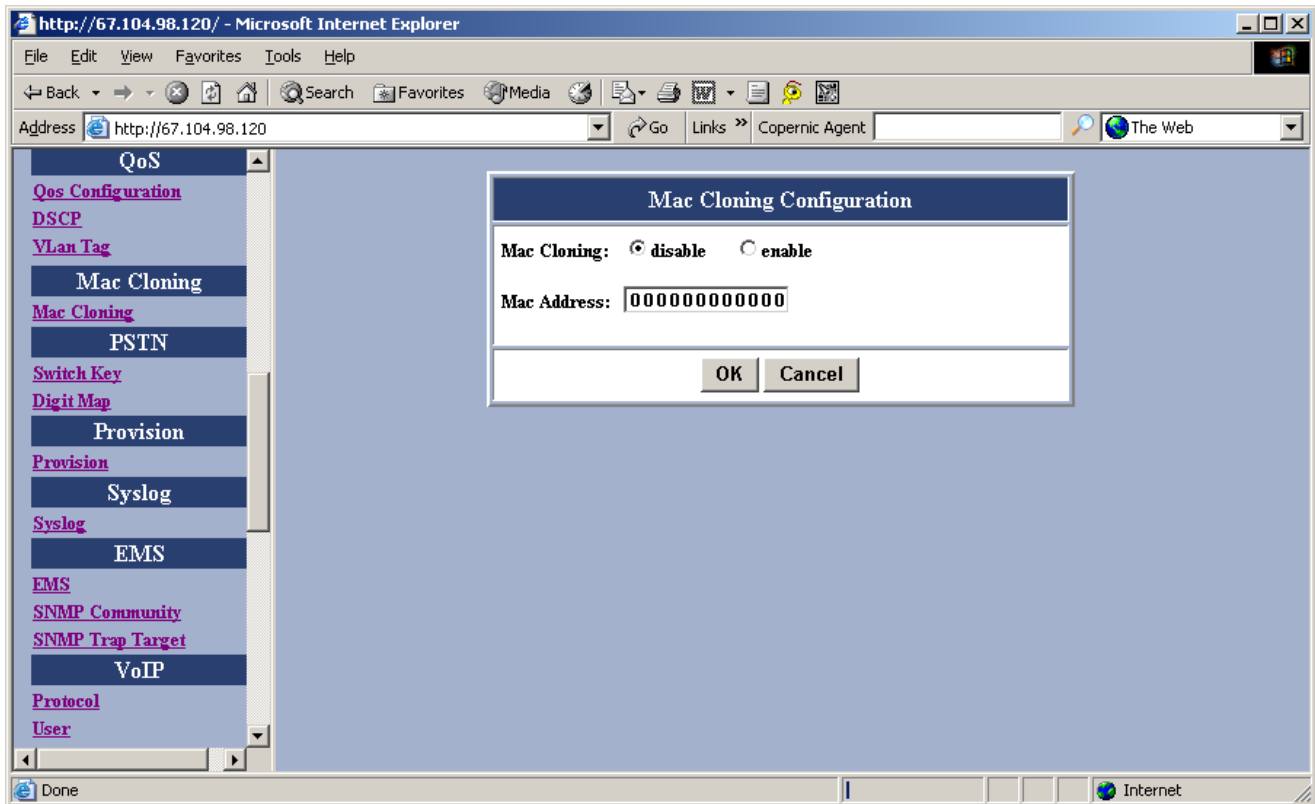

Figure 20 –Mac Cloning Window

Item	Description
Mac Cloning	Enables MAC Cloning mode or disables MAC Cloning mode
Mac Address	Specify the MAC address for MAC spoofing.

3.8 PSTN Configuration

3.8.1 Switch Key

This functions allows user to set PSTN switch number. User can switch VoIP mode to PSTN mode by entering a 4-digit entry. "0000" is the default value. In the event IP service from provider is down, or to make calls via the PSTN network, users can enter four-digit code and instantly make calls over PSTN.

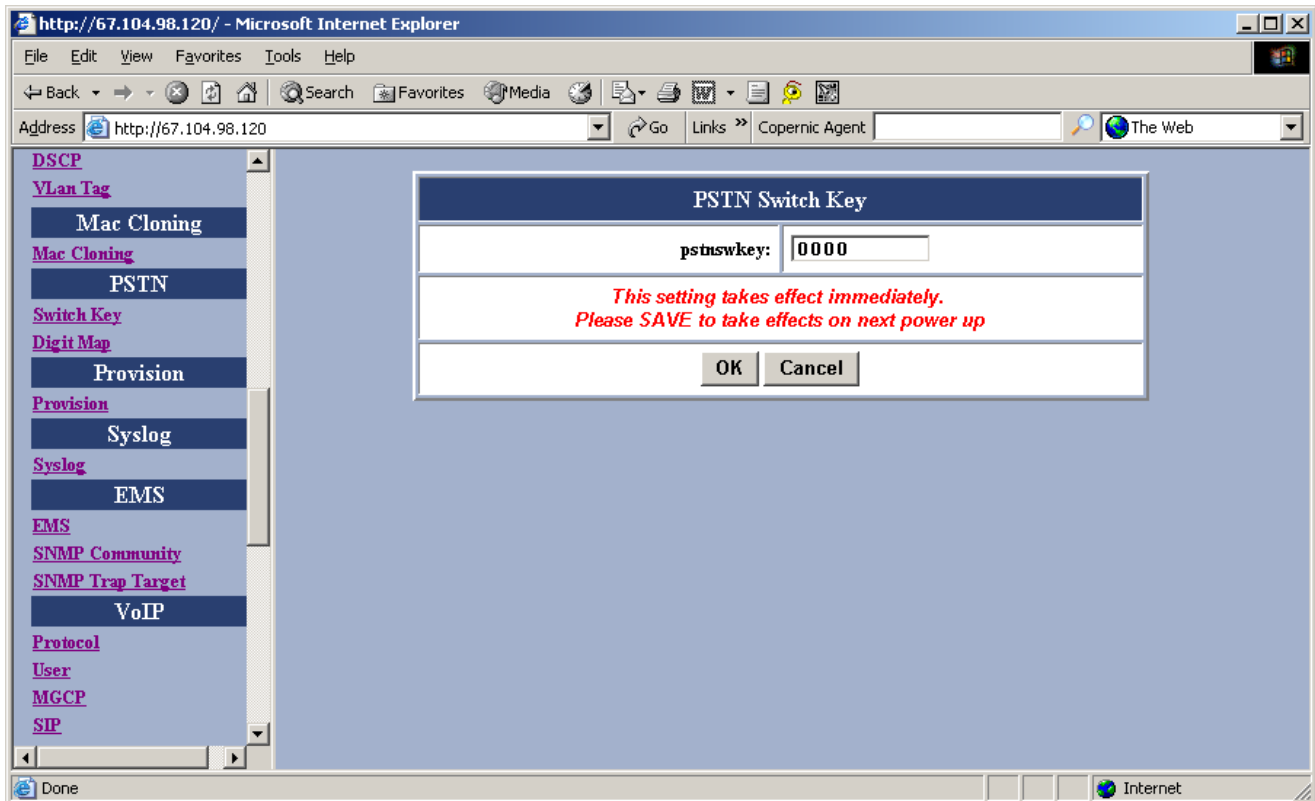

Figure 21 –PSTN Switch Key Window

Item	Description
PSTNKEY	Specify digit for immediate PSTN Access

3.8.2 Digit Map

This function allows user to set the Digit Map. User can set up a list of numbers with specific prefix and total length of phone number to switch from VoIP mode to PSTN mode. When user enters in specific, predefined phone numbers, the BMG gateway will automatically send these calls over the PSTN.

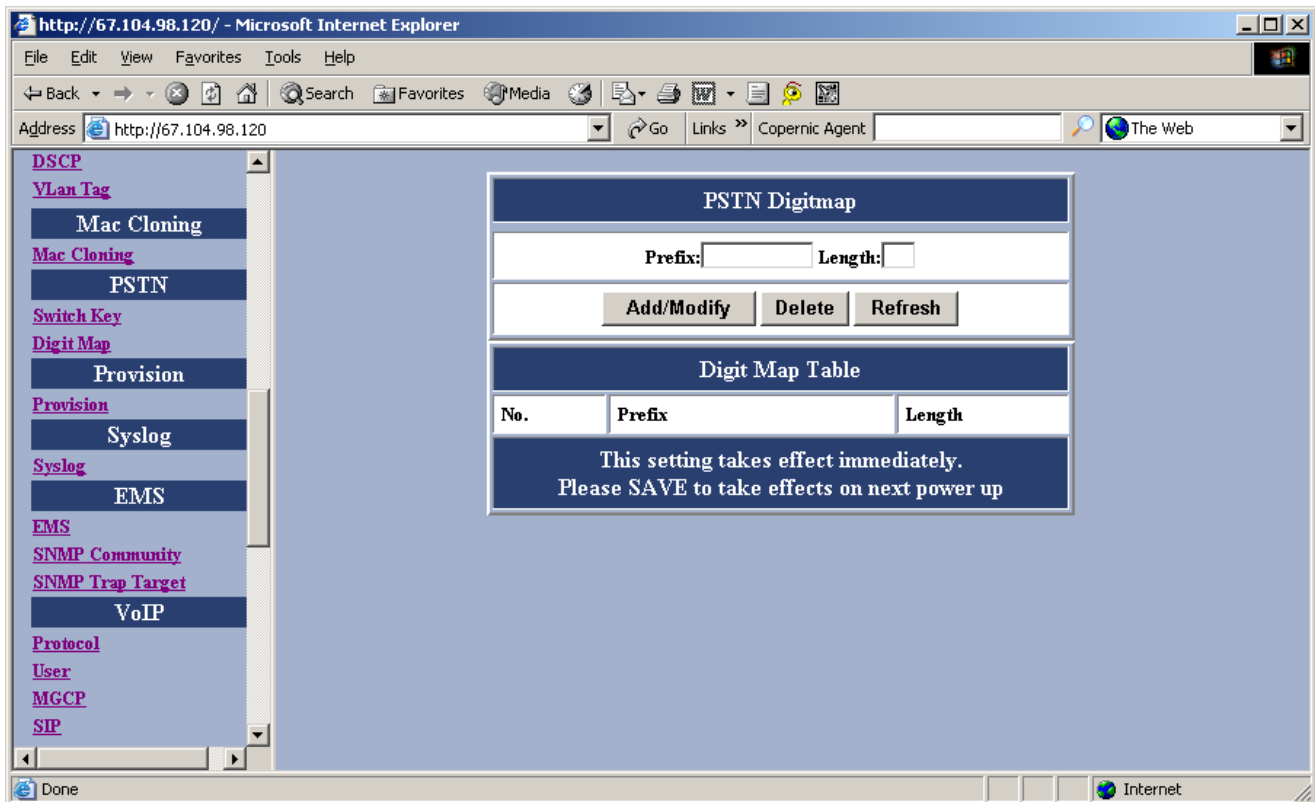

Figure 22 –PSTN Digitmap Window

Item	Description
Prefix	Enter the prefix of the telephone number. The maximum length is 15 digits.
Length	Enter the total length of the telephone number. The length is ranged from 0~64. "0" means the length is not fixed.
Add/Modify	Add or modify your desired prefix and length of the telephone number with 15 maximum entries
Delete	Delete an existing prefix and length of the telephone number from the Digit Map Table
Refresh	Press this button will show new changes

3.9 Provision Configuration

The BMG7011/ 7012 gateways support a Provisioning Configuration mechanism to set the gateway configuration parameters. When the Gateway downloads the configuration file from the Provisioning server, it will compare the downloaded parameters and existing local parameters. If the former is newer, the existing local setting parameters will be overwritten and the downloaded setting parameters will be written into the FLASH memory. This feature sets Provision Configurations including server address, server port number, group, and expiry time. **Save and Reboot.**

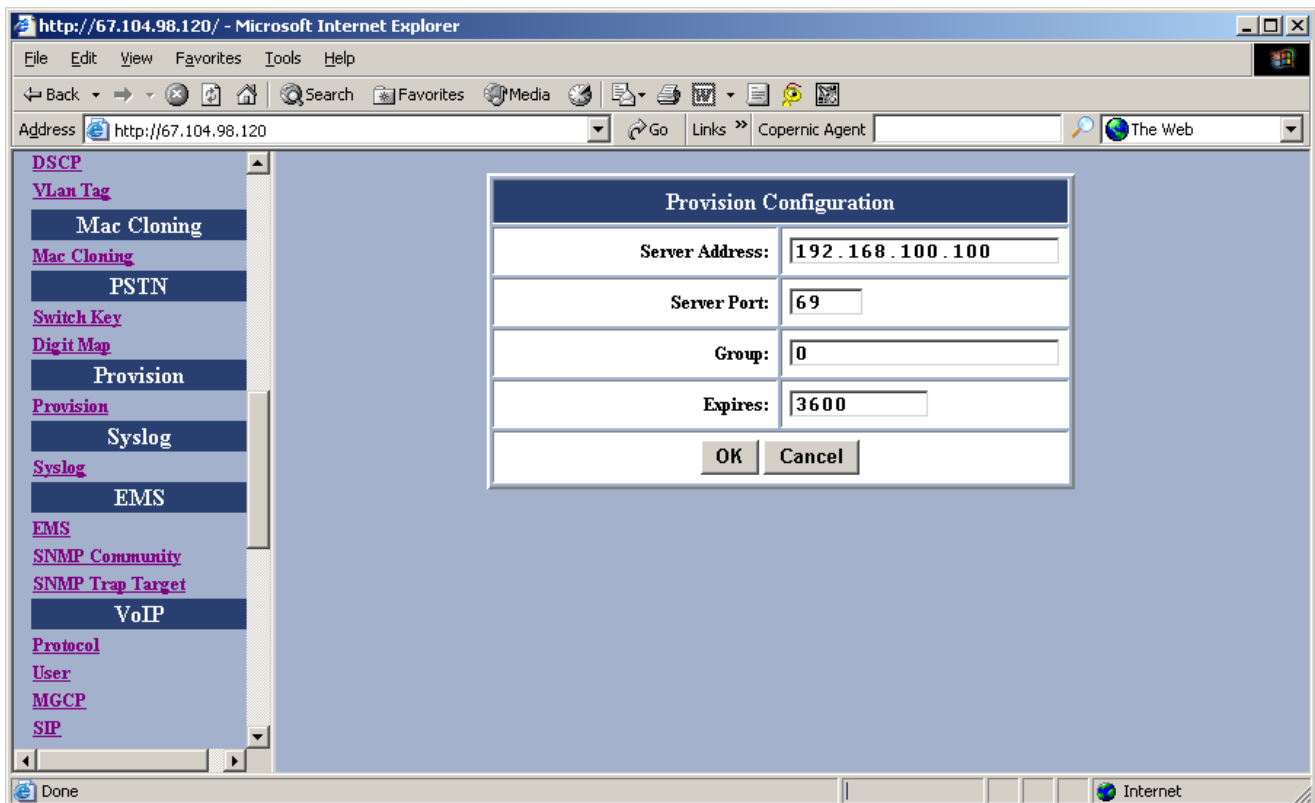

Figure 23 –Provision Configuration Window

Item	Description
Server Address	The IP Address of Provision Server. Enter the address provided by your ISP.
Server Port	The receiving port number of Provision Server. Enter the value provided by your ISP.
Group	Enter the string for different user group. The maximum length is 64. Enter the value provided by your ISP.
Expires	Periodic time in seconds to check new update for configuration to provisioning server. Enter the value provided by your ISP.

3.10 Syslog Configuration

The BMG7011/ 7012 VoIP gateway supports **Syslog**. Syslog is used to send UDP packets via Syslog port (514) and keep messages in the Log Server.

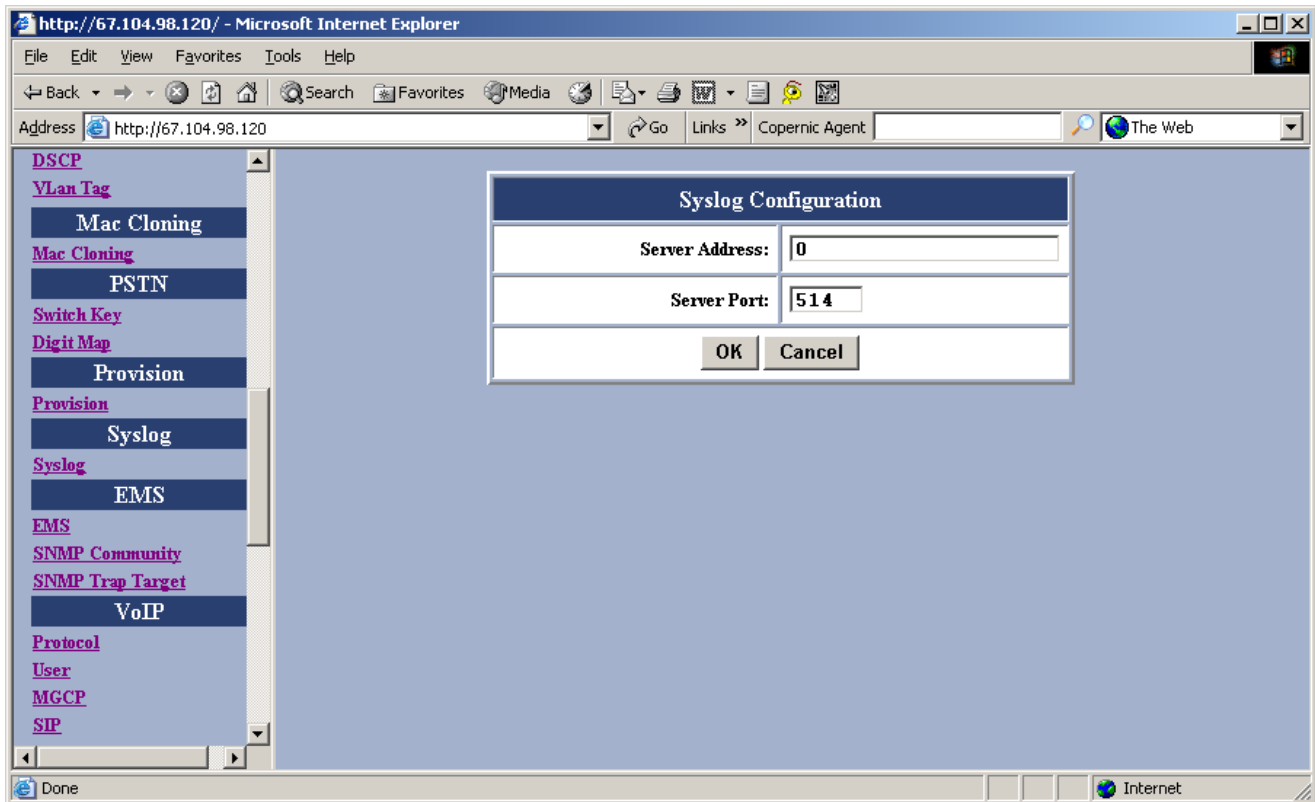

Figure 24 –Syslog Configuration Window

Item	Description
Server Address	Specify the IP Address of Syslog server.
Server Port	Specify the port number of Syslog server.

3.11 EMS Configuration

3.11.1 EMS

This VoIP gateway supports EMS management function. Users can set the EMS configuration including Server Address, Server Port, Community, and expiration time.

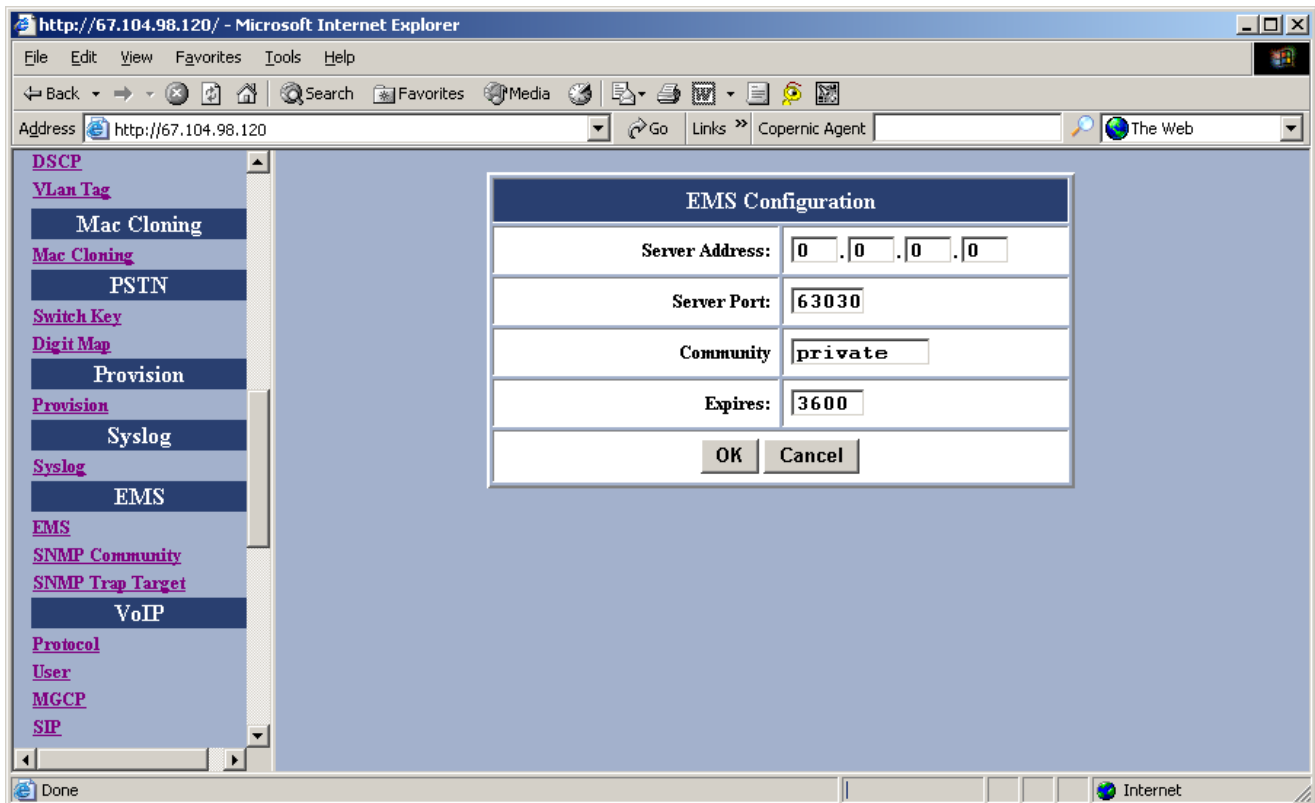

Figure 25 –EMS Configuration Window

Item	Description
Server Address	Specifies the IP address of EMS server
Server Port	Specifies the Port number of EMS Server
Community	Specifies the Community used to EMS Server
Expires	Specifies the valid period of the VoIP gateway managed by EMS Server. The unit is second.

3.11.2 SNMP Community

The BMG7011/ 7012 VoIP Gateway supports SNMP agent. Users can use EMS to manage the VoIP Gateway via SNMP protocol. **Save and Reboot.**

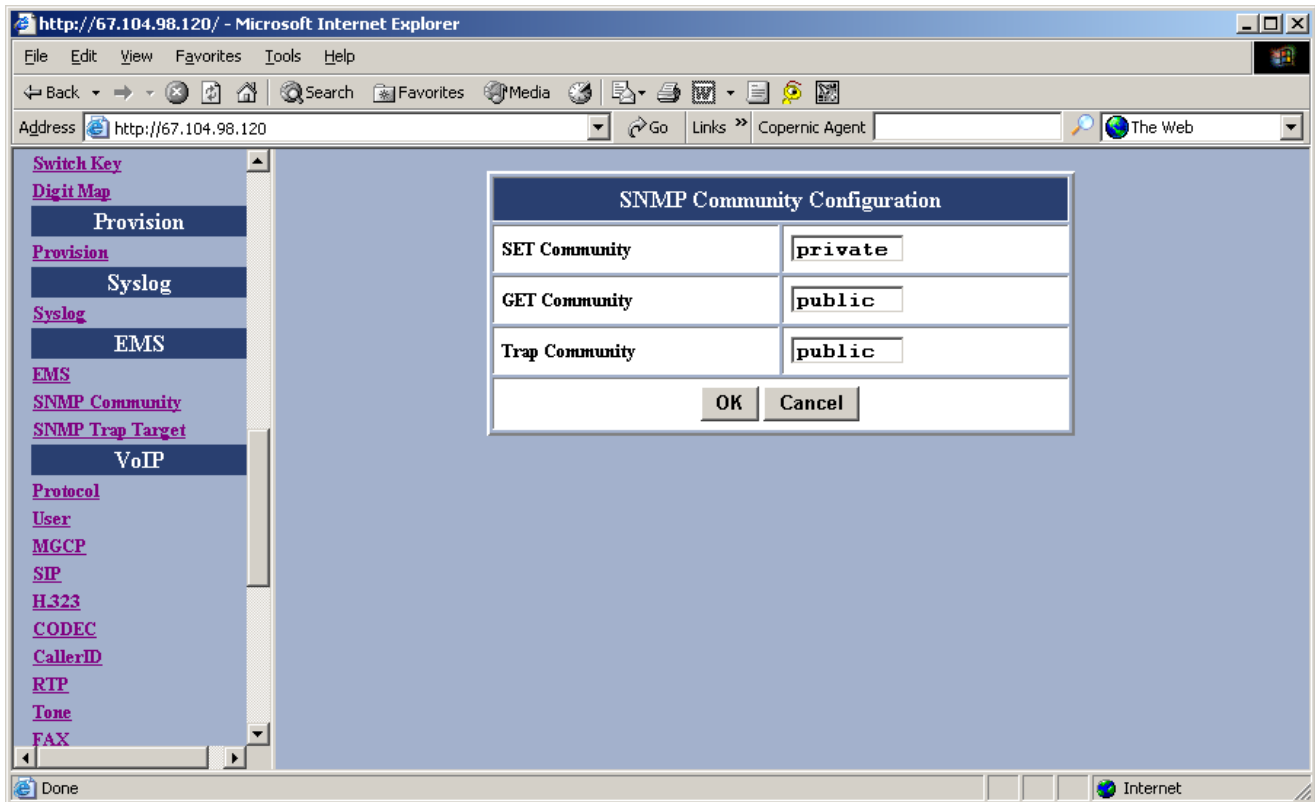

Figure 26 –SNMP Community Configuration Window

Item	Description
Set Community	The Community is used when the user sets OIDs (Object Identifiers)
Get Community	The Community is used when the user gets OIDs (Object Identifiers)
Trap Community	The Community is used when the user processes the traps.

3.11.3 SNMP Trap Target

The BMG7011/ 7012 VoIP gateways support (4) Trap targets. You can specify each IP and Port to receive the traps sent from the VoIP Gateway. **Save and Reboot.**

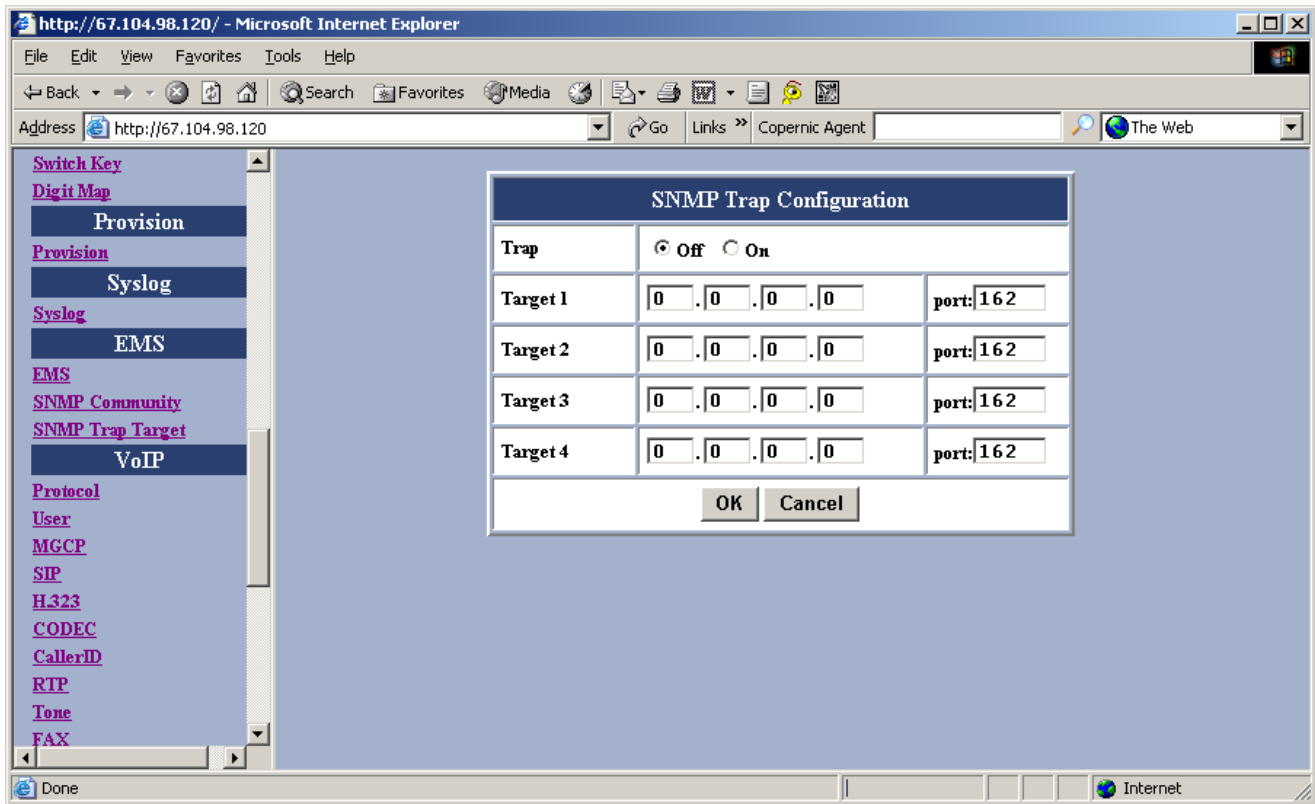

Figure 27 –SNMP Trap Configuration Window

Item	Description
Trap	The traps will be sent (on) or not (off).
IP	Specify the IP Address to which the traps of the VoIP Gateway will be sent.
Port	Specify the Port to which the traps of the VoIP Gateway will be sent.

3.12 VoIP Configuration

3.12.1 Protocol

This screen allows you to set the preferred protocol.

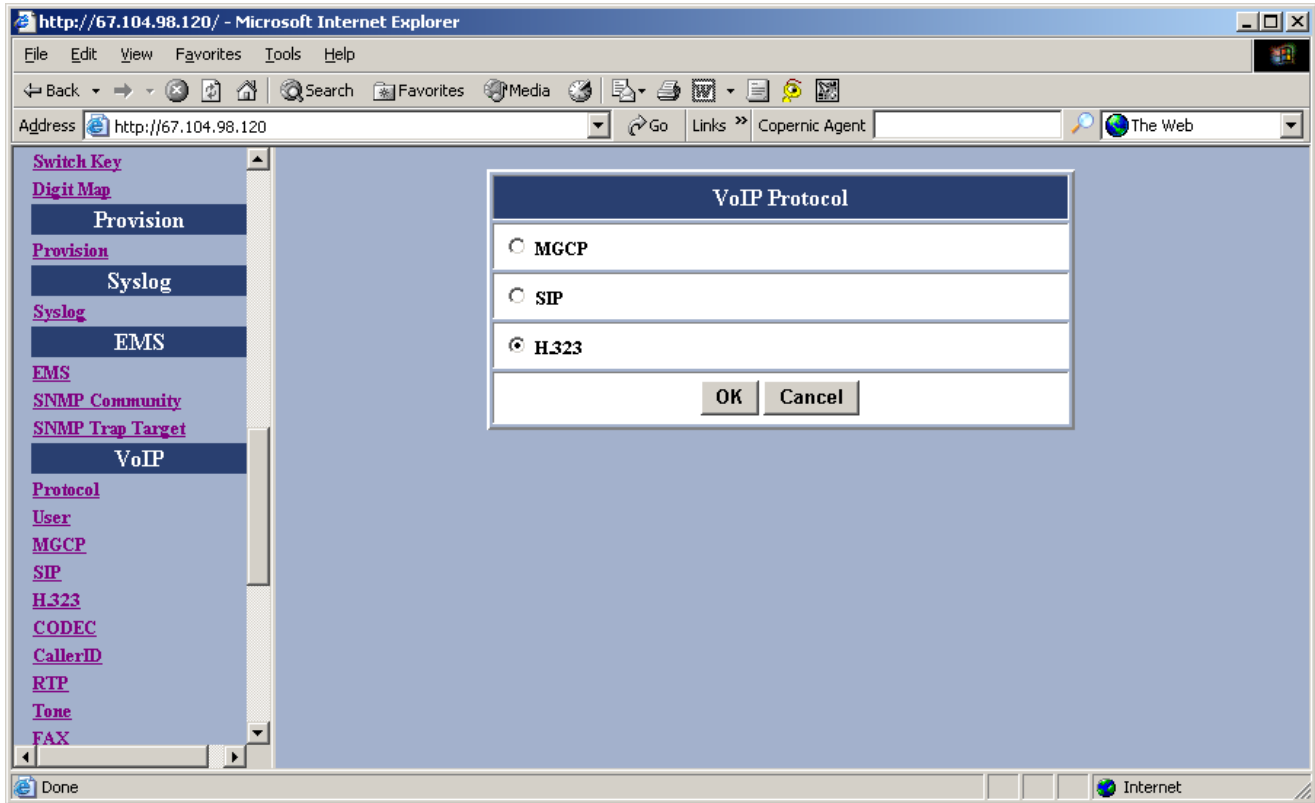

Figure 28 – VoIP User Configuration Window

Item	Description
MGCP	Select MGCP for MGCP Protocol
SIP	Select SIP for SIP Protocol
H.323	Select H.323 for H.323 Protocol

3.12.2 User

This screen allows you to set the user information such as username, password and display name. You should obtain the values from your service provider for these services. **Save and Reboot.**

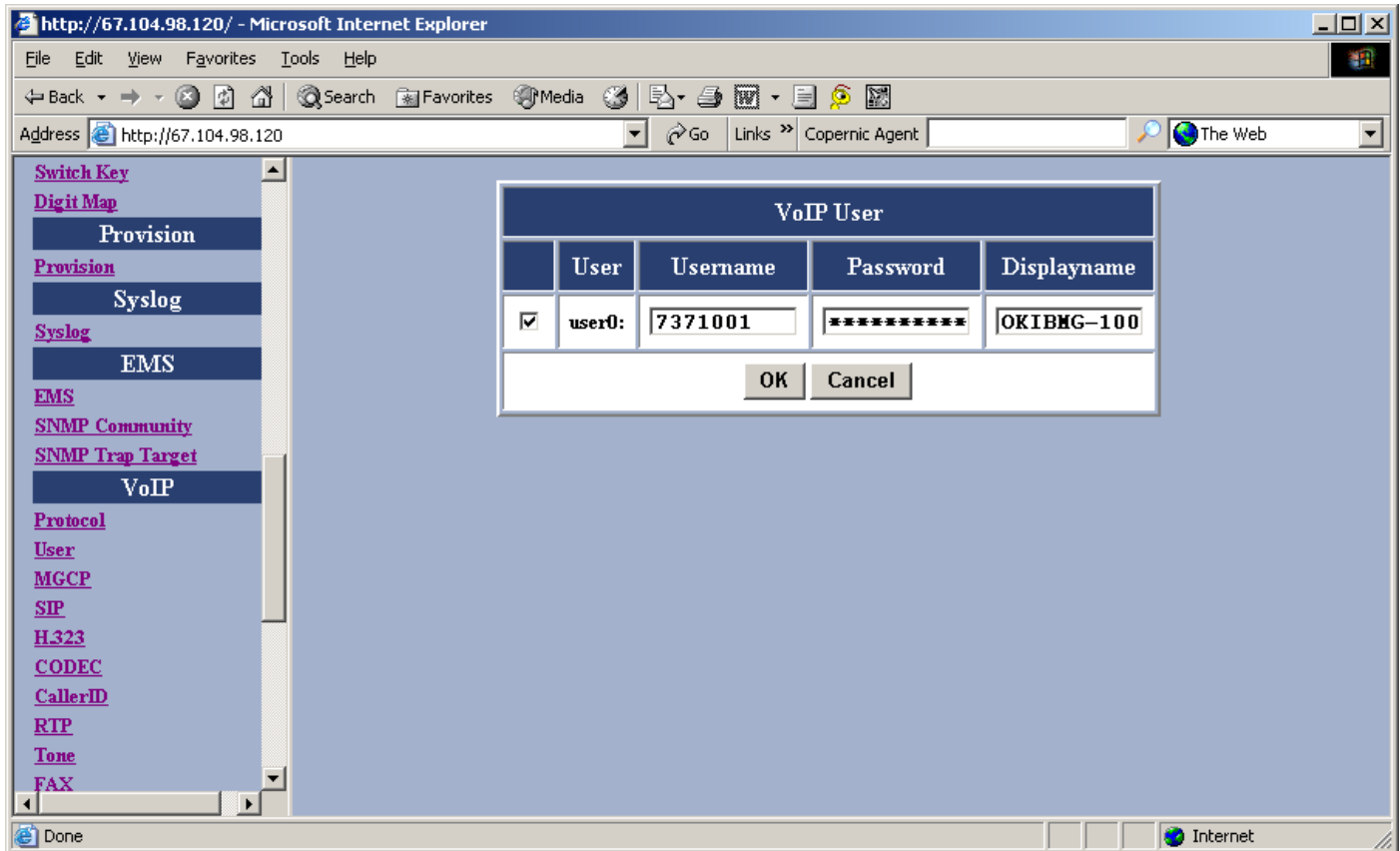

Figure 29 – VoIP User Configuration Window

Item	Description
User (check box)	Check user0 or user1 or both for phone to be used
Username	Specifies the name (or phone number) of the user
Password	Specifies the password of the user
Display name	Specifies the displayed user name for H.323 protocol specifies H.323 ID

3.12.3 MGCP

This screen allows you to make MGCP configurations including local port, call agent address, call agent port number, wild-carded RSIP, Name style, and expiry time.

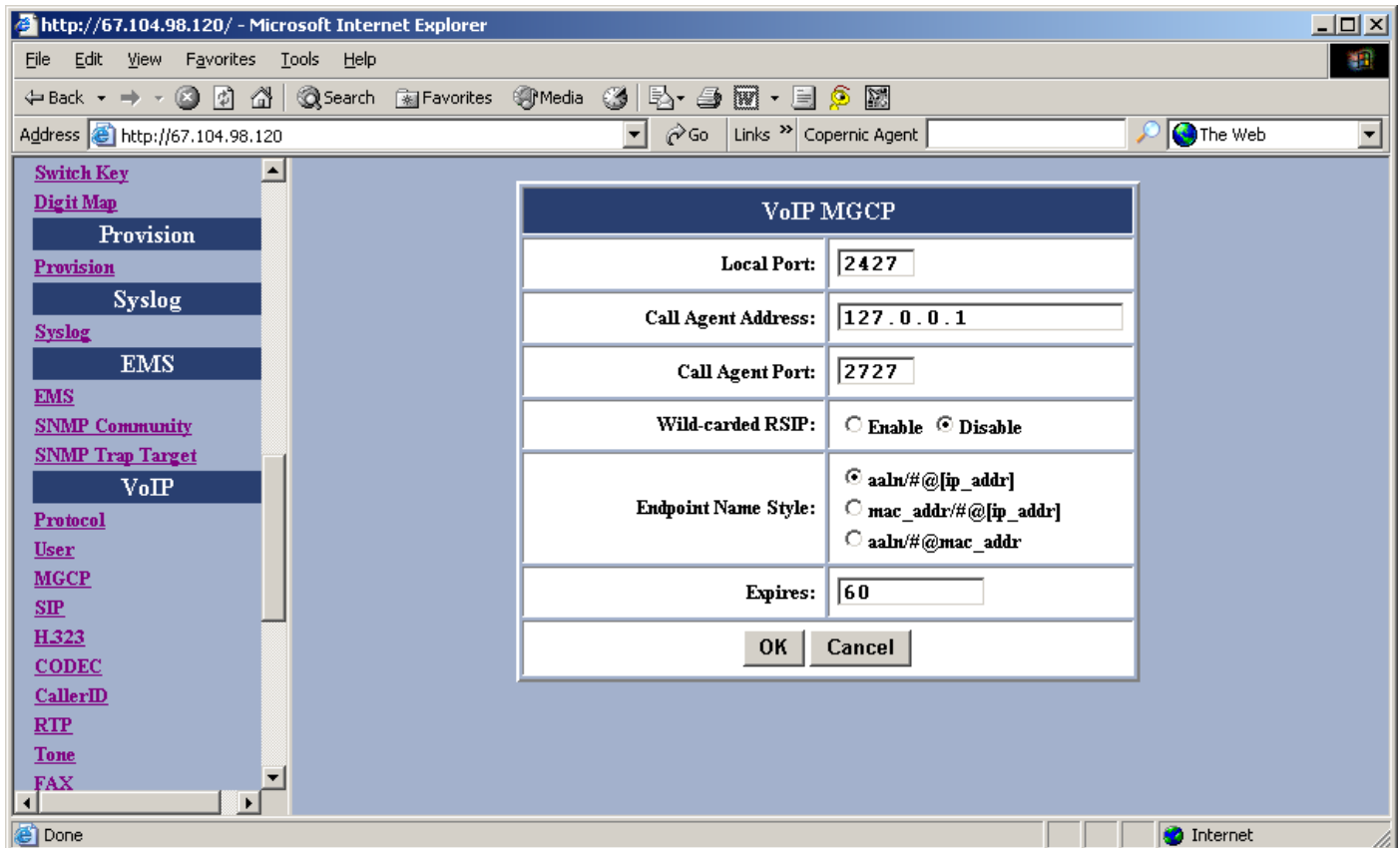

Figure 30 – VoIP MGCP Configuration Window

Item	Description
Local Port	This port number is identified to receive/send data from/to the Call Agent.
Call Agent Address	Specifies the IP Address of Call Agent.
Call Agent Port	This port number is identified to receive/send data from/to the VoIP Gateway.
Wild-carded RSTP	Enabling this field permits the use of wild card signals to replace RTP with RSTP.
Endpoint name style	Sets Endpoint name style.ex. aaln/#@[ip_addr] / mac_addr/#@[ip_addr] / aaln/#@mac_addr
Expires	<p>“Expires” specifies the period (in seconds) that the VoIP Gateway sends keeping-alive message to the Call Agent.</p> <p>This is to help check the connection status in case the VoIP Gateway is accidentally</p>

	disconnected from the Call Agent.
--	-----------------------------------

3.12.4 SIP

This screen allows you to make SIP configurations including local port, SIP proxy server address, port number, registrar server address, port number, expiry time, SIP domain, and subject. **Save and Reboot.**

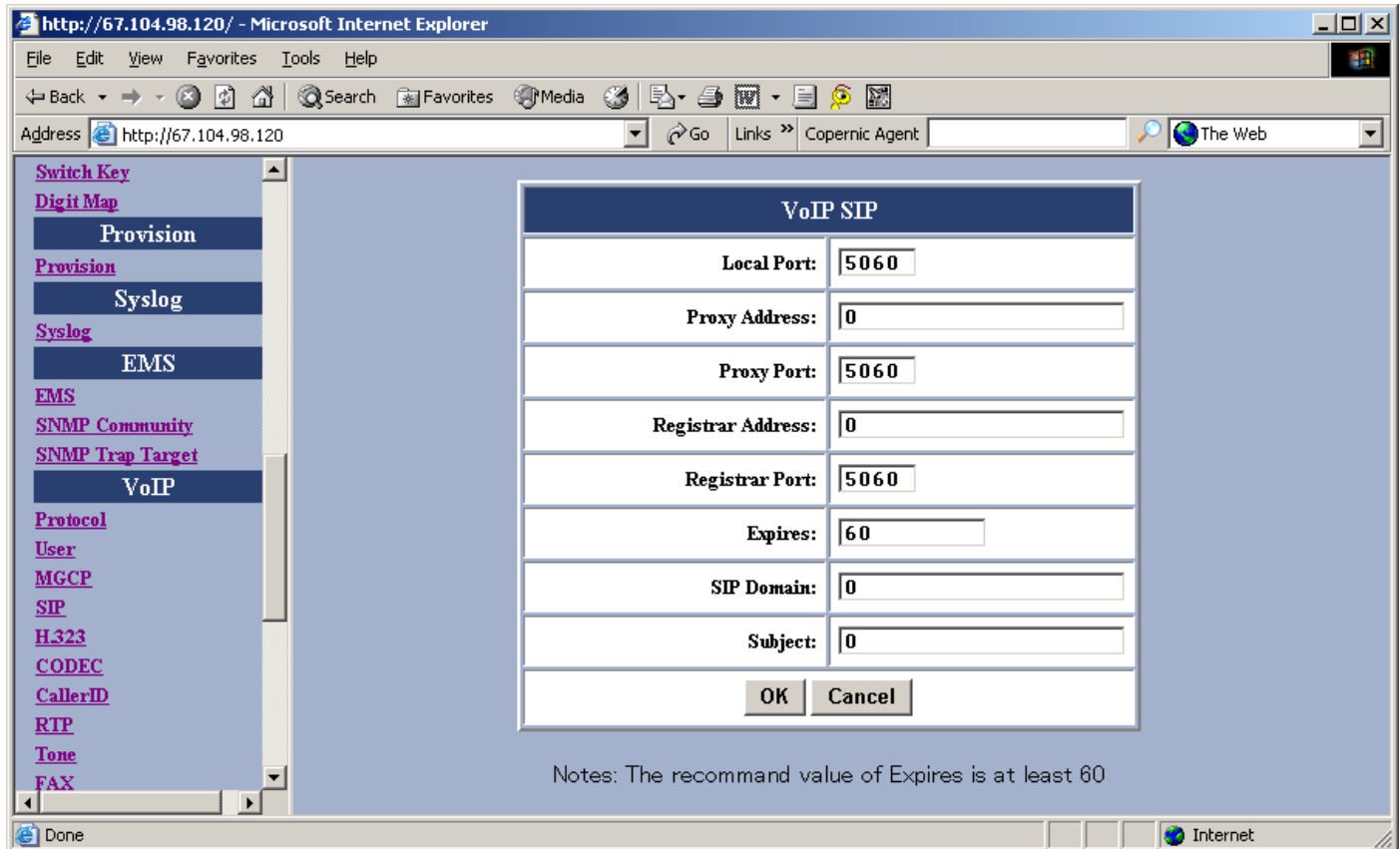

Figure 31 – VoIP SIP Configuration Window

Item	Description
Local Port	Specifies the port number of the SIP stack. 5060 is the default port number.
Proxy Address	Specifies the IP address of SIP proxy server
Proxy Port	Specifies the port number of SIP proxy server
Registrar Address	Specifies the IP address of Registrar server. Registrar server is often the same as SIP proxy server
Registrar Port	Specifies the port number of Registrar server.
Expires	“Expires” specifies the period (in seconds) that the VoIP Gateway sends Registration message to Registrar server. This is to help check the connection status in case the VoIP Gateway is

	accidentally disconnected from the Registrar server.
SIP Domain	Specifies the domain name to which BMG is assigned to by the service provider
Subject	Specifies the content of the subject header in outgoing INVITE message. This is used to indicate the title of the call.

3.12.5 H.323

This screen allows you to make changes to the H.323 configurations including local port, H.323 Gatekeeper ID, Gatekeeper Address, port number, H235 Password (optional), expiry time, Fast Start mode, and DTMF signal type. **Save and Reboot.**

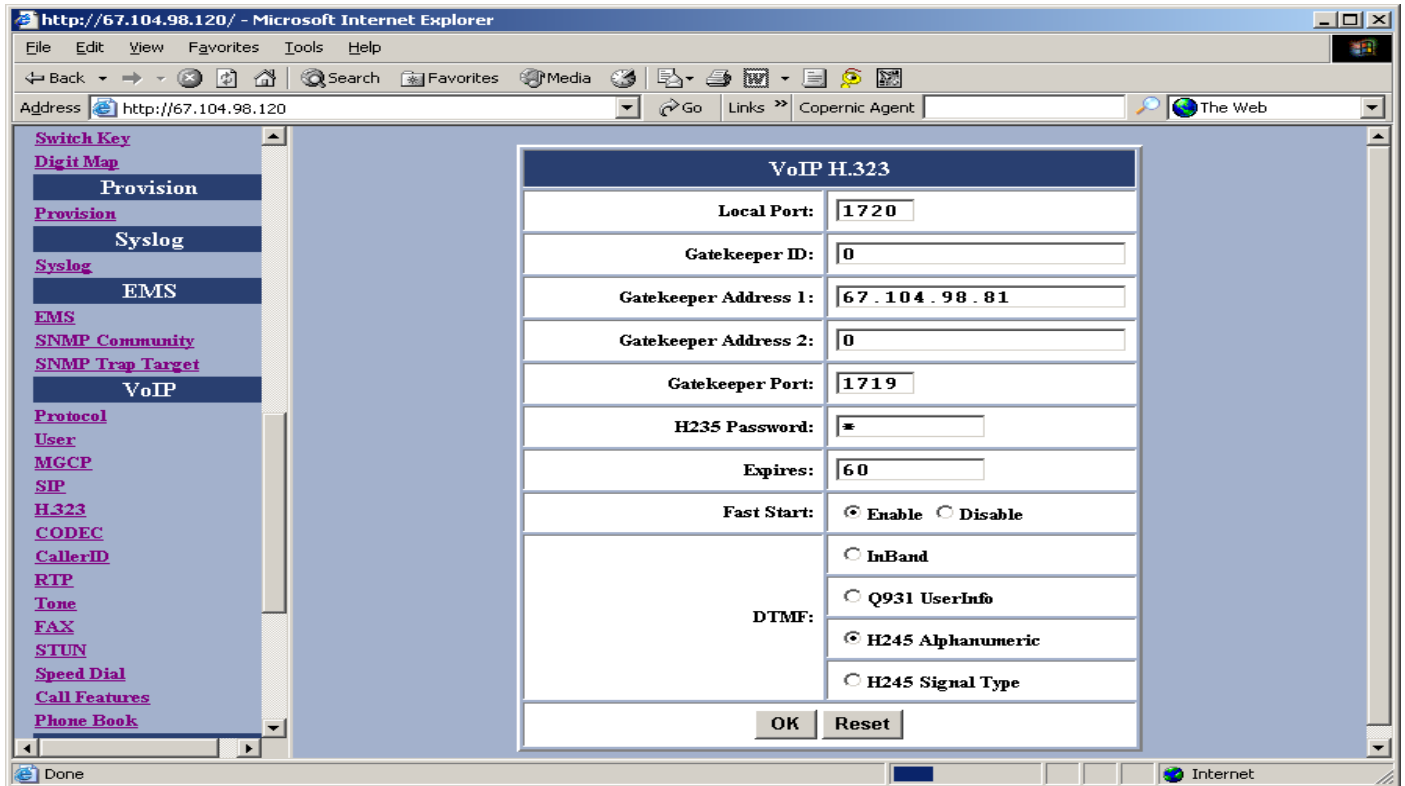

Figure 32 – VoIP H.323 Configuration Window

Item	Description
Local Port	Specifies the port number of the H.323 stack. 1720 is the default port number.
Gatekeeper ID	Specifies the ID of Gatekeeper
GK1 Address	Specifies the IP address of Gatekeeper.
GK2 Address	If Secondary Gatekeeper is specified.
Gatekeeper port	Specifies the port number of Gatekeeper.
H235 Password	Specifies the password for secured registration
Expires	“Expires” specifies the period (in seconds) that the VoIP Gateway sends Registration message to Gatekeeper. This is to help check the connection status in case the VoIP Gateway is accidentally disconnected from Gatekeeper.

Fast Start	Enables the Fast start mode or Disable to Normal start mode
DTMF	Specifies the DTMF signal types

3.12.6 CODEC

This screen allows you to set CODEC configurations including Codec Rate, Preferred Codec, and VAD. **Save and Reboot.**

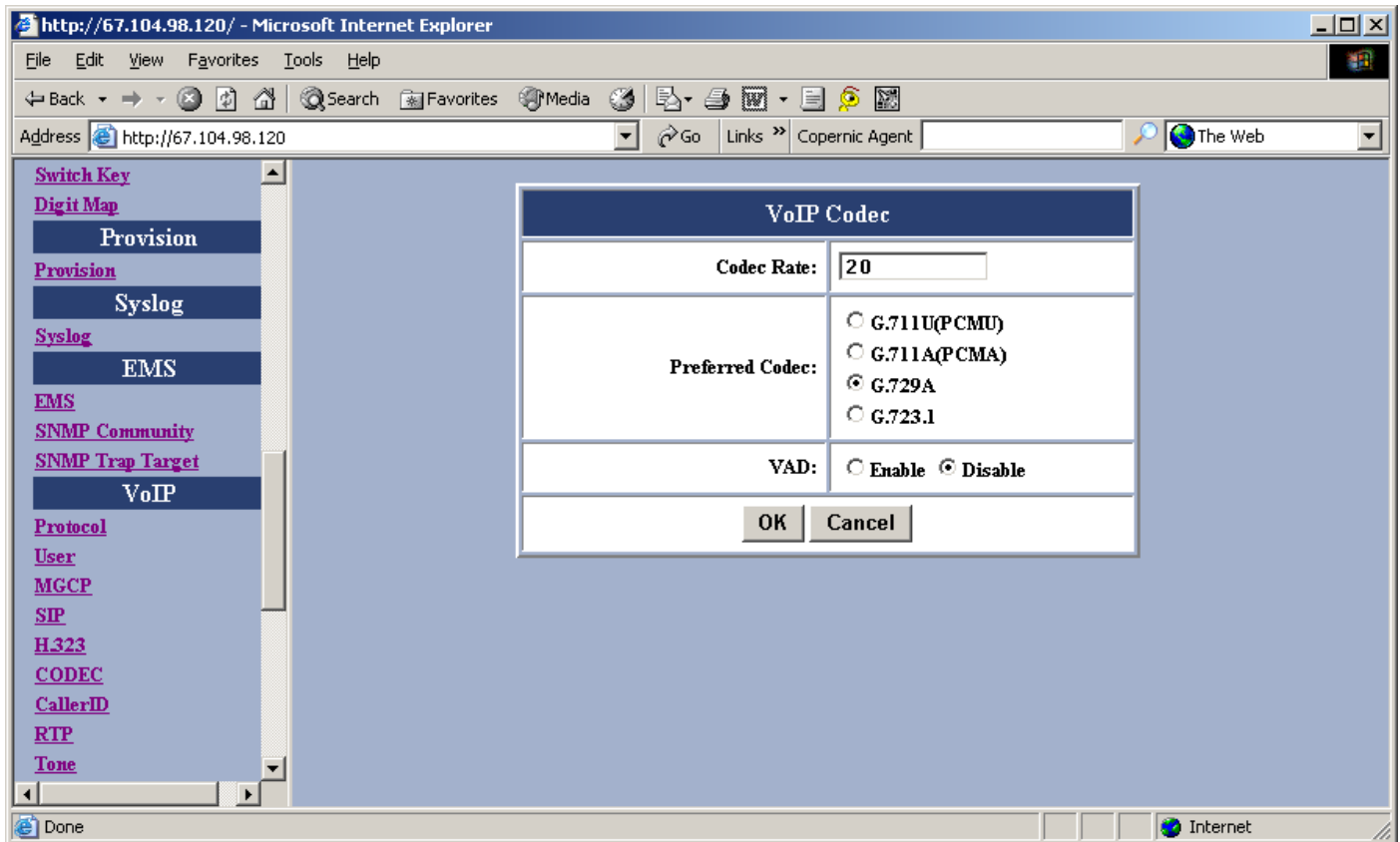

Figure 33 – VoIP Codec Configuration Window

Item	Description
CODEC Rate	<p>“CODEC rate” specifies the packetization time (in milliseconds).</p> <p>The value is from 10 to 40 ms for G.711 in 10 ms increments (20ms recommended)</p> <p>The value is from 10 to 80 ms for G.729A in 10 ms increments (20ms recommended)</p> <p>The value is 30, 60 or 90 ms for G.723.1 (30ms recommended)</p>
Preferred CODEC	Specifies the preferred method of voice compression.
VAD	<p>Voice Activity Detection feature.</p> <p>Enabled: sending packets only while the user is speaking. This will save the bandwidth but cause the time delay.</p>

	Disabled: sending packets no matter the user is speaking or not. This will improve the voice quality to be more smoothly but increase more traffic load.
--	--

3.12.7 Caller ID

This screen allows the user to set the FSK and DTMF. **Save and Reboot.**

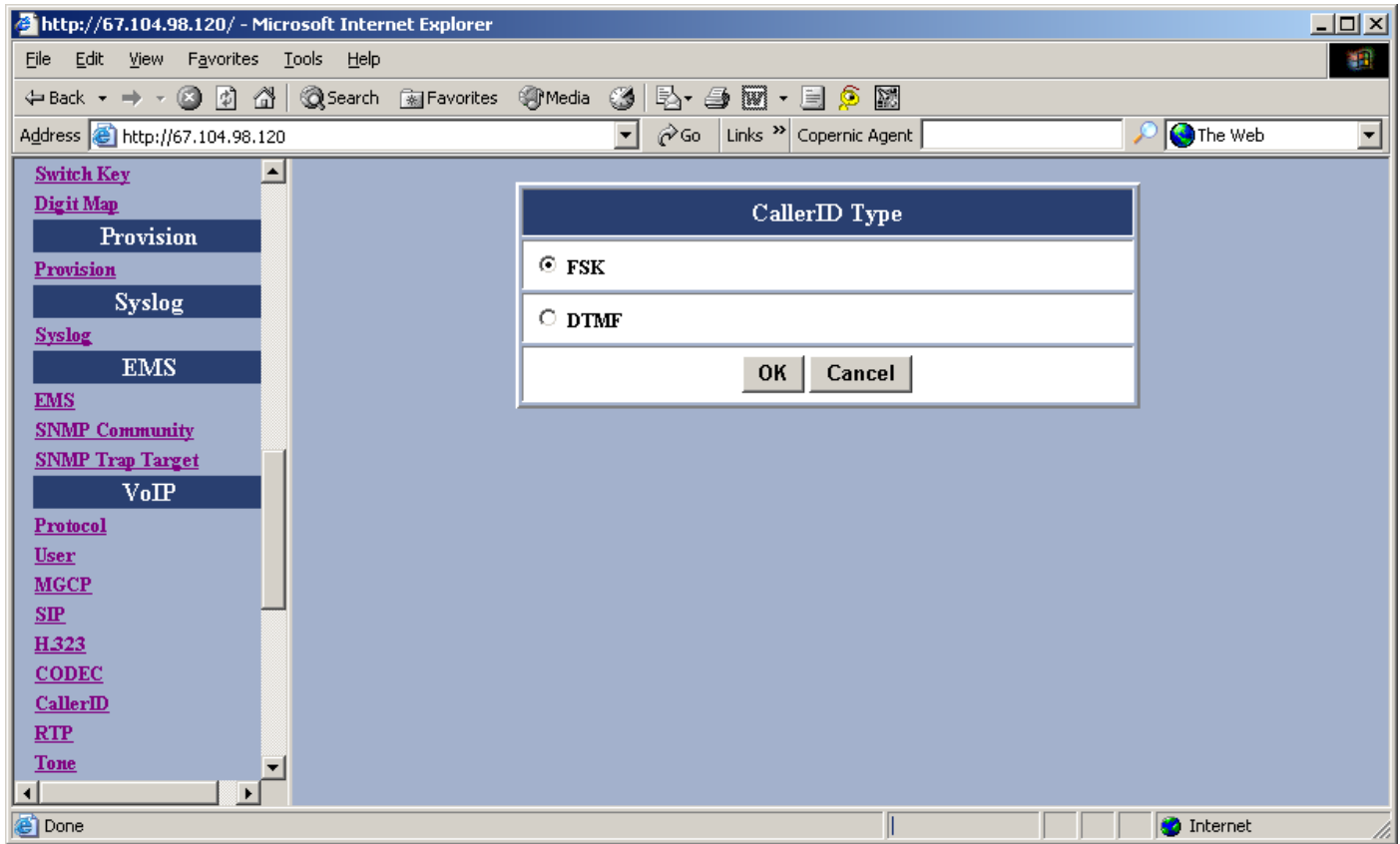

Figure 34 – VoIP Caller ID Configuration Window

Item	Description
FSK/ DTMF	Specifies the Caller ID transmission type.

3.12.8 RTP

This screen allows user to set RTP port number. **Save and Reboot.**

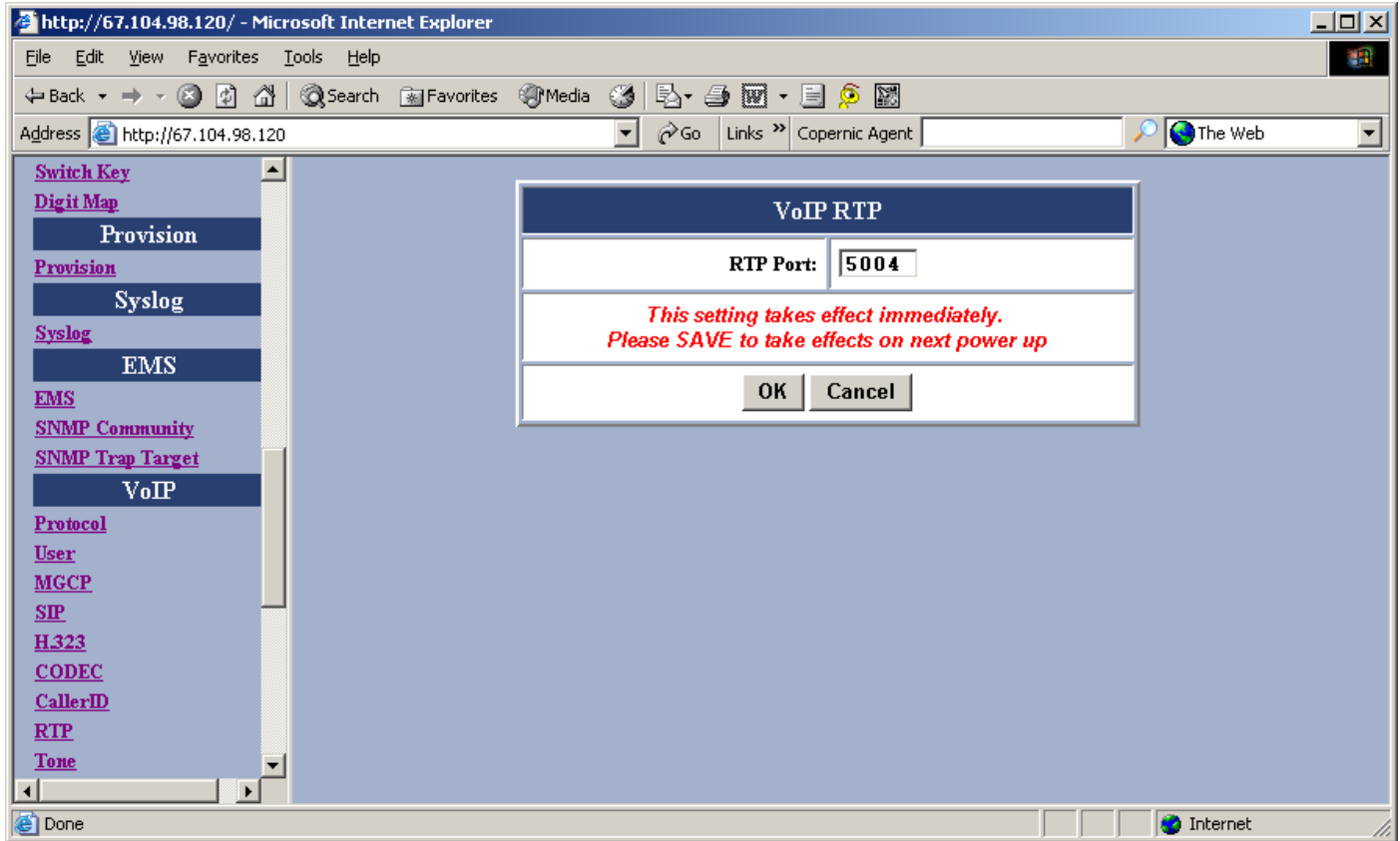

Figure 35 – VoIP RTP Configuration Window

Item	Description
RTP port	Specifies the RTP port number to the far end device that the voice packet should be received on this port number

3.12.9 Tone

This screen allows user to set the tone configurations including Rx gain, Tx gain, ringing tone, dial tone, busy tone, ring back tone, and call waiting tone. You can choose the country tone or you can customize with the following parameters. **Save and Reboot.**

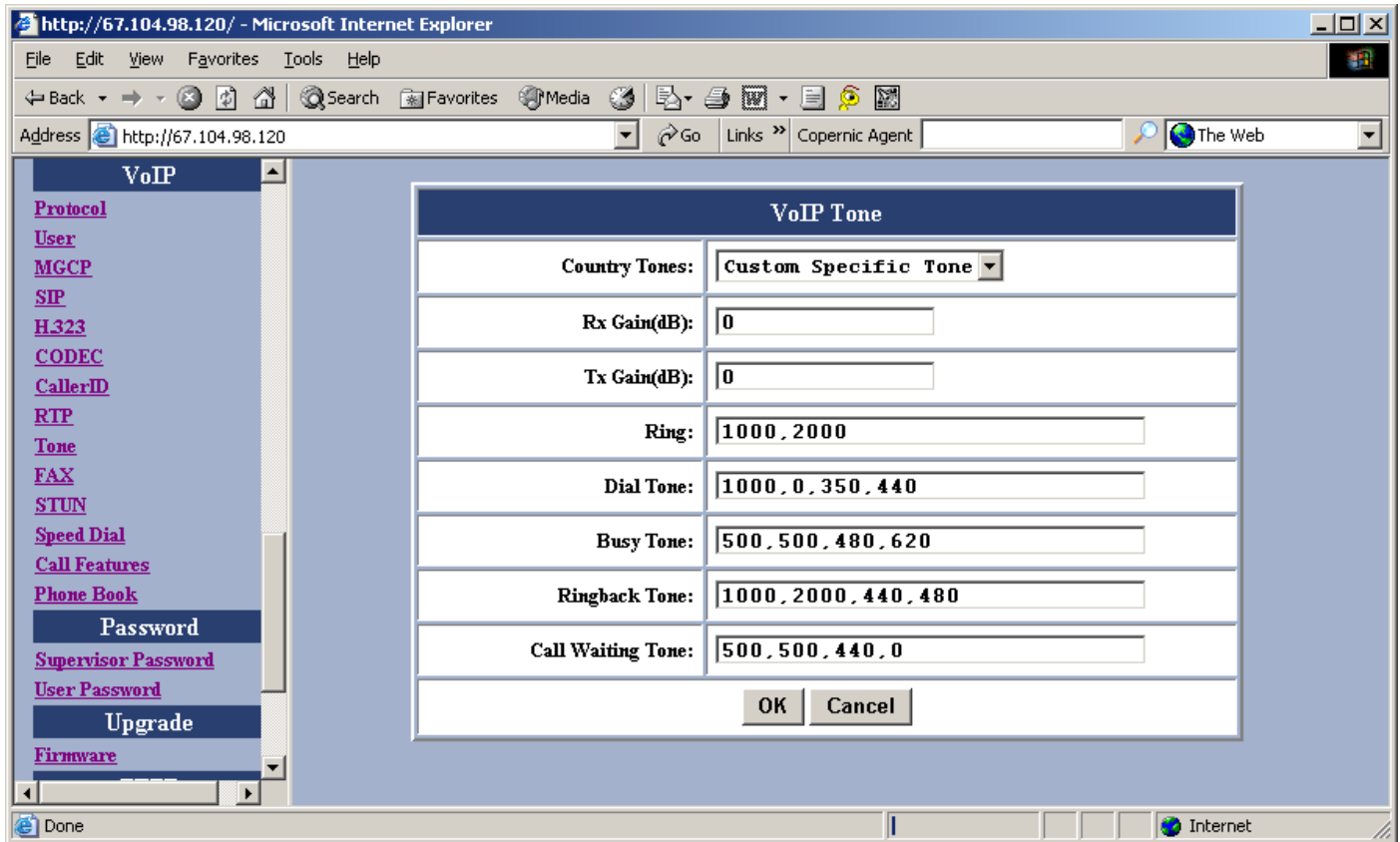

Figure 36 – VoIP Tone Configuration Window

Item	Description
Country Tone	Select one of listed countries for country default tone
Rx Gain	Adjusts the receiving audio gain to be higher or lower range -15 to 15dB
Tx Gain	Adjust the transmitting audio gain to be higher or lower range -15 to 15dB
Ring	Sets the ringing cadence (in milliseconds). <ontime, offtime>
Dial Tone	Sets the dial tone pattern <ontime, offtime (in milliseconds), freq1, freq2 (in Hz)>
Busy Tone	Sets the busy tone pattern <ontime, offtime (in milliseconds), freq1, freq2 (in Hz)>
Ring Back Tone	Sets the ring back tone pattern <ontime, offtime (in milliseconds), freq1, freq2 (in Hz)>

Call Waiting Tone	Sets the call waiting tone pattern <ontime, offtime (in milliseconds), freq1, freq2 (in Hz)>
------------------------------	--

3.12.10 FAX

This screen allows user to set the port number for sending/receiving T.38 packets. T.38 protocol supports data-resending mechanism in case of any missing data during transmission. **Save and Reboot.**

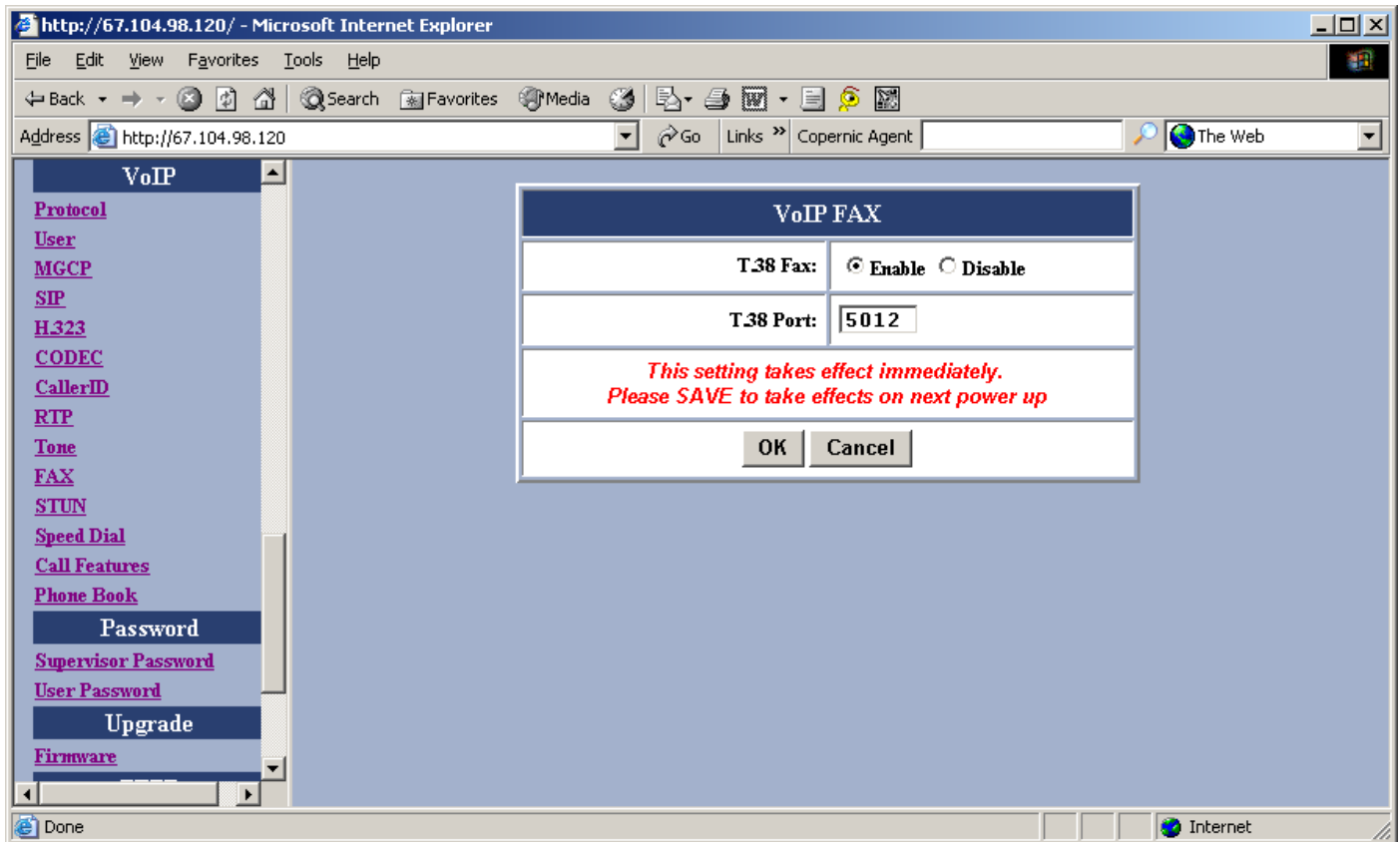

Figure 37 – VoIP Fax Configuration Window

Item	Description
T.38 Fax	Enable or disable T.38 Fax transmission
T.38 port	Specifies the T.38 port number for sending/receiving T.38 packets

3.12.11 STUN

This screen allows user to set NAT address, STUN server address, STUN server port, local port, and expiry time. **Save and Reboot.**

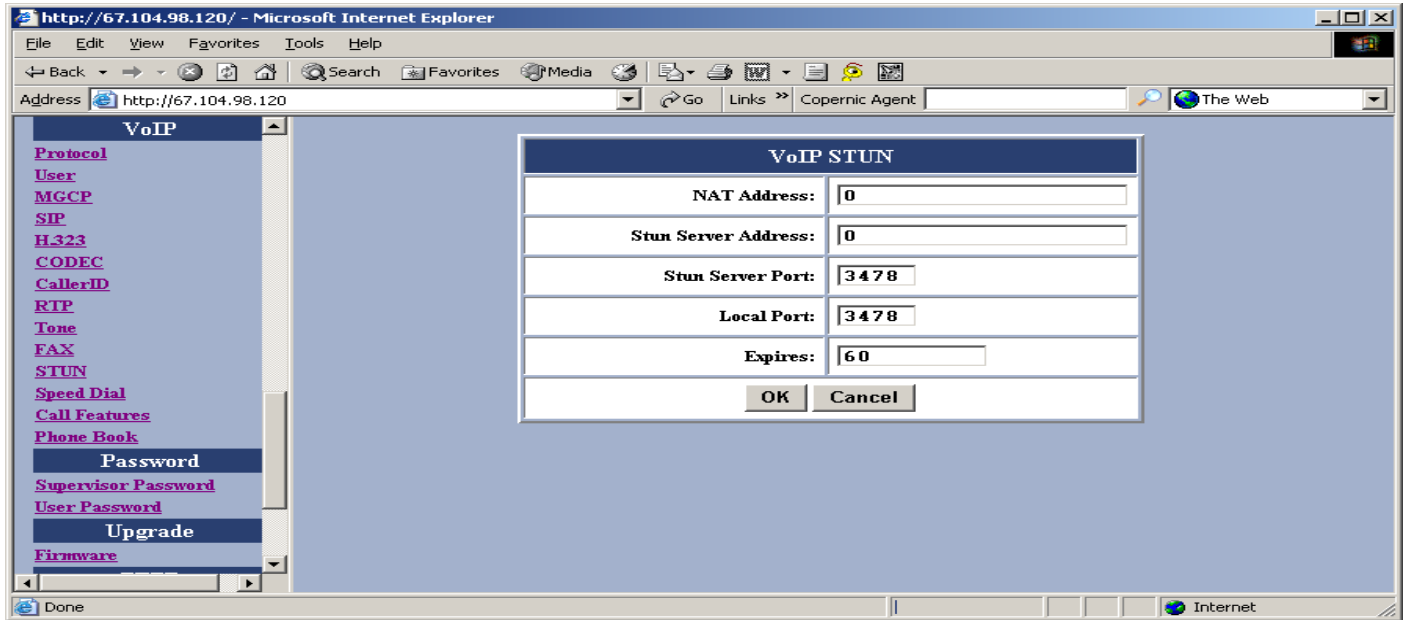

Figure 38 – VoIP STUN Configuration Window

Item	Description
NAT Address	Statically specifies the IP address of the BMG for VoIP if it is installed behind a NAT. The IP address is the WAN side IP address from the NAT device. Do not set an IP address when STUN is used. STUN will automatically update this address.
STUN Server Address	Specifies the IP address of STUN server (Simple Traversal of User Datagram)
STUN Server Port	Specifies the port number of STUN server
Local Port	Specifies the local port number of STUN client
Expires	“Expires” specifies the period (in seconds) that the VoIP Gateway sends STUN message to STUN server. This is to help check the connection status in case the VoIP Gateway is accidentally disconnected from STUN server.



User can dynamically set the IP address for VoIP using STUN. Please set the NAT address to 0 if STUN method is used. Vice versa, if NAT address is used, set the STUN Server Address to 0.

3.12.12 Speed Dial

The speed dial is used to set up a list of telephone numbers and SIP addresses of the call parties you wish to call.

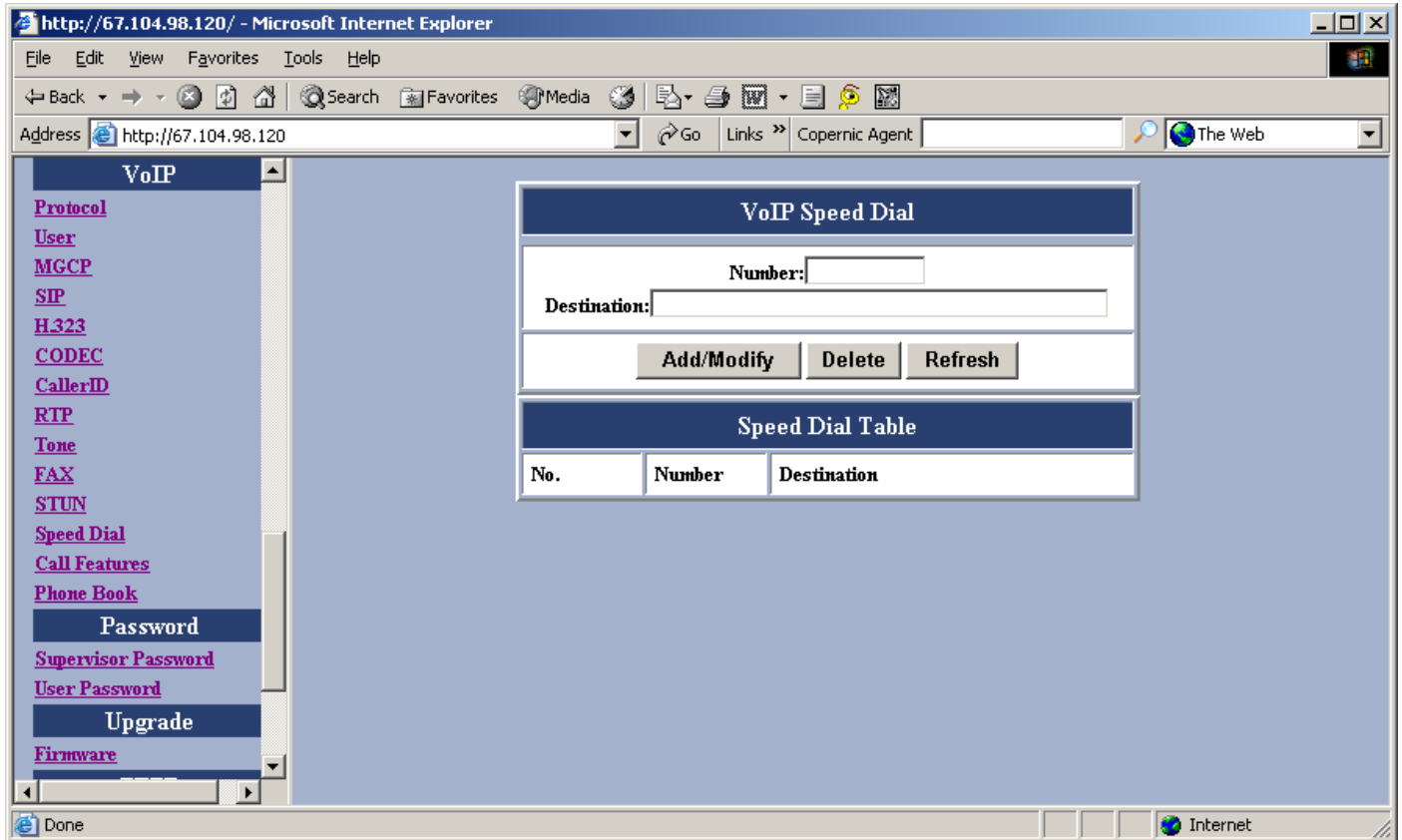

Figure 39 – VoIP Speed Dial Configuration Window

Item	Description
Number	Specifies the abbreviated number of the call party.
Destination	Enter the SIP address (or PSTN number) of the call party (Example: leon.tung@172.11.123.20)
Add/Modify	Add or modify the abbreviated number and SIP address or full telephone number of the call party.
Delete	Delete or modify the abbreviated number and SIP address or full telephone number of the call party from the Speed Dial Table.
Refresh	Pressing this button will show new changes.

3.12.13 Call Features

Set Call features for BMG including call Hold, call Waiting, call Forwarding. **Save and Reboot.**

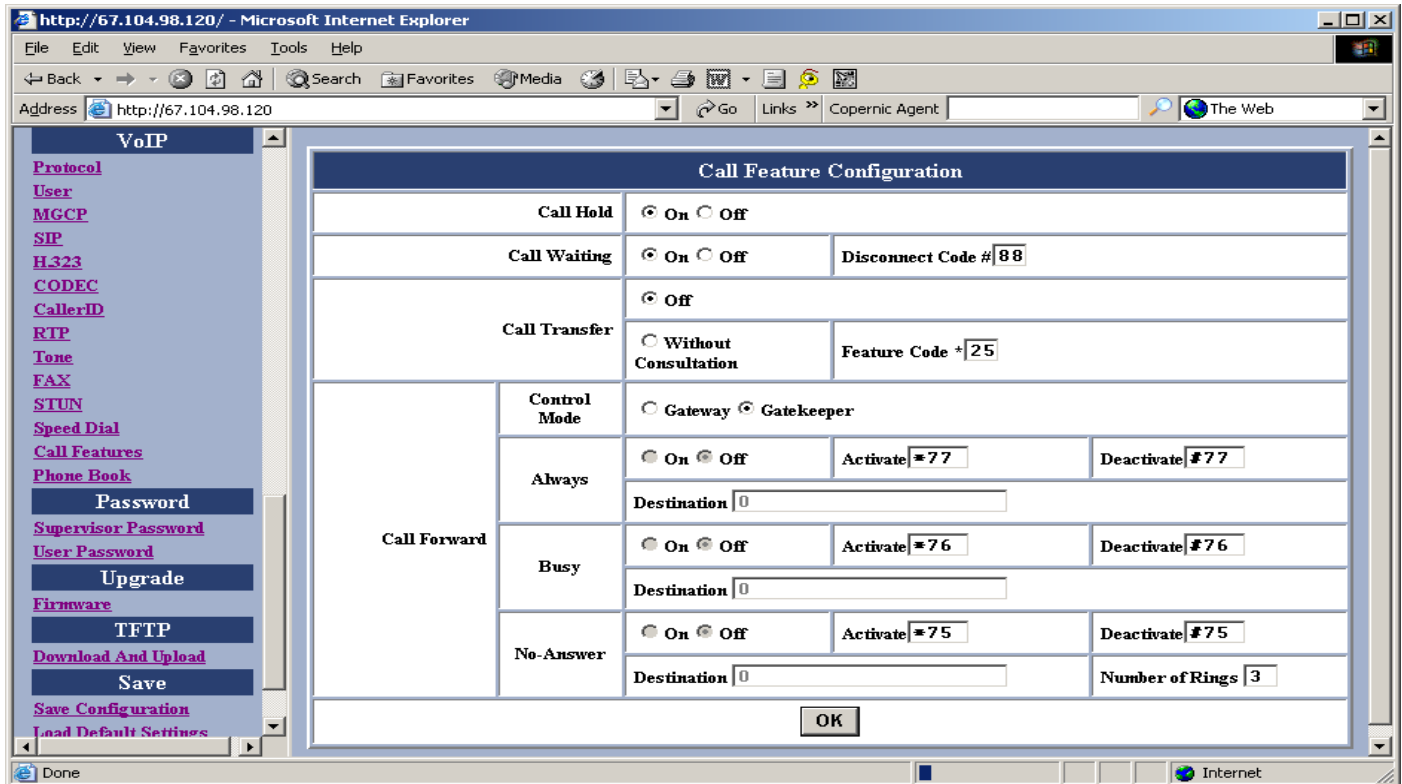

Figure 40 – VoIP Call Feature Configuration Window

Item	Description
Port	Configure port 1 or port 2 – For BMG7012 Only
Call Hold	Enable or Disable Call Hold feature. User can use flash key to hold the other party. Once call hold is disabled, call waiting is also disabled.
Call Waiting	Enable or Disable Call Waiting feature. If a user is talking with one party and the other call come in, a user can use flash key to switch to either party. If a user wants to disconnect with one party and talk with the other one, a user needs to enter disconnect code
Call Transfer	Enable or Disable Call Transfer feature, User can configure the feature code to perform call transfer function without consultation.
Call Forwarding	Enable or Disable Call Forwarding. There are 3 types Call Forwarding. Always: Unconditionally forward a call to the destination that user configured. Busy: Forward a call to the destination that user configured only when the line is busy No-Answer: Forward a call to the destination that user configured when nobody answers call after # of rings

3.12.14 Phone book

You can edit the phone book to map the IP and phone number.

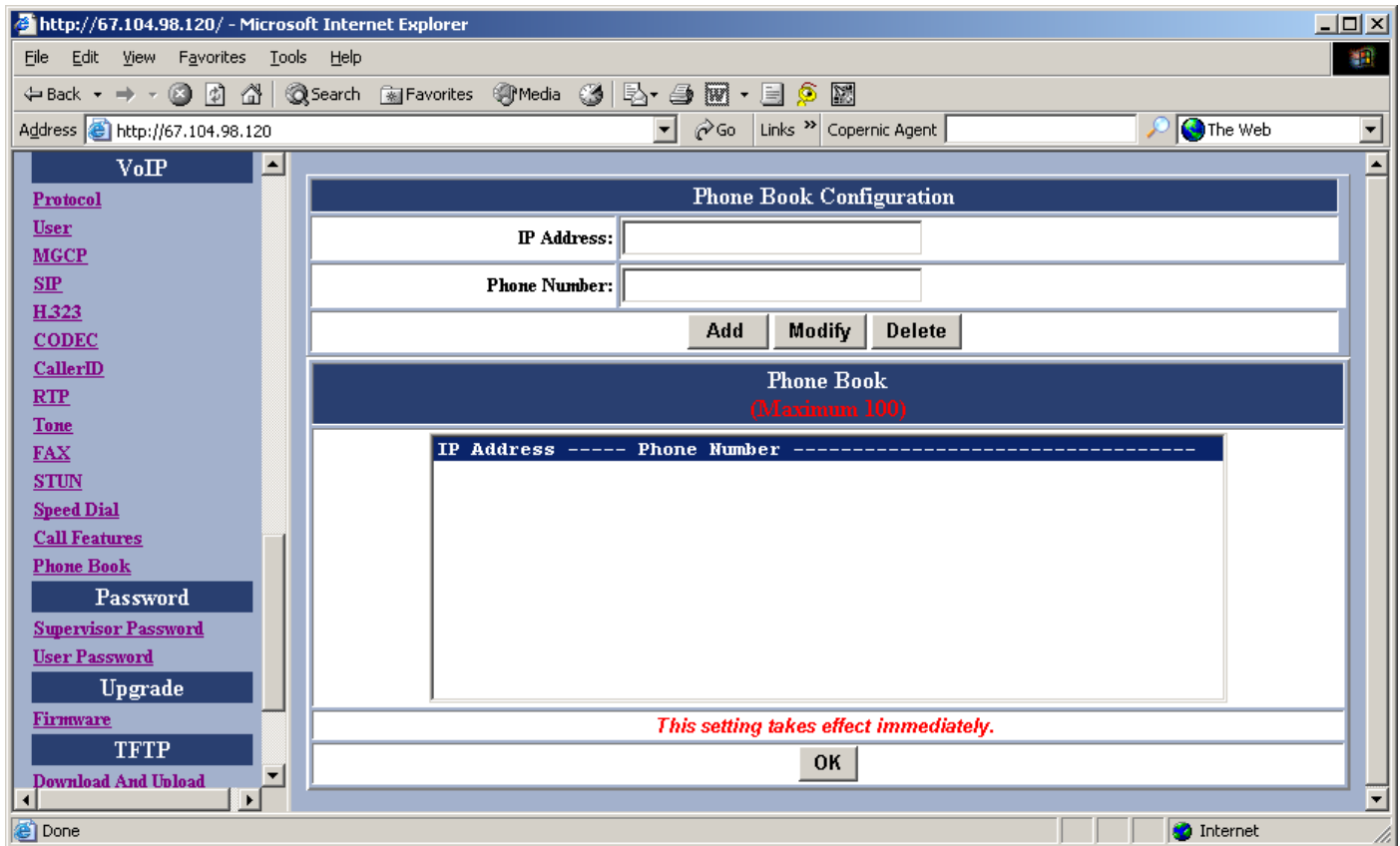

Figure 41 – VoIP Call Feature Configuration Window

Item	Description
IP Address	IP Address for the phone # specified
Phone Number	Phone book number to call
Phone Book	Maximum 100 entries

3.13 Password Configuration

3.13.1 Supervisor Password

The password will be used for authentication. It is recommended that you reset the password for administrator security.

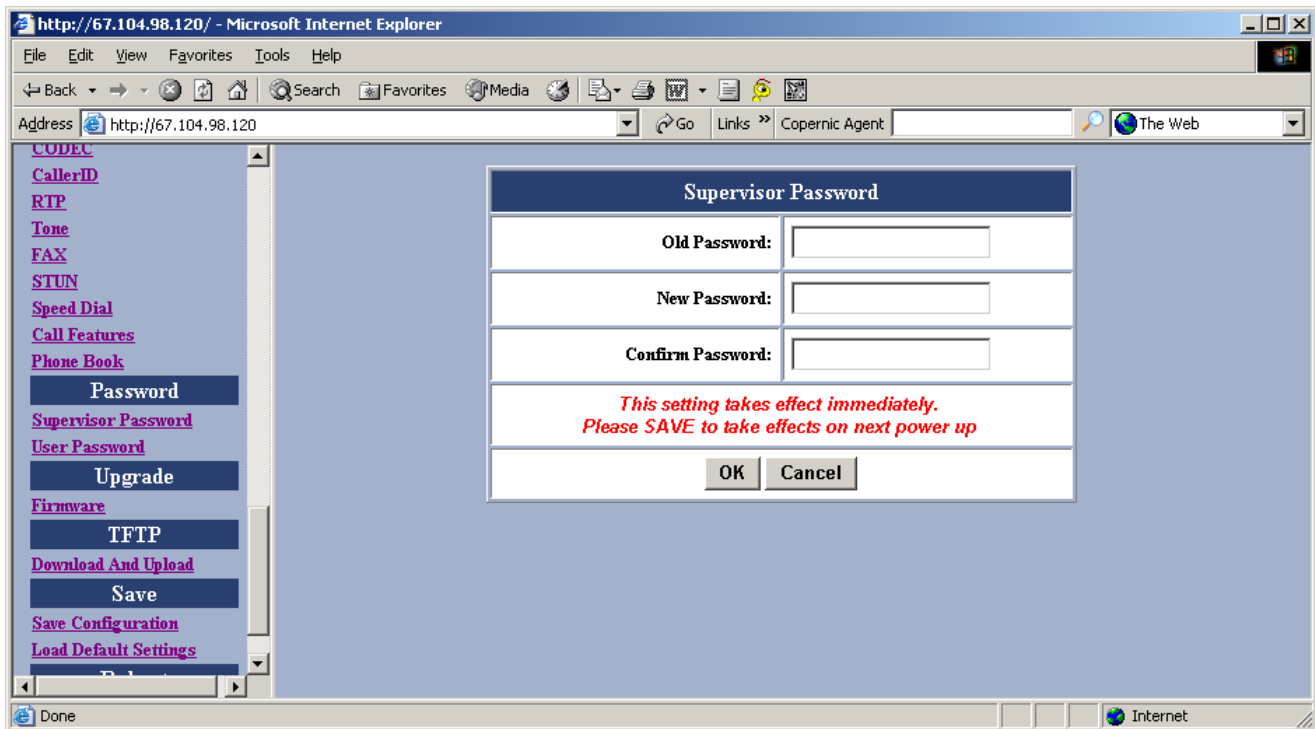

Figure 42 –Supervisor Password Window

Item	Description
Old Password	Enter the predefined password.
New Password	Enter the new password.
Confirm Password	Re-enter the new password in this field to ensure it is correct..

3.13.2 User Password

The password will be used for authentication. It is recommended that you reset the password for user security.

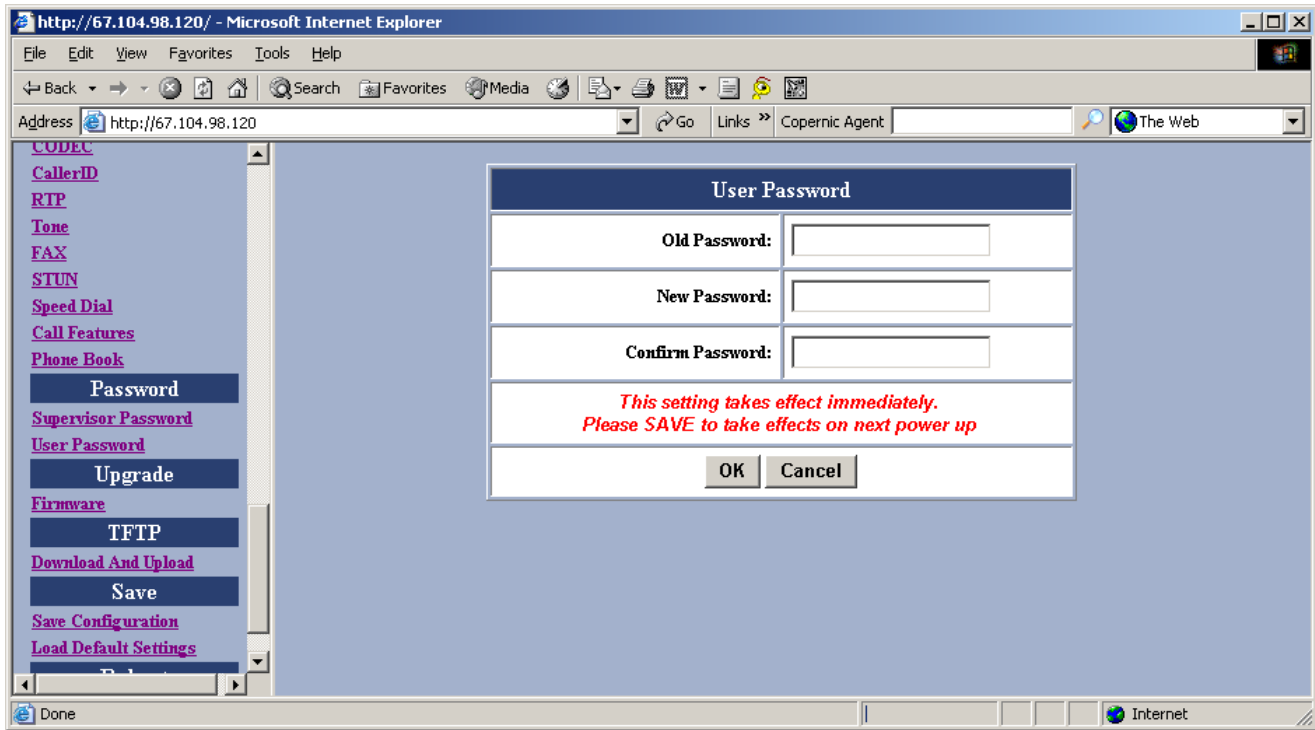

Figure 43 – User Password Window

Item	Description
Old Password	Enter the predefined password.
New Password	Enter the new password.
Confirm Password	Re-enter the new password in this field to ensure it is correct..

3.14 Upgrade Configuration

3.14.1 Firmware

This feature allows you to upgrade the firmware on the VoIP Gateway from the web browser. The firmware on the VoIP Gateway is stored on FLASH ROM. To upgrade firmware, you need to download the firmware to your local computer then, click **Browse** to locate the new firmware on your computer. Click **Upgrade** to complete the process.

See Firmware upgrade guide for additional information.

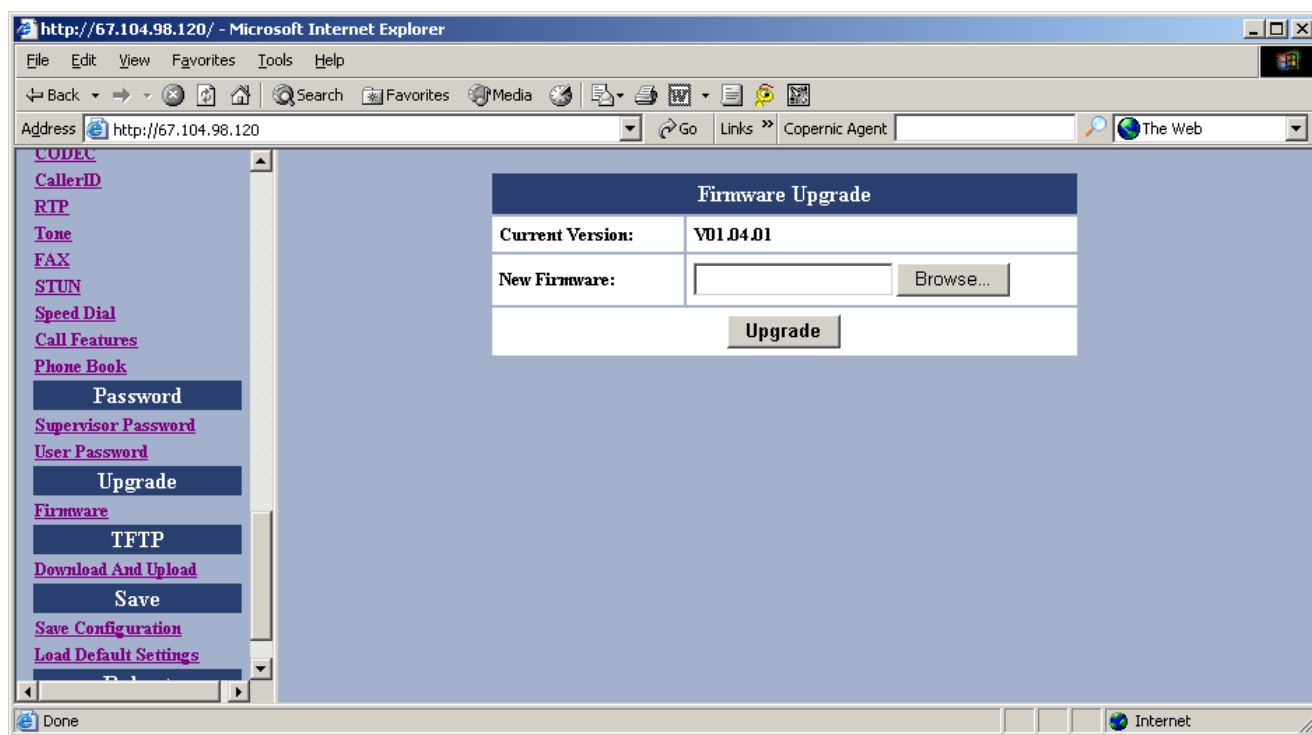

Figure 44 – Firmware Upgrade Window

Item	Description
Current Version	Shows current Firmware version
New Firmware	Enter new Firmware's file name

3.14.2 Configuration

You can upload to the current configuration to the TFTP server or download a new configuration to the unit from the TFTP server. You have to specify TFTP IP Address for this purpose. Either the configuration file or phonebook file can be uploaded or downloaded.

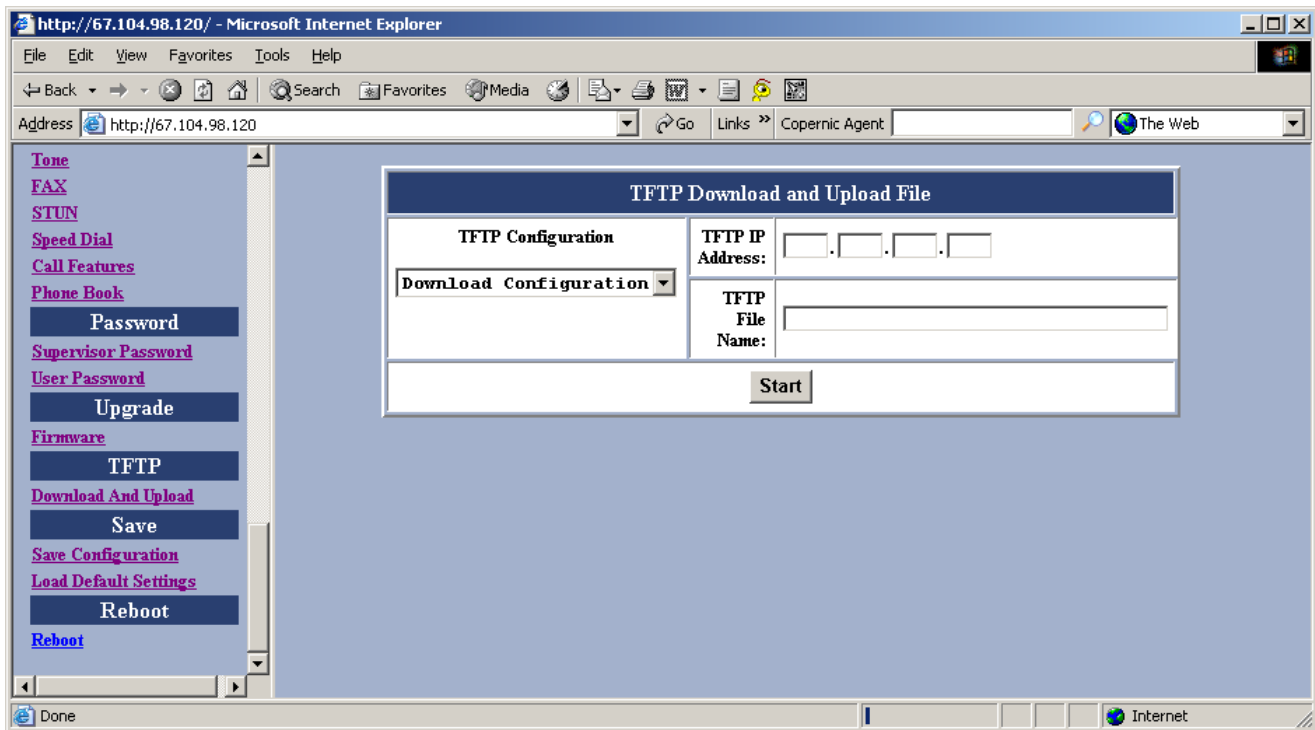

Figure 45 – Configuration Upgrade Window

Item	Description
TFTP Configuration	Select download/ upload configuration or phonebook
TFTP IP Address	Specifies TFTP Server IP Address
TFTP File Name	Enter proper file name at TFTP Server for configuration/ phonebook

3.15 Save

3.15.1 Save Configuration

Whenever you change into a new configuration, you need to save the new configuration data and then restart the gateway unit to have the new settings take effect. Once you click on the “**Save**” button from the window below, the new configuration data is automatically written into the FLASH memory and the system will be refreshed with new data on your next reboot (refer to the following section “Reboot”).

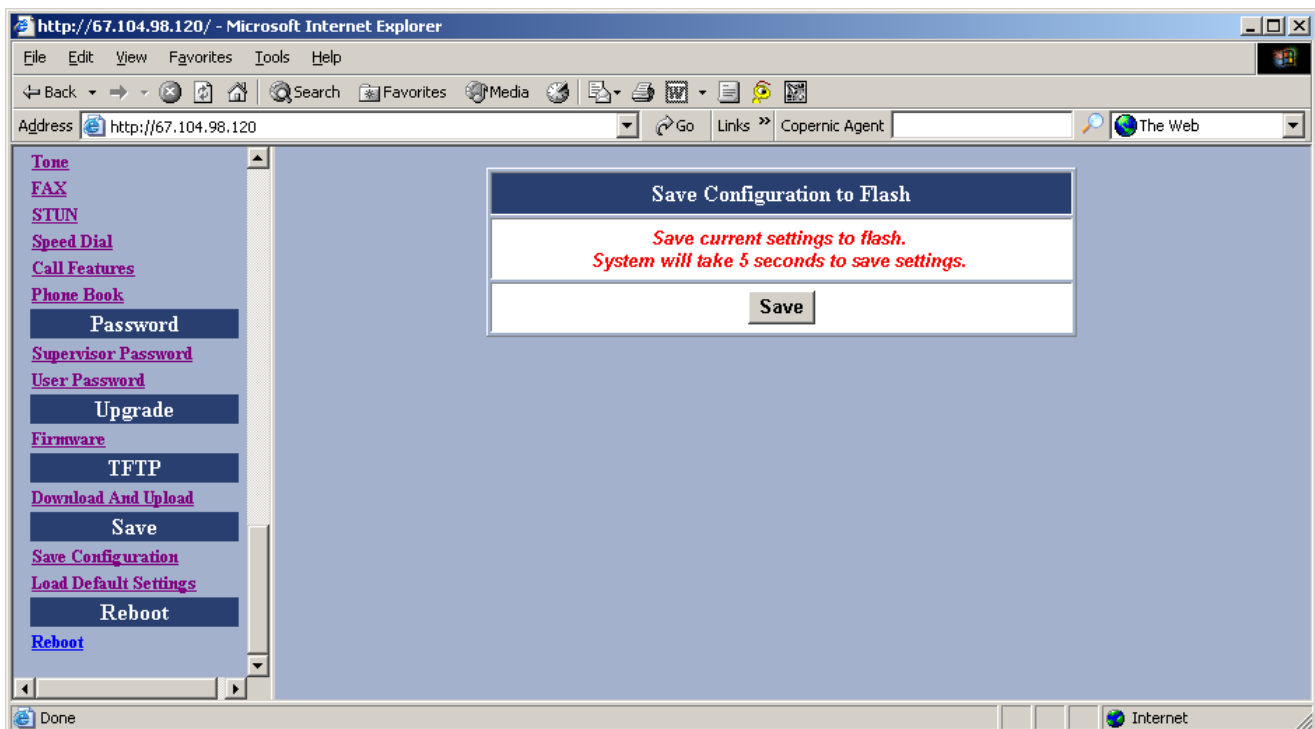

Figure 46 – Save Configuration to Flash Window

3.15.2 Load Default Settings

Click on the “**Load**” button if you would like to restore all default settings of the BMG7011/ 7012. Reboot the gateway for the new settings to take effect. See the next section “Reboot” for more information.

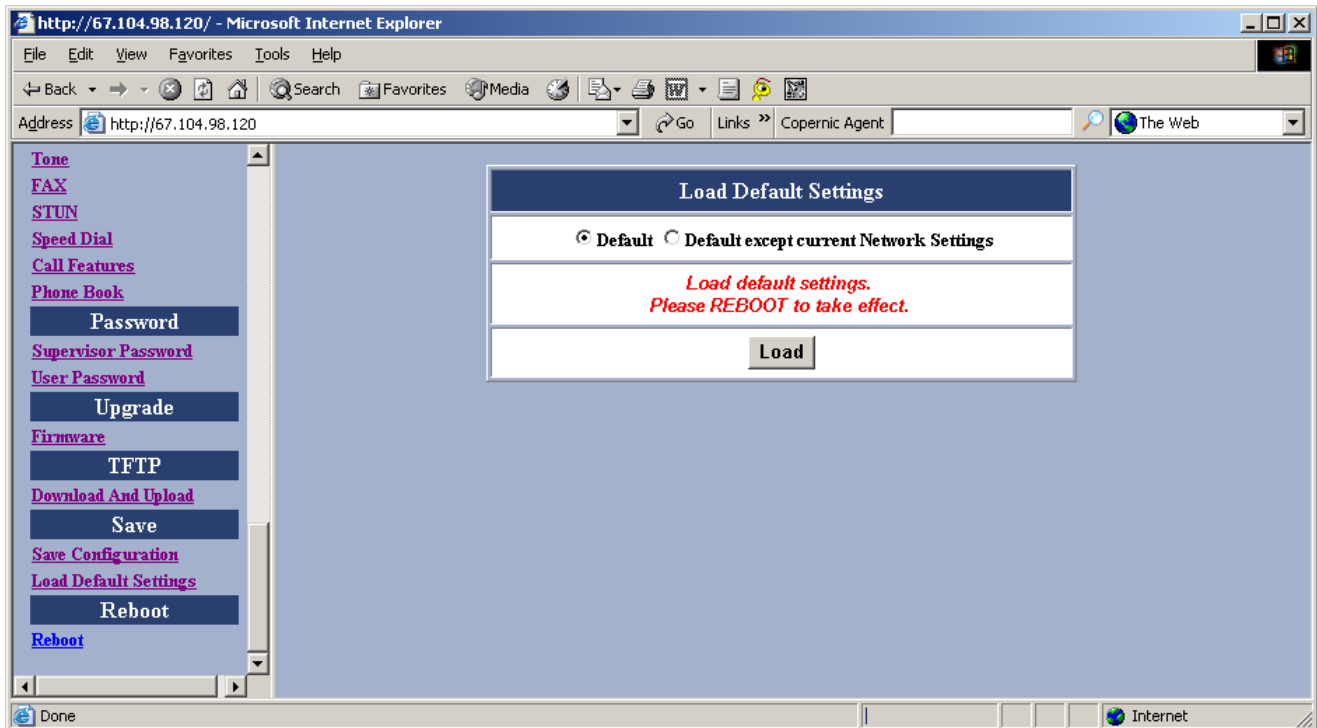

Figure 47 – Load Default Settings Window

Item	Description
Default	All value will reset to default
Default except current Network Settings	All value will reset to default while the network setting (WAN IP) still remain.

3.15.3 Reboot

Once you click **Reboot**, the system will restart and be updated with new configuration data stored in the flash memory.

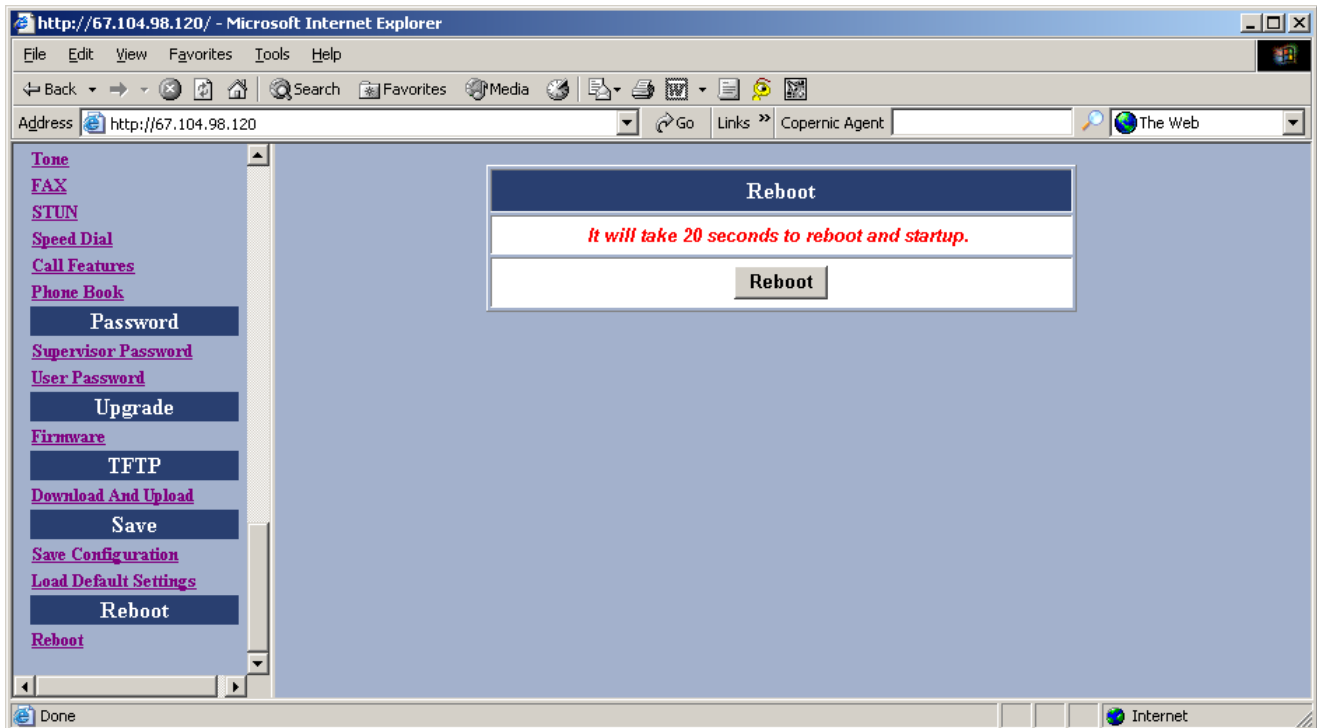

Figure 48 – Reboot Window

Appendix A: Troubleshooting

This section covers possible problems that may be encountered while using the BMG7011 and BMG7012 VoIP Gateways and suggested solutions to them. If you follow the suggested solutions below, but the BMG7011 and BMG7012 VoIP gateways still do not work properly, contact technical support for further advice.

Q: Power LED does not light up.

S: First check the AC adapter rating. The input rating must meet the specification of the country. The AC adapter must be DC 12V/1.2A output.

S: If the AC adapter output is correct. The problem will be on the VoIP Gateway. Please replace the VoIP Gateway.

Q: Ethernet interface cannot work.

S: Make sure the Ethernet adapter card installed in the PC is workable. The technician can use Hub/Switch to test it.

S: Make sure the Ethernet cable is workable, and the connection between PC and the VoIP Gateway is secure.

Q: Broadband access cannot work.

S: Make sure the Ethernet cable is workable, and the connection between Broadband device and the VoIP Gateway is secure.

S: Check the DHCP or PPPoE server setting. You have to enter correct username and password for PPPoE registration.

Q: Cannot download the proper configuration file.

S: Check if the connection between Provisioning Server and the VoIP Gateway is secure.

S: Check if the file name and setting of Provisioning file are correct.

Q: VoIP LED does not light up.

S: Check if configuration file indicates correct IP address and information of Soft-Switch.

S: Check if the VoIP Gateway is able to connect to Soft-Switch.

S: Check if the authorization content between the VoIP Gateway and Soft-Switch are the same.

Q: Cannot use PSTN backup line.

S: Disconnect the VoIP Gateway from the power supply and then check if PSTN backup line is workable.

S: Check the settings of "PSTN switch key and digit map" are correct.

Appendix B: Specifications

SPECIFICATIONS

USER INTERFACE

Subscriber Port: 1-Port (7011), 2-Port (7012), RJ11

PSTN Port: 1-Port Back-up PSTN Life Line, RJ11

LAN Port: 1-Port, 10B-T/100B-TX, RJ45

NETWORK INTERFACE

WAN Port: 1-Port, 10B-T/100B-TX, RJ45

VOIP PROTOCOLS

Call Control: H.323 v4 and v2, SIPv2, MGCPv1

Audio CODEC: G.711 u/A-law, G.729a, G.723.1

Fax Transmission: T.38 Real-Time, 2.4k-19.2kbps Automatic Fax Detection

H.450 Supplementary Service H.235 Security

MANAGEMENT PROTOCOLS

TELNET, TFTP, SYSLOG, SNMP, HTTP Server, NTP, STUN, PPPoE Client, DHCP Client

UNIT PERFORMANCE

Typical Unit Latency: G.711; 50ms, G.729a; 55ms, G.723.1; 135ms

Echo Cancellation: G.168, 30dB, 16ms

POWER REQUIREMENT

DC Input: 12VDC, 1A Power Adapter: Universal, 100 - 230VAC, 50/60Hz, 18W

PHYSICAL SPECIFICATIONS

Dimensions: W190(7.5) x D130(5) x H30(1.2) mm (in) Weight: 340g (0.75 lbs) Without Power Adapter

ENVIRONMENTAL

Operating Temperature: 0°C(32°F) To 40°C(104°F)

Storage Temperature: -10°C(14°F) To 70°C(158°F)

Operating Humidity: 10% To 90% Relative, Non-Condensing

Storage Humidity: 5% To 95% Relative, Non-Condensing

REGULATORY CERTIFICATIONS

Safety: UL60950, EN60950

EMC: FCC Part 15 Class B, EN55022 Class B, CE marking Telecom: FCC Part 68, CTR21

Manufacturing: ISO 9001

Free Manuals Download Website

<http://myh66.com>

<http://usermanuals.us>

<http://www.somanuals.com>

<http://www.4manuals.cc>

<http://www.manual-lib.com>

<http://www.404manual.com>

<http://www.luxmanual.com>

<http://aubethermostatmanual.com>

Golf course search by state

<http://golfingnear.com>

Email search by domain

<http://emailbydomain.com>

Auto manuals search

<http://auto.somanuals.com>

TV manuals search

<http://tv.somanuals.com>