

C5500n

User's Guide



59381901

Copyright Information

Copyright © 2006 by Oki Data. All Rights Reserved

Document Information

C5500n User's Guide

P/N 59381901, Revision 1.1

January, 2006

Disclaimer

Every effort has been made to ensure that the information in this document is complete, accurate, and up-to-date. The manufacturer assumes no responsibility for the results of errors beyond its control. The manufacturer also cannot guarantee that changes in software and equipment made by other manufacturers and referred to in this guide will not affect the applicability of the information in it. Mention of software products manufactured by other companies does not necessarily constitute endorsement by the manufacturer .

While all reasonable efforts have been made to make this document as accurate and helpful as possible, we make no warranty of any kind, expressed or implied, as to the accuracy or completeness of the information contained herein.

The most up-to-date drivers and manuals are available from the web site:

<http://www.okiprintingsolutions.com>

Trademark Information

Oki and Microline are registered trademarks of Oki Electric Industry Company Ltd. Apple, Macintosh and Mac OS are registered trademarks of Apple Computers Inc. ENERGY STAR is a trademark of the United States Environmental Protection Agency.

Hewlett-Packard, HP, and LaserJet are registered trademarks of Hewlett-Packard Company.

Microsoft, MS-DOS and Windows are either registered trademarks or trademarks of Microsoft Corporation in the United States and/or other countries.

Other product names and brand names are registered trademarks or trademarks of their proprietors.

Regulatory Information



As an ENERGY STAR® Program Participant, the manufacturer has determined that this product meets the ENERGY STAR guidelines for energy efficiency.



This product complies with the requirements of the Council Directives 89/336/EEC (EMC), 73/23/EEC (LVD) and 1999/5/EC (R&TTE), as amended where applicable, on the approximation of the laws of the member states relating to Electromagnetic Compatibility, Low Voltage and Radio & Telecommunications Terminal Equipment.

Contents

Copyright Information	2
Document Information	2
Disclaimer	2
Trademark Information	2
Regulatory Information	2
Notes, Cautions, etc.	6
Introduction	7
Features	7
Options	7
Parts of the Printer	8
Front	8
Rear	9
Paper (Print Media)	10
General Information	10
Paper Weights	11
Paper, US Bond	13
Paper, Index	15
Letterhead	17
Envelopes	21
Labels	23
Transparencies	26
Paper Trays	29
Windows	29
Macintosh	29
Paper Size Check	31
Paper Size, Feed, and Exit	32
Tray 1 and Optional Tray 2	32
Auto Switching	33
Multi-Purpose Tray (MP Tray) [Manual Feed]	35
Paper Exit Paths	38
Face Down (Top Exit)	38
Face Up (Rear Exit)	38
Duplex Unit	40
Loading Paper	41
Trays 1 and 2	41
Multi-Purpose (MP) Tray	45
Consumables	48
Life Expectancy	48

Part Numbers	48
Replace a Toner Cartridge	49
Replace an Image Drum	57
Replace the Fuser	66
Replace the Belt Unit	71
Printer Settings	
(Menu Settings)	77
Print a list of the current settings.	77
Changing Settings	78
Reset to Factory Defaults	80
Lists of Available Settings by Menu	81
Menu Defaults	95
Options	100
RAM Memory.	100
Duplex Unit.	101
Second Paper Tray.	102
Specifications	103
Troubleshooting	105
General Information.	105
Display Panel Messages	106
Paper Jams	110
Print Quality Problems	132
USB Problems	136
Application error	138
General Protection Fault	138
Paper Size Change Request	139
Printer does not go online.	139
Printer makes a strange noise	139
Printer takes a long time to start printing	140
Printing cancels	140
Printing does not start	141
Printing is slow	141
Cleaning	142
Printer Drivers.	143
General Information.	143
Macintosh	144
Printer Features	148
Overview	148
Banners	149
Black Printing	151
Booklets (Binding Print)	156
Collating.	160
Color Matching	163

Custom Page Sizes	192
Duplex Printing	195
Grayscale	201
N-Up Printing	202
Photographs	205
Posters	208
Print Resolution	210
Save as File	214
Toner Saving.	215
Watermarks	219
Utilities	223
Overview	223
Descriptions of Utilities.	224
Installing the Utilities	226
Color Correction Utility	228
Color Swatch Utility	243
Direct Network Printing Utility (LPR)	247
Display Language Utility	249
Network Setup Utility	250

Notes, Cautions, etc.

NOTE

A note appears like this. A note provides additional information to supplement the main text which helps you to use and understand the product.

Important!

An important message appears like this. An important message provides supplemental information which can prevent potential problems.

CAUTION!

A caution appears like this. A caution provides additional information which, if ignored, may result in equipment malfunction or damage.

WARNING!

A warning appears like this. A warning provides additional information which, if ignored, may result in a risk of personal injury.

Introduction

Your new printer is designed with advanced features to give you clear, vibrant color printing and crisp black and white pages at high speed on a range of print media.

Features

- Up to 20 pages per minute full color.
- Up to 24 pages per minute in black and white.
- 600 x 1200 dpi (dots per inch) print resolution.
- Single Pass Color Digital LED technology.
- Hiper-C emulation.
- 10 Base-T and 100 Base-TX network connection.

Options

- Additional Memory: see page 100
64 MB or 256 MB
- Duplex Unit: see page 101
for automatic two-sided printing
- Second Paper Tray: see page 102.
capacity 530 sheets 20-lb. paper

Parts of the Printer

Front

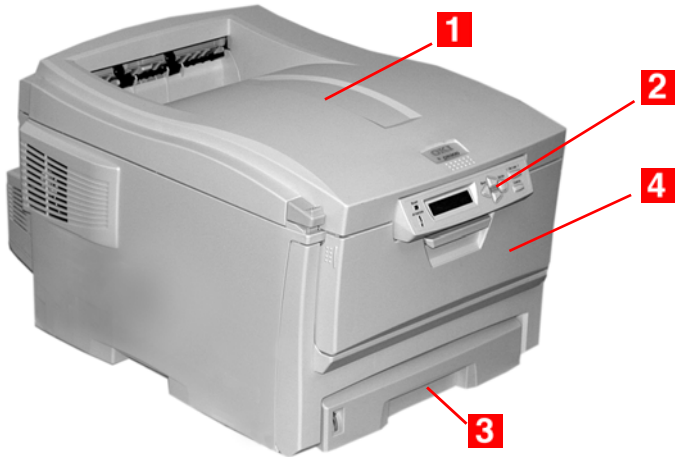

- 1.** Output Stacker, face down
Standard printed copy delivery point.
Holds up to 250 sheets of 20-lb. (75 g/m²) paper.
- 2.** Operator Panel
Menu driven operator controls and LCD display panel
- 3.** Paper Tray
Standard paper tray.
Holds up to 300 sheets of 20-lb. (75 g/m²) paper.
- 4.** Multi-Purpose Tray
Used for feeding transparencies, heavier paper stocks, envelopes and other special media.
Also for manual feeding of single sheets when required.

Rear

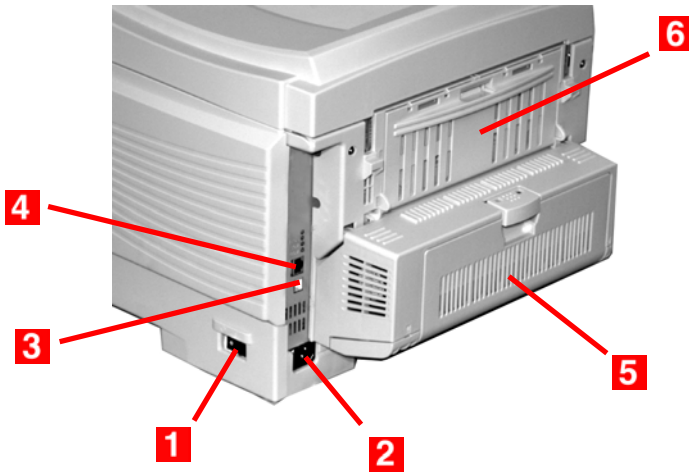

1. On/Off Switch
2. Socket for Power Cord
3. USB Interface
4. Network Interface
5. Optional Duplex Unit
6. Rear Stacker (face up)
Capacity 100 sheets

When the rear paper stacker is folded down, paper exits the printer through the rear of the printer and is stacked face up.

This is used for labels, heavy print media, envelopes and custom paper sizes.

When used with the Multi-Purpose Tray, the paper path through the printer is essentially straight. This avoids bending the print media around curves in the paper path and makes paper feeding more reliable.

Paper (Print Media)

General Information

CAUTION!

Print media must be able to withstand 446°F (230°C) for 0.2 second.

You need to know three characteristics about any paper (print media) you want to use with your printer:

- Type
- Weight
- Size

The type, weight, and size of the paper (print media) determine:

- which paper feed tray can be used
Choices are multipurpose tray (MP Tray/manual feed) or Trays 1 - 2
- which paper exit path can be used
Choices are face-down or face-up (straight-through)
- whether you can use double sided (duplex) printing

For type, see

- Paper: US Bond (Metric): see page 13
- Paper: Index: see page 15
- Letterhead: see page 17
- Envelopes: see page 21
- Transparencies: see page 26
- Labels: see page 23

For weight, refer to the correct paper type. Each paper type has a table (matrix) of paper size, paper weight, paper feed, paper exit, simplex/duplex correlations.

For general information on paper sizes, see "Paper Size, Feed, and Exit" on page 32.

Paper Weights

General Information

Designation	Weight	Feed Tray	Duplexer?	Exit Tray
Light	16-19 lb. US Bond (60-71 g/m ²)	Tray 1 Tray 2	No	Top ^a Rear ^b
Medium	20-27 lb. US Bond (75-101 g/m ²)	Tray 1 Tray 2 MP Tray	Yes	Top Rear
Heavy	28-32 lb. US Bond (105-120 g/m ²)	Tray 1 Tray 2 MP Tray	Yes (restricted to 28 lb. maximum)	Rear Only
Ultra Heavy	33-54 lb. US Bond (124-203 g/m ²)	Tray 2 ^c MP Tray	No	Rear Only

- a. Face Down Stacker
- b. Face Up Stacker
- c. 47 lb. (177 g/m²) maximum for Tray 2

Windows

1. Open the file you want to print.
2. Click File → Print.
3. In the Print dialog box, select your printer.
4. Next:
Windows 98/Me/NT4.0: click Properties.
Windows XP: click Preferences.
Windows 2000: go to the next step.
5. On the Setup tab, under Weights, make your selection.

Macintosh

OS 10.2 and 10.3

1. Open the file you want to print.
2. Click File → Print.

3. Open the drop-down list below Presets. Select Printer Option.
4. At Media Weight, make your selection.

Important!

If you are printing on a thick media such as card stock, be sure to select one of the thicker settings to get proper fusion of the toner to the page and to prevent possible damage to the printer.

Select the thickness/type of media on which you are printing a particular job, to produce optimum print results. This setting overrides the setting in the printer menu. The default printer menu setting is Medium.

Light

16-19 lb. US Bond (60-71 g/m²)

Medium

20-27 lb. US Bond (75-101 g/m²)

Heavy

28-32 lb. US Bond

58-67 lb. Index (105-120 g/m²)

Ultra Heavy

33-54 lb. US Bond

68-113 lb. Index (124-203 g/m²)

5. Change any other settings as desired.
6. Click Print.

Paper, US Bond

Paper Feed, Exit Path, and Duplex

General Information

NOTE

To determine if a paper weight is US Bond or Index, check the metric equivalent.

35 lb US Bond = 132 g/m²

35 lb Index = 64 g/m²

For more information, go to www.paper-paper.com/weight.html

The size, weight, and type of the paper (print media) determine:

- which paper feed tray can be used
- which paper exit path can be used
- whether you can use double sided (duplex) printing

Single sided printing is also known as simplex printing.

These settings can be made in the printer menu or in the printer driver.

Application settings override driver settings.

Driver settings override printer menu settings.

The best performance is obtained when using paper designed for use in copiers and laser printers. Suitable types include:

- Hammermill® Laser Printer Radiant White, 24 lb. US Bond (90 g/m²)
- Xerox® 4024, 20 lb. US Bond (75 g/m²)
- Oki® 52206101 Bright White Proofing Paper, 32 lb. US Bond (120 g/m²)

Recommendations

- Check www.okiprintingsolutions.com for the latest information on recommended papers for your printer.
- Paper should be stored flat, away from moisture, direct sunlight and heat sources.
- **The use of heavily laid or textured paper will seriously affect the life of the image drum and give poor print quality.** Print quality can be improved by changing the media setting to 'Ultra Heavy.' However, this will reduce the output speed and prevent the use of the duplex option.
- *Avoid:*
 - Damp, damaged or curled paper.
 - Very smooth, shiny or glossy paper.
 - Heavily embossed letterhead paper, very rough paper or paper that has a large grain difference between the two sides.
 - Paper with perforations, cut-outs or ragged edges.
 - Carbon paper, recycled paper, NCR paper, photosensitive paper, pressure sensitive paper or thermal transfer paper.

General Information

NOTE

To determine if a paper weight is US Bond or Index, check the metric equivalent.

- 35 lb US Bond = 132 g/m²
- 35 lb Index = 64 g/m²

For more information, go to www.paper-paper.com/weight.html

The size, weight, and type of the paper (print media) determine:

- which paper feed tray can be used
- which paper exit path can be used
- whether you can use double sided (duplex) printing

Single sided printing is also known as simplex printing.

These settings can be made in the printer menu or in the printer driver.

Application settings override driver settings.

Driver settings override printer menu settings.

The best performance is obtained when using paper designed for use in copiers and laser printers. Suitable types include:

- Hammermill® Laser Printer Radiant White, 24 lb. US Bond (90 g/m²)
- Xerox® 4024, 20 lb. US Bond (75 g/m²)
- Oki® 52206101 Bright White Proofing Paper, 32 lb. US Bond (120 g/m²)

Recommendations

- Check www.okiprintingsolutions.com for the latest information on recommended papers for your printer.
- Paper should be stored flat, away from moisture, direct sunlight and heat sources.
- **The use of heavily laid or textured paper will seriously affect the life of the image drum and give poor print quality.** Print quality can be improved by changing the media setting to 'Ultra Heavy.' However, this will reduce the output speed and prevent the use of the duplex option.
- *Avoid:*
 - Damp, damaged or curled paper.
 - Very smooth, shiny or glossy paper.
 - Heavily embossed letterhead paper, very rough paper or paper that has a large grain difference between the two sides.
 - Paper with perforations, cut-outs or ragged edges.
 - Carbon paper, recycled paper, NCR paper, photosensitive paper, pressure sensitive paper or thermal transfer paper.

General Information

The size, weight, and type of the paper (print media) determine:

- which paper feed tray can be used
- which paper exit path can be used
- whether you can use double sided (duplex) printing

Single sided printing is also known as simplex printing.

These settings can be made in the printer menu or in the printer driver.

Application settings override driver settings.

Driver settings override printer menu settings.

When using heavily laid or textured paper

- the life of the image drum is seriously shortened
- print quality may deteriorate
- change the media setting to 'Ultra Heavy'.

This will improve print quality.

When using 'Ultra Heavy':

- print speed slows
- duplexing *cannot* be used.

Recommendations

CAUTION

Print media must be able to withstand 446°F (230°C) for 0.2 second.

Only use letterhead designed for color laser printers and photocopiers.

Don't use very smooth, shiny or glossy paper.

Don't use heavily embossed headed paper, very rough paper or paper that has a large grain difference between the two sides.

- Check www.okiprintingsolutions.com for the latest information on recommended papers for your printer.
- Paper should be stored flat, away from moisture, direct sunlight and heat sources.
- **The use of heavily laid or textured paper will seriously affect the life of the image drum and give poor print quality.** Print quality can be improved by changing the media setting to 'Ultra Heavy.' However, this will reduce the output speed and prevent the use of the duplex option.
- *Avoid:*
 - Damp, damaged or curled paper.
 - Very smooth, shiny or glossy paper.
 - Heavily embossed letterhead paper, very rough paper or paper that has a large grain difference between the two sides.
 - Paper with perforations, cut-outs or ragged edges.
 - Carbon paper, recycled paper, NCR paper, photosensitive paper, pressure sensitive paper or thermal transfer paper.

Loading

Trays 1 and 2

Long edge feed

Face down, top toward the back of the printer.

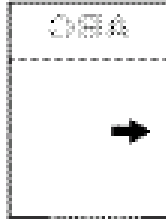

Short edge feed

face down, top to the right

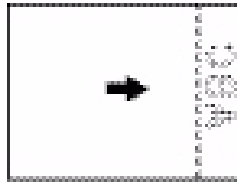

Loading

Manual Feed (MP Tray)

Long edge feed

Face up, top to the back of the printer

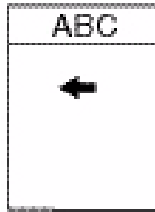

Short edge feed

Face up, top to the left

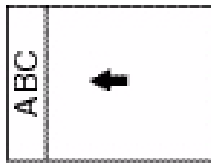

Envelopes

General Information

Envelopes can *only* be fed from the multi-purpose (MP / manual feed) tray.

Envelopes can *only* exit the printer *face-up*.

Recommendations

CAUTION

Print media must be able to withstand 446°F (230°C) for 0.2 second.

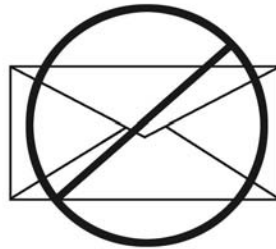
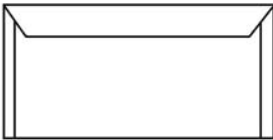

1. Use only recommended envelopes.
Oki 52206301 and 52206302:
For more information, see "Print Media, Oki" in your *Handy Reference Guide* or www.okiprintingsolutions.com.
2. Store envelopes flat and away from
 - moisture
 - direct sunlight
 - heat sources
3. Don't use envelopes with
 - windows
 - metal clasps
 - self-sealing flaps

- damp, damaged or curled paper envelopes

Loading

Trays 1 - 2

Envelopes *cannot* be fed from paper trays 1 - 2.

Multi-purpose Tray

Face up (flap side *down*), top to the left (into the printer)

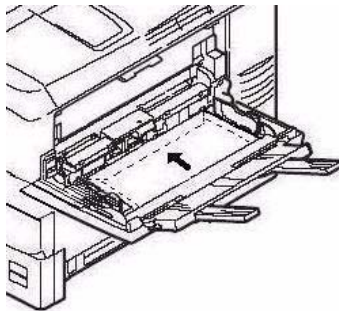

Labels

General Information

Labels can *only* be fed from the multi-purpose (MP / manual feed) tray.

Labels can *only* exit the printer *face-up*.

Avery 5161 White Laser Labels (letter size) work well with your printer.

Check www.okiprintingsolutions.com for the latest information on media for your printer.

Recommendations

CAUTION

Print media must be able to withstand 446°F (230°C) for 0.2 second.

- Only use labels designed for color laser printers and photocopiers.
- Labels must cover the entire carrier sheet.
- The carrier sheet or adhesive must not be exposed to any part of the printer.

Loading

Trays 1 - 2

Labels *cannot* be fed from paper trays 1 - 2.

Manual Feed (MP Tray)

Face up (print side *up*)

Default = long edge feed.

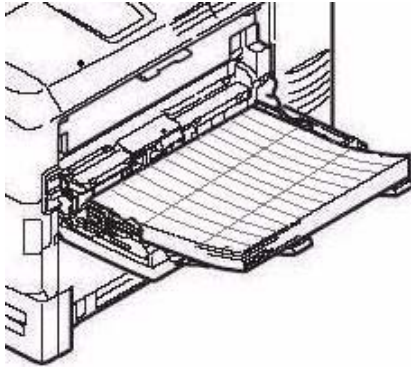

Windows

NOTE

Recommended labels for best print results:
Avery 5161 White Laser Label (Letter size);
Avery 7162, 7664, 7666 White Laser Labels
(size A4).

Macintosh

OS 10.2 and 10.3

NOTE

Recommended labels for best print results:
Avery 5161 White Laser Label (Letter size);
Avery 7162, 7664, 7666 White Laser Labels
(size A4).

1. Open the file you want to print.
2. Click File → Print.
3. Open the drop-down list below Presets. Select Printer Option.
4. At Media Weight, make your selection.
Labels1: For labels 0.1 to 0.169 mm thick.
Labels2: For labels 0.17 to 0.2 mm thick.
5. Change any other settings as desired.
6. Click Print.

Transparencies

General Information

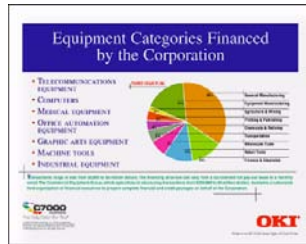

Transparencies can *only* be fed from the multi-purpose (MP / manual feed) tray.

Transparencies can *only* exit the printer *face-up*.

Recommendations

CAUTION

Print media must be able to withstand 446°F (230°C) for 0.2 second.

1. Only use transparencies designed for color laser printers and photocopiers.
2. Only use recommended transparencies
Oki 52205701
3M CG3720
3. Avoid office transparencies designed for use by hand with marker pens.
These will melt in the fuser and cause damage.

Loading

Trays 1 - 2

Transparencies *cannot* be fed from paper trays 1 - 5.

Manual Feed (MP Tray)

Face up (print side *up*)

Default = long edge feed.

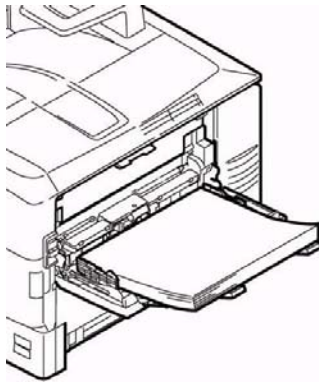

Windows

1. Open the file you want to print.
2. Click File → Print.
3. In the Print dialog box, select your printer.
4. Next:
Windows 98/Me/NT4.0: click Properties.
Windows XP: click Preferences.
Windows 2000: go to the next step.
5. On the Setup tab, under Weight, select Transparencies.

Macintosh

OS 10.2 and 10.3

NOTE

Use only recommended transparencies (3M CG3720, Oki 52205701).

1. Open the file you want to print.
2. Click File → Print.
3. Open the drop-down list below Presets. Select Printer Option.
4. At Media Weight, select Transparency.
5. Change any other settings as desired.
6. Click Print.

Paper Trays

Windows

1. Open the file you want to print.
2. Click File → Print.
3. In the Print dialog box, select your printer.
4. Next:
Windows 98/Me/NT4.0: click Properties.
Windows XP: click Preferences.
Windows 2000: go to the next step.
5. On the Setup tab, under Source, make your selection:
Automatically select
The printer automatically selects the paper tray.
Multi Purpose Tray / Tray1 / Tray 2
Tray 2 appears only if an optional tray is installed.
Select a specific paper tray.
For example:
You are printing a job on special media (letterhead).
Place the media in the Multi Purpose Tray.
Select the Multi Purpose Tray here (in the driver) when printing the job.

Macintosh

OS 10.2 and 10.3

1. Open the file you want to print.
2. Click File → Print.
3. Open the drop-down list below Presets. Select Paper Source.
4. Make your selection.
Auto
The printer automatically selects the paper tray.
Multi Purpose Tray / Tray1 / Tray 2
Tray 2 appears only if an optional tray is installed.
Select a specific paper tray.

For example:

You are printing a job on special media (letterhead).

Place the media in the Multi Purpose Tray.

Select the Multi Purpose Tray here (in the driver) when printing the job.

- 5.** Change any other settings as desired.
- 6.** Click Print.

Paper Size Check

General Information

If Paper Size Check is turned on (enabled), the printer checks whether the size paper loaded in the selected tray matches that required for the document being printed.

Windows

1. Open the file you want to print.
2. Click File → Print.
3. In the Print dialog box, select your printer.
4. Next:
Windows 98/Me/NT4.0: click Properties.
Windows XP: click Preferences.
Windows 2000: go to the next step.
5. On the Setup tab, click Paper feed options.
6. Select Media Check.

Macintosh

OS 10.2 and 10.3

1. Open the file you want to print.
2. Click File → Print.
3. Open the drop-down list below Presets. Select Printer Option.
4. Make your selection for Paper size check.
If the box has a check mark, the feature is ON.
If the box is empty, the feature is OFF.
5. Change any other settings as desired.
6. Click Print.

Paper Size, Feed, and Exit

Tray 1 and Optional Tray 2

Paper size	Feed		Exit	
	Tray 1	Tray 2	Top ^a	Rear ^b
Letter (8½ x 11")	S, D ^c	S, D	S, D	S, D
Legal-14 (8½ x 14")	S, D	S, D	S, D	S, D
Legal-13.5 (8½ x 13.5")	S, D	S, D	S, D	S, D
Legal-13 (8½ x 13")	S, D	S, D	S, D	S, D
Executive (7¼ x 10½")	S, D	S, D	S, D	S, D
A4 (210 x 297 mm)	S, D	S, D	S, D	S, D
A5 (145 x 210 mm)	S, D	S, D	S, D	S, D
A6 (105 x 148 mm)	S	Not Usable	Not Usable	S
B5 (182 x 257 mm)	S, D	S, D	S, D	S, D
Custom	S: <i>min.</i> 3.94 x 5.83" [100 x 148 mm], D: <i>min.</i> 5.8 x 8.25" [148 x 210 mm] S, D: <i>max.</i> 8.5 x 14" [215.9 x 355.6 mm]	S: <i>min.</i> 3.94 x 5.83" [100 x 148 mm], D: <i>min.</i> 5.8 x 8.25" [148 x 210 mm] S, D: <i>max.</i> 8.5 x 14" [215.9 x 355.6 mm]	S, D	Not Usable.

- Use the Top Exit (Face Down Stacker) only for paper up to 47 lb. US Bond (98 lb. Index, 177 g/m²).
- Switch to the Rear Exit (Face Up Stacker) when you are printing paper heavier than 47 lb. US Bond (98 lb. Index, 177 g/m²).
- S = Simplex; D = Duplex (printing on both sides)

Auto Switching

General Information

If a paper tray (Tray 1) runs out of paper, your printer can automatically switch to another paper tray (MP Tray, optional Tray 2) loaded with the same type of paper. This is called Auto Switching.

This feature is enabled either through the printer menu or the printer driver.

Application settings override driver settings.

Driver settings override printer menu settings.

Printer Menu

This function is enabled in the Print Menu.

The factory default is ON.

To change the setting:

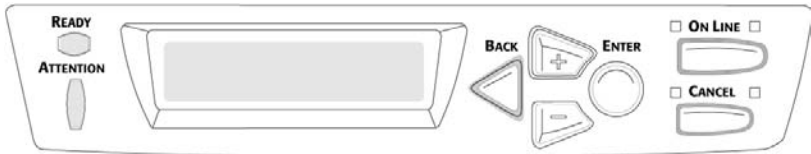

1. Press MENU + repeatedly until you see

PRINT MENU
AUTO TRAY SWITCH

2. Press ENTER.
3. Press MENU + repeatedly until you see

PRINT MENU
AUTO TRAY SWITCH

4. Press ENTER.
5. Press MENU + and/or MENU - repeatedly until you see the desired setting (ON or OFF).
6. Press ENTER to select the new setting.

7. Press ON LINE to exit the menu and return the printer to standby.

Macintosh

OS 10.2

This feature is not available in this operating system.

OS 10.3

1. Open the file you want to print.
2. Click File → Print.
3. Open the drop-down list below Presets. Select Printer Option.
4. At Auto tray switch, make your selection.
If the box has a check mark, the feature is ON.
If the box is empty, the feature is OFF.
5. Change any other settings as desired.
6. Click Print.

Multi-Purpose Tray (MP Tray) [Manual Feed]

General Information

This tray is also called the manual feed tray.

Use the Multi-Purpose Tray (MP Tray) for printing card stock, labels, envelopes and transparencies.

If a paper tray (Tray 1) runs out of paper, your printer can automatically switch to another paper tray (MP Tray, optional Tray 2) loaded with the same type of paper. This is called Auto Switching. See "Auto Switching" on page 33

- Capacity
 - stack of media about 3/8" (10 mm) high
 - about 10 envelopes
 - 50 transparencies
- Loading
 - print side *up*, top edge facing into the printer.
- Exit path
 - rear exit (Face Up Stacker), best for general use
 - top exit (Face Down Stacker), with restrictions
 - See "Paper Sizes and Exit Paths" on page 37
 - duplex (printing on both sides), with restrictions
 - See "Duplexing Restrictions" on page 36

Duplexing Restrictions

Important!

You can duplex

- paper
- paper weights up to
 - 28 lb. US Bond
 - 58 lb. Index
 - 105 g/m² metric

You *cannot* duplex

- labels
- envelopes
- transparencies
- paper weights above
 - 28 lb. US Bond
 - 58 lb. Index
 - 105 g/m² metric

Paper Sizes and Exit Paths

Paper size	Feed MP Tray	Exit Rear ^a	Exit Top ^b
Letter 8½ x 11"	Yes	Yes	Yes
Legal-14 8½ x 14"	Yes	Yes	Yes
Legal-13.5 8½ x 13.5"	Yes	Yes	Yes
Legal-13 8½ x 13"	Yes	Yes	Yes
Executive 7¼ x 10½"	Yes	Yes	Yes
A4 210 x 297 mm	Yes	Yes	Yes
A5 145 x 210 mm	Yes	Yes	Yes
B5 182 x 257 mm	Yes	Yes	Yes
Envelopes COM-10	Yes	Yes	No
Custom Minimum 3.94 to 5.83" 100 x 148 mm Maximum 8½ x 14" 216 x 356 mm Banner ^c	Yes	Yes	No

- a. Use the Rear Exit (Face Up Stacker) for heavy paper, transparencies, envelopes, and labels.
- b. Use the Top Exit (Face Down Stacker) only for paper up to 47 lb. US Bond (98 lb. Index, 177 g/m²).
- c. Banner specifications:
 - Length: up to 47" (1.2 m)
 - Width Range = 8¼ to 8½" (210 to 215.9 mm)
 - Weight Range = 28 to 34 lb. US Bond (105 to 128 g/m²)
 - Path = Rear Exit (Face Up Stacker) only
 - Feed one sheet at a time.

Paper Exit Paths

Face Down (Top Exit) ---

- Capacity
 - up to 250 sheets of standard paper
 - 20-lb. US Bond
 - 42 lb. Index, 75 g/m² metric
- Paper Weights
 - up to 47 lb. US Bond
 - 98 lb. Index, 176 g/m² metric
- Print Sequence
 - Pages are printed in reading order
 - Page 1 first; last page on top, facing down

Face Up (Rear Exit) ---



Open the face up stacker at the rear of the printer and pull out the tray extension.

When the face up stacker is open, paper exits via this path, regardless of driver settings.

- Capacity
 - up to 100 sheets of standard paper
 - 20 lb. US Bond

42 lb. Index, 75 g/m²

- Paper Weights up to

NOTE

Always use this stacker and the Multi-Purpose Tray for paper stocks heavier than 47 lb. US Bond (98 lb. Index, 176 g/m² metric).

54 lb. US Bond

113 lb. Index

203 g/m² metric

- Print Sequence

Papers are printed face up.

For multi-page documents,

Select "Reverse order printing" in your application Print dialog box (Click File → Print).

This puts the printed stack in the correct order.

Duplex Unit

General Information

The Duplex Unit enables your printer to print on both sides of the page.

See “Duplex Printing” on page 195.

Loading Paper

Trays 1 and 2

NOTE

If you have the optional second paper tray installed:

- If you are printing from the 1st (upper) tray, you can pull out the 2nd (lower) tray and reload it while the printer is printing.
- If you are printing from the 2nd (lower) tray, *do not pull out the 1st (upper) tray while printing*. This will cause a paper jam.

1. Remove the paper tray from the printer.



2. Fan the paper to be loaded at the edges (**1**) and in the middle (**2**). Then tap the edges of the stack on a flat surface to make it flush again (**3**).

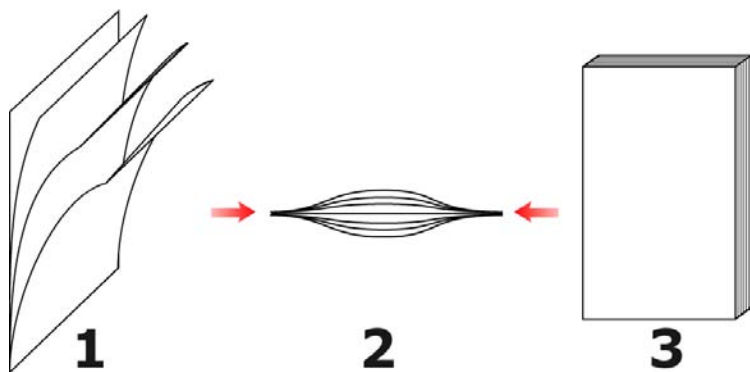

3. Load paper print side down. Make sure the rear stopper (1) and paper guides (2) are snug against the paper.

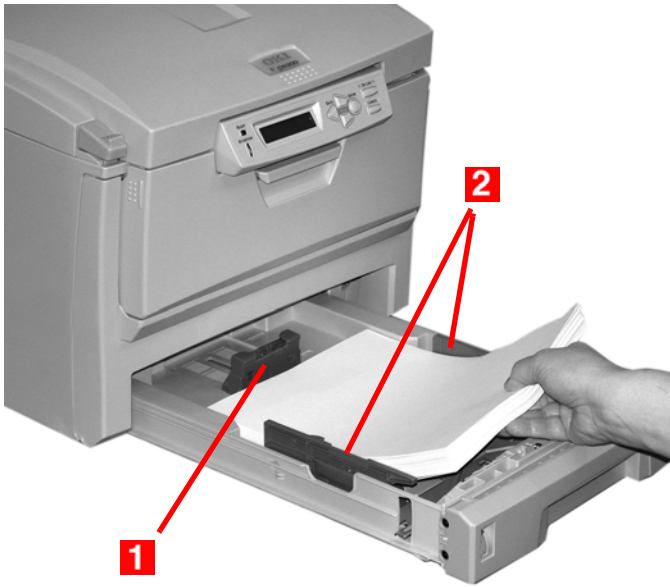

NOTE

Load letterhead paper face *down*. The top edge is aimed towards the front of the printer.

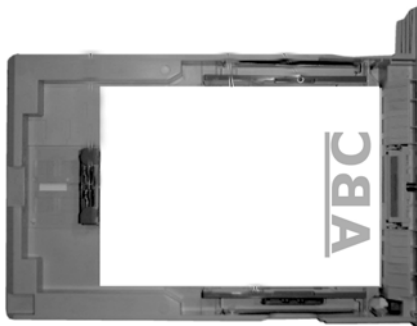

4. Gently close the paper tray.



NOTE

To prevent paper jams:

- Do not leave space between the paper and the guides and rear stopper.
- Do not overfill the paper tray. Capacity depends on the type of paper stock.
- Do not load damaged paper.
- Do not load paper of different sizes or types at the same time.
- Do not pull the paper tray out during printing (except as described above for the 2nd tray).

Multi-Purpose (MP) Tray

NOTE

The MP Tray will take

- a stack of media about 3/8" (10 mm) high
- about 10 envelopes
- about 50 transparencies.

Do not exceed the 3/8" (10 mm) media stack height.

1. Open the MP Tray.

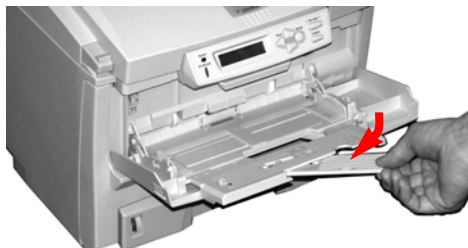
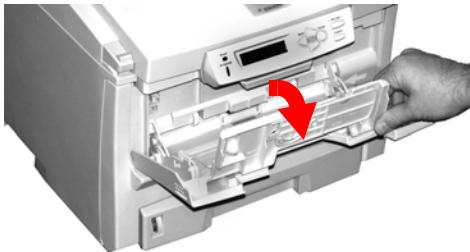

2. Press down on the loading platform.

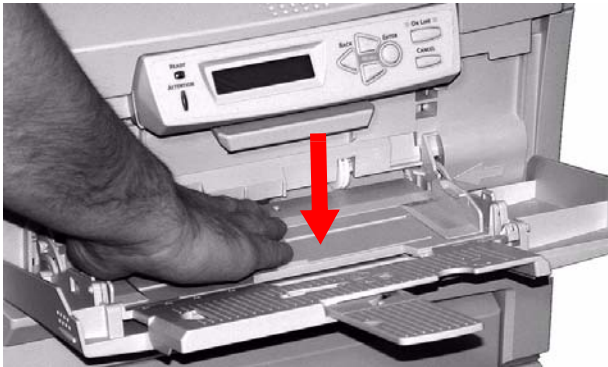

3. Load the print media. Adjust the guides (1) to the size media being used.

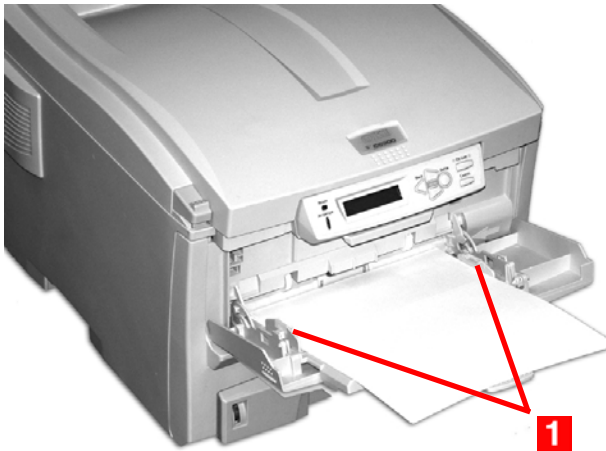

Letterhead:

Single-sided printing

load with pre-printed side *up* and the top edge *into* the printer.

Double-sided printing (duplex)

load with pre-printed side *down* and top edge *away from* the printer. (Optional duplex unit must be installed.)

Envelopes

Load print side up (flap down) with top edge to the left and short edge into the printer.

You cannot duplex envelopes.

4. Press the blue tray latch (1) toward the paper stack to lift the paper platform into the feed position.



Consumables

Life Expectancy

See "Specifications" on page 103

Part Numbers

Toner

Type C8

Black, High Capacity 43324404

Cyan, High Capacity 43324403

Magenta, High Capacity 43324402

Yellow, High Capacity 43324401

Black, standard 43381904

Cyan, standard 43381903

Magenta, standard 43381902

Yellow, standard 43381901

Image Drum

Type C8

Black 43381704

Cyan 43381703

Magenta 43381702

Yellow 43381701

Fuser

120 V 43363201

230V 43363202

Belt

Belt 43363401

Replace a Toner Cartridge



REPLACE TONER
nnn: zzzz TONER EMPTY

nnn: ZZZZ =

410: YELLOW

411: MAGENTA

412: CYAN

413: BLACK

1. Press the cover release. Open the printer's top cover fully.



WARNING!

If the printer has been powered on, the fuser is HOT. This area is clearly labelled. Do not touch it.

2. Note the positions of the four cartridges: Cyan (1), Magenta (2), Yellow (3), Black (4).

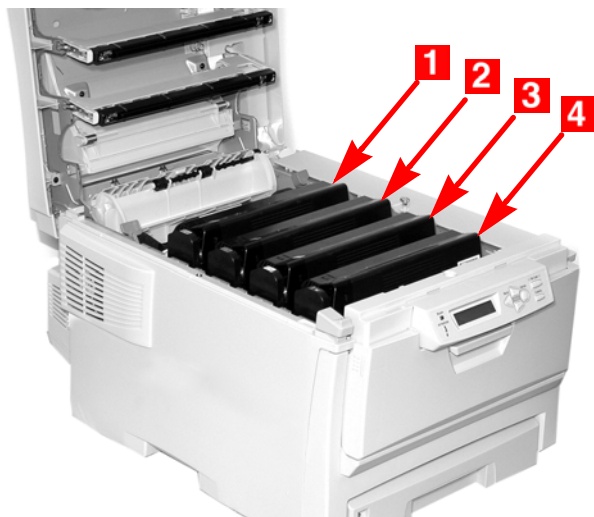

3. Pull the colored toner release lever on the cartridge to be replaced towards the front of the printer.
Shown: replacement of the black toner cartridge

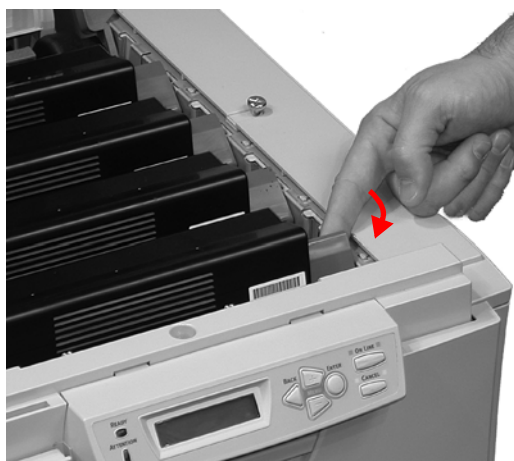

4. Lift the right-hand end of the cartridge. Then, pull the cartridge to the right to release the left-hand end. Remove the toner cartridge. Discard it in accordance with your local regulations.

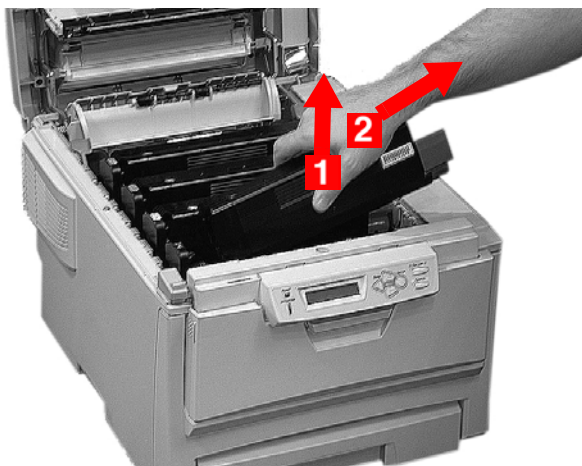

Install a Toner Cartridge

5. Unpack the new toner cartridge. Gently shake it *from side to side* to loosen and distribute the toner evenly inside the cartridge.



6. Remove the adhesive tape from the underside of the cartridge.



CAUTION!

Do not touch the toner release lever until the toner cartridge is installed in the image drum. If you do, it will open the toner release slot and spill toner.

7. Hold the cartridge by its top center with the colored release lever to the right. Insert the left end of the cartridge into the top of the image drum. Push it firmly against the spring on the drum unit.

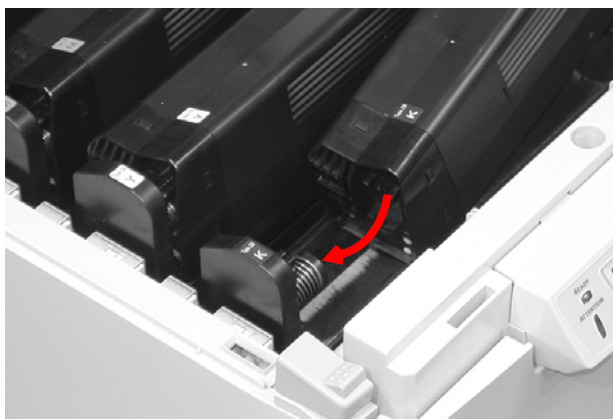
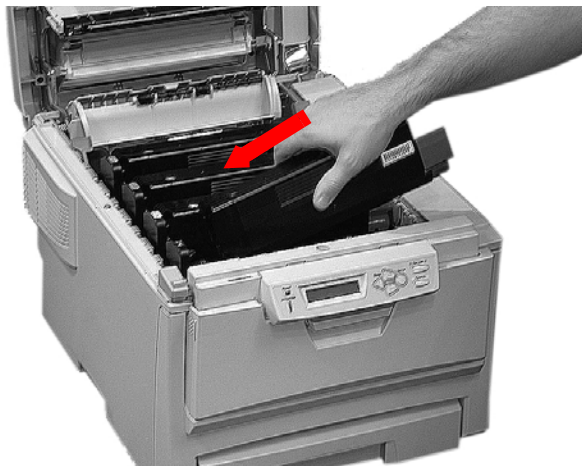

8. Lower the right end of the cartridge into the image drum unit. Press it firmly down in place. Then, push the colored lock lever back to open the toner slot and lock it in place.

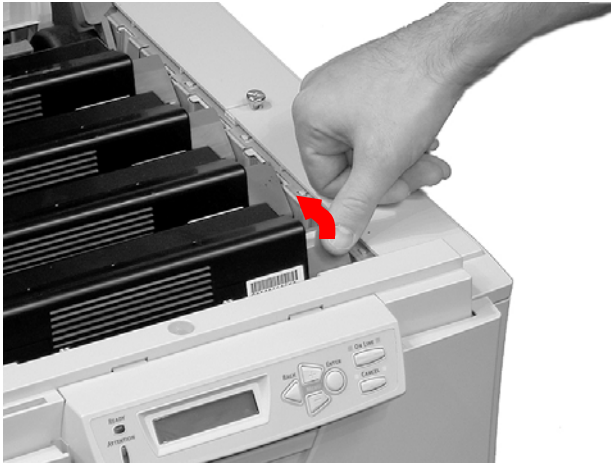

IMPORTANT!

The lever should move easily.

If it does not, **STOP!**

Push down on the toner cartridge to be sure that it is properly seated in the image drum. Press back on the lever again.

To avoid toner spillage, **DO NOT** open the toner release lever until the toner cartridge is firmly seated in the image drum.

9. Use the provided LED lens cleaner. Gently wipe the LED.



10. Close and latch the top cover.



Replace an Image Drum



REPLACE IMAGE DRUM
nnn: ZZZZ DRUM LIFE

nnn: ZZZZ =

350: YELLOW

351: MAGENTA

352: CYAN

353: BLACK

Important!

You must replace the toner cartridge when you replace the image drum. The life expectancy of the cartridge will be reduced as the toner charges the new drum.

1. Press the cover release and open the top cover fully.

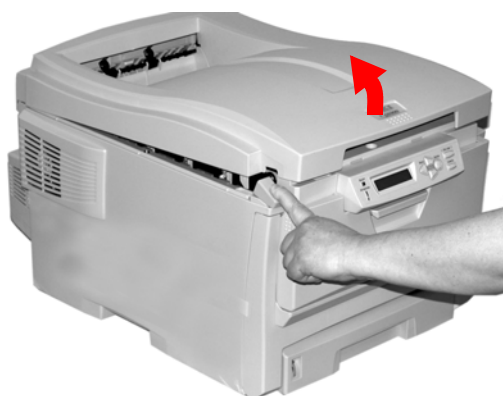

WARNING!

If the printer has been powered on, the fuser is HOT. This area is clearly labelled. Do not touch it.

2. Note the positions of the four image drums: Cyan (1), Magenta (2), Yellow (3), Black (4).

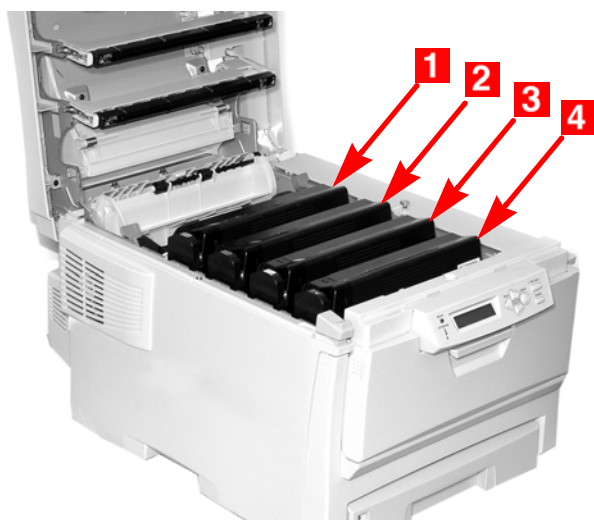

3. Lift the image drum, complete with its toner cartridge, out of the printer. Discard it in accordance with your local regulations.



4. Unpack the new image drum.

CAUTION!

Image drum handling

The image drum contains toner. To avoid spilling toner, be careful to *keep it upright*.



CAUTION!

The green surface at the base of each image drum is very delicate and light sensitive.

- Do not touch the green surface.
- Never expose the drum to direct sunlight or to very bright room lighting.
- Do not expose it to normal room light for more than 5 minutes.
- If the image drum must be out of the printer for longer than 5 minutes, place the image drum inside a black plastic bag or carefully place it in a drawer or cabinet to keep it away from light.

5. Grasp the white tape tab and peel the tape off the drum.



6. Remove the paper sheet. Then, remove the clear plastic film.

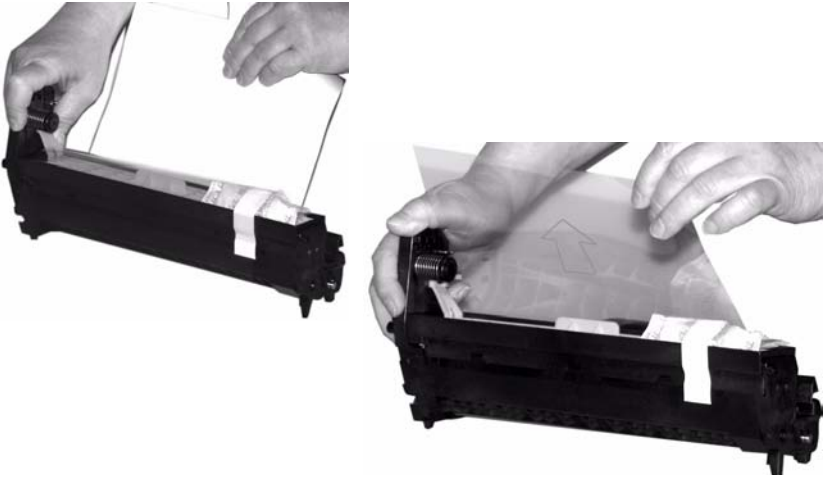

7. If present, remove the silica gel pack.



8. Place the image drum in the printer.



9. Remove the orange drum seal.



- 10.** Install the new toner cartridge in the image drum.
See "Install a Toner Cartridge" on page 53.

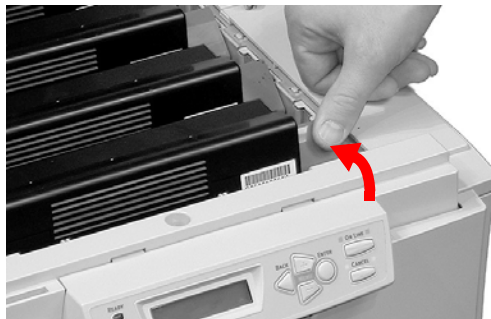
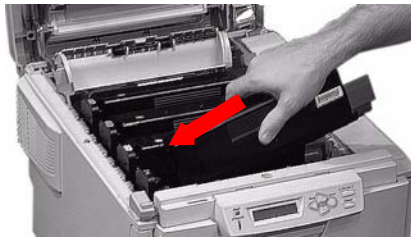

11. Use the provided LED lens cleaner. Gently wipe the LED.



12. Close and latch the top cover.



Replace the Fuser



REPLACE FUSER
354: FUSER LIFE

WARNING!

If the printer has been powered on, the *fuser is HOT*. This area is clearly labelled. Do not touch it. Handle the fuser with extreme care. Hold it only by its handle, which is only mildly warm to the touch.

If in doubt, switch the printer off. Wait at least 10 minutes for the fuser to cool before opening the printer cover.

1. Press the cover release. Fully open the printer's top cover.



2. Pull the two blue fuser lock levers (1) towards the front of the printer.

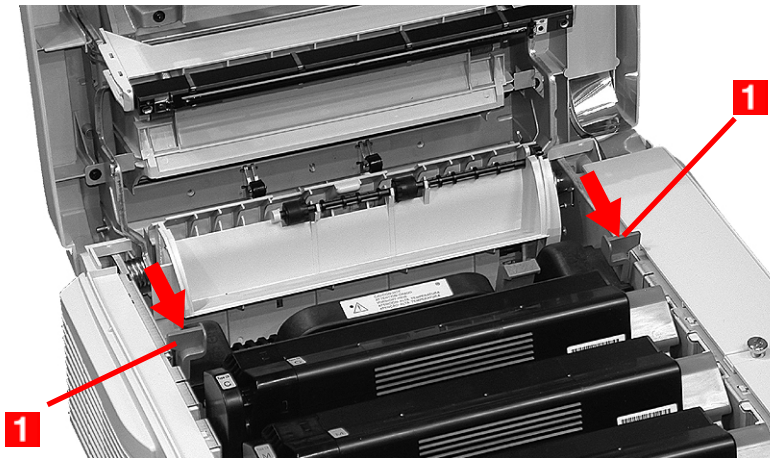

3. Hold the fuser **by its handle**. Lift the fuser out of the printer. *If the fuser is still warm, place it on a flat surface which will not be damaged by heat.* After letting the fuser cool down, discard it.



4. Remove the new fuser from its packaging. Remove any packing tape.
5. Push the orange transport lock to the left to release it. You'll hear it snap. Remove it.

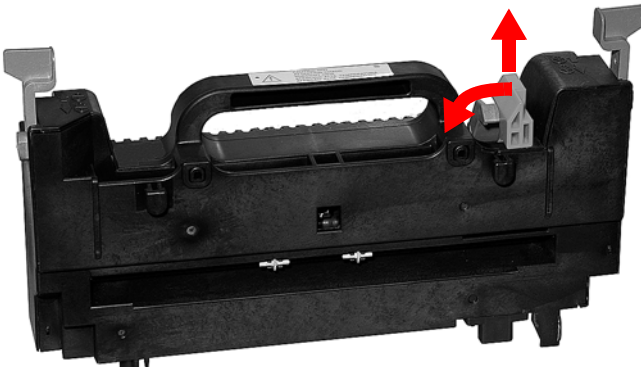

6. Hold the new fuser by the handle. The fuser pressure release lever (1) should be on the right. Lower the fuser into the printer.

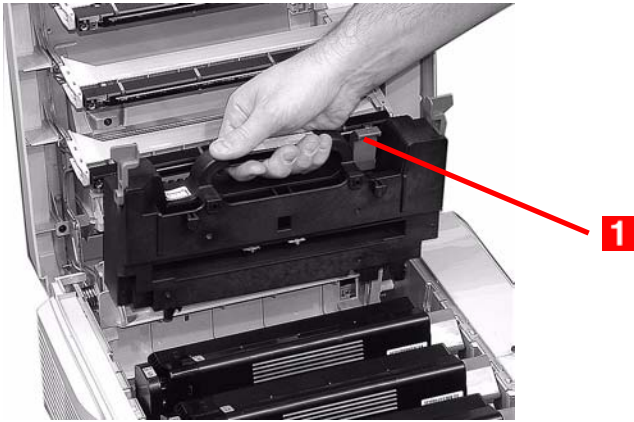

7. Push the two blue retaining levers (1) toward the rear of the printer to lock the fuser in place.

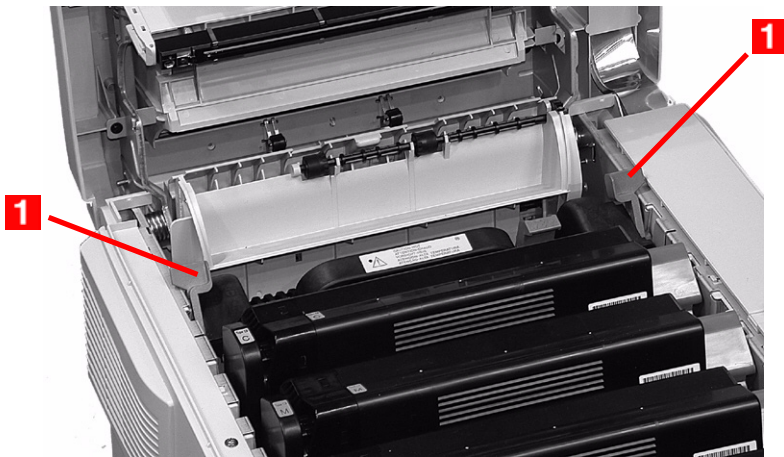

8. Close and latch the top cover.



Replace the Belt Unit

REPLACE BELT
355: BELT LIFE

The belt unit is located under the four image drums.

1. Press the cover release and open the top cover fully.



WARNING!

If the printer has been powered on, the *fuser* is *HOT*. This area is clearly labelled. Do not touch it.

2. Note the positions of the four image drums: Cyan (**1**), Magenta (**2**), Yellow (**3**), Black (**4**). **It is essential that they go back in the correct order!**

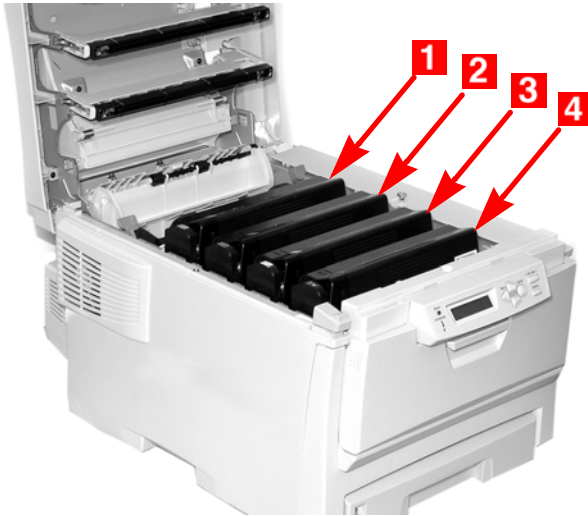

3. Lift each of the image drum units out of the printer. Place them on a *flat* surface in a safe place away from direct sources of heat and light.

CAUTION!

The green surface at the base of each image drum is very delicate and light sensitive.

- Do not touch the green surface.
- Never expose the drum to direct sunlight or to very bright room lighting.
- Do not expose it to normal room light for more than 5 minutes.
- If the image drum must be out of the printer for longer than 5 minutes, place the image drum inside a black plastic bag or carefully place it in a drawer or cabinet to keep it away from light.

4. Locate the two blue locks (1) and the handle (2).

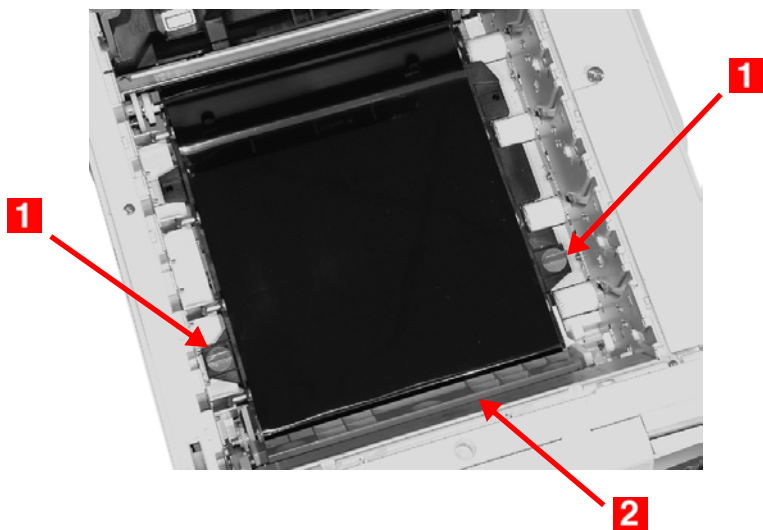

5. Turn the two locks about 45° *counterclockwise* to release the belt.

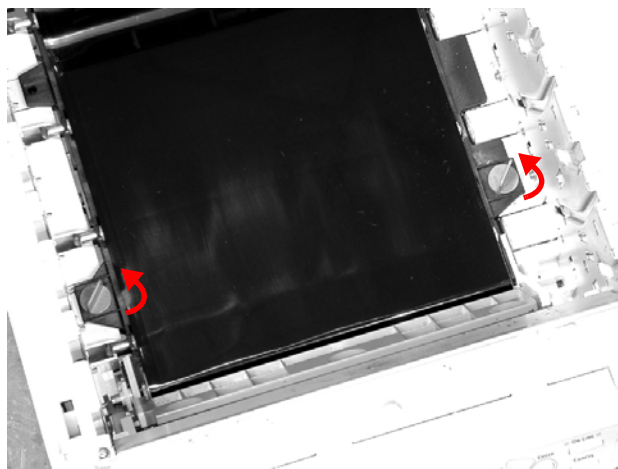

6. Pull up the handle and lift the belt unit out of the printer.



7. Unpack the new belt unit. Hold it with the blue handle toward the front of the printer.
8. Place the drive gear at the back of the belt unit in the gear at the left rear corner of the printer. Lower the belt unit into the printer.

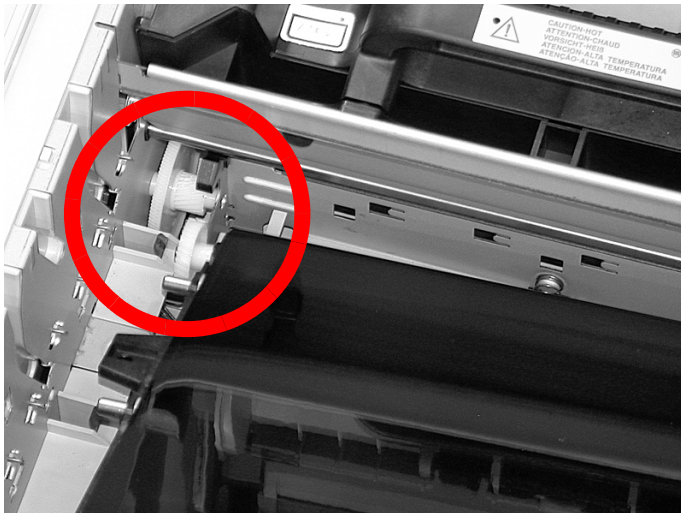

9. Turn the two belt locks about 45° clockwise to secure the belt unit in place.

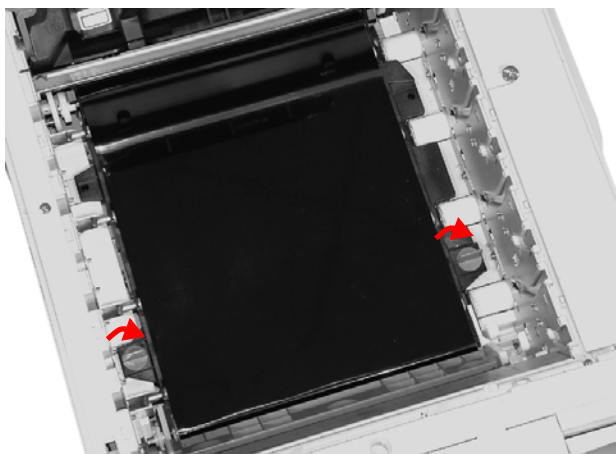

10. Place the four image drums/toner cartridges back in the printer (**1** = Cyan, **2** = Magenta, **3** = Yellow, **4** = Black). ***It is essential that they go back in the correct order!***

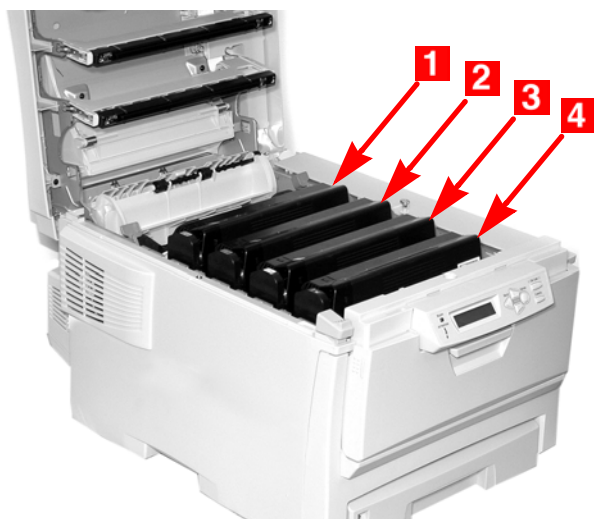

11. Close and latch the top cover.



Printer Settings (Menu Settings)

This section lists the menus accessed via the controls on the printer's operator panel and displayed in the LCD window.

Many of these settings can be overridden by settings in the printer driver. However, several of the driver settings can be left at "Printer Setting," which will then default to the settings entered in these printer menus

Print a list of the current settings

Menu Map

NOTE

... = keep pressing the button repeatedly until you see the display indicated.

To print a list of the current menu settings:

1. Press + ...

INFORMATION MENU

2. Press ENTER ...

PRINT MENU MAP
Execute

3. Press ENTER.
4. The Menu Map prints. The printer goes back on line.

Changing Settings

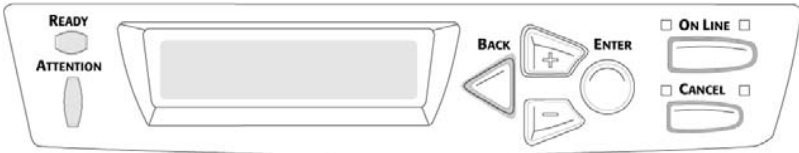

1. Press + to enter the menu mode.
2. Press +/- to scan through the available menus until the menu you wish to enter appears on the display.

NOTE

The menus and their various listings vary depending on which options you have installed on your printer.

3. Press ENTER to enter the menu.
4. Use +/- to move up and down through the items in the selected menu. When the item you want to change is displayed, press ENTER to edit that item.
5. Use +/- to move up and down through the available settings for this item.
6. When the setting you wish to use appears on the display, press ENTER.
An asterisk () appears next to the setting. The setting flashes.*
7. To finish:
 - a. If you are through making settings in the menu, press ON LINE to engage the setting and exit the menu.
 - b. If you wish to make additional changes in the menu, press BACK to engage the setting.
 - To change another setting in the same menu, use +/- to move through the list of menu items to the one you wish to change, then follow steps 5 through 7.
 - To change the setting for an item in a different menu, press BACK again, then follow steps 2 through 7.

Example: Power Save Time

To change the time interval for the printer to wait before going into Power Save mode (default setting is 60 MIN):

1. Press + to enter the menu mode.
2. Press + and/or - repeatedly until you see

SYS CONFIG MENU

3. Press ENTER to go into the Sys Config Menu.

POW SAVE TIME
60 MIN *

4. Press ENTER to select the Power Save Time item.
The value on the second line of the display begins flashing.

POW SAVE TIME
60 MIN *

5. Press + repeatedly until the interval (e.g., 240 MIN) you wish to select appears on the second line.

POW SAVE TIME
240 MIN

6. Press ENTER to select the new setting:
An asterisk appears on the second line of the display.

POW SAVE TIME
240 MIN *

7. Press ON LINE to engage the new setting and to exit the menu.
The printer returns to standby mode.

Reset to Factory Defaults _____

NOTE

... = keep pressing the button repeatedly until you see the display indicated.

To reset the printer menu to its original default settings:

1. Press + to enter the Menu mode.
2. Press + ...

MAINTENANCE MENU

3. Press ENTER.

MENU RESET
Execute

4. Press ENTER.
5. The printer resets and returns to the on-line state.

Lists of Available Settings by Menu _____

Information Menu

Item	Action	Explanation
PRINT MENU MAP	EXECUTE	Prints the MenuMap (menu listing) with current settings shown. Information about your printer is also shown at the top of each MenuMap page.
DEMO1	EXECUTE	Prints the built-in Demo page.

Print Menu

Notes:

Factory default settings are shown in **bold**.

Settings with a dagger (†) only appear when the appropriate option is installed.

Item	Settings	Explanation
COPIES	1 to 999	Enter the number of copies of a document to be printed.
DUPLEX†	ON OFF	Enables or disables duplex printing. †
PAPER FEED	TRAY1 TRAY2† MP TRAY	Selects the default tray for paper feed.
AUTO TRAY SWITCH	ON OFF	If two trays contain identical print media, the printer can switch to an alternate tray when the current tray runs out in the middle of a print job.
TRAY SEQUENCE	DOWN UP PAPER FEED TRAY	Sets the sequence in which the printer will seek an alternate tray with the same media size should the currently selected tray run out of media while printing a job.
MP TRAY USAGE	DO NOT USE WHEN MISMATCHXXX	If a document to be printed demands a paper size not installed in the selected tray, the printer can automatically feed from the Multi-Purpose Tray instead. If this function is not enabled, the printer will stop and request that the correct size be loaded.
MEDIA CHECK	ENABLE DISABLE	Set to DISABLE if you do not wish the printer to check to see if the size paper loaded in the selected tray matches that required for the document being printed.

Item	Settings	Explanation
MONO-PRINT SPEED	AUTO SPEED NORMAL SPEED COLOR SPEED	Sets the print engine speed. If you are printing only color documents, switch to COLOR SPEED. If you are printing only monochrome documents, switch to MONO 24PPM. AUTO SPEED sets the speed of printing based on whether the first page is color or monochrome. If you are printing a document with a color cover followed by mostly monochrome pages, use MIXED SPEED.

Media Menu

Notes:

- Factory default settings are shown in **bold**.
- Items with a dagger (†) only appear when the appropriate option is installed.

Item	Settings	Explanation
TRAY1 PAPERSIZE	A4, A5, A6, B5, LEGAL14, LEGAL13.5, LEGAL13, LETTER , EXECUTIVE, CUSTOM	Defines the size of paper loaded in Tray 1.
TRAY1 MEDIATYPE	PLAIN LETTERHEAD BOND RECYCLED ROUGH	Defines the type of media loaded in Tray 1. This will help the printer to adjust its internal operating parameters, such as engine speed and fusing temperature.
TRAY1 MEDIAWEIGHT	LIGHT, MEDIUM , HEAVY	Adjusts the printer for the weight of paper stock loaded in the tray. See "Paper Weights" on page 11.
TRAY2 PAPERSIZE†	A4, A5, B5, LEGAL14, LEGAL13.5, LEGAL13, LETTER , EXECUTIVE, CUSTOM	Defines the size of paper loaded in optional Tray 2.
TRAY2 MEDIATYPE†	PLAIN , LETTERHEAD, BOND, RECYCLED, ROUGH	Defines the type of media loaded in optional Tray 2.
TRAY2 MEDIAWEIGHT†	LIGHT, MEDIUM , HEAVY	Adjusts the printer for the weight of paper stock loaded in optional Tray 2.
MPT PAPERSIZE	LETTER , EXECUTIVE, LEGAL14, LEGAL13.5, LEGAL13, A4, A5, A6, B5, CUSTOM, COM-9 ENVELOPE, COM-10 ENVELOPE, MONARCH ENV, DL ENVELOPE, C5 ENVELOPE	Defines the size of paper to be fed from the Multi-Purpose Tray.

Item	Settings	Explanation
MPT PAPERTYPE	PLAIN , LETTERHEAD, TRANSPARENCY, LABELS, BOND, RECYCLED, CARD STOCK, ROUGH	Defines the type of media to be fed from the Multi-Purpose Tray so that the printer can adjust its internal parameters for the media.
MPT MEDIAWEIGHT	MEDIUM , HEAVY, ULTRA HEAVY	Defines the media weight to be fed from the Multi-Purpose Tray.
UNIT OF MEASURE	MILLIMETER INCH	Defines the unit of measure for the next two items.
X-DIMENSION	3 to 8.5 INCH Default = 8.5 INCH	Defines the width of paper defined by the "CUSTOM" settings.
Y-DIMENSION	5 to 35.5 INCH Default = 11 INCH	Defines the length of paper defined by the "Custom" settings. Note that media of up to 47" (1.2 m) in length can be fed one sheet at a time from the Multi-Purpose Tray- for banner printing.

Color Menu

Note: Factory default settings are shown in **bold**.

The printer automatically adjusts color balance and density at appropriate intervals, optimizing the printed output for bright white paper viewed in natural daylight conditions.

The items on this menu provide a means of changing the default settings for special or particularly difficult print jobs. Settings revert to their default values when the next print job is complete.

Item	Settings	Explanation
DENSITY CONTROL	AUTO MANUAL	AUTO = image density is automatically adjusted: <ul style="list-style-type: none"> • at power on • when a new image drum or toner cartridge is installed • at intervals of 100, 300 and 500 drum counts Auto adjustment takes up to 55 seconds. Switch to manual only if you wish to initiate Density Control manually using the printer menu.
ADJUST DENSITY	[EXECUTE]	Selecting this will perform the auto density set up.
AJST REGISTRATION	[EXECUTE]	Performs automatic color registration adjustment. Normally this is done at power on and when the top cover is opened and then closed. This process accurately aligns the cyan, magenta and yellow images to the black image.
C REG FINE ADJUST M REG FINE ADJUST Y REG FINE ADJUST	-3 to + 3 in increments of 1 Default = 0	Performs fine adjustment of image timing in relation to the black image component. A positive setting will darken the color; a negative setting will lighten the color.

System Configuration Menu

Note: Factory default settings are shown in **bold**.

Items	Settings	Explanation
POW SAVE TIME	5 15 30 60 240	Adjusts the time before the printer automatically switches into power saving mode. In this mode power consumption is reduced, but when a job is sent the printer will require a warm-up time of up to 1 minute before printing can begin.
CLEARABLE WARNING	ON JOB	When ON, non-critical warnings, such as requests for a different paper size, can be cleared by pressing the ON LINE button. When set to JOB, they are only cleared when the print job resumes.
MANUAL TIMEOUT	OFF 30 60	Specifies how many seconds the printer will wait for paper to be fed before cancelling the job.
WAIT TIMEOUT	5 to 300 SEC Default = 90 seconds	Specifies how many seconds the printer will wait when received data pauses before forcing a page eject.
LOW TONER	CONTINUE STOP	Specifies whether the printer should continue printing after a low toner condition is detected. If you change this to STOP, when low toner is detected, the printer goes off line.
JAM RECOVERY	ON OFF	Specifies whether the printer should perform jam recovery after a paper jam has occurred. If ON, the printer will attempt to print again any pages lost due to a paper jam once the jam has been cleared.
ERROR REPORT	ON OFF	Change this to ON if you wish the printer to print the error details when an error occurs.

USB Menu

Note: Factory default settings are shown in **bold**.

Item	Settings	Explanation
SOFT RESET	ENABLE DISABLE	Enables or disables the SOFT RESET command.
SPEED	480Mbps 12Mbps	Sets the maximum transfer speed for the USB interface.
SERIAL NUMBER	ENABLE DISABLE	ENABLE allows your computer to identify the printer by its USB interface serial number.

Network Menu

Note: Factory default settings are shown in **bold**.

Item	Settings	Explanation
TCP/IP	ENABLE DISABLE	Enables or disables this network protocol.
NETBEUI	ENABLE DISABLE	Enables or disables this network protocol.
IP ADDRESS SET	AUTO MANUAL	Change this to Manual to specify the IP address through the front panel (see next entry). Required for non-DHCP networks.
IP ADDRESS	xxx.xxx.xxx.xxx Default = 198.168.100.100	Current assigned IP address. To change: <ul style="list-style-type: none"> • Press ENTER. • Use +/- keys to increment first octet. • Press ENTER to move on to the next octet. • Use +/- keys to increment second octet. • Press ENTER to move on to the next octet. • Use +/- keys to increment third octet. • Press ENTER to move on to the last octet. • Use +/- keys to increment 1st octet. • Press ENTER to register the new address.
SUBNET MASK	xxx.xxx.xxx.xxx Default = 255.255.255.000	Current assigned subnet mask. To change, proceed as above.
GATEWAY ADDRESS	xxx.xxx.xxx.xxx Default = 192.168.100.254	Current assigned gateway address. To change, proceed as above.
INITIALIZE NIC?	[EXECUTE]	Initializes the network card.
WEB/IPP	ENABLE DISABLE	Enables or disables Web config. facility and Internet Printing Protocol. This item will not appear in the menu if TCP/IP is set to DISABLE.

Item	Settings	Explanation
TELNET	ENABLE DISABLE	Enables or disables Telnet config. facility. This item will not appear in the menu if TCP/IP is set to DISABLE.
FTP	ENABLE DISABLE	Enables or disables communication via FTP. This item will not appear in the menu if TCP/IP is set to DISABLE.
SNMP	ENABLE DISABLE	Enables or disables SNMP protocol.
LAN	NORMAL SMALL	Normal = Global network Small = Local network
HUB LINK SETTING	AUTO NEGOTIATE 100BASE-TX FUL 100BASE-TX HALF 10BASE-T FULL 10BASE-T HALF	Sets full or half duplex for communication via a network hub.

Memory Menu

Note: Factory default settings are shown in **bold**.

Item	Settings	Explanation
RECEIVE BUF SIZE	AUTO 0.5MB 1MB 2MB 4MB 8MB 16MB	Sets the size of the receive buffer.
FLASH INITIALIZE	[EXECUTE]	Initializes Resident Flash memory. When ENTER is pressed, the following message displays. ARE YOU SURE? YES=ENTER/NO=CANCEL Press ENTER. The following message displays: EXECUTE NOW? YES=ENTER/NO=CANCEL Press ENTER, then turn the printer off. The request to execute FLASH initialization is put into the memory and initialization is executed when the power is turned back on.

System Adjust Menu

Notes:

- Factory default settings are shown in **bold**.
- Items with a dagger (†) only appear when the appropriate option is installed.

Item	Settings	Explanation
X ADJUST	-2.00MILLIMETER TO +2.00MILLIMETER Default = 0.00	Adjusts overall print position horizontally in 0.25 increments.
Y ADJUST	-2.00MILLIMETER TO +2.00MILLIMETER Default = 0.00	Adjusts overall print position vertically in 0.25 increments.
DUPLEX X ADJUST†	-2.00MILLIMETER TO +2.00MILLIMETER Default = 0.00	Adjusts overall print position of print face horizontally in 0.25 increments.
DUPLEX Y ADJUST†	-2.00MILLIMETER TO +2.00MILLIMETER Default = 0.00	Adjusts overall print position of print face vertically in 0.25 increments.
DRUM CLEANING	OFF ON	If you are experiencing horizontal white lines on your printed pages, enter the menu and temporarily change this setting to ON, then send a one page print job. This will cause an extra blank sheet to print, cleaning the drum prior to printing. Careful! Leaving this set to ON will reduce the image drum life.

Maintenance Menu

Note: Factory default settings are shown in **bold**.

Item	Settings	Explanation
MENU RESET	[EXECUTE]	Resets menus to the default settings.
SAVE MENU	[EXECUTE]	Saves current menu settings as default values. At confirmation prompt, press ENTER to confirm save, or CANCEL.
POWER SAVE	ENABLE DISABLE	Change this setting to Disable if you do not want the printer to enter the power save mode after the specified time.
PAPER BLACK SETTING	-2 to +2 in increments of 1 Default = 0	Used for small adjustment when you experience faded print or light specks / streaking in monochrome printing on white paper. Select a higher value to reduce fading, or a lower value to reduce specks or streaking in high density print areas.
PAPER COLOR SETTING	-2 to +2 in increments of 1 Default = 0	As above, but for color printing.
TRANSPR BLACK SETTING	-2 to +2 in increments of 1 Default = 0	As above, but for mono printing on transparencies.
TRANSPR COLOR SETTING	-2 to +2 in increments of 1 Default = 0	As above, but for color printing on transparencies.

Usage Menu

This menu is for information only. It provides an indication of total usage of the printer and the expected life left in its consumable items. This is particularly useful if you do not have a full set of replacement consumables on hand and you need to know how soon you will need them.

- Items with a dagger (†) only appear when the appropriate option is installed.

Item	Explanation
TOTAL PAGE COUNT	The total number of pages printed.
TRAY1 PAGE COUNT	The total number of pages fed from Tray 1.
TRAY2 PAGE COUNT†	The total number of pages fed from optional Tray 2. Appears only if the optional Second Paper Tray is installed. See "Second Paper Tray", on page 102.
MPT PAGE COUNT	The total number of pages fed from the Multi-Purpose Tray.
COLOR PAGE COUNT	The total number of pages printed in color.
MONO PAGE COUNT	The total number of pages printed in monochrome.
K DRUM LIFE C DRUM LIFE M DRUM LIFE Y DRUM LIFE BELT LIFE FUSER LIFE	Percentage of life remaining in these consumable items is indicated as nn%.
K TONER C TONER M TONER Y TONER	Current remaining toner is indicated as nn%. 2k= standard cartridge 5K= high-capacity cartridge

Menu Defaults

Information, Print, and Media Menus

Note: Menus/Items with a dagger (†) only appear when the appropriate option is installed.

Menu	Item	Default Setting
INFORMATION MENU	PRINT MENU MAP	[EXECUTE]
	DEMO1	[EXECUTE]
PRINT MENU	COPIES	1
	DUPLEX†	OFF
	PAPER FEED	TRAY1
	AUTO TRAY SWITCH	ON
	TRAY SEQUENCE	DOWN
	MP TRAY USAGE	DO NOT USE
	MEDIA CHECK	ENABLE
	MONO-PRINT SPEED	AUTO SPEED
MEDIA MENU	TRAY1 PAPERSIZE	LETTER
	TRAY1 MEDIATYPE	PLAIN
	TRAY1 MEDIAWEIGHT	MEDIUM
	TRAY2 PAPERSIZE†	LETTER
	TRAY2 MEDIATYPE†	PLAIN
	TRAY2 MEDIAWEIGHT†	MEDIUM
	MPT PAPERSIZE	LETTER
	MPT MEDIATYPE	PLAIN
	MPT MEDIAWEIGHT	MEDIUM
	UNIT OF MEASURE	INCH
	X DIMENSION	8.5 INCH
	Y DIMENSION	11.0 INCH

Color, System Configuration, and USB Menus

Note: Menus/Items with a dagger (†) only appear when the appropriate option is installed.

Menu	Item	Default Setting
COLOR MENU	DENSITY CONTROL	AUTO
	ADJUST DENSITY	[EXECUTE]
	AJST REGSTRATION	[EXECUTE]
	C REG FINE AJST	0
	M REG FINE AJST	0
	Y REG FINE AJST	0
SYS CONFIG MENU	POW SAVE TIME	60 MIN
	CLRABLE WARNING	ON
	MANUAL TIMEOUT	60 SEC
	WAIT TIMEOUT	90 SEC
	LOW TONER	CONTINUE
	JAM RECOVERY	ON
	ERROR REPORT	OFF
	LANGUAGE	ENGLISH
USB MENU	SOFT RESET	DISABLE
	SPEED	480Mbps

Network and Memory Menus

Note: Menus/Items with a dagger (†) only appear when the appropriate option is installed.

Menu	Item	Default Setting
NETWORK MENU	TCP/IP	ENABLE
	NETBEUI	DISABLE
	IP ADDRESS SET	AUTO
	IP ADDRESS	192.168.100.100
	SUBNET MASK	255.255.255.000
	GATEWAY ADDRESS	192.168.100.254
	INITIALIZE NIC?	[EXECUTE]
	WEB/IPP	ENABLE
	TELNET	ENABLE
	FTP	ENABLE
	SNMP	ENABLE
	LAN	NORMAL
	HUB LINK SETTING	AUTO NEGOTIATE
MEMORY MENU†	RECEIVE BUF SIZE	AUTO
	FLASH INITIALIZE	[EXECUTE]

System Adjust and Maintenance Menus

Note: Menus/Items with a dagger (†) only appear when the appropriate option is installed.

Menu	Item	Default Setting
SYS ADJUST MENU	X ADJUST	0.00 MILLIMETER
	Y ADJUST	0.00 MILLIMETER
	DUPLEX X ADJUST†	0.00 MILLIMETER
	DUPLEX Y ADJUST†	0.00 MILLIMETER
	DRUM CLEANING	OFF
MAINTENANCE MENU	MENU RESET	[EXECUTE]
	SAVE MENU	[EXECUTE]
	POWER SAVE	ENABLE
	PAPER BLACK SET	0
	PAPER COLOR SET	0
	TRNSPR BLACK SET	0
	TRNSPR COLOR SET	0

Usage Menu

Menu	Item	Default Setting
USAGE MENU	TOTAL PAGE COUNT	nnnn
	TRAY1 PAGE COUNT	nnnn
	TRAY2 PAGE COUNT†	nnnn
	MPT PAGE COUNT	nnnn
	COLOR PAGE COUNT	nnnn
	MONO PAGE COUNT	nnnn
	K DRUM LIFE	REMAINING nn%
	C DRUM LIFE	REMAINING nn%
	M DRUM LIFE	REMAINING nn%
	Y DRUM LIFE	REMAINING nn%
	BELT LIFE	REMAINING nn%
	FUSER LIFE	REMAINING nn%
	K TONER	REMAINING nn%
	C TONER	REMAINING nn%
	M TONER	REMAINING nn%
	Y TONER	REMAINING nn%

Options

The following options are available for your printer:

- Additional RAM memory (see below)
- Duplex Unit (see page 101)
- Second Paper Tray (see page 102)

Instructions for installing these options are found in the packaging with the option.

RAM Memory

Oki 70042801, 70042901



The basic printer comes equipped with 64 MB of main memory. This can be upgraded with an additional memory board containing

- 64 MB (Oki 70042801), increasing the memory to 128 MB
- or
- 256 MB (Oki 70042901), increasing the memory to 320 MB.

Duplex Unit

Oki 43347501

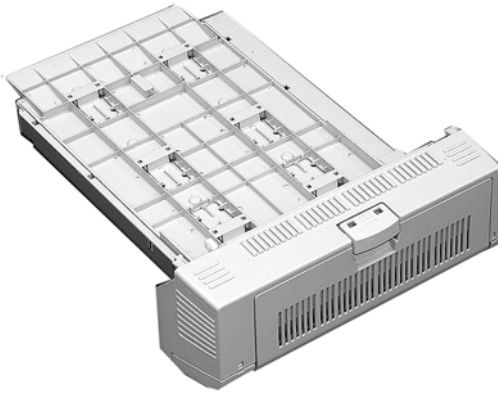

The Duplex Unit enables your printer to print on both sides of the page.

See "Duplex Printing" on page 195.

Second Paper Tray

Oki 43347601

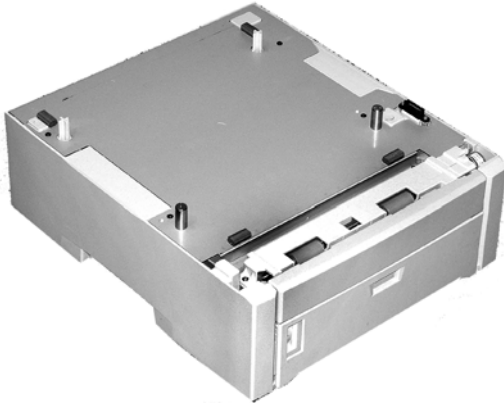

The second paper tray takes:

- Up to 530 sheets of 20-lb. paper.
- All the same size media as Tray 1 except A6.
- Paper weight range 16 to 57 lbs. (60 to 203 g/m²).

Specifications

Item	Specification
Dimensions	16.61" W x 22.09" D x 13.58" H (422 mm W x 561 mm D x 345 mm H)
Net Weight	57.3 lbs. (26 Kg)
Print speeds	<ul style="list-style-type: none"> • 20 pages per minute (ppm) color • 24 ppm monochrome • <i>For Transparencies:</i> 5 ppm color, 10 ppm monochrome
Resolution	600 dpi or 600 x 1200 dpi
Emulation	Hiper-C
Environmental	<p><i>Temperature</i></p> <ul style="list-style-type: none"> • Operating: 50 to 90°F (10 to 32°C) • Storage (packed up): -14 to 110°F (-10 to 43 °C) • Power Off: 32 to 110°F (0 to 43°C) <p><i>Relative Humidity</i></p> <ul style="list-style-type: none"> • Operating: 20 to 80% RH • Storage (packed up): 10 to 90% RH • Power Off: 10 to 90% RH
Electrical	<p>110-127 volts, 60 Hz (±2 Hz) 220-240 volts, 50 Hz (±2 Hz)</p> <p><i>Power Consumption:</i></p> <ul style="list-style-type: none"> • Operating, Typical: 420 watts • Max.: 950 watts • Power Save Mode: 20 watts
Auto Features	<p>Auto registration Auto density adjustment Auto consumable counter reset</p>
Memory	64 MB standard, upgradable to 128 MB or 320 MB See "RAM Memory" on page 100.
Paper capacity (20-lb. [75 g/ m ²] paper)	<p><i>Tray 1:</i> 300 sheets <i>Optional Tray 2:</i> 530 sheets <i>Multi-Purpose Tray:</i> 100 sheets</p>
Paper weight Range	<p><i>Tray 1:</i> 17 to 32 lb. (64 to 120 g/m²) <i>Optional Tray 2:</i> 17 to 47 lb. (64 to 177 g/m²) <i>Multi-Purpose Tray:</i> 20 to 54 lb. (75 to 203 g/m²)</p>
Paper output	<p><i>Top Exit (Face Down Stacker):</i> 250 sheets 20-lb. 75 g/m² paper <i>Rear Exit (Face Up Stacker):</i> 100 sheets 20-lb. 75 g/m²</p>
Printer life	420,000 pages or 5 years, whichever comes first

Item	Specification
Duty cycle	<i>Maximum:</i> 50,000 pages per month at 5% duty cycle (equivalent to an average business letter) <i>Average:</i> 4,000 pages per month
Toner life	<i>Standard cartridge:</i> approximately 2,000 pages at 5% coverage <i>High-capacity cartridge:</i> approximately 5,000 pages at 5% coverage
Image drum life	20,000 pages at 3 pages per job
Belt life	60,000 letter-size pages
Fuser life	60,000 letter-size pages

Troubleshooting

General Information

This section provides information to help you deal with problems that may arise when using the printer.

Troubleshooting is divided into the following sections:

- "Display Panel Messages" see page 106
- "Paper Jams" see page 110
- "Print Quality Problems" see page 132
- "USB Problems" see page 136
- "Application error" see page 138
- "General Protection Fault" see page 138
- "Paper Size Change Request" see page 139
- "Printer does not go online" see page 139
- "Printer makes a strange noise" see page 139
- "Printer takes a long time to start printing" see page 140
- "Printing cancels" see page 140
- "Printing does not start" see page 141
- "Printing is slow" see page 141
- "Cleaning" see page 142

Display Panel Messages

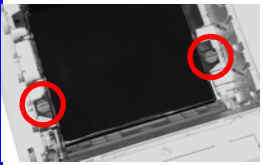
Message	Meaning	What to Do
* TONER SENSOR ERROR	Flashes across the second line of the display: the indicated color toner (*) is missing from the printer.	Open the top cover and make sure the indicated toner is there and properly seated in the printer: C = Cyan, Y = Yellow, M = Magenta, K = Black.
ADD MORE MEMORY 420: MEMORY OVERFLOW	The document size is too large for the printer's memory.	Reduce the size of the document. If this happens frequently, install additional memory (see "RAM Memory", on page 100).
CANCELLING JOB (JAM)	The setting for Jam Recovery in the menu has been changed to off and a paper jam has occurred. Any unprinted data is being deleted.	Clear the jam and resend the missing pages of the print job.
CHECK BELT 330: BELT MISSING	The belt unit is not properly installed.	<p>Open the top cover and lift out the black (K) and Yellow (Y) image drums, placing them on a <i>flat</i> surface. Check to be sure that the belt unit latches are fully in the latched position:</p>  <p>then reinstall the image drums.</p>

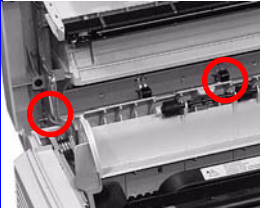
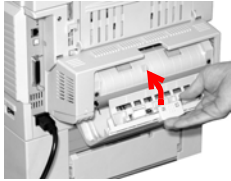
Message	Meaning	What to Do
CHECK FUSER 320: FUSER MISSING	The fuser unit is not properly installed.	<p>Open the top cover and check to be sure that the fuser unit is properly seated in the printer and that the lock levers are pushed all the way toward the back of the printer:</p> 
CHECK MP TRAY 390: PAPER JAM	Paper has jammed while exiting the MP Tray.	Clear the jam. See "Jam 390", on page 128.
CLOSE COVER 316: DUPLEX COVER OPEN	The duplex cover is open or not properly latched.	<p>Close the duplex cover:</p> 
CLOSE COVER nnn: COVER OPEN	Either the top cover or the front cover is open.	Be sure both the top cover and the front cover are firmly closed.
INSTALL PAPER CASSETTE 430: TRAY 1 MISSING	Tray 1 is not installed in the printer.	Install the missing tray.
INSTALL PAPER CASSETTE 440: TRAY 1 OPEN	Tray 1 is not properly installed in the printer.	Make sure the tray is pushed fully into the printer.

Message	Meaning	What to Do
LOAD mmm AND PRESS ONLINE SWITCH 490: MP TRAY EMPTY	Print job from MP Tray has been received and the MP Tray is empty.	Load the requested media (mmm) in the MP Tray and press ON-LINE.
LOAD mmm nnn: tttt EMPTY	A print job has been received and the indicated paper tray is empty.	Load mmm media in the indicated (tttt) tray.
LOAD mmm/ppp AND PRESS ONLINE SWITCH nnn: tttt MEDIA MISMATCH	The media type in the indicated tray (tttt) does not match that specified in the print job being processed.	Load the appropriate media in the tray and press ON-LINE.
LOAD mmm/ppp AND PRESS ONLINE SWITCH nnn: tttt SIZE MISMATCH	The media size (mmm) and/or type (ppp) loaded in the indicated tray (tttt) does not match that specified in the print job being processed.	Load the appropriate media in the tray and press ON-LINE.
OPEN DUPLEX COVER nnn: PAPER JAM	Paper has jammed entering or exiting the duplexer.	Clear the jam. See page 112 and page 114.
OPEN FRONT COVER nnn: PAPER JAM	Paper jam.	Clear the jam. See page 117 and page 130
OPEN TOP COVER nnn: PAPER JAM	Paper jam.	Clear the jam. See page 124 and page 119.
ORDER xxx	Appears on the second line of the display to indicate that consumable xxx (e.g., belt, fuser, toner, image drum) is nearing end of life.	Make sure you have a replacement unit on hand.
POWER ON/OFF 300: NETWORK ERROR	An error has occurred involving the network.	Shut the printer off, then turn it back on. If the message still appears, check with your network administrator.

Message	Meaning	What to Do
PRESS ONLINE SW INVALID DATA	The printer has received invalid data.	Press ON-LINE. Reprocess and resend the print job.
REPLACE TONER nnn: * TONER EMPTY	The indicated toner needs replacement.	Replace the indicated toner: 410: Y = Yellow 411 M = Magenta 412: C = Cyan 413: K = Black
REPLACE yyyy nnn: yyyy LIFE	The indicated component is nearing end of life and should be replaced.	Replace the indicated component: YYYY = Fuser, Belt, C Drum, Y Drum, M Drum, K Drum.
tttt EMPTY	Appears on the second line of the display to indicate that ttt tray has run out of media.	Load media in tray tttt.
xxx LIFE	Appears on the second line of the display to indicate that consumable xxx (e.g., belt, fuser, image drum) will need to be replaced soon.	Replace the indicated item.
YYYY nnn: FATAL ERROR	An error has occurred which requires service. YYYY = the general cause. nnn = error number.	Try turning off the printer then turning it back on. If this does not remedy the problem, write down the message including the error number "nnn," then call your authorized Oki Data Service Dealer for service. Note: If you see a series of octets containing letters and numbers scrolling across the display, be sure to write these down also and report them to the Service Dealer.

Paper Jams

General Information

Jams can occur due to paper misfeeding from a paper tray or at any point along the paper path.

When a jam occurs, the printer immediately stops. The control panel displays an error message. This message tells you where the first sheet is jammed.

All jammed sheets must be removed in order to restore the printer to normal operation.

Once you clear a jam and close the cover, you may see a new jam message indicating another jammed sheet which must be cleared. This is especially likely if you are printing a multi-page document or multiple copies of a single document.

Once all jams have been cleared, the printer should automatically try to reprint any pages lost due to paper jams. If it doesn't, check the Jam Recovery setting in the System Configuration Menu. It must be set to ON. See "Changing Settings" on page 78.

- If paper jams are frequent: see page 111
- Jam is cleared, but printer does not print: see page 111
- Jam 370: see page 112
- Jam 371: see page 114
- Jam 372: see page 117
- Jam 373: see page 112
- Jam 380: see page 117
- Jam 381: see page 119
- Jam 382: see page 124
- Jam 383: see page 112
- Jam 390: see page 128
- Jam 391: see page 130
- Jam 392: see page 130

If paper jams are frequent

- More than one sheet feeds at a time.
- Paper curls.
- Paper feeds at an angle.

Possible cause	Remedy
The printer is not horizontal.	Place the printer on a stable, level surface.
The paper is too thin.	Use the correct type of paper. See "Paper Weights" on page 11.
The paper is moist or affected by static.	Store paper within specified temperature and humidity levels. See "Specifications" on page 103.
The paper is creased or wrinkled.	Remove the creased/wrinkled paper from the feed tray.
The paper is not aligned correctly.	Adjust tray or manual feed guides.
Paper doesn't feed.	Correct paper feed selection in the Properties Setup tab in the printer driver.

Jam is cleared, but printer does not print.

Possible cause	Remedy
The top cover has not remained open until all paper jams have been cleared.	Removing a paper jam is not sufficient: Raise and <i>gently</i> lower the top cover, especially if the paper jam has been removed from behind the front cover.

Jam 370, 373 and 383

OPEN DUPLEX COVER
nnn: PAPER JAM

nnn = 370, 373, 383

1. Press the duplex cover release. Open the duplexer cover.

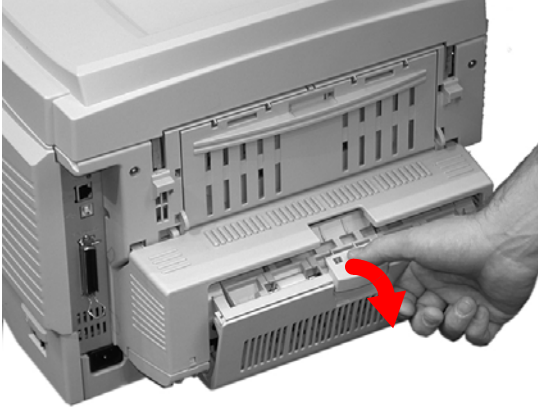

2. Remove any jammed sheets.

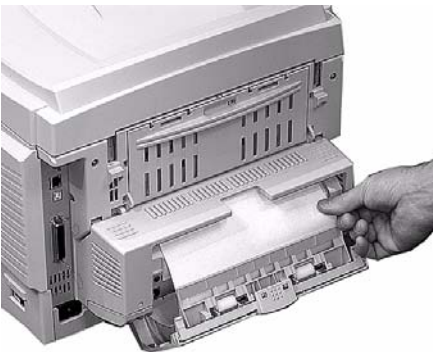

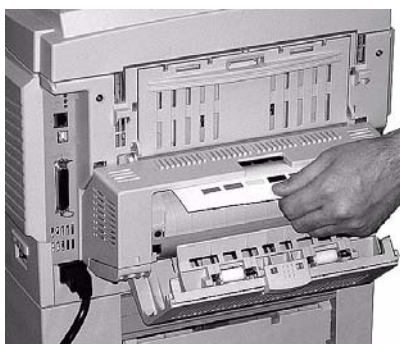
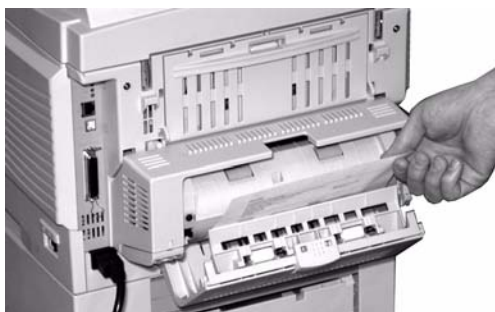

3. Close the duplex unit cover.

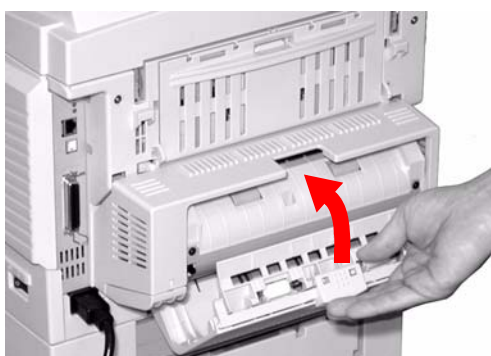

Jam 371

OPEN DUPLEX COVER 371: Paper Jam

1. Turn off the printer.
2. Pull out the duplexer.

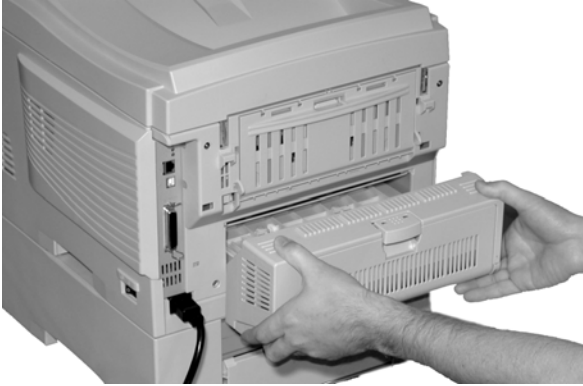

3. Pull the duplexer lid to unlock it.

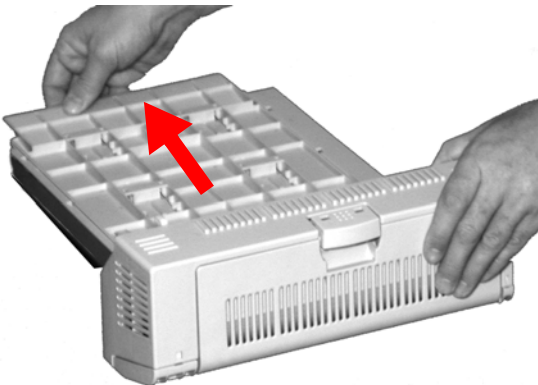

4. Open the lid. Remove the jammed sheet.



5. Close the lid. Push it back to lock it in place.



6. Push the duplexer back into the printer.

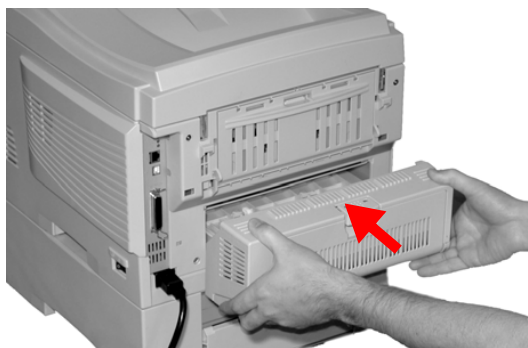

7. Turn on the printer.

Jam 372 and 380

OPEN FRONT COVER
nnn: PAPER JAM

nnn = 372 or 380.

1. Lift the front cover release. Pull open the front cover.



2. Remove any jammed sheets.



3. Close the front cover.



Jam 381

OPEN TOP COVER 381: Paper Jam

1. Press the cover release. Fully open the printer's top cover.



2. Note the positions of the four image drums: Cyan (1), Magenta (2), Yellow (3), Black (4). *It is essential that they go back in the correct order!*

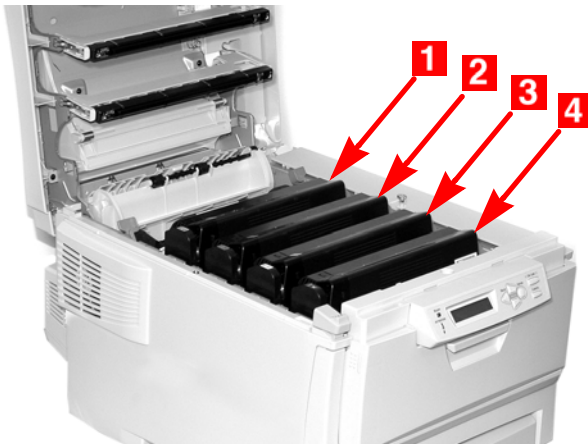

WARNING!

If the printer has been powered on, the fuser is hot. This area is clearly labelled. Do not touch it.

3. Lift each of the image drum/toner cartridge units out of the printer. Place them on a *flat* surface in a safe place *away from direct sources of heat and light*.



CAUTION!

The green surface at the base of each image drum is very delicate and light sensitive.

- Do not touch the green surface.
- Never expose the drum to direct sunlight or to very bright room lighting.
- Do not expose it to normal room light for more than 5 minutes.
- If the image drum must be out of the printer for longer than 5 minutes, place the image drum inside a black plastic bag or carefully place it in a drawer or cabinet to keep it away from light.

4. Remove any sheets of paper on the belt unit.



CAUTION!

Do not use any sharp or abrasive objects to separate sheets from the belt. This may damage the belt surface.

NOTE

Warning! If the printer has been printing, the fuser will be *HOT!*

If the sheet is well advanced into the fuser (only a short length is still visible), do not attempt to pull it back. See step 4 under "Jam 382" .

To remove a sheet trapped in the fuser:

1. Grasp the edge of the sheet.
2. Push the fuser pressure release lever (1) towards the front and down.
3. Lift out the sheet.
4. Let go of the fuser pressure release lever.

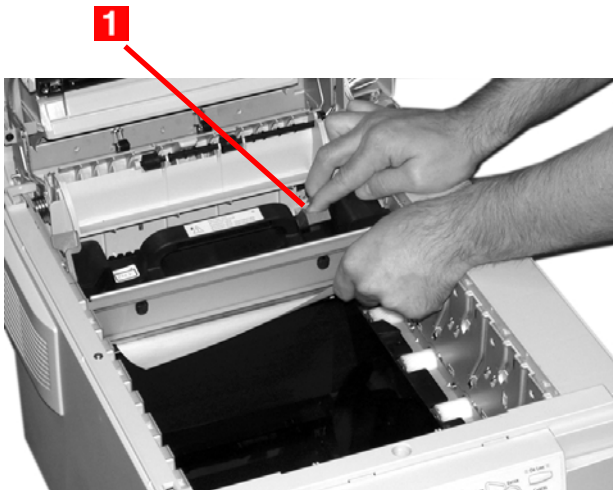

5. Place the four image drums/toner cartridges back in the printer. Be sure to place them in the proper sequence (**1** = Cyan, **2** = Magenta, **3** = Yellow, **4** = Black).

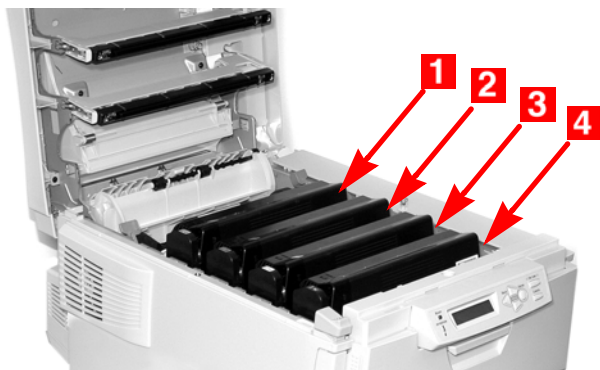

6. Close the top cover.



Jam 382

OPEN TOP COVER 382: Paper Jam

1. Open the top cover.

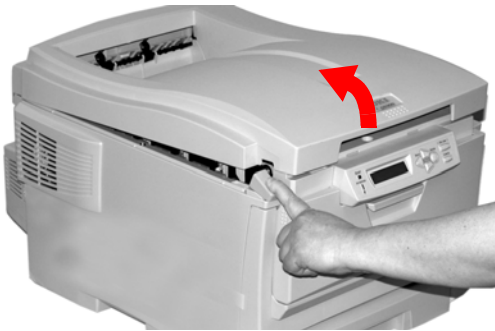

2. Gently pull the sheet out.
 - If the sheet does *not* come out easily, go to the next step.
 - If the sheet does come out, close the cover.



3. Lower the rear exit tray.

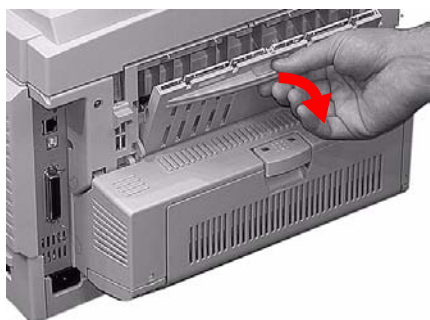

4. Pull out the jammed sheet.

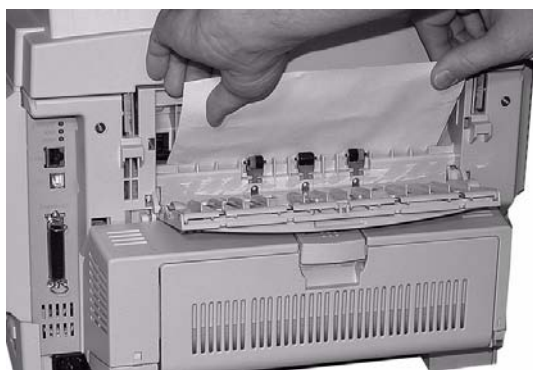

Important!

WARNING! The fuser may be HOT!

If the sheet is difficult to remove, it is partially jammed in the fuser. To get it out, reach around the top cover and press down on the fuser pressure release lever (1) before pulling the sheet out. Then let go of the fuser pressure release lever.

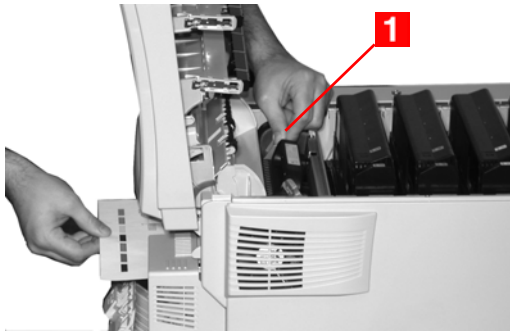

5. Close the rear exit.

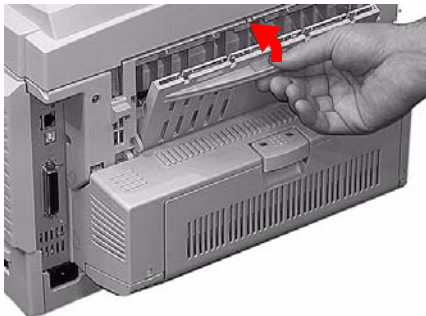

6. Close the top cover.



Jam 390

CHECK MP TRAY
390: Paper Jam

Sheet has just entered the printer

1. Gently pull the sheet out of the printer.



Sheet can't easily be pulled out from the front

1. Lift the front cover release. Pull open the front cover.

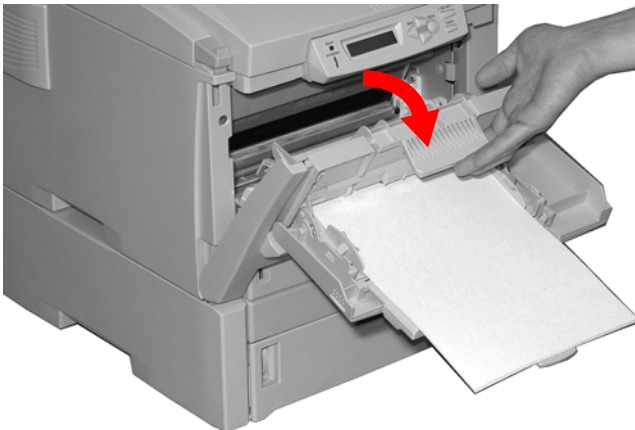

2. Remove any jammed sheets.

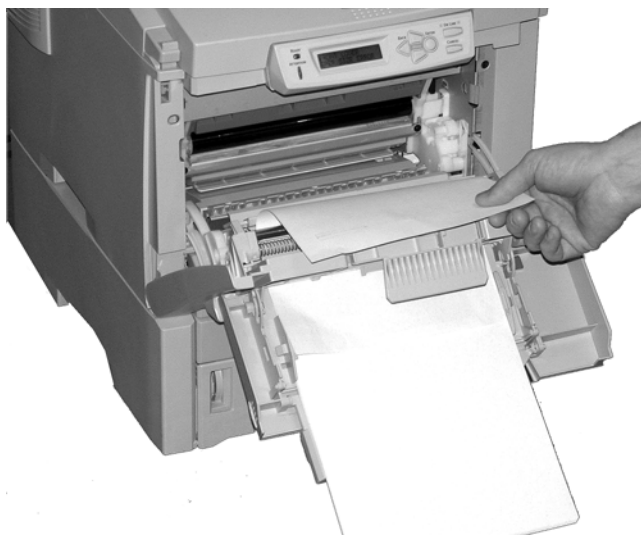

3. Close the front cover.



Jam 391 and 392

OPEN FRONT COVER
nnn: PAPER JAM

nnn = 391 or 392

1. Pull out the appropriate tray.
391 = Tray 1
392 = Optional Tray 2.
2. Remove any sheet jammed as it exited the tray.



391



392

3. Open the front cover.



4. Remove any jammed sheets.



5. Close the front cover.



Print Quality Problems

Blurred print (letter edges)

Possible cause	Remedy
LED is dirty.	Clean LED with lens cleaner or soft tissue.
Cannot print desired color because toner is low.	Replace toner cartridge. See "Replace a Toner Cartridge" on page 49.

Blurred print (one side of page)

Possible cause	Remedy
Top cover is not properly closed.	Press the cover release latch and open, then close, the cover.
One or more of the toner cartridges is not seated properly.	Open the top cover and check to be sure that each toner cartridge is fully seated and that each toner cartridge lock lever is pushed all the way back.

Fading, in patches

Possible cause	Remedy
The paper is moist.	Store paper within specified temperature and humidity levels. See "Specifications" on page 103.

Fading, Vertically

Possible cause	Remedy
LED head is dirty.	Clean LED head with lens cleaner or soft tissue.
Toner is low.	Change toner cartridge.
Paper is unsuitable for printer.	Use recommended paper.

Light Print

Possible cause	Remedy
The toner cartridge is incorrectly installed.	Reinstall the toner cartridge. See "Replace a Toner Cartridge" on page 49.
Toner is low.	Change toner cartridge. See "Replace a Toner Cartridge" on page 49.
The paper is moist.	Store paper within specified temperature and humidity levels. See "Specifications" on page 103.
Paper is unsuitable for printer.	Use recommended paper. See "Paper (Print Media)" on page 10.

Lines, Black (Vertical)

Possible cause	Remedy
Image drum is damaged.	Replace image drum. See "Replace an Image Drum" on page 57.
Toner is low.	Change toner cartridge. See "Replace a Toner Cartridge" on page 49.
Periodic black lateral lines or spots.	<p>If the lines or spots occur at intervals of approximately</p> <p>44 to 94 mm</p> <p>The green surface of the image drum is damaged or dirty. If damaged, replace the image drum cartridge. See "Replace an Image Drum" on page 57. If dirty, wipe the image drum gently with soft tissue. If this does not work, replace the image drum. See "Replace an Image Drum" on page 57.</p> <p>113 mm</p> <p>The fuser roller is damaged. Change the fuser. See "Replace the Fuser" on page 66.</p>
The image drum has been exposed to light.	Remove the image drum from the printer and store it in a dark place for several hours. If this does not work, replace the image drum. See "Replace an Image Drum" on page 57.

Lines, White (Vertical)

Remedy
Clean LED head with lens cleaner or soft tissue.
Change toner cartridge.
Change image drum.

Shading on unprinted sections

Possible cause	Remedy
Paper has been affected by static electricity.	Store paper within specified temperature and humidity levels. See "Specifications" on page 103.
Paper is too thick.	Use recommended paper. See "Paper Weights" on page 11.
Toner is low.	Replace toner cartridge. See "Replace a Toner Cartridge" on page 49.

Toner rubs off when you rub the printed surface.

Possible cause	Remedy
Media Weight and Media Type settings may not be appropriate.	Set the value of media weight in the menu to the next heaviest one (MEDIA MENU → YYY MEDIA WEIGHT).
Packing materials were left on the fuser when it was installed.	Careful! Fuser may be HOT! Open the top cover and check to be sure that all the packing materials were removed from the fuser. See "Replace the Fuser" on page 66.

USB Problems

Cannot configure for USB connection

NOTE

Windows NT 4.0 does not support USB. Windows 98 upgraded from Windows 95 may not support USB.

Possible cause	Remedy
USB cable does not meet specifications.	Use USB cable to specification Ver.2.0.
Interface is disabled.	Check that USB interface is set to Enable in the menu (USB MENU → USB → ENABLE).
Configuration procedure was not correctly followed or cancelled.	Configure again from the beginning.
USB cable is disconnected or faulty.	Reconnect or try another cable.
A USB hub is being used.	The printer cannot be used with a USB hub. Connect the printer and computer directly.
The USB cable is installed in the Ethernet port.	Make sure the USB cable is plugged into the black USB port (1) on the printer: 

Cannot print

- PRNUSBx write error is displayed.

Possible cause	Remedy
Interface is disabled.	In the printer menu settings, enable the USB interface (USB MENU → USB → ENABLE).
Printer is switched OFF.	Turn on the printer.
Printer interface cable is disconnected.	Reconnect the printer interface cable.
A converter, buffer, extension cable or USB hub is being used.	Test by connecting the printer and computer directly.
Printer driver output port is incorrect.	Set correct output port to which the printer interface cable is connected.
Printer is not selected in the printer driver.	Select the printer or set to default printer.
Incorrect printer driver is being used.	Delete this printer driver and install correct printer driver from the CD supplied with your printer.

Application error _____

or

General Protection Fault _____

Possible cause	Remedy
Application is not suitable for the operating system.	Upgrade the application.
Memory is insufficient for number of applications running.	Close all other applications.
Print file is corrupted.	Correct or recreate the file.
Memory is insufficient for application.	Increase computer's memory.
Printer driver is incorrectly configured.	Correctly configure printer driver.

Paper Size Change Request _____

Possible cause	Remedy
Paper loaded in tray is different size from that formatted in software application.	Either change paper in tray to match size formatted in application and press ON-LINE to continue, or continue printing on existing paper by pressing ON-LINE.

Printer does not go online _____

Possible cause	Remedy
Bad connection	Switch off the printer and disconnect the power cable. Reconnect the power cable and switch the printer on. If this does not clear the fault, call for service.

Printer makes a strange noise _____

Possible cause	Remedy
The printer is not horizontal.	Place the printer on a stable, level surface.
There are scraps of paper or other foreign matter inside the printer.	Check the inside of the printer and remove any such objects.
The top cover is not firmly shut.	Press the left and right sides of the top cover.

Printer takes a long time to start printing

Possible cause	Remedy
The printer has to warm up returning from power save mode.	In the printer menu settings, set power save to a higher value to increase the length of time before entering power save mode (SYS CONFIG MENU → POW SAVE TIME).
The image drum carries out a cleaning process to ensure print quality, which takes time.	Wait until this process has been completed.
The fuser unit adjusts temperature, which takes time.	Wait until this process has been completed.
The printer is processing data from another interface.	Wait until this data is processed.

Printing cancels

Possible cause	Remedy
The printer interface cable is faulty.	Replace the printer interface cable.
The time out setting is too short.	Reset time out in the menu to a higher value (SYS CONFIG MENU → WAIT TIMEOUT).

Printing does not start _____

Possible cause	Remedy
Printer error	Check the control panel. If an error message is displayed, correct the problem.

Printing is slow _____

Possible cause	Remedy
Print processing is carried out by the computer.	Use a computer with a faster processor.
Print resolution is set high.	Set lower print resolution in the printer driver Job Options tab.
Data is too complex.	Simplify data.

Cleaning

Cleaning Page

Macintosh

OS 10.2 and 10.3

Use this to generate a cleaning page which runs through the printer before the job is printed. This should eliminate any fading, streaking or erratic marks from the printed pages.

1. Open the file you want to print.
2. Click File → Print.
3. Open the drop-down list below Presets. Select Printer Option.
4. Select "Run maintenance cycle before printing".
If the box has a check mark, the feature is ON.
If the box is empty, the feature is OFF.
5. Change any other settings as desired.
6. Click Print.

Printer Drivers

General Information

NOTE

Most applications allow the printer properties to be accessed from within the document print dialog box.

Application settings override driver settings.

Driver settings override printer menu settings.

See your printed Setup Guide for information on installing the driver supplied with your printer.

You can also go to <http://my.okidata.com> to see/download a copy of the Setup Guide or for the latest information on printer drivers.

For more information about working with your printer driver, refer to the appropriate operating system.

- "Macintosh" see page 144

Summary

Presets

Scheduler

Paper Handling

Macintosh

General Information

Summary

Macintosh OS 10.2 and 10.3

The "Summary" lists all the printer settings currently made for your print job. See "Summary" on page 145.

Presets

Macintosh OS 10.2 and 10.3

"Presets" allow you to save a group of settings which you use for many documents, or to change the settings designated as the Standard Preset. See "Presets" on page 145.

Scheduler

Macintosh OS 10.3 only

"Scheduler" allows you to schedule when your job will print and its priority relative to other jobs in the print queue. See "Scheduler" on page 146.

Paper Handling

Macintosh OS 10.3 only

"Paper Handling" allows you to determine how the pages in your print job will print. Choices are: Reverse page order, All Pages, Odd numbered pages, or Even numbered pages.

Select "Reverse page order" to print the last page of the document first. This is useful when you are printing to the straight-through, rear (face up) exit required for heavy paper, labels, envelopes and transparencies.

See "Paper Handling" on page 147.

Summary

Macintosh OS 10.2 and 10.3

The "Summary" lists all the printer settings currently made for your print job.

1. Open the file you want to print.
2. Click File → Print.
3. Open the drop-down list below Presets. Select Summary.

Presets

Macintosh OS 10.2 and 10.3

Use / Save Presets

Presets allow you to save a group of settings which you use for many documents, or to change the settings designated as the Standard Preset.

For example, if you are using Job Accounting, you can enter your User Name and Job Account ID on the Job Accounting screen, then save the setting as part of the Standard Preset.

Create a New Preset

1. Make all the printer settings you wish to save as a Preset.
2. Select Summary. Review the settings to make sure you have all the settings you want to save.
3. Open the Presets drop-down list. Select Save As
4. Type in a name under which to save your settings. Click OK.
5. The new Preset appears in the drop-down list.

Change an Existing Preset

1. Make sure the Preset you wish to change is selected in the Preset box.
2. Make any needed changes in the printer settings.
3. Review the Summary screen to confirm that the settings are what you want.
4. Open the drop-down list. Select Save.
The revised settings are saved under that Preset.

Delete a Preset

CAUTION!

When you click Delete, the Preset is instantly deleted *without* prompting you to confirm the deletion.

1. Make sure the Preset you wish to change is selected in the Preset box.
2. Open the drop-down list. Select Delete.
The Preset is deleted from the list.

Scheduler

Macintosh OS 10.3 only

1. Open the file you want to print.
2. Click File → Print.
3. Open the drop-down list below Presets. Select Scheduler.
4. At Print Document, set the schedule for when your job prints.
 - Now (the default).
 - At [a specific time you specify in one minute increments]
 - On Hold [until you come back and select Now]
5. At Priority, select the urgency of your print job.
If your job competes with other documents in the print queue, this setting determines the printing priority of your job.

Paper Handling

Macintosh OS 10.3 only

1. Open the file you want to print.
2. Click File → Print.
3. Open the drop-down list below Presets. Select Paper Handling.

Reverse page order

Select this to print the last page of the document first. This is useful when you are printing to the straight-through, rear (face up) exit required for heavy paper, labels, envelopes and transparencies.

Print

All Pages

Odd numbered pages

Even numbered pages

Use this to print only the odd or only the even pages in your document.

Printer Features

Overview

Banners: see page 149

Black Printing: see page 151

Booklets: see page 156

Collating: see page 160

Color Matching: see page 163

Custom Page Size: see page 192

Duplex Printing: see page 195

Grayscale: see page 201

N Up (multiple pages on one sheet): see page 202

Photographs: see page 205

Posters: see page 208

Print Resolution: see page 210

Save as File: see page 214

Toner Saving: see page 215

Watermarks: see page 219

Banners

General Information

A banner is a document printed on an extra-long sheet of paper.

To print a banner, you must:

- use an application that supports banners

Notes:

Word does not support banners. Word limits page length to 22 inches (558.8 mm).

Power Point does support banners.

- define a custom page size for your banner

See "Custom Page Sizes" on page 192.

- use the Multi Purpose Tray and the Face Up (Rear) Exit

See

Multi-Purpose Tray (MP Tray) [Manual Feed], on page 35

Face Up (Rear Exit), on page 38

Specifications

- Length: up to 47" (1.2 m)
- Width Range = 8¼ to 8½" (210 to 215.9 mm)
- Weight Range = 28 to 34 lb. US Bond (105 to 128 g/m²)
- Path = Rear Exit (Face Up Stacker) only
- Feed one sheet at a time.

Windows

For important information about printing banners, see General Information, on page 149.

Macintosh

OS 10.2 and 10.3

For important information about printing banners, see General Information, on page 149.

Before you print a banner, you must set Multi Purpose Tray is Manual feed to ON in the printer driver. The default is OFF.

The printer operator panel will prompt you to load the media before the job prints.

1. Open the file you want to print.
2. Click File → Print.
3. Open the drop-down list below Presets. Select Printer Option.
4. Select "Multi Purpose Tray is Manual feed".
If the box has a check mark, the feature is ON.
If the box is empty, the feature is OFF.
5. Change any other settings as desired.
6. Click Print.

Black Printing

General Information

Your printer prints the color black in one of two ways:

- Composite Black
- True Black

Composite Black

The cyan, magenta, yellow, and black toners are *combined* to create composite black.

Use composite black when printing photographs.

Composite Black can appear as a brownish-black.

True Black

Only black toner is used to print true black.

Use True Black when printing a combination of text and graphics.

If you use True Black to print photographs, dark sections of the photos may appear black.

Windows

True Black

Normally, the printer prints black using all four toner colors (Composite Black).

If you do a lot of black-only printing, set the printer to use only black toner (True Black).

Individual Print Jobs

1. When you print a job, click on the driver's Color tab
2. Click in the box next to Grayscale.
If the box has a check mark, the feature is ON.
If the box is empty, the feature is OFF.

All Print Jobs (Default)

1. Click Start → Settings → Printers [Printers and Faxes in Windows XP].
2. Right-click the printer name.
3. Next
Windows 98/Me: select Properties. Click Printer Properties.
Windows 2000/XP: select Properties. Click Printing Preferences.
Windows NT 4.0: select Document Defaults.
4. On the Color tab, click Grayscale.
If the box has a check mark, the feature is ON.
If the box is empty, the feature is OFF.
5. Click OK twice.

NOTE

Once Grayscale is set as the default, you must select either Auto Color or Manual Color on the Color tab when you print color documents. See "List of Color Matching Methods" on page 180.

Windows

Black Finish

Individual Print Jobs

NOTE

The driver's color options are only designed to work with RGB data.

1. Open the file you want to print.
2. Click File → Print.
3. Click on the Color tab.
4. At Advanced Color, make your selection.
If the box has a check mark, the feature is ON.
If the box is empty, the feature is OFF.
5. Below Black Finish, make your selection.
Choices are Auto, Gloss, and Matte.

Gloss

This option produces printing with a more glossy finish.

Matte

This option uses more Black and less CMYK while producing a flatter black.

6. Change any other settings as desired.
7. Click Print.
8. The document prints.

All Print Jobs (Default)

1. Click Start → Settings → Printers [Printers and Faxes in Windows XP].
2. Right-click the printer name.
3. Next
Windows 98/Me: Select Properties. Click Printer Properties.

Windows 2000/XP: Select Properties. Click Printing Preferences.

Windows NT 4.0: Select Document Defaults.

4. Click on the Color tab.
5. At Advanced Color, make your selection.
If the box has a check mark, the feature is ON.
If the box is empty, the feature is OFF.
6. Below Black Finish, make your selection.
Choices are Auto, Gloss, and Matte.

Gloss

This option produces printing with a more glossy finish.

Matte

This option uses more Black and less CMYK while producing a flatter black.

7. Change any other settings as desired.
8. Click Print.
9. The document prints.

Macintosh

OS 10.2 and 10.3

True Black

1. Open the file you want to print.
2. Click File → Print.
3. Open the drop-down list below Presets. Select Printer Option.
4. At “Always create 100% Black(K) Toner”, make your selection.
If the box has a check mark, the feature is ON.
If the box is empty, the feature is OFF.
5. Change any other settings as desired.
6. Click Print.

Macintosh

OS 10.2 and 10.3

Black Finish

1. Open the file you want to print.
2. Click File → Print.
3. Open the drop-down list below Presets. Select Color.
4. Under Color Mode, select Advanced Color.
5. Choose the type of black finish.

Gloss

This option produces printing with a more glossy finish.

Matte

This option uses more Black and less CMYK while producing a flatter black.

6. Change any other settings as desired.
7. Click Print.

Booklets (Binding Print)

General Information

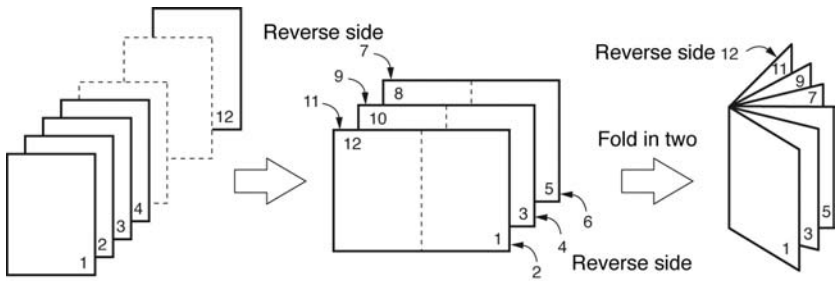

Booklet printing allows you to print a document like a brochure or greeting card.

Both the duplex unit and additional memory must be installed and enabled in the driver *before* using booklet printing.

Some applications do not support booklet printing.

Please read the Notes (below).

Booklet Printing Restrictions

NOTES

Both the duplex unit and additional memory must be installed and enabled in the driver *before* using booklet printing.

Not available on some network connections: see the Help file.

Some software applications may not support booklet printing.

The right-to-left setting allows a booklet to be printed for right to left reading, which is used in some languages.

Booklet printing is restricted to four (4) pages per sheet [two (2) pages per side].

Examples:

- print a 5½ x 8½ inch booklet on 8½ x 11 inch paper
- print an 8½ x 11 inch booklet on 11 x 17 inch paper

Most applications allow the printer properties to be accessed from within the document print dialog box.

Application settings override driver settings.

Driver settings override printer menu settings.

Windows

NOTES

Before booklet printing can be carried out, both the duplex unit and additional memory must be

- installed
- enabled in the driver.

Not available on some network connections: see the Help file.

Some software applications may not support booklet printing.

The right-to-left setting allows a booklet to be printed for right to left reading, which is used in some languages.

Booklet printing is restricted to four (4) pages per sheet [two (2) pages per side].

Examples:

- print a 5½ x 8½ inch booklet on 8½ x 11 inch paper
- print an 8½ x 11 inch booklet on 11 x 17 inch paper

Most applications allow the printer properties to be accessed from within the document print dialog box.

Application settings override driver settings.

Driver settings override printer menu settings.

1. Open the file you want to print.
2. Click File → Print.
3. In the Print dialog box, select your printer.
4. Next:
Windows 98/Me/NT4.0: click Properties.
Windows XP: click Preferences.
Windows 2000: go to the next step.
5. On the Setup tab, under Finishing Mode, in the drop-down list, select Booklets.

6. Click Options. Enter your settings. Click OK.
7. Next:
Windows 98/Me/NT4.0: .
Windows XP: click OK.
Windows 2000: go to the next step.
8. Next:
Windows 98/Me/NT4.0: click OK.
Windows XP: click Print.
Windows 2000: click Print.

Macintosh

OS 10.2 and 10.3

This feature is not available in these operating systems.

Collating

General Information

Important

If your software application has a collate option, use it instead of the collate option in the printer driver. This prevents any conflicts between the software application and the printer driver.

NOTE

Most applications allow the printer properties to be accessed from within the document print dialog box. Application settings override driver settings. Driver settings override printer menu settings.

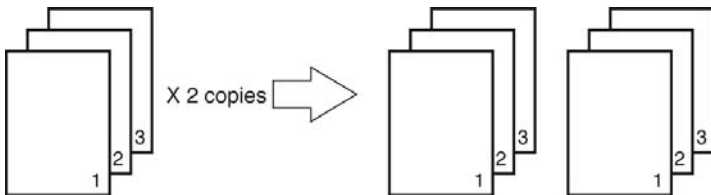

Collating is printing multiple copies of a multi-page job where each copy has the pages arranged in the correct order.

If you print multiple copies of a multi-page job and DO NOT specify collating, all of the copies of the first page print before the copies of the subsequent page(s) print.

Windows

Important

If your software application has a collate option, use it instead of the collate option in the printer driver.

This prevents any conflicts between the software application and the printer driver.

NOTE

Most applications allow the printer properties to be accessed from within the document print dialog box.

Application settings override driver settings.

Driver settings override printer menu settings.

1. Open the file you want to print.
2. Click File → Print.
3. In the Print dialog box, select your printer.
4. Next:
Windows 98/Me/NT4.0: click Properties.
Windows XP: click Preferences.
Windows 2000: go to the next step.
5. On the Job Options tab, under Job Type, enter the number of copies required. Select Collate.
6. Next:
Windows 98/Me/NT4.0/XP: click OK.
Windows 2000: go to the next step.
7. Next:
Windows 98/Me/NT4.0: click OK.
Windows XP/2000: click Print.

Macintosh

OS 10.2 and 10.3

1. Open the file you want to print.
2. Click File → Print.
3. Open the drop-down list below Presets. Select Copies & Pages.
4. At Collated, make your selection.
If the box has a check mark, the feature is ON.
If the box is empty, the feature is OFF.
5. Change any other settings as desired.
6. Click Print

Overview

NOTE

Most applications allow the printer properties to be accessed from within the document print dialog box. Application settings override driver settings. Driver settings override printer menu settings.

Color reproduction is a complex topic.

This topic is divided into two sections:

- background information

The background information explains the factors that affect color matching.

See page 164.

- how-to information

The how-to information explains how to perform color matching with your printer.

See page 180.

Background Information

NOTE

Most applications allow the printer properties to be accessed from within the document print dialog box. Application settings override driver settings. Driver settings override printer menu settings.

Color reproduction is a complex topic.

This background information explains the factors that affect color matching.

Background information is divided into these sections:

1. Factors that Affect Color Printing: see page 165
2. Choosing a Color Matching Method: see page 171
3. Printing Vivid Colors: see page 176
4. Color Settings: see page 177
5. Hue, Brightness, and Saturation: see page 179

Color Matching

Factors that Affect Color Printing

There are many factors that affect color printing.

Some of the most important factors are:

- the differences between the range of colors a monitor can reproduce versus the range of colors that a printer can reproduce. See page 166.
- monitor settings. See page 167.
- color settings in your software application. See page 168.
- how your software application displays color. See page 168.
- color settings in your printer driver. See page 169.
- viewing (lighting) conditions. See page 170.
- paper type. See page 170.

Color Matching

Factors that Affect Color Printing

Monitor Colors vs. Printer Colors

(Differences between the range of colors a monitor or printer can reproduce)

Neither a printer nor a monitor can reproduce the full range of colors seen by the human eye.

Each device is limited to a certain range of colors.

- A printer cannot reproduce all of the colors displayed on a monitor.
- A monitor cannot reproduce all of the colors printed by a printer.

Both devices use very different technologies to represent color.

- A monitor uses Red, Green and Blue (RGB) phosphors (or LCDs).
- A printer uses Cyan, Yellow, Magenta and Black (CMYK) toner or ink.

Very vivid colors (such as intense reds and blues) can be displayed on a monitor. These same colors cannot be easily produced on *any* printer using toner or ink.

There are certain colors (for example, some yellows), that can be printed, but cannot be displayed accurately on a monitor.

These differences between monitor colors and printer colors are the main reasons why printed colors do not always match the colors displayed on screen.

Color Matching

Factors that Affect Color Printing

Monitor Settings

The brightness and contrast controls on your monitor can change how your document looks on-screen.

Your monitor color temperature also influences how "warm" or "cool" the colors look.

NOTE

Several of the Color Matching options make reference to your monitor's Color Temperature. Many monitors allow you to adjust the color temperature through their control panels.

There are several settings found on a typical monitor:

5000k * or D50

Warmest; yellowish lighting.

Typically used in graphics arts environments.

6500k * or D65

Cooler

Approximates daylight conditions.

9300k *

Cool

The default setting for many monitors and television sets.

*k = degrees Kelvin, a measurement of temperature

Macintosh OS 10.1, 10.2, and 10.3

You can calibrate your monitor's color regimen in System Preferences → Displays → Color.

Color Matching

Factors that Affect Color Printing

Software Settings

Many software applications have their own color settings.

The application settings may override the settings in the printer driver.

Please refer to the documentation for your software application for details on how that particular program's color management functions.

How the application displays color

Some graphics applications such as CorelDRAW®, Adobe® Photoshop®, or Macromedia Freehand® may display color differently from "office" applications such as Microsoft® Word.

For more information, please see your application's online help or user manual.

Color Matching

Factors that Affect Color Printing

Printer Driver Settings

The color settings in your printer driver can change the appearance of a document.

There are several options available to help match the printed colors with those displayed on screen.

See "How To" on page 180.

For Windows

The printer drivers supplied with your printer provide several controls for changing the color output.

The default driver settings produce good results for most documents.

For Macintosh

The install utility provides

- a color matching profile for your printer and
- a Color Option utility in the print driver.

The **Auto** settings produce good results for most documents.

See "Auto Color" on page 181.

Color Matching

Factors that Affect Color Printing

Lighting (Viewing) Conditions

A document can look very different under various lighting conditions.

For example, the colors may look different when viewed standing next to a sunlit window compared to how they look under standard office fluorescent lighting.

Paper Type

The type of paper used can also significantly affect the printed color.

For example, a printout on recycled paper can look duller than one on specially formulated glossy paper.

Color Matching

Choosing a Color Matching Method

General Information

NOTE

These suggestions are for guidance only.
Your results may vary depending on the application from which you are printing.
Some applications override, without warning, any color matching settings in the printer driver.

There is no one way to achieve a good match between the document displayed on your monitor, and its printed equivalent.

There are many factors involved in achieving accurate and reproducible color.

However, the following guidelines may help in achieving good color output from your printer.

There are several suggested methods. The method you choose is determined by the type of document you are printing.

- most common [RGB]. See page 173.
- professional desktop publishing and graphics [CMYK]. See page 173.
- photographic images. See page 174.
- specific colors (i.e., a company logo). See page 175.
- printing vivid colors. See page 176.

Color Matching

Choosing a Color Matching Method

Your choices are:

Auto Color

Advanced Color

Grayscale

Auto Color

Your printer automatically uses the best method to match color, depending on the type of document you are printing.

See "Auto Color" on page 181.

Advanced Color

Advanced Color allows you to customize the color matching settings you use.

Color matching is a complex topic. Use Advanced Color only if you are comfortable with color matching concepts!

See "Advanced Color" on page 183.

Grayscale

This option prints all documents as monochrome.

No color prints.

The printer interprets all colors as a variation of grays.

See "Grayscale" on page 185.

Color Matching

Choosing a Color Matching Method

RGB or CMYK?

The guidelines for choosing a color matching method make distinctions between RGB and CMYK.

RGB = Red, Green, Blue

and

CMYK = Cyan, Magenta, Yellow, Black.

Most documents you print are in RGB format. This is the most common method. If you do not know your document's color mode, assume that it is RGB.

CMYK documents are typically only supported in professional Desktop Publishing and Graphics applications.

Windows and Macintosh 10.2 and 10.3

The driver and Color Swatch Utility supplied with your printer support only RGB. If you wish to use CMYK, you might be able to use the software application's Soft Proofing feature.

Color Matching

Choosing a Color Matching Method

Matching Photographs

RGB only

Select a matching method appropriate to your monitor.

Windows

Natural is generally a good choice. Select a matching method appropriate to your monitor.

See "Color Settings" on page 177.

Macintosh

OS 10.2 and 10.3

Natural is a generally a good choice. Select a matching method appropriate to your monitor.

See "Color Settings" on page 177.

RGB or CMYK

If you are printing photographic images from a graphics application such as Adobe Photoshop, you may be able to use Soft-Proofing to simulate the printed image on your monitor.

Color Matching

Choosing a Color Matching Method

Matching Specific Colors

(Example: Company logo)

RGB only

Windows

- **Color Swatch Utility**

Use the Color Swatch Utility to print out a chart of RGB swatches. Select your desired RGB values from the swatches. Enter the values in your application's color picker

See "Color Swatch Utility" on page 243.

Macintosh

OS 10.2 and 10.3

- **Color Swatch Utility**

Use the Color Swatch Utility to print out a chart of RGB swatches. Select your desired RGB values from the swatches. Enter the values in your application's color picker

See "Color Swatch Utility" on page 243.

RGB or CMYK

If you are printing from a graphics application such as Adobe Photoshop, you may be able to use Soft-Proofing to simulate the printed image on your monitor.

Color Matching

Choosing a Color Matching Method

Printing Vivid Colors

RGB only

Choices are

- Monitor 6500k Vivid
- sRGB
- Digital Camera settings.

Windows

See "Color Settings" on page 177.

Macintosh

OS 10.2 and 10.3

See "Color Settings" on page 177.

RGB or CMYK

Windows

Auto is a generally a good choice.

See "Auto Color" on page 181.

Macintosh

OS 10.2 and 10.3

Auto is a generally a good choice.

See "Auto Color" on page 181.

Color Settings

This is a list of all possible options.

The list you see varies according to your computer platform, operating system, color production method, and printer driver type.

You can modify these settings by selecting Advanced Color, then Natural. See "Advanced Color" on page 183.

Monitor (6500k) Auto

The default setting (in Macintosh) that selects the best options for your printer. This selection works best for office situations.

Optimized for printing general documents when using a monitor with a color temperature of 6500K.

Monitor (6500k) Perceptual

This is best choice for printing photographic images.

Optimized for printing photographs when using a monitor with a color temperature of 6500K.

Monitor (6500k) Vivid

Ideal for office graphics and text.

Optimized for printing bright colors when using a monitor with a color temperature of 6500K. Vivid or Digital Camera settings produce brightest colors.

Monitor (9300k)

Optimized for printing photographs when using a monitor with a color temperature of 9300K.

Digital Camera

Optimized for printing photographs taken with a digital camera. This tends to produce prints with lighter and brighter colors.

For some photographs, other settings may be better depending on the subjects and the conditions under which they were taken. Vivid or Digital Camera settings produce brightest colors.

sRGB

This option attempts to simulate RGB color.

Optimized for matching specific colors, such as a company logo color. The colors within the printer's color gamut are printed without any modification. Only colors that fall outside the printable colors are modified.

Hue, Brightness, and Saturation

There are three main components to color: Hue, Brightness, and Saturation.

Hue

The component that determines the frequency of light or the position in the spectrum or the relative amounts of red, green and blue. Hue corresponds to the common definition of color, e.g. "red", "orange", "violet" etc.

Brightness

The component that determines the total amount of light (white) in the color. Zero brightness is black. 100% Brightness is white. Intermediate values are "light" or "dark" colors.

Windows and Macintosh 10.3

Brightness can be adjusted when using the Advanced Color or Gray Scale color modes (color matching methods).

Advanced Color: see page 183

Gray Scale: see page 185

Saturation

The degree of saturation of a color is its relative purity, or freedom from, mixture with white.

Windows and Macintosh 10.3

Saturation can be adjusted when using the Advanced Color or Gray Scale color modes (color matching methods).

Advanced Color: see page 183

Gray Scale: see page 185

How To

NOTE

Most applications allow the printer properties to be accessed from within the document print dialog box.
Application settings override driver settings.
Driver settings override printer menu settings.

Color reproduction is a complex topic.

This how-to information explains how to perform color matching with your printer.

List of Color Matching Methods

This is a list of all possible options.

The list you see varies according to your computer platform, operating system, color production method, and printer driver type.

To change these settings in your printer driver, refer to the appropriate section.

- Auto Color: see page 181
- Advanced Color: see page 183
- Grayscale: see page 185

Auto Color

Your printer automatically uses the best method to match color, depending on the type of document you are printing.

Windows

Individual Print Jobs

NOTE

The driver's color options are only designed to work with RGB data.

1. Open the file you want to print.
2. Click File → Print.
3. Click on the Color tab.
4. At Auto Color, make your selection.
If the box has a check mark, the feature is ON.
If the box is empty, the feature is OFF.
5. Click OK until you return to the Print dialog box.
6. Print the document.

All Print Jobs (Default)

1. Click Start → Settings → Printers [Printers and Faxes in Windows XP].
2. Right-click the printer name.
3. Next
Windows 98/Me: select Properties. Click Printer Properties.
Windows 2000/XP: select Properties. Click Printing Preferences.
Windows NT 4.0: select Document Defaults.
4. Click on the Color tab.
5. At Auto Color, make your selection.
If the box has a check mark, the feature is ON.

If the box is empty, the feature is OFF.

6. Click OK until you return to the Print dialog box.
7. Print the document.

Macintosh

OS 10.2 and 10.3

1. Open the file you want to print.
2. Click File → Print.
3. Open the drop-down list below Presets. Select Color.
4. Below Color Mode, at Auto Color, make your selection.
If the box has a check mark, the feature is ON.

If the box is empty, the feature is OFF.

5. Click Print.
6. The document prints.

Advanced Color

Advanced Color allows you to customize the color matching settings you use.

Color matching is a complex topic. Use Advanced Color only if you are comfortable with color matching concepts!

Windows

Individual Print Jobs

NOTE

The driver's color options are only designed to work with RGB data.

1. Open the file you want to print.
2. Click File → Print.
3. Click on the Color tab.
4. At Advanced Color, make your selection.
If the box has a check mark, the feature is ON.
If the box is empty, the feature is OFF.
5. Change any other settings as desired.
6. Click Print.
7. The document prints.

All Print Jobs (Default)

1. Click Start → Settings → Printers [Printers and Faxes in Windows XP].
2. Right-click the printer name.
3. Next
Windows 98/Me: select Properties. Click Printer Properties.
Windows 2000/XP: select Properties. Click Printing Preferences.
Windows NT 4.0: select Document Defaults.
4. Click on the Color tab.

5. At Advanced Color, make your selection.
If the box has a check mark, the feature is ON.
If the box is empty, the feature is OFF.
6. Change any other settings as desired.
7. Click Print.
8. The document prints.

Macintosh

OS 10.2 and 10.3

1. Open the file you want to print.
2. Click File → Print.
3. Open the drop-down list below Presets. Select Color.
4. Below Color Mode, at Advanced Color, make your selection.
If the box has a check mark, the feature is ON.
If the box is empty, the feature is OFF.
5. Change any other settings as desired.
6. Click Print.
7. The document prints.

Grayscale

This option prints all documents as monochrome.

No color prints.

The printer interprets all colors as a variation of grays.

Windows

Individual Print Jobs

NOTE

The driver's color options are only designed to work with RGB data.

1. Open the file you want to print.
2. Click File → Print.
3. Click on the Color tab.
4. At Grayscale, make your selection.
If the box has a check mark, the feature is ON.
If the box is empty, the feature is OFF.
5. Change any other settings as desired.
6. Click Print.
7. The document prints.

All Print Jobs (Default)

1. Click Start → Settings → Printers [Printers and Faxes in Windows XP].
2. Right-click the printer name.
3. Next
Windows 98/Me: select Properties. Click Printer Properties.
Windows 2000/XP: select Properties. Click Printing Preferences.
Windows NT 4.0: select Document Defaults.
4. Click on the Color tab.

5. At Grayscale, make your selection.
If the box has a check mark, the feature is ON.
If the box is empty, the feature is OFF.
6. Change any other settings as desired.
7. Click Print.
8. The document prints.

NOTE

Once Grayscale is set as the default, you must select either Auto Color or Manual Color on the Color tab when you print color documents. See "List of Color Matching Methods" on page 180.

Macintosh

OS 10.2 and 10.3

1. Open the file you want to print.
2. Click File → Print.
3. Open the drop-down list below Presets. Select Color.
4. Below Color Mode, at Gray Scale, make your selection.
If the box has a check mark, the feature is ON.
If the box is empty, the feature is OFF.
5. Change any other settings as desired.
6. Click Print.

Color Matching

Color Synch

Macintosh OS 10.3

1. To access the print features, open your print driver from within an application by selecting File → Print.
2. Open the drop-down list below Presets. Select Color Synch.
3. At Color Conversion, select Standard.
4. At Quartz Filter, make your selection.

Choices are:

None, Black & White, Blue Tone, Gray Tone, Lightness Decrease, Lightness Increase, Reduce File Size, Sepia Tone, and Add Filters.

The following section has examples and explanations of each filter.

NOTE

To see the affect of any of these filters on your document, select Add Filters. Click the filter in the list. Click Apply.

Color Matching

Color Synch

Macintosh OS 10.3

Filters

None

The default. No filters are applied to the document.



Black & White

Converts the document to black and white, with no gray shades.



Blue Tone

Converts the document to shades of blue.



Gray Tone

Converts the document to shades of gray.



Lightness Decrease (A) / Lightness Increase (B)

Darkens or lightens the document. The middle picture below is with no filters applied.



A



B

Reduce File Size

This filters the document to reduce its file size.

Sepia Tone

Converts the document to shades of brown.



Add Filters

Clicking this brings up a Preview screen.

Here you can see the effect produced by selecting any of the standard filters.

To do this, click the name in the Filters box. Then, click Apply. You can also

- add New filters of your choice
- Delete filters you have added to the list
- set color conversion options such as Rendering Intent (Automatic, Perceptual, Relative, Saturation, Absolute), etc.



Custom Page Sizes

General Information

Using the Printer Driver

NOTE

Most applications allow the printer properties to be accessed from within the document print dialog box.

Application settings override driver settings.

Driver settings override printer menu settings.

Custom page sizes can be printed from Tray 1, Tray 2 or the Multi-Purpose (MP) Tray, one-sided printing only, rear exit only.

Tray 1 and Tray 2 Custom Size Range

- minimum 3.94" x 5.83" [100 x 148 mm]
- maximum 8½" x 14" [215.9 x 355.6 mm].

MP Tray Custom Size Range

- minimum 3.94" to 5.83" [100 x 148 mm]
- maximum 8½" x 14" [216 x 356 mm]
- banners from 8¼" to 8½" (210 to 215.9 mm) wide by up to 47¼" (1.2 m) long. Banners must be fed one sheet at a time.

Windows

Printing

NOTE

Up to 32 custom page sizes can be defined.

1. Make sure the rear exit path is open:



2. Load the custom size paper in the tray of your choice.
1. Open the file you want to print.
2. Click File → Print.
3. In the Print dialog box, select your printer.
4. Next:
Windows 98/Me/NT4.0: click Properties.
Windows XP: click Preferences.
Windows 2000: go to the next step.
5. On the Setup tab, under Media, in the Size drop-down list, select
User Defined Size from the bottom
or select a custom size you have already defined
See "Creating and Saving Custom Page Sizes" on page 194.

Define the custom size in the dialog box which appears.
Click OK

NOTE

You may see a Warning dialog box indicating a conflict. If you do, click OK and the driver will automatically make the needed changes to correct for the conflict.

6. Under Media, in the Source drop-down list, select the tray you will be using. Click OK.
7. Next:
Windows 98/Me/NT4.0: click OK.
Windows XP/2000: click Print.

Windows

Creating and Saving Custom Page Sizes

1. Click Start → Settings → Printers [Printers and Faxes for XP].
2. Right click the printer icon.
3. Next:
Windows 98/Me: select Properties. Click the Printer Properties tab.
Windows XP/2000: select Properties. Click Printing Preferences.
Windows NT 4.0: select Document Defaults.
4. On the Setup tab, click Paper Feed Options.
5. Click Custom Size.
6. For each size, enter a name, width and height. Click Add.
7. When done, click OK.
8. Click OK three more times.

Duplex Printing

(Printing on Both Sides of the Paper)

General Information

NOTE

The duplex unit must be installed and enabled in the driver *before* using duplex printing.

Most applications allow the printer properties to be accessed from within the document print dialog box.

Application settings override driver settings.

Driver settings override printer menu settings.

- Paper must be loaded print side *up*.
- Any tray (Tray 1, optional Tray 2, MP tray) can be used for duplex printing.

Paper Types

Paper *only*

Cannot duplex

labels

envelopes

transparencies

Paper Sizes

Size	Inches	Millimeters
Letter	8½ x 11	215.9 x 279.4
Legal-14	8½ x 14	215.9 x 355.6
Legal-13.5	8½ x 13.5	215.9 x 342.9
Legal-13	8½ x 13	215.9 x 330.2
Executive	7¼ x 10½	184.15 x
A4	8.27 x 11.69	210 x 297
A5	5.71 x 8.27	145 x 210
B5	7.17 x 10.12	182 x 257
Custom	Minimum 5.8 x 8.25 Maximum 8.5 x 14	Minimum 148 x 210 Maximum 215.9 x 355.6

Paper Weights

20 to 28-lb. US Bond

42 to 58 lb. Index

75 to 105 g/m² metric

Duplexing Restrictions

Important!

You can duplex

- paper
- paper weights up to
28 lb. US Bond
58 lb. Index
105 g/m² metric

You *cannot* duplex

- labels
- envelopes
- transparencies
- paper weights above
28 lb. US Bond
58 lb. Index
105 g/m² metric

Long Edge vs. Short Edge

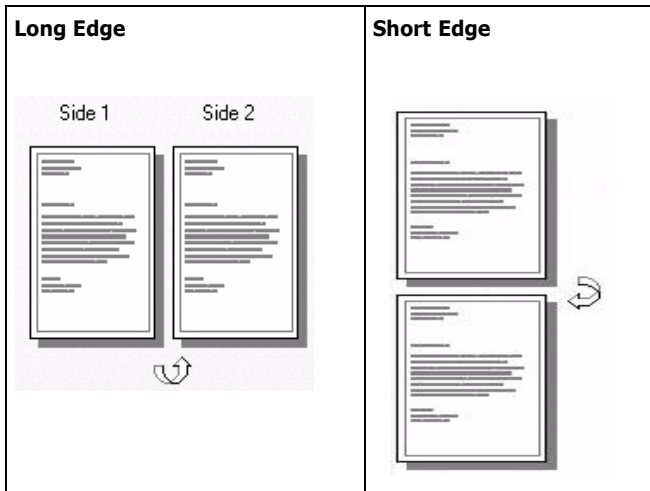

Windows

Individual Print Jobs

Please review General Information, on page 195, for important information about duplex printing.

1. Open the file you want to print.
2. Click File → Print.
3. In the Print dialog box, select your printer.
4. Next:
Windows 98/Me/NT4.0: click Properties.
Windows XP: click Preferences.
Windows 2000: go to the next step.
5. On the Setup tab, under 2-Sided Printing, make your selection.
Choices are Long Edge or Short Edge.

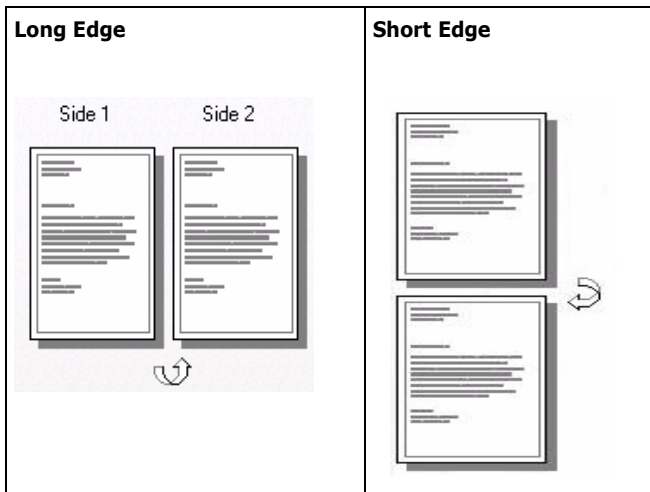

6. Next:
Windows 98/Me/NT4.0/XP: Click OK.
Windows 2000: go to the next step.
7. Next:
Windows 98/Me/NT4.0: click OK.
Windows XP/2000: click Print.

Windows

All Print Jobs (Default)

1. Click Start → Settings → Printers [Printers and Faxes for XP].
2. Right click the printer icon, then:
Windows 98/Me: select Properties. Click the Printer Properties tab.
Windows XP/2000: select Properties. Click Printing Preference.
Windows NT 4.0: select Document Defaults.
3. Follow steps below. Note that the screen for setting defaults will have more tabs.
4. On the Setup tab, under 2-Sided Printing, make your selection.
Choices are Long Edge or Short Edge.

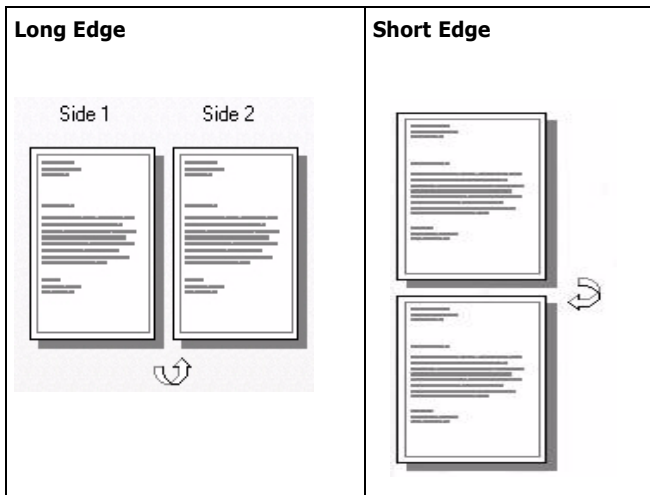

5. Next:
Windows 98/Me/NT4.0/XP: Click OK twice.
Windows XP/2000: click Print.

Macintosh

OS 10.2 and 10.3

1. Open the file you want to print.
2. Click File → Print.
3. Open the drop-down list below Presets. Select Duplex.
4. At Duplex, make your selection.
Choices are: Off, Long-Edge Binding, and Short-Edge Binding.

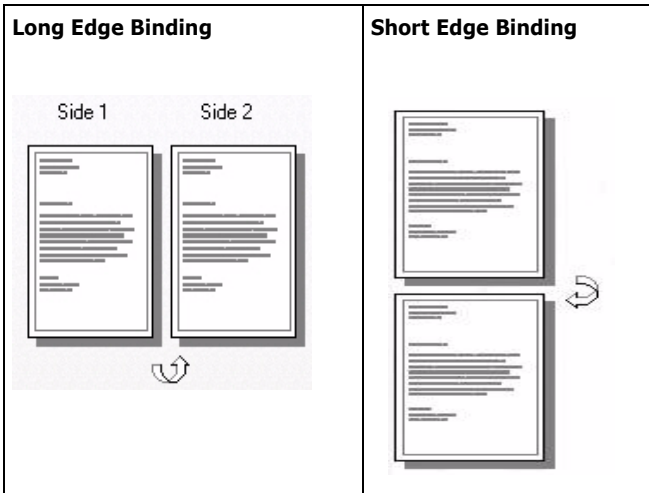

5. Change any other settings as desired.
6. Click Print.

Grayscale

This feature is described in the Color Matching section.
See "Grayscale" on page 185.

N-Up Printing

Printing Multiple Pages on One Sheet

General Information

N-Up printing allows you to reduce several full-size pages and print them on a single sheet.

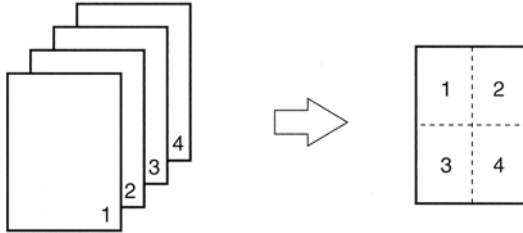

Windows

NOTE

Most applications allow the printer properties to be accessed from within the document print dialog box.

Application settings override driver settings.

Driver settings override printer menu settings.

1. Open the file you want to print.
2. Click File → Print.
3. In the Print dialog box, select your printer.
4. Next:
Windows 98/Me/NT4.0: click Properties.
Windows XP: click Preferences.
Windows 2000: go to the next step.

5. On the Setup tab, under Finishing Mode (**1**), select the required number of pages per sheet in the drop-down list.
6. To change additional settings, click Options (**2**).
Settings are:

Pages per Sheet

Use this to print up to 16 pages on one sheet.

Layout Direction

Use this to set the orientation in which multiple pages are printed on the sheet.

Border

When printing multiple pages on one sheet, use this to print a border between the sheets, if desired.

7. Make your selections. Click OK.
8. Next:
Windows 98/Me/NT4.0/XP: Click OK.
Windows 2000: go to the next step.
9. Next:
Windows 98/Me/NT4.0: click OK.
Windows XP/2000: click Print.

Macintosh

OS 10.2 and 10.3

1. Open the file you want to print.
2. Click File → Print.
3. Open the drop-down list below Presets. Select Layout.
4. Make your selections.

Pages per Sheet

Use this to print up to 16 pages on one sheet.

Layout Direction

Use this to set the orientation in which multiple pages are printed on the sheet.

Border

When printing multiple pages on one sheet, use this to print a border between the sheets, if desired.

5. Change any other settings as desired.
6. Click Print.

Photographs

For the best quality when printing photographs, select Photo Enhance in the driver.

Windows

All Print Jobs (Default)

1. Click Start → Settings → Printers [Printers and Faxes in Windows XP].
2. Right-click the printer name.
3. Next
Windows 98/Me: select Properties. Click Printer Properties.
Windows XP/2000: select Properties. Click Printing Preferences.
Windows NT 4.0: select Document Defaults.
4. Follow the steps below. Note that the screen for setting defaults will have more tabs.
5. On the Job Options tab, select Photo Enhance.
6. Change any other settings as desired.
7. Next:
Windows 98/Me/NT4.0/XP: click OK
Windows 2000: go to the next step.
8. Next:
Windows 98/Me/NT4.0: click OK
Windows XP/2000: click Print.

Windows

Individual Print Jobs

1. Open the file you want to print.
2. Click File → Print.
3. In the Print dialog box, select your printer.
4. Next:
Windows 98/Me/NT4.0: click Properties.
Windows XP: click Preferences.
Windows 2000: go to the next step.
5. On the Job Options tab, select Photo Enhance.
6. Change any other settings as desired.
7. Next:
Windows 98/Me/NT4.0/XP: click OK
Windows 2000: go to the next step.
8. Next:
Windows 98/Me/NT4.0: click OK
Windows XP/2000: click Print.

Macintosh

OS 10.2 and 10.3

1. Open the file you want to print.
2. Click File → Print.
3. Open the drop-down list below Presets. Select Print Quality.
4. Select Photo Enhance
5. Change any other settings as desired.
6. Click Print.

Posters

General Information

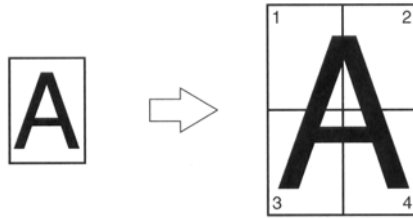

This option allows you to print posters by dividing a single document page into multiple pieces. Each piece prints, enlarged, on a separate sheet. Then, you combine the separate sheets to create a poster.

Windows

1. Open the file you want to print.
2. Click File → Print.
3. In the Print dialog box, select your printer.
4. Next:
Windows 98/Me/NT4.0: click Properties.
Windows XP: click Preferences.
Windows 2000: go to the next step.
5. On the Setup tab, under Finishing Mode, select PosterPrint.
6. Click Options... and enter the configuration details.
Note: an overlap of at least 0.2 mm must be specified.
7. Click OK.
8. Next:
Windows 98/Me/NT4.0/XP: click OK.
Windows 2000: go to the next step.
9. Next:
Windows 98/Me/NT4.0: click OK.
Windows XP/2000: click Print.

Macintosh

OS 10.2 and 10.3

This feature is not available in these operating systems.

Print Resolution

General Information

Adjusting the resolution for a print job allows you to control the print speed and print quality of a job. Adjusting the resolution also allows you to improve your toner mileage.

When printing proofs or drafts, you usually don't need the best possible print quality. You usually do need the fastest possible print speed. Using a lower print resolution can accomplish these goals.

Lowering the print resolution can reduce the need for toner and the wear on the image drum. This increases the mileage of your toner and drum.

Raising the print resolution can maximize the image quality of a print job. You usually do this for final versions of documents or when printing images (photographs).

Windows

All Print Jobs (Default)

1. Click Start → Settings → Printers [Printers and Faxes for XP].
2. Right click the printer icon.
3. Next:
Windows 98/Me: select Properties. Click the Printer Properties tab.

Windows XP/2000: select Properties. Click Printing Preferences.

Windows NT 4.0: select Document Defaults.

4. Follow the steps below. Note that the screen for setting defaults will have more tabs.
5. On the Job Options tab, under Quality, make your selection.

High Quality

The best quality image the printer provides.

Choose this for optimum results when printing graphics.

Fine/Detail (600 x 1200)

high resolution printing

Normal

standard resolution. The default.

- 6.** Change any other settings as desired.
- 7.** Next:
Windows 98/Me/NT4.0/XP: click OK.
Windows 2000: go to the next step.
- 8.** Next:
Windows 98/Me/NT4.0: click OK.
Windows XP/2000: click Print.

Windows

Individual Print Jobs

1. Open the file you want to print.
2. Select File →Print.
3. In the Print dialog box, select your printer.
4. Next:
Windows 98/Me/NT4.0: click Properties.
Windows XP: click Preferences.
Windows 2000: go to the next step.
5. On the Job Options tab, under Quality, make your selection.
High Quality
The best quality image the printer provides.
Choose this for optimum results when printing graphics.
Fine/Detail (600 x 1200)
high resolution printing
Normal
standard resolution. The default.
6. Change any other settings as desired.
7. Next:
Windows 98/Me/NT4.0/XP: click OK.
Windows 2000: go to the next step.
8. Next:
Windows 98/Me/NT4.0: click OK.
Windows XP/2000: click Print.

Macintosh

OS 10.2 and 10.3

1. Open the file you want to print.
2. Click File → Print.
3. Open the drop-down list below Presets. Select Print Quality.
4. Make your selection.

High Quality

The best quality image the printer provides.

Choose this for optimum results when printing graphics.

Fine/Detail (600 x 1200)

high resolution printing

Normal

standard resolution. The default.

5. Change any other settings as desired.
6. Click Print.

Save as File ---

General Information

Use Save as File to save print data to a file, without actually printing a hardcopy.

Save as File captures either a PDF or a PostScript file.

Windows

This feature is not available in this operating system.

Macintosh

OS 10.2 and 10.3

1. Open the file you want to print.
2. Click File → Print.
3. Open the drop-down list below Presets. Select Output Options.
4. At Save as File, make your selection.
If the box has a check mark, the feature is ON.
If the box is empty, the feature is OFF.
5. At Format, make your selection.
Choices are:
 Adobe® Acrobat® PDF
 PostScript®
6. Change any other settings as desired.
7. Click Print.

Toner Saving

General Information

Use Toner Save to maximize the life of your toner cartridges.

Toner Save uses less toner to create the printed images. Toner Save adjusts the darkness of the color halftones. Images may appear lighter than normal.

NOTES

Toner Save does not work if you are printing 100 per cent black.

Toner Save does not work if Gray Scale is the selected print mode.

Toner Save does not work with applications and operating systems that create print data in CIE color space.

Windows

Individual Print Jobs

Please review General Information, on page 215, for important information about toner saving.

- 1.** Open the file you want to print.
- 2.** Click File → Print.
- 3.** In the Print dialog box, select your printer.
- 4.** Next:
Windows 98/Me/NT4.0: click Properties.
Windows XP: click Preferences.
Windows 2000: go to the next step.
- 5.** Click on the Job Options tab.
- 6.** At Toner Saving, make your selection.
Checking this will enable toner saving, but reduce print quality.
If the box has a check mark, the feature is ON.
If the box is empty, the feature is OFF.
- 7.** Change any other settings as desired
- 8.** Next:
Windows 98/Me/NT4.0/XP: click OK.
Windows 2000: go to the next step.
- 9.** Next:
Windows 98/Me/NT4.0: click OK.
Windows XP/2000: click Print.

Windows

All Print Jobs (Default)

Please review General Information, on page 215, for important information about toner saving.

1. Click Start → Settings → Printers [Printers and Faxes for XP].
2. Right click the printer icon.
3. Next:
Windows 98/Me: select Properties. Click the Printer Properties tab.

Windows XP/2000: select Properties. Click Printing Preferences.

Windows NT 4.0: select Document Defaults.
4. Click on the Job Options tab.
5. Follow the steps below. Note that the screen for setting defaults will have more tabs.
6. At Toner Saving, make your selection.
Checking this will enable toner saving, but reduce print quality.

If the box has a check mark, the feature is ON.
If the box is empty, the feature is OFF.
7. Change any other settings as desired
8. Next:
Windows 98/Me/NT4.0/XP: click OK.

Windows 2000: go to the next step.
9. Next:
Windows 98/Me/NT4.0: click OK.

Windows XP/2000: click Print.

Macintosh

OS 10.2 and 10.3

1. Open the file you want to print.
2. Click File → Print.
3. Open the drop-down list below Presets. Select Print Quality.
4. At Toner saving, make your selection.
Checking this will enable toner saving, but reduce print quality.

If the box has a check mark, the feature is ON.

If the box is empty, the feature is OFF.

5. Change any other settings as desired.
6. Click Print.

Windows

Create a Watermark

1. Open the file you want to print.
2. Click File → Print.
3. In the Print dialog box, select your printer.
4. Next:
Windows 98/Me/NT4.0: click Properties.
Windows XP: click Preferences.
Windows 2000: go to the next step.
5. Click on the Job Options tab.
6. Click Watermark.
7. Click New.
8. Enter the text for your watermark.
9. Select the attributes (font, size, angle, etc.) for your watermark.
10. Click OK.
The new watermark appears in the Watermark list.
11. Change any other settings as desired
12. Click OK.
13. Next:
Windows 98/Me/NT4.0/XP: click OK.
Windows 2000: go to the next step.
14. Next:
Windows 98/Me/NT4.0: click OK.
Windows XP/2000: click Print.

Windows

Edit a Watermark

1. Open the file you want to print.
2. Click File → Print.
3. In the Print dialog box, select your printer.
4. Next:
Windows 98/Me/NT4.0: click Properties.
Windows XP: click Preferences.
Windows 2000: go to the next step.
5. Click on the Job Options tab.
6. Click Watermark.
7. Select a name from the Watermark list.
8. Click Edit.
9. Modify the text for your watermark.
10. Modify the attributes (font, size, angle) for your watermark.
11. Click OK.
12. Adjust where and how the watermark prints, if necessary.
Choices are: On first page only, In background, As outline only
13. Change any other settings as desired
14. Click OK.
15. Next:
Windows 98/Me/NT4.0/XP: click OK.
Windows 2000: go to the next step.
16. Next:
Windows 98/Me/NT4.0: click OK.
Windows XP/2000: click Print.

Windows

Print, using a Watermark

1. Open the file you want to print.
2. Click File → Print.
3. In the Print dialog box, select your printer.
4. Next:
Windows 98/Me/NT4.0: click Properties.
Windows XP: click Preferences.
Windows 2000: go to the next step.
5. Click on the Job Options tab.
6. Click Watermark.
7. Select a name from the Watermark list
8. Adjust where and how the watermark prints, if necessary.
Choices are: On first page only, In background, As outline only
9. Change any other settings as desired
10. Click OK.
11. Next:
Windows 98/Me/NT4.0/XP: click OK.
Windows 2000: go to the next step.
12. Next:
Windows 98/Me/NT4.0: click OK.
Windows XP/2000: click Print.

Macintosh

OS 10.2 and 10.3

This feature is not available in these operating systems.

Utilities

Overview

The following utilities are available for your printer.

Color Correction Utility see page 228

Color Swatch Utility see page 243

Direct Network Printing Utility (LPR) see page 247

Display Language Utility see page 249

Network Setup Utility see page 250

Print Job Accounting Utility

PrintSuperVision

Web Driver Installer

You may access the utilities two ways.

via the CD shipped with the printer

via a download from the internet, accessed through the Menu Installer on the CD

Here is a list of the utilities provided on the CD shipped with your printer.

Color Correction Utility see page 228

Color Swatch Utility see page 243

Direct Network Printing Utility (LPR) see page 247

Display Language Utility see page 249

Network Setup Utility see page 250

Here is a list of the utilities provided via download.

Print Job Accounting Utility

PrintSuperVision

Web Driver Installer

Descriptions of Utilities

1. Color Correction Utility

This utility allows you to fine tune the printer's color settings and save them for future use.

See "Color Correction Utility" on page 228.

2. Color Swatch Utility

This utility allows you to print color samples or swatches on your color printer. The swatches are used with your software program to select and reproduce color accurately. The swatches represent selected samples of the your printer's color palette and can be used to find the desired colors for your printed documents.

See "Color Swatch Utility" on page 243.

3. Direct Network Printing Utility (LPR)

The Direct Network Printing Utility (LPR) allows you to print directly to a printer on the network without a print server. It creates a Printer Port, and installs a pop-up status box so you can monitor printer status.

The Direct Network Printing Utility (LPR) operates in Windows Me/98, Windows NT 4.0, Windows 2000, and Windows XP operating systems.

See "Direct Network Printing Utility (LPR)" on page 247.

4. Display Language Utility

This utility allows you to change the language of the front panel of your printer.

See "Display Language Utility" on page 249.

5. Network Setup Utility

This utility provides an easy way to configure your printer on a network.

See the online Network User's Guide for details on how to use this utility. See "Network Setup Utility" on page 250.

6. Print Job Accounting Utility

The Print Job Accounting software, designed specifically for Sharp printers in a network environment, provides job accounting features that allow you to track printer usage, calculate printing costs, and specify access available to each client (user).

7. PrintSuperVision

PrintSuperVision is a web-based application for managing printing devices connected to a network. PrintSuperVision provides access to networked printer data for monitoring, reporting and managing networked printers. It provides a full range of management functions for Sharp printers, and for other brands of printers as well.

8. Web Driver Installer

This utility is a web-based application. It automates tasks for a network administrator.

- Discovering printers connected to a TCP/IP network
- Displaying discovered printers on a web page
- Sending users e-mail notification of the URL that permits the downloading of printer driver installation programs for discovered printers.

Administrators can use this utility to manage printers and users organized in groups, such as departments or floors.

Installing the Utilities

Windows

Utilities on the CD

Load the utilities from the Menu Installer located on the CD supplied with your printer.

Download Utilities

Download the utilities from the internet, accessed through the Menu Installer on the CD.

Macintosh

OS 9.x

Utilities on the CD

1. Insert the CD supplied with your printer into the CD-ROM drive.
2. Double-click the CD icon that appears on the desktop.
3. Open the MAC folder.
4. Click PSDRV → English. Double click the Mac Installer icon.
5. Click Continue. Accept the Software License Agreement.
6. Select Custom Install to access the Utility Installation.
7. Click the boxes beside the Utilities you wish to install. Click Install.

The Utilities install into the folder you specify during the installation process.

Download Utilities

Download the utilities from the internet, accessed through the Menu Installer on the CD.

OS 10.1, 10.2, and 10.3

Utilities on the CD

The utilities on the CD are not available for Mac OS X and will only run on Mac 9.x or Classic OS.

Once the Print Job Accounting utility has been set up by your Network Administrator, it is transparent to the operation of the printer driver on your OS X system.

Download Utilities

Download the utilities from the internet, accessed through the Menu Installer on the CD.

Color Correction Utility ---

General Information

This utility allows you to fine tune the printer's color settings and save them for future use.

The Color Correct Utility is the best choice for working with Microsoft Excel or Word.

You can use the Color Correct Utility to:

- Change the Pallet Color: see page 229
- Adjust the Gamma Value and Hue: see page 239

How to Install

Load this program from the Menu Installer located on the CD.

Additional Information

For more information, see the on-line help in the utility.

Change the Pallet Color

General Information

NOTES

This feature is not available for Windows Me/98.
This feature is not available for shared printers.
When test printing, use paper larger than B5 size.

There are four steps in changing the Pallet Color.

1. Print the Sample Color Chart.
See page 230.
2. Print the Color Adjustment Chart.
See page 231.
3. Make the adjustments. Save the adjustments, using a name you select.
See page 233.
4. When printing a document, select the name of the saved adjustment settings.
See page 238.

Change the Pallet Color

Step 1: Print the Sample Color Chart

1. Click Start → Programs → All Applications.
Windows XP
Click Start → Programs → Okidata → Color Correct Utility → Color Adjustment Utility.
2. Select Adjust Pallet Color. Click Next.
3. The Select Printer screen appears. Select the printer you are using. Click Next.
The Color Correct Utility starts.
Installed printer drivers display. You must setup each driver.
4. The Select Setting screen appears. From the list, select the desired setting. Click Sample Print.
5. The Sample Color Chart prints.

Change the Pallet Color

Step 2: Print the Color Adjustment Chart

First, you must perform the steps in "Step 1: Print the Sample Color Chart" see page 230.

6. Click Next.
7. The Pallet Color Matching screen appears.

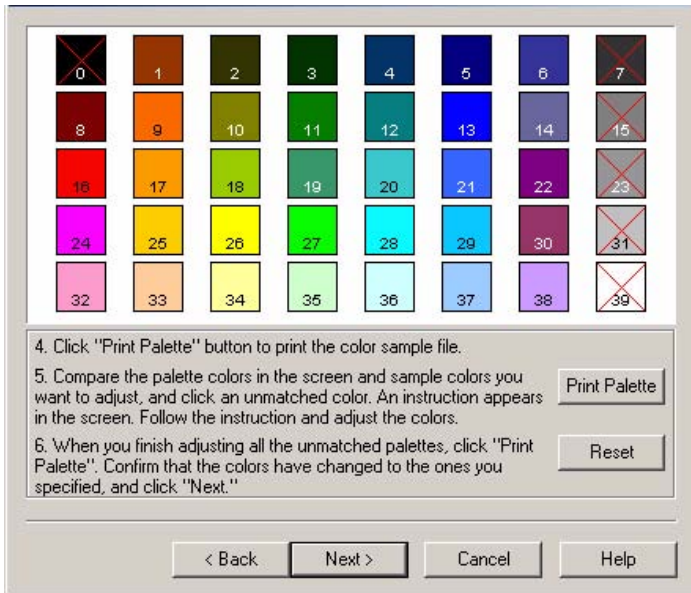

8. Click Test print.
The Color Adjustment Chart prints.

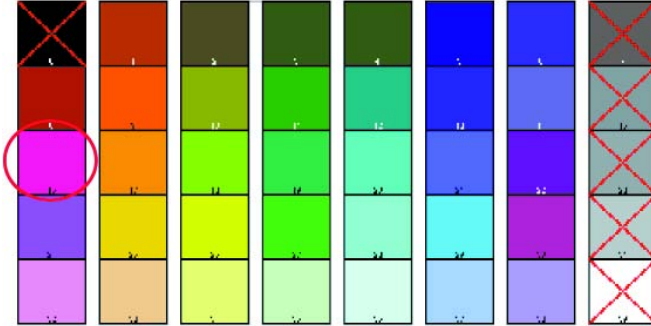

9. Compare the printed Color Adjustment Chart to the Pallet Color Matching screen.
If the printed colors do not match the screen, perform an adjustment.
You cannot adjust colors marked with an X.

Change the Pallet Color

Step 3: Make the adjustments and save the settings

First, you must perform the steps in "Step 1: Print the Sample Color Chart" see page 230 and "Step 2: Print the Color Adjustment Chart" see page 231.

When making the adjustments, you are obtaining the best possible match between the values for Hue and Brightness on your Sample Color Chart and the Pallet Color Matching screen.

10. On the Pallet Color Matching screen, click the color you want to adjust.

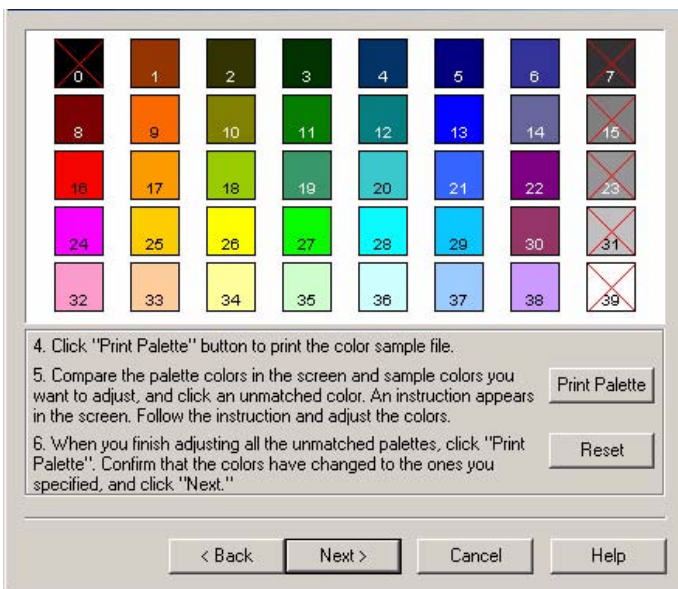

11. The Enter Adjustment Value screen appears.

View the pull down menus for the Hue (X) and Brightness (Y) values.

You are finding the available ranges for both Hue (X) and Brightness (Y).

The available ranges (values) vary according to color.

12. Use the Sample Color Chart.

Find the color you want to adjust.

Locate the desired color within the identified available ranges (values) from Step 10.

Find the values for both Hue (X) and Brightness (Y)

- On the Pallet Color Matching screen, click the color you want to adjust.
The Enter Adjustment Value screen appears.
View the pull down menus for the Hue (X) and Brightness (Y) values.
Adjust the values for Hue and Brightness to match the values from Step 11.

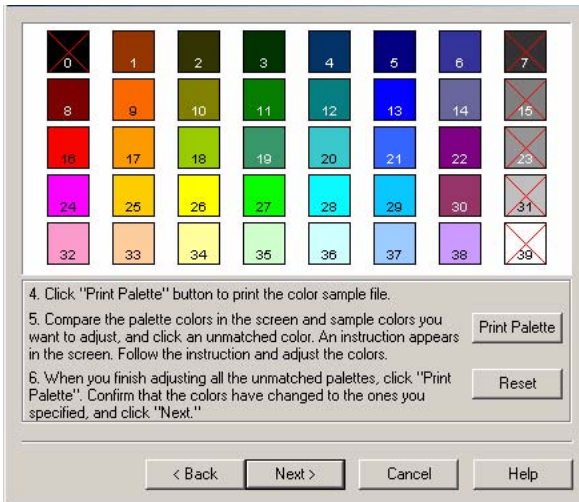

14. Click OK.
15. The Pallet Color Matching screen appears.

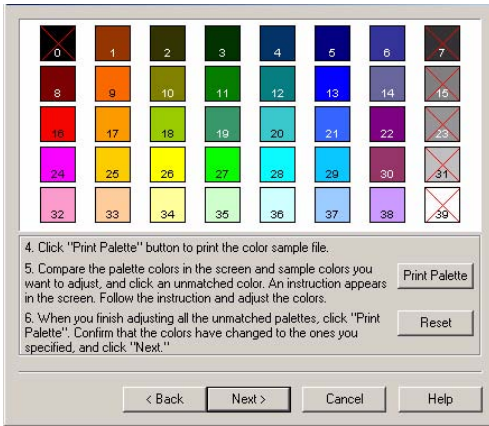

- Click Test Print.
The Color Adjustment Chart prints.

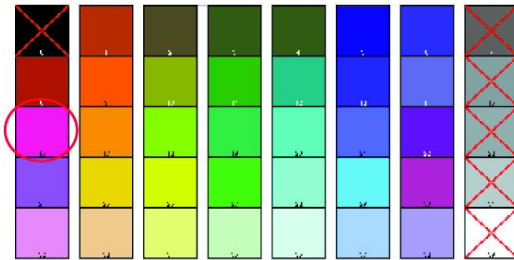

- Compare the printed Color Adjustment Chart to the Pallet Color Matching screen.
If you are satisfied with the comparison, go to step 17.
If you are not satisfied, repeat steps 10 through 16.
- If you have another color you want to adjust, repeat 10 through 16.
- When you have finished adjusting all desired colors, click Next.
- Enter the setting name. Remember the name for future use.
- Click Save.
- Click OK.

Change the Pallet Color

Step 4: Use the saved settings to print a document

Windows

1. Open the file you want to print.
2. Click File → Print.
3. In the Print dialog box, select your printer.
4. Next:
Windows XP: Click Properties. Click Advanced.
Windows 2000: go to the next step.
5. On the Color tab, under Color Mode, under User Setting, select the Color Matching name you created using the Color Correct Utility
6. Click OK.
7. Print the document.

Adjust the Gamma Value and Hue

General Information

NOTES

This feature is not available for Windows Me/98.
This feature is not available for shared printers.
When test printing, use paper larger than B5 size.
You must have Administrator authority when setting up a network connection in Windows XP/2000/NT4.0/Server 2003.

1. Click Start → Programs → All Applications.
2. Your action depends on your operating system.
Windows XP: Click Okidata → Color Correct Utility → All Applications.
Windows 2000: Go to the next step.
3. Select Correct gamma and hue.
4. Click Next.
5. The "Select printer" screen appears. Select the printer you want to adjust.
6. Click Next.
7. The Color Correct Utility starts.
The installed printer drivers display.
You must setup the Color Correct Utility for each driver.
8. In the list box, select the mode.
9. Click Next.

10. Change the slide bar values of gamma, hue, brightness, and saturation to adjust the color.

Use primary colors of ink

Select this to adjust the settings to the standard hues for the printer.

Hue	Toner printing
R (Red)	50% yellow and 50% magenta
Y (Yellow)	100% yellow
G (Green)	50% cyan and 50% yellow
C (Cyan)	100% cyan
B (Blue)	50% magenta and 50% cyan
M (Magenta)	100% magenta

The Gamma slide bar adjusts *total* brightness.

The Hue/Brightness slide bar adjusts output color.

Use the printer color buttons to switch to a different color.

Brightness

For Brighter color, slide the Gamma bar to the *left*.

Hue

Adjustments are made relative to positions on the color wheel.

Move forward = + (counter-clockwise)

Move backward = - (clockwise)

Example: adjust the Y (yellow) slide bar:

Move forward = + (counter-clockwise), the color becomes more green.

Move backward = - (clockwise), the color becomes more red.

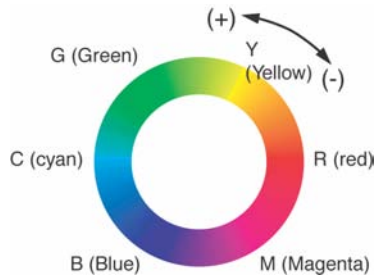

11. Click Test Print.
12. The Adjustment Confirmation Sample prints.
13. If the sample meets your requirements, click Set.
If the sample does not meet your requirements, repeat Steps 10 - 12 until your requirements are met. Then, click Set.
14. Click Save.
15. Enter the setting name.
16. Click OK.
17. Click OK.

NOTE

When you update or reinstall a printer driver, the Color Correct Utility reloads the created Color Matching names. Make sure that the Color Matching names appear in the [Setting Selection]. Click Complete.

18. Click Complete to exit the Color Correct Utility.
19. When printing a document, select the setting name.

Adjusting the Gamma Value and Hue

Use the saved settings to print a document

Windows

1. Open the file you want to print.
2. Click File → Print.
3. In the Print dialog box, select your printer.
4. Next:
Windows XP: Click Properties. Click Advanced.
Windows 2000: Go to the next step.
5. On the Color tab, under Color Mode, under User Setting, select the Color Matching name you created using the Color Correct Utility.

NOTE

When you update or reinstall a printer driver, the Color Correct Utility reloads the created Color Matching names. Make sure that the Color Matching names appear in the [Setting Selection]. Click End.

6. Click OK.
7. Print the document.

Color Swatch Utility

General Information

The Color Swatch Utility allows you to

- print color samples (swatches) on your color printer.
- create custom color swatches

The swatches are used with your software program to select and reproduce color accurately.

The swatches represent selected samples of the printer's color palette. Use the swatches to find the desired colors for your printed documents.

NOTE

- **The Swatch Utility does not guarantee that the printer prints the same color as displayed on your monitor. Consider the displayed color as a reference.**
- **The printer may not be able to print the exact color that you desire.**
- **Your software may not be able to match colors using the swatch information. You may need to use other matching methods.**
- **The color swatch samples do not show all the colors your printer can print.**
- **Other factors influence how you see color: the color and finish of the paper, ambient light, even the color surrounding the one you are looking at.**

How to Install

Load this program from the Menu Installer located the CD.

Additional Information

For additional information, see the Swatch Utility Read-me file located in the Windows Programs list.

Printing Color Swatches

NOTE

- **The color swatch samples do not show all the colors your printer can print.**
- **The Swatch Utility does not guarantee that the printer prints the same color as displayed on your monitor. Consider the displayed color as a reference.**
- **The printer may not be able to print the exact color that you desire.**

1. Install the utility from the CD using the Menu Installer (Windows).
2. Click Start → Programs → Color Swatch → Color Swatch Utility.
3. A swatch page displays, showing commonly used colors.

4. Select print to print sample pages.

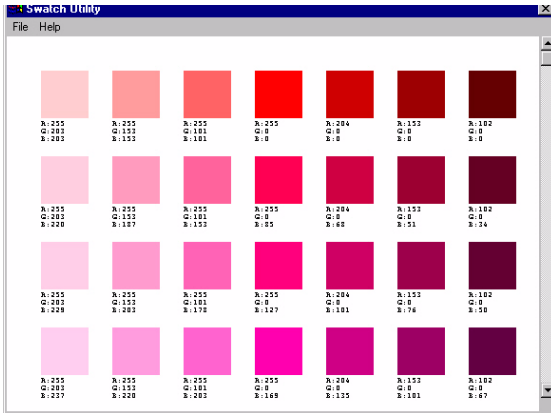

5. Use the color blocks to pick the specific colors that you want to appear in your printed document.
Each color block, or sample, is identified with information your software package needs to reproduce that color accurately.

The numbers under each block specify the amounts of the primary colors—red (R), green (G), and blue (B)—that mix to form each particular shade.

The amounts are given as a numerical value between 0 and 255.

Creating Custom Swatch Colors

NOTE

The Swatch Utility does not guarantee that the printer prints the same color as displayed on your monitor. Consider the displayed color as a reference.

The printer may not be able to print the exact color that you desire.

If you don't find your desired color, you can create or customize colors:

1. Select Custom Swatch from the File menu.
2. On the pop-up window, there are 3 slide bars that allow you to customize swatches:
 - Hue bar changes the hue of the swatches, for example, red to green or blue to yellow.
 - Saturation bar changes vividness.
 - Lightness bar changes darkness.
3. Adjust the bars until you see the desired color. Color variations are created to help you find the best match.
4. Click OK.
5. Print the custom swatch page.
6. Repeat these steps until you find the desired printed color.
7. For additional information, see the Swatch Utility Read-me file located in the Windows Programs list. The file includes:
 - Applying Color Value in your Application
 - Setting Monitor Color

Direct Network Printing Utility (LPR) _____

General Information

The Direct Network Printing Utility (LPR) allows you to print directly to a printer on the network without a print server. It creates a Printer Port, and installs a pop-up status box so you can monitor printer status.

The Direct Network Printing Utility (LPR) operates in Windows Me/98, Windows NT 4.0, Windows 2000, and Windows XP operating systems.

Load this program from the Menu Installer located the CD.

How to Install

The Direct Network Printing Utility (LPR) supports TCP/IP. Your network administrator will first need to set up an IP address and TCP/IP properties for your printer.

Your network administrator may have already installed this software. If you need to install it manually, load it from the Menu Installer on the CD:

1. Place the CD supplied with your printer in your CD-ROM drive. Wait for the Menu Installer to open.
If the CD does not AutoPlay, click Start → Run → Browse. Browse to your CD-ROM. Double-click Install.exe. Click OK.
2. Click Next to accept the terms in the license agreement.
3. Click Optional Utilities → Install Direct Network Printing Utility. Follow the on-screen instructions.

Direct Network Printing Utility (LPR) Status Box

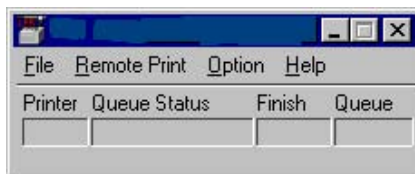

The Direct Network Printing Utility (LPR) Status Box displays the following information:

- Printers

Names of added printers (You can add up to 30 printers)

- Status

Direct Network Printing Utility (LPR) status (empty, connecting, sending, paused, checking status, not connected)

- Finish

Number of completed jobs.

- Queue

Number of jobs waiting to be printed.

Additional Information

For help, click on **HELP** in the program.

Display Language Utility ---

General Information

This utility allows you to change the language of the front panel of your printer.

How to Install

Load this program from the Menu Installer located on the CD. Follow the onscreen instructions to change the language of the messages on the front panel.

Additional Information

For help, click on **HELP** in the program.

Network Setup Utility ---

General Information

This utility provides an easy way to configure your printer on a network.

How to Install

Load this program from the Menu Installer located on the CD.

Additional Information

See the online Network User's Guide for details on how to use this utility. The Network User's Guide is found on the CD shipped with your printer.

Free Manuals Download Website

<http://myh66.com>

<http://usermanuals.us>

<http://www.somanuals.com>

<http://www.4manuals.cc>

<http://www.manual-lib.com>

<http://www.404manual.com>

<http://www.luxmanual.com>

<http://aubethermostatmanual.com>

Golf course search by state

<http://golfingnear.com>

Email search by domain

<http://emailbydomain.com>

Auto manuals search

<http://auto.somanuals.com>

TV manuals search

<http://tv.somanuals.com>