

[®]OKIDATA

OKIPAGE[®] 10i



Every effort has been made to ensure that the information in this document is complete, accurate, and up-to-date. OKIDATA assumes no responsibility for the results of errors beyond its control. OKIDATA also cannot guarantee that changes in software and equipment made by other manufacturers and referred to in this guide will not affect the applicability of the information in it. Mention of software products manufactured by other companies does not necessarily constitute endorsement by OKIDATA.

Copyright 1998 by OKIDATA. All rights reserved.

Second edition March, 1998.

Written and produced by the OKIDATA Publications Services Dept.

Please address any comments to:

Publications Services Department
OKIDATA
532 Fellowship Road
Mount Laurel, New Jersey 08054

<http://www.okidata.com>

OKIDATA is a registered trademark of Oki Electric Industry Company, Ltd.; Marque déposée de Oki Electric Industry Company, Ltd.; Marca Registrada, Oki Electric Industry Company, Ltd.

OKIPAGE is a trademark of OKI America, Inc.

Energy Star is a trademark of the United States Environmental Protection Agency.

TrueType is a registered trademark of Apple Computer Company.

Hewlett-Packard, HP, and LaserJet are registered trademarks of Hewlett-Packard Company.

IBM is a registered trademark of International Business Machines Corp.

Microsoft and MS-DOS are registered trademarks and Windows is a registered trademark of Microsoft Corporation in the U. S. and other countries.

Intellifont is a registered trademark of Compugraphic Corporation.

Adobe, PostScript are trademarks of Adobe Systems Inc. which may be registered in certain jurisdictions.

Epson is a registered trademark of Seiko Epson Corp.

All products currently sold by Okidata are Year 2000 Compliant. Each product contains information technology that accurately processes date and time data between the years 1999 and 2000. These products, when used in combination with products purchased from other manufacturers, whose products properly exchange date and time information, will accurately process the date and time. All future products are committed to meeting the same Year 2000 compliance.



As an Energy Star Partner,
Okidata has determined that this
product meets the Energy Star
guidelines for energy efficiency.

Safety Instructions

Your OKIDATA printer has been carefully designed to give you years of safe, reliable performance. As with all electrical equipment, however, there are a few basic precautions you should take to avoid hurting yourself or damaging the printer:

- Read the setup instructions in this handbook carefully. Be sure to save it for future reference.
- Read and follow all warning and instruction labels on the printer itself.
- Unplug the printer before you clean it. Use only a damp cloth; do not use liquid or aerosol cleaners.
- Place your printer on a firm, solid surface. If you put it on something unsteady, it may fall and be damaged; if you place it on a soft surface, such as a rug, sofa, or bed, the vents may be blocked, causing the printer to overheat.
- To protect your printer from overheating, make sure all openings on the printer are not blocked. Don't put the printer on or near a heat source, such as a radiator or heat register. Keep it out of direct sunlight. Allow enough room around the printer for adequate ventilation and easy access to the paper trays.
- Do not use your printer near water, or spill liquid of any kind into it.
- Be certain that your power source matches the rating listed on the back of the printer. If you're not sure, check with your dealer or with your local power company.
- Your printer has a grounded, 3-prong plug as a safety feature, and it will only fit into a grounded outlet. If you can't plug it in, chances are you have an older, non-grounded outlet; contact an electrician to have the outlet replaced. Do not use an adapter to defeat the grounding.
- The printer must be installed near a power outlet which remains easily accessible.

- To avoid damaging the power cord, don't put anything on it or place it where it will be walked on. If the cord becomes damaged or frayed, replace it immediately.
- If you are using an extension cord or power strip with the printer, make sure that the total of the amperes required by all the equipment on the extension is less than the extension's rating. The total ratings of all equipment plugged into the outlet should not exceed 15 amperes.
- Do not poke anything into the ventilation slots on the printer; you could get a shock or cause a fire.
- Aside from the routine maintenance described in this handbook, don't try to service the printer yourself; opening the cover may expose you to shocks or other hazards.
- Do not make any adjustments other than those outlined in the handbook: you may cause damage requiring extensive repair work. See Section 5 for information on how to get your printer serviced by qualified OKIDATA technicians.

If anything happens that indicates that your printer is not working properly or has been damaged, unplug it immediately and follow the procedures in Section 5 for having your printer serviced.

These are some of the things to look for:

- The power cord or plug is frayed or damaged.
- Liquid has been spilled into the printer, or it has been exposed to water.
- The printer has been dropped, or the cabinet is damaged.
- The printer doesn't function normally when you're following the operating instructions.

Federal Communications Commission
Radio Frequency Interference Statement for
120-Volt Models

WARNING: This equipment has been tested and found to comply with the limits for a Class B digital device, pursuant to Part 15 of the FCC Rules. These limits are designed to provide reasonable protection against harmful interference in a residential installation. This equipment generates, uses and can radiate radio frequency energy and, if not installed and used in accordance with the instructions, may cause harmful interference to radio communications. However, there is no guarantee that interference will not occur in a particular installation. If this equipment does cause harmful interference to radio or television reception, which can be determined by turning the equipment off and on, the user is encouraged to try to correct the interference by one or more of the following measures:

- Reorient or relocate the receiving antenna.
- Increase the separation between the equipment and receiver.
- Connect the equipment into an outlet on a circuit different from that to which the receiver is connected.
- Consult the dealer or an experienced radio/TV technician for help.

It is the responsibility of the user to obtain the required shielded cable in order to ensure compliance of this equipment with FCC regulations.

Changes or modifications not expressly approved by Okidata may void your authority to operate this device.

Industry Canada
Radio Interference Statement for 120-Volt Models

This apparatus complies with the Class “B” limits for radio interference as specified in the Industry Canada Radio Interference Regulations.

Cet appareil est conforme aux critères établis pour la Classe “B” en ce qui concerne les interférences radio, tel que spécifié par Industry Canada dans les Règlements relatifs aux Interférences Radio.

Federal Communications Commission
Radio Frequency Interference Statement for 230/240-Volt Models

WARNING: This equipment has been tested and found to comply with the limits for a Class A digital device, pursuant to Part 15 of the FCC Rules. These limits are designed to provide reasonable protection against harmful interference when the equipment is operated in a commercial environment. This equipment generates, uses and can radiate radio frequency energy and, if not installed and used in accordance with the instructions, may cause harmful interference to radio communications. Operation of this equipment in a residential area is likely to cause harmful interference in which case the user will be required to correct the interference at his own expense.

It is the responsibility of the user to obtain the required shielded cable in order to ensure compliance of this equipment with FCC regulations.

Changes or modifications not expressly approved by Okidata may void your authority to operate this device.

Industry Canada Radio Interference Statement for
230/240-Volt Models

This apparatus complies with the Class “A” limits for radio interference as specified in the Industry Canada Radio Interference Regulations.

Cet appareil est conforme aux critères établis pour la Classe “A” en ce qui concerne les interférences radio, tel que spécifié par Industry Canada dans les Règlements relatifs aux Interférences Radio.

**European Union Council of the European Communities
Statement of Electromagnetic Conformance for 230/240-Volt Models**

This product complies with the requirements of the Council Directive 89/336/EEC on the approximation of the laws of the member states relating to electromagnetic compatibility.

This product is in conformity with Directive 73/23/EEC on the harmonization of the laws of Member States relating to electrical equipment designed for use within certain voltage limits.

Ce matériel est conforme aux dispositions de la Directive du Conseil 89/336/CEE applicables à l'approximation de la législation des Etats membres en ce qui concerne la compatibilité des équipements électromagnétiques.

Ce produit est conforme à la Directive 72/23/EEC sur l'harmonisation des lois des états membres relativement au matériel électrique devant être utilisé dans des limites de tension spécifiques.

Este producto cumple con los requisitos de la Directiva del Consejo 89/336/CEE sobre la aproximación de la legislación de los Estados Miembros por cuanto respecta a la compatibilidad electromagnética.

Este producto cumple con la Directiva 73/23/EEC sobre armonización de las leyes de los Estados Miembros referente a equipo eléctrico a ser usado dentro de ciertos límites de voltaje.

Este produto obedece aos requisitos da Directiva do Conselho 89/336/CEE sobre a aproximação das leis dos estados membros relativamente à compatibilidade electromagnética.

Este produto está de acordo com a Diretriz 73/23/EEC sobre a harmonização das leis dos Estados Membros relacionadas a equipamentos elétricos projetados para o uso dentro de determinados limites de tensão.

Warranty Enhancement Programs

⇒ Available in the U.S. and Canada only

OKI Extend™



This program offers you the opportunity to purchase an extension of the standard warranty for your Okidata printer. You can add 1 or 2 years to the standard warranty period.

OKI On-Site™



If you experience a malfunction of your Okidata printer and the problem cannot be resolved over the phone, this program offers you repair of your printer right at your place of business, by our national service provider.

For more information...

For pricing and more detailed information on these programs:

- call 1-800-OKIDATA (1-800-654-3282)
- or
- visit our Web site: <http://www.okidata.com>

Table of Contents

Features

Consumables	1
Options	1

Section 1-Setting Up Your Printer

Select a Location for Your Printer	2
Visit the OKIDATA Web Site	2
Check the Contents	2
Remove the Image Drum Protective Paper	3
Remove Operator Panel Protective Film	3
Installing Toner	4
Loading Paper	5
Using Legal Size Paper	5
Paper Exit Options	6
Top Paper Exit	6
Rear Paper Exit	6
Choosing Paper	6
Interfacing with your Computer	7
Connecting the Cable	7
Attaching the Power Cord	7
Changing the Display Language	8
Printing a Demo Page	8
Printing a Font Page	8
Printer Software	9

Section 2-Operating Your Printer

Using the Front Operator Panel	10
Ready Light	10
LCD Display Window	10
Paper Size Indicator	10
Button Functions	11
Using the Printer Menu	12
Level-1 Menu	12
Level-2 Menu	12

Resetting the Menu	12
Sub Menus	12
Printing the Menu	12
Level-1 Menu Selections	13
Level-2 Menu Selections	21
Maintenance Menu	25
Using Special Print Media	26
Printing a Special Document	26
Enhancing Print Quality	26
Printing Envelopes	27
Selecting Envelopes	27
Printing Transparencies and Adhesive Labels	28
Guidelines for Transparencies and Labels	28
Using Recycled Print Media	28

Section 3-Printer Maintenance

Replacing The Toner Cartridge	29
Toner Cartridge Life	29
Replacing the Image Drum Cartridge	30
Image Drum Cartridge Life	30
Cleaning the LED Array	30
Printing a Cleaning Page	31

Section 4-Problem Solving

Clearing Paper Jams	32
Input Jam	32
Feed Jam	32
Exit Jam (top bin)	32
Exit Jam (rear tray)	33
Printer Messages	34
System Status	34
Maintenance Menu Mode	35
Cleaning/Maintenance	35

Paper Errors	36
Manual Paper Feed Request	36
Controller Errors	37
Interface Errors	37
Print Quality Problems	37
Software Problems	39
Hardware Problems	41

Section 5-Service and Support

OKIDATA ONLINE	42
Your Dealer	42
The Okidata Customer Support Center	42
Okidata Customer Service Representatives	42
Faxable Facts	43
Purchasing Supplies	43
Ways to Purchase	43
Warranty Service	43
Okidata Service Centers	43
OKIDATA SERVICE CENTER LOCATIONS	44
WARRANTY	45
OVERNIGHT EXCHANGE	46
INDEX	47
Material Safety Data Sheet	49

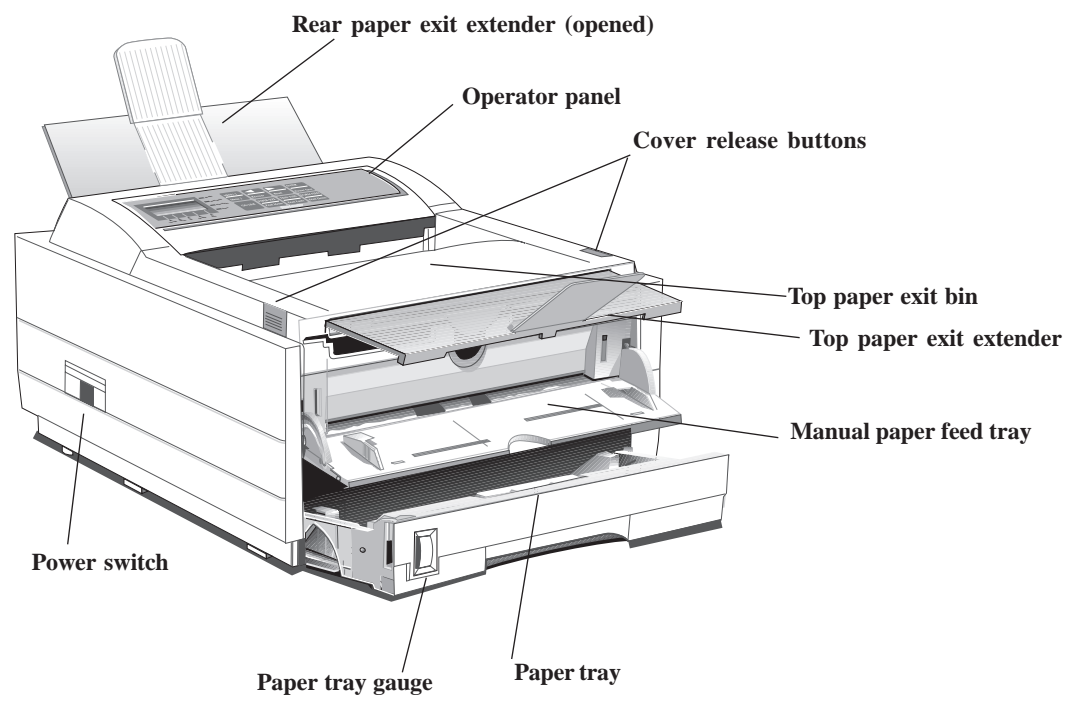
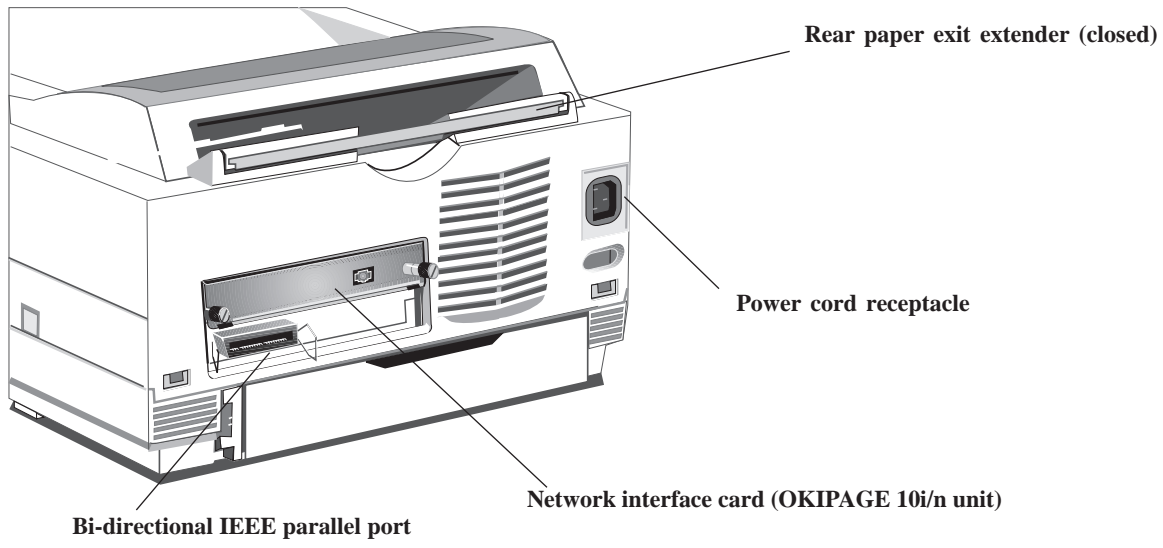

Features

- Fast print speed - 10ppm with a 28 MHz RISC micro processor
- Excellent print quality - True 600 dpi and 600 x1200 graphics
- Large paper capacity - 250 sheet paper tray and manual sheet/envelope feeder plus options for increasing paper capacity up to 850 sheets
- Memory - 2MB installed, expandable to 35MB
- Fonts - 35 PCL® fonts (Agfa), 10 True Type fonts, USPS Barcode font, OCR-A/B supported, and 37 Adobe™ Type-1 fonts with the PostScript™ option
- Emulations - Standard HP® LaserJet 5 (PCL6), IBM® ProprinterIII/Epson® FX (9-pin emulation), plus optional PostScript Level 2
- Printer drivers - Windows® NT 3.51/4.0, Windows 95, Windows 3.x
- Networkable - With optional adapter for shared network environments
- Interface - IEEE 1284 bi-directional parallel interface
- On-screen status monitor and interactive software operator panel
- Energy Savings - Power is reduced when not printing
- 1 year overnight exchange warranty, 5 year warranty on the LED printhead (overnight exchange available in the US and Canada)

Consumables

Toner - 2,000 pages @ 5% print density (Type 5 Toner Cartridge Kit, Part# 52109001)

Drum - 20,000 pages with continuous printing (Type 5 Image Drum Cartridge Kit, Part# 40433305)

Options

- 500 sheet 2nd Paper Tray/Mechanism (Part# 70028701)
- 100 sheet/50 envelope Multi-purpose Feeder (Part# 70025101)
- 1 MB Memory Expansion Board with 2 expansion (SIMM) sockets (Part# 70033101)
- RS-232 Serial Interface Board with 2 expansion (SIMM) sockets (Part# 00025302)
- Ethernet Network Adapter Card with 2 expansion (SIMM) sockets (Part# 70032901)

To install the following options, a Memory Expansion Board, RS-232 Serial Interface Board, or Network Adapter Card must be purchased.

- Flash Memory SIMM 4MB (Part# 70032601)
- Flash Memory SIMM 8MB (Part# 70033201)
- Adobe PostScript Level 2 SIMM Kit with 4MB Memory SIMM (Part# 70033001)
- 4MB Memory SIMM Chip (Part# 70028801)

Section 1 ➔ Setting Up Your Printer

Select a Location for Your Printer

- A firm surface such as a table or desktop
- Space to open the cover and pull out the paper tray and the rear output extender
- Air circulation around the printer to prevent overheating (minimum of 4 inches)
- A nearby power source
- Room temperature of 50° to 90°F (10° to 32°C).
- Relative Humidity of 20- 80%
- No direct sunlight

Visit the OKIDATA Web Site

<http://www.okidata.com>

for the latest information on:

- Product Guides
- Customer Support
- Software Drivers
- Corporate Information
- Online Dealers
- Documentation

Check the Contents

Unpack your printer. The shipping box should contain:

1. OKIPAGE 10i Printer (with image drum cartridge installed)
2. CD-ROM (includes printer drivers and software)
3. Printer software diskette (to install printer software without CD-ROM)
4. Toner Cartridge
5. Black plastic light-shield bag (to store image drum if you need to ship the printer)
6. Power Cord
7. Okipage 10i User's Guide
8. Okipage 10i Printer Software Installation Guide
9. Warranty Registration Card

⇒ *The OKIPAGE 10i/n unit is configured with a network interface card.*

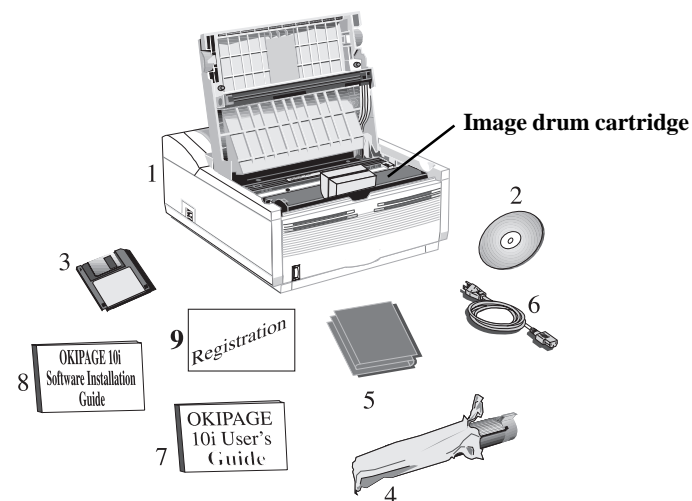

1 Setting Up Your Printer

Remove the Image Drum Protective Paper

1. Press the cover release buttons and lift the cover.

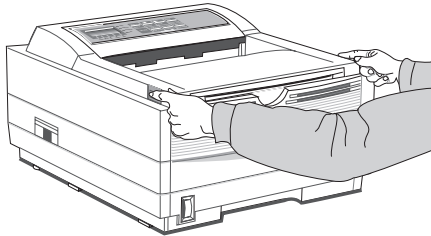

2. Lift out the image drum cartridge. **Do not touch the drum's green surface.**

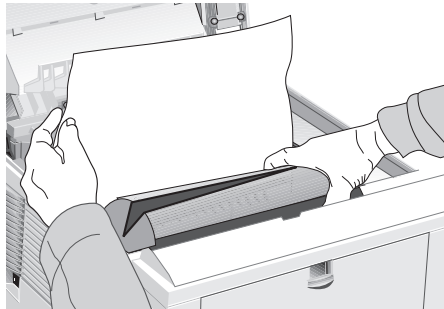

⇒ *Only the Okipage 10i Type 5 Series Image Drum will fit in this unit (Part# 40433305)*

3. Remove the protective paper from the image drum.

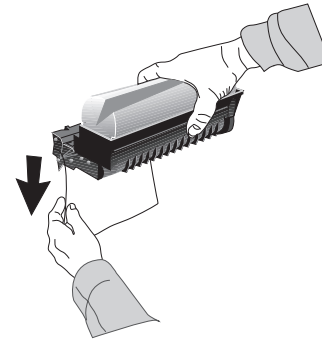

4. Reinstall the image drum cartridge into the printer.

Remove Operator Panel Protective Film

Lift up the corner and peel the protective plastic film from the control panel.

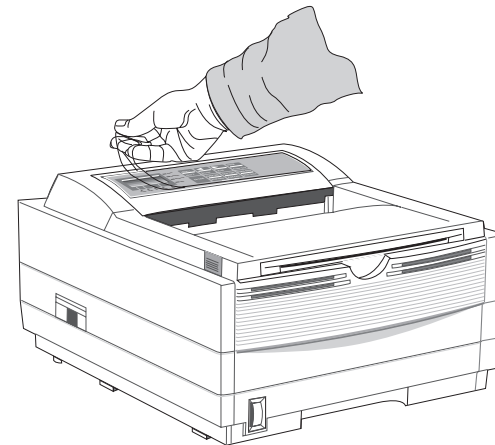

Setting Up Your Printer 1

Installing Toner

1. Remove the sponge.

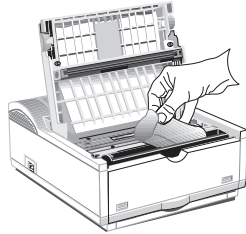

2. Unwrap the toner cartridge. Shake the cartridge from side to side to distribute the toner.

⇒ *Only the OKIPAGE 10i Type 5 Series Toner Cartridge will fit in this unit (Part# 52109001)*

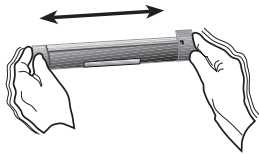

3. Peel tape off the bottom.

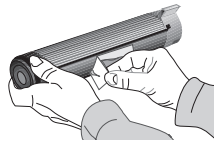

4. Grasp the lock lever and place the left side of the toner cartridge into the toner well, under the tab.

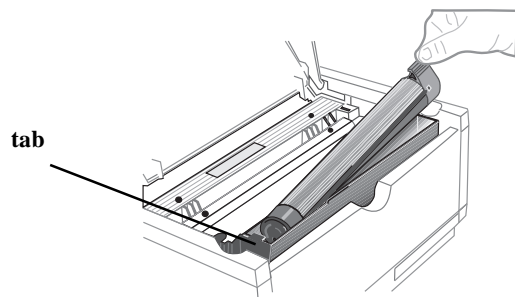

5. Lower the right side, aligning the lock lever slot with the ridge in the drum cartridge.

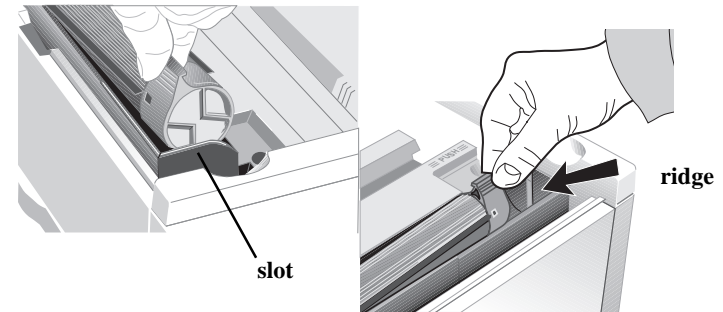

6. When the cartridge is in place, push the lock lever forward until it stops.

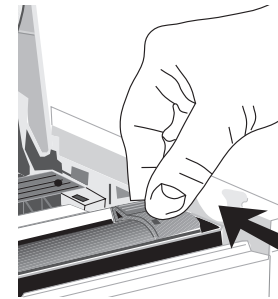

7. Lower the printer cover and press firmly to close.

1 Setting Up Your Printer

Loading Paper

1. Slide the tray out of the printer.

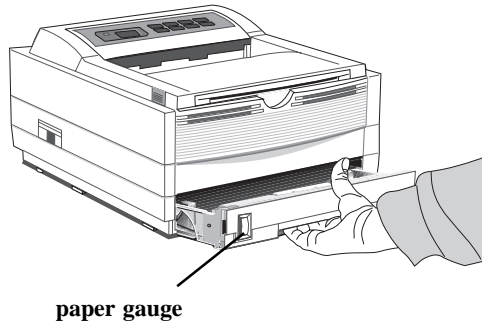

⇒ The paper gauge indicates how much paper remains in the tray.

2. Adjust the paper guides for the paper size you are using.

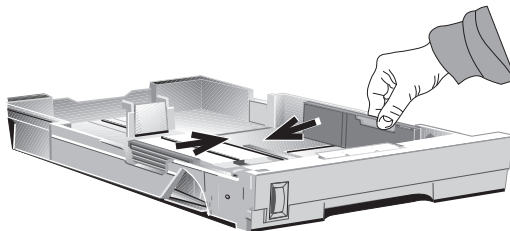
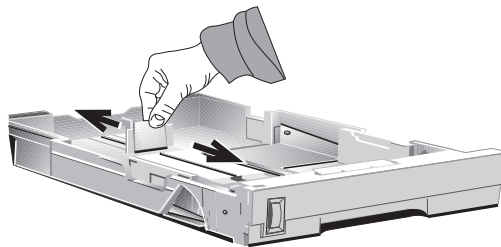

3. Fan a stack of paper (Maximum 250 sheets, 20 lb.) and place it in the tray under the tabs. Do not fill above the “PAPER FULL” mark. To use letterhead, place paper print side down, top-edge facing you.

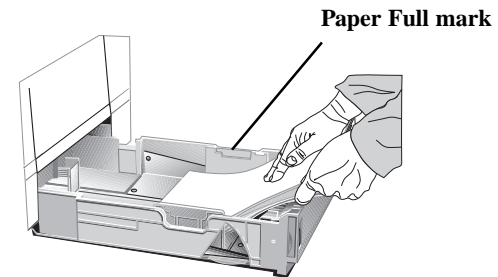

⇒ Recommended paper weight for the tray is 16 to 28 lb (60 to 105 g/m²).

4. Place the tray back into the printer until it locks.

Using Legal Size Paper

To load legal size paper, open out the tray extender and adjust the rear paper guide.

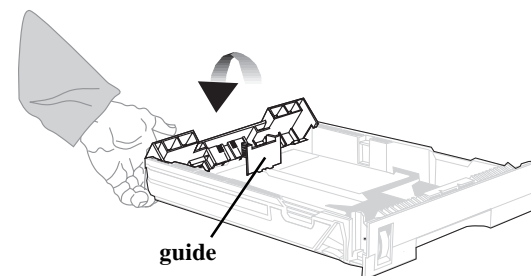

Setting Up Your Printer 1

Paper Exit Options

Two paper exit options are available. Select the paper path that is appropriate for the media you are using.

Top Paper Exit

Use top paper exit for most printing jobs.

- Printed pages exit face down
- Pages are stacked in the order printed
- Exit bin holds 150 sheets of 20-lb. paper

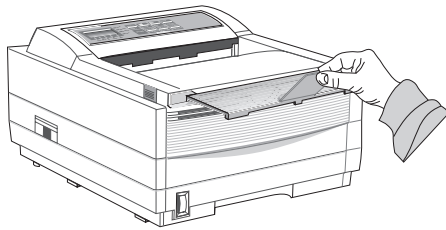

1. Pull the front tray extender forward.
2. Lift out the support bar.

⇒ *Don't change paper paths while printing, paper jam may occur.*

Rear Paper Exit

The rear paper exit tray provides a straighter paper path. Use rear exit when printing on heavy paper, envelopes, labels, and transparencies.

- Printed pages feed face up into the rear tray
- Pages are stacked in reverse order
- Tray holds a maximum of 50 sheets of 20 lb. paper
- Use rear exit for printing on heavy paper, envelopes, labels, transparencies or odd size paper

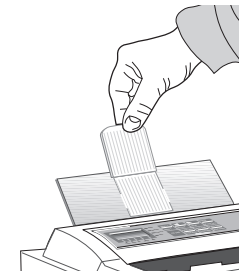

1. Pull out the rear exit tray until it locks in place.
2. Lift out the support bar.

To return to top exit, close the support bar and push the rear exit extender firmly back in place, paper will then exit into the top bin.

⇒ *See Section 2 for information on using special print media.*

Choosing Paper

- For best results, use paper that is smooth and of high quality.
- Store paper in its ream wrapper until you are ready to use it, and keep it away from moisture or conditions that can cause it to wrinkle or curl.
- Avoid printing on both sides of the paper for more than a few pages, or preprinted documents that have been in a photocopier.
- Try paper before you buy it in quantity.

⇒ *See Section 2 for information on using recycled print media.*

1 Setting Up Your Printer

Interfacing with your Computer

Your printer has a high-speed, bi-directional parallel IEEE 1284 interface port. Purchase a cable marked IEEE 1284 compliant. **To comply with FCC regulations, the cable must be shielded and UL and CSA approved.** Consult your PC manual for details on cable requirements and interface ports on your computer.

- ⇒ OKIDATA has tested and approved the following bi-directional cable: Part# 70000803. See Section 5 for purchasing information.
- ⇒ An optional RS-232 Serial I/O Card is available: Part# 00025302. See Section 5 for purchasing information.

Connecting the Cable

Make sure the printer and computer are off.

1. Insert the printer end of the cable firmly into the connector on the back of the printer). Fasten the cable to the printer securely.

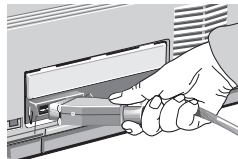

2. Connect the other end of the cable to the proper connector on your computer. Fasten the cable securely to your computer.

Attaching the Power Cord

1. Make sure the printer power switch (on left side) is set off.



2. Plug the power cord into the printer first, then into a grounded outlet.



3. Turn the printer on. It takes about 10 seconds for the printer to initialize, warm up, and display the **ON-LINE** message, indicating the printer is ready to receive data.

Setting Up Your Printer 1

Changing the Display Language

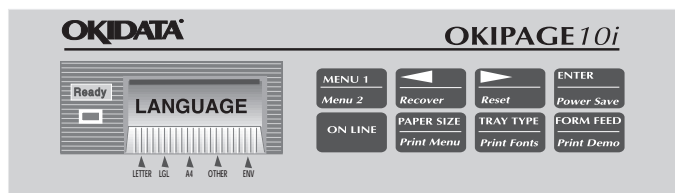

To change the language on the panel display and menu printout:

1. Press ON-LINE until the READY light goes out.
2. Press and hold MENU1/Menu2 until **PRINT MODE** displays.
3. Press MENU1/Menu2 10 times until the display reads **LANGUAGE**.
4. Press ENTER/Power Save . The display now reads **LANGUAGE ENGLISH***.
5. Press ►/Reset until the language you want appears. Press ENTER/Power Save.
6. Press ON-LINE.

Printing a Demo Page

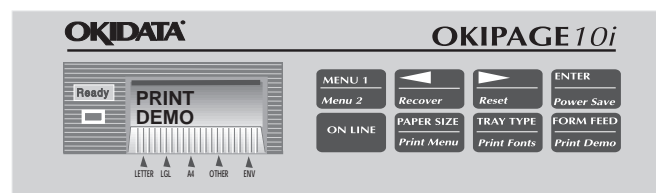

To print a page showing printer features and capabilities, do the following:

1. Press ON-LINE until the READY light goes out and the printer is OFF-LINE.
2. Press FORM FEED/Print Demo and hold until **DEMO** appears.
3. Press ENTER. The demo page will print.

Printing a Font Page

To print a page showing the printers available fonts, do the following:

1. Press ON-LINE until the READY light goes out and printer is OFF-LINE.
2. Press TRAY TYPE/Print Fonts and hold until **FONTS** appears.
3. Press ENTER. The font page will print.
4. To print the font page for a different emulation, before pressing ENTER, press ► until that emulation displays.

Printer Software

See the “Software Installation Guide” for instructions to install printer drivers and software. The printer drivers must be installed to access all printer features.

Section 2 ➔ Operating Your Printer

This section provides the following information:

- Using the front operator panel
- Setting printer features using the printer menu
- Using the printer software
- Using manual feed
- Printing envelopes
- Printing transparencies and labels
- Using recycled print media

Using the Front Operator Panel

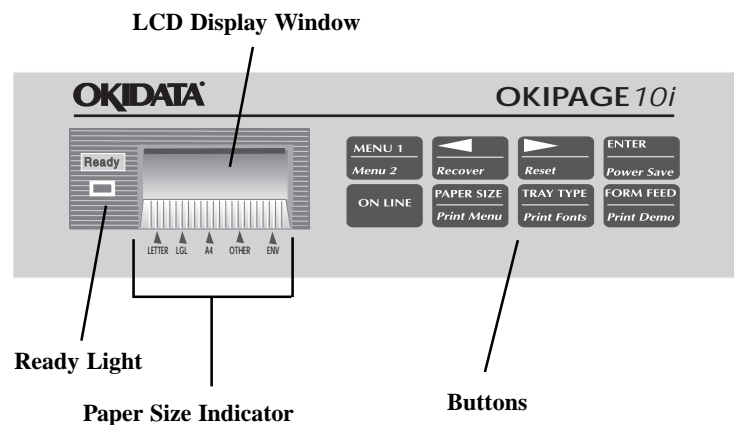

Ready Light

- On** Printer is online, ready to receive data; button functions inactive (except ON-LINE).
- Off** Printer is off-line, cannot receive data; button functions active.
- Blinking** Printer is receiving data.

LCD Display Window

Indicates:

- What the printer is doing during normal operation.
- When you need to add paper or change consumables.
- When there's something wrong with the printer.
- Printer feature selections in Menu mode

➔ See "Problem Solving" for a description of display messages.

Paper Size Indicator

The paper size in the tray is indicated by using the dot at the very bottom of the LCD display. Paper size options are shown immediately below the LCD display.

Button Functions

BUTTON	OPERATION	FUNCTION
ON LINE	Quick press	Switches between ON-LINE and OFF-LINE mode.
	In Menu	Exits Menu mode.
FORM FEED	Quick press	In ON-LINE mode, one sheet is ejected. In OFF-LINE mode, unprinted data is printed.
<i>Print Demo</i>	<i>2 second press</i>	<i>In OFF-LINE mode, demo page print.</i>
TRAY TYPE	Quick press	In OFF-LINE mode, enters Tray Select Sub Menu.
<i>Print Fonts</i>	<i>2 second press</i>	<i>In OFF-LINE mode, prints font page.</i>
PAPER SIZE	Quick press	In OFF-LINE mode, enters Paper Size Sub Menu.
<i>Print Menu</i>	<i>2 second press</i>	<i>In OFF-LINE mode, prints Menu settings.</i>
MENU 1	Quick press	In OFF-LINE mode, enters Level-1 Menu.
	In Menu mode	Moves to next Menu category. Reverts to previous Menu category when pressed for 8 seconds or more.
	At power on	Enters User Maintenance mode.
<i>Menu 2</i>	<i>2 second press</i>	<i>In OFF-LINE mode, enters Level-2 Menu.</i>
ENTER	In Menu mode	Set the displayed selection as default setting.
<i>Power Save</i>	<i>2 second press</i>	<i>In OFF-LINE mode, enters the Power Save Sub Menu.</i>
	In Menu mode	Returns to previous Menu item.
<i>Recover</i>	<i>2 second press</i>	<i>Clears certain receive data errors and returns printer on-line.</i>
	In Menu mode	Advances to next Menu item.
<i>Reset</i>	<i>2 second press</i>	<i>Clears all data and executes internal reset.</i>

Operating Your Printer 2

Using the Printer Menu

The Menu provides a way to select printer operations and features using the printer's front operator panel.

The Menu is divided into Level 1 and Level 2.

Level-1 Menu

- Enter this mode using a quick press of the Menu 1/*Menu 2* button with the printer off-line.
- Items frequently changed are included.

Level-2 Menu

- Enter this mode by pressing the Menu 1/*Menu 2* button for 2 seconds with the printer off-line.
- Items rarely changed are included.

Each level has a hierarchical structure of categories and items, and options. Selections display in the LCD window.

1. Press the ON LINE button to enter off-line mode.
2. Enter the Menu mode by pressing the MENU 1/*Menu 2* button.
3. Continue pressing MENU 1/*Menu 2* to display the next category.
4. Press MENU 1 again to see more items in a category.
5. To select an item, press ENTER. Items are displayed on the top line. The bottom line indicates available options within each item. An asterisk (*) indicates the current selection.
6. Press ►/*Recover* to see more selections.
7. Press ENTER to choose a selection.
8. Press ON-LINE to exit the menu.

⇒ *Operations and features set in your application software, will override Menu settings.*

⇒ *Most printer menu options can also be set using the soft operator panel on-screen. See the Software Installation Guide.*

Resetting the Menu

The menu can be reset to the factory (default) settings in the Maintenance Menu (See Maintenance Menu for information on using this feature).

Sub Menus

Sub Menus are accessed by pressing a specific button on the front operator panel. This feature allows quick access to three often used features:

- Power Save
- Paper Size
- Tray Type

The operation is the same as the regular menu, but only the category indicated on the button is activated.

Printing the Menu

For a printout of all menu settings including default (factory) and user settings, firmware revisions, and total RAM capacity:

1. Press ON-LINE to select off-line mode.
2. Press PAPER SIZE/*Print Menu for 2 seconds*. MENU and the current emulation setting displays.
3. Press ENTER to print the menu.
4. To print the menu for a different emulation, before pressing ENTER, press ► until that emulation displays.

Category	Items	Options
PERSONALITY	EMULATION	AUTO EMULATON*, HP PCL6, IBM PPR, EPSON FX, ADOBE PS (OPTION)
	Notes: **Auto Emulation switches emulations automatically. Adobe PostScript emulation appears only when option is installed.	
TRAY SELECT	MANUAL	OFF* ON
	Notes: When set ON, paper will feed from the front feeder.	
	PAPER IN	TRAY 1* TRAY 2 (OPTION) FEEDER MULTI FEEDER (OPTION)
	Notes: Select paper source. Tray 2 and Multi Feeder appear if installed.	
EDIT SIZE	AUTO TRAY SWITCH	OFF* ON
	NOTES: ON=WHEN PAPER TRAY 1 IS EMPTY, PRINTER AUTOMATICALLY SWITCHES TO TRAY WITH SAME SIZE PAPER INSTALLED. (ONLY WHEN 2ND TRAY OR FEEDER IS INSTALLED).	
EDIT SIZE	EDIT SIZE	CASSETTE SIZE* LETTER EXECUTIVE LEGAL 14 LEGAL 13 A4 SIZE

***Default Setting**

Category	Items	Options
	A5 SIZE A6 SIZE B5 SIZE COM-9 COM-10 MONARCH DL ENVELOPE C5 ENVELOPE C4 ENVELOPE	
	<p>Notes: CASSETTE SIZE=Paper size in the tray is automatically identified by paper sensors. This setting eliminates having to manually select paper size. Other sizes=setting must match paper size in tray or PAPER SIZE ERROR displays unless PAPER SIZE CHECK is set to Disable.</p>	
PAPER SIZE	TRAY1 TRAY 2 (Option)	LETTER* EXECUTIVE LEGAL 14 LEGAL 13 A4 SIZE A5 SIZE A6 SIZE B5 SIZE
	<p>Notes: Select paper size.</p> MANUAL	LETTER* EXECUTIVE LEGAL 14 LEGAL 13 A4 SIZE A5 SIZE A6 SIZE B5 SIZE COM-9 COM-10 MONARCH

*Default Setting

Category	Items	Options
		DL ENV C5 ENV
	<p>Notes: Select paper size installed in Front Feeder (manual feed). If paper size installed does not match setting, printer will display message requesting the size set in menu.</p>	
	MULTI FEEDER ENVELOPE (option)	
MEDIA TYPE	TRAY 1	MEDIUM HEAVY HEAVY LIGHT MEDIUM* MEDIUM LIGHT
	<p>Notes: Paper thickness setting.</p> <p>Medium Light=18-lb paper Medium Heavy=24-lb paper Heavy= 28-lb paper Light=16-lb paper Medium=20-lb paper</p>	
	MANUAL	MEDIUM LIGHT MEDIUM HEAVY HEAVY LIGHT MEDIUM* TRANSPARENCY
	TRAY 2 (Option)	
	MULTI FEEDER ENVELOPE (Option)	
PAPER SIZE CHECK	PAPER SIZE CHECK	ENABLE* DISABLE
	<p>Notes: ENABLE=printer only accepts paper size selected in software which matches size loaded in drawer. DISABLE=printer accepts any paper size selected in software.</p>	
*Default Setting		

Category	Items	Options
COPIES	COPIES	1* TO 999
	Notes: Select number of copies to print for each document.	

THE FOLLOWING CATEGORIES ARE DEPENDENT ON EMULATION

FONTS & SYMBOLS

(LJ5)FONT SRC

RESIDENT*, SIMM , DLLSOFT

Notes: Select location of default fonts. SIMM is indicated only when a ROM SIMM option is installed. DLLSOFT is indicated only when a soft font is downloaded at permanent setting.

(LJ5)FONT NO.

I000* TO I046

Notes: Select font by ID number (see font print sample); S=soft font.

(LJ5)FONT CPI

Notes: Appears if selected font is scalable/fixed spaced

10.00*, 0.44 TO 99.99

ADJUST IN .01 POINT INCREMENTS.

Notes: Select number of characters printed in a horizontal inch (pitch) when scalable font with fixed spacing is selected. (72 points= 1 inch). Character height (point size) adjusts accordingly.

(LJ5)FONT HGT

Notes: Appears if selected font is scalable/proportional spaced

***Default Setting**

Category	Items	Options
		<p>OPTIONS12.00*, 4.00 TO 999.75 ADJUST IN .25 POINT INCREMENTS.</p> <p>Notes: Select point size (height) of characters when scalable font with proportional spacing is selected. 72 points= 1 inch). Horizontal spacing adjusts accordingly.</p>
	(LJ5)SYMBOL	<p>ROMAN-8* 60 SETS ARE AVAILABLE.</p> <p>Notes: Select Symbol Set.</p>
PAGE LAYOUT1	(LJ5)A4 WIDTH	<p>78 COL*, 80 COL</p> <p>Notes: Use for A4 size paper to select 78 columns or condense 80 columns to fit characters on a line.</p>
	(LJ5)BLNKSKIP	<p>OFF*, ON</p> <p>Notes: ON= printer will ignore FF code when buffer is empty. (Sometimes software will print an extra blank page.)</p>
	CR FUNC	<p>CR*,CR+LF</p> <p>Notes: Sets operation when receiving CR code. CR+LF=add LF command to each CR command.</p>
	(LJ5)LF FUNC	<p>LF*, LF+CR</p> <p>Notes: Sets operation when receiving LF code. LF+CR=add CR command to each LF command.</p>
FONTS & SYMBOLS	(IBM, EPSON) PITCH	<p>10 CPI* 12 CPI 17 CPI</p>

***Default Setting**

Category	Items	Options
		20 CPI PROP
	Notes: Select font and character pitch.	
	(IBM)CONDENSE	12 TO 20 12 TO 12
	Notes: Pitch with 12 cpi only (IBM only)	
	(IBM, EPSON)CHAR SET	SET- 2* SET-1
	Notes: Selects character set.	
	(IBM, EPSON)SYMBOL	IBM-473*
	Notes: Selects code page.	
	(IBM, EPSON)LETTER 0	DISABLE* ENABLE
	Notes: Select the style of letter 0.	
	(IBM, EPSON)ZERO CHR	NORMAL* SLASHED
	Select the style of 0 (zero).	
<hr/>		
PAGE LAYOUT 1	(IBM, EPSON)LN PITCH	6 LPI* 8 LPI
	(IBM, EPSON)BLNKSKIP	OFF* ON
	Notes: Set OFF, a blank page will not eject.	

***Default Setting**

Category	Items	Options
	(IBM, EPSON)CR FUNCTION	CR* CR+LF
	Notes: Select function when CR code is received.	
	(IBM)LF FUNC	LF* LF+CR
	Notes: Select function when LF code is received.	
	(IBM, EPSON)LINLENG	80 COL* 136 COL
	Notes: Select number of characters per line.	
	(IBM, EPSON)FORMLENG	LETTER* A4 12 INCH
	Notes: Select page length.	
	(IBM, EPSON)TOF POS	0 INCH* 0.1 INCH 0.5 INCH 1 INCH
	Notes: Select print start position from the top of the page.	
	(IBM, EPSON)L.MRGN	0 INCH 0.1 INCH 1 INCH
	Notes: Moves horizontal print start position to the right.	

***Default Setting**

Category	Items	Options
THE FOLLOWING CATEGORIES ARE COMMON TO ALL EMULATIONS		
PAGE LAYOUT 2	ORIENT	PORTRAIT* LANDSCP
	Notes: Select vertical/horizontal printing.	
	LINES/PG	5 LNS 60 LNS* 64 LNS 128 LNS
	Notes: Sets number of lines printed on a page. Minimum is 5, maximum is 128.	
HOST I/F	PARALLEL	ENABLE* DISABLE
	RS-232C	ENABLE* DISABLE
	NETWORK	ENABLE* DISABLE
Notes: If set to enable, performs automatic interface switch with RS-232 if this option is installed.		

***Default Setting**

Category	Items	Options
PRINT MODE	MODE	600 DPI* , 300 DPI V1200 DPI
	Notes: Select resolution (dots per inch).	
MEMORY USAGE	RST BUF	AUTO* , 180KB, 360KB, 720KB, 1.08MB, 1.44MB
	Notes: Reserves area in memory for page size; reduces print overuns.	
	FONT PROT	AUTO, OFF*, 100 KB TO 1.1MB
Notes: Reserves a section of memory for downloading fonts; improves printing speed by saving previously created fonts. Will take memory away from total print buffer and REC BUFF.		
	FREE MEM	XXXXXXKB
Notes: Displays memory area available for downloading fonts. Reduce RSTBUF/RECBUFF to increase free area.		
AUTO OPERATION	AUTOCONT	OFF, ON*
	Notes: ON, software or data error will cause printer to display error message then continue to print; Set OFF, printer will stop printing; press RECOVER to continue.	
	WAITTIME	5 SEC TO 300 SEC 90 SEC* OFF

***Default Setting**

Category	Items	Options
		<p>Notes: Select time print job will be flushed after last print command is received. Effective in PostScript only.</p> <p>MANTIME</p> <p>30 SEC* 60 SEC OFF</p> <p>Notes: Time printer will wait before flushing job when requesting manual paper input.</p>
PRPROTEK	GOOD, BETTER*, BEST	<p>Designates whether Frame Buffer compression is performed or not. Good:not performed. Better:judges data and performed. Best:performed without exceptions. Generally,the Better setting won't cause overrun. However, the Good setting in PCL6 is more efficient.</p>
DARKNESS CONTROL	DARKNESS	<p>0, +1*, +2, -2, -1</p> <p>Notes: Control print density. Negative values lighten, positive values darken.</p>
POWER SAVING	PWR SAVE	<p>0 SEC, 8 MIN*, DISABLE</p> <p>Notes: 0 SEC=Reduces power consumption at end of receive time. 8 MIN=Reduces power consumption 8 minutes after printer stops receiving data, fuser heating element shuts off; 30 seconds later fan shuts off. When printer receives data, fuser warms up before printing begins. DISABLE=Fuser and fan are always on, printer is ready to print at all times.</p>
LOW TONER	LOW TNR	<p>ON*, OFF</p> <p>Notes: ON=When low toner is detected, TONER LOW displays, 100 more sheets print; TONER EMPTY displays, printing stops. OFF=When low toner is detected, TONER EMPTY displays, printing stops. Install new toner cartridge to resume printing.</p>
TONER SAVING	TNR SAVE	<p>DISABLE*, MEDIUM, LIGHT</p> <p>Notes: Use this feature to conserve toner and reduce printing costs when you are printing rough drafts or proof copies. Medium reduces toner by 30%, light reduces toner by 50%.</p>

***Default Setting**

Category	Items	Options
CLEARABLE WARNINGS	CLR WRNG	ON*, JOB
	Notes: Warning message appears when printer must reconfigure memory to select most efficient way to print a complex job. ON=Message displays, press RECOVER to clear. OFF=Message clears when next print job is received.	
ERROR REPORT	ERR REPT	OFF* ON
PARALLEL I/F	SPEED	HIGH*, MEDIUM
	Notes: HIGH=Data transfer speed maximized. MEDIUM=Select if data transmission problems occur, or with earlier computers.	
	BI-DIRCT	ENABLE*, DISABLE
	Notes: ENABLE=Select bi-directional parallel communication.	
I-PRIME	I-PRIME	OFF*, ON
	Notes: ON=I-Prime signal resets printer. Set OFF, or if HOST I/F is set to AUTO IF, printer ignores signal.	
RS232C SERIAL	FLOW CTL	DTR HI*, DTR LO, XONXOFF, RBSTXON
	Notes: Select serial protocol.	
BAUDRATE	BAUDRATE	9600*, 19200, 300, 600, 1200, 2400, 4800
	Notes: Appears when RS232C Board is installed. Select transmission rate in bits per second (bps).	

***Default Setting**

Category	Items	Options
	DATABITS	8 BITS*, 7 BITS
	Notes: Appears when RS232C Board is installed. Select serial interface data bit format.	
	PARITY	NONE*, EVEN, ODD
	Notes: Appears when RS232C Board is installed. Select serial interface parity type.	
	MIN BUSY	200 MSEC*, 1 SEC
	Notes: Appears when RS232C Board is installed. Set length of busy signal when Ready/Busy (DTR) protocol is selected.	
<hr/>		
NETWORK	Notes: Indicates when Network option is installed.	
<hr/>		
LANGUAGE	ENGLISH* DEUTSCH FRANCIS ITALIAN CASTLAN SVENSKA NORSK DANSK NEDERL TURKCE PORTUG POLSKI	
	Notes: Select language displayed on the LCD operator panel. German, French, Italian, Spanish , Swedish, Norwegian, Danish, Dutch , Turkish, Portuguese, Polish	

***Default Setting**

Maintenance Menu

The Maintenance Menu includes printer maintenance and operating functions described below.

To enter Maintenance Menu mode:

1. Turn off the printer
2. Press and hold MENU1/*Menu2* and turn on the printer. USER MNT displays.
3. Press MENU1/*Menu2* again to advance to the next category.
4. Press ENTER to invoke a function; or
5. Press  to see other options, then press ENTER to select the option you want. Press ON-LINE to exit the menu.

Category	Options	Function
MENU RESET		Reset Menu (Level 1) to factory settings.
HEX DUMP		Print a hex dump of received data for diagnostics. to exit hex dump mode, turn off the printer.
DRUM CNT RESET		Reset the drum counter after replacing the image drum cartridge.
REC BUF	AUTO*, 8KB, 20KB, 100KB, 1MB	Reserves memory area for receive data; larger setting improves computer return time.
OP MENU	ENABLE* DISABLE	DISABLE=All control panel buttons except ON-LINE are disabled. ENABLE=All buttons are active.
X ADJUST	0mm to 2.00mm	Adjust horizontal print position in 0.25 mm increments. Plus (+) indicates right movement, minus (-) indicates left movement.
Y ADJUST	0mm to 2.00mm	Adjust horizontal print position in 0.25 mm increments. Plus (+) indicates downward movement, minus (-) indicates upward movement.

⇒ *Menu Reset, Drum Count Reset and X-Y Adjust functions can also be selected in the printer software.*

Operating Your Printer 2

Using Special Print Media

Use manual feed to print:

- Envelopes
- Labels
- Transparencies
- A special document not loaded in the paper tray, like a single letterhead page
- Paper heavier than 28 lbs.

Printing a Special Document

If you have plain paper loaded in the paper tray and you want to print one letterhead page or special document, do the following:

1. Set manual feed and paper size in your software.
2. Pull down the manual feed tray.

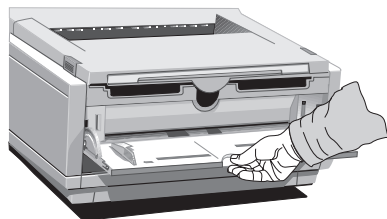
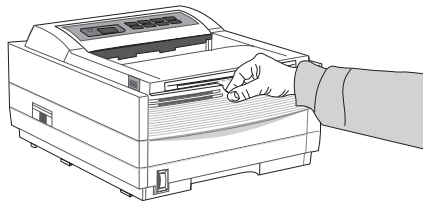

3. Adjust the paper guides.

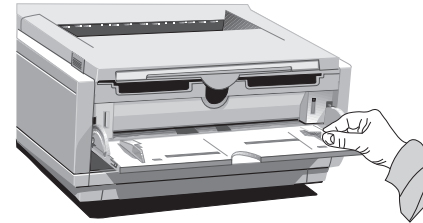

4. Insert the sheet (letterhead: top edge in first, facing up) until the printer grips it.

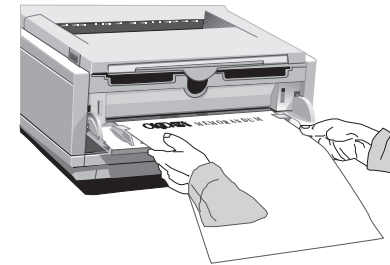

5. Issue the print command in your software.

Enhancing Print Quality

To enhance print quality when printing on different types of media, you can adjust the following settings in the printer Menus:

Level 1 Menu

Media Type - Adjust for paper thickness

Level 2 Menu

Print Mode - Select dots per inch

Darkness Control - Adjust print density

Toner Saving - Select proof copy quality to conserve toner

Printing Envelopes

1. Set envelope size and landscape orientation in your software.
2. Pull out the rear exit extender until it locks.

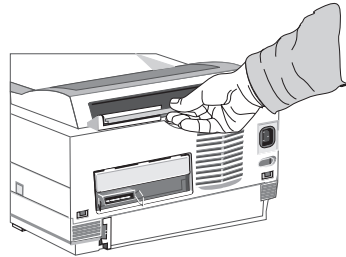

3. Lift out the support bar.



4. Pull the manual feed tray down.

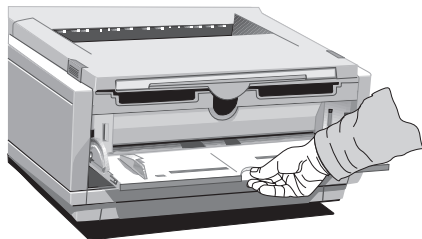

5. Adjust the paper guides.

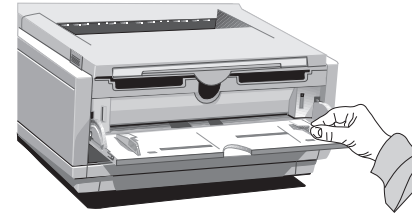

6. Insert the envelope –flap down and to the left– until the printer grips it.

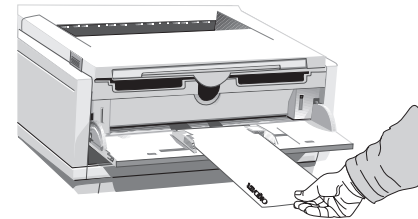

7. Issue the print command in your software.

Selecting Envelopes

- No windows, metal clasps, or snaps –they can damage the image drum.
- Paper no heavier than 28 lb.
- Sturdy construction.
- Smooth, even surface.
- Seams down the sides, not across the middle.
- Squared-off flaps that don't cover the print area.
- No self-sealing flaps.
- Always use rear output when printing envelopes.

Operating Your Printer 2

Printing Transparencies and Adhesive Labels

1. Pull out the rear exit extender until it locks

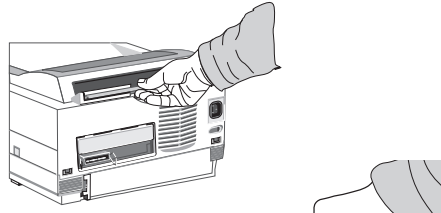

2. Lift out the support bar.

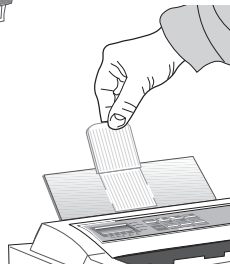

3. Insert the label sheet with print-side up.

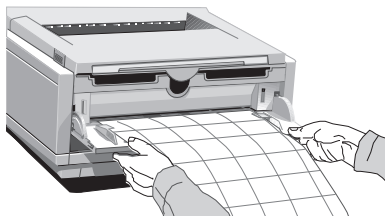

Guidelines for Transparencies and Labels

- Always use manual feed.
- Always use rear output when printing transparencies and adhesive labels.
- Should be specifically made for laser printers or photocopiers.
- Must be able to withstand heat of 200°C for 0.1 second.
- Labels should cover the entire carrier sheet—carrier and adhesive must not be exposed to any part of the printer.
- Use rear paper output – to reduce heat exposure and curling.

Using Recycled Print Media

Recycled paper should be restricted to 20% to 35% Post Consumer Content and not exceed 50%. Paper must be relatively stiff and have minimum edge curl. Paper should be white and bright for maximum contrast. The surface should be smooth, clean, and stable electrically and dimensionally.

Recycled paper used by OKIDATA printers must be specifically denoted by the paper manufacturer to be for laser printers, or laser guaranteed or compatible. Using media outside these specifications may cause problems requiring service that will not be covered by OKIDATA warranty or service agreements.

The following recycled paper has been tested and approved for use in OKIDATA printers.

- Weyerhaeuser, Lynx Opaque, 20% PCW, 20lb., 28 lb. and Laser Copy, 20 lb.
- Union Camp Great White (Laser), 25% PCW, 20lb., 24lb.
- International Paper, Beckett Division, Enhanced Marble, 50% Recycled, 20% PCW, 24lb.
- International Paper, Hammermill Division, Savings DP, 20% PCW, 20 lb.
- Georgia Pacific, GeoCycle, 20% PCW, 20lb.
- James River, WordPro Laser, 20% PCW, 20lb., 24lb.
- Warren, SpectraTech, Gloss and Matte, 10% PCW, 28lb., 32lb.
- Cross Pointe, Worx, 50% Recycled, 20% PCW
- Strathmore, Script Bright White Wove, 50% Recycled

Section 3 ➔ Printer Maintenance

This Section provides the following printer maintenance information:

- Replacing the Toner Cartridge
- Replacing the Image Drum
- Cleaning the LED Array
- Printing a Cleaning Page

Replacing The Toner Cartridge

Replace the toner cartridge after TONER LOW displays on the printer's front operator panel, or on your screen in the Status Monitor if you have installed the printer software. After TONER LOW displays, the printer will print 100 more sheets, then display TONER EMPTY and stop printing. Printing will resume when a new toner cartridge is installed.

1. You will need a new toner cartridge (Type 5 Toner Kit, Part#52109001).
2. Open the printer cover.
3. Grasp the lock lever and pull towards the front of the printer to unlock the cartridge. Lift out carefully and discard the used toner cartridge.

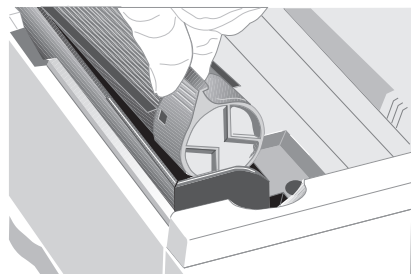

4. To install a new toner cartridge, follow the instruction in Section 1 (or the instructions included in the toner cartridge kit).
5. Be sure to clean the LED array.

⇒ *Drum and Toner are consumables and as such are subject to a 90-day warranty on workmanship.*

Toner Cartridge Life

How long your toner cartridge lasts depends on the print density, the percentage of the page that prints black.

- A typical letter has 3% to 5% print density, graphics usually have higher density.
- Higher print density means toner is used up faster.
- At 5% print density, a toner cartridge will print an average of 2,000 pages. Remember, this is only an average actual results may vary.

The first toner cartridge in your new printer has to fill the drum reservoir and saturate the developing roller with toner. It's normal that the first cartridge will produce about 1,000 pages.

Printer Maintenance 3

Replacing the Image Drum Cartridge

When the image drum reaches 90% of its life, the CHANGE DRUM message will display on the printer's front operator panel and on your screen in the Status Monitor if you have installed the printer software. Change the image drum cartridge when the print becomes faint or begins to deteriorate. It's a good idea to keep a new cartridge on hand.

1. You will need a new image drum cartridge (Type 5 Image Drum Cartridge Kit, Part#40433305) and a new toner cartridge (Type 5 Toner Kit, Part#52109001).
2. Open the printer cover.

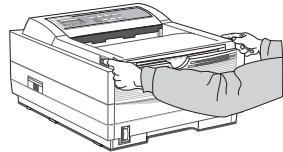

3. Lift out the used image drum cartridge with toner installed.

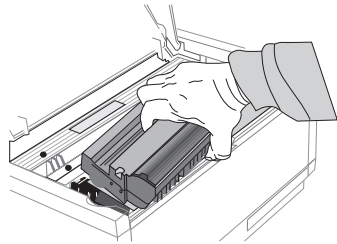

4. Remove the new image drum cartridge from the package. To install the new image drum cartridge, follow the installation instructions in Section 1 (or the instructions included in the replacement kit).

Image Drum Cartridge Life

The life of the image drum depends on a number of factors, including the operating temperature, humidity, the type of paper you use, and the number of pages per job. Each time you print or power on/off, the drum has to rotate to start up and to wind down. As a result, frequent one page print jobs will wear down your drum more quickly than multiple-page print jobs. The image drum cartridge should last up to 10,000 pages at 1 page per job, or 20,000 pages at 3 pages per job (continuous printing). These numbers are approximate since you won't print the same number of pages each time, and environmental conditions and paper type used may vary.

Cleaning the LED Array

Clean the LED array each time you install a new toner cartridge, or if you have faded vertical areas or light printing down a page.

The LED array is on the underside of the printer cover. Wipe it gently with the cleaning pad that is included in the toner cartridge kit. You can also use a clean, soft cloth with a small amount of rubbing alcohol on it.

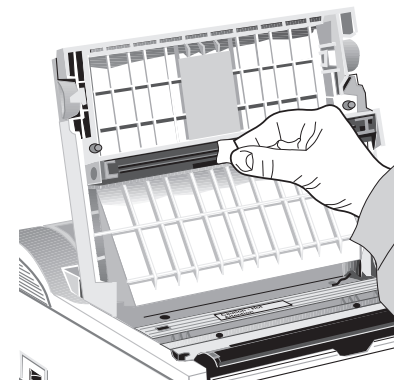

Printing a Cleaning Page

The cleaning page process removes residual impurities from printing surfaces. Printing a cleaning page helps reduce print quality problems, such as repeated marks, blotches, and shaded areas.

From the front operator panel:

1. Press ON-LINE to set the printer off-line.
2. Press ◀/Recover and ▶/Reset simultaneously and hold for 2 seconds. CLEANING, MANUAL LETTER REQUEST displays.
3. Pull down the manual feed tray and insert a clean sheet of 8 1/2" x 11" paper. The print rollers will grip the paper and PRINT CLEANING displays.

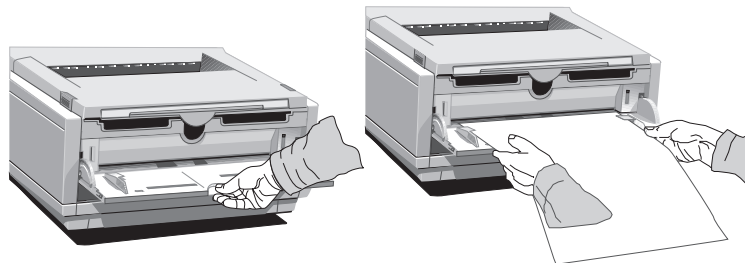

4. The cleaning page prints, then OFF-LINE displays.
5. Press ON-LINE to enter online mode.

From the status monitor:

1. Click the Operator Panel button on the status monitor Controls tab.

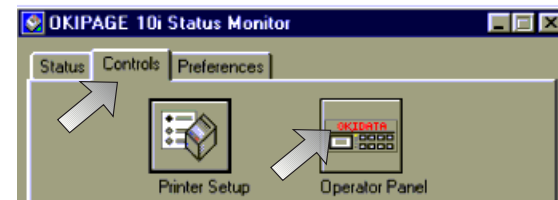

2. Click the Test Printing tab.

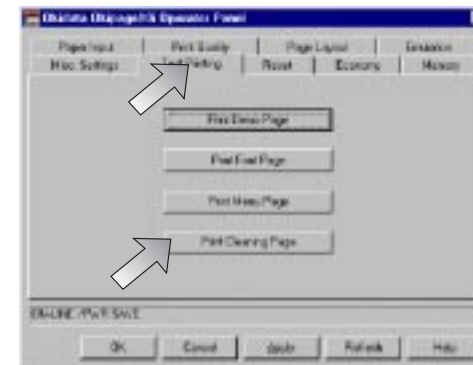

3. Click the Print Cleaning Page button. Follow the on-screen instructions.

Section 4 ➔ Problem Solving

Clearing Paper Jams

To reduce paper jams:

- Do not fill tray above Paper Full mark.
- Use only recommended paper weight
 - Tray: 16 to 28 lb. (60 to 105 g/m²)
 - Manual feed: 16 to 32 lb (60 to 120.5 g/m²)
- Do not open the cover, or remove the paper tray during a print job.
- Do not switch paper exit paths while printing.
- Use paper that is smooth and of high quality.
- Store paper in its ream wrapper until you are ready to use it, and keep it away from moisture or other conditions that can cause it to wrinkle or curl.
- Avoid printing on both sides of the paper for more than a few pages, or preprinted documents that have been in a photocopier.
- Try paper before you buy in quantity.

If a paper jam message displays, remove the jam using the instructions that follow.

TRAY n INPUT JAM

⇒ “n” indicates the tray in which the jam occurred

1. Slide the paper tray out of the printer.

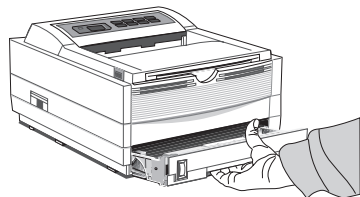

2. Remove the sheet that did not feed.

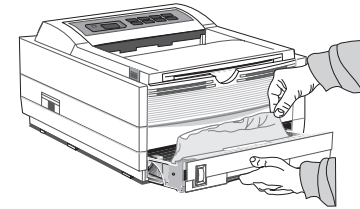

3. Check the remaining sheets to make sure they're not wrinkled or stuck together. Replace the tray.
4. Open and close the cover to clear the display message.

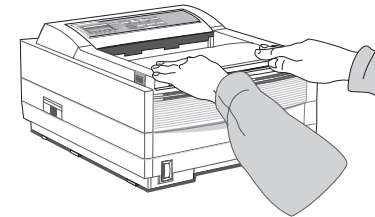

TRAY n FEED JAM or PAPER EXIT JAM (top bin)

displays when paper exits to the top bin

1. Open the cover. Lift out the image drum. *Be careful: the fuser unit at the back of the printer is hot!*

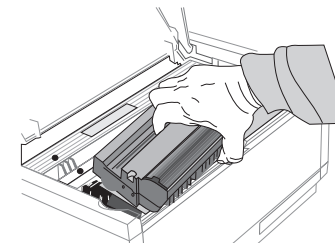

2. Remove the jammed paper.

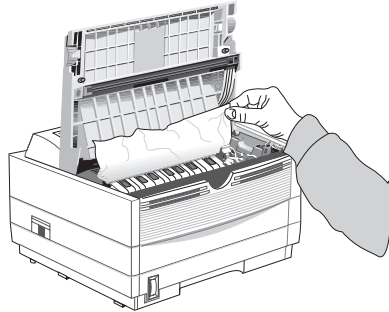

3. Replace the image drum. Close the cover.

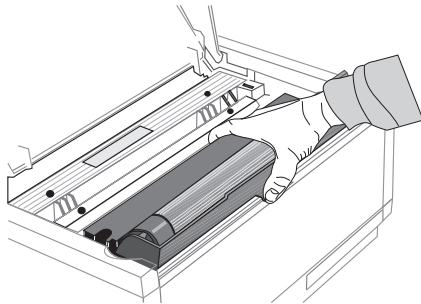

PAPER EXIT JAM (rear tray)

displays if paper exits to rear exit tray

1. Lift the top cover.

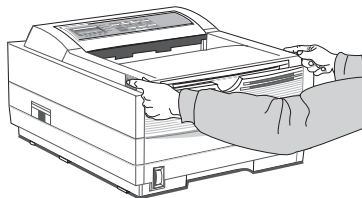

2. Pull the jammed paper out from the back of the printer. Pulling from the front may damage the printer.

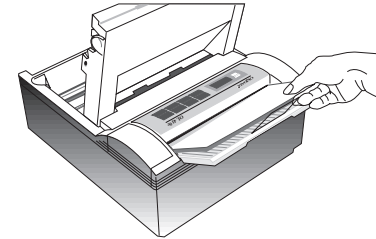

3. Remove the image drum and look to make sure the paper is cleared and no pieces are left.

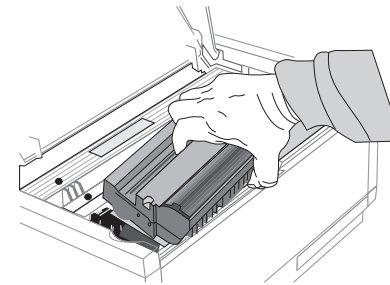

4. Replace the image drum and close the cover.

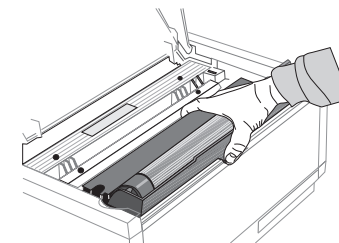

Problem Solving 4

Printer Messages

This section explains printer status messages displayed on the operator panel LCD.

System Status

MESSAGE: ■■■■■■■■
■■■■■■■■

Explanation: Displayed when power is turned on. The lamp and display light for 1 second.

Action: No action needed. *If display is continuous, contact service.*

MESSAGE: ACTIVE

Explanation: Data is being received or is in process of being output.

Action: No action needed.

MESSAGE: INITIALIZING

Explanation: Controller is being initialized.

Action: No action needed.

MESSAGE: WARM UP

Explanation: Printer is warming up.

Action: No action needed.

MESSAGE: ON-LINE

Explanation: Ready to receive data. Second line alternates between Emulation and PWR SAVE when fuser and fan are turned off by power save function.

Action: No action needed.

MESSAGE: OFF-LINE

Explanation: Not on-line to receive data.

Action: Press ON-LINE to enable printer to receive data.

MESSAGE: DATA

Explanation: Data remains in buffer.

Action: Press ON-LINE, FORM FEED, ON-LINE to empty buffer.

MESSAGE: PRINT FONTS

Explanation: Font sample page prints.

Action: No action needed.

MESSAGE: PRINT MENU

Explanation: Menu page prints.

Action: No action needed.

MESSAGE: PRINT DEMO

Explanation: Demo page prints.

Action: No action needed.

MESSAGE: RESET

Explanation: Data not yet printed is deleted from buffer, printer initializes to user defaults. Temporary DLL fonts are deleted.

Action: No action needed.

MESSAGE: RESET TO SAVE

Explanation: Data or DLLs in buffer, menu cannot be reset automatically.

Action: Press RESET button to save changes and exit menu.

MESSAGE: CPYnn

Explanation: Displayed when number of copies is two or more, nn indicates copies.

Action: No action needed.

Maintenance Menu Mode

MESSAGE: USER MNT

Explanation: Maintenance Menu has been accessed.

Action: Press MENU button to see categories.

MESSAGE: MENU RESET

Explanation: Menu reset option has been accessed.

Action: Press ENTER to reset Menus 1 & 2 to factory settings, or press MENU to see next category.

MESSAGE: HEX DUMP

Explanation: Hex Dump option has been accessed.

Action: Press ENTER to start hex dump of received data, or MENU for next category. Power OFF/ ON to exit hex dump mode.

MESSAGE: DRUM CNT RESET

Explanation: Drum Counter Reset option has been accessed.

Action: Press ENTER to reset drum counter, or press MENU for next category.

MESSAGE: OP MENU

Explanation: Control panel Enable/ Disable category accessed. Change to Disable to deactivate control panel; features can be controlled only through software. To reset, enter Maintenance Menu.

Action: Press NEXT + to toggle enable/disable then press ENTER.

Cleaning/Maintenance

MESSAGE: xxxxxx

TONER LOW

Explanation: Toner is running out. Another message can display on the first line.

Action: Replace toner cartridge when print quality deteriorates.

MESSAGE: TONER SNS

Explanation: A fault occurred in the toner sensor; image drum cartridge is not properly installed.

Action: Install/reinstall image drum cartridge. If not cleared, contact Service.

MESSAGE: xxxxxx

CHG DRUM

Explanation: Drum near end of life. Another message can display on the first line.

Action: Normal operations continue. Replace Image Drum Cartridge when print quality deteriorates.

MESSAGE: xxxxxx

FUSER

Explanation: Fuser near end of life. Another message can display on the first line.

Action: Normal operations continue. When print quality deteriorates, contact service to replace fuser.

MESSAGE: COVER

Explanation: Cover is open.

Action: Close cover.

Problem Solving 4

MESSAGE: PRINT CLEANING

Explanation: Cleaning Page being generated.

Action: See Cleaning Page instructions in Section 3.

Paper Errors

MESSAGE: TRAY PAPER OUT

Explanation: Paper tray has run out of paper.

Action: Add paper.

MESSAGE: TRAY n INPUT JAM

Explanation: Paper jammed while being supplied from the tray.

Action: n=tray 1, 2. See page 85 for instructions.

MESSAGE: TRAY n FEED JAM

Explanation: Paper jammed during feeding inside printer.

Action: n=tray 1, 2. See page 84 for instructions.

MESSAGE: PAPER EXIT JAM n

Explanation: Paper jammed at exit.

Action: n=tray1, 2. See page 86 for instructions.

MESSAGE: PAPER SIZE ERR

Explanation: Wrong size paper is in the tray.

Action: Check paper in tray; check for too much paper. Open/Close top cover to recover and continue. Ensure that paper size in menu or software matches size you are using.

MESSAGE: xxxxx PAPER

Explanation: Request to load specified size paper in tray. Top line of message may be any valid paper size.

Action: Insert requested size paper.

Manual Paper Feed Request

MESSAGE: xxxxx MANUAL REQUEST

Explanation: Request that specified size paper be loaded in manual feed slot. Top line of message may be any valid paper size.

Action: Insert requested size paper in manual feed slot.

MESSAGE: REC BUFFER OVERFLOW

Explanation: Receive buffer is full.

Action: Press RECOVER to continue. Check flow control setting in menu, cable configuration.

MESSAGE: PAGE BUF OVERFLOW

Explanation: Page buffer is full.

Action: Press RECOVER to continue. Resend job beginning with page that did not print. If problem persists, set REC BUFF=8K, FONT PROT=OFF in MENU 2 MEMORY USAGE. Resend job. If job still cannot print, additional memory is required.

MESSAGE: PRINT OVERRUN

Explanation: Page is too complicated to print.

Action: Press RECOVER to release error. Set PAGE BUF to larger value in Menu 2

MESSAGE: DLL BUFF OVERFLOW

Explanation: Data in the DLL buffer has overflowed.

Action: Press RECOVER to continue. Decrease amount of DLL fonts (Windows TrueType) or install more memory.

MESSAGE: MACRO OVERFLOW

Explanation: Data in the Macro Buffer has overflowed.

Action: Press RECOVER to continue. Decrease Macro size or install more memory.

Controller Errors

MESSAGE: ERROR nn aaaaaaaa

Explanation: Error occurred in controller.
nn = Exception Code. aaaaaaaa = Error Address.

Action: Turn printer off/on to recover. If error continues, contact service.

MESSAGE: ERROR nn

Explanation: Indicates internal error. nn = type of error.

Action: Call Service if turning the power off and on does not clear error.

Interface Errors

MESSAGE: HOST I/F ERROR

Explanation: Error in optional serial I/F. Displayed when parity error, framing error or overrun error is detected.

Action: Press RECOVER to release error. Check protocol of host and printer. Contact service.

Print Quality Problems

Before consulting a service representative regarding a print quality problem, check the table below to see if there is a solution, or something you might have overlooked.

Symptom: Blank sheets printed.

Problem: Image drum cartridge not properly installed.

Solution: Reinstall image drum cartridge.

Problem: Empty or missing toner cartridge.

Solution: Install new toner cartridge.

Symptom: Entire page prints faintly.

Problem: Empty toner cartridge. Pages get fainter when toner is low.

Solution: Install new toner cartridge.

Problem: LED array is dirty.

Solution: Clean LED array. (See Section 3)

Symptom: Page has gray background.

Problem: Static electricity, generally from dry, cotton fiber papers, causes toner to stick to background.

Solution: Change papers to an acceptable laser bond or use a humidifier.

Problem Solving 4

- Symptom:** Page prints all black.
Problem: Damaged image drum cartridge causes repetitive marks every 1.6 inches due to surface nicks and scratches.
Solution: Install new image drum cartridge.
- Symptom:** Vertical white streaking or faint areas on page.
Problem: Toner is low and does not distribute properly or the drum is worn out.
Solution: Replace toner cartridge. Check drum and replace the drum, if necessary. Contact service.
- Problem:** LED array dirty.
Solution: Clean LED array. (See Section 3)
- Symptom:** Vertical black lines.
Problem: Scratched image drum.
Solution: Replace the image drum cartridge.
- Problem:** Hardware problem.
Solution: Contact service.
- Symptom:** Fuzzy print
Problem: Dirty LED array.
Solution: Clean LED array.
- Symptom:** Distorted print
Problem: Paper path, lamp assembly, or fusing unit problem.
Solution: Generate Cleaning Page. Contact service.
- Symptom:** Faded print after installation.
Problem: Toner cartridge is not correctly installed.
Solution: Install toner cartridge correctly.

- Symptom:** Smearred or blotched print.
Problem: Dirty or defective fuser assembly or other hardware problem.
Solution: Generate Cleaning Page. Contact service.
- Symptom:** Printed page is light or blurred.
Problem: Is toner low?
Solution: Replace toner cartridge.
- Problem:** Is paper meant for laser printers?
Solution: Use recommended paper.
- Problem:** LED array is dirty.
Solution: Clean LED array.
- Symptom:** Bold characters and dark lines are smeared.
Problem: Toner is low.
Solution: Install new toner cartridge.
- Symptom:** Print is darker than usual.
Problem: Darkness setting is too high.
Solution: Change darkness setting in the printer menu.
- Symptom:** Pages curl excessively
Problem: Printing on wrong side of paper. High humidity.
Solution: Turn paper over in tray. Note arrow on paper package. Install paper print side down in tray.
- Problem:** Moisture in paper. Improper storage.
Solution: Avoid storing paper in areas of excessive temperature changes and humidity.
- Problem:** High Humidity.
Solution: Recommended operating humidity: 20-80%

Software Problems

Software controls printing features. Make sure you have selected the correct printer driver in your software. See your software application documentation for more information.

- Symptom:** Blank pages appear between printed pages.
- Problem:** Number of lines per page in software is not equal to number of lines per page of printer.
- Solution:** Many software packages assume 66 lines per page; your printer default is 60. Adjust software accordingly, or set LINES/Pg in Menu 1 to equal lines per page in software.
- Symptom:** Cannot get justified right margin with a proportionally spaced font.
- Problem:** Right justification with proportional fonts is a software feature.
- Solution:** Check your software manual to see if this feature is supported.
- Symptom:** Control codes not operating correctly.
- Problem:** Incorrectly entered control codes.
- Solution:** Check for confusion of letter *l* with number 1, letter *O* with number 0; make sure you are using upper/ lower case correctly; make sure font is specified correctly and is available.
- Symptom:** Data sent to printer does not print, but DATA message appears.
- Problem:** A form feed has not been sent.
- Solution:** Press the ON-LINE button to take the printer off-line, then press the FORM FEED button to eject the final page, or send a form feed command (decimal character 12). If desired, set AUTOEJCT in MENU2.

- Symptom:** Data is sent to printer, but nothing happens. ON-LINE message appears.
- Problem:** Wrong interface cable.
- Solution:** Use correct cable. If optional Serial I/F is installed, make sure RS232C Serial is selected in the Level 1 menu and RS232C Serial settings in Level 2 menu are correct.
- Symptom:** Last page of document not printed.
- Problem:** No form feed provided at end of document.
- Solution:** Press the ON-LINE button to take the printer off-line, then press the FORM FEED button to eject the final page or send the form feed code (decimal character 12). If desired, set AUTOEJCT in MENU 2.
- Symptom:** First line on page won't print.
- Problem:** Tops of letters extend into unprintable area, so none of them print.
- Solution:** Set your software to print within the printable area.
- Symptom:** Parts of control codes are printed at the beginning of documents.
- Problem:** Command sent is not a true printer command, generally because the ESC character was not sent.
- Solution:** Before sending control codes through an application, make sure the ESC character can be entered, and is entered properly.
- Symptom:** Parts of documents are missing at the edges of the printed sheet.
- Problem:** Software is attempting to print beyond the printer's maximum image area.
- Solution:** Adjust software page margins to printer's maximum margins (8" X 10" for standard sheets).

Problem Solving 4

Symptom: Print job started with italics, changed to bold, but italics still output.

Problem: Font selection is by priority, and italic is “higher” than bold.

Solution: Turn italics off before turning bold on.

Symptom: Printer ignores control codes sent prior to printing a document.

Problem: The application software automatically sends a reset command before printing.

Solution: Embed the control codes in the text to be printed.

Symptom: “Garbage” prints out.

Problem: Incorrect driver is installed.

Solution: Install an appropriate driver.

Symptom: Printer’s output is below rated speed.

Problem: Delays are caused by software formatting routines, graphics downloads, and other application specific factors.

Solution: For maximum speed, output plain text.

Symptom: Size of top margin increases with each page printed.

Problem: “Creeping text.” Number of lines per page in software is not equal to number of lines per page of printer.

Solution: Many software packages assume 66 lines per page, but your printer’s default is 60. Adjust software accordingly, or set LINES/ Pg in Menu 1 to equal lines per page in software.

Problem: In Epson FX Emulation, when command for 66 lines is sent to the printer, printer prints only 64 lines on a page, loses the 65 and 66 line and prints 67th line on the second page.

Solution: Set line spacing to 35/216 with a software command ESC “3” Pn (Pn=number of 216ths). Then send the command to set the page length to 66 lines per page, ESC C Pn (Pn = number of lines per page).

Symptom: Strange symbols appear during normal printing.

Problem: Wrong symbol set.

Solution: Make sure the symbol set selected corresponds to symbol set resident, in font card, or in soft font.

Hardware Problems

- Symptom:** Graphic image prints partly on one page, partly on the next.
- Problem:** Insufficient printer memory for this image at this resolution.
- Solution:** Change the resolution, reduce the image size, or install more memory in your printer.
-
- Symptom:** Nothing happens, but printer indicates it is ready to receive data.
- Problem:** Configuration error.
- Solution:** Check cable connection; if serial, make sure appropriate MODE command has been used (PC). If more than one printer is available, make sure your printer has been selected. Make sure your printer is on-line.
-
- Symptom:** “Garbage” prints.
- Problem:** Incorrect cable configuration. (Also, see “Software Problems.”)
- Solution:** Check cable configuration, continuity, and length.
- Symptom:** Printer freezes or displays error message when computer is rebooted.
- Problem:** Booting the computer while the printer is on can cause a communications error.
- Solution:** Take printer off-line before rebooting computer.
-
- Problem:** Gases are given off by forms or adhesives passing through the hot fusing unit.
- Solution:** Make sure the forms you use can withstand heating, and provide adequate ventilation.

Section 5 → Service and Support

This information is valid for the United States and Canada only.

If you can't solve your printer problem after reading this manual, contact these sources for service or support.

OKIDATA ONLINE

Visit the OKIDATA Web Site at

<http://www.okidata.com>

for the latest information on:

- Software drivers
- Product guides
- Customer support
- Corporate information
- Dealers
- Documentation

Your Dealer

Consult the store where you purchased your printer, or call 1-800-OKIDATA for the location of the nearest authorized Okidata service dealer. Have your ZIP code ready.

- Proof of purchase is required for warranty work. Be sure to retain your purchase documents.
- Prices and minimum charges may vary.

The Okidata Customer Support Center

For customer service, call 1-800-OKIDATA. The Okidata Information System Automated Attendant is available 24 hours a day, 7 days a week. The system can provide immediate assistance with:

- Basic printer operating procedures
- Sales and service referrals
- Parts and consumable referrals
- Product information

Okidata Customer Service Representatives

Agents are available 24 hours a day, 7 days a week. Please be sure that you are calling from a telephone close to your printer, so you can describe your problem accurately. Our customer service representative are trained on all current Okidata products. They can answer your questions regarding:

- Installation of your printer
- Determination of printer issues and require service
- Consumer relations
- Interface information
- Availability and installation of printer drivers. (*CSRs are not trained to provide assistance with the use of commercial software packages. Please consult your software user's manual for times and availability of their support*).

Faxable Facts

You can have product and support information faxed automatically to you through Okidata's Faxable Facts, an online document retrieval system. A touch-tone telephone and facsimile machine with a designated telephone number are required.

Call toll-free at 1-800-654-6651, press option 2 to hear a description of how Faxable Facts works. If you are calling for the first time, order a catalog of available documents. This faxback system is accessible 24 hours a day, 7 days a week. The following information can be faxed to you in minutes:

- Product data brochures
- Product part numbers and pricing (USA and Canadian)
- User tips
- Accessories, options, and consumables part numbers and pricing (USA and Canadian)

Purchasing Supplies

Before you order, know your printer model number (see the front of the printer) and have the correct part number and description of the item.

Ways to Purchase

- Consult the dealer where you purchased your printer.
- Consult an Okidata authorized sales or service dealer.
- Call 1-800-OKIDATA for the nearest Authorized Sales and Service location. Have your ZIP code ready for our Customer Support Representatives.
- Check office supply catalogs or your local stationery store. Most carry Okidata brand supplies.

Warranty Service

Your printer is warranted for one year from date of purchase except for the printhead (LED imaging array), which is warranted for a period of five years from date of purchase. If your printer hardware should fail during the warranty period, you have the option of returning it, shipped prepaid to OKIDATA or an authorized service center, or using the overnight exchange procedure (U.S. and Canada only). See the list of OKIDATA Service Centers or call 1-800-OKIDATA for the location of the nearest authorized Okidata service dealer. Have your ZIP code ready. See Limited Warranty and Overnight Exchange in this section for more information.

OKIDATA SERVICE CENTERS

If you need to ship your printer to a service center, replace it in the original packing materials. If the original packaging is not available, contact your dealer or 1-800-OKIDATA for shipping instructions.

For out-of-warranty repairs, allow 30 days for round trip shipping and repair. Before shipping your printer, call for a return authorization number (RA).

Okidata Service Center Locations

UNITED STATES

OKIDATA

Tel: 1-800-809-4948

Fax: 1-609-222-5247

CANADA

OKIDATA

Tel: 905-238-4265

Fax: 905-238-4427

MEXICO

Oki Data de Mexico, S.A. de C.V.

Tel: 525-661-6860

Fax: 525-661-5861

Compu Support

Tel: 915-559-3022

Fax: 915-559-3267

C-Sercomp

Tel: 915-581-2166

Fax: 915-697-6366

ROM Mayoreo Mexico

Phone/Fax: 525-682-3407

ARGENTINA

Free Distribuidores Mayoristas

Fax: 54-41-259250

Tel: Buenos Aires: (01)300-0052

Tel: Cordoba: (051)61-4060

Tel: Rosario: (041)49-4440

CHILE

Teknos Comunicaciones

Tel: 56 (2) 555 5530

Fax: 56 (2)550 2390

VENEZUELA

MAI de Venezuela S.A.

Tel: 782.78.11

Fax: (02)781.9390

COLOMBIA

Texins S.A.

Tel: 571-218-5300

BRAZIL

Oki Data do Brasil, Ltda.

Av. Leonardo da Vinc

1178/1182 Jabaquara

Sao Paulo, Brasil

Tel: (5511) 5589-1518

Fax: (5511) 5584-0267

NYTEK

Rua Pe. Francisco Libermann

301 Cidade Sao Francisco

Sao Paulo CEP 05353-160

Tel: (011) 819-0211

Fax: (011) 819-3496

NYTEK

Rua Parapanema

122 Jd. Rio das Pedras

Cotia, Sao Paulo CEP 06700-000

Tel: (011) 7924-0796, 7, 8

Fax: (011) 493-3234

Limited Warranty

OKIDATA, division of Oki America, Inc. (OKIDATA) warrants this printer to be free from defect in material and workmanship and will remedy any such defect according to the terms of this *Limited Warranty*.

OKIDATA will repair (or at its option, replace) at no charge, any defective component(s) of the Printer for one (1) year from the date of purchase except for the printhead (LED imaging array), which is warranted for a period of five (5) years from date of purchase. This *Limited Warranty* extends to the original purchaser only. This *Limited Warranty* does not extend to consumable items.

To make request or claim for service under this *Limited Warranty* the original purchaser has the option to implement the overnight exchange procedure (U.S and Canada only; see Overnight Exchange) or return the OKIDATA product, shipping prepaid, in the original shipping container or equivalent, to OKIDATA or an authorized OKIDATA service center and assume the risk of loss or damage in transit. A written receipt for the product, showing the date of purchase, dealer's name, and both the model and serial numbers of the OKIDATA printer must accompany any request or claim for work to be performed under this *Limited Warranty*.

This *Limited Warranty* shall not apply if the product has been damaged due to abuse, misuse, misapplication, accident, or as a result of service or modification by any other than an authorized OKIDATA service center. THERE ARE NO EXPRESS WARRANTIES OTHER THAN THOSE ON THE FACE HEREOF AND DESCRIBED ABOVE. NO WARRANTIES WHETHER EXPRESS OR IMPLIED, INCLUDING, BUT NOT LIMITED TO, ANY PARTICULAR PURPOSE, SHALL EXTEND BEYOND THE RESPECTIVE WARRANTY PERIOD DESCRIBED ABOVE. Some states do not allow limitations on how long an implied warranty lasts, so the above limitation may not apply to you. OKIDATA SHALL NOT BE RESPONSIBLE OR LIABLE FOR ANY

SPECIAL, INCIDENTAL OR CONSEQUENTIAL DAMAGES OR LOSS ARISING FROM THE USE OF THIS PRODUCT. Some states do not allow the exclusion or limitation of incidental or consequential damages, so the above exclusion may not apply to you.

Additional information on obtaining service under this *Limited Warranty* is available by contacting the OKIDATA dealer from whom the product was purchased, by contacting OKIDATA directly at 1-800-OKIDATA (U.S. and Canada, English only) or 1-609-222-5276 (Spanish only), or by contacting one of the service depots listed.

This *Limited Warranty* applies to this OKIDATA printer. However, the procedure for obtaining service may vary outside the continental United States. Contact your OKIDATA dealer for such warranty service information.

This warranty gives you specific legal rights, and you may also have other rights which vary from state to state.

Overnight Exchange

Available in the United States and Canada

If you choose to use our Overnight Exchange service, call 1-800-OKIDATA: our trained personnel will try to solve your problem over the phone. If they determine that your printer hardware is defective, an exchange machine will be shipped to you via air express. Have your credit card available as our representative will be asking for this information. You will receive the exchange machine the next business day—or no later than the second business day.

Return the original machine to OKIDATA by using the same packaging materials you received with the exchange printer, and making it available to pickup by OKIDATA's representative within 2 business days from your receipt of the exchange machine: failure to do so may result in your being charged the full price of the exchange unit. Before you ship the printer, remove the image drum and toner cartridge to prevent damage to the printer during shipment: failure to do so may result in a fee for cleaning/repairs which will be charged to your account.

When Overnight Exchange is used, the returned machine becomes the property of OKIDATA. Exchange machines may be new or repaired, at the option of OKIDATA: the exchange machine becomes the property of the customer when the returned machine had been picked up by OKIDATA's designated carrier. The exchange printer will be warranted for thirty (30) days or the remaining warranty period of the returned printer, whichever is longer.

Overnight Exchange of the printer for a printhead failure is limited to one year from date of purchase. For the remaining printhead warranty period, replacement will be at an authorized service center or authorized third party service organization. Call 1-800-OKIDATA for authorized service locations.

A

ACTIVE message 34
Adhesive Labels 28
AUTO OPERATION 21

B

Bi-directional interface 7
Button Functions 11

C

CHANGE DRUM message 30, 35
Cleaning Page 31
Cleaning the LED Array 30
CLEARABLE WARNINGS 23
connecting cables 7
Consumables 1
 image drum 1
 toner 1
Contents, check 2
COVER message 35
CPYnn message 34
Customer Service Representatives 42
Customer Support Center 42

D

DARKNESS CONTROL 22
DATA message 34
Demo pages 8
Display language 8
display window 10
DLL BUFF OVERFLOW message 36
Drivers, printer 1, 9
DRUM CNT RESET message 35

E

EDIT SIZE 13
Emulations 1
Energy Savings 1
Envelopes 26, 27
ERROR nn aaaaaaaa message 37
ERROR nn message 37
ERROR REPORT 23

F

Faxable Facts 43
Fonts 1
 Adobe™ Type-1 1
 OCR-A/B 1
 True Type 1
FONTS & SYMBOLS 16
FONTS & SYMBOLS (IBM, EPSON) 17
Front Operator Panel 10
FUSER message 35

H

HEX DUMP message 35
HOST I/F 20
HOST I/F ERROR message 37

I

Image Drum Cartridge
 replacing 30
INITIALIZING message 34
Installing Toner 4
Interfacing 7

L

Labels 26

LANGUAGE 8, 24
LED Array
 cleaning 30
Level-1 Menu 12, 13
Level-2 Menu 12, 21
Location, selecting a suitable 2
LOW TONER 22

M

MACRO OVERFLOW message 37
Maintenance Menu 25
MANUAL REQUEST message 36
MEDIA TYPE 15
Memory 1
MEMORY USAGE 21
Menu 12
 Level-1 Menu 12, 13
 Level-2 Menu 12, 21
 printing 12
 resetting 12
 Sub Menus 12
 using 12
MENU RESET message 35

N

NETWORK 24

O

OFF-LINE message 34
OKIDATA Online 42
OKIDATA Service Centers 43, 44
ON-LINE message 34
OP MENU message 35
Options 1

Index

- P**
- PAGE BUF OVERFLOW message 36
 - PAGE LAYOUT 1 17
 - PAGE LAYOUT 1 (IBM, EPSON) 18
 - PAGE LAYOUT 2 20
 - Paper Capacity 1
 - PAPER EXIT JAM 32, 33
 - PAPER EXIT JAM n message 36
 - Paper exit path 6
 - Paper Jams
 - PAPER EXIT JAM 33
 - TRAY n EXIT JAM 32
 - TRAY n FEED JAM 32
 - TRAY n INPUT JAM 32
 - reducing 32
 - PAPER SIZE 14–16
 - PAPER SIZE CHECK 15
 - PAPER SIZE ERR message 36
 - Paper Size Indicator 10
 - PARALLEL I/F 23
 - Parallel interface 7
 - PERSONALITY 13
 - Power cord 7
 - POWER SAVING 22
 - PRINT CLEANING message 36
 - PRINT DEMO message 34
 - PRINT FONTS message 34
 - PRINT MENU message 34
 - PRINT MODE 21
 - PRINT OVERRUN message 36
 - Print quality 1, 37, 38, 39
 - Print speed 1
 - Printer Messages
 - Cleaning/Maintenance 35
 - Controller Errors 37
 - Interface Errors 37
 - Maintenance Menu Mode 35
 - Manual Paper Feed Request 36
 - Paper Errors 36
 - System Status 34
 - Printing the Menu 12
 - Protective Film 3
 - Protective Paper 3
 - PRPROTEK 22
 - Purchasing Supplies 43
- R**
- Ready Light 10
 - REC BUFFER OVERFLOW message 36
 - RESET message 34
 - RESET TO SAVE message 34
 - Resetting the Menu 12
 - RS232C SERIAL 23
- S**
- Service and Support 42
 - Customer Information Center 42
 - Customer Service Representatives 42
 - Dealers 42
 - Faxable Facts 43
 - REGIONAL SERVICE CENTER 43
 - Web Site 42
 - Status Monitor 1
 - Supplies
 - purchasing 43
- T**
- Toner Cartridge
 - replacing 29
 - TONER EMPTY message 29
 - TONER LOW message 29, 35
 - TONER SAVING 22
 - TONER SNS message 35
 - Transparencies 26, 28
 - TRAY n FEED JAM 32
 - TRAY n FEED JAM message 36
 - TRAY n INPUT JAM 32
 - TRAY n INPUT JAM message 36
 - TRAY PAPER OUT message 36
 - TRAY SELECT 13
- U**
- USER MNT message 35
 - USPS Barcode font 1
- W**
- WARM UP message 34
 - Web Site 42
- X**
- xxxxx PAPER message 36

MATERIAL SAFETY DATA SHEET

Type 5 Toner 52109001

MSDS # 58330401

For more information, contact Okidata at:

532 Fellowship Road
Mount Laurel, NJ 08054
Emergency Information: 1-800-OKIDATA

EMERGENCY FIRST AID PROCEDURES

Emergency	Procedure
Toner swallowed (ingested)	Dilute by giving two glasses of water and induce vomiting by administering Syrup of Ipecac (follow manufacturer's instructions). Seek medical attention. <i>NEVER give anything by mouth or attempt to induce vomiting in a person who is unconscious.</i>
Toner inhaled	Remove person to fresh air. Seek medical attention.
Toner gets in the eyes	Flush eyes with large quantities of cool water for 15 minutes, keeping the eyelids open with fingers. Seek medical attention.
Note	Small amounts of toner on skin or clothing can easily be removed with soap and <i>cold</i> water. Hot water makes toner harder to remove.

Hazardous Ingredients

Styrene-Butyl Acrylate Copolymer (91% by weight)

CAS# 25767-47-9
OSHA TWA 15 mg/m³ for total dust
ACGIH TLV 10 mg/m³ for total dust

Carbon Black (5-7% by weight)

CAS# 1333-86-4
OSHA TWA 3.5 mg/m³
ACGIH TLV 3.5 mg/m³

Paraffin Wax (less than 3% by weight)

CAS# 8002-74-2
OSHA TWA 2 mg/m³ for total dust
ACGIH TLV 2 mg/m³ for total dust

OKIPAGE 10i User's Guide

Amorphous Fumed Silica (less than 1% by weight)

CAS# 67762-90-7
OSHA PEL 15.0 mg/m³ for total dust
ACGIH TLV 10.0 mg/m³ for total dust

Note This product is not regulated under Section 313 of SARA, Title III.

Physical Data

Melting Point: 110°C (230°F)
Boiling Point: Not applicable
Vapor Pressure: Not applicable
Vapor Density (Air=1): Not applicable
Evaporation Rate (Butyl Acetate=1): Not applicable
Specific Gravity (H₂O=1): 1.15
Solubility in water: Negligible
Appearance and odor: Black granules, no odor

Fire and Explosion Hazard Data

Flash Point (Method Used): Not applicable
Flammable Limits
Lower Explosive Limit: Not applicable
Upper Explosive Limit: Not applicable
Extinguishing Media: Water, CO₂, Dry Chemical, or Foam
Special Fire Fighting Procedures: Do not use methods that may create a dust cloud, such as high pressure water and/or steam
Unusual Fire and Explosion Hazards:
—Organic components decompose at 200-455°C (392-851°F).
—Material may explosively combust when finely suspended in air.
—Thermal decomposition of organic components may result in release of oxides of carbon and nitrogen.

Health Hazard Data

Routes of Entry: Inhalation, Ingestion, Eyes, Skin.

Health Hazards:

1. Styrene-Butyl Acrylate Copolymer

Subcutaneous implantation of polymeric styrene powder in rats has induced tumors at the site of implantation.

2. Carbon black

(Group 2B "Possible Carcinogen"; IARC)

Overexposure to carbon black is associated with causing irritation, conjunctivitis, and corneal hypoplasia of the eyes; minor irritation and eczema of the skin; and throat irritation and bronchitis. Long-term inhalation exposure may be associated with causing lung cancer.

3. Paraffin Wax

(Group 3 "Not Classifiable"; IARC)

May cause eye, skin, respiratory, and digestive tract irritation. Paraffin is an equivocal tumorigenic agent by RTECS criteria.

4. Amorphous Fumed Silica

(Group 3 "Not Classifiable"; IARC)

Overexposure to amorphous silica has been associated with causing irritation of the lungs and pneumoconiosis. Long-term inhalation exposure may be associated with producing tumors in laboratory animals.

Reactivity Data

Stability: Stable

Polymerization: Will not occur.

Hazardous Decomposition Products: Thermal

decomposition may result in release of oxides of carbon and nitrogen.

Temperature: Do not expose to temperatures above 200°C (392°F).

Incompatibility: Avoid exposure to strong oxidizers.

Spill Cleanup and Disposal

Spill Cleanup

Small Spills

1. Remove sources of ignition.
2. Clean up spill with wet cloth.

Large Spills

1. Remove sources of ignition.
2. Wear protective gear: respirator, rubber gloves, goggles (see below)
3. Clean up spill with scoop, *being* careful not to generate a lot of dust.

Waste Disposal: Follow appropriate federal, state and local regulations.

Safe Handling and Use

Respiratory Protection: Not normally required. For large spills, use NIOSH-approved full face-piece respirator with HEPA cartridge during cleanup.

Protective Gloves and/or Eye Protection: Not normally required. For large spills, use rubber gloves and chemical worker's goggles during cleanup.

Ventilation: Outside of normal ventilation, not normally required.

Other Protective Equipment and/or Hygienic Practices: None

Special Precautions

Precautions for Handling or Storage: Protect from high heat. Avoid making dust.

Other Precautions: None

The information contained in this MSDS is based on data considered accurate; however, no warranty is expressed or implied regarding the accuracy of these data or the results to be obtained from the use thereof. Vendor assumes no responsibility for injury to vendee or third person party proximately caused by the product if reasonable safety procedures are not adhered to as stipulated in the MSDS. Furthermore, vendor assumes no responsibility for injury to vendee or third person party proximately caused by abnormal use of the product even if reasonable safety procedures are followed. Additionally, vendee assumes the risk of his use of the product.

Preparation Date: November 25, 1997

OKIPAGE 10i User's Guide

Free Manuals Download Website

<http://myh66.com>

<http://usermanuals.us>

<http://www.somanuals.com>

<http://www.4manuals.cc>

<http://www.manual-lib.com>

<http://www.404manual.com>

<http://www.luxmanual.com>

<http://aubethermostatmanual.com>

Golf course search by state

<http://golfingnear.com>

Email search by domain

<http://emailbydomain.com>

Auto manuals search

<http://auto.somanuals.com>

TV manuals search

<http://tv.somanuals.com>