

# OLYMPUS®

## DIGITAL CAMERA

# E-PL2

## Instruction Manual

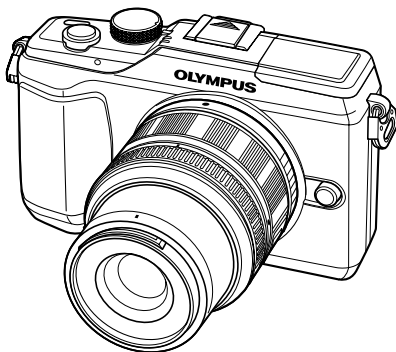

### Basic guide

### Quick task index

### Table of Contents

1. Basic photography/frequently-used options
  2. Other shooting options
  3. Flash shooting
  4. Shooting and viewing movies
  5. Playback options
  6. Sending and receiving images
  7. Using OLYMPUS Viewer 2/[ib]
  8. Printing pictures
  9. Camera setup
  10. Customizing camera settings
  11. Information
  12. SAFETY PRECAUTIONS
- Index

- Thank you for purchasing an Olympus digital camera. Before you start to use your new camera, please read these instructions carefully to enjoy optimum performance and a longer service life. Keep this manual in a safe place for future reference.
- We recommend that you take test shots to get accustomed to your camera before taking important photographs.
- The screen and camera illustrations shown in this manual were produced during the development stages and may differ from the actual product.
- The contents in this manual are based on firmware version 1.0 for this camera. If there are additions and/or modifications of functions due to firmware update for the camera, the contents will differ. For the latest information, please visit the Olympus website.

## Unpack the box contents

The following items are included with the camera.  
If anything is missing or damaged, contact the dealer from whom you purchased the camera.

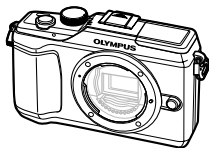

Camera



Body cap



Strap

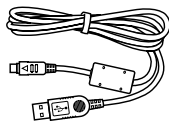

USB cable  
CB-USB6

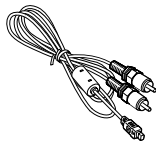

AV cable  
(Monaural)  
CB-AVC3



Lithium ion battery  
BLS-5

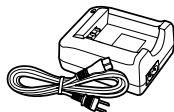

Lithium ion charger  
BCS-5

- Computer software CD-ROM
- Instruction manual
- Warranty card

### Attaching the strap

**1** Thread the strap in the direction of the arrows.

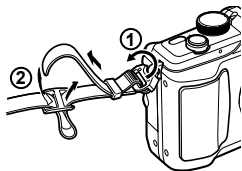



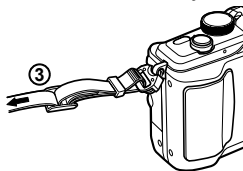

**2** Lastly, pull the strap tight making sure that it is fastened securely.



- Attach the other end of the strap to the other eyelet in the same way.

### Indications used in this manual

The following symbols are used throughout this manual.

 <b>Caution</b>	Important information on factors which may lead to a malfunction or operational problems. Also warns of operations that should be absolutely avoided.
 <b>Notes</b>	Points to note when using the camera.
 <b>Tips</b>	Useful information and hints that will help you get the most out of your camera.
	Reference pages describing details or related information.

# Charging and inserting the battery

## 1 Charging the battery.

### Charging indicator

Amber light: Charging in progress

Off: Charging complete  
(Charging time: Up to approximately 3 hours 30 minutes)

Amber blinking: Charging error

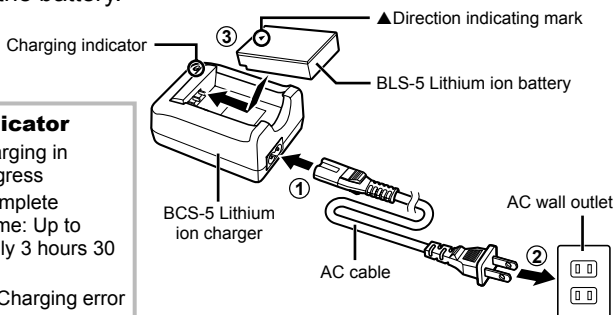

## 2 Loading the battery.

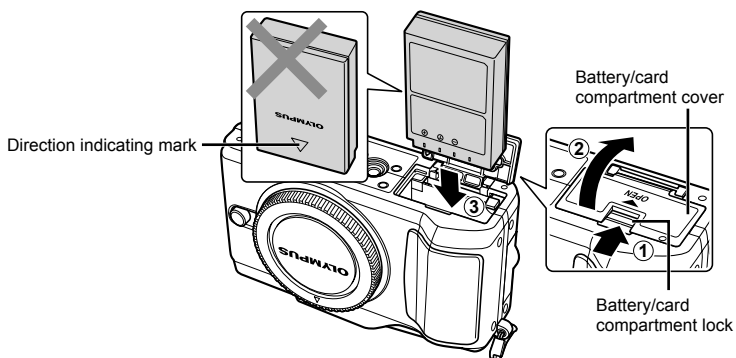

### Removing the battery

Turn off the camera before opening or closing the battery/card compartment cover.

To remove the battery, first push the battery lock knob in the direction of the arrow and then remove.

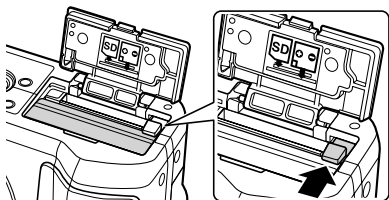

### Notes

- It is recommended to set aside a backup battery for prolonged shooting in case the battery in use drains.

# Inserting and removing cards

## 1 Loading the card.

- Insert the SD/SDHC/SDXC card (referred to as “card” in these instructions) until it locks in place.  
☞ “Card basics” (P. 96)

### ⚠ Caution

- Turn off the camera before loading or removing the card.

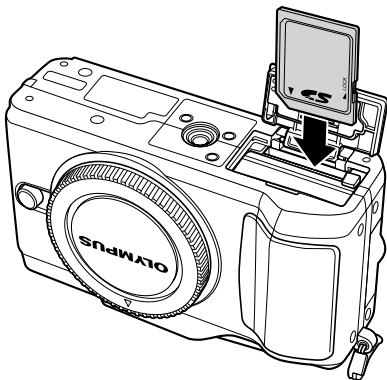

## Removing the card

Press the inserted card lightly and it will be ejected. Pull out the card.

### ⚠ Caution

- Do not remove the battery or card while the card write indicator (P. 22) is displayed.

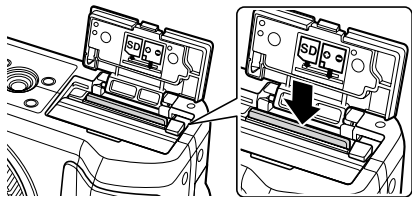

## 2 Closing the battery/card compartment cover.

- Close the cover until you hear a click.

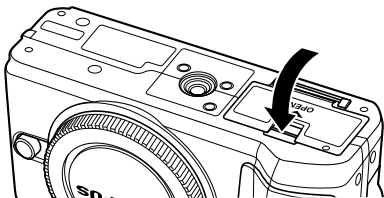

### ⚠ Caution

- Close the battery/card compartment cover when using the camera.

# Attaching a lens to the camera

- 1 Remove the body cap from the camera and the rear cap from the lens.

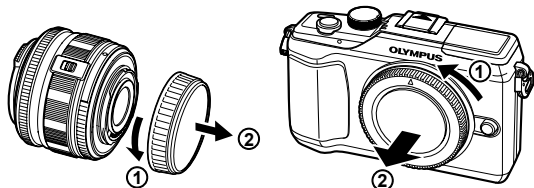

- 2 Attach a lens to the camera.

## ⚠ Caution

- Make sure the camera is turned off.
- Do not press the lens release button.
- Do not touch internal portions of the camera.

- Align the lens attachment mark (red) on the camera with the alignment mark (red) on the lens, then insert the lens into the camera's body.
- Rotate the lens in the direction indicated by the arrow until you hear it click.

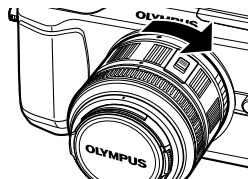
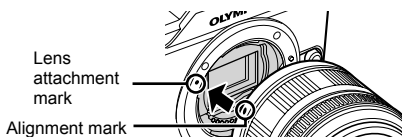

- 3 Remove the lens cap.

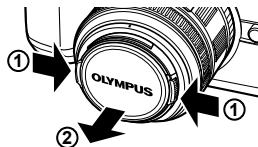

## Removing the lens from the camera

While pressing the lens release button, rotate the lens in the direction of the arrow.

👉 "Interchangeable lenses" (P. 98)

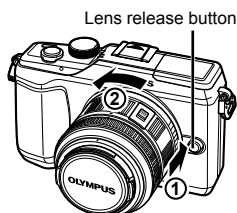

# Power on

## 1 Press the **ON/OFF** button to turn on the camera.

- When the camera is turned on, the (blue) power lamp will light and the monitor will turn on.
- When the camera is turned on, dust reduction will be performed to remove dust from the surface of the image sensor filter.
- To turn off the power, press the **ON/OFF** button again.

## 2 Set the mode dial to **FAUTO**.

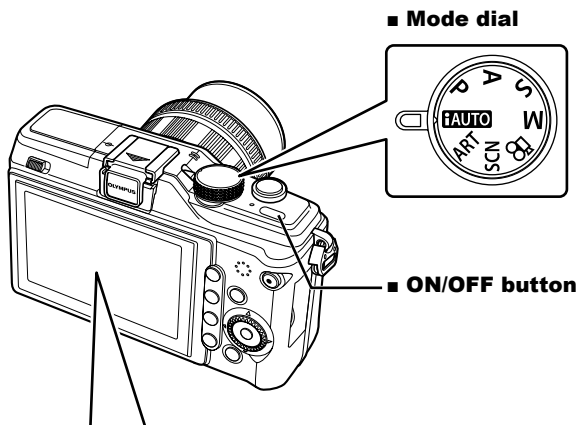

### ■ LCD monitor

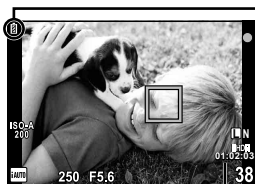

### Battery level

- (green): Camera ready to shoot.  
Displayed for about 10 seconds after the camera is turned on.
- (green): Low battery
- (blinks red): Charge the battery

### Number of storable still pictures

### Available recording time

# Setting the date/time

Date and time information is recorded on the card together with the images. The file name is also included with the date and time information. Be sure to set the correct date and time before using the camera.

## 1 Display the menus.

- Press the **MENU** button to display the menus.

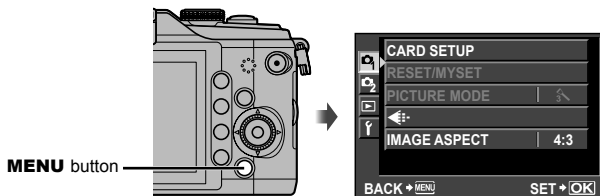

## 2 Select [f] in the [f] (setup) tab.

- Use  $\Delta$   $\nabla$  to select [f] and press  $\triangleright$ .
- Select [f] and press  $\triangleright$ .



## 3 Set the date and time.

- Use  $\triangleleft$   $\triangleright$  to select items.
- Use  $\Delta$   $\nabla$  to change the selected item.
- Use  $\Delta$   $\nabla$  to select the date format.

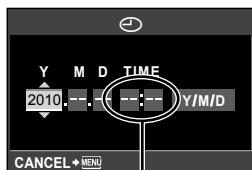

The time is displayed using a 24-hour clock.

## 4 Save settings and exit.

- Press **OK** to set the camera clock and exit to the main menu.
- Press the **MENU** button to exit the menus.

# Names of parts

## Camera

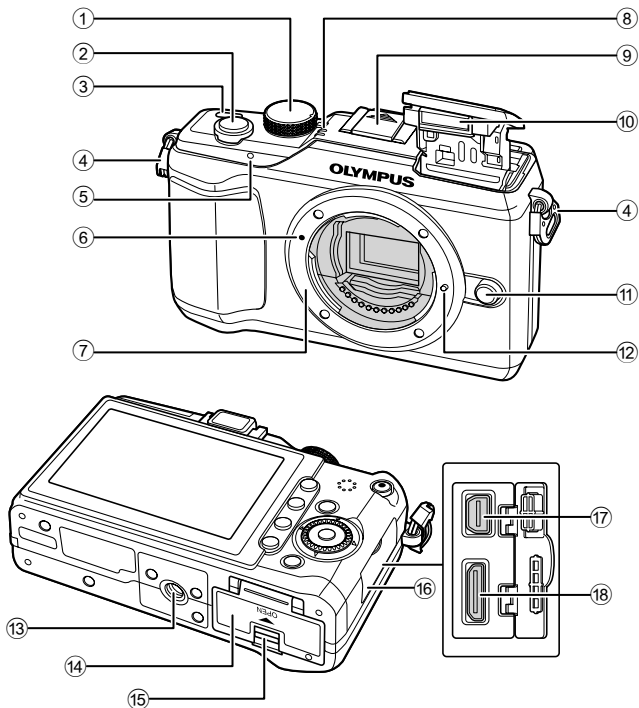

- |   |  |
|---|--|
| ① Mode dial..... P. 6, 10                                   | ⑩ Built-in flash..... P. 56                    |
| ② Shutter button ..... P. 11, 12, 35, 88                    | ⑪ Lens release button ..... P. 5               |
| ③ <b>ON/OFF</b> button ..... P. 6                           | ⑫ Lens lock pin                                |
| ④ Strap eyelet..... P. 2                                    | ⑬ Tripod socket                                |
| ⑤ Self-timer lamp..... P. 46                                | ⑭ Battery/card compartment cover<br>..... P. 3 |
| ⑥ Lens attachment mark ..... P. 5                           | ⑮ Battery/card compartment lock .... P. 3      |
| ⑦ Mount (Remove the body cap before<br>attaching the lens.) | ⑯ Connector cover                              |
| ⑧ Microphone ..... P. 59, 65                                | ⑰ Multi-connector..... P. 66, 70, 74           |
| ⑨ Hot shoe cover  | ⑱ HDMI mini-connector (type C).... P. 66       |



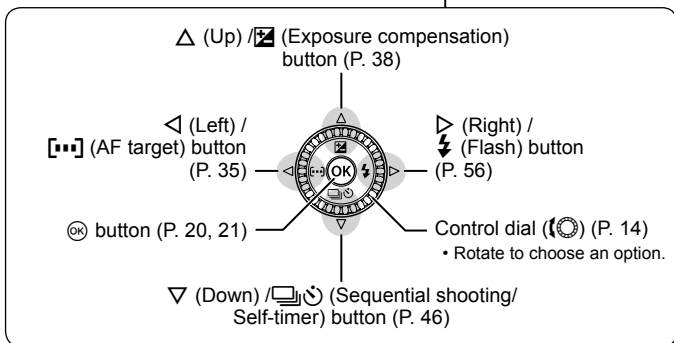
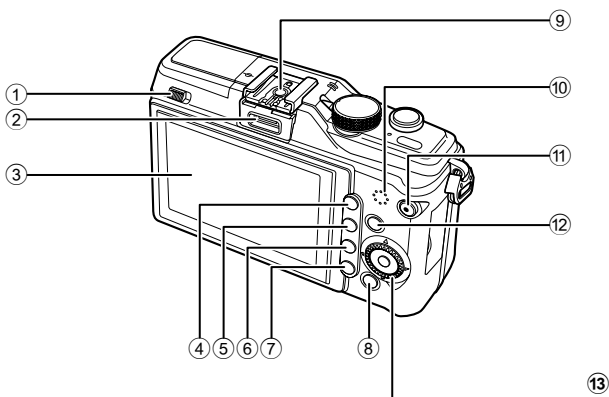

- |  |   |
|--|---|
| ① Flash switch ..... P. 56   | ⑨ Hot shoe..... P. 103  |
| ② Accessory port   | ⑩ Speaker   |
| ③ LCD monitor ..... P. 22, 23                                      | ⑪ [Movie] / [Protect] button<br>..... P. 11, 13, 58/P. 60, 64         |
| ④ Q button..... P. 31, 36, 61                                      | ⑫ <b>INFO</b> (Information display) button<br>..... P. 22, 30, 31, 32 |
| ⑤ <b>Fn</b> / [Exposure compensation] button ..... P. 86/P. 60, 61 | ⑬ Arrow pad<br>Control dial (P. 14)..... P. 14, 49, 50, 51            |
| ⑥ [Playback] button ..... P. 14, 60                                |   |
| ⑦ [Erase] button..... P. 15, 64                                    |   |
| ⑧ <b>MENU</b> button..... P. 21                                    |   |

# Camera controls

## Mode dial

Use the mode dial to select the shooting mode. After choosing the shooting mode, use the shutter button to take photographs and the  button to shoot movies.

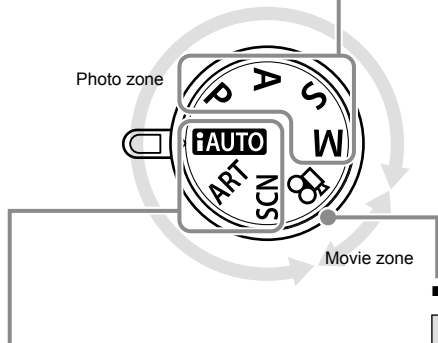
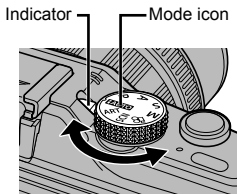

### ■ Advanced shooting modes

<b>P</b>	Program shooting (P. 48)
<b>A</b>	Aperture priority shooting (P. 49)
<b>S</b>	Shutter priority shooting (P. 50)
<b>M</b>	Manual shooting (P. 51)

- For more advanced shooting and greater creative control, you can set the aperture value and shutter speed.
- The settings made in the advanced shooting modes are retained even if the camera is turned off.

### ■ Movie mode

	Movie (P. 58)
---	---------------

### ■ Easy shooting modes

<b>iAUTO</b>	iAUTO (P. 18)
<b>ART</b>	Art filter (P. 16)
<b>SCN</b>	Scene (P. 17)



- If **iAUTO** is selected, the camera automatically optimizes settings to suit the subject.
- Select **ART** or **SCN** options according to your subject or creative intent. The camera optimizes settings automatically.
- When rotating the mode dial or turning off the power in the easy shooting modes, functions with changes made to their settings are restored to the factory default settings.

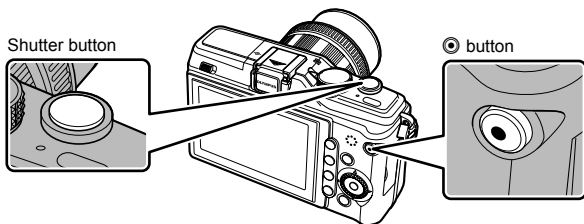

### Tips

- Resetting camera settings:  "Restoring default or custom settings" (P. 33)



Mode	Photos: shutter button	Movies:  button
<b>P</b>	Aperture and shutter speed are automatically adjusted for optimal results.	The camera automatically adjusts settings and records a movie.
<b>A</b>	You control aperture.	
<b>S</b>	You control shutter speed.	
<b>M</b>	You control aperture and shutter speed.	
<b>TAUTO</b>	A full auto mode in which the camera automatically optimizes settings for the current scene.	
<b>ART</b>	Select an art filter.	
<b>SCN</b>	Select a scene.	
	Photographs are recorded at the settings selected in [  MODE].	Shoot movies using art filter or aperture and shutter speed effects.

### ■ Taking photographs during movie recording

- To take a photograph during movie recording, press the shutter button. Press the  button to end recording. Three files will be recorded to the memory card: the movie footage preceding the photograph, the photograph itself, and the movie footage following the photograph.
- Only one photograph can be taken at a time during movie recording; the self-timer and flash can not be used.

### Caution

- Image size and quality for photographs are independent of movie frame size.
- The autofocus and metering used in movie mode may differ from that used to take photographs.
- The  button can not be used to record movies in the following instances: shutter button pressed halfway/BULB/Sequential shooting/PANORAMA/multiple exposure, etc (still photography also ends).

# Taking photographs/shooting movies

## 1 Frame the shot.

- Keep your fingers and the strap away from the lens.

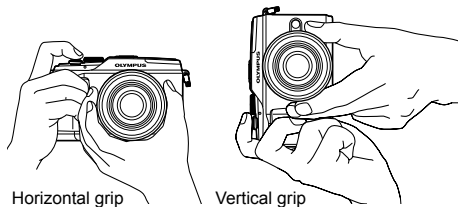

### Using lenses with an UNLOCK switch

Retractable lenses with an UNLOCK switch can not be used while retracted.

Turn the zoom ring in the direction of arrow (1) to extend the lens (2).

To store, turn the zoom ring in the direction of arrow (4) while sliding the UNLOCK switch (3).

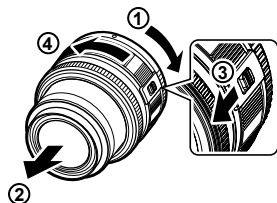

## 2 Adjust the focus.

- Lightly press the shutter button down to the first position (press the shutter button halfway).

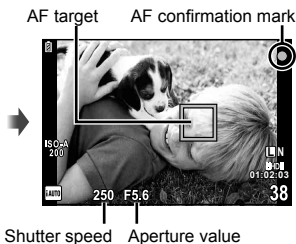
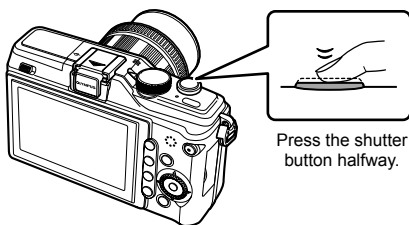

- The AF confirmation mark (● or ○) will be displayed and focus will lock.

●	Lenses that supports Hi-Speed Imager AF*
○	Lenses with other Four Thirds mounts

\* Visit our website for more information.

- The shutter speed and aperture value that have been set automatically by the camera are displayed.

### Pressing the shutter button halfway and all the way down

The shutter button has two positions. The act of lightly pressing the shutter button to the first position and holding it there is called “pressing the shutter button halfway,” that of pressing it all the way down to the second position “pressing the shutter button all (or the rest of) the way down.”



## 3 Release the shutter.



### Taking photographs

Press the shutter button all the way (fully).

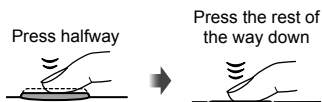
- The shutter sounds and the picture is taken.



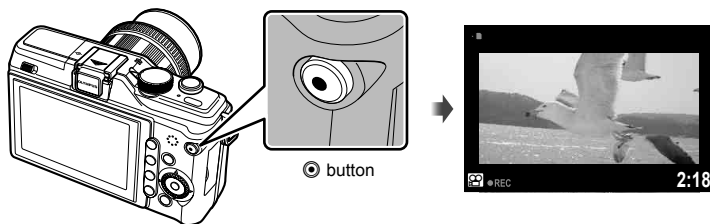

### Recording movies

Release the shutter button and press the  button to begin recording. Press the  button again to end recording.



### Tips

- If no operations are performed for a minute, the camera enters “sleep” (stand-by) mode to turn off the monitor and to cancel all actions. The camera activates again when you touch any button (the shutter button,  button, etc.). [SLEEP]:  “Custom menu” (P. 78)

### Caution

- Bright light sources appear black when framed in the monitor but are recorded normally in the final picture.
- If the camera is used for extended periods, the temperature of the image pickup device will rise and noise and colored fog may appear in images recorded at high ISO sensitivities. Choose a lower ISO sensitivity or turn the camera off for a short period.

# Playback/Erasing

## Single-frame playback

Press the  button to display your most recent photograph or movie.

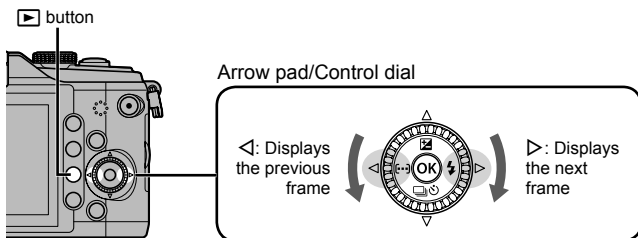

### ■ Close-up playback

- To zoom in on the image currently displayed in single-frame playback, press the **Q** button. Keep pressing the button to zoom in up to 14x. Press  to return to single-frame playback.

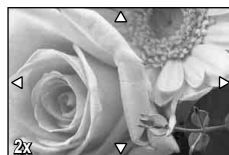

### ■ Index display/Calendar display

- To view multiple pictures, press the  button. To start calendar playback, press the  button repeatedly.
- Press the **Q** button to view the currently selected picture full frame.



## Movie playback

Select a movie and press **OK** to display the playback menu. Select [MOVIE PLAY] and press **OK** to begin playback.

- To interrupt movie playback, press **MENU**.



## Volume

Volume can be adjusted by pressing **Δ** or **∇** during single-frame and movie playback.



## Erasing images

Display a image you want to delete and press **🗑️**. Select [YES] and press **OK**.

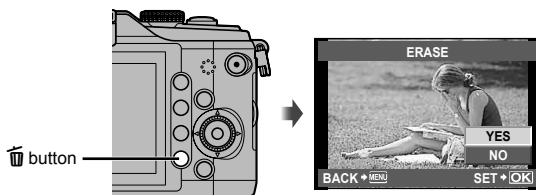

## Protecting images

Protect images from accidental deletion. Display an image you wish to protect and press the **🔒** button; a **🔒** (protect) icon will appear on the image. Press the **🔒** button again to remove protection.

### ⚠️ Caution

- Formatting the card erases all images even if they have been protected.



# Using art filters

## 1 Rotate the mode dial to **ART**.

- A menu of art filters will be displayed. Select a filter using  $\Delta$ / $\nabla$ .

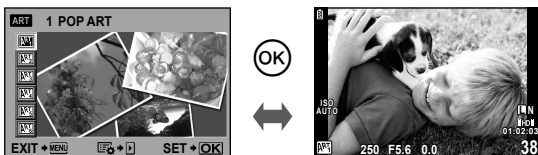

- Press  $\text{OK}$  or press the shutter button halfway to display the view through the lens in the monitor. Press  $\text{OK}$  to return to the art filter menu.

## ■ Types of art filters

POP ART	PIN HOLE
SOFT FOCUS	DIORAMA
GRAINY FILM	DRAMATIC TONE

## 2 Shoot.

- To choose a different setting, press  $\text{OK}$  to display the art filter menu.

### Art effects

Art filters can be modified and effects can be added. Pressing  $\triangleright$  in the art filter menu displays additional options.

### Modifying filters

Option I is the original filter, while options II and on add effects that modify the original filter.

### Adding effects

Soft focus, pin-hole, frames (the effects available vary with the selected filter).

### ⚠ Caution

- If [RAW] is currently selected for image quality, image quality will automatically be set to [L/N+RAW]. The art filter will be applied to the JPEG copy only.
- Depending on the subject, tone transitions may be ragged, the effect may be less noticeable, or the image may become more "grainy."
- Some effects may not be visible in live view or during movie recording.



# Shooting in scene mode

## 1 Rotate the mode dial to **SCN**.

- A menu of scene menu will be displayed. Select a scene using  $\Delta$   $\nabla$ .

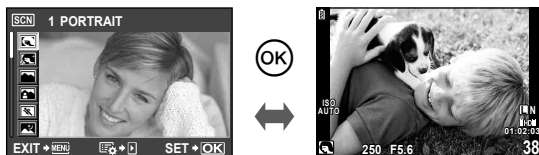

- Press  $\odot$  or press the shutter button halfway to display the view through the lens in the monitor. Press  $\odot$  to return to the scene menu.

### ■ Types of scene modes

- |                    |                  |
|--------------------|------------------|
| PORTRAIT           | MACRO            |
| e-PORTRAIT         | NATURE MACRO     |
| LANDSCAPE          | CANDLE           |
| LANDSCAPE+PORTRAIT | SUNSET           |
| SPORT              | DOCUMENTS        |
| NIGHT SCENE        | PANORAMA (P. 52) |
| NIGHT+PORTRAIT     | FIREWORKS        |
| CHILDREN           | BEACH & SNOW     |
| HI                 | FISHEYE EFFECT   |
| LOW                | WIDE-ANGLE       |
| DIS MODE           | MACRO            |

## 2 Shoot.

- To choose a different setting, press  $\odot$  to display the scene menu.

### ! Caution

- In [e-PORTRAIT] mode, two images are recorded: an unmodified image and a second image to which [e-PORTRAIT] effects have been applied. The unmodified image is recorded using the option currently selected for image quality, the modified copy at an image quality of JPEG (M-quality (2560 × 1920)).
- [ FISHEYE EFFECT], [ WIDE-ANGLE], and [ MACRO] are for use with optional lens attachments.

## Using live guides

Live guides are available in iAUTO (FAUTO) mode. While iAUTO is a full auto mode, live guides make it easy to access a variety of advanced photographic techniques.

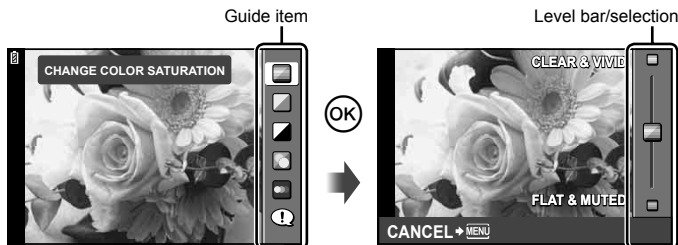

Guide item	Level bar/selection	Affects
CHANGE COLOR SATURATION*	CLEAR & VIVID ↔ FLAT & MUTED	Saturation, contrast, gradation, etc.
CHANGE COLOR IMAGE*	WARM ↔ COOL	Color temperature, gradation, etc.
CHANGE BRIGHTNESS*	BRIGHT ↔ DARK	Exposure compensation, gradation, etc.
BLUR BACKGROUND*	BLUR ↔ SHARP	Aperture, live preview, etc.
EXPRESS MOTIONS*	BLURRED MOTION ↔ STOP MOTION	Shutter speed (1/2 s – fastest speed), frame rate, etc.
SHOOTING TIPS	<ul style="list-style-type: none"> <li>• TIPS FOR CHILD PHOTO</li> <li>• TIPS FOR PET PHOTO</li> <li>• TIPS FOR FLOWER PHOTO</li> <li>• TIPS FOR CUISINE PHOTO</li> <li>• TIPS FOR FRAMING</li> <li>• TIPS WITH ACCESSORY</li> </ul>	—

\* Monitor frame rate slows.

- 1 Set the mode dial to **FAUTO**.
- 2 After pressing **OK** to display the live guide, use the **Δ** **▽** buttons on the arrow pad to highlight an item and press **OK** to select.



- 3 Use **Δ** **▽** on the arrow pad to choose the level.

- If [SHOOTING TIPS] is selected, highlight an item and press **OK** to view a description.
- Press the shutter button halfway to select.
- The effect of the selected level is visible in the display. If [BLUR BACKGROUND] or [EXPRESS MOTIONS] is selected, the display will return to normal, but the selected effect will be visible in the final photograph.

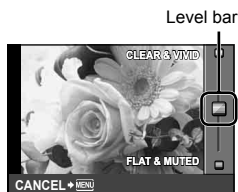

- 4 Shoot.

- Press the shutter button to shoot.
- To clear the live guide from the display, press the **MENU** button.

#### **!** Caution

- If [RAW] is currently selected for image quality, image quality will automatically be set to [L/N+RAW].
- Live guide settings are not applied to the RAW copy.
- Pictures may appear grainy at some live guide setting levels.
- Changes to live guide setting levels may not be visible in the monitor.
- The flash can not be used with the live guide.
- Changes to live guide options cancel previous changes.
- Choosing live guide settings that exceed the limits of the camera exposure meters may result in pictures that are over- or under-exposed.

# Using live control

The live control can be used to adjust settings in **P**, **S**, **A**, **M**, and  modes. Using live control allows you to preview the effects of different settings in the monitor. A custom setting is available that allows the live control to be used in other modes (P. 78).



## ■ Available settings

Picture mode <sup>*1</sup> .....	P. 42	Record mode .....	P. 44
Scene mode <sup>*2</sup> .....	P. 17	Flash mode <sup>*1*2</sup> .....	P. 56
Art filter mode <sup>*2</sup> .....	P. 16	Flash intensity control <sup>*1*2</sup> .....	P. 57
 mode <sup>*3</sup> .....	P. 58	Metering mode <sup>*1*2</sup> .....	P. 39
White balance .....	P. 40	AF mode .....	P. 34
Sequential shooting/self-timer .....	P. 46	Face priority <sup>*1*2</sup> .....	P. 37
Image stabilizer .....	P. 47	Movie sound record .....	P. 59
Aspect ratio <sup>*1*2</sup> .....	P. 45	ISO sensitivity .....	P. 45





\*1 **P**, **A**, **S**, **M** and **AUTO** modes only.

\*2 **ART** and **SCN** only.

\*3  mode only.

**1** Press  to display the live control.

- To hide the live control, press  again.

**2** Use the   buttons on the arrow pad to select settings, use   to change the selected setting, and press .

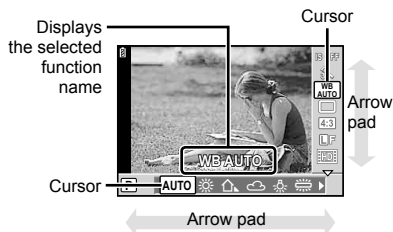

- The selected settings take effect automatically if no operations are performed for about 8 seconds.



## ! Caution

- Some items are not available in some shooting modes.

## 💡 Tips

- For information on displaying or hiding the live control.  **CONTROL SETTINGS**:  "Custom menu" (P. 78)

# Using the menus

- 1 Press the **MENU** button to display the menus.

**Menus**

- Preliminary and basic shooting options
- Advanced shooting options
- Playback and retouch options
- Custom menu\*
- Accessory port menu\*
- Camera setup (e.g., date and language)

\* Not displayed at default settings.

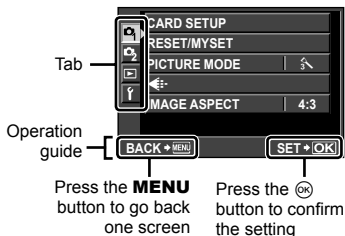

- 2 Use  $\Delta$   $\nabla$  to select a tab and press **OK**.
- 3 Select an item using  $\Delta$   $\nabla$  and press **OK** to display options for the selected item.

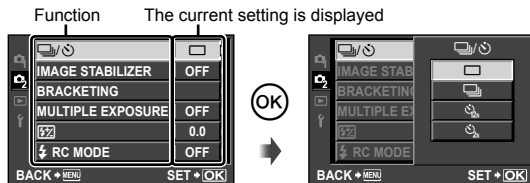

- 4 Use  $\Delta$   $\nabla$  to highlight an option and press **OK** to select.
  - Press the **MENU** button repeatedly to exit the menu.

## Notes

- For details on the functions that can be set with the menu, refer to “Menu directory” (P. 108).

## Tips

- Camera settings can be customized to your shooting style: Use the custom menus to customize camera settings to your own goals or taste. Custom menus are not displayed by default, and you will need to display the menus before proceeding.
  - “Custom menu” (P. 78)
- Using accessory port devices: Settings for the EVF and OLYMPUS PENPAL accessories are accessed from the accessory port menu. This menu is not displayed by default, and you will need to display it before proceeding.
  - “Accessory port menu options” (P. 90)

# Information displayed in the monitor

## Shooting

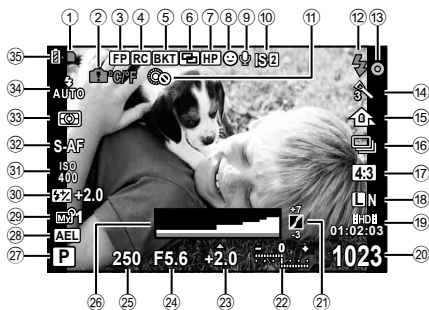

- |   |   |
|---|---|
| ① Card write indicator ..... P. 4   | ⑳ Number of storable still pictures ..... P. 107    |
| ② Internal temperature warning<br>°C/F ..... P. 94                                      | ㉑ Tone control ..... P. 32, 38                      |
| ③ Super FP flash  ..... P. 105  | ㉒ Top: Flash intensity control ..... P. 57          |
| ④ RC mode ..... P. 89   | Bottom: Exposure compensation indicator ..... P. 38 |
| ⑤ Auto bracket  ..... P. 54   | ㉓ Exposure compensation value... P. 38              |
| ⑥ Multiple exposure  ..... P. 53  | ㉔ Aperture value ..... P. 48–51                     |
| ⑦ Home position  ..... P. 35, 79  | ㉕ Shutter speed ..... P. 48–51                      |
| ⑧ Face priority  ..... P. 37, 81  | ㉖ Histogram ..... P. 30, 31                         |
| ⑨ Movie sound ..... P. 59   | ㉗ Shooting mode ..... P. 10, 48–51                  |
| ⑩ Image stabilizer    ..... P. 47   | ㉘ AE Lock  ..... P. 39                              |
| ⑪  ..... P. 80  | ㉙ MYSET ..... P. 33                                 |
| ⑫ Flash ..... P. 56<br>(blinks: charging in progress,<br>lights up: charging completed) | ㉚ Flash intensity control ..... P. 57               |
| ⑬ AF confirmation mark ..... P. 12  | ㉛ ISO sensitivity ..... P. 45                       |
| ⑭ Art filter ..... P. 16  | ㉜ AF mode ..... P. 34                               |
| Scene mode ..... P. 17  | ㉝ Metering mode ..... P. 39                         |
| Picture mode ..... P. 42  | ㉞ Flash mode ..... P. 56                            |
| ⑮ White balance ..... P. 40   | ㉟ Battery check                                     |
| ⑯ Sequential shooting/self-timer .... P. 46   | Lit up (green) (ready for use)                      |
| ⑰ Aspect ratio ..... P. 45  | Lit up (green) (Battery is running low)             |
| ⑱ Record mode (still images) ..... P. 44  | Blinks (red) (charging required)                    |
| Record mode (movies)/<br>Available recording time ..... P. 44                           |   |

You can switch the monitor display using the **INFO** button.

“Switching the information display” (P. 30)

## Playback

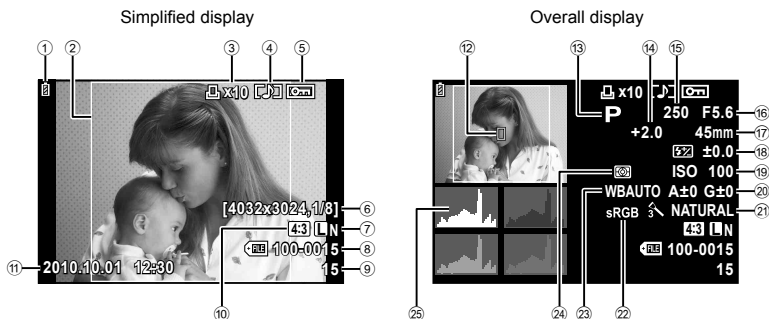

- |   |  |
|---|--|
| ① Battery check                                     | ⑭ Exposure compensation ..... P. 38  |
| ② Aspect border ..... P. 45                         | ⑮ Shutter speed ..... P. 48–51   |
| ③ Print reservation<br>Number of prints ..... P. 73 | ⑯ Aperture value ..... P. 48–51  |
| ④ Sound record ..... P. 65                          | ⑰ Focal length ..... P. 98<br>(The focal length is displayed in 1 mm units.) |
| ⑤ Protect ..... P. 15                               | ⑱ Flash intensity control ..... P. 57  |
| ⑥ Pixel count, compression rate .... P. 44          | ⑲ ISO sensitivity ..... P. 45  |
| ⑦ Record mode ..... P. 44                           | ⑳ White balance compensation .... P. 41                                      |
| ⑧ File number ..... P. 73                           | ㉑ Picture mode ..... P. 42   |
| ⑨ Frame number ..... P. 73                          | ㉒ Color space ..... P. 82  |
| ⑩ Aspect ratio ..... P. 45, 63                      | ㉓ White balance ..... P. 40  |
| ⑪ Date and time ..... P. 7                          | ㉔ Metering mode ..... P. 39  |
| ⑫ AF target ..... P. 35                             | ㉕ Histogram ..... P. 31  |
| ⑬ Shooting mode ..... P. 10, 48–51                  |  |

You can switch the monitor display using the **INFO** button.

 “Displaying information during playback” (P. 31)

# Quick task index

## Shooting



Taking pictures with automatic settings	▶ iAUTO ( <b>HAUTO</b> )	10, 11
Easy photography with special effects	▶ Art filter ( <b>ART</b> )	16
Choosing an aspect ratio	▶ Aspect ratio	45
Quickly matching settings to the scene	▶ Scene ( <b>SCN</b> )	17
Pro-level photography made simple	▶ Live guide	18
Taking pictures so that whites come out white and blacks come out black	▶ Exposure compensation	38
	▶ HIGH KEY/LOW KEY	43
Taking pictures with a blurred background	▶ Live guide	18
	▶ Aperture priority shooting	49
Taking pictures that stop the subject in motion or convey a sense of motion	▶ Live guide	18
	▶ Shutter priority shooting	50
Taking pictures with the correct color	▶ White balance	40
	▶ One-touch white balance	41
Processing pictures to match the subject/Taking monotone pictures	▶ PICTURE MODE	42
	▶ Art filter ( <b>ART</b> )	16
Focus/Focusing on one area	▶ AF target	35
	▶ Zoom frame AF/zoom AF	36
When the camera won't focus on your subject	▶ Focus lock	35
Focusing on a small spot in the frame/confirming focus before shooting	▶ Zoom frame AF/zoom AF	36
Recomposing photographs after focusing	▶ Focus lock	35
	▶ C-AF+TR (AF Tracking)	34
Turning off the beep speaker	▶ ■)) (Beep sound)	81
Disabling the flash/taking photos without the flash	▶ Flash	56
	▶ ISO/DIS MODE	45/17
	▶ IMAGE STABILIZER	47
Reducing camera shake	▶ ANTI-SHOCK	82
	▶ Self-timer	46
	▶ Remote cable	100
Taking pictures of a subject against backlight	▶ Flash shooting	56
	▶ GRADATION (PICTURE MODE)	43
Photographing fireworks	▶ Bulb shooting	51
	▶ Scene ( <b>SCN</b> )	17
Reducing image noise (mottling)	▶ NOISE REDUCT.	82



Taking pictures without white subjects appearing too white or black subjects appearing too dark	▶ GRADATION (PICTURE MODE)	43
	▶ Histogram/Exposure compensation	31/38
	▶ Tone control	32
Optimizing the LCD monitor/adjusting monitor hue	▶ Monitor brightness adjustment	77
	▶ LIVE VIEW BOOST	81
Checking set effect before taking a picture	▶ Multi view display	30, 38
	▶ Preview function	49
	▶ TEST PICTURE	86
Taking pictures while checking the level of the camera	▶ DISPLAYED GRID (☒/INFO SETTINGS)	80
Shooting with deliberate composition	▶ DISPLAYED GRID (☒/INFO SETTINGS)	80
Zooming in on photos to check focus	▶ AUTO (▶) (REC VIEW)	77
	▶ mode2 (▶) CLOSE UP MODE)	61
Self-portraits	▶ Self-timer	46
Sequential shooting	▶ Sequential shooting	46
Extending the useful life of the battery	▶ SLEEP	81
Increasing the number of pictures that can be taken	▶ Record mode	44

## Playback/Retouch

Viewing images on a TV	▶ Playback on TV	66
Viewing slideshows with background music	▶ Slideshow	62
Brightening shadows	▶ SHADOW ADJ (JPEG EDIT)	63
Dealing with red-eye	▶ REDEYE FIX (JPEG EDIT)	63
Printing made easy	▶ Direct printing	74
Commercial prints	▶ Creating a print order	73
Simple photo sharing	▶ OLYMPUS PENPAL	68

## Camera Settings

Restoring default settings	▶ RESET	33
Saving the settings	▶ MYSET	33
Changing the menu display language	▶ 	77

# Table of Contents

<b>Basic guide</b>	<b>3</b>	<b>Choosing shooting controls</b> .....	<b>30</b>
<b>Preparations for shooting</b> .....	<b>3</b>	<b>Displaying information during playback</b> .....	<b>31</b>
Charging and inserting the battery .....	3	<b>Other uses for the INFO button</b> .....	<b>32</b>
Inserting and removing cards .....	4	One-touch white balance .....	32
Attaching a lens to the camera .....	5	Color temperature .....	32
Power on .....	6	Playback zoom .....	32
Setting the date/time .....	7	Tone control .....	32
<b>Names of parts and functions</b> .....	<b>8</b>	Focal length .....	32
Names of parts .....	8	<b>Restoring default or custom settings</b> .....	<b>33</b>
Camera .....	8	Using reset settings .....	33
Camera controls .....	10	Using MYSET .....	33
Mode dial .....	10	Saving MYSET .....	33
<b>Basic operations</b> .....	<b>12</b>	<b>Choosing a focus mode (AF mode)</b> .....	<b>34</b>
Taking photographs/shooting movies .....	12	<b>Choosing a focus target (AF target)</b> .....	<b>35</b>
Playback/Erasing .....	14	Focus lock .....	35
Single-frame playback .....	14	Quick AF target selection .....	35
Movie playback .....	15	Toggling quickly between AF and MF .....	35
Volume .....	15	<b>Zoom frame AF/zoom AF</b> .....	<b>36</b>
Erasing images .....	15	<b>Face priority AF/pupil detection AF</b> .....	<b>37</b>
Protecting images .....	15	Taking pictures using face priority .....	37
Using art filters .....	16	<b>Controlling exposure (exposure compensation)</b> .....	<b>38</b>
Shooting in scene mode .....	17	Previewing the effects of exposure compensation and white balance .....	38
Using live guides .....	18	<b>Changing the brightness of highlights and shadows</b> .....	<b>38</b>
Using live control .....	20	<b>Choosing how the camera measures brightness (metering)</b> .....	<b>39</b>
Using the menus .....	21		
<b>Information displayed in the monitor</b> .....	<b>22</b>		
Shooting .....	22		
Playback .....	23		
<b>Quick task index</b>	<b>24</b>		
<b>Basic photography/frequently-used options</b>	<b>30</b>		
<b>Switching the information display</b> .....	<b>30</b>		

■ Exposure lock (AE lock) .....	39
■ Adjusting color (white balance) .....	40
White balance compensation .....	41
One-touch white balance .....	41
■ Processing options (picture mode) .....	42
■ Image quality (record mode) .....	44
Choosing a record mode .....	44
■ Setting the image aspect .....	45
■ ISO sensitivity .....	45
■ Sequential shooting/using the self timer .....	46
■ Reducing camera shake (the image stabilizer) .....	47
<b>Other shooting options</b> .....	<b>48</b>
■ “Point-and-shoot” photography (P program mode) .....	48
■ Choosing aperture (A aperture-priority mode) .....	49
■ Choosing shutter speed (S shutter-priority mode) .....	50
■ Choosing aperture and shutter speed (M manual mode) .....	51
Choosing when the exposure ends (bulb) .....	51
■ Panoramas .....	52
Taking pictures for a panorama .....	52
■ Recording multiple exposures in a single image (multiple exposure) .....	53
■ Varying settings over a series of photographs (bracketing) .....	54

## Flash shooting 56

■ Using a flash (flash photography) .....	56
■ Adjusting flash output (Flash intensity control) .....	57
■ Using external flash units designated for use with this camera .....	57
■ Other external flash units .....	57

## Shooting and viewing movies 58

■ Changing the settings for movie recording .....	58
Adding effects to a movie .....	58
Movie sound options (recording sound with movies) .....	59
■ Viewing movies .....	59

## Playback options 60

■ Single-frame playback .....	60
■ Index display/calendar display .....	60
■ Playback zoom (close-up playback) .....	61
■ Rotate .....	62
■ Slideshow .....	62
■ Editing still images .....	63
■ Selecting and protecting images .....	64
■ Erasing images .....	64
Erasing selected frames .....	64
All-frame erase .....	64
■ Image overlay .....	65
■ Audio recording .....	65
■ Viewing camera images on TV .....	66

# Table of Contents

## Sending and receiving images 68

- Sending images ..... 68
- Receiving images/  
adding a host ..... 68
- Editing the address book ..... 69
- Creating albums ..... 69

## Using OLYMPUS Viewer 2/ [ib] 70

- Windows ..... 70
- Macintosh ..... 71

- Copying pictures to a computer  
without OLYMPUS Viewer 2/  
[ib] ..... 72

## Printing pictures 73

- Print reservation (DPOF) ..... 73
  - Creating a print order ..... 73
  - Removing all or selected pictures  
from the print order ..... 74
- Direct printing (PictBridge) ..... 74
  - Easy printing ..... 75
  - Custom printing ..... 75

## Camera setup 77

- Setup Menu ..... 77
  - ⌚ (Date/time setting) ..... 77
  - 🗨️ (Changing the display  
language) ..... 77
  - 📺 (Monitor brightness  
adjustment) ..... 77
  - REC VIEW ..... 77
  - 🗨️/MENU DISPLAY ..... 77
  - FIRMWARE ..... 77

## Customizing camera settings 78

- Custom Menu ..... 78
  - Displaying the Custom Menu ..... 78
- Custom Menu options ..... 78
  - 📷 AF/MF ..... 78
  - 📷 BUTTON/DIAL ..... 79
  - 📷 RELEASE ..... 80
  - 📷 DISP/📷/PC ..... 80
  - 📷 EXP/📷/ISO ..... 81
  - 📷 ⚡ CUSTOM ..... 82
  - 📷 ⚡-/COLOR/WB ..... 82
  - 📷 RECORD/ERASE ..... 83
  - 📷 MOVIE ..... 85
  - 📷 📷 UTILITY ..... 85
  - AEL/AFL ..... 85
  - ▽ FUNCTION, ▷ FUNCTION  
..... 86
  - Fn FUNCTION, Ⓞ FUNCTION  
..... 86
- Using the super control panel... 87
- Recording movies with the  
shutter button ..... 88
  - Taking a photograph when  
recording ends ..... 88
- Wireless remote control flash  
photography ..... 89
- Accessory port menu options... 90
  - 📷 OLYMPUS PENPAL SHARE  
..... 90
  - 📷 OLYMPUS PENPAL ALBUM  
..... 90
  - 📷 ELECTRONIC VIEWFINDER  
..... 90

<b>Information</b>	<b>91</b>
Shooting tips and information .....	91
Error codes .....	93
Cleaning and storing the camera.....	95
Cleaning the camera .....	95
Storage .....	95
Cleaning and checking the image pickup device.....	95
Pixel mapping - Checking the image processing functions...	96
Card basics .....	96
Usable cards.....	96
Formatting the card .....	96
Battery and charger .....	97
Using your charger abroad .....	97
Interchangeable lenses.....	98
M.ZUIKO DIGITAL interchangeable lenses .....	98
M.ZUIKO DIGITAL lens specifications.....	99
Mount adapter.....	100
Four Thirds lens adapter (MMF-2).....	100
OM adapter (MF-2).....	100
Remote cable (RM-UC1).....	100
Lens attachments.....	101
MACRO ARM LIGHT (MAL-1) .....	101
Microphone set (SEMA-1) .....	101
Using electronic view finder (sold separately).....	102
Program line diagram (P mode) .....	103
Exposure warning display.....	103
Flash modes that can be set by shooting mode.....	104
Flash synchronization and shutter speed.....	104
Manual flash guide numbers for the built-in flash.....	104
Flash range .....	105
External flash shooting.....	105
Settings stored using MYSET .....	106
Record mode and file size/ number of storable still pictures .....	107
Menu directory.....	108
Specifications .....	112
<b>SAFETY PRECAUTIONS</b>	<b>114</b>
SAFETY PRECAUTIONS .....	114
<b>Index</b>	<b>120</b>

The **INFO** button can be used to choose the information and type of controls displayed during shooting.

## Switching the information display

Press the **INFO** button to choose the information displayed when shooting.

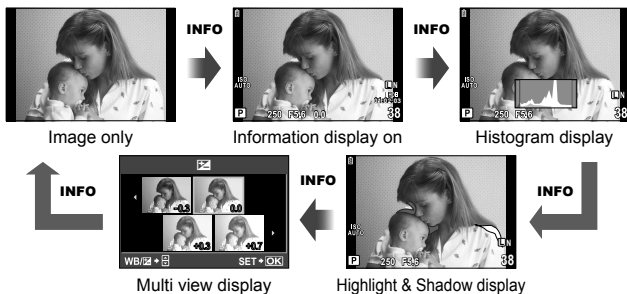

The multi-view ([MULTI VIEW]) and highlight and shadow displays ([HIGHLIGHT & SHADOW]) are available when enabled in the [INFO SETTINGS] menu. You can also opt to display a framing grid in the information display. See “Custom menu” (P. 78)

## Choosing shooting controls

Shooting options can be displayed by pressing **OK**. You can choose the types of display available using the [CONTROL SETTINGS] option in the custom menus (P. 78).

### ART/SCN

Art filter menu



### P/A/S/M

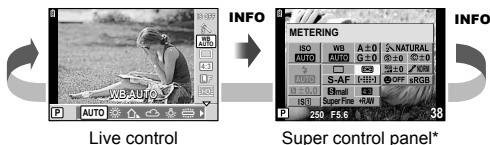

\* Can be displayed using [CONTROL SETTINGS].

## Displaying information during playback

The **INFO** button can be used to choose the information displayed during playback.

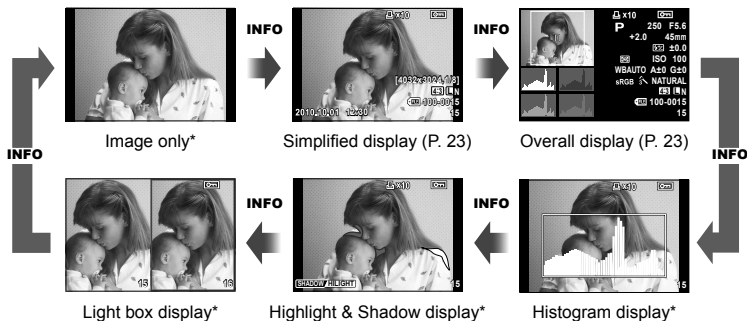

\* Can be displayed using [INFO]/INFO SETTINGS]. [INFO] “Custom menu” (P. 78)

### Histogram display

Display a histogram showing the distribution of brightness in the image. The horizontal axis gives the brightness, the vertical axis the number of pixels of each brightness in the image. Areas above the upper limit at shooting are displayed in red, those below the lower limit in blue, and the area metered using spot metering in green.

### Highlight & Shadow display

Areas above the upper limit of brightness for the image are shown in red, those below the lower limit in blue. [HISTOGRAM SETTINGS]: [INFO] “Custom menu” (P. 78)

### Light box display

Compare two images side-by-side. Press [OK] to select the image on the opposite side of the display. In addition to adjusting settings using [INFO]/INFO SETTINGS] in the custom menu, you will also have to select [mode2] for [CLOSE UP MODE].

[INFO] “Custom menu” (P. 78)

- The base image is displayed on the right. Use [LEFT] to select an image and press [OK] to move the image to the left. The image to be compared to the image on the left can be selected on the right. To choose a different base image, highlight the right frame and press [OK].
- Press [Q] to zoom in on the current image. You can zoom in or out by pressing **INFO** and using [UP] [DOWN].
- Use [UP] [DOWN] [LEFT] to view other areas of the picture. The image displayed changes each time the [Q] button is pressed.



## Other uses for the **INFO** button

### One-touch white balance

To view the one-touch white balance dialog, press the **INFO** button in the one-touch white balance menu (P. 40).



### Color temperature

To view the color temperature dialog, press the **INFO** button in the custom white balance menu (P. 40).

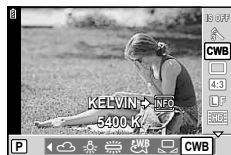

### Playback zoom

To zoom an image in or out, press the **Q** button to initiate playback zoom and then press the **INFO** button and use  $\Delta \nabla$ .

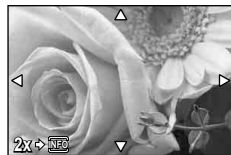

### Tone control

Exposure compensation, aperture, and shutter speed can be adjusted by pressing the  $\square$  button. The tone control dialog can be displayed by pressing the **INFO** button after pressing the  $\square$  button. You can then use  $\triangleleft \triangleright$  to choose the tone level.

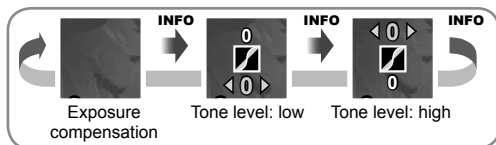

### Focal length

To choose a focal length for image stabilization, press the **INFO** button in the IS mode dialog and use  $\Delta \nabla \triangleleft \triangleright$  or the control dial.





## Restoring default or custom settings

Camera settings can be easily restored to one of three presets.

### **RESET** ([RESET/MYSET] > [RESET])

Restore default settings.

### **MYSET** ([RESET/MYSET] > [MYSET1]–[MYSET4])

Restore preselected settings for **P**, **A**, **S**, or **M** mode. The shooting mode does not change. Up to four sets of preselected settings can be stored.

### **Quick MYSET**

Preset settings are used only while the **Fn** button is pressed. Shooting mode is adjusted to the preset settings.

## Using reset settings

- 1 Select [RESET/MYSET] in shooting menu  (P. 108).
- 2 Select [RESET] and press the **OK** button.
- 3 Select [YES] and press the **OK** button.

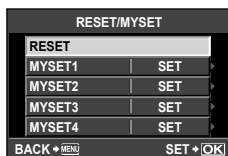

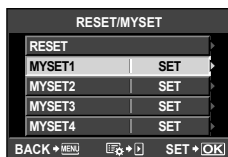

## Using MYSET

- 1 Select [RESET/MYSET] in shooting menu  (P. 108).
- 2 Select the desired settings ([MYSET1]–[MYSET4]) and press the **OK** button.
- 3 Select [SET] and press the **OK** button.



## Saving MYSET

- 1 Adjust settings in order to save.
- 2 Select [RESET/MYSET] in shooting menu  (P. 108).
- 3 Select the desired destination ([MYSET1]–[MYSET4]) and press **▷**.
  - [SET] appears next to destinations ([MYSET1]–[MYSET4]) to which settings have already been saved. Selecting [SET] again overwrites the registered setting.
  - To cancel the registration, select [RESET].
- 4 Select [SET] and press the **OK** button.  
 "Settings stored using MYSET" (P. 106)

## Choosing a focus mode (AF mode)

Select a focusing method (focus mode).

**1** Display the live control (P. 20) and select the AF mode item using  $\Delta \nabla$ .

**2** Select an option with  $\triangleleft \triangleright$  and press the  $\odot$  button.

- The selected AF mode is displayed on the LCD monitor.



<b>S-AF</b> (single AF)	The camera focuses once when the shutter button is pressed halfway. When the focus is locked, a beep sounds, and the AF confirmation mark and the AF target mark light up. This mode is suitable for taking pictures of still subjects or subjects with limited movement.
<b>C-AF</b> (continuous AF)	The camera repeats focusing while the shutter button remains pressed halfway. When the subject is in focus, the AF confirmation mark lights up on the LCD monitor and the beep sounds when the focus is locked at the first and second time. Even if the subject moves or you change the composition of the picture, the camera continues trying to focus. <ul style="list-style-type: none"> <li>Four Thirds system lenses focus using [S-AF].</li> </ul>
<b>MF</b> (manual focus)	This function allows you to manually focus on any subject. 
<b>S-AF+MF</b> (Simultaneous use of S-AF mode and MF mode)	After pressing the shutter button halfway to focus in [S-AF] mode, you can turn the focus ring to fine-adjust focus manually.
<b>C-AF+TR</b> (AF Tracking)	Press the shutter button halfway to focus; the camera then tracks and maintains focus on the current subject while the shutter button is held in this position. <ul style="list-style-type: none"> <li>The AF target is displayed in red if the camera can no longer track the subject. Release the shutter button and then frame the subject again and press the shutter button halfway.</li> <li>Four Thirds system lenses focus using [S-AF].</li> </ul>



### Tips

- The [RLS PRIORITY S] (P. 80) and [RLS PRIORITY C] (P. 80) options can be used to choose whether the shutter can be released when the camera is unable to focus.
- [MF ASSIST] (P. 79) can be used to enable automatic zoom display when the lens focus ring is rotated.
- [FOCUS RING] (P. 79) allows you to change the rotational direction of the focus ring.



### Caution

- The camera may be unable to focus if the subject is poorly lit, obscured by mist or smoke, or lacks contrast.

## Choosing a focus target (AF target)

Choose which of the 11 autofocus targets will be used for autofocus.

- 1 Press the **[•••]** button ( $\triangleleft$ ) to display options.
- 2 Select an AF target with  $\triangle \nabla \triangleleft \triangleright$  and press the **OK** button.

If all targets are surrounded by a green frame (ALL TARGETS)

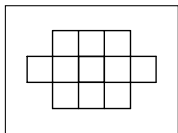

The camera automatically selects from the 11 focus targets.

If one target is surrounded by a green frame (SINGLE TARGET)

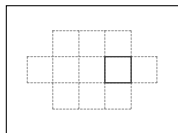

The camera will focus on the subject in the selected focus target.

## Focus lock

If the camera is unable to focus on your chosen subject, select [SINGLE TARGET] and use focus lock to focus on another subject at about the same distance.

- 1 In [S-AF] mode, position the AF target over the subject and press the shutter button halfway.
  - Make sure that the AF confirmation mark is lighting up.
  - Focus locks while the shutter button is pressed halfway.
- 2 Keeping the shutter button pressed halfway, recompose the photograph and then press the shutter button the rest of the way down.
  - Do not change the distance between the camera and the subject while pressing the shutter button halfway.

## Quick AF target selection

You can pre-select an AF target.

- Select the AF target using **[•••] SET HOME** (P. 79).
- Use **[Fn] FUNCTION** or **[OK] FUNCTION** to assign this function to the button.  
[BUTTON FUNCTION]: "Custom menu" (P. 78)

## Toggling quickly between AF and MF

The **Fn** or **OK** button can be used to toggle [MF].

- Use **[Fn] FUNCTION** or **[OK] FUNCTION** to assign this function to the button.  
[BUTTON FUNCTION]: "Custom menu" (P. 78)

## Zoom frame AF/zoom AF

You can zoom in on a portion of the frame when adjusting focus. Choosing a high zoom ratio allows you to use autofocus to focus on a smaller area than is normally covered by the AF target. Autofocus is also available over a wider area of the frame than with AF target selection.

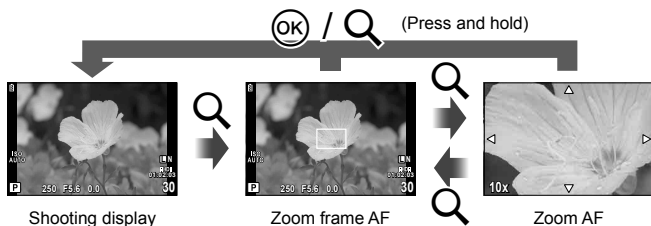

### 1 Press the Q button to display the zoom frame.

- If the camera was focused using autofocus just before the button was pressed, the zoom frame will be displayed at the current focus position.
- Use  $\Delta$   $\nabla$   $\triangleleft$   $\triangleright$  to position the zoom frame.
- Press **INFO** and use  $\Delta$   $\nabla$  to choose the zoom ratio.

#### Positioning the zoom frame

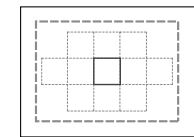

Area in which zoom frame can be positioned

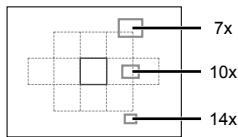

Comparison of AF and zoom frames

### 2 Press the Q button again to zoom in on the zoom frame.

- Use  $\Delta$   $\nabla$   $\triangleleft$   $\triangleright$  to position the zoom frame.
- Press **INFO** and use  $\Delta$   $\nabla$  to choose the zoom ratio.

### 3 Press the shutter button halfway to initiate autofocus.

#### Notes

- Autofocus is available and pictures can be taken both when the zoom frame is displayed and when the view through the lens is zoomed in.
- At higher zoom ratios, autofocus is more accurate when the view through the lens is zoomed in.

#### Caution

- Zoom is visible only in the monitor and has no effect on the resulting photographs.

## Face priority AF/pupil detection AF

When [ON] is selected for face priority, the camera will set focus and digital ESP metering for faces indicated by white frames.

### Taking pictures using face priority

**1** Display the live control (P. 20) and select [☺ FACE PRIORITY] using  $\Delta \nabla$ .



**2** Use  $\triangleleft \triangleright$  to select [ON] and press  $\odot$ .

**3** Point the camera at your subject.

- If a face is detected, it will be indicated by a white border.

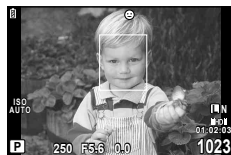

**4** Press the shutter button halfway to focus.

- When the camera focuses on the face in the white border, the border will turn green.
- If the camera is able to detect the subject's eyes, it will focus on the closer of the two eyes and the focus point will be indicated by a green frame (pupil detection AF).

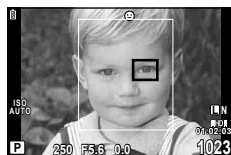

**5** Press the shutter button the rest of the way down to shoot.

#### **!** Caution

- Face priority applies only to the first shot in each sequence taken during sequential shooting.
- Depending on the subject, the camera may not be able to correctly detect the face.
- In metering modes other than [☺] (Digital ESP metering), the camera will meter exposure for the selected position.

#### **📝** Notes

- Face priority is also available in [MF]. Faces detected by the camera are indicated by white frames.

## Controlling exposure (exposure compensation)

Press the  button ( $\Delta$ ) and use  $\triangleleft \triangleright$  to adjust exposure compensation. Choose positive (“+”) values to make pictures brighter, negative (“-”) values to make pictures darker. Exposure can be adjusted by  $\pm 3$  EV.



### Tips

- To change the exposure adjustment interval. [EV STEP]:  “Custom menu” (P. 78)





### Caution

- Exposure compensation is not available in **FAUTO**, **M**, or **SCN** modes.

## Previewing the effects of exposure compensation and white balance

The effects of exposure compensation and white balance can be previewed in the 4-split screen.

1

Select [ON] for [/INFO SETTINGS] > [MULTI VIEW] in the  Custom menu (P. 78).



2

Press the **INFO** button repeatedly to display the multi view display.

- This function is not available in **FAUTO**, **ART**, **SCN** or  mode.

3

Use  $\triangleleft \triangleright$  to select the desired value and press  $\odot$ .

- Use  $\Delta \nabla$  to toggle between the exposure compensation and white balance displays.

## Changing the brightness of highlights and shadows

To display the tone control dialog, press the  button ( $\Delta$ ) and press the **INFO** button. Use  $\triangleleft \triangleright$  to choose a tone level. Choose “low” to darken shadows or “high” to brighten highlights.

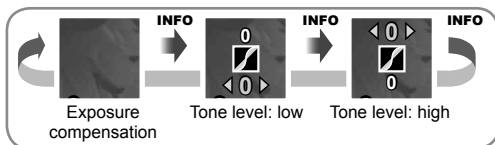







## Choosing how the camera measures brightness (metering)

Choose how the camera meters subject brightness.

- 1 Display the live control (P. 20) and select the metering item using  $\Delta \nabla$ .

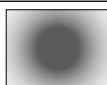

- 2 Select an option with  $\triangleleft \triangleright$  and press  $\text{OK}$ .

 <b>Digital ESP metering</b>	The camera meters exposure in 324 areas of the frame and optimizes exposure for the current scene or (if [ON] is selected for [☺ FACE PRIORITY]) portrait subject. This mode is recommended for <u>general use</u> .	
 <b>Center weighted averaging metering</b>	This metering mode provides the average metering between the subject and the background lighting, placing more weight on the subject at the center.	
 <b>Spot metering</b>	Choose this option to meter a small area (about 2% of the frame) with the camera pointed at the object you wish to meter. Exposure will be adjusted according to the brightness at the metered point.	
 <b>Spot metering - highlight control</b>	Increases spot metering exposure. Ensures bright subjects appear bright.	
 <b>Spot metering - shadow control</b>	Lowers spot metering exposure. Ensures dark subjects appear dark.	

- 3 Press the shutter button halfway.
  - Normally, the camera will start metering when the shutter button is pressed halfway and lock exposure while the shutter button is held in this position.

## Exposure lock (AE lock)

To lock exposure without locking focus, press the **Fn** or  $\text{AE-L}$  button. Exposure lock can be used when you want to set focus and exposure separately while recomposing photographs, or if you want to take a series of photographs at the same exposure.

- Assign AEL/AFL to the **Fn** or  $\text{AE-L}$  button using [**Fn**FUNCTION] or [ $\text{AE-L}$ FUNCTION].



AE lock

Exposure locks and a  $\text{AE-L}$  icon is displayed when the button is pressed once. Press the shutter button to take a picture.

- Press the button again to cancel AE lock.

### Tips





- To lock exposure while the button is pressed. [AEL/AFL MEMO]: To activate AE lock with a set metering mode. [AEL METERING]:  $\text{AE-L}$  "Custom menu" (P. 78)





## White balance compensation

This function lets you make fine changes to the auto WB and preset WB settings.

- 1 Select [WB] in  Custom Menu (P. 78) tab .
- 2 Select the option to be modified and press .
- 3 Select a slider with  and use  to choose the amount.

### Adjusting the white balance in the A direction (Amber-Blue)

Higher values produce “warmer” (redder) tints, lower values “cooler” (bluer) tints.

### Adjusting the white balance in the G direction (Green-Magenta)



Higher values produce greener tints, lower values tints that are more purple.



- 4 Press  to save settings and exit.





#### Tips

- To display a test photograph taken at the selected white balance value, press the  button.
- Adjusting all WB mode settings at once. [ALL ]:  “Custom menu” (P. 78)

## One-touch white balance

Measure white balance by framing a piece of paper or other white object under the lighting that will be used in the final photograph. This is useful when shooting a subject under natural light, as well as under various light sources with different color temperatures.

- 1 After selecting [ (One-touch white balance)] (P. 40) , press the **INFO** button.
- 2 Photograph a piece of colorless (white or gray) paper.
  - Frame the object so that it fills the display and no shadows fall it.
  - The one-touch white balance screen appears.
- 3 Select [YES] and press the  button.
  - The new value is saved as a preset white balance option.
  - The new value is stored until one-touch white balance is measured again. Turning the power off does not erase the data.



#### Tips

- If the subject is too bright or too dark or visibly tinted, the message “WB NG RETRY” will be displayed and no value will be recorded. Correct the problem and repeat the process from Step 1.

## Processing options (picture mode)











Select a picture mode and make individual adjustments to contrast, sharpness, and other parameters. Changes to each picture mode are stored separately.

- 1 Select [PICTURE MODE] in shooting menu  (P. 108).



- 2 Select an option with   and press .

### Picture modes

 <b>i-ENHANCE</b>	Produces more impressive-looking pictures matched to the scene mode.
 <b>VIVID</b>	Produces vivid colors.
 <b>NATURAL</b>	Produces natural colors.
 <b>MUTED</b>	Produces flat tones.
 <b>PORTRAIT</b>	Produces beautiful skin tones.
<b>MONOTONE</b>	Produces black and white tone.
<b>CUSTOM</b>	Select one picture mode, set the parameters, and register the setting.
 <b>POP ART</b>	Choose an art filter and select the desired effect.
 <b>SOFT FOCUS</b>	
 <b>GRAINY FILM</b>	
 <b>PIN HOLE</b>	
 <b>DIORAMA</b>	
 <b>DRAMATIC TONE</b>	

### 3 Press $\triangleright$ to display settings for the selected option.

<b>CONTRAST</b>	Distinction between light and dark	✓	✓	✓	✓
<b>SHARPNESS</b>	Sharpness of the image	✓	✓	✓	✓
<b>GRADATION</b>	Adjust tone (gradation).				
<b>AUTO</b>	Divides the image into detailed regions and adjusts the brightness separately for each region. This is effective for images with areas of large contrast in which the whites appear too bright or the blacks appear too dark.	✓	✓	✓	✓
<b>NORMAL</b>	Use [NORMAL] mode for general uses.				
<b>HIGH KEY</b>	Gradation for a bright subject.				
<b>LOW KEY</b>	Gradation for a dark subject.				
<b>SATURATION</b>	Vividness of the color	✓	✓	—	✓
<b>EFFECT (i-ENHANCE)</b>	Sets the extent that the effect will be applied.	✓	—	—	✓
<b>B&amp;W FILTER (MONOTONE)</b>	Creates a black and white image. The filter color is brightened and the complementary color is darkened.				
<b>N:NEUTRAL</b>	Creates a normal black and white image.				
<b>Ye:YELLOW</b>	Reproduces clearly defined white cloud with natural blue sky.	—	—	✓	✓
<b>Or:ORANGE</b>	Slightly emphasizes colors in blue skies and sunsets.				
<b>R:RED</b>	Strongly emphasizes colors in blue skies and brightness of crimson foliage.				
<b>G:GREEN</b>	Strongly emphasizes colors in red lips and green leaves.				
<b>PICT. TONE (MONOTONE)</b>	Colors the black and white image.				
<b>N:NEUTRAL</b>	Creates a normal black and white image.				
<b>S:SEPIA</b>	Sepia	—	—	✓	✓
<b>B:BLUE</b>	Bluish				
<b>P:PURPLE</b>	Purplish				
<b>G:GREEN</b>	Greenish				

#### **Caution**

- Changes to contrast have no effect at settings other than [NORMAL].

## Image quality (record mode)

Select an image quality for photographs and movies according their intended use, for example retouching on a computer or display on the web. [L/N] is a good all-purpose choice for photographs, as is [HD] for movies.

### Choosing a record mode

1 Display the live control (P. 20) and use  $\Delta$   $\nabla$  to choose a record mode for movies or photographs.



Record mode

2 Select an option using  $\triangleleft$   $\triangleright$  and press  $\odot$ .  
• The selected option is displayed in the monitor.

#### ■ Record modes (still images)

Choose from RAW and JPEG (L, M, N, and S) modes. Choose a RAW+JPEG option to record both a RAW and a JPEG image with each shot. JPEG modes combine image size (L, M, and S) and compression ratio (SF, F, N, and B). The options available can be selected using the [SET] option in the custom menus. [SET] "Custom menu" (P. 78)

Image size		Compression rate				Application
Name	Pixel count	SF (Super Fine)	F (Fine)	N (Normal)	B (Basic)	
L (Large)	4032×3024*	L SF	L F*	L N*	L B	Select for the print size
	3200×2400	M SF	M F	M N*	M B	
M (Middle)	2560×1920*					
	1920×1440					
S (Small)	1600×1200	S SF	S F	S N*	S B	For small prints and use on a web site
	1280×960*					
	1024×768					
	640×480					

\* Default.

- The size of [M] and [S] images can be selected using the [PIXEL COUNT] option in the custom menus. [SET] "Custom menu" (P. 78)

#### RAW image data

This format (extension ".ORF") stores unprocessed image data for later processing. RAW image data can not be viewed using other cameras or software, and RAW images can not be selected for printing. JPEG copies of RAW images can be created using this camera. [SET] "Editing still images" (P. 63)

#### ■ Record modes (movies)

Choose from HD and SD modes.

Record mode	Pixel count	Application
HD	1280×720	Record high-definition movies.
SD	640×480	Record standard-definition movies.

## Setting the image aspect

You can change the aspect ratio (horizontal-to-vertical ratio) when taking pictures using live view. Depending on your preference, you can set the aspect ratio to [4:3] (standard), [16:9], [3:2], or [6:6].

- 1 Display the live control (P. 20) and select the aspect ratio item using  $\Delta \nabla$ .
- 2 Use  $\triangleleft \triangleright$  to select an aspect ratio and press  $\text{OK}$ .



### ! Caution

- JPEG images are cropped to the selected aspect ratio; RAW images, however, are not cropped but are instead saved with information on the selected aspect ratio.
- When RAW images are played back, the selected aspect ratio is shown by a frame.

### 💡 Tips

- For information on cropping existing photographs or changing their aspect ratio, see “Editing still images” (P. 63).

## ISO sensitivity

Increasing ISO sensitivity increases noise (graininess) but allows photographs to be taken when lighting is poor. The setting recommended in most situations is [AUTO], which starts at ISO 200 — a value that balances noise and dynamic range — and then adjusts ISO sensitivity according to shooting conditions.

- 1 Display the live control (P. 20) and select the ISO sensitivity item using  $\Delta \nabla$ .
- 2 Select an option using  $\triangleleft \triangleright$  and press  $\text{OK}$ .
  - The selected option is displayed in the monitor.



<b>AUTO</b>	The sensitivity is set automatically according to the shooting conditions.
<b>200–6400</b>	Sensitivity is set to the selected value.

### 💡 Tips

- The default value and upper limit for auto ISO sensitivity can be selected using [ISO-AUTO SET].  
The options available for ISO sensitivity can be selected using [ISO STEP].  
Auto sensitivity can be enabled in **M** mode using [ISO-AUTO].  
👉 “Custom menu” (P. 78)



## Sequential shooting/using the self timer

The camera will take photos at a rate of about 3 frames per second (fps) while the shutter button is pressed all the way down. Alternatively, the self-timer can be used for self- or group-portraits or to reduce camera shake when the camera is mounted on a tripod or otherwise fixed in place.

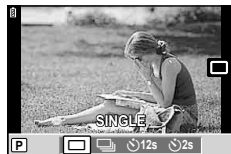
- 1 Press the  button ( $\nabla$ ) to display the direct menu.



- 2 Select an option using  $\triangleleft$  and  $\triangleright$  and press  $\text{OK}$ .

<input type="checkbox"/> <b>Single-frame shooting</b>	Shoots 1 frame at a time when the shutter button is pressed (normal shooting mode).
 <b>Sequential shooting</b>	Photographs are taken at about 3 frames per second (fps) while the shutter button is pressed all the way down ([S-AF] or [MF] selected for [AF MODE], P. 34).
 <b>Self-timer 12 SEC</b>	Press the shutter button halfway to focus, the rest of the way down to start the timer. First, the self-timer lamp lights up for approximately 10 seconds, then it blinks for approximately 2 seconds and the picture is taken.
 <b>Self-timer 2 SEC</b>	Press the shutter button halfway to focus, the rest of the way down to start the timer. The self-timer lamp blinks for approximately 2 seconds, and then the picture is taken.

### Notes

- To cancel the activated self-timer, press the  button.
- During sequential shooting, focus, exposure, and white balance are locked at the first frame (during [S-AF], [MF]).

### Caution

- During sequential shooting, if the battery check blinks due to low battery, the camera stops shooting and starts saving the pictures you have taken on the card. The camera may not save all of the pictures depending on how much battery power remains.
- Fix the camera securely on a tripod for self-timer shooting.
- If you stand in front of the camera to press the shutter button halfway when using the self-timer, the photograph may be out of focus.

## Reducing camera shake (the image stabilizer)

You can reduce the amount of camera shake that can occur when shooting in low light situations or shooting with high magnification.

- 1 Display the live control (P. 20) and select the image stabilizer item using  $\Delta \nabla$ .



- 2 Select an option with  $\triangleleft \triangleright$  and press  $\text{OK}$ .

OFF	Image stabilizer is off.
I.S. 1	Image stabilizer is on.
I.S. 2	Image stabilization applies only to vertical (1) camera shake. Use when panning the camera horizontally.
I.S. 3	Image stabilization applies only to horizontal (2) camera shake. Use when panning the camera horizontally with the camera held in portrait orientation.

### Choosing a focal length (Micro Four Thirds/Four Thirds System lenses excluded)

Use focal length information to reduce camera shake when shooting with lenses that are not Micro Four Thirds or Four Thirds system lenses.

- 1 Select the [IMAGE STABILIZER] item in the live control (P. 20) and press the **INFO** button.



- 2 Use  $\triangleleft \triangleright$  to choose a focus distance and press  $\text{OK}$ .

- Choose a focal length between 8mm and 1000mm.
- Choose the value that most closely matches to the one that is printed on the lens.

### ! Caution

- The image stabilizer cannot correct excessive camera shake or camera shake that occurs when the shutter speed is set to the slowest speed. In these cases, it is recommended that you use a tripod.
- When using a tripod, set [IMAGE STABILIZER] to [OFF].
- When using a lens with an image stabilization function, turn off the image stabilizer function of either the lens or the camera.
- You may notice an operating sound or vibration when the image stabilizer is activated.
- The image stabilizer will not activate at shutter speeds of over 2 seconds.
- If the internal temperature of the camera exceeds the specified temperature, the image stabilizer is deactivated and the image stabilizer icon lights red on the monitor.

# 2 Other shooting options

## “Point-and-shoot” photography (P program mode)

In mode **P**, the camera automatically adjusts shutter speed and aperture in response to subject brightness.

**1** Set the mode dial to **P**.

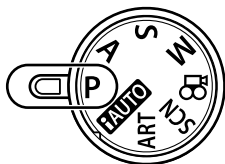

**2** Take pictures.

- The shutter speed and aperture selected by the camera are displayed in the monitor.
- Rotate the control dial to adjust exposure compensation.

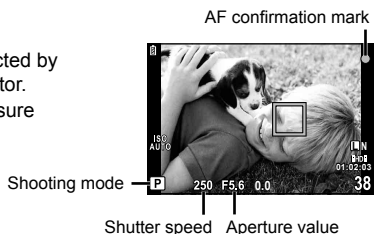

### Program shift (Ps)

In **P** and **ART** modes, you can press the  button ( $\Delta$ ) and then use  $\Delta$   $\nabla$  to choose different combinations of aperture and shutter speed without altering exposure. This is known as “program shift.” “s” appears next to the shooting mode during program shift. To cancel program shift, press and hold  $\Delta$   $\nabla$  until “s” is no longer displayed or turn the camera off.

#### **Caution**

- Program shift is not available when you are using a flash.



#### **Caution**

- The shutter speed and aperture displays flash if the camera is unable to achieve optimal exposure. See “Exposure warning display” (P. 103).



## Choosing aperture (A aperture-priority mode)

In mode **A**, you choose the aperture and let the camera automatically adjust shutter speed for optimal exposure.

**1** Rotate the mode dial to **A**.

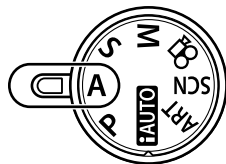

**2** Rotate the control dial to choose the aperture.

- You can also select the aperture by pressing the  button ( $\Delta$ ) and then using  $\Delta$ / $\nabla$ . In this case the control dial can be used for exposure compensation.



Aperture value

**3** Take pictures.



- Larger apertures (lower f-numbers) decrease depth of field (the area in front of or behind the focus point that appears to be in focus), softening background details. Smaller apertures (higher f-numbers) increase depth of field.

When the aperture value (f-number) is decreased



When the aperture value (f-number) is increased

### Preview function

The **Fn** and  buttons can be used to preview depth of field. If [PREVIEW] is assigned to either button using the [**Fn** FUNCTION] or [ FUNCTION] option in the custom menu, you can press and hold the button to stop aperture down to the selected value and preview depth of field (the distance behind and in front of the focus point that appears to be in focus) in the monitor.

[BUTTON FUNCTION]:  "Custom menu" (P. 78)

**Fn** button  button

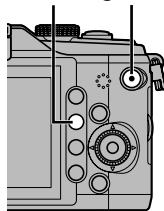

## Choosing shutter speed (S shutter-priority mode)

In mode **S**, you choose the shutter speed and let the camera automatically adjust aperture for optimal exposure.

**1** Rotate the mode dial to **S**.

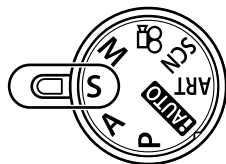

**2** Rotate the control dial to choose the shutter speed.

- You can also select the shutter speed by pressing the  button ( $\Delta$ ) and then using  $\Delta$   $\nabla$ . In this case the control dial can be used for exposure compensation.



Shutter speed

**3** Take pictures.

- A fast shutter speed can freeze a fast action scene without any blur. A slow shutter speed will blur a fast action scene. This blurring will give the impression of dynamic motion.

Fast shutter speed





Slow shutter speed

## Choosing aperture and shutter speed (M manual mode)

In mode **M**, you choose both the aperture and the shutter speed. At a speed of BULB, the shutter remains open while the shutter button is pressed.

**1** Rotate the mode dial to **M**.

**2** Rotate the control dial to choose the shutter speed. To select the aperture, press the  button ( $\Delta$ ).

- To use the arrow pad to adjust shutter speed and aperture, begin by pressing the  button ( $\Delta$ ) and then use  $\langle \triangleright \rangle$  to select the aperture and  $\Delta \nabla$  to choose the shutter speed.
- The shutter speed can be set to 1/4000–60 sec. or [BULB].

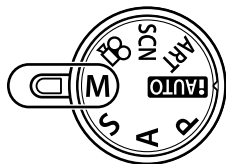

**3** Take pictures.

### **Caution**

- Exposure compensation is not available in **M** mode.

## Choosing when the exposure ends (bulb)

You can take a picture with a bulb exposure time in which the shutter stays open as long as you hold down the shutter button. Time the end of the exposure to suit the subject. Use for landscapes and fireworks. In **M** mode, set the shutter speed to [BULB].

- [BULB] is displayed on the LCD monitor.

### **Tips**

- To automatically end bulb shooting after a specified period of time. [BULB TIMER]:  
To fix the focus during manual focus shooting. [BULB FOCUSING]:  
 "Custom menu" (P. 78)

### **Caution**

- To prevent blur during bulb photography, mount the camera on a tripod and use a remote cable (P. 100).
- The following functions are not available during bulb shooting:  
Sequential shooting/self-timer shooting/AE bracket shooting/image stabilizer/  
flash bracketing

### **Noise in images**

While shooting at slow shutter speeds, noise may appear on-screen. These phenomena are caused when current is generated in those sections of the image pickup device that are not normally exposed to light, resulting in a rise in temperature in the image pickup device or image pickup device drive circuit. This can also occur when shooting with a high ISO setting in a high-temperature environment. To reduce this noise, the camera activates the noise reduction function. [NOISE REDUCT.]:

 "Custom menu" (P. 78)

## Panoramas



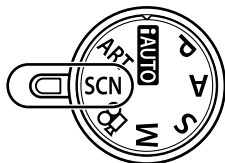

If you have installed the supplied computer software, you can use it to join pictures together to form a panorama.  "Using OLYMPUS Viewer 2/[i]b]" (P. 70)

### Taking pictures for a panorama

**1** Rotate the mode dial to **SCN**.



**2** Select [PANORAMA] and press .

**3** Use     to choose a pan direction.

**4** Take a picture, using the guides to frame the shot.

- Focus, exposure, and other settings are fixed at the values for the first shot.



**5** Take the remaining images, framing each shot so that the guides overlap with the previous picture.

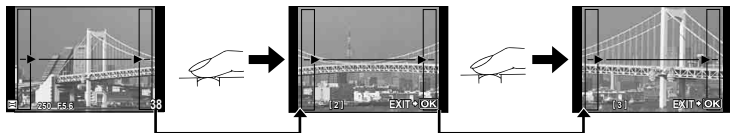



- A panorama may include up to 10 images. A warning indicator () is displayed after the tenth shot.

**6** After taking the last shot, press  to end the series.

#### **Caution**

- During panorama shooting, the image previously taken for position alignment will not be displayed. With the frames or other markers for display in the images as a guide, set the composition such that the edges of the overlapping images overlap within the frames.

#### **Notes**

- Pressing the  button before shooting the first frame returns to the scene mode selection menu. Pressing the  button in the midst of shooting ends the sequence of panorama shooting, and allows you to continue with the next one.

## Recording multiple exposures in a single image (multiple exposure)

Record multiple exposures in a single image, using the option currently selected for image quality.

**1** Select [MULTIPLE EXPOSURE] in shooting menu  (P. 108).

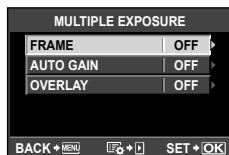

**2** Adjust settings.

<b>FRAME</b>	Select [2F].
<b>AUTO GAIN</b>	When set to [ON], the brightness of each frame is set to 1/2 and the images are overlaid. When set to [OFF], the images are overlaid with the original brightness of each frame.
<b>OVERLAY</b>	When set to [ON], a RAW image recorded on a card can be overlaid with multiple exposures and stored as a separate image. The number of pictures taken is one.





-  is displayed in the monitor while multiple exposure is in effect.

**3** Take pictures.

-  is displayed in green when shooting starts.
- Press  to delete the last shot.
- The previous shot is superimposed on the view through the lens as a guide to framing the next shot.

### Tips

- To overlay 3 or more frames: Select RAW for  and use the [OVERLAY] option to make repeated multiple exposures.
- For more information on overlaying RAW images:  "Image overlay" (P. 65)

### Caution

- [SLEEP] is automatically set to [OFF] while multiple exposure is in effect.
- Photographs taken with other cameras can not be included in a multiple exposure.
- When [OVERLAY] is set to [ON], the images displayed when a RAW image is selected are developed with the settings at the time of shooting.
- To set the shooting functions, cancel multiple exposure shooting first. Some functions cannot be set.
- Multiple exposure is cancelled automatically from the first picture in the following situations.

The camera is turned off/The  button is pressed/The **MENU** button is pressed/  
The shooting mode is set to a mode other than **P, A, S, M**/The battery power runs out/Any cable is connected to the camera/You switch between the monitor and electronic view finder

- When a RAW image is selected using [OVERLAY], the JPEG image for the image recorded in JPEG+RAW is displayed.
- When shooting multiple exposures using bracketing, priority is given to multiple exposure shooting. While the overlay image is being saved, bracketing is reset to the factory default setting.

## Varying settings over a series of photographs (bracketing)

The camera automatically varies exposure, white balance, flash level, or sensitivity over a series of exposures, "bracketing" the current setting. Bracketing is available in **P**, **A**, **S**, and **M** modes.

- 1 Select [BRACKETING] in shooting menu  (P. 108).

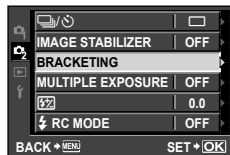

- 2 Choose a bracketing type.
  - **BKT** is displayed in the monitor.



### AE BKT (AE bracketing)

The camera varies exposure by 0.3EV, 0.7EV, or 1.0EV over three shots.

In single-frame shooting mode, one photograph is taken each time the shutter button is pressed all the way down, while in sequential shooting mode the camera continues to take shots in the following order while the shutter button is pressed all the way down: no modification, negative, positive. Number of shots: 2, 3, 5, or 7

- The **BKT** indicator turns green during bracketing.
- The camera modifies exposure by varying aperture and shutter speed (mode **P**), shutter speed (modes **A** and **M**), or aperture (mode **S**).
- The camera brackets the value currently selected for exposure compensation.
- The size of the bracketing increment changes with the value selected for [EV STEP].  "Custom menu" (P. 78)

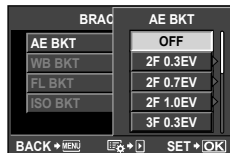

### **WB BKT (WB bracketing)**

Three images with different white balances (adjusted in specified color directions) are automatically created from one shot, starting with the value currently selected for white balance.

- White balance can be varied by 2, 4, or 6 steps on each of the A–B (Amber–Blue) and G–M (Green–Magenta) axes.
- The camera brackets the value currently selected for white balance compensation.
- No pictures will be taken during WB bracketing if there is not enough memory on the card for the selected number of frames.

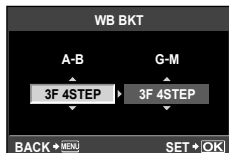

### **FL BKT (FL bracketing)**

The camera varies flash level over three shots (no modification on the first shot, negative on the second, and positive on the third). In single-frame shooting, one shot is taken each time the shutter button is pressed; in sequential shooting, all shots are taken while the shutter button is pressed.

- The **BKT** indicator turns green during bracketing.
- The size of the bracketing increment changes with the value selected for [EV STEP]. “Custom menu” (P. 78)

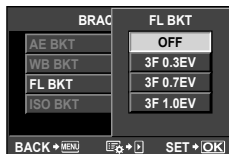

### **ISO BKT (ISO bracketing)**

The camera varies sensitivity by 0.3EV, 0.7EV, or 1.0EV over three shots (no modification on the first shot, negative on the second, and positive on the third), bracketing the current sensitivity setting (or if auto sensitivity is selected, the optimal sensitivity setting) while keeping shutter speed and aperture fixed. In single-frame shooting, one shot is taken each time the shutter button is pressed; in sequential shooting, all shots are taken while the shutter button is pressed.



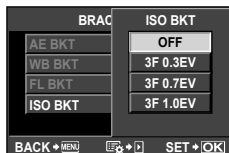

- The size of the bracketing increment does not change with the value selected for [ISO STEP]. “Custom menu” (P. 78)
- Bracketing is performed regardless of the upper limit set with [ISO-AUTO SET]. “Custom menu” (P. 78)















# 3 Flash shooting

The built-in flash can be set manually as required. The built-in flash can be used for flash photography in a variety of shooting conditions.

## Using a flash (flash photography)

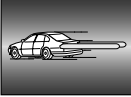
- 1 Slide the flash switch to raise the flash.
- 2 Press the  button () to display options.
- 3 Use   to choose a flash mode and press .

- The options available and the order in which they are displayed vary depending on the shooting mode.  "Flash modes that can be set by shooting mode" (P. 104)







	<b>Auto flash</b>	The flash fires automatically in low light or backlight conditions.
	<b>Fill-in flash</b>	The flash fires regardless of the light conditions.
	<b>Flash off</b>	The flash does not fire.*1
	<b>Red-eye reduction flash</b>	This function allows you to reduce the red-eye phenomenon. In <b>S</b> and <b>M</b> mode, the flash always fires.
	<b>Slow synchronization (1st curtain)</b>	Slow shutter speeds are used to brighten dimly-lit backgrounds.
 <b>SLOW</b>	<b>Slow synchronization (1st curtain)/Red-eye reduction flash</b>	Combines slow synchronization with red-eye reduction.
 <b>2nd CURTAIN</b>	<b>Slow synchronization (2nd curtain)</b>	The flash fires just before the shutter closes to create trails of light behind moving light sources. 
	<b>Manual (FULL)<sup>*2</sup></b>	For users who prefer manual operation. Flash output is expressed as a fraction of full power: 1/4, 1/16, or 1/64.
	<b>Manual (1/4)<sup>*2</sup></b>	
	<b>Manual (1/16)<sup>*2</sup></b>	
	<b>Manual (1/64)<sup>*2</sup></b>	

\*1 Both the built-in flash and optional external flash units turn off.

\*2 Built-in flash only.

- 4 Press the shutter button all the way.

### **Caution**

- In [/   (Red-eye reduction flash)], after the pre-flashes, it takes about 1 second before the shutter is released. Do not move the camera until shooting is complete.
- [/   (Red-eye reduction flash)] may not work effectively under some shooting conditions.
- When the flash fires, the shutter speed is set to 1/180 sec. or slower. When shooting a subject against a bright background with the fill-in flash, the background may be overexposed.



## Adjusting flash output (Flash intensity control)

Flash output can be adjusted if you find that your subject to appears overexposed, or is underexposed even though the exposure in the rest of the frame is just right.

- 1 Display the live control (P. 20) and select the Flash intensity control item using  $\Delta \nabla$ .
- 2 Choose the compensation value with  $\triangleleft \triangleright$  and press the  $\text{OK}$  button.



### Tips

- For information on flash bracketing:  "FL BKT (FL bracketing)" (P. 55)

### Caution

- This does not work when the flash control mode on the electronic flash is set to MANUAL.
- If flash intensity is adjusted on the electronic flash, it will be combined with the camera's flash intensity setting.
- When  $[\text{Fn} + \text{Fn}]$  is set to [ON], the flash intensity value will be added to the exposure compensation value.  "Custom menu" (P. 78)

## Using external flash units designated for use with this camera

Optional external flash units designated for use with this camera support a wide variety of options for flash photography, including automatic flash control, super FP, and wireless flash control (P. 89).

### Other external flash units

Observe the following precautions when mounting an external flash unit not designated for use with this camera on the camera hot shoe:

- Using obsolete flash units that apply currents of more than about 24 V to the camera hot shoe X-contact will damage the camera.
- Connecting flash units with signal contacts that do not conform to Olympus specifications may damage the camera.
- Use only with the camera in shooting mode **M** at shutter speeds slower than 1/180s and at ISO settings other than [AUTO].
- Flash control can only be performed by manually setting the flash to the ISO sensitivity and aperture values selected with the camera. Flash brightness can be adjusted by adjusting either ISO sensitivity or aperture.
- Use a flash with an angle of illumination suited to the lens. Angle of illumination is usually expressed using 35-mm format equivalent focal lengths.

# 4 Shooting and viewing movies

Use the **OK** button to record High Definition (HD) movies with sound. In movie mode, you can create movies that take advantage of the effects available in modes **A** and **M**.

## Changing the settings for movie recording

### Adding effects to a movie

**1** After selecting **MOVIE** mode, display the live control (P. 20) and use **▲▼** to highlight the shooting mode.



**2** Use **◀▶** to choose a mode and press **OK**.

<b>P</b>	Optimal aperture is set automatically according to the brightness of the subject.
<b>A</b>	Depiction of background is changed by setting the aperture. Use <b>◀▶</b> to set aperture.
<b>M</b>	You control both aperture and shutter speed. Use <b>◀▶</b> to choose the aperture, <b>▲▼</b> to select the shutter speed from values between 1/30 s and 1/4000 s. Sensitivity can be set manually to values between ISO 400 and 1600; auto ISO sensitivity control is not available.
<b>ART1–ART6</b>	Movie can be recorded with effects of art filter mode.  "Using art filters" (P. 16)

### **!** Caution

- When recording a movie, you cannot change the settings for exposure compensation and aperture value, and shutter speed.
- The size of each movie file is limited to 2GB. With some types of media, shooting may be interrupted unexpectedly before reaching the end of available recording time.
- If [IMAGE STABILIZER] is activated while recording a movie, the recorded image is enlarged slightly. Even if [I.S. 2] or [I.S. 3] is selected, the setting for [I.S. 1] is applied.
- Stabilization is not possible when the camera shake is excessive.
- When using a lens with the image stabilizer function, turn off the image stabilizer function of either the lens or the camera.
- You cannot use **[☺ FACE PRIORITY]** in movie mode.
- When the inside of the camera becomes hot, shooting is automatically stopped to protect the camera.
- With some art filters, [C-AF] operation is limited.
- It is recommended to use a SD speed class 6 compatible card for movie shooting.
- The camera may not correctly display the recording time in art filter mode. Movies recorded in [ART5] (DIORAMA) mode play back at high speed; during recording, the recording time is adjusted to reflect the playback time and advances more slowly than usual.

## Movie sound options (recording sound with movies)

- 1 Display the live control (P. 20) and select [MOVIE \Delta  $\nabla$ .
- 2 Switch ON/OFF using  $\triangleleft$   $\triangleright$  and press the  $\odot$  button.

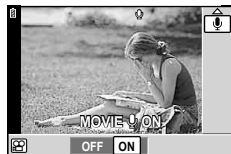

### Caution

- When recording sound in a movie, the sound made by the lens and camera operating may be recorded. If desired, you can reduce these sounds by shooting with [AF MODE] set to [S-AF], or by limiting the amount of times you press the buttons.
- No sound is recorded in [ART5] (DIORAMA) mode.



## Viewing movies

- 1 Display a movie in single-frame playback and press the  $\odot$  button.
- 2 Select [MOVIE PLAY] using  $\Delta$   $\nabla$  and press the  $\odot$  button to begin playback.
  - The following operations can be performed during movie playback:



$\odot$	Pause or resume playback. <ul style="list-style-type: none"> <li>- While playback is paused, press <math>\Delta</math> to display the first frame and press <math>\nabla</math> to display the last frame. Press <math>\triangleleft</math> <math>\triangleright</math> to rewind or advance one frame. Press and hold the button to rewind or advance in succession.</li> </ul>	 <p style="text-align: right;">Elapsed time/Total recording time</p>
$\triangleleft$ $\triangleright$	Advance or rewind a movie.	
$\Delta$ $\nabla$	Adjust volume.	

### Tips

- Recording movies with the shutter button:  "Recording movies with the shutter button" (P. 88)
- Recording longer movies (when you don't need to record in HD):  "Choosing a record mode" (P. 44)
- Recording in stereo, or reducing wind noise:  "Microphone set (SEMA-1)" (P. 101)

# 5 Playback options





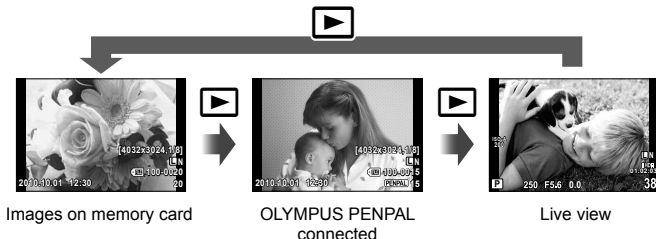





## Single-frame playback

Press the  button to view pictures full frame.



- To exit to shooting mode, press the shutter button halfway.

The following operations can be performed in full-frame playback.

 or 	View other pictures.
	Erase the current picture (P. 15).
	Press the  button to zoom in on pictures (P. 14).
	Press the  button to view multiple pictures.
<b>INFO</b>	View information on the current picture (P. 31).
	Protect the current picture (P. 15).
	Display the menus. JPEG EDIT, RAW DATA EDIT,  , ROTATE, 

## Index display/calendar display

### ■ Index display

To view multiple pictures, press the  button in full-frame playback.

### ■ Calendar display

Display the first picture taken on each date.

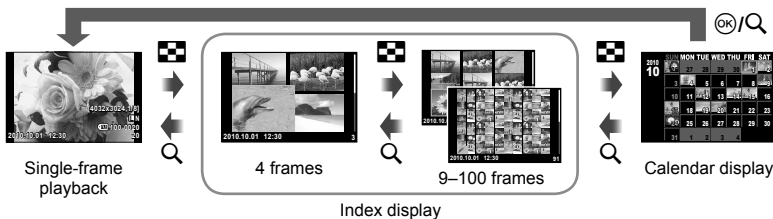

Only items for which [ON] is selected are displayed. [INFO/SETTINGS]: [INFO] "Custom menu" (P. 78)

	Press  to increase the number of images displayed from 4 to 9, 25, or 100. Press  again to view the calendar display.
	Press  to decrease the number of images displayed from 100 to 25, 9, or 4. Press  again to view the current image full frame.
	Select a picture.
	Protect the selected picture (P. 15).
	<b>Index display</b> Place a check mark (✓) on the current picture (P. 64). <b>Calendar display</b> View the pictures taken on the selected date full frame.

## Playback zoom (close-up playback)

Besides normal close-up playback, you can also quickly zoom in on images and view other frames at the current zoom ratio (zoom paging) if [mode2] is selected for [CLOSE UP MODE]. [INFO] "Custom menu" (P. 78)

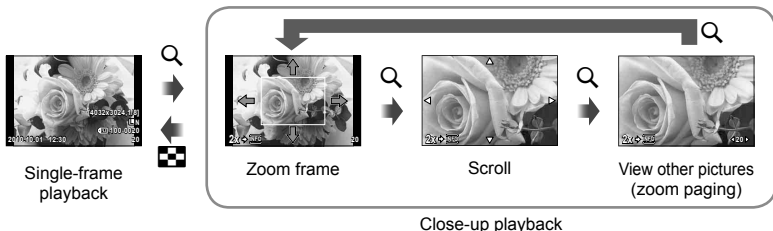

	Position the zoom frame. In zoom paging, use  to view other pictures at the current zoom ratio.
	View the frame at the selected zoom ratio. Press again to zoom in.
<b>INFO</b>	To choose the zoom ratio, press <b>INFO</b> and then use .
	Exit to single-frame playback.

## Rotate

Choose whether to rotate photographs.

- 1 Play the photograph back and press **OK**.
- 2 Select [ROTATE] and press **OK**.
- 3 Press **▲** to rotate the image counterclockwise, **▼** to rotate it clockwise; the image rotates each time the button is pressed.
  - Press **OK** to save settings and exit.
  - The rotated image is saved in its current orientation.
  - Movies and protected images can not be rotated.

## Slideshow

This function displays images stored on the card one after another.

- 1 Press **OK** during playback and select the slideshow option.

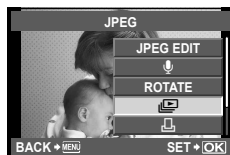

- 2 Adjust settings.

<b>START</b>	Start the slideshow. Images are displayed in order, starting with the current picture.
<b>BGM</b>	Set BGM (6 types) or turn BGM [OFF].
<b>SLIDE</b>	Set type of slideshow to execute.
<b>SLIDE INTERVAL</b>	Choose the length of time each slide is displayed from 2 to 10 seconds.
<b>MOVIE INTERVAL</b>	Select [FULL] to include full-length movie clips in the slide show, [SHORT] to include only the opening portion of each clip.



- 3 Select [START] and press the **OK** button.
  - The slideshow will start.
  - Press the **OK** button to stop the slideshow.

### Volume

Press **▲▼** during the slide show to adjust the overall volume of the camera speaker. Press **<>** to adjust the balance between the background music and the sound recorded with photographs or movies.

### Caution

- If the slideshow is left running for about 30 minutes, the camera will turn off automatically.

## Editing still images

Recorded images can be edited and saved as new images.

### 1 Display the image to be edited and press **OK**.

- [RAW DATA EDIT] is displayed if the picture is a RAW image, [JPEG EDIT] if it is a JPEG image. If the image recorded at a setting of [RAW+JPEG] is selected, either of them is used according to [EDIT].

### 2 Select [RAW DATA EDIT] or [JPEG EDIT] and press **OK**.

<b>RAW DATA EDIT</b>	Create a JPEG copy of a RAW image. The JPEG copy is processed using the settings currently stored in the camera. Adjust camera settings before choosing this option.
<b>JPEG EDIT</b>	<p>Choose from the following options:</p> <p>[SHADOW ADJ]: Brightens a dark backlit subject.</p> <p>[REDEYE FIX]: Reduces the red-eye phenomenon during flash shooting.</p> <p>[CROP]: Choose the size of the crop using <b>Q</b> or <b>Q</b> and use <b>Δ</b> <b>∇</b> <b>&lt;</b> <b>&gt;</b> to position the crop.</p> 

### **!** Caution

- You cannot edit movies.
- Red-eye correction may not work depending on the image.
- Editing of a JPEG image is not possible in the following cases:
  - When an image is recorded in RAW, when an image is processed on a PC, when there is not enough space in the card memory, when an image is recorded on another camera.
- When resizing (**RESIZE**) an image, you cannot select a larger number of pixels than was originally recorded.
- [CROP] and [ASPECT] can only be used to edit images with an aspect ratio of 4:3 (standard).

## Selecting and protecting images

You can select multiple images in the index display. In the index display, select an image you want to protect using  $\Delta$   $\nabla$   $\triangleleft$   $\triangleright$  and press  $\text{OK}$ . Selected images are shown by a check mark ( $\checkmark$ ). To deselect the images, press  $\text{OK}$  again.



### ■ Protecting selected frames

Select an image and press the  $\text{On}$  button.

- Protected images are shown by a  $\text{On}$  (protect) icon.

### ■ Canceling all protections

This function lets you cancel the protection of several images at one time.

- 1 Select [RESET PROTECT] in the  $\square$  (playback) menu (P. 108).
- 2 Select [YES] and press  $\text{OK}$ .

## Erasing images

### Erasing selected frames

Erase multiple selected frames.

- 1 In the index display, select an image you want to protect using  $\Delta$   $\nabla$   $\triangleleft$   $\triangleright$  and press  $\text{On}$ .
- 2 Select [YES] and press  $\text{OK}$ .
  - The selected images will be erased.

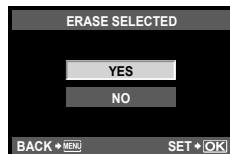

### All-frame erase

Erase all images on the memory card.

- 1 Select [CARD SETUP] in shooting menu  $\text{M}$  (P. 108).
- 2 Select [ALL ERASE] and press  $\text{OK}$ .
  - The [FORMAT] option (P. 96) can be used to delete non-image data.
- 3 Select [YES] and press  $\text{OK}$ .



## Image overlay

Up to 3 frames of RAW images taken with the camera can be overlaid and saved as a separate image. The image is saved with the record mode set at the time the image is saved. (If [RAW] is selected, the copy will be saved in [L+N+RAW] format.)

- 1 With a RAW image displayed during playback, press **OK** and select [IMAGE OVERLAY].
- 2 Select the number of images in the overlay and press **OK**.
- 3 Use **Δ** **∇** **◀** **▶** to select the RAW images that will be used in the overlay and press **OK** to select.
  - When you have selected the number of images specified in Step 2, the overlay will be displayed.
- 4 Adjust gain.
  - Use **◀** **▶** to select an image and use **Δ** **∇** to adjust gain.
  - Gain can be adjusted in the range 0.1–2.0. Check the results in the monitor.
- 5 Press **OK**. A confirmation dialog will be displayed; select [YES] and press **OK**.

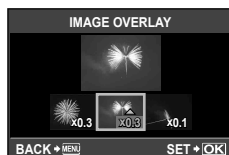
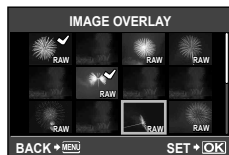

### Tips

- To overlay 4 or more frames, save the overlay image as a RAW file and use [IMAGE OVERLAY] repeatedly.

## Audio recording

Add an audio recording (up to 30 sec. long) to the current photograph.

- 1 Display the image to which you want to add an audio recording and press **OK**.
  - Audio recording is not available with protected images.
  - Audio recording is also available in the playback menu.
- 2 Select **[M]** and press **OK**.
  - To exit without adding a recording, select [NO].
- 3 Select **[M] START** and press **OK** to begin recording.
  - To stop recording part-way through, press the **OK** button.
- 4 Press **OK** to end recording.

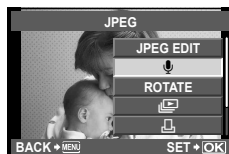

- Images with audio recordings are indicated by a **[M]** icon.
- To delete a recording, select [ERASE] in Step 2.

Download from [Wwww.Somanuals.com](http://www.Somanuals.com). All Manuals Search And Download.

## Viewing camera images on TV

Use the AV cable provided with the camera to playback recorded images on your TV. You can playback high-definition images on a high-definition TV by connecting it to the camera using a commercially available HDMI mini-cable.

### ■ Connection via AV cable

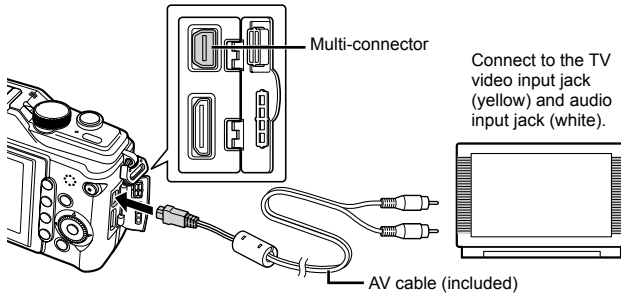

**1** Use the camera to select the video signal format that matches that of the connected TV ([NTSC]/[PAL]).

- [VIDEO OUT]: "Custom menu" (P. 78)

**2** Connect the TV and camera.

**3** Turn on the TV, and change "INPUT" to "VIDEO" (an input jack connected to the camera).

### ! Caution

- The camera's monitor turns off automatically when the AV cable is connected to the camera.
- Press the button when connecting via an AV cable.
- For details on changing the input source of the TV, refer to the TV's instruction manual.
- Depending on the TV's settings, the displayed images and information may become cropped.

### ■ Connection via HDMI mini-cable

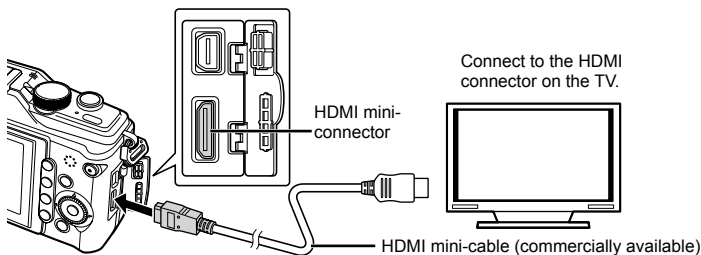

- 1** Connect the camera to the TV using the HDMI mini-cable.
- 2** Turn on the TV and switch “INPUT” to “HDMI INPUT”.
- 3** Turn on the camera.

**! Caution**



- For details on changing the input source of the TV, refer to the TV's instruction manual.
- Use an HDMI mini-cable that matches the HDMI mini connector on the camera and the HDMI connector on the TV.
- When the camera and TV are connected by both an AV cable and an HDMI mini-cable, HDMI will take priority.
- Depending on the TV's settings, the displayed images and information may become cropped.
- When you connect to a TV via an HDMI mini-cable, you can select the format of the digital video signal. Choose a format that matches the input format selected with the TV. [HDMI]:  “Custom menu” (P. 78)

<b>1080i</b>	Priority is given to 1080i HDMI output.
<b>720p</b>	Priority is given to 720p HDMI output.
<b>480p/576p</b>	480p/576p HDMI output. 576p is used when [PAL] is selected for [VIDEO OUT].

- You cannot shoot pictures or movies when the HDMI cable is connected.
- Do not connect the camera to other HDMI output devices. Doing so may damage the camera.
- HDMI output is not performed while connected via USB to a computer or printer.

**Using the TV remote control**

The camera can be operated by a TV remote control when connected to a TV that supports HDMI control.

- 1** Select [HDMI] in  Custom Menu (P. 78) tab .
- 2** Select [HDMI CONTROL] and choose [ON].
- 3** Operate the camera by using the TV remote control.
  - You can operate the camera by following the operation guide displayed on the TV.
  - During single-frame playback, you can display or hide the information display by pressing the “Red” button, and display or hide the index display by pressing the “Green” button.
  - Some functions may be unavailable, even if displayed, depending on the TV.

# 6 Sending and receiving images

The optional OLYMPUS PENPAL can be used to upload pictures to, and receive pictures from, Bluetooth devices or other cameras connected to an OLYMPUS PENPAL. Visit the OLYMPUS website for more information on Bluetooth devices. Before sending or receiving images, select [ON] for [ MENU DISPLAY] > [ MENU DISPLAY] to make the accessory port menu accessible.

## Sending images

Resize and upload JPEG images to another device. Before sending images, make sure that the receiving device is set to the mode for receiving data.

- 1 Display the picture you wish to send full frame and press .
- 2 Select [SEND A PICTURE] and press .
  - Select [SEARCH] and press in the next dialog. The destination will be searched and displayed.
- 3 Select the destination and press .
  - The image will be uploaded to the receiving device.
  - If prompted to enter a PIN code, enter the code for the receiving device and press .

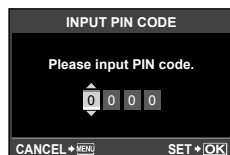
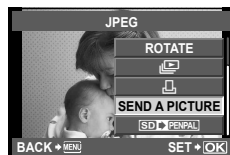

## Receiving images/adding a host

Connect to the transmitting device and download JPEG images.

- 1 Select [OLYMPUS PENPAL SHARE] in the tab of the accessory port menu (P. 90).
- 2 Select [PLEASE WAIT] and press .
  - Perform operations for sending images on the sending device.
  - Transmission will start and a [RECEIVE PAIRING REQUEST] dialog will be displayed.
- 3 Select [ACCEPT] and press .
  - The image will be downloaded to the camera.
  - If prompted to enter a PIN code, enter the code for the transmitting device and press .

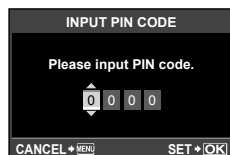
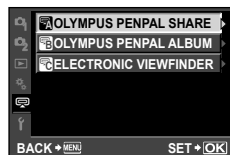





## Tips

- To resize images to be transmitted or choose how long the camera searches for a destination:  "Accessory port menu options" (P. 90)

## Editing the address book

The OLYMPUS PENPAL can store host information. You can assign names to hosts or delete host information.

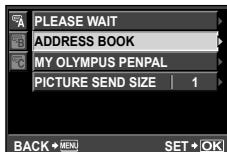

- 1 Select [OLYMPUS PENPAL SHARE] in the  tab of the accessory port menu (P. 90).
  - Press  and select [ADDRESS BOOK].
- 2 Select [ADDRESS LIST] and press .
- 3 Select the host you wish to edit and press .



### Deleting hosts







Select [YES] and press .

### Editing host information

Press  to display host information. To change the host name, press  again and edit the current name in the rename dialog.



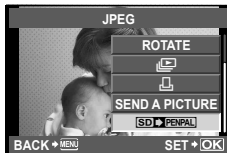

## Creating albums

Your favorite JPEG pictures can be resized and copied to an OLYMPUS PENPAL.

- 1 Display the picture you wish to copy full frame and press .
- 2 Select [  PENPAL] and press .
- To copy images from an OLYMPUS PENPAL to the memory card, select [  SD] and press .



## Tips

- Choosing the size at which images are copied:  [PICTURE COPY SIZE] (P. 90)
- Copying all images from the memory card:  [COPY ALL] (P. 90)
- Deleting or formatting albums:  [ALBUM MEM. SETUP] (P. 90)
- Removing protection from all images in the album:  [RESET PROTECT] (P. 90)
- Viewing album status (amount of memory remaining):  [ALBUM MEM. USAGE] (P. 90)

## Caution

- The OLYMPUS PENPAL can be used only in the region in which it was purchased. Depending on the areas, the usage may infringe the wave regulations and may be subject to its penalty.

# 7 Using OLYMPUS Viewer 2/[ib]

## Windows

### 1 Insert the supplied CD in a CD-ROM drive.

#### Windows XP

- A "Setup" dialog will be displayed.

#### Windows Vista/Windows 7

- An Autorun dialog will be displayed. Click "OLYMPUS Setup" to display the "Setup" dialog.



#### ! Caution

- If the "Setup" dialog is not displayed, select "My Computer" (Windows XP) or "Computer" (Windows Vista/Windows 7) from the start menu. Double-click the CD-ROM (OLYMPUS Setup) icon to open the "OLYMPUS Setup" window and then double-click "LAUNCHER.EXE".
- If a "User Account Control" dialog is displayed, click "Yes" or "Continue".

### 2 Follow the on-screen instructions on your computer.

#### ! Caution

- If nothing is displayed on the camera screen even after connecting the camera to the computer, the battery may be exhausted. Use a full-charged battery.

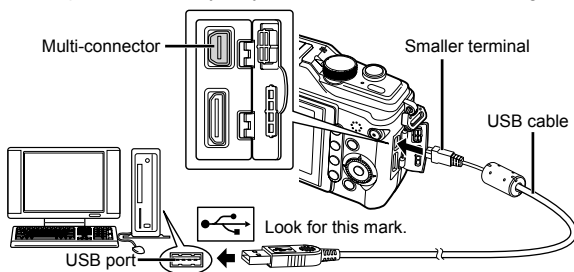

#### ! Caution

- When the camera is connected to another device via USB, a message will be displayed prompting you to choose a connection type. Select [STORAGE].

### 3 Register your Olympus product.

- Click the "Registration" button and follow the on-screen instructions.

### 4 Install OLYMPUS Viewer 2 and [ib] computer software.

- Check the system requirements before beginning installation.
- Click the "OLYMPUS Viewer 2" or "OLYMPUS ib" button and follow the on-screen instructions to install the software.

OLYMPUS Viewer 2	
<b>Operating System</b>	Windows XP (Service Pack 2 or later)/Windows Vista/Windows 7
<b>Processor</b>	Pentium 4 1.3 GHz or better
<b>RAM</b>	1 GB or more (2 GB or more recommended)
<b>Free Hard Drive Space</b>	1 GB or more
<b>Monitor Settings</b>	1024 × 768 pixels or more Minimum 65,536 colors (16,770,000 colors recommended)

[ib]	
<b>Operating System</b>	Windows XP (Service Pack 2 or later)/Windows Vista/Windows 7
<b>Processor</b>	Pentium 4 1.3 GHz or better (Pentium D 3.0 GHz or better required for movies)
<b>RAM</b>	512 MB or more (1 GB or more recommended) (1 GB or more required for movies—2 GB or more recommended)
<b>Free Hard Drive Space</b>	1 GB or more
<b>Monitor Settings</b>	1024 × 768 pixels or more Minimum 65,536 colors (16,770,000 colors recommended)
<b>Graphics</b>	A minimum of 64 MB video RAM with DirectX 9 or later.

- See online help for information on using the software.

## Macintosh

### 1 Insert the supplied CD in a CD-ROM drive.

- The disk contents should automatically be displayed in the Finder. If they are not, double-click the CD icon on the desktop.
- Double-click the “Setup” icon to display the “Setup” dialog.



### 2 Install OLYMPUS Viewer 2.

- Check the system requirements before beginning installation.
- Click the “OLYMPUS Viewer 2” button and follow the on-screen instructions to install the software.



OLYMPUS Viewer 2	
<b>Operating System</b>	Mac OS X v10.4.11–v10.6
<b>Processor</b>	Intel Core Solo/Duo 1.5 GHz or better
<b>RAM</b>	1 GB or more (2 GB or more recommended)
<b>Free Hard Drive Space</b>	1 GB or more
<b>Monitor Settings</b>	1024 × 768 pixels or more Minimum 32,000 colors (16,770,000 colors recommended)

- Other languages can be selected from the language combo box. For information on using the software, see online help.

## Copying pictures to a computer without OLYMPUS Viewer 2/[ib]

Your camera supports the USB Mass Storage Class. You can transfer images to a computer by connecting the camera to the computer with the provided USB cable. The following operating systems are compatible with the USB connection:

**Windows:** Windows 2000 Professional/Windows XP Home Edition/  
Windows XP Professional/Windows Vista/Windows 7

**Macintosh:** Mac OS X version 10.3 or later

- 1 Turn the camera off and connect it to the computer.
  - The location of the USB port varies with the computer. For details, refer to your computer's manual.
- 2 Turn on the camera.
  - The selection screen for the USB connection is displayed.
- 3 Press  $\Delta$   $\nabla$  to select [STORAGE]. Press the  $\text{OK}$  button.
- 4 The computer recognizes the camera as a new device.

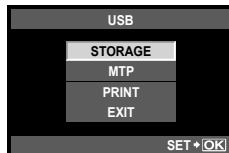

### **Caution**

- If your computer is running Windows Vista, select [MTP] in Step 3 to use Windows Photo Gallery.
- Data transfer is not guaranteed in the following environments, even if your computer is equipped with a USB port.
  - Computers with a USB port added by means of an extension card, etc.
  - Computers without a factory-installed OS and home-built computers
- When the camera is connected to the computer, none of the camera buttons are functional.
- If the dialog shown in Step 2 is not displayed when the camera is connected, select [AUTO] for [USB MODE] in the camera custom menus.  $\text{[MENU]}$  "Custom menu" (P. 78)



## Print reservation (DPOF\*)

You can save digital "print orders" to the memory card listing the pictures to be printed and the number of copies of each print. You can then have the pictures printed at a print shop that supports DPOF or print the pictures yourself by connecting the camera directly to a DPOF printer. A memory card is required when creating a print order.

\* DPOF (Digital Print Order Format) is a standard for recording the data that a printer or print service requires to automatically print pictures.

### Creating a print order

- 1 Press **OK** during playback and select **[ ]**.
- 2 Select **[ ]** or **[ALL]** and press **OK**.

#### Individual pictures

Press **<>** to select the frame that you want to set as print reservation, then press **Δ ∇** to set the number of prints.

- To set print reservation for several pictures, repeat this step. Press **OK** when all the desired pictures have been selected.

#### All pictures

Select **[ALL]** and press the **OK** button.

- 3 Select the date and time format and press the **OK** button.

<b>NO</b>	The pictures are printed without the date and time.
<b>DATE</b>	The pictures are printed with the shooting date.
<b>TIME</b>	The pictures are printed with the shooting time.

- 4 Select **[SET]** and press the **OK** button.

#### ! Caution

- The camera can not be used to modify print orders created with other devices. Creating a new print order deletes any existing print orders created with other devices.
- Not all functions may be available on all printers or at all photo labs.
- Print orders can not include RAW images or movies.
- When requesting prints without a digital print order, specify the file number. Requesting prints by frame number may result in the wrong pictures being printed.

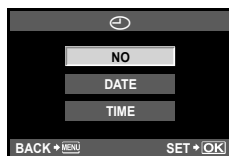
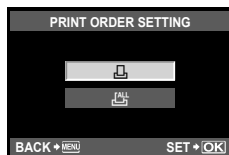

## Removing all or selected pictures from the print order

You can reset all print reservation data or just the data for selected pictures.

- 1 Press **OK** during playback and select **[ ]**.
- 2 Select **[ ]** and press **OK**.
  - To remove all pictures from the print order, select **[RESET]** and press **OK**.  
To exit without removing all pictures, select **[KEEP]** and press **OK**.
- 3 Press **<|>** to select images you wish to remove from the print order.
  - Use **∇** to set the number of prints to 0. Press **OK** once you have removed all the desired pictures from the print order.
- 4 Select the date and time format and press the **OK** button.
  - This setting is applied to all frames with print reservation data.
- 5 Select **[SET]** and press the **OK** button.

## Direct printing (PictBridge)

By connecting the camera to a PictBridge-compatible printer with the USB cable, you can print out recorded pictures directly.

- 1 Connect the camera to the computer using the supplied USB cable and turn the camera on.

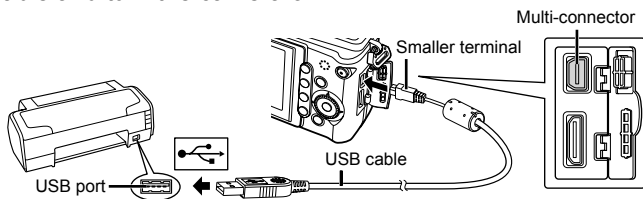

- Use a fully charged battery for printing.
  - When the camera is turned on, a dialog should be displayed in the monitor prompting you to choose a host. If it is not, select **[AUTO]** for **[USB MODE]** in the camera custom menus. **[ ]** “Custom Menu” (P. 78)
- 2 Use **Δ ∇** to select **[PRINT]**.
    - **[ONE MOMENT]** will be displayed, followed by a print-mode selection dialog.
    - If the screen is not displayed after a few minutes, disconnect the USB Cable and start again from Step 1.

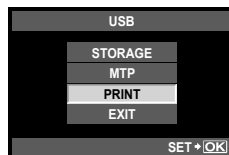

**Proceed to “Custom printing” (P. 75).**

## ⚠ Caution

- RAW images and movies can not be printed.

## Easy printing

Use the camera to display the picture you wish to print before connecting the printer via the USB cable.

**1** Use  $\triangleleft$   $\triangleright$  to display the pictures you want to print on the camera.

**2** Press  $\triangleright$ .

- The picture selection screen appears when printing is completed. To print another picture, use  $\triangleleft$   $\triangleright$  to select the image and press the  $\odot$  button.
- To exit, unplug the USB cable from the camera while the picture selection screen is displayed.



## Custom printing

**1** Follow the operation guide to set a print option.

### Selecting the print mode

Select the type of printing (print mode). The available print modes are as shown below.

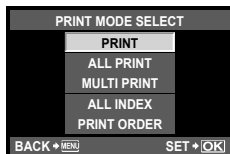

<b>PRINT</b>	Prints selected pictures.
<b>ALL PRINT</b>	Prints all the pictures stored in the card and makes one print for each picture.
<b>MULTI PRINT</b>	Prints multiple copies of one image in separate frames on a single sheet.
<b>ALL INDEX</b>	Prints an index of all the pictures stored in the card.
<b>PRINT ORDER</b>	Prints according to the print reservation you made. If there is no picture with print reservation, this is not available.

### Setting the print paper items

This setting varies with the type of printer. If only the printer's STANDARD setting is available, you cannot change the setting.



<b>SIZE</b>	Sets the paper size that the printer supports.
<b>BORDERLESS</b>	Selects whether the picture is printed on the entire page or inside a blank frame.
<b>PICS/SHEET</b>	Selects the number of pictures per sheet. Displayed when you have selected [MULTI PRINT].

## Selecting pictures you want to print

Select pictures you want to print. The selected pictures can be printed later (single-frame reservation) or the picture you are displaying can be printed right away.



<b>PRINT([OK])</b>	Prints the currently displayed picture. If there is a picture that [SINGLE PRINT] reservation has already been applied to, only that reserved picture will be printed.
<b>SINGLE PRINT([OK])</b>	Applies print reservation to the currently displayed picture. If you want to apply reservation to other pictures after applying [SINGLE PRINT], use <D> to select them.
<b>MORE([OK])</b>	Sets the number of prints and other items for the currently displayed picture, and whether or not to print it. For operation, refer to "Setting printing data" in the next section.

## Setting printing data

Select whether to print printing data such as the date and time or file name on the picture when printing. When the print mode is set to [ALL PRINT] and [OPTION SET] is selected, the following options appears.

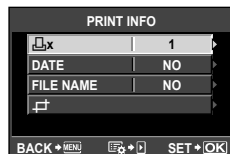

<b>x</b>	Sets the number of prints.
<b>DATE</b>	Prints the date and time recorded on the picture.
<b>FILE NAME</b>	Prints the file name recorded on the picture.
<b>[Crop Icon]</b>	Trims the picture for printing. Set the trimming size with the Q or [Crop Icon] button and the trimming position with Δ ∇ <D>.

**2** Once you have set the pictures for printing and printing data, select [PRINT], then press the **[OK]** button.

- To stop and cancel printing, press the **[OK]** button. To resume printing, select [CONTINUE].

## ■ Cancelling printing

To cancel printing, highlight [CANCEL] and press **[OK]**. Note that any changes to the print order will be lost; to cancel printing and return to the previous step, where you can make changes to the current print order, press **MENU**.

# 9 Camera setup

## Setup Menu

Use the Setup Menu to set the basic camera functions.

For details on using the menu lists, see “Using the menus” (P. 21).

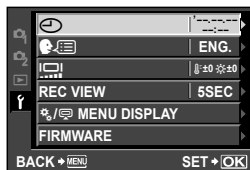

Option	Description	
(Date/time setting)	Set the camera clock.	7
(Changing the display language)	You can change the language used for the on-screen display and error messages from ENGLISH to another language.	—
(Monitor brightness adjustment)	<p>You can adjust the brightness and color temperature of the monitor. Color temperature adjustment will affect only the LCD monitor display during playback.</p> <p>Use   to switch between  (color temperature) and  (brightness), and use   to adjust the value between [+7]–[–7].</p> <p>For information on adjusting the brightness and color temperature of the electronic view finder, see [EVF ADJUST].</p> <p> “Accessory port menu options” (P. 90)</p>	—
REC VIEW	<p>Choose whether pictures are displayed immediately after shooting and for how long. This is useful for making a brief check of the picture you have just taken. Pressing the shutter button halfway while checking the picture lets you resume shooting immediately.</p> <p>[1SEC]–[20SEC]: Selects the number of seconds to display each picture. Can be set in units of 1 second.</p> <p>[OFF]: The picture being recorded to the card is not displayed.</p> <p>[AUTO ]: Displays the image being recorded, and then switches to playback mode. This is useful for erasing a picture after checking it.</p>	—
MENU DISPLAY	Choose whether to display the custom menus or accessory port menu.	78, 90
FIRMWARE	Your product’s firmware version will be displayed. When you make inquiries about your camera or accessories or when you want to download software, you will need to state which version of each of the products you are using.	—

## Custom Menu

The custom menus are used to adjust the settings listed below.

### Displaying the Custom Menu

Before changing settings in the Custom Menu, display the [] (Custom Menu) tab by selecting [ON] for the [/MENU DISPLAY] > [ MENU DISPLAY] option in the setup menu.

- 1 Press the **MENU** button to display the menus.
- 2 Select the setup menu tab (P. 77) using  $\Delta$ / $\nabla$  and press  $\triangleright$ .
- 3 Select [/MENU DISPLAY] using  $\Delta$ / $\nabla$  and press  $\triangleright$ .
- 4 Select [ MENU DISPLAY] using  $\Delta$ / $\nabla$  and press  $\triangleright$ .
- 5 Select [ON] using  $\Delta$ / $\nabla$  and press the button.
  - The [] tab is displayed.

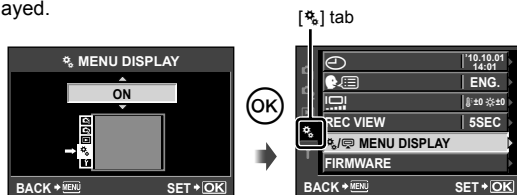
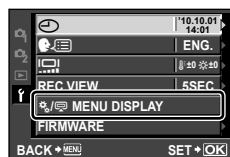



## Custom Menu options

### AF/MF

MENU  $\rightarrow$   $\rightarrow$

Option	Description	
AF MODE	Choose the AF mode.	34
AF AREA	Choose the AF target mode.	35
RESET LENS	When set to [ON], this resets the focus of the lens (infinity) each time the power is turned off.	—

Option	Description	
<b>BULB FOCUSING</b>	Normally focus locks during the exposure when manual focus (MF) is selected. Select [ON] to allow focusing using the focus ring.	—
<b>FOCUS RING</b>	You can customize how the lens adjusts to the focal point by selecting the rotational direction of the focus ring. <div style="display: flex; justify-content: space-around; align-items: center;">   </div>	—
<b>MF ASSIST</b>	Select [ON] to automatically magnify the image for precise focus when the focus ring is rotated in manual focus mode.	—
<b>[] SET HOME</b>	Choose the AF target position that will be saved as the home position.  appears in the AF target selection display while you choose a home position.	—

Option	Description																
<b>DIAL FUNCTION</b>	Choose the function assigned to the dial before and after the  button is pressed. <table border="1" style="margin-left: 20px;"> <thead> <tr> <th></th> <th>P</th> <th>A</th> <th>S</th> <th>M</th> </tr> </thead> <tbody> <tr> <td>Before</td> <td></td> <td>Aperture value</td> <td>Shutter speed</td> <td>Shutter speed</td> </tr> <tr> <td>After</td> <td>Ps</td> <td></td> <td></td> <td>Aperture value</td> </tr> </tbody> </table>		P	A	S	M	Before		Aperture value	Shutter speed	Shutter speed	After	Ps			Aperture value	—
	P	A	S	M													
Before		Aperture value	Shutter speed	Shutter speed													
After	Ps			Aperture value													
<b>AEL/AFL</b>	Assign focus or AE lock to the <b>Fn</b> or  button.	85															
<b>AEL/AFL MEMO</b>	If [ON] is selected, exposure will remain locked after the <b>Fn</b> or  button is released. Press the button again to cancel exposure lock.	39															
<b>BUTTON TIMER</b>	If [3 SEC], [5 SEC], or [8 SEC] is selected, settings can be adjusted for 3, 5, or 8 seconds after the , , or  button is released. If [HOLD] is selected, settings can be adjusted until the button is pressed a second time.	—															
<b>BUTTON FUNCTION</b>	Choose the function assigned to the selected button.	—															
<b>FUNCTION</b>	Fn FACE DETECT, PREVIEW, , [] HOME, MF, RAW , TEST PICTURE, MYSET, , AEL/AFL, , BACKLIT LCD, OFF	86															
<b>FUNCTION</b>																	
<b>FUNCTION</b>																	
<b>FUNCTION</b>																	
<b>DIAL DIRECTION</b>	Choose the direction in which the control dial is rotated to increase or decrease shutter speed or aperture or to move the cursor.	—															

## BUTTON/DIAL

MENU → →

Option	Description	
LOCK	Select [ON] to disable the control dial until the  button is pressed.	—

## RELEASE

MENU → →

Option	Description	
RLS PRIORITY S	If [ON] is selected, the shutter can be released even when the camera is not in focus. This option can be set separately for S-AF (P. 34) and C-AF (P. 34) modes.	—
RLS PRIORITY C		

## DISP/

MENU → →

Option	Description																																			
HDMI	[HDMI OUT]: Selecting the digital video signal format for connecting to a TV via an HDMI mini-cable. [HDMI CONTROL]: Select [ON] to allow the camera to be operated using remotes for TVs that support HDMI control.	67																																		
VIDEO OUT	Choose the video standard ([NTSC] or [PAL]) used in your country or region.	66																																		
/INFO SETTINGS	Choose the information displayed when the <b>INFO</b> button is pressed. []INFO]: Choose the information displayed in full frame playback. [LV-INFO]: Choose the information displayed when the camera is in shooting mode. <ul style="list-style-type: none"> <li>To choose a framing guide from [], [], [], or [], select [DISPLAYED GRID].</li> </ul> [] SETTINGS]: Choose the information displayed in index and calendar playback.	30, 31, 60, 61																																		
CONTROL SETTINGS	Choose the controls displayed in each shooting mode. <table border="1" data-bbox="315 982 849 1191"> <thead> <tr> <th rowspan="2">Controls</th> <th colspan="4">Shooting mode</th> </tr> <tr> <th>P/A/S/M</th> <th>AUTO</th> <th>ART</th> <th>SCN</th> </tr> </thead> <tbody> <tr> <td>LIVE CONTROL (P. 20)</td> <td>ON/OFF</td> <td>ON/OFF</td> <td>ON/OFF</td> <td>ON/OFF</td> </tr> <tr> <td>SCP (P. 87)</td> <td>ON/OFF</td> <td>ON/OFF</td> <td>ON/OFF</td> <td>ON/OFF</td> </tr> <tr> <td>LIVE GUIDE (P. 18)</td> <td>—</td> <td>ON/OFF</td> <td>—</td> <td>—</td> </tr> <tr> <td>ART MENU</td> <td>—</td> <td>—</td> <td>ON/OFF</td> <td>—</td> </tr> <tr> <td>SCENE MENU</td> <td>—</td> <td>—</td> <td>—</td> <td>ON/OFF</td> </tr> </tbody> </table>	Controls	Shooting mode				P/A/S/M	AUTO	ART	SCN	LIVE CONTROL (P. 20)	ON/OFF	ON/OFF	ON/OFF	ON/OFF	SCP (P. 87)	ON/OFF	ON/OFF	ON/OFF	ON/OFF	LIVE GUIDE (P. 18)	—	ON/OFF	—	—	ART MENU	—	—	ON/OFF	—	SCENE MENU	—	—	—	ON/OFF	30
Controls	Shooting mode																																			
	P/A/S/M	AUTO	ART	SCN																																
LIVE CONTROL (P. 20)	ON/OFF	ON/OFF	ON/OFF	ON/OFF																																
SCP (P. 87)	ON/OFF	ON/OFF	ON/OFF	ON/OFF																																
LIVE GUIDE (P. 18)	—	ON/OFF	—	—																																
ART MENU	—	—	ON/OFF	—																																
SCENE MENU	—	—	—	ON/OFF																																
ART LV MODE	Choose how art filter effects are displayed in the monitor while the shutter button is pressed halfway. [mode1]: Priority is given to accurately previewing the effect rather than to smooth display. [mode2]: Priority is given to smooth display rather than to accurately previewing the effect.	—																																		



Option	Description	
<b>LIVE VIEW BOOST</b>	If [ON] is selected, priority will be given to making images clearly visible; the effects exposure compensation and other settings will not be visible in the monitor.	—
<b>CLOSEUP MODE</b>	[mode1]: Press Q to zoom in (to a maximum of 14 ×) and press  to zoom out. [mode2]: Press Q to display the zoom frame for the specified zoom ratio. Press Q again to zoom in.	14, 61
<b>MODE GUIDE</b>	Choose [ON] to display help for the selected mode when the mode dial is rotated to a new setting.	10
<b>HISTOGRAM SETTINGS</b>	[HIGHLIGHT]: Choose the lower bound for the highlight display. [SHADOW]: Choose the upper bound for the shadow display.	31
<b>FACE PRIORITY</b>	Select [ON] to assign human faces priority when determining autofocus. The camera zooms in on faces during playback zoom.	37
<b>BACKLIT LCD</b>	If no operations are performed for the selected period, the backlight will dim to save battery power. The backlight will not dim if [HOLD] is selected.	—
<b>SLEEP</b>	The camera will enter sleep (energy saving) mode if no operations are performed for the selected period. The camera can be reactivated by pressing the shutter button halfway. [OFF] cancels the sleep mode.	—
<b>(Beep sound)</b>	When set to [OFF], you can turn off the beep sound that is emitted when the focus locks by pressing the shutter button.	—
<b>VOLUME</b>	Adjust playback volume.	15, 59, 62
<b>USB MODE</b>	Choose a mode for connecting the camera to a computer or printer. Choose [AUTO] to display USB mode options every time the camera is connected.	—

Option	Description	
<b>EV STEP</b>	Choose the size of the increments used when selecting shutter speed, aperture, exposure compensation, and other exposure parameters.	—
<b>METERING</b>	Choose a metering mode according to the scene.	39
<b>AEL METERING</b>	Choose the metering method used for AE lock (P. 39). [AUTO]: Use the currently selected metering method.	—
<b>ISO</b>	Set ISO sensitivity.	45
<b>ISO STEP</b>	Select the increments available for choosing ISO sensitivity.	—
<b>ISO-AUTO SET</b>	Choose the upper limit and default value used for ISO sensitivity when [AUTO] is selected for [ISO]. [HIGH LIMIT]: Choose the upper limit for auto ISO sensitivity selection. [DEFAULT]: Choose the default value for auto ISO sensitivity selection.	—

Option	Description	📖
<b>ISO-AUTO</b>	Choose the shooting modes in which [AUTO] ISO sensitivity is available. [P/A/S]: Auto ISO sensitivity selection is available in all modes except <b>M</b> . ISO sensitivity is fixed at ISO 200 in mode <b>M</b> . [ALL]: Auto ISO sensitivity selection is available in all modes.	—
<b>BULB TIMER</b>	You can set the maximum time for bulb shooting.	—
<b>ANTI-SHOCK [⬆]</b>	Choose the delay between the shutter button being pressed and the shutter being released. This diminishes camera shake caused by vibrations. This feature is useful in situations such as microscope photography and astrophotography. It is also useful for sequential shooting (P. 46) and self timer photography (P. 46).	—

⚙️ ⚡ **CUSTOM**

Option	Description	📖
⚡ <b>X-SYNC.</b>	Choose the shutter speed used when the flash fires.	104
⚡ <b>SLOW LIMIT</b>	Choose the slowest shutter speed available when a flash is used.	104
📷+📷	When set to [ON], it will be added to the exposure compensation value and flash intensity control will be performed.	38, 57

⚙️ ⬅️/ **COLOR/WB**

Option	Description	📖
<b>NOISE REDUCT.</b>	This function reduces the noise that is generated during long exposures. [AUTO]: Noise reduction is only performed at slow shutter speeds. [ON]: Noise reduction is performed with every shot. [OFF]: Noise reduction off. <ul style="list-style-type: none"> <li>Noise reduction requires about twice the time needed to record the image.</li> <li>Noise reduction turns off automatically during sequential shooting.</li> <li>This function may not work effectively with some shooting conditions or subjects.</li> </ul>	51
<b>NOISE FILTER</b>	Choose the amount of noise reduction performed at high ISO sensitivities.	—
<b>WB</b>	Choose the white balance mode.	40
<b>ALL</b> [WB%]	[ALL SET]: Use the same white balance compensation in all modes except [CWB]. [ALL RESET]: Set white balance compensation for all modes except [CWB] to 0.	—
<b>COLOR SPACE</b>	You can select how colors are reproduced on the monitor or printer.	—

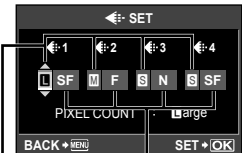
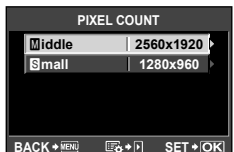
Option	Description	👉
<b>SHADING COMP.</b>	Choose [ON] to correct peripheral illumination according to the type of lens. <ul style="list-style-type: none"> <li>• Compensation is not available for teleconverters or extension tubes.</li> <li>• Noise may be visible at the edges of photographs taken at high ISO sensitivities.</li> </ul>	—
<b>← SET</b>	The record mode for JPEG photographs can be selected from four combinations of image size and compression rate. The camera offers a choice of three sizes and four compression rates for each combination. <div style="border: 1px solid black; padding: 5px; margin-top: 10px;"> <p><b>Modifying JPEG record modes</b></p> <ol style="list-style-type: none"> <li>Use &lt; &gt; to select a combination ([←:1] – [←:4]) and use Δ ∇ to change.</li> <li>Press Ⓞ.</li> </ol>  <p style="text-align: center;">Number of pixels      Compression rate</p> </div>	44
<b>PIXEL COUNT</b>	Choose the pixel count for [M]- and [S]-size images. <ol style="list-style-type: none"> <li>Select [PIXEL COUNT] in the ⚙️ Custom Menu (P. 78) 📷 tab.</li> <li>Select [M]iddle or [S]mall and press ▷.</li> <li>Choose a pixel count and press Ⓞ.</li> </ol> 	44

📷 RECORD/ERASE

Option	Description	👉
<b>QUICK ERASE</b>	If [ON] is selected, pressing the 🗑️ button in the playback display will immediately delete the current image.	—
<b>RAW+JPEG ERASE</b>	Choose the action performed when a photograph recorded at a setting of RAW+JPEG is erased in single-frame playback (P. 15). <ul style="list-style-type: none"> <li>[JPEG]: Only the JPEG copy is erased.</li> <li>[RAW]: Only the RAW copy is erased.</li> <li>[RAW+JPEG]: Both copies are erased.</li> <li>• [ALL ERASE] (P. 64) and [ERASE SELECTED] (P. 64) delete both RAW and JPEG copies.</li> </ul>	44

Option	Description	☞
<b>FILE NAME</b>	[AUTO]: Even when a new card is inserted, the file numbers are retained from the previous card. File numbering continues from the last number used or from the highest number available on the card. [RESET]: When you insert a new card, the folder numbers starts at 100 and the file name starts at 0001. If a card containing images is inserted, the file numbers start at the number following the highest file number on the card.	—
<b>EDIT FILENAME</b>	Choose how image files are named by editing the portion of the filename highlighted below in gray. sRGB: Pmdd0000.jpg _____ Pmdd AdobeRGB: _mdd0000.jpg _____ mdd	—
<b>PRIORITY SET</b>	Choose the default selection ([YES] or [NO]) for confirmation dialogs.	—
<b>dpi SETTING</b>	Choose the print resolution. [AUTO]: Print resolution is selected automatically according to image size. [CUSTOM]: Press ▷ to choose a print resolution.	—
<b>COPYRIGHT SETTINGS</b>	<p>Add the names of the photographer and copyright holder to new photographs. Names can be up to 63 characters long.</p> <p>[COPYRIGHT INFO.]: Select [ON] to include the names of the photographer and copyright holder in the Exif data for new photographs.</p> <p>[ARTIST NAME]: Enter the name of the photographer.</p> <p>[COPYRIGHT NAME]: Enter the name of the copyright holder.</p> <div style="border: 1px solid gray; padding: 10px; margin-top: 10px;"> <ol style="list-style-type: none"> <li>1) Highlight a character ② and press <b>OK</b> to add the highlighted character to the name ①.</li> <li>2) Repeat Step 1 to complete the name, then highlight [END] and press <b>OK</b>. <ul style="list-style-type: none"> <li>• To delete a character, press <b>INFO</b> to place the cursor in the name area ①, highlight the character, and press <b>INFO</b>.</li> </ul> </li> </ol> </div>	—

- OLYMPUS does not accept liability for damages arising from disputes involving the use of [COPYRIGHT SETTINGS]. Use at your own risk.

## MOVIE

MENU → →

Option	Description	
MODE	Choose a movie record mode. This option can also be selected using the live control.	58
MOVIE+STILL	Choose [ON] to record a photograph when movie recording ends.	88
MOVIE	Choose [OFF] to record silent movies. This option can also be selected using the live control.	59

## UTILITY

MENU → →

Option	Description	
PIXEL MAPPING	The pixel mapping feature allows the camera to check and adjust the image pickup device and image processing functions.	96
EXPOSURE SHIFT	Adjust optimal exposure separately for each metering mode. <ul style="list-style-type: none"> <li>• This reduces the number of exposure compensation options available in the selected direction.</li> <li>• The effects are not visible in the monitor. To make normal adjustments to the exposure, perform exposure compensation (P. 38).</li> </ul>	—
WARNING LEVEL	Choose the battery level at which the  warning is displayed.	6

## AEL/AFL

MENU → → → [AEL/AFL]

The **Fn** and buttons can be used for metering or autofocus. Choose a mode for each focus mode.

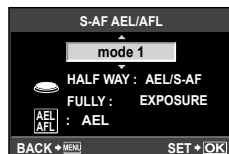

## AEL/AFL

Mode		Shutter button function				Fn button or  button function	
		Half-press		Full press		When holding down AEL/AFL	
		Focus	Exposure	Focus	Exposure	Focus	Exposure
S-AF	mode1	S-AF	Locked	—	—	—	Locked
	mode2	S-AF	—	—	Locked	—	Locked
	mode3	—	Locked	—	—	S-AF	—
C-AF	mode1	C-AF start	Locked	Locked	—	—	Locked
	mode2	C-AF start	—	Locked	Locked	—	Locked
	mode3	—	Locked	Locked	—	C-AF start	—
	mode4	—	—	Locked	Locked	C-AF start	—
MF	mode1	—	Locked	—	—	—	Locked
	mode2	—	—	—	Locked	—	Locked
	mode3	—	Locked	—	—	S-AF	—

## ■ ▽ FUNCTION, ▷ FUNCTION

MENU → → → [BUTTON FUNCTION] → [▽FUNCTION]/[▷FUNCTION]

The following functions can be assigned to the ▷ and ▽ buttons:

	The button performs the same function as the  button.
	The button performs the same function as the  button.
	The button performs the same function as the  button.
ISO	The button performs the same function as the ISO button.
WB	The button performs the same function as the WB button.

## ■ [Fn] FUNCTION, ◎ FUNCTION

MENU → → → [BUTTON FUNCTION] → [Fn] FUNCTION/[◎ FUNCTION]

The following functions can be assigned to the Fn and ◎ buttons:

<b>Fn FACE DETECT</b>	Pressing the <b>Fn</b> or ◎ button selects [ON] for [◎ FACE PRIORITY]; press the <b>Fn</b> or ◎ button again to turn it off (P. 37, 81).
<b>PREVIEW (electronic)</b>	Press and hold the <b>Fn</b> or ◎ button to stop aperture down to the selected value and preview depth of field (P. 49).
	Press the <b>Fn</b> or ◎ button to measure white balance (P. 41).
<b>[ ] HOME</b>	Press the <b>Fn</b> or ◎ button to select the home AF target position saved with [ ] SET HOME (P. 79). The home AF target position is indicated by a [ ] icon. Press the button again to return to AF target mode. If the camera is turned off when the home position is selected, the home position will be reset.
<b>MF</b>	Press the <b>Fn</b> or ◎ button to select [MF] for AF mode. Press the button again to restore the previously selected AF mode.
<b>RAW</b>	Press the <b>Fn</b> or ◎ button to toggle between JPEG and RAW+JPEG record modes.
<b>TEST PICTURE</b>	To take a photograph and display it in the monitor without recording it to the card, press the shutter button while the <b>Fn</b> or ◎ button is pressed.
<b>MYSET1–MYSET4</b>	Pictures taken while the <b>Fn</b> or ◎ button is pressed will be shot using the settings selected for [RESET/MYSET] (P. 33).
	Press the <b>Fn</b> or ◎ button to toggle between  and  when the waterproof protector is attached.
<b>AEL/AFL</b>	Press the <b>Fn</b> or ◎ button to lock focus and exposure.
◎ <b>REC</b>	Press the <b>Fn</b> or ◎ button to record a movie. If this option has not been assigned to either button, movies can be recorded by rotating the mode dial to .
<b>BACKLIT LCD</b>	Press the <b>Fn</b> or ◎ button to turn the monitor off. This is useful when you are using the electronic view finder. Press the button again to turn the monitor on.
<b>OFF</b>	No function is assigned to the <b>Fn</b> or ◎ button.

## Using the super control panel

The term “super control panel” refers to the display shown below, which lists shooting settings together with the option currently selected for each.

To use the super control panel, select [ON] for [CONTROL SETTINGS] > [SCP] (P. 80). To choose between the live control, super control panel, and other displays, press the **OK** button while the camera is in shooting mode and press the **INFO** button to cycle through the different displays.

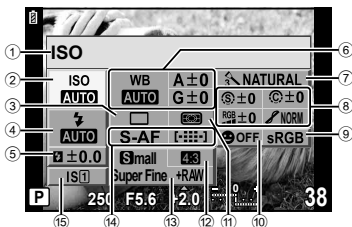

### ■ Settings that can be modified using super control panel

- |   |  |              |                               |
|---|--|--------------|-------------------------------|
| ① | Currently selected option                | Gradation    | P. 43                         |
| ② | ISO sensitivity ..... P. 45              | B&W Filter   | P. 43                         |
| ③ | Sequential shooting/self-timer.... P. 46 | Picture tone | P. 43                         |
| ④ | Flash mode ..... P. 56                   | ⑨            | Color space ..... P. 82       |
| ⑤ | Flash intensity control ..... P. 57      | ⑩            | Face priority ..... P. 37, 81 |
| ⑥ | White balance ..... P. 40                | ⑪            | Metering mode ..... P. 39     |
|   | White balance compensation.... P. 41     | ⑫            | Aspect ratio ..... P. 45      |
| ⑦ | Picture mode ..... P. 42                 | ⑬            | Record mode..... P. 44        |
| ⑧ | Sharpness                                | ⑭            | AF mode..... P. 34            |
|   | Contrast                                 |              | AF target ..... P. 35         |
|   | Saturation                               | ⑮            | Image stabilizer..... P. 47   |

### ! Caution

- Movie record mode is not displayed.

**1** After displaying the super control panel, select the desired setting using **Cursor** and press **OK**.

- You can also select settings using the control dial.

**2** Select an option using **◀▶** and press **OK**.

- Repeat steps 1 and 2 as necessary.
- The selected settings take effect automatically if no operations are performed for a few seconds.

**3** Press the shutter button halfway to return to shooting mode.

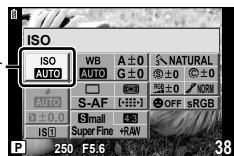

## Recording movies with the shutter button

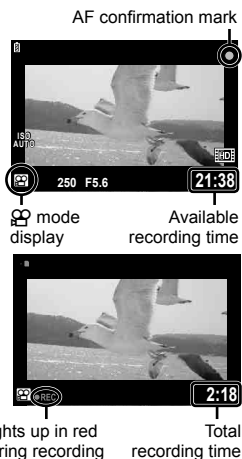

Movies are usually recorded using the  button, but the shutter button can be used if other functions have been assigned to both the **Fn** and  buttons.

- 1 Set the mode dial to .
- 2 Press the shutter button halfway down and focus on what you wish record.
  - When the subject is in focus, the AF confirmation mark lights up.
- 3 Press the shutter button all the way to begin recording.
  - **•REC** lights up while both movie and sound are recorded simultaneously.
- 4 Press the shutter button all the way to end recording.



## Taking a photograph when recording ends

Select [ON] for [MOVIE+STILL] to take a still picture when movie recording is finished. This feature is useful when you want to record a still picture as well as the movie.

- 1 Select [MOVIE+STILL] in  Custom Menu (P. 78) tab .
- 2 Select [ON] and press the .

### Caution

- This option is only available when the shutter button is used to record movies.





## Wireless remote control flash photography

External flash units that offer a remote control mode and are designated for use with this camera can be used for wireless flash photography. The built-in flash can independently control up to three groups of remote flash units. See the documentation provided with the external flash units for details.

### 1 Set the remote flash units to RC mode and place them as desired.

- Turn each flash unit on, press the MODE button, and select RC mode.
- Select a channel and group for each flash unit.

### 2 Select [ON] for [⚡ RC MODE] in Shooting menu 2 (P. 108).

- The super control panel switches to RC mode.
- You can choose a super control panel display by repeatedly pressing the **INFO** button.
- Select a flash mode (note that red-eye reduction is not available in RC mode).

### 3 Adjust the settings for each group in the super control panel.

#### Group

- Select the flash control mode and adjust the flash intensity individually for groups A, B, and C. For **MANUAL**, select the flash intensity.

Flash intensity value

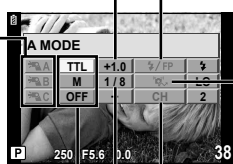

Flash control mode

Flash intensity

Normal flash/Super FP flash  
• Switch between normal flash and Super FP flash.

Communication light level  
• Set the communication light level to [HI], [MID], or [LO].

Channel  
• Set the communication channel to the same channel used on the flash.

### 4 Press the UP button to raise the built-in flash.

- After confirming that the built-in and remote flash units have charged, take a test shot.

#### ■ Wireless flash control range

Position the wireless flash units with their remote sensors facing the camera. The following illustration shows the approximate ranges at which the flash units can be positioned. The actual control range varies with local conditions.

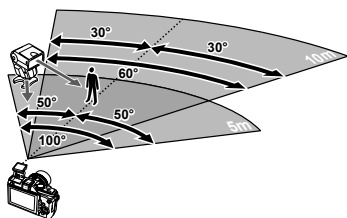



#### ⚠ Caution



- The built-in flash can not be used as a light source in RC mode.
- We recommend using a single group of up to three remote flash units.
- Remote flash units can not be used for second curtain slow synchronization or anti-shock exposures longer than 4 seconds.
- If the subject is too close to the camera, the control flashes emitted by the built-in flash may affect exposure (this effect can be reduced by reducing the output of the built-in flash by, for example, using a diffuser).

## Accessory port menu options



Adjust settings for such optional accessories as electronic viewfinders or the OLYMPUS PENPAL. The accessory port menu can be displayed using [\*/MENU DISPLAY].

### OLYMPUS PENPAL SHARE

MENU →   



Option	Description	
PLEASE WAIT	Receive images and add hosts to the address book.	68
ADDRESS BOOK	[ADDRESS LIST]: View the hosts that have been saved to the address book. [NEW PAIRING]: Add a host to the address book. [SEARCH TIMER]: Choose how long the camera searches for a host.	69
MY OLYMPUS PENPAL	Display information for your OLYMPUS PENPAL, including the name, address, and supported services. Press  to edit the device name.	69
PICTURE SEND SIZE	Choose the size at which images are transmitted. [SIZE 1: SMALL]: Images are sent at a size equivalent to 640 × 480. [SIZE 2: LARGE]: Images are sent at a size equivalent to 1920 × 1440. [SIZE 3: MEDIUM]: Images are sent at a size equivalent to 1280 × 960.	68







### OLYMPUS PENPAL ALBUM

MENU →   

Option	Description	
COPY ALL	All images and sound files are copied between the memory card and OLYMPUS PENPAL. Copied images are resized according to the option selected for picture copy size.	69
RESET PROTECT	Remove protection from all pictures in the OLYMPUS PENPAL album.	69
ALBUM MEM. USAGE	Show the number of pictures currently in the album and the number of additional pictures that can be stored at [SIZE 2: MEDIUM].	69
ALBUM MEM. SETUP	[ALL ERASE]: Delete all pictures in the album. [FORMAT ALBUM]: Format the album.	69
PICTURE COPY SIZE	Choose the size at which images are copied. [SIZE 1: LARGE]: Copied images are not resized. [SIZE 2: MEDIUM]: Images are copied at a size equivalent to 1920 × 1440.	69

### ELECTRONIC VIEWFINDER

MENU →   

Option	Description	
EVF ADJUST	Adjust the brightness and color temperature of the electronic viewfinder. The selected color temperature is also used in the monitor during playback. Use   to select color temperature (  ) or brightness (  ) and use   to choose from values between [+7] and [-7].	103



## Shooting tips and information

### The camera does not turn on even when a battery is loaded

#### The battery is not fully charged

- Charge the battery with the charger.

#### The battery is temporarily unable to function because of the cold

- Battery performance drops at low temperatures. Remove the battery and warm it by putting it in your pocket for a while.

### No picture is taken when the shutter button is pressed

#### The camera has turned off automatically

- The camera automatically enters sleep mode to reduce the drain on the battery if no operations are performed for a set period of time.  [SLEEP] (P. 13)  
If no operations are performed for a set time (5 minutes) after the camera has entered sleep mode, the camera will turn off automatically.

#### The flash is charging

- On the LCD monitor, the  mark blinks when charging is in progress. Wait for the blinking to stop, then press the shutter button.

#### Unable to focus

- The camera can not focus on subjects that are too close to the camera or that are not suited to autofocus (the AF confirmation mark will blink in the monitor). Increase the distance to the subject or focus on a high contrast object at the same distance from the camera as your main subject, compose the shot, and shoot.

#### Subjects that are difficult to focus on

It may be difficult to focus with auto focus in the following situations.

AF confirmation mark is blinking. These subjects are not focused.



Subject with low contrast

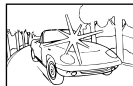

Excessively bright light in center of frame

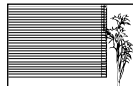

Subject containing no vertical lines

AF confirmation mark lights up but the subject is not focused.



Subjects at different distances

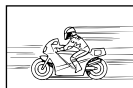

Fast-moving subject



Subject not inside AF area

### Noise reduction is activated

- When shooting night scenes, shutter speeds are slower and noise tends to appear in images. The camera activates the noise-reduction process after shooting at slow shutter speeds. During which, shooting is not allowed. You can set [NOISE REDUCT.] to [OFF].  “Custom menu” (P. 78)

### The date and time has not been set

#### The camera is used with the settings at the time of purchase

- The date and time of the camera is not set when purchased. Set the date and time before using the camera.  “Setting the date/time” (P. 7)

#### The battery has been removed from the camera

- The date and time settings will be returned to the factory default settings if the camera is left without the battery for approximately 1 day. The settings will be cancelled more quickly if the battery was only loaded in the camera for a short time before being removed. Before taking important pictures, check that the date and time settings are correct.

### Set functions are restored to their factory default settings

When you rotate the mode dial or turn off the power in a shooting mode other than **P**, **A**, **S**, or **M**, functions with changes made to their settings are restored to the factory default settings.

### Image taken appears whitish

This may occur when the picture is taken in backlight or semi-backlight conditions. This is due to a phenomenon called flare or ghosting. As far as possible, consider a composition where strong light source is not taken in the picture. Flare may occur even when a light source is not present in the picture. Use a lens hood to shade the lens from the light source. If a lens hood does not have effect, use your hand to shade the lens from the light.  “Interchangeable lenses” (P. 98)

### Unknown bright dot(s) appear on the subject in the picture taken









This may be due to stuck pixel(s) on the image pickup device. Perform [PIXEL MAPPING]. If the problem persists, repeat pixel mapping a few times.  “Pixel mapping - Checking the image processing functions” (P. 96)









### Functions that cannot be selected from menus

Some items may not be selectable from the menus when using the arrow pad.

- Items that cannot be set with the current shooting mode
- Items that cannot be set because of an item that has already been set: Combination of  and [NOISE REDUCT.], etc.

## Error codes

Monitor indication	Possible cause	Corrective action
 NO CARD	The card is not inserted, or it cannot be recognized.	Insert a card or insert a different card.
 CARD ERROR	There is a problem with the card.	Insert the card again. If the problem persists, format the card. If the card cannot be formatted, it cannot be used.
 WRITE PROTECT	Writing to the card is prohibited.	The card write-protect switch is set to the "LOCK" side. Release the switch. (P. 96)
 CARD FULL	<ul style="list-style-type: none"> <li>The card is full. No more pictures can be taken or no more information such as print reservation can be recorded.</li> <li>There is no space in the card and print reservation or new images cannot be recorded.</li> </ul>	Replace the card or erase unwanted pictures. Before erasing, download important images to a PC.
	Card cannot be read. Card may not have been formatted.	<ul style="list-style-type: none"> <li>Select [CLEAN CARD], press the <b>OK</b> button and turn off the camera. Remove the card and wipe dry the metallic surface with a soft, dry cloth.</li> <li>Select [FORMAT] ▶ [YES], and then press the <b>OK</b> button to format the card. Formatting the card erases all data on the card.</li> </ul>
 NO PICTURE	There are no pictures on the card.	The card contains no pictures. Record pictures and play back.
 PICTURE ERROR	The selected picture cannot be displayed for playback due to a problem with this picture. Or the picture cannot be used for playback on this camera.	Use image processing software to view the picture on a PC. If that cannot be done, the image file is damaged.
 THE IMAGE CANNOT BE EDITED	Pictures taken with another camera cannot be edited on this camera.	Use image processing software to edit the picture.
 PICTURE ERROR	Images can not be transferred between devices that are currently receiving or transmitting data.	Increase the amount of memory available on the card, for example by deleting unwanted images, or choose a smaller size for the images being transmitted.

Monitor indication	Possible cause	Corrective action
		Turn off the camera and wait for the internal temperature to cool.
 Internal camera temperature is too high. Please wait for cooling before camera use.	The internal temperature of the camera has risen due to sequential shooting.	Wait a moment for the camera to turn off automatically. Allow the internal temperature of the camera to cool before resuming operations.
 BATTERY EMPTY	The battery is drained.	Charge the battery.
 NO CONNECTION	The camera is not connected to the computer or printer correctly.	Disconnect the camera and connect it again correctly.
 NO PAPER	There is no paper in the printer.	Load some paper in the printer.
 NO INK	The printer has run out of ink.	Replace the ink cartridge in the printer.
 JAMMED	The paper is jammed.	Remove the jammed paper.
SETTINGS CHANGED	The printer's paper cassette has been removed or the printer has been manipulated while making settings on the camera.	Do not manipulate the printer while making settings on the camera.
 PRINT ERROR	There is a problem with the printer and/or camera.	Turn off camera and printer. Check the printer and remedy any problems before turning the power on again.
 CANNOT PRINT	Pictures recorded on other cameras may not be printed on this camera.	Use a personal computer to print.
The lens is locked. Please extend the lens.	The lens of the retractable lens stays retracted.	Extend the lens. (P. 12)
Please check the status of a lens.	An abnormality has occurred between the camera and the lens.	Turn off the camera, check the connection with the lens, and turn the power on again.

## Cleaning and storing the camera

### Cleaning the camera

Turn off the camera and remove the battery before cleaning the camera.

#### Exterior:

- Wipe gently with a soft cloth. If the camera is very dirty, soak the cloth in mild soapy water and wring well. Wipe the camera with the damp cloth and then dry it with a dry cloth. If you have used the camera at the beach, use a cloth soaked in clean water and well wrung.

#### LCD monitor:

- Wipe gently with a soft cloth.

#### Lens:

- Blow dust off the lens with a commercially available blower. For the lens, wipe gently with a lens cleaning paper.

### Storage

- When not using the camera for a prolonged period, remove the battery and card. Store the camera in a cool, dry place that is well ventilated.
- Insert the battery periodically and test the camera's functions.
- Remove dust and other foreign matter from the body and rear caps before attaching them.
- Attach the body cap to the camera to prevent dust from getting inside when no lens is attached. Be sure to replace the front and rear lens caps before putting the lens away.
- Clean the camera after use.
- Do not store with insect repellent.

### Cleaning and checking the image pickup device

This camera incorporates a dust reduction function to keep dust from getting on the image pickup device and to remove any dust or dirt from the image pickup device surface with ultrasonic vibrations. The dust reduction function operates when the camera is turned on.



The dust reduction function operates at the same time as the pixel mapping, which checks the image pickup device and image processing circuitry. Since dust reduction is activated every time the camera's power is turned on, the camera should be held upright for the dust reduction function to be effective.



#### **Caution**

- Do not use strong solvents such as benzene or alcohol, or a chemically treated cloth.
- Avoid storing the camera in places where chemicals are treated, in order to protect the camera from corrosion.
- Mold may form on the lens surface if the lens is left dirty.
- Check each part of the camera before use if it has not been used for a long time. Before taking important pictures, be sure to take a test shot and check that the camera works properly.

## Pixel mapping - Checking the image processing functions

The pixel mapping feature allows the camera to check and adjust the image pickup device and image processing functions. After using the monitor or taking continuous shots, wait for at least one minute before using the pixel mapping function to ensure that it operates correctly.

**1** Select [PIXEL MAPPING] in  Custom Menu (P. 78) tab .

**2** Press , then press the  button.

- The [BUSY] bar is displayed when pixel mapping is in progress. When pixel mapping is finished, the menu is restored.

### **Caution**

- If you accidentally turn the camera off during pixel mapping, start again from Step 1.

## Card basics

### Usable cards

In this manual, all storage devices are referred to as “cards.”

The following types of SD memory card (available separately) can be used with this camera: SD, SDHC, and SDXC. For the latest information, please visit the Olympus website.



#### SD card write protect switch

The SD card body has a write protect switch. If you set the switch to the “LOCK” side, you will not be able to write to the card, delete data or format. Return the switch to the unlock position enable writing.

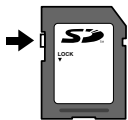

### **Caution**

- The data in the card will not be erased completely even after formatting the card or deleting the data. When discarding, destroy the card to prevent leakage of personal information.

## Formatting the card

Cards formatted on a computer or other camera must be formatted with the camera before they can be used.

All data stored on the card, including protected images, is erased when the card is formatted. When formatting a used card, confirm there are no images that you still want to keep on the card.

**1** Select [CARD SETUP] in shooting menu  (P. 108).

**2** Select [FORMAT].

**3** Select [YES] and press .

- Formatting is performed.

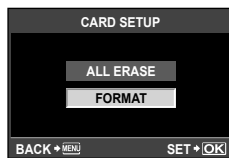



## Battery and charger

- Use the single Olympus lithium-ion battery (BLS-5). Batteries other than genuine OLYMPUS BLS-5 batteries can not be used.
- The camera's power consumption varies widely with usage and other conditions.
- As the following consume a lot of power even without shooting, the battery will be drained quickly.
  - Performing auto focus repeatedly by pressing the shutter button halfway in shooting mode.
  - Displaying images on the LCD monitor for a prolonged period.
  - When connected to a computer or printer.
- When using a drained battery, the camera may turn off without the low battery warning being displayed.
- The battery will not be fully charged at the time of purchase. Charge the battery using the provided charger (BCS-5) before use.
- The normal charging time using the provided charger is approximately 3 hours 30 minutes (estimated).
- Do not attempt to use chargers not specifically designated for use with the supplied battery, or to use batteries not specifically designated for use with the supplied charger.

### **Caution**

- There is a risk of explosion if the battery is replaced with the incorrect battery type. Dispose of the used battery following the instructions. "Battery Handling Precautions" (P. 115)

## Using your charger abroad

- The charger can be used in most home electrical sources within the range of 100 V to 240 V AC (50/60 Hz) around the world. However, depending on the country or area you are in, the AC wall outlet may be shaped differently and the charger may require a plug adapter to match the wall outlet. For details, ask at your local electrical shop or travel agent.
- Do not use commercially available travel adaptors as the charger may malfunction.

## Interchangeable lenses

Choose a lens according to the scene and your creative intent. Use lenses designed exclusively for the Micro Four Thirds System, which bear the symbol shown at right. With an adapter, you can also use Four Thirds System and OM System lenses.



### M.ZUIKO DIGITAL interchangeable lenses

This is an interchangeable lens specifically for use with the “Micro Four Thirds system” which is a smaller, thinner version of the “Four Thirds system”.

#### Micro Four Thirds System lenses

Cameras designed for the Micro Four Thirds System do away with the bulky mirror box and viewfinder found in ordinary single-lens reflex cameras, resulting in a camera body that is substantially more compact. Similarly, lens design is matched to the camera for a compact, light-weight photo system. One characteristic of Micro Four Thirds System lenses is that they can achieve magnifications equivalent to double those produced by 35 mm format cameras with lenses of the same focal length, producing high-power lenses that are light and compact. For example, a Micro Four Thirds System lens with a focal length of 14–42 mm is equivalent to a 35 mm format lens with a focal length of 28–84 mm. The aperture of a Micro Four Thirds System lens can also be made smaller than that of a 35 mm format lens, making it possible to achieve a lens with the same brightness (f-number) in a smaller package. The brighter the lens, the faster the shutter speeds that can be achieved under low-light conditions.

#### ! Caution

- When you attach or remove the body cap and lens from the camera, keep the lens mount on the camera pointed downward. This helps prevent dust and other foreign matter from getting inside the camera.
- Do not remove the body cap or attach the lens in dusty places.
- Do not point the lens attached to the camera toward the sun. This may cause the camera to malfunction or even ignite due to the magnifying effect of sunlight focusing through the lens.
- Be careful not to lose the body cap and rear cap.

## M.ZUIKO DIGITAL lens specifications

### ■ Names of parts

- ① Filter mount thread
- ② Zoom ring (zoom lenses only)
- ③ Focus ring
- ④ Mount index
- ⑤ Electrical contacts
- ⑥ Front cap
- ⑦ Rear cap

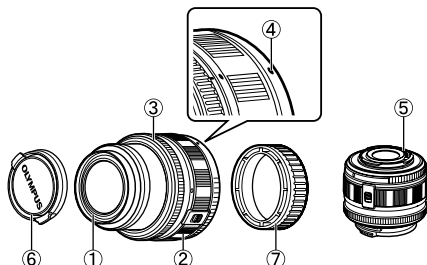

### ■ Lens and camera combinations

Lens	Camera	Attachment	AF	Metering
Micro Four Thirds system lens	Micro Four Thirds system camera	Yes	Yes	Yes
Four Thirds system lens		Attachment possible with mount adapter	Yes* <sup>1</sup>	Yes
OM System lenses			No	Yes* <sup>2</sup>
Micro Four Thirds system lens	Four Thirds System Camera	No	No	No

\*1 [C-AF] and [C-AF+TR] of [AF MODE] cannot be used.

\*2 Accurate metering not possible.

### ■ Main Specifications

Items	14–42 mm II	17 mm	40–150 mm	14–150 mm
Mount	Micro Four Thirds mount			
Focal length	14–42 mm	17 mm	40–150 mm	14–150 mm
Max. aperture	f/3.5–5.6	f/2.8	f/4–5.6	f/4–5.6
Image angle	75°–29°	64.9°	30.3°–8.2°	75°–8.2°
Lens configuration	7 groups, 8 lenses	4 groups, 6 lenses	10 groups, 13 lenses	11 groups, 15 lenses
	Multilayer film coating			
Iris control	f/3.5–22	f/2.8–22	f/4.0–22	f/4.0–22
Shooting range	0.25 m–∞	0.2 m–∞	0.9 m–∞	0.5 m–∞
Focus adjustment	AF/MF switching			
Weight (excluding hood and cap)	112 g	71 g	190 g	260 g
Dimensions (Max. diameter × overall length)	ø56.5×50 mm	ø57×22 mm	ø63.5×83 mm	ø63.5×83 mm
Filter mount thread diameter	37 mm	37 mm	58 mm	58 mm

### ! Caution

- Edges of pictures may be cut off if more than one filter is used or if a thick filter is used.

Download from [Www.Somanuals.com](http://Www.Somanuals.com). All Manuals Search And Download.

## Mount adapter

Mount adapter allows the camera to be used with lenses that do not conform to the Micro Four Thirds System standard.

### ■ Names of parts

- ① Front cap
- ② Mount index
- ③ Lens release button
- ④ Rear cap

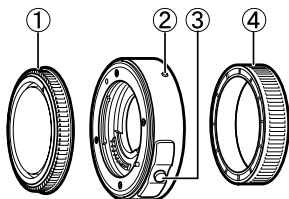

### ■ Mounting

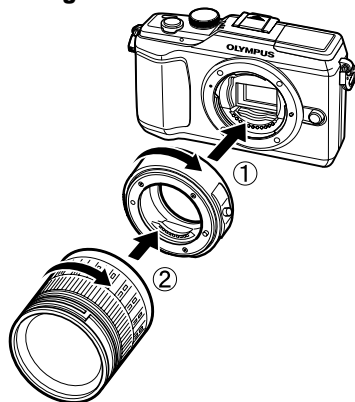

## Four Thirds lens adapter (MMF-2)

The camera requires MMF-2 Four Thirds lens adapter to attach Four Thirds lenses such as those used with the E-3 and E-620. Some features, such as autofocus, may not be available.

## OM adapter (MF-2)

Use with existing OLYMPUS OM System lenses. Focus and aperture must be adjusted manually. Image stabilization can be used. Input the focal length of the lens being used in the camera image stabilization settings.

## Remote cable (RM-UC1)

Use when the slightest camera movement can result in blurred pictures, for example for macro or bulb photography. The remote cable attaches via the camera USB connector.

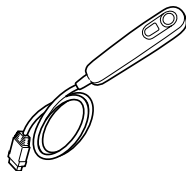

## Lens attachments

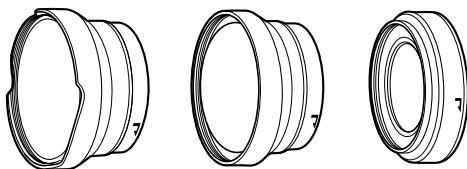

Lens attachments	Supported lenses	Use for
Fisheye (FCON-P01)	M.ZUIKO.14-42 mm II	120° fisheye photography
Wide (WCON-P01)	M.ZUIKO.14-42 mm II	Focal lengths of 11 mm (35mm format equivalent: 22mm)
Macro (MCON-P01)	M.ZUIKO.14-42 mm II M.ZUIKO.40-150 mm M.ZUIKO.14-150 mm	Supports macro photography.

- Use the appropriate lens attachment for **SCN** mode (📷, 📷, or 📷). In other modes, select [OFF] for [IMAGE STABILIZER].

## MACRO ARM LIGHT (MAL-1)

Use to illuminate subjects for macro photography, even at ranges at which vignetting would occur with the flash.

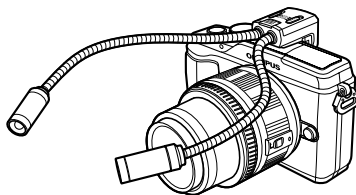

## Microphone Set (SEMA-1)

Produces higher-quality recordings than the camera's built-in microphone. The microphone can be placed at a distance from the camera to avoid recording ambient sounds or wind noise. Third-party commercial microphones can also be used depending on your creative intent (power supplied via  $\phi 3.5$  mm stereo mini-plug).

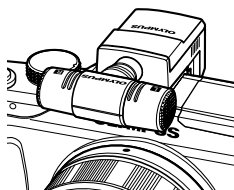

## Using electronic view finder (sold separately)

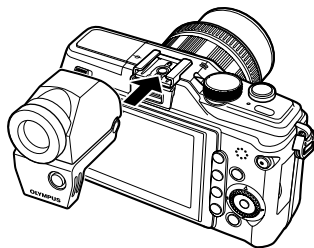

If you use the electronic view finder (sold separately: VF-2), you can view the shooting screen in the finder. This is convenient when you are in a very bright location, such as under direct sunlight, where it is difficult to view the monitor, or are using the camera at a low angle. Also refer to the electronic view finder's manual.

- 1 Turn off the camera.
- 2 Slide off the hot shoe cover.
  - Keep the shoe cover in a safe place to avoid losing it.
- 3 Remove the connector cover from the electronic view finder.



- 4 Align the electronic view finder with the hot shoe on the camera body, and slide it in until it stops.
  - Insert the electronic view finder by pushing on its lower part.

- 5 Turn on the camera.

- 6 Each press of the  button switches between the monitor display and electronic view finder display.
  - You can adjust the brightness and color temperature of the electronic view finder. [EVF ADJUST]:  "Accessory port menu options" (P. 90)

- 7 Turn the diopter adjustment ring to a position where the image on the viewfinder can be seen clearly.

- Adjust the electronic view finder to your preferred angle (up to 90 degrees).

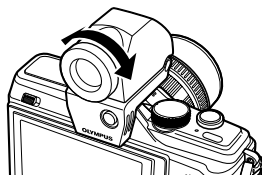

### Caution

- You cannot use an external flash and the electronic view finder at the same time.
- When carrying the camera, do not hold it by the electronic view finder. The camera may separate from the electronic view finder and drop.
- Do not leave the camera with the electronic view finder attached in a location subject to direct sunlight.

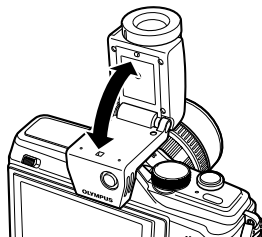

## Program line diagram (P mode)

In the **P** mode, the camera is programmed such that the aperture value and shutter speed are automatically selected according to the subject's brightness as shown below. The program line diagram varies with the type of lens mounted.

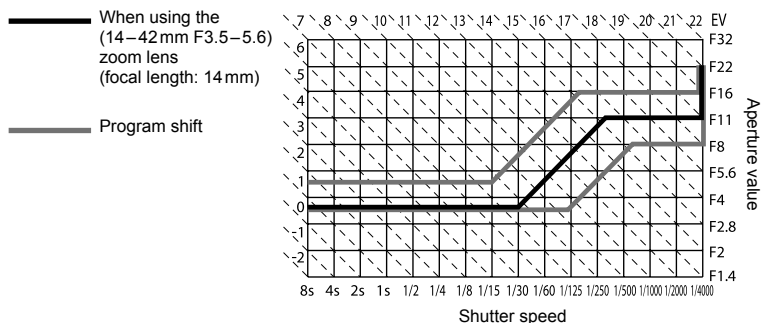

## Exposure warning display

If the optimum exposure cannot be obtained when pressing the shutter button halfway, the display will blink on the LCD monitor.

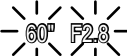
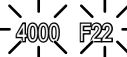
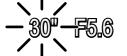
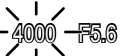
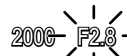
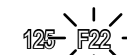
Shooting mode	Warning display example (blinking)	Status	Action
<b>P</b>		The subject is too dark.	<ul style="list-style-type: none"> <li>• Increase the ISO sensitivity.</li> <li>• Use the flash.</li> </ul>
		The subject is too bright.	<ul style="list-style-type: none"> <li>• Decrease the ISO sensitivity.</li> <li>• Use a commercially available ND filter (for adjusting the amount of light).</li> </ul>
<b>A</b>		The subject is underexposed.	<ul style="list-style-type: none"> <li>• Decrease the aperture value.</li> <li>• Increase the ISO sensitivity.</li> </ul>
		The subject is overexposed.	<ul style="list-style-type: none"> <li>• Increase the aperture value.</li> <li>• Decrease the ISO sensitivity or use a commercially available ND filter (for adjusting the amount of light).</li> </ul>
<b>S</b>		The subject is underexposed.	<ul style="list-style-type: none"> <li>• Set the shutter speed slower.</li> <li>• Increase the ISO sensitivity.</li> </ul>
		The subject is overexposed.	<ul style="list-style-type: none"> <li>• Set the shutter speed faster.</li> <li>• Decrease the ISO sensitivity or use a commercially available ND filter (for adjusting the amount of light).</li> </ul>

- The aperture value at the moment when its indication blinks varies with the lens type and focal length of the lens.

## Flash modes that can be set by shooting mode

Shooting Mode	Super control panel	Flash Mode	Flash timing	Conditions for firing the flash	Shutter speed limit
P/A	AUTO	Auto flash	1st curtain	Fires automatically in dark/backlit* conditions	1/30sec. – 1/180sec.
		Auto flash (red-eye reduction)			
		Fill-in flash			
		Flash off	—	—	—
	SLOW	Slow synchronization (red-eye reduction)	1st curtain	Fires automatically in dark/backlit* conditions	60sec. – 1/180sec.
	SLOW	Slow synchronization (1st curtain)			
SLOW2	Slow synchronization (2nd curtain)	2nd curtain			
SLOW2	Slow synchronization (2nd curtain)	2nd curtain			
S/M		Fill-in flash	1st curtain	Always fires	60sec. – 1/180sec.
		Fill-in flash (red-eye reduction)			
		Flash off	—	—	—
	2nd CURTAIN	Fill-in flash/Slow synchronization (2nd curtain)	2nd curtain	Always fires	60sec. – 1/180sec.

\* When the flash is set to the Super FP mode, it detects backlight and fires with a longer duration than for normal flash before emitting light.

- **AUTO**, can be set in **AUTO** mode.

## Flash synchronization and shutter speed

Shooting mode	Flash timing	Upper limit of synchronization timing*1	Fixed timing when flash fires*2
<b>P</b>	1/ (lens focal length × 2) or synchronization timing, whichever is slower	1/180	1/60
<b>A</b>			
<b>S</b>	The set shutter speed		—
<b>M</b>			

\*1 Can be changed using menu: 1/60–1/180 [ X-SYNC.]: “Custom menu” (P. 78)

\*2 Can be changed using menu: 30–1/180 [ SLOW LIMIT]: “Custom menu” (P. 78)

## Manual flash guide numbers for the built-in flash

FULL	Manual (FULL)	10
1/4	Manual (1/4)	5
1/16	Manual (1/16)	2.5
1/64	Manual (1/64)	1.2

- All figures are approximate and given in meters (ISO 200).



## Flash range

Flash range can be calculated as shown below.

$$\text{Flash range (m)} = \frac{\text{GN (ISO 200)} \times \text{ISO sensitivity factor}}{\text{Aperture (f-number)}}$$

### GN (ISO200)

Depending on flash output, the Guide Number (GN) may be from 1.4 (minimum) to 10 (FULL).

### ISO sensitivity factor

	ISO sensitivity (x)						$K = \sqrt{\frac{X}{200}}$
	200	400	800	1600	3200	6400	
ISO sensitivity factor (K)	1.0	1.4	2.0	2.8	4.0	5.6	

### Aperture (f-number)

Aperture can be set to values between the maximum aperture for the lens and  $f/22$ . Check the maximum aperture for the lens.

### Minimum range

The lens may cast shadows over objects close to the camera, causing vignetting, or be too bright even at minimum output.

Lens	Approximate distance at which vignetting occurs
14–42 mm	0.35 m
17 mm	0.25 m
40–150 mm	1.0 m
14–150 mm	Flash can not be used

- Use optional off-camera flash units to prevent vignetting. To prevent photographs from being overexposed, select mode **A** or **M** and choose a high f-number, or reduce ISO sensitivity.

## External flash shooting

With this camera, you can use one of the separately sold external flash units to achieve a flash suited to your needs. The external flashes communicate with the camera, allowing you to control the camera's flash modes with various available flash control modes, such as TTL-AUTO and Super FP flash.

An external flash unit specified for use with this camera can be mounted on the camera by attaching it to the camera's hot shoe. You can also attach the flash to the flash bracket on the camera using the bracket cable (optional). Refer to the documentation provided with the external flash units as well.

### Functions available with external flash units

Optional flash	Flash control mode	GN (Guide number)(ISO100)	RC mode
<b>FL-50R</b>	TTL-AUTO, AUTO, MANUAL,	GN50 (85 mm*) GN28 (24 mm*)	✓
<b>FL-36R</b>	FP TTL AUTO, FP MANUAL	GN36 (85 mm*) GN20 (24 mm*)	✓
<b>FL-20</b>	TTL-AUTO, AUTO,	GN20 (35 mm*)	–
<b>FL-14</b>	MANUAL	GN14 (28 mm*)	–
<b>RF-11</b>		GN11	–
<b>TF-22</b>	TTL-AUTO, MANUAL	GN22	–

\* The focal length of the lens that can be used (Calculated based on 35 mm film camera).

## Settings stored using MYSET

Function	MYSET registration
	✓
IMAGE STABILIZER	✓
	✓
FLASH MODE	✓
PICTURE MODE	✓
	✓
STILL PICTURE	✓
	✓
MOVIE	✓
IMAGE ASPECT	✓
	✓
RC MODE	✓
AE BKT	✓
WB BKT	✓
FL BKT	✓
ISO BKT	✓
MULTIPLE EXPOSURE	—
	—
	—
X-SYNC.	✓
	✓
SLOW LIMIT	✓
	✓
NOISE REDUCT.	✓
NOISE FILTER	✓
WB	✓
ALL	—
COLOR SPACE	✓
SHADING COMP.	✓
	✓
PIXEL COUNT	✓
QUICK ERASE	✓
RAW+JPEG ERASE	✓
FILE NAME	—
EDIT FILENAME	—
PRIORITY SET	—
dpi SETTING	—
	—
MOVIE+STILL	✓
MOVIE	✓
PIXEL MAPPING	—
EXPOSURE SHIFT	✓
	—
WARNING LEVEL	—
Shooting mode	✓
Tone control	✓
Aperture value	✓
Shutter speed	✓
REC VIEW	✓
	—
MENU DISPLAY	—
FIRMWARE	—
AF MODE	✓
STILL PICTURE	✓
MOVIE	✓
AF AREA	✓
RESET LENS	—
BULB FOCUSING	—
FOCUS RING	✓
MF ASSIST	✓
	—
SET HOME	—
AEL/AFL	✓
AEL/AFL MEMO	✓
BUTTON FUNCTION	✓
BUTTON TIMER	—
DIAL FUNCTION	✓
DIAL DIRECTION	✓
	✓
LOCK	✓
RLS PRIORITY S	✓
RLS PRIORITY C	✓
HDMI	—
VIDEO OUT	—
SLEEP	✓
LIVE VIEW BOOST	✓
	✓
FACE PRIORITY	✓
	✓
INFO SETTINGS	✓
	✓
CONTROL SETTINGS	✓
HISTOGRAM SETTINGS	—

Function	MYSET registration
EVF ADJUST	—
BACKLIT LCD	✓
MODE GUIDE	—
	—
CLOSEUP MODE	—
	✓
VOLUME	—
USB MODE	—
EV STEP	✓
METERING	✓
AEL METERING	✓
ISO	✓
ISO STEP	✓
ISO-AUTO SET	✓
ISO-AUTO	✓
BULB TIMER	✓
ANTI-SHOCK [♦]	✓
X-SYNC.	✓
SLOW LIMIT	✓
	✓
NOISE REDUCT.	✓
NOISE FILTER	✓
WB	✓
ALL	—
COLOR SPACE	✓
SHADING COMP.	✓
	✓
PIXEL COUNT	✓
QUICK ERASE	✓
RAW+JPEG ERASE	✓
FILE NAME	—
EDIT FILENAME	—
PRIORITY SET	—
dpi SETTING	—
	—
MOVIE+STILL	✓
MOVIE	✓
PIXEL MAPPING	—
EXPOSURE SHIFT	✓
	—
WARNING LEVEL	—
Shooting mode	✓
Tone control	✓
Aperture value	✓
Shutter speed	✓

✓ : Can be registered.

— : Cannot be registered.

\* Includes anti-shock.

## Record mode and file size/number of storable still pictures

The file size in the table is approximate for files with a 4:3 aspect ratio.

Record mode	Number of pixels (PIXEL COUNT)	Compression	File format	File size (MB)	Number of storable still picture <sup>*1</sup>
RAW	4032×3024	Loss-less compression	ORF	Approx. 14	54
L SF		1/2.7		Approx. 8.4	101
L F		1/4		Approx. 5.9	145
L N		1/8		Approx. 2.7	320
L B		1/12		Approx. 1.8	477
M SF	3200×2400	1/2.7	JPEG	Approx. 5.6	154
M F		1/4		Approx. 3.4	255
M N		1/8		Approx. 1.7	504
M B		1/12		Approx. 1.2	747
M SF		1/2.7		Approx. 3.2	269
M F	2560×1920	1/4	JPEG	Approx. 2.2	395
M N		1/8		Approx. 1.1	776
M B		1/12		Approx. 0.8	1143
M SF		1/2.7		Approx. 1.8	473
M F		1/4		Approx. 1.3	696
M N	1920×1440	1/8	JPEG	Approx. 0.7	1346
M B		1/12		Approx. 0.5	1954
M SF		1/2.7		Approx. 1.3	673
M F		1/4		Approx. 0.9	993
M N		1/8		Approx. 0.5	1893
M B	1600×1200	1/12	JPEG	Approx. 0.4	2753
S SF		1/2.7		Approx. 0.9	1044
S F		1/4		Approx. 0.6	1514
S N		1/8		Approx. 0.3	2884
S B		1/12		Approx. 0.3	4038
S SF	1024×768	1/2.7	JPEG	Approx. 0.6	1594
S F		1/4		Approx. 0.4	2243
S N		1/8		Approx. 0.3	4038
S B		1/12		Approx. 0.2	5507
S SF		1/2.7		Approx. 0.3	3563
S F	640×480	1/4	JPEG	Approx. 0.2	5048
S N		1/8		Approx. 0.2	8654
S B		1/12		Approx. 0.1	10096









\*1 Assumes a 1GB SD card.

### ! Caution







- The number of remaining pictures may change according to the subject, whether or not print reservations have been made, and other factors. In certain instances, the number of remaining pictures displayed on the LCD monitor will not change even when you take pictures or erase stored images.
- The actual file size varies according to the subject.
- The maximum number of storable still pictures displayed on the monitor is 9999.
- For the available recording time for movies, see the Olympus website.

## Menu directory













### Shooting Menu

Tab	Function		Default		
	CARD SETUP		—	64, 93	
	RESET/MYSET		—	33	
	PICTURE MODE		 NATURAL	42	
		STILL PICTURE	 N	44	
		MOVIE	HD		
IMAGE ASPECT		4:3	45		
	 IMAGE STABILIZER		<input type="checkbox"/>	46	
	IMAGE STABILIZER		IS.1	47	
	BRACKETING	AE BKT		OFF	54
		WB BKT	A-B	OFF	55
			G-M		
		FL BKT		OFF	55
		ISO BKT		OFF	55
	MULTIPLE EXPOSURE	FRAME		OFF	53
		AUTO GAIN		OFF	
		OVERLAY		OFF	
			±0.0	57	
 RC mode		OFF	89		

### Playback Menu

Tab	Function		Default	
		START	—	62
		BGM	MELANCHOLY	
		SLIDE	ALL	
		SLIDE INTERVAL	3 SEC	
		MOVIE INTERVAL	SHORT	
	EDIT	SEL. IMAGE	RAW DATA EDIT	—
JPEG EDIT			—	63
IMAGE OVERLAY			—	65
			—	65
		—	73	
RESET PROTECT		—	64	

### Setup Menu

Tab	Function		Default		
			—	7	
	 *		—	77	
			 ±0,  ±0	77	
	REC VIEW		5 SEC	77	
		 MENU DISPLAY	 MENU DISPLAY	OFF	77
			 MENU DISPLAY	OFF	
	FIRMWARE		—	77	

\* Settings differ depending on the region where the camera is purchased.







## ⚙️ Custom Menu

Tab	Function	Default			
⚙️	<b>Ⓐ</b> AF/MF AF MODE AF AREA RESET LENS BULB FOCUSING FOCUS RING MF ASSIST [•••] SET HOME	STILL PICTURE	S-AF	78, 79	
		MOVIE			
		[•••]			
		ON			
		ON			
		↻			
		OFF			
		[•••]			
	<b>Ⓑ</b> BUTTON/DIAL DIAL FUNCTION AEL/AFL AEL/AFL MEMO BUTTON TIMER BUTTON FUNCTION DIAL DIRECTION Ⓜ️ LOCK	P	<input checked="" type="checkbox"/>		79, 80
		A		FNo.	
		S		SHUTTER	
		M		SHUTTER	
			S-AF	mode1	
			C-AF	mode2	
			MF	mode1	
			ON		
			8 SEC		
		<b>Fn</b> FUNCTION		Fn FACE DETECT	
		<b>Ⓜ️</b> FUNCTION		<b>Ⓜ️</b> REC	
	<b>▷</b> FUNCTION		⚡		
	<b>▽</b> FUNCTION		📄↻		
		DIAL1			
		OFF			
	<b>Ⓒ</b> RELEASE RLS PRIORITY S RLS PRIORITY C		OFF		80
			ON		
	<b>Ⓓ</b> DISP/Ⓜ️/PC HDMI VIDEO OUT* <b>📷</b> /INFO SETTINGS <b>📷</b> CONTROL SETTINGS ART LV MODE LIVE VIEW BOOST <b>▷</b> CLOSEUP MODE MODE GUIDE HISTOGRAM SETTINGS <b>👤</b> FACE PRIORITY BACKLIT LCD	HDMI OUT	1080i	OFF	80, 81
		HDMI CONTROL			
			—		
<b>▶</b> INFO			IMAGE ONLY, OVERALL		
LV-INFO			IMAGE ONLY, 📊		
<b>📷</b> SETTINGS			📅 <b>25</b> , CALENDAR		
iA <i>U</i> T <i>O</i>			LIVE GUIDE		
P/A/S/M			LIVE CONTROL		
ART			ART MENU		
SC <i>N</i>			SCENE MENU		
			mode1		
			OFF		
			mode1		
			ON		
HIGHLIGHT			255		
SHADOW			0		
		ON			
		HOLD			

\* Settings differ depending on the region where the camera is purchased.

Tab	Function	Default		
	SLEEP	1MIN	81	
		ON		
	VOLUME	3		
	USB MODE	AUTO		
		EXP/		81, 82
		EV STEP	1/3EV	
		METERING		
		AEL METERING	AUTO	
		ISO	AUTO	
		ISO STEP	1/3EV	
		ISO-AUTO SET	HIGH LIMIT: 1600 DEFAULT: 200	
		ISO-AUTO	P/A/S	
		BULB TIMER	8 MIN	
	ANTI-SHOCK	OFF		
	CUSTOM		82	
	X-SYNC.	1/180		
	SLOW LIMIT	1/60		
		OFF	82, 83	
	NOISE REDUCT.	AUTO		
	NOISE FILTER	STANDARD		
	WB	AUTO   A:0, G:0		
	ALL	ALL SET		—
		ALL RESET		—
	COLOR SPACE	sRGB		
	SHADING COMP.	OFF		
	SET	—		
PIXEL COUNT	Middle	2560×1920		
	Small	1280×960		
	RECORD/ERASE		83, 84	
	QUICK ERASE	OFF		
	RAW+JPEG ERASE	RAW+JPEG		
	FILE NAME	AUTO		
	EDIT FILENAME	OFF		
	PRIORITY SET	NO		
	dpi SETTING	AUTO		
	COPYRIGHT SETTINGS	COPYRIGHT INFO.		OFF
		ARTIST NAME		—
COPYRIGHT NAME		—		
	MOVIE		85	
	MODE	<b>P</b>		
	MOVIE+STILL	OFF		
	MOVIE	ON		
	UTILITY		85	
	PIXEL MAPPING	—		
	EXPOSURE SHIFT			±0
	WARNING LEVEL			±0

## Accessory Port Menu

Tab	Function	Default		
	 OLYMPUS PENPAL SHARE			
	PLEASE WAIT		—	68, 90
	ADDRESS BOOK	ADDRESS LIST	—	90
		NEW PAIRING	—	
		SEARCH TIMER	30 SEC	
	PICTURE SEND SIZE		SIZE 1: SMALL	
	MY OLYMPUS PENPAL		—	
	 OLYMPUS PENPAL ALBUM			
	COPY ALL		—	90
	RESET PROTECT		—	
	ALBUM MEM. USAGE		—	
	ALBUM MEM. SETUP		—	
	PICTURE COPY SIZE		SIZE 2: MEDIUM	
	 ELECTRONIC VIEWFINDER			
	EVF ADJUST		 ±0,  ±0	90

# Specifications

## Camera

Product type	
Product type	Digital camera with interchangeable lens system
Lens	M.Zuiko Digital, Micro Four Thirds System Lens
Lens mount	Micro Four Thirds mount
Equivalent focal length on a 35 mm film camera	Approx. twice the focal length of the lens
Image pickup device	
Product type	4/3" Live MOS sensor
No. of total pixels	Approx. 13,060,000 pixels
No. of effective pixels	Approx. 12,300,000 pixels
Screen size	17.3 mm (H) × 13.0 mm (V)
Aspect ratio	1.33 (4:3)
Live view	
Sensor	Uses Live MOS sensor
Field of view	100%
LCD monitor	
Product type	3.0" TFT color LCD
Total no. of pixels	Approx. 460,000 dots
Shutter	
Product type	Computerized focal-plane shutter
Shutter	1/4000–60 sec., Bulb shooting
Auto focus	
Product type	Imager contrast detection system
Focusing points	11 points
Selection of focusing point	Auto, Optional
Exposure control	
Metering system	TTL metering system (imager metering) Digital ESP metering/Center weighted averaging metering/Spot metering
Metered range	EV–1–18 (Digital ESP metering/Center weighted averaging metering/Spot metering)
Shooting modes	<b>A</b> UTO: i <b>A</b> UTO/ <b>P</b> : Program AE (Program shift can be performed)/ <b>A</b> : Aperture priority AE/ <b>S</b> : Shutter priority AE/ <b>M</b> : Manual/ <b>ART</b> : Art filter/ <b>SCN</b> : Scene/  : Movie
ISO sensitivity	200–6400 (1/3, 1 EV step)
Exposure compensation	±3 EV (1/3, 1/2, 1 EV step)
White balance	
Product type	Image pickup device
Mode setting	Auto/Presets WB (8 settings)/Customized WB/One-touch WB
Recording	
Memory	SD memory card/SDHC memory card/SDXC memory card
Recording system	Digital recording, JPEG (in accordance with Design rule for Camera File system (DCF)), RAW Data
Applicable standards	Exif 2.2, Digital Print Order Format (DPOF), PRINT Image Matching III, PictBridge
Sound with still pictures	Wave format
Movie	AVI Motion JPEG
Audio	PCM 44.1 kHz
Playback	
Display format	Single-frame playback/Close-up playback/Index display/Calendar display



<b>Drive</b>	
Drive mode	Single-frame shooting/Sequential shooting/Self-timer
Sequential shooting	3 frames/sec.
Self-timer	Operation time: 12 sec., 2 sec.
<b>External flash</b>	
Synchronization	Synchronized with the camera at 1/180 sec. or less
Flash control mode	TTL-AUTO (TTL pre-flash mode)/AUTO/MANUAL
Flash attachment	Hot shoe
<b>External connector</b>	
Multi-connector (USB connector, AV connector)/HDMI mini connector (Type C)/Accessory port	
<b>Power supply</b>	
Battery	Li-ion Battery (BLS-5) ×1
<b>Dimensions/weight</b>	
Dimensions	115.4 mm (W) × 72.7 mm (H) × 42.0 mm (D) (4.5" × 2.9" × 1.7") (excluding protrusions)
Weight	Approx. 362 g (0.8 lb.) (including battery and memory card)
<b>Operating environment</b>	
Temperature	0 °C–40 °C (32 °F–104 °F) (operation)/–20 °C–60 °C (–4 °F–140 °F) (storage)
Humidity	30%–90% (operation)/10%–90% (storage)

HDMI, the HDMI logo and High-Definition Multimedia Interface are trademarks or registered trademarks of HDMI Licensing LLC.



## Battery/charger

### ■ BLS-5 Lithium ion battery

MODEL NO.	BLS-5
Product type	Rechargeable Lithium ion battery
Nominal voltage	DC 7.2 V
Nominal capacity	1150 mAh
No. of charge and discharge times	Approx. 500 times (varies with usage conditions)
Ambient temperature	0 °C–40 °C (32 °F–104 °F) (charging)
Dimensions	Approx. 35.5 mm (W) × 12.8 mm (H) × 55 mm (D) (1.4" × 0.5" × 2.2")
Weight	Approx. 44 g (0.1 lb.)

### ■ BCS-5 Lithium ion charger

MODEL NO.	BCS-5
Rated input	AC 100 V–240 V (50/60 Hz)
Rated output	DC 8.35 V, 400 mA
Charging time	Approx. 3 hours 30 minutes (room temperature if using BLS-5)
Ambient temperature	0 °C–40 °C (32 °F–104 °F) (operation)/–20 °C–60 °C (–4 °F–140 °F) (storage)
Dimensions	Approx. 62 mm (W) × 38 mm (H) × 83 mm (D) (2.4" × 1.5" × 3.3")
Weight	Approx. 70 g (0.2 lb.) (without AC cable)

\* The AC cable supplied with this device is for use only with this device and should not be used with other devices. Do not use cables for other devices with this device.

SPECIFICATIONS ARE SUBJECT TO CHANGE WITHOUT ANY NOTICE OR OBLIGATION ON THE PART OF THE MANUFACTURER.

## SAFETY PRECAUTIONS



**CAUTION**  
RISK OF ELECTRIC SHOCK  
DO NOT OPEN



**CAUTION: TO REDUCE THE RISK OF ELECTRICAL SHOCK, DO NOT REMOVE COVER (OR BACK). NO USER-SERVICEABLE PARTS INSIDE. REFER SERVICING TO QUALIFIED OLYMPUS SERVICE PERSONNEL.**



An exclamation mark enclosed in a triangle alerts you to important operating and maintenance instructions in the documentation provided with the product.



**DANGER** If the product is used without observing the information given under this symbol, serious injury or death may result.



**WARNING** If the product is used without observing the information given under this symbol, injury or death may result.



**CAUTION** If the product is used without observing the information given under this symbol, minor personal injury, damage to the equipment, or loss of valuable data may result.

**WARNING!**

**TO AVOID THE RISK OF FIRE OR ELECTRICAL SHOCK, NEVER DISASSEMBLE, EXPOSE THIS PRODUCT TO WATER OR OPERATE IN A HIGH HUMIDITY ENVIRONMENT.**

**General Precautions**

**Read All Instructions** — Before you use the product, read all operating instructions. Save all manuals and documentation for future reference.

**Cleaning** — Always unplug this product from the wall outlet before cleaning. Use only a damp cloth for cleaning. Never use any type of liquid or aerosol cleaner, or any type of organic solvent to clean this product.

**Attachments** — For your safety, and to avoid damaging the product, use only accessories recommended by Olympus.

**Water and Moisture** — For precautions on products with weatherproof designs, read the weatherproofing sections.

**Location** — To avoid damage to the product, mount the product securely on a stable tripod, stand, or bracket.

**Power Source** — Connect this product only to the power source described on the product label.

**Foreign Objects** — To avoid personal injury, never insert a metal object into the product.

**Heat** — Never use or store this product

near any heat source such as a radiator, heat register, stove, or any type of equipment or appliance that generates heat, including stereo amplifiers.

**Product Handling Precautions****⚠ WARNING**

- **Do not use the camera near flammable or explosive gases.**
- **Do not use the flash and LED on people (infants, small children, etc.) at close range.**

You must be at least 1 m (3 ft.) away from the faces of your subjects. Firing the flash too close to the subject's eyes could cause a momentary loss of vision.

- **Keep young children and infants away from the camera.**

Always use and store the camera out of the reach of young children and infants to prevent the following dangerous situations which could cause serious injury:

- Becoming entangled in the camera strap, causing strangulation.

- Accidentally swallowing the battery, cards or other small parts.
- Accidentally firing the flash into their own eyes or those of another child.
- Accidentally being injured by the moving parts of the camera.
- **Do not look at the sun or strong lights with the camera.**
- **Do not use or store the camera in dusty or humid places.**
- **Do not cover the flash with a hand while firing.**

### CAUTION

- **Stop using the camera immediately if you notice any unusual odors, noise, or smoke around it.**  
Never remove the batteries with bare hands, which may cause a fire or burn your hands.
- **Never hold or operate the camera with wet hands.**
- **Do not leave the camera in places where it may be subject to extremely high temperatures.**

Doing so may cause parts to deteriorate and, in some circumstances, cause the camera to catch fire.

Do not use the charger if it is covered (such as a blanket). This could cause overheating, resulting in fire.

- **Handle the camera with care to avoid getting a low-temperature burn.**  
When the camera contains metal parts, overheating can result in a low-temperature burn. Pay attention to the following:
  - When used for a long period, the camera will get hot. If you hold on to the camera in this state, a low temperature burn may be caused.
  - In places subject to extremely cold temperatures, the temperature of the camera's body may be lower than the environmental temperature. If possible, wear gloves when handling the camera in cold temperatures.
- **Be careful with the strap.**  
Be careful with the strap when you carry the camera. It could easily catch on stray objects - and cause serious damage.

### Battery Handling Precautions

Follow these important guidelines to prevent batteries from leaking, overheating, burning, exploding, or causing electrical shocks or burns.

### DANGER

- The camera uses a lithium ion battery specified by Olympus. Charge the battery with the specified charger. Do not use any other chargers.
- Never heat or incinerate batteries.
- Take precautions when carrying or storing batteries to prevent them from coming into contact with any metal objects such as jewelry, pins, fasteners, etc.
- Never store batteries where they will be exposed to direct sunlight, or subjected to high temperatures in a hot vehicle, near a heat source, etc.
- To prevent causing battery leaks or damaging their terminals, carefully follow all instructions regarding the use of batteries. Never attempt to disassemble a battery or modify it in any way, by soldering, etc.
- If battery fluid gets into your eyes, flush your eyes immediately with clear, cold running water and seek medical attention immediately.
- Always store batteries out of the reach of small children. If a child accidentally swallows a battery, seek medical attention immediately.

### WARNING

- Keep batteries dry at all times.
- To prevent batteries from leaking, overheating, or causing a fire or explosion, use only batteries recommended for use with this product.
- Insert the battery carefully as described in the operating instructions.
- If rechargeable batteries have not been recharged within the specified time, stop charging them and do not use them.
- Do not use a battery if it is cracked or broken.
- If a battery leaks, becomes discolored or deformed, or becomes abnormal in any other way during operation, stop using the camera.
- If a battery leaks fluid onto your clothing or skin, remove the clothing and flush the affected area with clean, running cold water immediately. If the fluid burns your skin, seek medical attention immediately.
- Never subject batteries to strong shocks or continuous vibration.

### CAUTION

- Before loading, always inspect the battery carefully for leaks, discoloration, warping, or any other abnormality.
- The battery may become hot during prolonged use. To avoid minor burns, do not

remove it immediately after using the camera.

- Always unload the battery from the camera before storing the camera for a long period.
- This camera uses a lithium ion battery specified by Olympus. Do not use any other type of battery. For safe and proper use, read the battery's instruction manual carefully before using it.
- If the battery's terminals get wet or greasy, camera contact failure may result. Wipe the battery well with a dry cloth before use.
- Always charge a battery when using it for the first time, or if it has not been used for a long period.
- When operating the camera with battery power at low temperatures, try to keep the camera and spare battery as warm as possible. A battery that has run down at low temperatures may be restored after it is warmed at room temperature.
- The number of pictures you can take may vary depending on the shooting conditions or battery.
- Before going on a long trip, and especially before traveling abroad, purchase extra batteries. A recommended battery may be difficult to obtain while traveling.
- When the camera will not be used for an extended period, store it in a cool place.
- Please recycle batteries to help save our planet's resources. When you throw away dead batteries, be sure to cover their terminals and always observe local laws and regulations.

## Caution for Usage Environment

- To protect the high-precision technology contained in this product, never leave the camera in the places listed below, no matter if in use or storage:
  - Places where temperatures and/or humidity are high or go through extreme changes. Direct sunlight, beaches, locked cars, or near other heat sources (stove, radiator, etc.) or humidifiers.
  - In sandy or dusty environments.
  - Near flammable items or explosives.
  - In wet places, such as bathrooms or in the rain. When using products with weatherproof designs, read their manuals as well.
  - In places prone to strong vibrations.
- Never drop the camera or subject it to severe shocks or vibrations.
- When mounted on a tripod, adjust the position of the camera with the tripod head.

Do not twist the camera.

- Do not leave the camera pointed directly at the sun. This may cause lens or shutter curtain damage, color failure, ghosting on the image pickup device, or may possibly cause fires.
- Do not touch electric contacts on cameras and interchangeable lenses. Remember to attach the body cap when removing the lens.
- Before storing the camera for a long period, remove the battery. Select a cool, dry location for storage to prevent condensation or mold from forming inside the camera. After storage, test the camera by turning it on and pressing the shutter release button to make sure that it is operating normally.
- The camera may malfunction if it is used in a location where it is subject to a magnetic/electromagnetic field, radio waves, or high voltage, such as near a TV set, microwave, video game, loud speakers, large monitor unit, TV/radio tower, or transmission towers. In such cases, turn the camera off and on again before further operation.
- Always observe the operating environment restrictions described in the camera's manual.
- Do not directly touch or wipe the image pickup device of the camera.

## LCD Monitor

- Do not push the monitor forcibly; otherwise the image may become vague, resulting in a playback mode failure or damage to the monitor.
- A strip of light may appear on the top/bottom of the monitor, but this is not a malfunction.
- When a subject is viewed diagonally in the camera, the edges may appear zigzagged on the monitor. This is not a malfunction; it will be less noticeable in playback mode.
- In places subject to low temperatures, the LCD monitor may take a long time to turn on or its color may change temporarily. When using the camera in extremely cold places, it is a good idea to occasionally place it in a warm place. An LCD monitor exhibiting poor performance due to low temperatures will recover in normal temperatures.
- The LCD used for the monitor is made with high-precision technology. However, black spots or bright spots of light may appear constantly on the LCD Monitor. Due to its characteristics or the angle at which you are viewing the monitor, the spot may not be uniform in color and brightness. This is not a malfunction.

## Lens

- Do not immerse in water or splash with water.
- Do not drop or exert strong force on the lens.
- Do not hold at the moving part of the lens.
- Do not touch the lens surface directly.
- Do not touch the contact points directly.
- Do not subject to abrupt temperature changes.
- The operating temperature range is  $-10^{\circ}\text{C}$   $-40^{\circ}\text{C}$  ( $14^{\circ}\text{F}$ – $104^{\circ}\text{F}$ ). Always use within this temperature range.

## Legal and Other Notices

- Olympus makes no representations or warranties regarding any damages, or benefit expected by using this unit lawfully, or any request from a third person, which are caused by the inappropriate use of this product.
- Olympus makes no representations or warranties regarding any damages or any benefit expected by using this unit lawfully which are caused by erasing picture data.

## Disclaimer of Warranty

- Olympus makes no representations or warranties, either expressed or implied, by or concerning any content of these written materials or software, and in no event shall be liable for any implied warranty of merchantability or fitness for any particular purpose or for any consequential, incidental or indirect damages (including but not limited to damages for loss of business profits, business interruption and loss of business information) arising from the use or inability to use these written materials or software or equipment. Some countries do not allow the exclusion or limitation of liability for consequential or incidental damages, so the above limitations may not apply to you.
- Olympus reserves all rights to this manual.

## Warning

Unauthorized photographing or use of copyrighted material may violate applicable copyright laws. Olympus assumes no responsibility for unauthorized photographing, use or other acts that infringe upon the rights of copyright owners.

## Copyright Notice

All rights reserved. No part of these written materials or this software may be reproduced or used in any form or by any means, electronic or mechanical, including photocopying and recording or the use of any type of information storage and retrieval system, without the prior written permission of Olympus. No liability

is assumed with respect to the use of the information contained in these written materials or software, or for damages resulting from the use of the information contained therein. Olympus reserves the right to alter the features and contents of this publication or software without obligation or advance notice.

## FCC Notice

- **Radio and Television Interference**  
Changes or modifications not expressly approved by the manufacturer may void the user's authority to operate this equipment. This equipment has been tested and found to comply with the limits for a Class B digital device, pursuant to Part 15 of the FCC Rules. These limits are designed to provide reasonable protection against harmful interference in a residential installation. This equipment generates, uses, and can radiate radio frequency energy and, if not installed and used in accordance with the instructions, may cause harmful interference to radio communications.

However, there is no guarantee that interference will not occur in a particular installation. If this equipment does cause harmful interference to radio or television reception, which can be determined by turning the equipment off and on, the user is encouraged to try to correct the interference by one or more of the following measures:

- Adjust or relocate the receiving antenna.
- Increase the distance between the camera and receiver.
- Connect the equipment to an outlet on a circuit different from that to which the receiver is connected.
- Consult your dealer or an experienced radio/TV technician for help. Only the OLYMPUS-supplied USB cable should be used to connect the camera to USB enabled personal computers (PC).

Any unauthorized changes or modifications to this equipment would void the user's authority to operate it.

## Use Only Dedicated Rechargeable Battery and Battery Charger

We strongly recommend that you use only the genuine Olympus dedicated rechargeable battery and battery charger with this camera. Using a non-genuine rechargeable battery and/or battery charger may result in fire or personal injury due to leakage, heating, ignition or damage to the battery. Olympus does not assume any liability for accidents or damage that may result from the use of a battery and/or battery charger that are not genuine Olympus accessories.

## For customers in North and South America

### For customers in USA

Declaration of Conformity

Model Number : E-PL2

Trade Name : OLYMPUS

Responsible Party : **OLYMPUS IMAGING AMERICA INC.**

Address : 3500 Corporate Parkway, P. O. Box 610, Center Valley, PA 18034-0610, USA

Telephone Number : 484-896-5000

Tested To Comply With FCC Standards

FOR HOME OR OFFICE USE

This device complies with Part 15 of the FCC rules. Operation is subject to the following two conditions:

- (1) This device may not cause harmful interference.
- (2) This device must accept any interference received, including interference that may cause undesired operation.

### For customers in Canada

This Class B digital apparatus complies with Canadian ICES-003.

## For customers in Europe



"CE" mark indicates that this product complies with the European requirements for safety, health, environment and customer protection. "CE" mark cameras are intended for sales in Europe.



This symbol [crossed-out wheeled bin WEEE Annex IV] indicates separate collection of waste electrical and electronic equipment in the EU countries. Please do not throw the equipment into the domestic refuse.

Please use the return and collection systems available in your country for the disposal of this product.



This symbol [crossed-out wheeled bin Directive 2006/66/EC Annex II] indicates separate collection of waste batteries in the EU countries.

Please do not throw the batteries into the domestic refuse.

Please use the return and collection systems available in your country for the disposal of the waste batteries.

### Provisions of warranty

- 1 If this product proves to be defective, although it has been used properly (in accordance with the written Handling Care and Operating instructions supplied with it), during the applicable national warranty period and has been purchased from an authorized Olympus distributor within the business area of Olympus Europa Holding GmbH as stipulated on the website: <http://www.olympus.com> this product will be repaired, or at Olympus's option replaced, free of charge. To claim under this warranty the customer must take the product before the end of the applicable national warranty period to the dealer where the product was purchased or any other Olympus service station within the business area of Olympus Europa Holding GmbH as stipulated on the website: <http://www.olympus.com>. During the one year period of the World Wide Guarantee the customer may turn the product in at any Olympus service station. Please notice that not in all countries such Olympus service station exists.
- 2 The customer shall transport the product to the dealer or Olympus authorized service station at his own risk and shall be responsible for any costs incurred in transporting the product.

### Provisions of Guarantee

- 1 "OLYMPUS IMAGING CORP., Shinjuku Monolith, 2-3-1 Nishi-Shinjuku, Shinjuku-ku, Tokyo 163-0914, Japan grants a one year World Wide Guarantee. This worldwide Guarantee must be presented at an Olympus authorized repair service station before any repair can be made under conditions of this Guarantee. This Guarantee is valid only if the Guarantee Certificate and proof of purchase are presented at the Olympus repair service station. Please note that this Guarantee is in addition to and does not affect the customer's legal warranty rights under the applicable national legislation governing the sale of consumer goods mentioned above.
- 2 This Guarantee does not cover the following and the customer will be required to pay repair

charge, even for defects occurring within the Guarantee period referred to above.

- (a) Any defect that occurs due to mishandling (such as an operation performed that is not mentioned in the Handling Care or other sections of the instructions, etc.)
  - (b) Any defect that occurs due to repair, modification, cleaning, etc. performed by anyone other than Olympus or an Olympus authorized service station.
  - (c) Any defect or damage that occurs due to transport, a fall, shock, etc. after purchase of the product.
  - (d) Any defect or damage that occurs due to fire, earthquake, flood damage, thunderbolt, other natural disasters, environmental pollution and irregular voltage sources.
  - (e) Any defect that occurs due to careless or improper storage (such as keeping the product under conditions of high temperature and humidity, near insect repellents such as naphthalene or harmful drugs, etc.), improper maintenance, etc.
  - (f) Any defect that occurs due to exhausted batteries, etc.
  - (g) Any defect that occurs due to sand, mud, etc. entering the inside of the product casing.
  - (h) When the Guarantee Certificate is not returned with the product.
  - (i) When any alterations whatsoever are made to the Guarantee Certificate regarding the year, month and date of purchase, the customer's name, the dealer's name, and the serial number.
  - (j) When proof of purchase is not presented with this Guarantee Certificate.
- 3 This Guarantee applies to the product only; the Guarantee does not apply to any other accessory equipment, such as the case, strap, lens cap and batteries.
  - 4 Olympus's sole liability under this Guarantee shall be limited to repairing or replacing the product. Any liability under the Guarantee for indirect or consequential loss or damage of any kind incurred or suffered by the customer due to a defect of the product, and in particular any loss or damage caused to any lenses, films, other equipment or accessories used with the product or for any loss resulting from a delay in repair or loss of data, is excluded. Compelling regulations by law remain unaffected by this.

## Notes regarding Guarantee maintenance

- 1 This Guarantee will only be valid if the Guarantee Certificate is duly completed by Olympus or an authorized dealer or other documents contain sufficient proof. Therefore, please make sure that your name, the name of the dealer, the serial number and the year, month and date of purchase are all completed or the original invoice or the sales receipt (indicating the dealer's name, the date of purchase and product type) is attached to this Guarantee Certificate. Olympus reserves the right to refuse free-of-charge service if neither Guarantee Certificate is completed nor the above document is attached or if the information contained in it is incomplete or illegible.
- 2 Since this Guarantee Certificate will not be re-issued, keep it in a safe place.
  - Please refer to the list on the web site: <http://www.olympus.com> for the authorized international Olympus service network.

## Trademarks

- IBM is a registered trademark of International Business Machines Corporation.
- Microsoft and Windows are registered trademarks of Microsoft Corporation.
- Macintosh is a trademark of Apple Inc.
- The SDHC and SDXC logos are trademarks.
- "Shadow Adjustment Technology" function contains patented technologies from Apical Limited.
- All other company and product names are registered trademarks and/or trademarks of their respective owners.
- Micro Four Thirds and the Micro Four Thirds logo are trademarks or registered trademarks of OLYMPUS IMAGING Corporation in Japan, the United States, the countries of the European Union, and other countries.
- "PENPAL" is used in reference to the OLYMPUS PENPAL.
- The standards for camera file systems referred to in this manual are the "Design Rule for Camera File System/DCF" standards stipulated by the Japan Electronics and Information Technology Industries Association (JEITA).



# Index

## Symbols

Shooting Menu 1 .....	108
Shooting Menu 2 .....	108
Playback Menu .....	108
Setup Menu .....	77, 108
Custom Menu .....	78, 109
Accessory port menu .....	90
AF/MF .....	78
BUTTON/DIAL .....	79
RELEASE .....	80
DISP/PC .....	80
EXP/ISO .....	81
CUSTOM .....	82
COLOR/WB .....	82
RECORD/ERASE .....	83
MOVIE .....	85
UTILITY .....	85
OLYMPUS PENPAL SHARE .....	90
OLYMPUS PENPAL ALBUM .....	90
ELECTRONIC VIEWFINDER .....	90
(Large) .....	44
(Middle) .....	44, 83
(Small) .....	44, 83
RC MODE .....	89
(Language selection) .....	77
MENU DISPLAY .....	77, 78
SET HOME .....	79
LOCK .....	80
INFO SETTINGS .....	80
CONTROL SETTINGS .....	80
CLOSE UP MODE .....	81
FACE PRIORITY .....	37, 81
(Beep sound) .....	81
SLOW LIMIT .....	82
X-SYNC .....	82
.....	82
SET .....	83
MODE .....	58
WARNING LEVEL .....	85
HOME .....	86
REC .....	86

FISHEYE EFFECT .....	17
WIDE-ANGLE .....	17
MACRO .....	17

## A

Adding sound to still pictures	65
ADDRESS BOOK .....	69, 90
AE BKT .....	54
AE bracketing .....	54
AE lock .....	39
AEL METERING .....	81
AEL/AFL .....	79, 85, 86
AEL/AFL MEMO .....	79
AF AREA .....	35
AF MODE .....	34, 78
AF target	12, 35
ALBUM MEM. SETUP .....	90
ALBUM MEM. USAGE .....	90
ALL	82
ALL ERASE .....	64
ALL TARGETS .....	35
ANTI-SHOCK	82
Aperture priority shooting <b>A</b> .....	49
Aperture value .....	12, 49, 51
Art filter mode <b>ART</b> .....	16
ART LV MODE .....	80
ASPECT .....	63
Auto flash .....	56
Auto focus .....	12, 34, 91
Auto white balance .....	40





## B

B (Basic) .....	44
B&W FILTER .....	43
BACKLIT LCD .....	81, 86
Battery .....	3, 6, 97
BEACH & SNOW	17
BGM .....	62
BLACK & WHITE .....	63
BRACKETING .....	54
BULB FOCUSING .....	79
Bulb shooting .....	51









BULB TIMER	82
BUTTON FUNCTION	79
BUTTON TIMER	79

## C



C-AF (continuous AF)	34
C-AF+TR (AF Tracking)	34
Calendar display	60
CANDLE 	17
Card	4, 96
CARD SETUP	64, 96
Center weighted averaging metering 	39
CHILDREN 	17
Close-up playback 	14, 61
COLOR SPACE	82
Color temperature	40
Compression rate	44
Continuous AF (C-AF)	34
CONTRAST	43
COPY ALL	69
COPYRIGHT SETTINGS	84
CUSTOM 	42
Custom white balance <b>CWB</b>	40

## D





Date/time setting 	7
DIAL DIRECTION	79
DIAL FUNCTION	79
Digital ESP metering 	39
DIORAMA 	16
Direct print	74
DIS MODE 	17
DOCUMENTS 	17
dpi SETTING	84
DPOF	73
DRAMATIC TONE 	16
Dust reduction	6, 95

## E

Easy printing	75
Easy shooting modes	10
EDIT FILENAME	84
EFFECT	43
Electronic view finder	102

e-PORTRAIT 	17, 63
ERASE SELECTED	64
EV STEP	81
EVF ADJUST	90
Exposure compensation 	38
EXPOSURE SHIFT	85



## F

F (Fine)	44
FILE NAME	84
Fill-in flash 	56
FIREWORKS 	17
FIRMWARE	77
FL BKT	55
Flash	56
Flash bracketing	55
Flash intensity control 	57
Flash mode 	56
Flash off 	56
Fn FACE DETECT	86
Focus lock	35
FOCUS RING	79
FORMAT	93
Four Thirds system lenses	98



## G

GRADATION	43
GRAINY FILM 	16

## H

HD	44
HDMI	66, 80
HIGH KEY 	17, 43
Histogram	30, 31
HISTOGRAM SETTINGS	81
Home position 	79

## I



iAUTO shooting <b>IAUTO</b>	10, 11, 18
i-ENHANCE 	42
IMAGE ASPECT	45
IMAGE OVERLAY	65
Image size	44
IMAGE STABILIZER IS	47
Index display 	14, 60

<b>INFO</b> button.....	9, 30, 31, 32
Information display .....	30, 31
<b>IS</b> (Image stabilizer).....	47
ISO .....	45, 81
ISO BKT .....	54
ISO bracketing.....	55
ISO STEP .....	81
ISO-AUTO .....	82
ISO-AUTO SET .....	81





## J



JPEG .....	44
JPEG EDIT .....	63

## L





LANDSCAPE  .....	17
LANDSCAPE+PORTRAIT  .....	17
Lens.....	5, 98
Lens attachments .....	101
Lithium ion battery .....	3, 97, 115
Lithium ion charger .....	3, 97
Live control .....	20
LIVE GUIDE .....	18
LIVE VIEW BOOST .....	81
LOW KEY  .....	17, 43

## M

M.ZUIKO DIGITAL interchangeable lens.....	98
MACRO  .....	17
Manual focus (MF).....	34
Manual shooting <b>M</b> .....	51
METERING.....	39, 81
MF (manual focus).....	34, 86
MF ASSIST.....	79
Micro Four Thirds system lenses.....	98
MODE GUIDE .....	81
Monitor brightness adjustment  .....	77
MONOTONE  .....	42
MOVIE PLAY .....	59
MOVIE  .....	59, 85
Movie shooting  .....	13, 58
MOVIE+STILL .....	85, 88
MTP .....	72
Multi view display.....	30, 38

MULTIPLE EXPOSURE  .....	53
MUTED  .....	42
MY OLYMPUS PENPAL .....	90







## N

N (Normal).....	44
NATURAL  .....	42
NATURE MACRO  .....	17
NIGHT SCENE  .....	17
NIGHT+PORTRAIT  .....	17
NOISE FILTER .....	82
NOISE REDUCT.....	82
NTSC.....	66, 80

## O

OLYMPUS PENPAL .....	68, 90
One-touch white balance  .....	32, 41





## P

PAL.....	66, 80
PANORAMA  .....	17, 52
PICT. TONE .....	43
PictBridge .....	74
PICTURE COPY SIZE .....	90
PICTURE MODE .....	42
PICTURE SEND SIZE.....	90
PIN HOLE  .....	16
PIXEL COUNT.....	83
PIXEL MAPPING.....	96
Playback on TV .....	66
PLEASE WAIT .....	68, 90
POP ART  .....	16
PORTRAIT  .....	42
PORTRAIT  .....	17
Preset white balance .....	40
PREVIEW .....	49
PRINT.....	74
Print reservation  .....	73
PRIORITY SET .....	84
Program shift <b>Ps</b> .....	48
Program shooting <b>P</b> .....	48
Protecting  .....	15







## Q









QUICK ERASE .....	83
-------------------	----

## R

RAW .....	44
RAW DATA EDIT .....	63
RAW  .....	86
RAW+JPEG ERASE .....	83
REC VIEW .....	77
Record mode  .....	44, 107
REDEYE FIX .....	63
Red-eye reduction flash  .....	56
RESET LENS .....	78
RESET/MYSET .....	33
RESET PROTECT .....	64, 90
Resizing  .....	63
RLS PRIORITY C .....	80
RLS PRIORITY S .....	80
ROTATE .....	62

## S



S-AF (single AF) .....	34
S-AF+MF .....	34
SATURATION .....	43, 63
Scene mode <b>SCN</b> .....	17
SD .....	44
SD/SDHC/SDXC card .....	4, 96
Self-timer  .....	46
SEPIA .....	63
Sequential shooting  .....	46
SF (Super Fine) .....	44
SHADING COMP .....	83
SHADOW ADJ .....	63
SHARPNESS .....	43
Shutter priority shooting <b>S</b> .....	50
Shutter speed .....	12, 50, 51
Single AF (S-AF) .....	34
SINGLE TARGET .....	35
Single-frame erase  .....	15
Single-frame playback .....	60
Single-frame protect .....	15
Single-frame shooting  .....	46
SLEEP .....	81
SLIDE .....	62
Slideshow  .....	62
Slow synchronization (1st curtain)  SLOW .....	56

Slow synchronization (1st curtain)/ Red-eye reduction flash  SLOW .....	56
Slow synchronization (2nd curtain)  SLOW2/2nd CURTAIN .....	56
SOFT FOCUS  .....	16
SPORT  .....	17
Spot metering - highlight control  HI .....	39
Spot metering - shadow control  SH .....	39
Spot metering  .....	39
STORAGE .....	72
Strap .....	2
SUNSET  .....	17
Super control panel .....	87
Super FP flash .....	105

## T

TEST PICTURE .....	86
Tone control .....	32, 38
Trimming  .....	63, 76

## U

Underwater macro/underwater wide   .....	86
USB MODE .....	81

## V

VIDEO OUT .....	80
VIVID  .....	42
VOLUME .....	81

## W

WB .....	40, 82
WB BKT .....	55
WB bracketing .....	55
White balance compensation  .....	41
White balance <b>WB</b> .....	40

## Z

Zoom display .....	36
Zoom frame AF .....	36

# OLYMPUS®

<http://www.olympus.com/>

## OLYMPUS IMAGING CORP.

Shinjuku Monolith, 3-1 Nishi-Shinjuku 2-chome, Shinjuku-ku, Tokyo, Japan

## OLYMPUS IMAGING AMERICA INC.

3500 Corporate Parkway, P.O. Box 610, Center Valley, PA 18034-0610, U.S.A. Tel. 484-896-5000

### Technical Support (U.S.A.)

24/7 online automated help: <http://www.olympusamerica.com/DSLR>

Phone customer support: Tel. 1-800-260-1625 (Toll-free)

Our phone customer support is available from 9am to 9pm (Monday to Friday) ET

E-Mail: [e-slpro@olympus.com](mailto:e-slpro@olympus.com)

Olympus software updates can be obtained at: <http://www.olympusamerica.com/digital>

To find the nearest Service Centers, please visit: <http://www.olympusamerica.com/digital>, and click on the Worldwide Warranty icon at the bottom of the page.

### Service Centers

#### **U.S.A.:**

##### **California**

**Olympus Imaging America Inc.**

10805 Holder Street Suite 170

Cypress, CA 90630-5145

Tel: (800) 260-1625

FAX: (714) 229-1652

##### **New York**

**Olympus Imaging America Inc.**

400 Rabro Drive

Hauppauge, NY 11788-4258

Tel: (800) 260-1625

FAX: (631) 881-6510

#### **Canada:**

##### **Ontario**

**Olympus Canada Inc.**

Consumer Products Group

151 Telson Road

Markham, Ontario Canada L3R 1E7

Tel: (800) 260-1625

Fax: (905) 969-3291

#### **Mexico:**

**Olympus Imaging de Mexico S.A. de C.V.**

WTC Mexico, Montecito

No.38 - planta baja local 12

Col. Napoles, Mexico D.F. 03810

Tel: (01800) 900-1280/900-1281

## Free Manuals Download Website

<http://myh66.com>

<http://usermanuals.us>

<http://www.somanuals.com>

<http://www.4manuals.cc>

<http://www.manual-lib.com>

<http://www.404manual.com>

<http://www.luxmanual.com>

<http://aubethermostatmanual.com>

Golf course search by state

<http://golfingnear.com>

Email search by domain

<http://emailbydomain.com>

Auto manuals search

<http://auto.somanuals.com>

TV manuals search

<http://tv.somanuals.com>