

OLYMPUS®

PT-E06

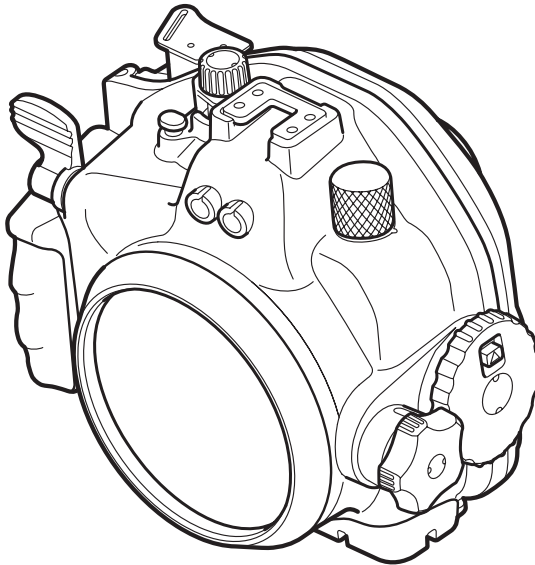

En

Instruction Manual

Underwater Case for digital camera **€-620**

- Thank you for buying the Underwater Case PT-E06 (hereinafter Case).
- Please read this instruction manual carefully and use the product safely and correctly. Please keep this instruction manual for reference after reading it.
- Wrong usage may cause damage to the camera inside the Case due to water leakage, and repair may not be possible.
- Before use, perform an advance check as described in this manual.

Introduction

- Unauthorized copying of this manual in part or in full, except for private use, is prohibited. Unauthorized reproduction is strictly prohibited.
- OLYMPUS IMAGING CORP. shall not be responsible in any way for lost profits or any claims by third parties in case of any damage occurring from improper use of this product.



Please read the following items before use

- This Case is a precision device designed for use at a water depth within 40 m. Please handle it with sufficient care.
- Please use the Case correctly after sufficient understanding of the contents of this manual in regard to handling of the Case, checks before use, maintenance, and storage after use.
- The Case must be used in combination with the separately available Waterproof Port.
- OLYMPUS IMAGING CORP. shall in no way be responsible for accidents involving immersion of a digital camera in water. In addition, expenses incurred for damage of internal materials or loss of recorded contents due to water entering the camera will not be compensated.
- OLYMPUS IMAGING CORP. shall not pay any compensation for accidents (injuries or material damage) at the time of use.

For safe use

En

This instruction manual uses various pictographs for correct use of the product and to prevent danger to the user and other person, as well as property damage. These pictographs and their meanings are shown below.

 WARNING	This shows the content regarding assumption of possibility of human death or severe injury in case of handling with disregard of this indication.
 CAUTION	This shows the contents regarding assumption of possibility of injury or damage to property in case of handling with disregard of this indication.

WARNING

- ① Keep this product out of the reach of babies, infants, and children. There is the possibility of occurrence of the following types of accidents.
 - Injury by dropping onto the body from heights.
 - Injury from parts of the body getting caught in parts which open and close.
 - Swallowing of small parts, O-ring, silicone grease and silica gel. Please consult a physician immediately if any parts have been swallowed.
- ② Do not store digital camera with batteries inserted in this product.
Storage with a battery inserted may lead to leakage of the battery liquid and fire hazard.
- ③ The Case must be used in combination with the Waterproof Port available separately. Remember that the Case cannot be used without the Waterproof Port.
- ④ If leakage of water should occur with a camera installed in this product, quickly remove the battery from the camera. There is the possibility of ignition and explosion from generation of hydrogen gas.
- ⑤ This product is made of resin. There is the possibility that injuries may be caused when it becomes broken due to strong impact with a rock or other hard objects. Please handle it with sufficient care.

CAUTION

- ① Do not disassemble or modify this product. This may cause water leakage or defect. In case of the loss of image data caused by disassembly, repair or modification etc. by any party other than those appointed by OLYMPUS IMAGING CORP., we shall bear no responsibility for damage.
- ② Use or storage of the product at the following locations may cause defective operation, defects, damage, fire, internal fogging, or water leakage. This should be avoided.
 - Locations reaching high temperatures such as those under direct sunlight, in an automobile, etc.
 - Locations close to fire
 - A water depth in excess of 40 m
 - Locations subject to vibrations
 - Locations with high temperature and humidity or with extreme temperature changes
 - Locations with volatile substances
- ③ Opening and closing at locations with much sand, dust, or dirt may impair the waterproof characteristic and cause water leakage. This should be avoided.
- ④ This product is not a case to soften impacts to the camera inside the product. When this product with a digital camera inside is subjected to impacts or heavy objects are placed onto it, the digital camera may be damaged. Please handle it with sufficient care.
- ⑤ Do not use the following chemicals for cleaning, corrosion prevention, prevention of fogging, repair or other purposes. When these are used for the Case directly or indirectly (with the chemicals in vaporized state), they may cause cracking under high pressure or other problems.

Chemicals which cannot be used	Explanation
Volatile organic solvents, chemical detergents	Do not clean the Case with alcohol, gasoline, thinner or other volatile organic solvents or with chemical detergents etc. Pure water or lukewarm water is sufficient for cleaning.
Anticorrosion agent	Do not use anticorrosion agents. Pure water is sufficient when washing the metal parts as stainless steel and brass are used.
Commercial defogging agents	Do not use commercial defogging agents. Always use the specified desiccant silica gel.
Grease other than specified silicone grease	Use only the specified silicone grease for the silicon O-ring, as otherwise the O-ring surface may deteriorate and water leakage may occur.
Adhesive	Do not use adhesive for repairs or other purposes. When repair is required, please contact a dealer or a service station of OLYMPUS IMAGING CORP.

- 
- ⑥ Jumping into the water with the Case in your pocket or in your hand, throwing the Case from a boat or ship into the water, and other rough handling may cause water leakage. Please handle with sufficient care, when handing it over from hand to hand etc.
 - ⑦ If the camera on the inside should become wet because of water leakage etc., immediately wipe off all moisture and confirm the operation.
 - ⑧ Be careful not to apply excessive force to the port connector, TTL cable connector, zoom dial or tripod seat.
 - ⑨ Do not push the air vent valve from inside.
 - ⑩ Please remove the O-ring when traveling by air. Otherwise air pressure may make it impossible to open the Case.
 - ⑪ For safe use of the digital camera in this product, please read the "Instruction Manual" for the digital camera carefully.
 - ⑫ When sealing this product, take sufficient care that no foreign matter gets caught at the O-ring and the contact surfaces.
 - ⑬ The camera's built-in flash cannot be used when the Case is combined with an external Olympus flash. Also, the camera's built-in flash cannot be popped up if the hot shoe cable is connected to the camera's hot shoe. If the built-in flash is forcibly popped up, the connected flash will not work properly and the hot shoe cable may be disconnected from the camera's hot shoe. In this case, the camera may also be damaged.
 - ⑭ The camera's built-in flash cannot be used when the camera is in the Case.

Contents

Introduction	1
Please read the following items before use	1
For safe use	1
1.Preparations.....	6
Check the contents of the package	6
Names of the parts.....	7
Install the Waterproof Port	8
Attach the hand strap	8
How to attach and detach the camera table.....	9
2.Advance check of the Case	10
Advance check before use	10
3.How to connect the electronic flash	11
Connecting the underwater optical fiber cable	11
When using the TTL cable	12
4.Installing the digital camera	14
Check the digital camera	14
Open the Case	15
Attach the digital camera to the camera table.....	15
Insert the digital camera in the Case.....	16
Check the loading status	17
Seal the Case.....	18
Check the operation of the loaded camera	18
Perform the final checks.....	18
Visual Inspection.....	18
Water Leakage Test	19
5.Handling After Shooting	20
Wipe off any waterdrop	20
Unload the digital camera	20
Wash the Case with pure water	20
Dry the Case	21
6.Maintaining the Waterproof Function	22
Remove the O-ring.....	22
Remove any sand, dirt, etc.	22
Install the O-ring	22
How to Apply Grease to the O-ring	23
Replace consumable products	24
Maintenance of the threaded sections on the TTL cable and TTL cable connector.....	24
Maintenance of the TTL Connector Cap	24



7. Appendix	25
Specifications	25
Supplied accessories for PT-E06.....	25
Waterproof Port.....	26
Optional accessories.....	26

1. Preparations

Check the contents of the package

Check that all accessories are in the box.
Contact your dealer if accessories are missing or damaged.

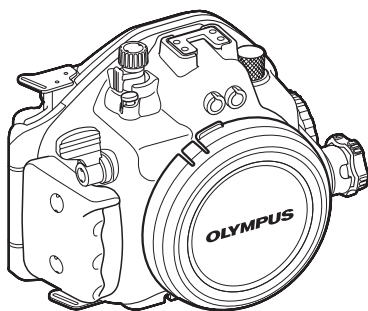

- Case body
(Check that the O-ring is installed on both of rear case and front case.)

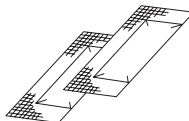

- Silica gel (2g)

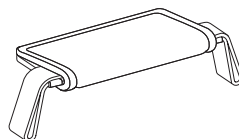

- Hand strap

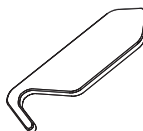

- O-ring remover

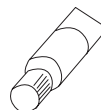

- Silicone grease

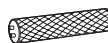

- Maintenance adapter

- Authorized distributors list/Authorized service centres list
- Instruction manual (this manual)









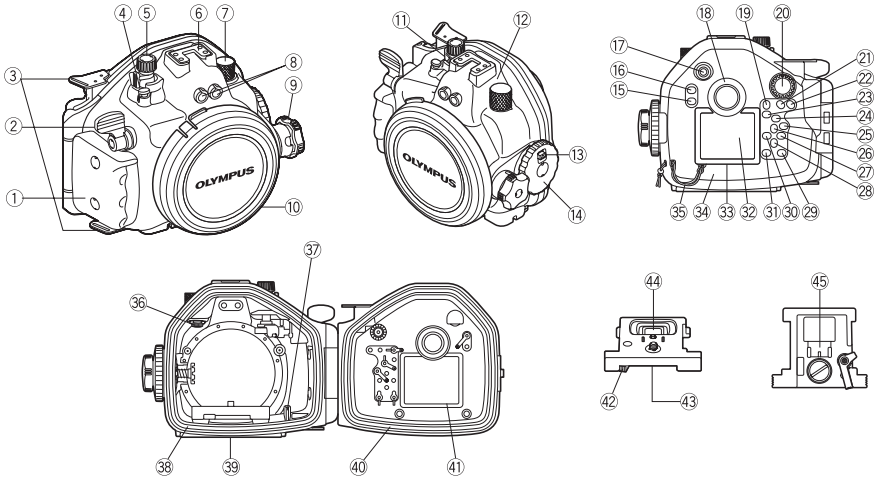

CAUTION:

After purchase, be sure to do maintenance even in brand-new condition. Neglecting the maintenance may become the cause of water leakage.
For how to maintenance the case, refer to P.22.

En

Names of the parts



- ① Palm grip
- *② Shutter lever
- ③ Hand strap ring
- *④  (Exposure correction) button
- *⑤ Mode dial knob
- ⑥ Accessory mount
- ⑦ TTL cable connector
- ⑧ Optical fiber cable insertion slot, cap
- *⑨ Zoom dial
- ⑩ Body cap
- *⑪ Power switch lever
- ⑫ Front lid
- ⑬ Slide lock
- ⑭ Open/close dial
- *⑮ **MENU** button
- *⑯ **INFO** (Info display) button
- ⑰ Air vent valve
- ⑱ Pickup finder
- *⑲ **AEL/AFL** button
- *⑳ Control dial knob
- *㉑ Fn button
- *㉒  (AF target) button
- *㉓  (Play) button
- *㉔  button
- *㉕  button
- *㉖  Cross-cursor button ▲
- *㉗  Cross-cursor button ►
- *㉘  Cross-cursor button ▼
- *㉙ IS button
- *㉚  Cross-cursor button ◀
- *㉛  (Erase) button
- ㉜ LCD monitor window
- ㉝ LCD hood
- ㉞ Rear lid
- ㉟ LCD hood strap
- ㊱ Hot shoe cable connectors (w/caps)
- ㊲ Loading guide rails
- ㊳ O-ring (POL-E06B)
- ㊴ Tripod seat
- ㊵ O-ring (POL-E06A)
- ㊶ LCD inner hood
- ㊷ Camera table lock
- ㊸ Camera table
- ㊹ Eyecup storage space
- ㊺ Hot shoe cover storage space

Note:

Case operation parts marked by * corresponds to the operation parts of the digital camera. When the operation parts of the Case are operated, the corresponding functions of the digital camera will operate. For details of the functions, refer to the instruction manual for the digital camera.

Install the Waterproof Port

To enable the Case to be used underwater, the separately available Waterproof Port for the camera lens must be installed on the Case. Align the Waterproof Port with the position where the camera lens will be when the camera is loaded in the Case.

- Refer to the instruction manual provided with the Waterproof Port before attaching the Waterproof Port to the Case.
- Apply the provided Silicon grease to the O-ring section of the Waterproof Port and the Waterproof Port mounting thread on the Case.
- Screw the Waterproof Port into the Case by turning it clockwise all the way.

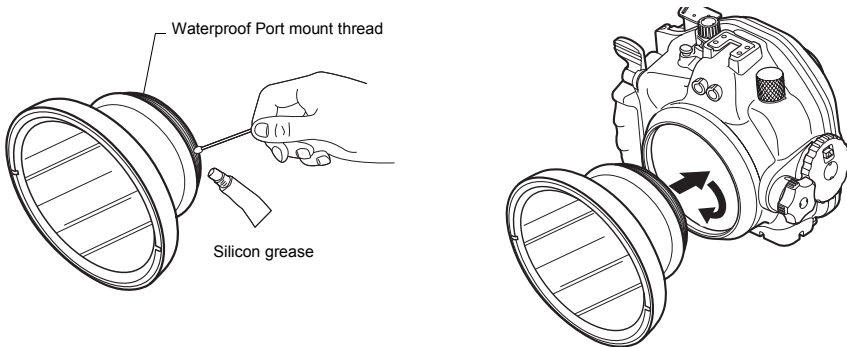

⚠ CAUTION:

The Case should not be used underwater at depths that exceed 40 meters. Even when the attached underwater lens port or other equipment is able to withstand depths exceeding 40 meters, the Case itself cannot be used at depths of more than 40 meters.

Attach the hand strap

Attach the hand strap to the Case.

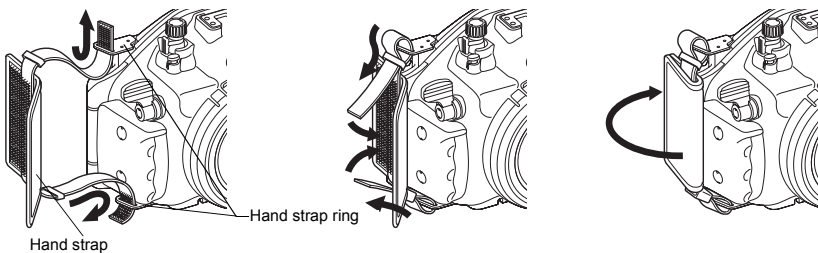

En

How to attach and detach the camera table

The camera table inside the front lid of the Case is used to load the digital camera into the Case.

How to detach the camera table

- ① Slide and hold the Case's slide lock and open the open/close dial, then open the rear lid.
- ② Slide the camera table lock to the left to unlock the camera table.
Slide the table towards the rear.

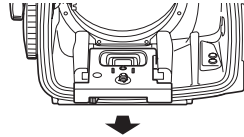
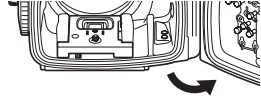

How to attach the camera table

- ① Slide the camera table all the way into the camera table loading grooves on the front-lid side of the Case.
Slide the camera table lock to the right to lock the camera table.
- ② Gently close the rear lid of the Case and close the open/close dial firmly.

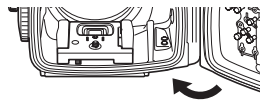
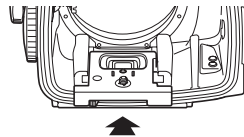

CAUTION:

Closing the rear lid of the Case before the camera table is inserted all the way (until it stops), into the camera table loading grooves could damage the Case and the camera.

2. Advance check of the Case

Advance check before use

This Case has been the subject of thorough quality control for the parts during the manufacturing process and thorough function inspections during the assembly. In addition, a water pressure test is performed with a water pressure tester for all products to confirm that the performance conforms to the specifications.

However, depending on the carrying and storage conditions, the maintenance status, etc., the waterproof function may be damaged.

Before using, always perform the following advance checks.

Check the waterproof parts of the Case

Check the waterproof parts of the Case as described below.

- ① Ensure that the Case's O-rings are firmly attached and secured with the slide lock and the open/close dial.
- ② Ensure that the separately available Waterproof Port is installed correctly, and that the Waterproof Port is attached firmly to the O-ring between the Waterproof Port and Case.
- ③ Ensure that the O-ring of the TTL connector is attached firmly and that the cap is screwed into the connector without loosening.

Advance check

- ① Before loading the digital camera in the Case, immerse the empty Case to confirm that there is no water leakage. When it is difficult, water leakage can be checked by referring "Water Leakage Test" (P.19).
- ② Main causes of water leakage are as follows.
 - Forgetting to install the O-ring
 - Part of an O-ring or an entire O-ring is outside the specified groove.
 - O-ring damage, cracks, deterioration or deformation
 - Sand, fibers, hair or other foreign matter sticking to the O-ring, the O-ring groove or the O-ring contact surface.
 - Damage to an O-ring groove or O-ring contact surface.
 - Attached strap or silica gel getting caught when closing the Case.

Perform the test after the above causes have been eliminated.

CAUTION:

If the advance test should show water leakage with normal handling, stop using the Case and contact your dealer or an Olympus service station.

En

3. How to connect the electronic flash

Connecting the underwater optical fiber cable

To connect the UFL-2 underwater flash (optional) to the Case using an underwater optical fiber cable (optional), follow the procedures below.

How to connect the underwater optical fiber cable

- ① Remove the cap of the optical fiber cable insertion slot.

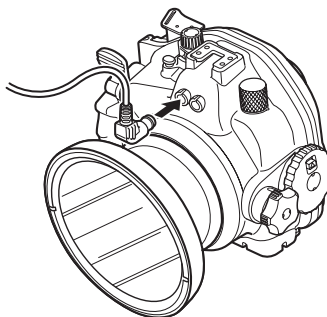

- ② Put the underwater optical fiber cable plug all the way into the optical fiber cable insertion slot.

Setting of the digital camera

- ① Set the RC mode of the camera to ON so that the camera's built-in flash is activated.
- ② Load the camera in the Case with the camera's built-in flash popped up.

Refer to the UFL-2 instruction manual for the UFL-2 operation.

CAUTION:

When using a non-Olympus manufacturer's slave-type flash with underwater optical fiber cable, set the camera's built-in flash to manual.

If the camera's built-in flash ratio is more than 1/64, the camera's built-in flash light may reflect in the lens port and be taken into the picture.

When using the TTL cable

When connecting the optional electronic flash with the underwater TTL cable (optional: PTCB-E01), connect the hot shoe cable (optional: PHCB-01) to the camera and front cover of the Case.

Connecting the underwater TTL cable

- ① Turn the TTL connector cap of the Case counter-clockwise and remove it.
- ② Connect the underwater TTL cable (optional: PTCB-E01) to the TTL connector on the Case.

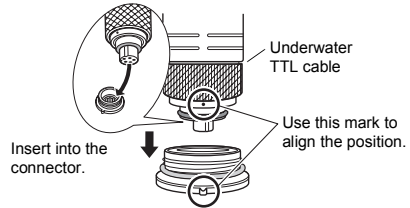

- ③ When not using the underwater TTL cable, attach the TTL connector cap.

Make sure there is no foreign matter attached to the O-rings inside the cap and on the TTL cable connector. After that, gently turn it clockwise until it stops.

Turn the threaded section of the connector clockwise gently until it stops.

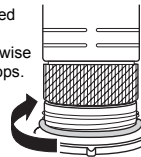

Check O-rings

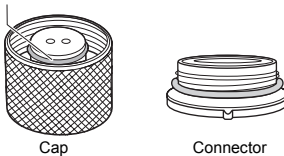

⚠ CAUTION:

If the TTL connector cap is loose, water leakage may result.

How to connect the hot shoe cable

- ① Turn the hot shoe cable connector cap inside the Case counter-clockwise to remove it.
- ② Insert the connector of the hot shoe cable into the Case's connector and turn the connector screws all the way clockwise to connect them firmly.
- ③ Load the camera in the Case, and then connect the hot shoe cable to the camera.

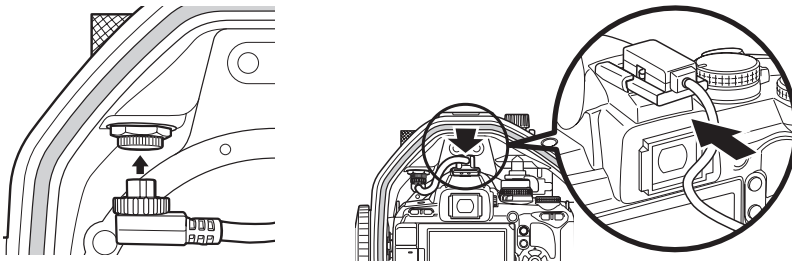

En

Setting of the digital camera

- ① Set the automatic pop-up setting of the camera to OFF. The camera's built-in flash is designed to pop up automatically when shooting under low light or against the sun in any scene mode other than the AUTO or underwater modes. For details on camera function setup, refer to the camera's instruction manual.
- ② Switch the electronic flash ON before switching the camera ON.
When using the electronic flash, be sure to turn it ON before turning the camera on.
If the automatic pop-up setting of the camera is ON and the camera is set to the scene mode other than the AUTO or underwater modes, turning the camera ON before turning the electronic flash on would cause the camera's built-in flash to pop up automatically. Always be sure to turn the electronic flash ON before turning the camera ON.

CAUTION:

- If the camera's built-in flash pops up while the hot shoe cable is connected to the camera, it will interfere with the hot shoe cable, either disconnecting it or causing a connection failure.
- When using a slave-type underwater flash from a non-Olympus manufacturer, pop the camera's built-in flash up before loading it in the Case.
- Once the Case has been sealed, the built-in flash cannot be popped up or stored.

4. Installing the digital camera

Check the digital camera

Check the digital camera before loading it in the Case.

1. Battery Confirmation

Underwater shooting can reduce battery life because the picture has to be checked on the LCD monitor before and after shooting. Make sure that you have sufficient remaining battery capacity before use.

2. Check the remaining number of pictures

Check that the image storage medium has enough room for the number of pictures you want to take.

3. Remove the strap and lens cap from the camera.

If the digital camera is loaded without removing the strap and lens cap, the Case cannot be sealed properly and may leak.

4. Remove the eyecup from the digital camera.

To improve the view of the pickup viewfinder, remove the camera's eyecup before loading it in the Case.

The eyecup removed from the camera can be stored in the camera table.

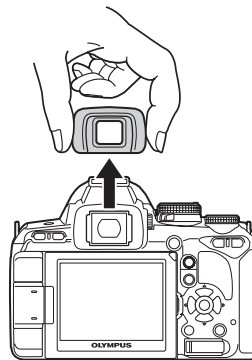

CAUTION:

In case the digital camera is loaded in the Case without removing the eyecup and the rear lid of the Case is closed, the pickup viewfinder pops out. Remove the eyecup, then push in the pickup viewfinder.

En

5. Remove the filter from the digital camera

The digital camera cannot be loaded in the Case while the filter is attached to the lens.

Open the Case

- ① Slide and hold the slide lock towards the arrow direction (①) and turn the open/close dial counter clockwise (②).
- ② Turn the open/close dial to the position where it cannot be turned further.
- ③ Open the rear lid of the Case gently.

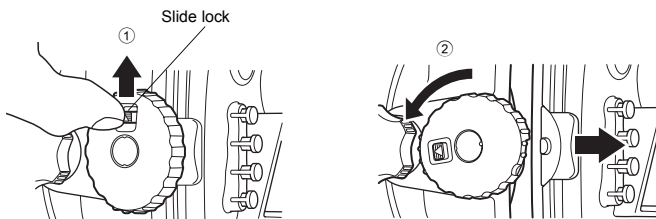

⚠ CAUTION:

Do not exert too much force while turning the open/close dial. Doing so may damage the dial.

Attach the digital camera to the camera table

In order to load the camera into the Case, attach the camera table (located on the front-lid side of the Case) to the digital camera.

- ① The eyecup and the hot shoe cover of the digital camera can be stored in the camera table.
- ② Attach the camera table to the tripod seat section on the bottom of the digital camera. Use the camera's tripod screw hole for attaching.

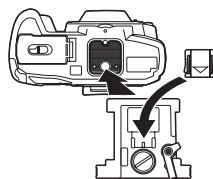

- ③ The camera table has fixed up-down and front-rear orientations. To ensure that it is properly attached, refer to the illustration on the right.

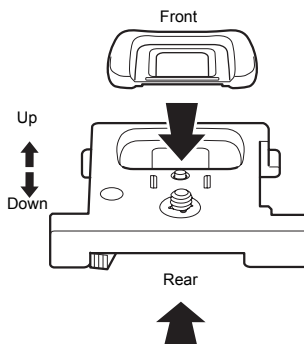

Insert the digital camera in the Case

- ① Pull out the zoom dial and mode dial on the Case (pulling out the mode dial also pulls up the power switch lever) so that they do not get in the way while loading the digital camera.



At this time, set the orientation of the power switch lever as shown below.

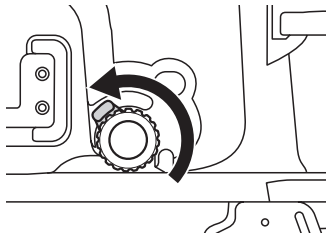

- ② After attaching the camera table to the digital camera, slide the camera table into the Case's camera table-loading groove. Do not insert the camera table by force. Slide it in gently while checking that the digital camera does not interfere with the internal parts of the Case.

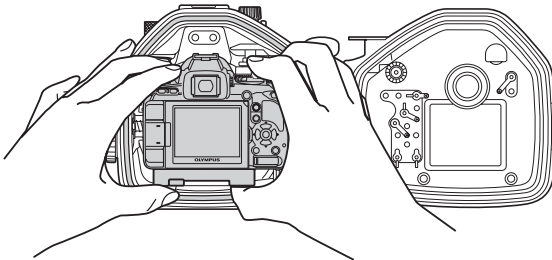

- ③ Gently push the Case's zoom dial and mode dial down and confirm that the zoom dial can smoothly control zooming, the power switch lever can turn the digital camera ON/OFF, and that the mode dial can control the mode dial of the camera.



⚠ CAUTION:

- Before loading the digital camera, attach the zoom and focus gears to the Case's zoom and focus rings. Refer to the instruction manual provided with the optional underwater lens port for details.
- If the zoom and focus gears on the lens are not properly meshed with the Case's zoom dial gear, zooming and focusing are not possible. Even when the gears are meshed, the zoom and focus control ranges may be limited due to the positioning of the zoom and focus gears in the Case. Be sure to carefully follow the instructions provided with optional underwater lens port to ensure that correctly position the gears.

④ Insert the silica gel

Before sealing the Case, be sure to insert the silica gel bag in the space between the bottom of the camera table and the inner surface of the Case. This will prevent fogging. Inset the silica gel bag laterally with the sides folded down.

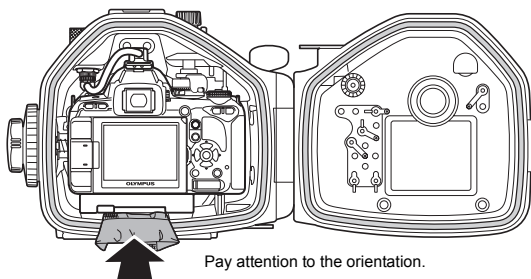

⚠ CAUTION:

- If the bag is only inserted part of the way, it will get caught by the O-ring when you try to seal the Case and water will leak into the Case.
- Once silica gel has been used, the moisture absorption performance will be impaired. Always change the silica gel when you open or close the Case.

Check the loading status

Always perform the following checks before sealing the Case.

- Is the eyecup removed correctly?
- Does maintenance of the O-ring perform properly?
- Does the zoom dial operate properly?
- Is the silica gel inserted all the way at the specified position?
- Are the O-rings and the O-ring contact surfaces free of dirt and other foreign matter?
- Are the O-rings installed properly?
- When using an external electronic flash with a TTL cable, check that the hot shoe cable is connected properly and that the camera's automatic pop-up setting is set to OFF.
- When using the UFL-2 underwater electronic flash with the underwater optical fiber cable, or when using a slave flash from a non-Olympus manufacture, check that the camera's built-in flash is popped up.

Seal the Case

- ① Close the rear lid gently (so that the O-rings do not slip out of the grooves).
- ② Turn the open/close dial clockwise.
 - The Case is sealed when the position of the slide lock is at the top.

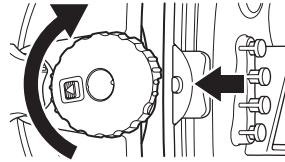

CAUTION:

If the open/close dial is not fully turned, the Case will not be sealed airtight and water leakage may occur.

Check the operation of the loaded camera

After sealing the Case, check that the camera functions normally.

- Operate the power switch lever on the Case and confirm that the camera can be turned ON/OFF.
- Turn the mode dial knob on the Case and confirm that the camera mode switches properly.
- Operate the shutter lever on the Case and confirm that the camera shutter is released.
- Operate the zoom dial on the Case and confirm that the camera's lens is controlled.
- Operate other control buttons on the Case and confirm that the camera functions properly as intended.

Perform the final checks

Visual Inspection

After closing the case tightly, check the seal between the front and rear lids and the connection between the port and case to make sure the O-rings are not twisted, that they sit properly in the grooves, and that no foreign matter has been caught between the two parts.











CAUTION:

Hair, fiber, and other narrow items are not very apparent, but they may cause entry of water, therefore special attention is required.

Water Leakage Test

The final test after loading the camera is explained below. Always perform this test. It can be performed easily in a water tank or a bathtub. The required time is about five minutes.

Simple water leakage test	Explanatory image	Hints
① Place the Case slowly into the water.		As the rear lid of the Case is transparent, waterdrops entering into it can be confirmed easily.
② At first, immerse the Case for only three seconds.		In case of trouble with the O-ring, three seconds is enough for water to enter. Are there air bubbles coming out between the lids?
③ Check that no water has entered the Case.		Remove the Case from the water and check that no water has leaked at the inside of the Case.
④ Next, immerse the Case for 30 seconds.		Check carefully for air bubbles! Do not perform any operation yet, but just observe.
⑤ Check that no water has entered the Case.		Remove the Case from the water and check that no water has leaked at the bottom of the Case.
⑥ Next, check by immersing for three minutes.		Check carefully for air bubbles! Try operation of the buttons used frequently. Check carefully for air bubbles!
⑦ This is the final check. Has the silica gel become moist?		Has the silica gel become moist? Please check carefully!
⑧ If there is no water leakage and everything is functioning correctly, you are ready to start shooting underwater.		Now everything is all right!

5. Handling After Shooting

Wipe off any waterdrop

After underwater shooting, remove any drops of water from the case. Use pressurized air or a soft, lint-free cloth to carefully wipe away any moisture from the hinge between the front and rear lids, the shutter release lever, the handgrip and the open/close dial.

 CAUTION:

Water left between the front and rear lids or between the case and port can get inside the case once it is opened or the port is detached. Please dry these areas carefully.

Unload the digital camera

First, open the open/close dial of the Case and then open the rear lid carefully. Disconnect the hot shoe cable if it is connected to the camera, then remove the Case's zoom and mode dials so that they do not interfere with removal of the camera. Gently remove the loaded digital camera, while holding it with both hands.

 CAUTION:

- When opening the case or removing the port, make sure no water from outside (e.g. drops from your hair or the diving suit) gets inside the case and/or on the camera!
- Before opening the case or removing the port, ensure that your hands or gloves are completely clean (free of sand, loose fibers, etc.).
- Never open the case or remove the port in areas where water could splash or spray or where sand or dust could be blown in the air. When this cannot be avoided, for example if the battery or memory card needs to be changed, the case and camera should be protected from the wind or spray with a plastic sheet or similar object.)
- Never touch the digital camera and/or battery when your hands are wet with sea water.

Wash the Case with pure water

After use, seal the Case again after taking out the camera and wash it sufficiently in pure water as soon as possible.

After use in sea water, it is effective to immerse it for a fixed time (30 minutes to 1 hour) in pure water to remove any salt.

 CAUTION:

- Water leakage may be caused when a high water pressure is applied locally. Before washing the Case with water, remove the digital camera from it.
- Operate the shutter lever and various buttons of this product in pure water to remove salt adhering to the shaft. Do not disassemble for cleaning.
- Letting salt dry on the case may impair the function. Always wash off any salt after use.



Dry the Case

After washing with pure water, use a lint-free soft cloth without any salt on it to wipe off any waterdrop and dry the Case completely at a well ventilated location in the shade.

 **CAUTION:**

Do not use hot air from a hair drier or the like for drying and do not expose the Case to direct sunlight, as this may accelerate deterioration and deformation of the Case and deterioration of the O-ring, leading to leakage of water.

When wiping the Case, take care not to cause scratches.

6. Maintaining the Waterproof Function

The O-ring is a consumable product. Before each use, perform proper maintenance. Always be sure to perform the O-ring maintenance operation as described below. Neglecting this maintenance may become the cause of water leakage.

Perform at the location without sand or dust, after washing and drying your hands.

Remove the O-ring

Open the Case and remove the O-ring.

Procedure

- ① Insert the O-ring remover into the gap between the O-ring and O-ring groove wall.
- ② Bring the tip of the inserted O-ring remover below the O-ring. (Be careful not to damage the groove with the tip of the O-ring remover.)
- ③ Lift the O-ring, pinch it with your fingertips and pull it out of the Case.

Remove any sand, dirt, etc.

After visually checking that dirt has been removed from the O-ring, check for attached sand and other foreign matter, as well as for damage and cracks by squeezing the entire circumference of the O-ring lightly with your fingertips.

Remove attached foreign matter from the O-ring groove with a clean cloth or a cotton swab. Also remove any sand or dirt attached to any part of the Case that comes into contact with the O-ring.

CAUTION:





- When a sharp object is used to remove the O-ring or to clean the inside of the O-ring groove, the Case and the O-ring may be damaged and water leakage may be caused.
- When the O-ring is checked with the fingertips, take care not to stretch the O-ring.
- Never use alcohol, thinner, benzene or similar solvents or chemicals detergents to clean the O-ring. When such chemicals are used, it is likely that the O-ring will be damaged or that its deterioration will be accelerated.

En

Install the O-ring

Confirm that no foreign matter is attached, apply a thin coat of the accessory grease to the O-ring, and fit the O-ring into the groove. At this time, confirm that the O-ring does not stick out from the groove.

How to Apply Grease to the O-ring

<p>① Apply only Olympus exclusive lubricant to each O-ring.</p>		<p>Make sure that your fingers and the O-ring are free of dirt, and squeeze about 5 mm of lubricant onto a finger. (5 mm is the most appropriate amount.)</p>
<p>② Spread the lubricant onto the entire circumference of the O-ring.</p>		<p>Spread the grease onto the entire circumference of the O-ring using 3 fingers. Be careful not to use excessive force as this may stretch the O-ring.</p>
<p>③ Check that the O-ring is free of scratches or unevenness.</p>		<p>After spreading the lubricant, check visually and by touch that the O-ring is not scratched and that its surface is flat. If it is damaged in any way, replace it with a brand-new O-ring.</p>
<p>④ Apply lubricant on the O-ring contact surface.</p>		<p>Use the lubricant remaining on the fingers to clean and lubricate the case's contact surface.</p>

⚠ CAUTION:

- Always perform maintenance of the waterproof function even when the Case has been opened every shooting. Neglecting this maintenance may become the cause of water leakage.
- When the Case is not to be used for a long time, remove the O-ring from the groove to prevent deformation of the O-ring, apply a thin coat of silicone grease, and store it in a clean plastic bag or the like.

Examples of foreign matter sticking to the O-ring

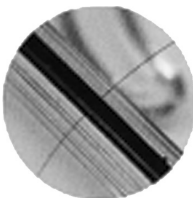

Hair



Fibers

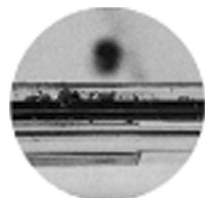

Grains of sand

Replace consumable products

- The O-ring is a consumable product. Independent of the number of times the Case is used, it is recommended that the O-ring should be replaced by a new piece at least once a year.
- Deterioration of the O-ring is accelerated by the usage conditions and the storage conditions. Replace the O-ring even before a year has passed if it shows signs of damage, cracking or loss of elasticity.

⚠ CAUTION:

- Please use genuine Olympus silicone grease, silica gel and O-ring.
- Do not try to replace the O-ring by yourself.
- We recommend to perform the check periodically.

Maintenance of the threaded sections on the TTL cable and TTL cable connector

If the threaded sections used to connect the TTL cable to the TTL cable connector are not maintained properly, salt and other seawater residue may adhere to the TTL cable and prevent it from being disconnected.

After use in seawater, clean off any salt, sand, or other residue as soon as possible, then dry the equipment thoroughly. Clean the threaded sections with a cotton swab and apply a thin, uniform layer of silicone grease (provided with this case).



Maintenance of the TTL Connector Cap

After removing the TTL connector cap from the Underwater Case, be sure to clean and grease the O-ring.

Use the maintenance adapter to remove the O-ring unit from the TTL connector cap.



- ① Insert the adapter by aligning its pin with the hole on the cap.
- ② Turn the adapter counterclockwise to remove the O-ring unit.
- ③ After removing the O-ring attached to the O-ring unit, clean the O-ring groove and apply silicone grease to the O-ring. Then, re-attach the O-ring to the O-ring unit.

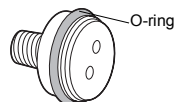

* Reverse the removal procedure to re-attach the O-ring unit to the TTL connector cap.

En

7. Appendix

Specifications

Available models	Olympus Digital Camera E-620
Pressure resistance	Depth of down to 40 m (130 feet)
Main materials	Main body: Polycarbonate resin. Open/close dial/release lever/power switch dial/mode dial/control dial/zoom dial/ camera table: Polycarbonate resin. Port mount/pickup viewfinder frame/optional bracket mount/zoom dial gear/TTL connector cap: Aluminum. Axis of operation buttons/hand strap ring: Stainless steel. Body cap: ABS resin. O-rings/LCD inner hood: Silicone rubber. LCD hood: NBR rubber.
Dimensions	Width 208.0 mm x height 169.0 mm x depth 144.0 mm
Weight	1,340 g (camera and accessories not included)

* We reserve the right to change the external appearance and the specifications without notice.

Supplied accessories for PT-E06

O-ring (for back lid): POL-E06A

O-ring (for front lid): POL-E06B

Silicone grease: PSOLG-2

Silica gel: SILCA-5S

LCD hood: PFUD-E06

Camera stand: PTMO-E05

Hand strap: PST-E02

Body cap: PBC-E02

TTL connector cap: PTAC-E04

Waterproof Port

Waterproof Port	Withstanding depth	Applicable Lens	Note
PPO-E01	60 m	14-45 mm	Packaged with the PPZR-E01 underwater zoom gear for 14-45 mm lens.
		35 mm Macro	The provided PPZR-E01 zoom gear cannot be used. The focus ring rotation angle can be increased to 360° by using the optional PPZR-E04 underwater focus gear. The magnification immediately in front of the objective is about x0.6.
PPO-E02	60 m	14-54 mm 14-54 mm II	Packaged with the PPZR-E02 underwater zoom gear for 14-54 mm, 14-54 mm II or 11-22 mm lens.
		11-22 mm	
PPO-E03	60 m	50 mm Macro	Manual focusing is possible using the provided PPZR-E01, but the focus ring rotation angle is limited to 180°. The focus ring rotation angle can be increased to 360° by using the optional PPZR-E04 underwater focus gear.
PER-E01	60 m	EC-14	When using the EC-14, attach it between the underwater lens port and PT-E series case. Zooming of the lens and manual focus cannot be operated when using EC-14.
PPO-E04 +PER-E02	60 m	7-14 mm	The PPZR-E03 underwater zoom gear for 7-14 mm lens is provided with the PER-E02.
PPO-E04	60 m	8 mm Fisheye	The focus ring angle can be rotated by 360° by using the optional PPZR-E05 underwater focus gear.
		9-18 mm Fisheye	The zoom can be operated by using the optional PPZR-E07 dedicated gear.
PPO-E05	40 m	14-42 mm	Packaged with the PPZR-E06 underwater zoom gear for 14-42 mm lens.

When the waterproof port is used in combination with a PT-E06, the maximum depth that the combination can be used at is 40 m, as specified for the waterproof port. This is true even when the PT-E06 is specified for use at depths up to 60 m.

Optional accessories

Silicone grease: PSOLG-3

Underwater optical fiber cable: PTCB-E02

TTL cable: PTCB-E01

Hot shoe cable: PHCB-01

Bracket: PTBK-E01, PTBK-E02

* When use combining PTBK-E01 and the Case, the dedicated washers are necessary in the screw part.

If you have PTBK-E01 to which dedicated washers are not bundled, please contact to customer support center.

Accessories can be purchased. Products of other model types than those describing above cannot be used.

OLYMPUS®

<http://www.olympus.com/>

OLYMPUS IMAGING CORP.

Shinjuku Monolith, 3-1 Nishi-Shinjuku 2-chome, Shinjuku-ku, Tokyo, Japan

OLYMPUS IMAGING AMERICA INC.

3500 Corporate Parkway, P.O. Box 610, Center Valley, PA 18034-0610, U.S.A. Tel. 484-896-5000

Technical Support (USA)

24/7 online automated help: <http://www.olympusamerica.com/support>

Phone customer support: Tel. 1-888-553-4448 (Toll-free)

Our phone customer support is available from 8 am to 10 pm

(Monday to Friday) ET

E-Mail: distec@olympus.com

Olympus software updates can be obtained at: <http://www.olympusamerica.com/digital>

OLYMPUS IMAGING EUROPA GMBH

Premises: Wendenstrasse 14-18, 20097 Hamburg, Germany

Tel: +49 40-23 77 3-0 / Fax: +49 40-23 07 61

Goods delivery: Bredowstrasse 20, 22113 Hamburg, Germany

Letters: Postfach 10 49 08, 20034 Hamburg, Germany

European Technical Customer Support:

Please visit our homepage <http://www.olympus-europa.com>

or call our TOLL FREE NUMBER* : **00800 - 67 10 83 00**

for Austria, Belgium, Denmark, Finland, France, Germany, Italy, Luxemburg, Netherlands, Norway, Portugal, Spain, Sweden, Switzerland, United Kingdom

* Please note some (mobile) phone services providers do not permit access or request an additional prefix to +800 numbers.

For all European Countries not listed and in case that you can't get connected to the above mentioned number, please make use of the following

CHARGED NUMBERS: **+49 180 5 - 67 10 83** or **+49 40 - 237 73 4899**

Our Technical Customer Support is available from 9 am to 6 pm MET (Monday to Friday)



MEMO

OLYMPUS[®]

<http://www.olympus.com/>

Free Manuals Download Website

<http://myh66.com>

<http://usermanuals.us>

<http://www.somanuals.com>

<http://www.4manuals.cc>

<http://www.manual-lib.com>

<http://www.404manual.com>

<http://www.luxmanual.com>

<http://aubethermostatmanual.com>

Golf course search by state

<http://golfingnear.com>

Email search by domain

<http://emailbydomain.com>

Auto manuals search

<http://auto.somanuals.com>

TV manuals search

<http://tv.somanuals.com>