

OLYMPUS®

DIGITAL VOICE
RECORDER

DS-3300

**ONLINE
INSTRUCTIONS**

Thank you for purchasing an Olympus
Digital Voice Recorder.

Please read these instructions for information
about using the product correctly and safely.
Keep the instructions handy for future reference.

To ensure successful recordings, we recommend that
you test the record function and volume before use.

EN

Table of Contents

Table of Contents	2
Safe and Proper Usage	4
General Precautions	5

1 Getting Started

Main Features	9
xD-Picture Card	10
Identification of Parts	11
Installing Batteries	13
Charging Battery	15
Information Regarding Rechargeable Batteries	16
Turning ON the Recorder	17
Power Save Mode	17
Dealer Option Items	18
CUSTOM Button (Programmable)	18
Setting Time/Date (TIME&DATE)	19
Inserting and Ejecting a Card	21

2 Basic Operations

Recording	23
Microphone Sensitivity (MIC SENSE) ...	27
Recording Modes (REC MODE)	28

Using the Variable Control Voice Actuator (VCVA)	29
Hands-free Recording	30
Recording Monitor	30
Playing	31
Erasing	33

3 Other Functions

Menu List	37
Learning to Use the Menu	38
Locking Files (LOCK)	39
Index Marks	40
LCD Display Information	41
Setting Priority Levels	43
Setting Job Data	44
Setting Option Item	46
Formatting the Card (FORMAT)	47
Hold	49

4 Preparation Before Using DSS Player

DSS Player Software	50
Installing DSS Player Software	52
Uninstalling DSS Player Software	53

Using Online Help	54
Connection to Your PC	55
Running DSS Player	58
Window Names	60

5 Managing Files on Your PC

Download Dictation Files	
from the Recorder	61
Playing a Dictation File	63
Upload Dictation Files to the Recorder	64
Direct Recording/Editing on PC	65
Changing User ID (Author ID)	66
Changing a Folder Name	67
Editing File Comments	67
Using Voice Recognition	
Software (Optional)	68
Joining Files	72
Splitting Files	74
USB Microphone/USB Speaker	76
Sending Dictation Files/	
Receiving Document Files	77

6 Using the Recorder as a Reader / Writer

Using the Recorder as a	
Reader/Writer	88

7 Other Information

Alarm Message List	89
Troubleshooting	90
Accessories (Optional)	91
Specifications	92
Technical Assistance and Support	93

Safe and Proper Usage

Before using your new recorder, read this manual carefully to ensure that you know how to operate it safely and correctly. Keep this manual in an easily accessible location for future reference.

Important Safety Precautions

Certain symbols are used in the user's manual and on this product to help protect users, their surroundings, and their property from possible injury or damage. Please familiarize yourself with the following definitions and meanings for each symbol before reading the precautions.

 Danger	Signifies danger which may result in serious injury or death.
 Warning	Indicates items or actions which may cause serious injury or death.
 Caution	Indicates items or actions which may result in damage or personal injury.

Symbols prohibiting a specific action



Prohibited



Do not disassemble

Symbols requiring a specific action



Mandatory



Unplug from power outlet

Convention Used In this Manual

- The word "card" is used to refer to the xD-picture Card.
- The word "DSS Player" is used to refer to the DSS Player Pro Dictation Module in Windows environment and DSS Player in Apple Macintosh environment.
- The Notes at the bottom of a page are used for additional information, exceptions, or related events.
- Words in uppercase form such as PLAY or REC are used to describe a function, button, or switch position on the recorder.
- The icon  indicates that feature or setting can be modified by Professional Olympus Authorized Dealer only.

General Precautions

- Do not leave the recorder in hot, humid locations such as inside a closed automobile under direct sunlight or on the beach in the summer.
- Do not store the recorder in places exposed to excessive moisture or dust.
- Do not use organic solvents such as alcohol and lacquer thinner to clean the unit.
- Do not place the recorder on top of or near electric appliances such as TVs or refrigerators.
- Avoid recording or playing back near cellular phones or other wireless equipment, as they may cause interference and noise. If you experience noise, move to another place, or move the recorder further away from such equipment.
- Avoid sand or dirt. These can cause irreparable damage.
- Avoid strong vibrations or shocks.
- Do not disassemble, repair or modify the unit yourself.
- Do not operate the unit while operating a vehicle (such as a bicycle, motorcycle, or go-cart).
- Keep the unit out of the reach of children.

<Warning regarding data loss>

Recorded content in memory may be destroyed or erased by operating mistakes, unit malfunction, or during repair work.

It is recommended to back up and save important content to other media such as a computer hard disk.

Batteries/Rechargeable Battery Pack (BR402)

Danger

- Do not solder lead wires or terminals directly onto a battery or modify it.
- Do not connect the ⊕ and ⊖ terminals together. This may cause fire, overheating or electric shock.
- When carrying or storing the battery (BR402), be sure to put it in the provided case to protect its terminals. Do not carry or store the battery with any metal objects (such as key rings). If this warning is not followed, fire, overheating or electric shock may occur.
- Do not connect the batteries directly to a power outlet or a cigarette lighter of an automobile.
- Do not insert the batteries with their ⊕ and ⊖ terminals reversed.
- If any liquid from a battery gets into your eyes, promptly wash it off with clean water and consult your doctor at once.
- There is a hole from which gas escapes on the ⊕ terminal. Do not cover or block it (BR402).

Warning

- Batteries should never be exposed to flame, heated, short-circuited or disassembled.
- Do not attempt to recharge alkaline, lithium or any other non-rechargeable batteries.
- Never use any battery with a torn or cracked outer cover.

- Keep batteries out of the reach of children.
- If you notice anything unusual when using this product such as abnormal noise, heat, smoke, or a burning odor:
 - ① remove the batteries immediately while being careful not to burn yourself, and;
 - ② call your dealer or local Olympus representative for service.
- Do not expose the rechargeable batteries to water. Do not allow water to contact the terminals.
- Do not remove or damage the battery insulating sheet.
- Do not use the batteries if you find something wrong with them such as leakage, color change or deformity.
- Unplug the charger if the charging is still incomplete after the specified time it should take.
- Should any battery liquid get on skin or clothing, promptly wash it off with clean water.
- Keep batteries away from fire.

Caution

- BR402 rechargeable batteries are exclusively for use with Olympus digital voice recorder DS-3300. Do not use them in combination with other equipment.
- Do not subject batteries to strong shocks.
- Do not use with other types of batteries, or with batteries that have different voltages or brand names.
- When using more than two batteries, charge them at the same time.

- When using new batteries, or batteries which have not been used for a long time, be sure to recharge them even if they were only used for a short period of time.

Battery Charger (Cradle)

Danger



- Do not attempt to use this charger with anything other than Olympus Ni-MH batteries. Using it in combination with other batteries may cause fire, explosion, leakage or overheating.



- Do not put the charger in water. Using it when wet or in a humid area (such as a bathroom) may cause fire, overheating or electric shock.



- Do not use the charger with batteries that have been inserted with their \oplus and \ominus terminals reversed. This may cause fire, explosion, leakage, overheating or damage to batteries.



Do not disassemble

- Never modify or disassemble the charger. This may cause fire, overheating, electric shock or injury.

Warning



- Do not use the batteries if you find something wrong with them such as deformity or leakage. This may cause explosion or overheating.



- Do not insert metal wires or similar objects. This may cause fire, overheating or electric shock.



- Keep out of the reach of children. Do not let children use this product without adult supervision.

Caution



- If charging is not completed (if the charging indicator is not turned off) after 3 hours, plug the power-supply cord out. Contact the store of purchase or Olympus Service Station for repair since it may be a malfunction.



- Be sure to charge batteries within the temperature range of 0°C - 40°C/32°F - 104°F. If not, there may be explosion, fire, leakage or damage to batteries.



- Do not put anything heavy on the charger or leave it in an unstable position or in a humid place. This may cause explosion, fire, leakage, overheating, electric shock or injury.



- Do not touch the charger for too long when using it. This may cause a serious low-temperature burn.



- If charging does not finish (or if the charge indicator light does not go off) after three hours, the charger may break. If this occurs, disconnect the power plug and consult your nearest Olympus dealer or customer support center.



- Do not use or store the charger in/on an unstable place, such as a television set, etc. If it falls, it may cause injury or break.

AC Adapter

Danger



- Be sure to use the charger with the proper voltage (AC 100 - 240 V). Using it with other voltage levels may cause fire, explosion, overheating, electric shock or injury.



Unplug from
power outlet

- For safety, be sure to unplug the charger from the outlet before performing maintenance or cleaning. Also, never plug in or disconnect the power plug with a wet hand. This may cause electric shock or injury.

Warning

- Do not attempt to disassemble, repair or modify the AC adapter in any way.
- Keep foreign objects including water, metal, or flammable substances from getting inside the product.

- Do not moisten the AC adapter or touch it with a wet hand.
- Do not use the AC adapter in the vicinity of flammable gas (including gasoline, benzene and lacquer thinner).

In case

- ... the internal parts of the AC adapter are exposed because it has been dropped or otherwise damaged:
- ... the AC adapter is dropped in water, or if water, metal flammable substances or other foreign objects get inside it:
- ... you notice anything unusual when using the AC adapter such as abnormal noise, heat, smoke, or a burning odor:
 - ① do not touch any of the exposed parts;
 - ② immediately disconnect the power supply plug from the power outlet, and;
 - ③ call your dealer or local Olympus representative for servicing. Continued use of the AC adapter under these circumstances could result in electric shock, fire or injury.

Caution



- Do not use the charger if the power plug is damaged or the plug is not completely connected to the outlet. This may cause fire, overheating, electric shock, short circuit or damage.



Unplug from
power outlet

- Unplug the AC Adapter from AC outlet when not using. If this precaution is not followed, fire, overheating or electric shock may occur.



- Make sure to hold the plug when removing the power plug from the outlet. Do not bend the cord excessively or put a heavy object on it. This may cause fire, overheating, electric shock or damage.



- If something appears to be wrong with the charger, unplug the charger from the outlet and consult your nearest service center. Using the charger may cause fire, overheating, electric shock or injury.



- Do not use or keep the charger in very hot places, such as in direct sunlight, in a closed car on a sunny day, near a heater, on an electric carpet, etc. Do not use the charger if something is covering it (such as a blanket). This may cause fire, explosion, leakage or overheating.

Main Features

- Dual function cradle, docking station, for recharging of the optional Ni-MH Rechargeable Battery Pack (BR402) (☞ P.14)*¹ and for downloading data from the recorder to a PC (☞ P.61).
- The recorder has multi programmable button (CUSTOM) (☞ P.18).
- Recording and storing voice in DSS format.
- Two recording modes, SP (Standard Playback) mode or LP (Long Playback) mode (☞ P.28).
- Five folders and up to 199 files/folder, for a maximum of 995 recordings (☞ P.23).
- Built-in Variable Control Voice Actuator (VCVA) function (☞ P.29).
- USB Audio Device, recorder can be used as a USB microphone or USB speaker when connected to a PC (☞ P.76).^{*2}
- Large LCD screen with backlight.
- Multi-level priority setting (☞ P.43).
- DSS Player software included (☞ P.50).
- Hands-free recording function when used with the optional foot switch (RS25/26) (☞ P.30).

*¹ Available only with the optional Ni-MH Rechargeable Battery Pack (BR402).

*² Do not use with Windows 98 as computer operation may become unstable.

IBM and PC/AT are the trademarks or registered trademarks of International Business Machines Corporation.

Microsoft and Windows are registered trademarks of Microsoft Corporation.

Apple, Macintosh, iMac, eMac, Mac, and PowerMac are trademarks or registered trademarks of Apple Computer, Inc.

Intel and Pentium are registered trademarks of Intel Corporation.

Adobe and Acrobat Reader are registered trademarks of Adobe Systems Incorporated.

Other product and brand names mentioned herein may be the trademarks or registered trademarks of their respective owners.

xD-Picture Card

The xD-Picture Card is a removable recording media.

Compatible Cards

The removable card can be used to store different kind of data. Since the card has larger memory capacity than a diskette, it can be used to transfer data between different PCs. The recorder supports cards with memory capacity between 16 to 512 MB.



① **Index area**
You can write down the card's contents.

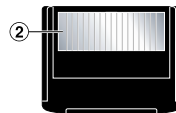

② **Contact area**
Comes into contact with the recorder's signal read contacts.

Memory Sizes of Cards and Approximate Recording Times*1

Memory Size	SP Mode	LP Mode
16MB	2 hr. 35 min.	5 hr. 30 min.
32MB	5 hr. 13 min.	11 hr. 00 min.
64MB	10 hr. 25 min.	22 hr. 20 min.
128MB	20 hr. 55 min.	44 hr. 45 min.
256MB	42 hr. 00 min.	89 hr. 40 min.
512MB	84 hr. 05 min.	179 hr. 30 min.*2

*1: Available recording time for one continuous file.
Available recording time may be shorter if many short recordings are made.

*2: Total recording time of two files. The maximum recording time per file is 99 hours.

Notes

- When initializing (formatting) a card, confirm that no necessary data is stored on the card beforehand. Initialization completely erases the existing data on the card.
- Cards used in a recorder must be formatted in the same recorder first unless formatted with a CAMEEDIA series Olympus digital camera. Card may not perform as expected when formatted by a different device.
- The card has a service life. When reaching the end of its life, writing or erasing data on the card will be disabled. In this case, replace the card.
- If you use a PC card adapter compatible with the card to save or delete some data on the card, the maximum recording time on the card may be decreased. To recover the original recording time, initialize/format the card in the recorder.
- Olympus will not be held liable for any data corruption or loss due to misuse of the media card.

Identification of Parts

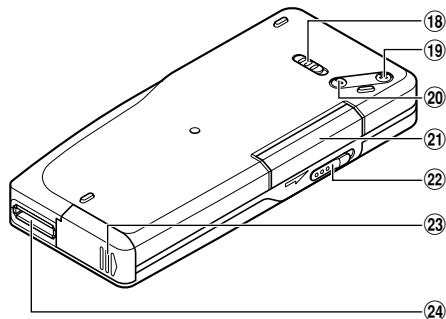
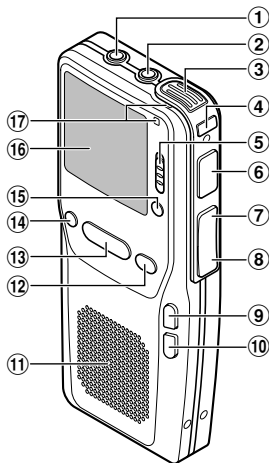

- ① EAR (Earphone) jack
- ② MIC (Microphone) jack
- ③ Built-in microphone
- ④ NEW button
- ⑤ HOLD switch
- ⑥ REC (Record) button
- ⑦ REW (Rewind) button
- ⑧ FF (Fast Forward) button
- ⑨ INDEX button
- ⑩ FOLDER/MENU button
- ⑪ Built-in speaker
- ⑫ STOP button
- ⑬ PLAY button

- ⑭ ERASE button
- ⑮ CUSTOM button
(Programmable)
- ⑯ Display (LCD panel)
- ⑰ Record/Play indicator lamp
- ⑱ POWER (ON/OFF) switch
- ⑲ VOLUME (+) button
- ⑳ VOLUME (-) button
- ㉑ Card cover
- ㉒ Card cover lock
- ㉓ Battery cover
- ㉔ PC (USB) terminal/Cradle
attachment point

Display (LCD Panel)

Identification of Parts

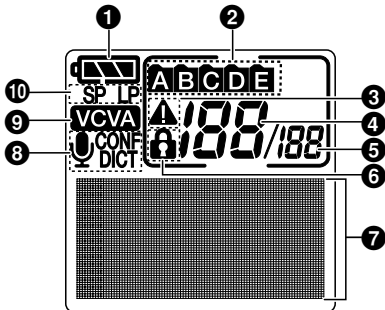

- 1 Battery indicator
- 2 Folder
- 3 Priority indicator
- 4 Current file number
- 5 Total number of recorded files in the folder
- 6 Erase lock indicator
- 7 Character Information display
- 8 Microphone sensitivity display
- 9 VCVA (Variable Control Voice Actuator) indicator
- 10 Record mode indicator

Installing Batteries

AAA alkaline batteries

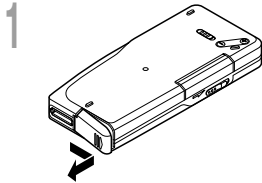

1 Lightly press down on the arrow and slide the battery cover open.

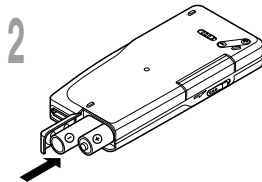

2 Insert two AAA batteries, observing the correct polarity.

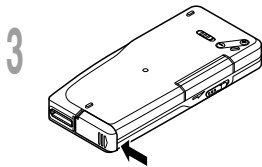

3 Close the battery cover completely.

Replacing batteries

The battery indicator on the display changes as the batteries lose power.

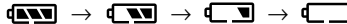

When  appears on the display, replace the batteries as soon as possible.

When the batteries are too weak, the recorder shuts down and “BATTERY LOW” appears on the display.

Notes

- **Be sure to turn OFF the recorder before replacing the batteries.** Removing the batteries while the recorder is in use may corrupt the card. If you are recording into a file and the batteries run out, you will lose your currently recorded file since the file header will not be written. It is crucial to replace the batteries when one hash mark in shown in the battery icon.
- Be sure to replace both batteries at the same time.
- **Never mix old and new batteries, or batteries of different types and/or brands.**
- If it takes longer than 1 minute to replace dead batteries, you may have to reset the time when you load new batteries.
- Remove the batteries if you are not going to use the recorder for an extended period of time.

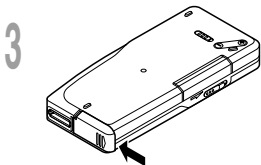
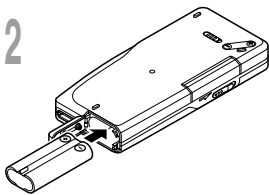
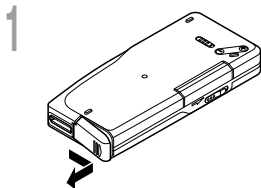

Ni-MH Rechargeable Battery Pack (BR402) (Optional)

An optional Ni-MH Rechargeable Battery from Olympus can be used for the recorder.

1 Lightly press down on the arrow and slide the battery cover open.

2 Insert Ni-MH Rechargeable Battery Pack, observing the correct polarity.

3 Close the battery cover completely.

The battery needs to be charged when you use the recorder for the first time after purchase (☞ P.15).

Recharging battery

The battery indicator on the display changes as the battery loose power.

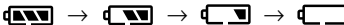

When  appears on the display, charge the battery as soon as possible.

When the battery is too weak, the recorder shuts down and “BATTERY LOW” appears on the display.

Notes

- The Olympus Ni-MH Rechargeable Battery Pack (BR402) is sold separately.
- Removing the battery pack while the recorder is in use may corrupt the file. If you are recording into a file and the battery run out, you will lose your currently recorded file since the file header will not be written. It is crucial to charge the battery once you see only one hash mark in the battery icon.
- Remove the battery pack if you are not going to use the recorder for an extended period of time.

Charging Battery

You can charge the Ni-MH Rechargeable Battery Pack (BR402) in the recorder when you set the recorder in the cradle. The battery is usually shipped partially charged. You need to charge the battery before first use.

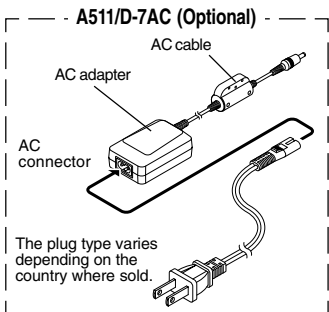

1 Connect the optional AC adapter (A511/D-7AC) or USB cable to the cradle.

For connection procedures, see P.57.

When using the adapter for charging, connect the power plug to the charger's AC connector.

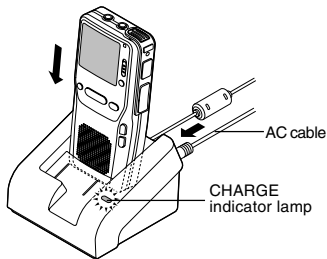

2 Turn ON the recorder and set it vertically in the cradle.

CHARGE indicator lamp glows red and the charging starts.

The lamp goes out when the charging is complete.

Notes

- The Olympus AC adapter (A511/D-7AC) is sold separately.
- Charge the battery often for first few uses. Battery performs better after several full charge/discharge cycles.
- Ni-MH battery pack (BR402) is only chargeable with the Olympus AC adapter A511 or D-7AC.
- If you charge the battery right after charging is complete, it will take only few minutes to charge the battery.
- The PC must be ON when charging battery via the USB cable connection.
- Charging battery via the USB cable connection may not be successful depending on the power supply capacity of your PC. Use the AC adapter instead.
- If you change the recorder to AUDIO device while charging battery only via the USB cable connection, charging may stop.
- Do not set or remove the recorder from the cradle while it is in operation.
- You can charge the battery while the recorder is in operation.

Information Regarding Rechargeable Batteries

These batteries are exclusively for use with Olympus voice recorder DS-3300. Never use them in combination with other equipment.

Discharging

Batteries self-discharge while they are not in use. Be sure to charge them regularly before use.

Battery life

Charging and discharging are possible for approximately 500 times depending on usage.

Operating temperature

Batteries are chemical products. Battery efficiency may change even when operating within the recommended temperature range, but this is not a malfunction.

Recommended temperature range for use

Discharging (when using appliance): 0°C - 50°C/32°F - 122°F

Charging: 0°C - 40°C/32°F - 104°F

Storage: -20°C - 30°C/-4°F - 86°F

Using the batteries outside the above temperature range may result in declining efficiency and shorter battery life.

In order to prevent battery leakage or rust, remove the batteries from the products when you will not be using them for a long time, and store them separately.

Notes

This charger is designed to fully charge batteries regardless of their energy level. However, for best results when charging newly purchased batteries or batteries that have not been used for a long time (more than one month), it is recommended to fully charge the batteries, then discharge them. Repeat two or three times.

- When you dispose dead batteries always observe the laws and regulations regarding the disposing of such items.
- If Ni-MH rechargeable batteries are not fully discharged, protect against short-circuiting (e.g. by taping the contacts) before disposing.

**(NL) Batterij niet
weggoien, maar
inleveren als KCA.**



For customers in Germany

Olympus has a contract with the GRS (Joint Battery Disposal Association) in Germany to ensure environmentally friendly disposal.

Turning ON the Recorder

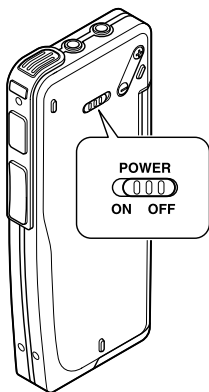

With the battery charged in the recorder and the card inserted properly, the recorder is ready to work.

While the power switch on the back of the recorder is in the OFF position, none of the buttons or switch on the recorder will be active. Slide the power switch to the ON position to activate the recorder.

Power Save Mode

When the recorder is ON but not in use for 10 minutes, by default, it will switch to power save mode automatically. To reactivate the recorder again, press any of the buttons on the recorder.

Dealer Option Items

Some additional options can be set by your Olympus Professional Dealer. These additional and customisable options are as follows:

- Setting for “beep” sound.
- Setting for NEW button operation.
- Setting for REC button operation.
- Setting for Splash screen.
- Adding/removing of user defined fields.
- Switching the display languages.
- Changing the number of folders.
- Assigning functionality to CUSTOM button.
- Assigning functionality to the foot switch.
- Setting time for Power save mode.
- Setting to lock the file automatically on completion of recording.
- Setting for intervals of acceleration when using CUE and REV.
- Setting to select the AUTHOR ID when the recorder is turned on.

For details on the functions and operation of dealer optional items, consult your Olympus dealer.



CUSTOM Button (Programmable)

The CUSTOM button can be assigned two kinds of functions by being pressed in different ways. By default, the button is programmed on PRIORITY for both ways:

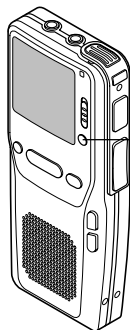

CUSTOM button
(Programmable)

Default	Operation
PRIORITY button	Press the CUSTOM button.
	Press and hold the CUSTOM button.

The following functions can be assigned to CUSTOM button.

- DISPLAY button
- Recording Mode setting button
- Microphone Sensitivity setting button
- VCVA setting button
- PRIORITY setting button

Setting Time/Date (TIME&DATE)

Setting the correct time and date on the recorder is very important since every file recorded on the recorder will have the date and time information as part of the file header. This will simplify the file management aspects later on.

The hour indicator will flash automatically when you load batteries before using the recorder for the first time, or after the recorder hasn't been used for a long time. Proceed from step 1.

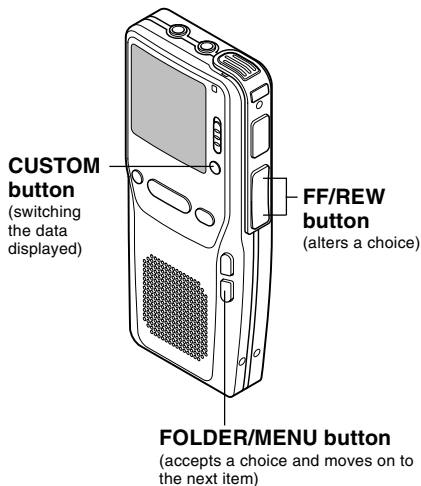

1 Set the hour.

- 1 Press the **FF** button or **REW** button to set the hour.
 - 2 Press the **REC** button to accept the hour.
- You can choose between 12 and 24 hour display by pressing the **CUSTOM** button while setting the hour and minute.

Example: 5:45 P.M.

5:45 PM ↔ 17:45
(Initial setting)

2 Set the minute.

- 1 Press the **FF** button or **REW** button to set the minute.
- 2 Press the **REC** button to accept the minute.

3 Set the year.

- 1 Press the **FF** button or **REW** button to set the year.
 - 2 Press the **REC** button to accept the year.
- You can choose a different date format by pressing the **CUSTOM** button while setting the date.

Setting Time/Date (TIME&DATE)

Example: March 14, 2005

3M 14D 2005Y (Initial setting)



14D 3M 2005Y



2005Y 3M 14D



4 Set the month.

- 1 Press the **FF** button or **REW** button to set the month.
- 2 Press the **REC** button to accept the month.

5 Set the day.

- 1 Press the **FF** button or **REW** button to set the day.
- 2 Press the **REC** button to accept the day's date.

Notes

- If you press the STOP button during the setup operation, the recorder will save the items that were set to that point.
- You can set the time and date from your PC using DSS Player software (P.50).

Changing the Time/Date

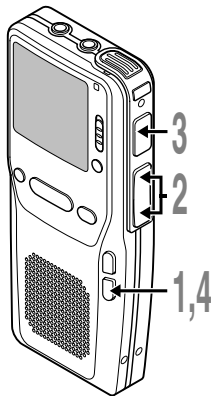

1 Press and hold the **FOLDER/MENU** button for 1 second or longer.

The menu appears (P.37).

2 Press the **FF** or **REW** button until "TIME&DATE" in SUB MENU flashes on the display.

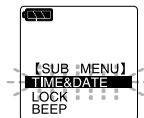

3 Press the **REC** button.

Time/Date screen appears. The hour indicator flashes, indicating the start of the Time/Date setup process. Follow the same steps starting at step 1 in "Setting Time/Date" (P.19).

4 Press the **FOLDER/MENU** button to close the menu.

Inserting and Ejecting a Card

Inserting a Card

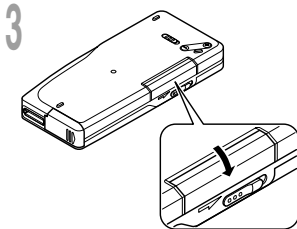
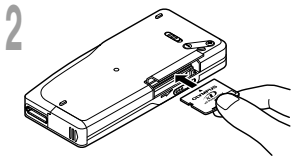
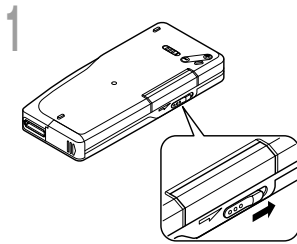

1 Slide the card cover lock in the direction indicated by the arrow.

The card cover is unlocked and the message “CARD COVER IS OPEN” appears on the display. When this message appears, the power is switched off automatically.

2 Face the card the correct way and insert it into the card slot as shown in the diagram.

- Insert the card keeping it straight.
- The card stops with a click when it is inserted all the way.
- Inserting the card the wrong way or at an angle could damage the contact area or cause the card to jam.
- If the card is not inserted all the way, data may not be written to the card.

3 Close the card cover securely.

Card inserted fully into the slot

The message “PLEASE WAIT” on the display flashes for seconds.

Card not inserted fully into the slot

When the card cover is closed, the message “INSERT CARD” on the display flashes for a few seconds. Pressing any button will sound beeps* and flash the message “INSERT CARD” again.

* When the system sounds are enabled.

Notes

- If an unformatted card is inserted, the recorder automatically displays the menu to menu format option (P.47).
- Never use any card in the recorder unless it has been formatted on this unit or on a CAMELIA series Olympus digital camera (P.47).

1 Ejecting a Card

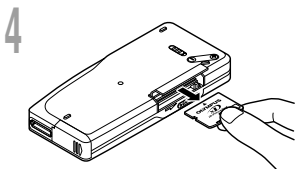
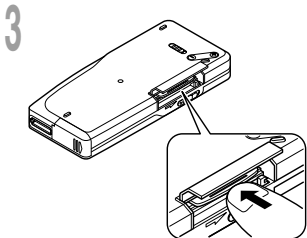
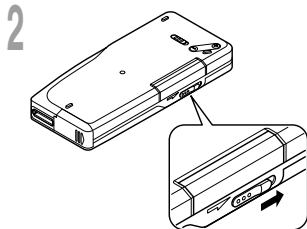

1 Make sure the recorder is STOP mode.

2 Slide the card cover lock in the direction indicated by the arrow.

The card cover is unlocked and the message “CARD COVER IS OPEN” appears on the display. The power is switched off automatically.

3 Push the card inward to unlock it, and let it eject partially.

The card is visibly out of the slot and can be removed safely.

4 Hold the card straight and pull it out.

Note

Releasing your finger quickly after pushing the card inward may cause it to eject forcefully out of the slot.

Recording

By default, the recorder has five folders, **A**, **B**, **C**, **D**, **E** and you can select folder by pressing the FOLDER/MENU button. These five folders can be selectively used to distinguish the kind of recording; for example, Folder **A** might be used to store private information, while Folder **B** might be dedicated to holding business information. You can use your DSS player to change a folder name (P.67). Up to 199 messages can be recorded per folder.

All recordings made in any of the folders will be in Digital Speech Standard (DSS) format. By default, the RECORD function is configured to record at the current position (overwrite). However, that can be changed to any of the following settings:

- Append: Appends the recording to the end of the current file.
- Insert: Inserts the recording at the current position in the file.
- Overwrite: Overwrites the recording starting at the current position in the file.

New Recording

Create a new file to record in.

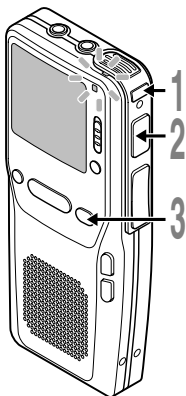

1 Press the **NEW** button to create a new file.

- (a) Current recording mode
- (b) New file number
- (c) Selected Author ID



2 Press the **REC** button to start recording.

The record/play indicator lamp glows red.
Aim the microphone at the sound source.

- (d) Current recording time
- (e) Remaining recording time

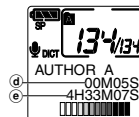

3 Press the **STOP** button to stop recording.

If you want to append additional recordings to the same file, press the REC button again.

Pause

Press the **REC** button while recording.

➡ “REC PAUSE” will flash on the display.

- The recorder stops when it has been left paused for 10 minutes or longer.

Resume Recording

Press the **REC** button again.

➡ Recording will resume at the point of interruption.

Notes

- A beep will sound when the remaining recording time reaches 60 seconds, 30 seconds, and 10 seconds while recording.
- “MEMORY FULL” or “FOLDER FULL” will be displayed when the memory or folder capacity is full. Delete any unnecessary files before recording any further (☞ P.33) or transfer dictation files to your computer using DSS Player Software (☞ P.58).
- You cannot select a different recording mode (SP or LP) than that of the original file when appending recording.

Review Recording

Press the **REW** button while recording, and release it when you want to start playing a file. The recorder plays up to the end of file, then stops.

You can overwrite or append additional recordings in the same file from that point.

Overwrite Recording

You can overwrite a previously recorded file from any point within the file. Note that the overwritten recordings will be erased.

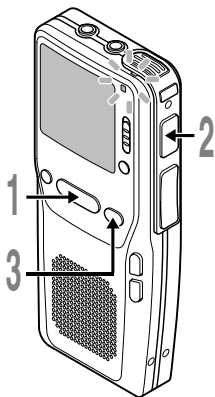

- 1 **Select and play the file you want to overwrite.**
Stop playback at the starting point of overwrite.
- 2 **Press the **REC** button to start overwriting.**
The record/play indicator lamp glows red.
- 3 **Press the **STOP** button to stop overwriting.**



Note

You cannot select a different recording mode (SP, LP) than that of the original file before overwrite recording.

Insert Recording

Additional recording can be inserted into previously recorded file.

2

Recording

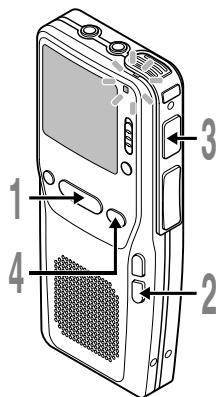

1 Select and play the file you want to insert an additional recording into.

2 While playing the file, press the **FOLDER/MENU** button to insert an additional recording.

“INSERT ?” appears on the display.

3 Press the **REC** button to start inserting an additional recording.

The record/play indicator lamp glows red. “INSERT REC” and the remaining recording time will alternate on the display.

4 Press the **STOP** button to stop inserting the additional recording.

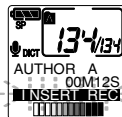
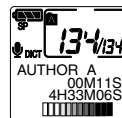

Notes

- The recording time and date of the file is updated to the time and date of the inserted recording.
- You cannot select a different recording mode (SP, LP) than that of the original file before inserting.

Microphone Sensitivity (MIC SENSE)

Microphone sensitivity is adjustable to meet recording needs.

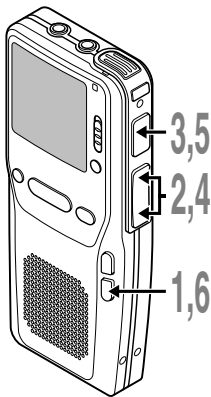

1 Press and hold the **FOLDER/MENU** button for 1 second or longer.
The menu appears (see P.37).

2 Press the **FF** or **REW** button until “**MIC SENSE**” flashes on the display.

3 Press the **REC** button.
The microphone sensitivity setup process begins.

4 Press the **FF** or **REW** button to choose between “**CONF.**” and “**DICT.**”.
CONF.: High-sensitivity mode that records sounds in all directions.
DICT.: Low-sensitivity mode suited for dictation.

5 Press the **REC** button to select the option.

6 Press the **FOLDER/MENU** button to close the menu.

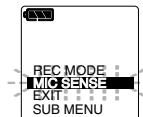

Microphone Sensitivity (MIC SENSE)

2

Note

If you want to record clear or noise-free dictation, select DICT mode and place the microphone 5 to 10 cm (2 to 4 inches) from the source.

Recording Modes (REC MODE)

The recording mode can choose between SP (standard recording) and LP (long-term recording).

2

Recording Modes (REC MODE)

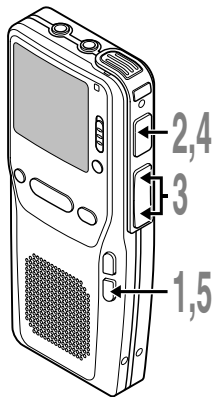

- 1 Press and hold the **FOLDER/MENU** button for 1 second or longer.

"REC MODE" will be displayed on the screen (see P.37).

- 2 Press the **REC** button.

The recording mode setup process begins.

- 3 Press the **FF** or **REW** button to choose between "SP" and "LP".

- 4 Press the **REC** button to select the option.

- 5 Press the **FOLDER/MENU** button to close the menu.

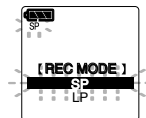
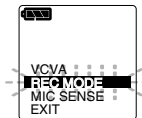

Note

Choose SP mode for recording meetings or lectures with crisp clarity.

Using the Variable Control Voice Actuator (VCVA)

When the microphone senses that sounds have reached a preset actuation volume level, the built-in Variable Control Voice Actuator (VCVA) starts recording automatically, and stops when the volume drops below the actuation level. The VCVA feature helps extending recording time and conserves the memory by turning off recording during silent periods. This helps make the playback, with no lulls or dead space, more efficient and convenient.

2

Using the Variable Control Voice Actuator (VCVA)

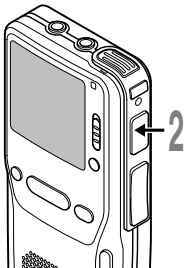

1 **Set the VCVA in the menu to ON** (☞ P.37-38).

2 **Press the REC button to start recording.**

When the sound volume is lower than the preset actuation sound level, recording automatically stops after 1 second approximately, and "STANDBY" flashes on the display. The record/play indicator lamp glows when recording starts and flashes when recording pauses.



Adjust the Start/Stop Actuation Level

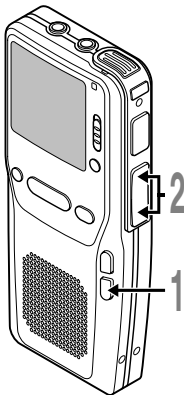

1 **Press the FOLDER/MENU button during recording.**

The VCVA level screen is displayed.

2 **Press the FF or REW button to adjust the actuation level.**

The VCVA level can be set to any of 15 different values. The higher the value is, the more sensitive the recorder can react to sounds. At the highest value, even the faintest sound will activate recording. The VCVA actuation level can be adjusted according to the ambient (background) noise.

- a **Start level (varies according to the sound volume being recorded)**
- b **Level meter (moves to the right/left according to the set level)**

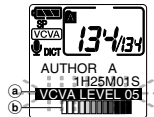

Notes

- The start/stop actuation level also varies depending on the selected microphone sensitivity mode (☞ P.27).
- To ensure successful recordings, prior testing and adjustment of the start/stop actuation level is recommended.

Hands-free Recording

The recorder can be used as a hands-free recording device. To setup the recorder for hands-free operation, connect the optional Olympus foot switch (RS25/26) to the back of the cradle and place the recorder in the cradle as shown in the diagram below.

2

Hands-free Recording/ Recording Monitor

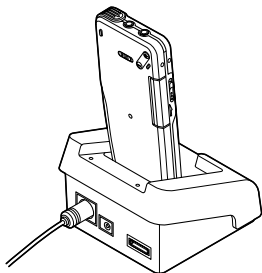

The default settings of the foot switch functions are as follow:

Default settings			
Switch	Press	Press and hold	Release
FF	NEW	-	-
LISTEN	-	REC	STOP
REW	-	REV	PLAY

Notes

- The Olympus foot switch (RS25/26) is sold separately.
- Make sure the recorder is STOP mode before connecting it to the cradle for hands-free recording.
- To record with better quality using the hands-free recording function, set the microphone sensitivity to "CONF." mode, or use an external microphone.

Recording Monitor

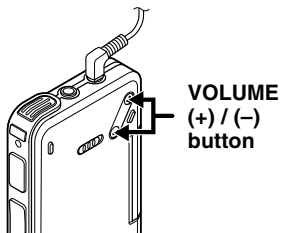

It is possible to monitor your recording by listening to the recording while recording is in progress. Insert the earphone plug into the earphone jack and use the VOLUME button to control the volume level.

Note

- 30** Insert the plugs to the end as shown in the illustration when inserting the earphone or external microphone.

Playing

You can start playing a file at any point.

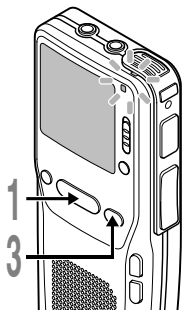

1 Select the file, then press the **PLAY** button to start playback.

The record/play indicator lamp glows green.

- a **Current playback time**
- b **Total recording time of the file being played**

2 Press the **VOLUME (+)** or **VOLUME (-)** button to adjust the volume.

The display shows the volume level. You can choose between 0 to 30.

3 Press the **STOP** button at any point you want to stop the playback.

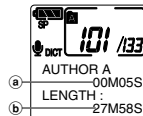

Playback functions

2

Playing

Playback functions	Operation	How to Cancel
Fast Forward (FF)	Press the FF button once while stopped.	Press the PLAY button. ➔ The recorder starts the operation of the set position.
Rewind (REW)	Press the REW button once while stopped.	
Cue (CUE)	Hold the FF button while stopped or playing a file.	Release the FF button.
Review (REV)	Hold the REW button while stopped or playing a file.	Release the REW button.

- If you press the FF button once while fast-forwarding or twice while stopped, the recorder will stop at the end of the file (F.SKIP).
- If you press the REW button once while rewinding or twice while stopped, the recorder will stop at the beginning of the file (B.SKIP). If the REW button is pressed within 2 seconds, the recorder skips to the beginning of the previous file.

Erasing

Erasing a File

Erasing or deleting a file from any of the folder on the recorder is a very simple process.

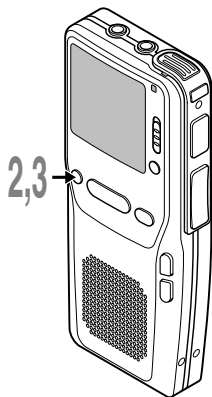

1 Select the file you want to erase.

2 Press the **ERASE** button.
“FILE ERASE ?” flashes on the display for approximately 8 seconds.

3 Press the **ERASE** button once more while “FILE ERASE ?” is flashing.
The display changes to “FILE ERASE !” and erasing will start.

“ERASE DONE” is displayed when the file is erased. File numbers will be reassigned automatically.

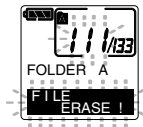
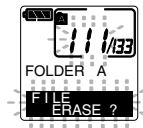

2

Erasing

Notes

- If the ERASE button is not pressed within the 8 seconds after “FILE ERASE?” starts flashing, the recorder will revert to the stop status.
- An erased file cannot be restored.
- Locked files cannot be erased (ⓘ P.39).

Erasing All Files in a Folder

All files in a folder can be erased simultaneously, except for locked files (see P.39).

2

Erasing

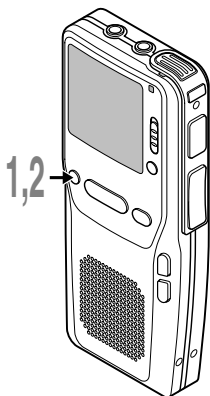

1 Select any file in the folder, then **press and hold the ERASE button for 3 seconds or longer.**

“ALL ERASE ?” flashes on the display for approximately 8 seconds.

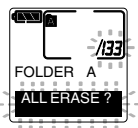

2 Press the **ERASE button once more while “ALL ERASE ?” is flashing.**

The display changes to “ALL ERASE !” and erasing will start.

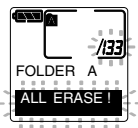

“ERASE DONE” is displayed when the files are erased. Any locked files in the folder will be reassigned new file numbers in ascending order.



Notes

- If the ERASE button is not pressed within the 8 seconds after “ALL ERASE ?” starts flashing, the recorder will revert to the stop status.
- The erasing process may take up to 10 seconds. Do not interrupt this process! Data will be destroyed.

Partially Erasing a File

You can erase a selected file in part.

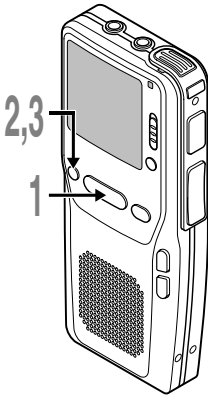

1 Start playback the file you want to erase partially.

2 Press the **ERASE button at the point to start erasing.**

While playback continues, “PARTIAL ERASE” and the file length will alternate on the display.

3 Press the **ERASE button at the point to end erasing.**

The erase starting point (time) set in step 2 and the ending point (time) set in this step will alternate on the display for 8 seconds.

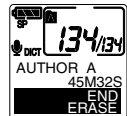
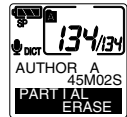
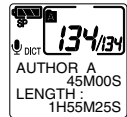

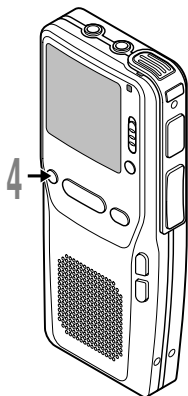

4 Press the **ERASE** button to confirm erase.

The display changes to “PARTIAL ERASE!” and erasing will start.

When “ERASE DONE” appears on the display, partial erase is complete.



Notes

- If the ERASE button is not pressed within the 8 seconds after “START” or “END” starts flashing, the recorder will revert to the stop status.
- An erased file cannot be restored.
- Locked files cannot be partially erased (*3 P.39).

Menu List

Press and hold the **FOLDER/MENU** button for 1 second or longer.

MENU

REC MODE

Select SP or LP mode (☞P.28).

MIC SENSE

Microphone sensitivity setting. Select between CONF (high-sensitivity mode) or DICT (low-sensitivity mode) (☞P.27).

EXIT

Exit MENU and return to STOP mode.

SUB MENU

Switches to the SUB MENU.

VCVA

VCVA setting (☞P.29). Select ON (enabled) or OFF (disabled).

SUB MENU

LOCK

Locking files setting (☞P.39). Select ON (locked) or OFF (unlocked).

BEEP

System sounds setting. Select ON (enabled) or OFF (disabled).

FORMAT

Recorder formatting (☞P.47).

EXIT

Returns to the MENU.

CONTRAST

LCD contrast adjustment. Select the level from 1 to 12.

USB CHARG.

USB charge setting. Select ON (enabled) or OFF (disabled).

BACKLIGHT

Backlight setting. Select ON (enabled) or OFF (disabled).

TIME&DATE

Time/Date setting. Hour, minute, year, month and day (☞P.19).

Press the **FF** button or **REW** button.

Press the **REC** button.

Notes

- If you press the STOP button or FOLDER/MENU button during a menu setup operation, the recorder will stop and apply the items that were set to that point.
- The recorder will stop if you leave it idle for 3 minutes during a menu setup operation, when a selected item is not applied.
- You can set the time and date on the recorder from your PC using DSS Player software (☞P.50).

Download from www.seamless.com. All Manuals Search And Download.

Learning to Use the Menu

To navigate through the different options in the MENU, use the MENU List flow chart (P.37) and the following steps to modify or change any settings.

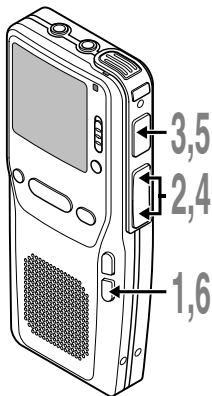

- 1 Press and hold the FOLDER/MENU button for 1 second or longer.**
The menu appears (P.37).
- 2 Press the FF or REW button to highlight a menu item you want to modify/change.**
- 3 Press the REC button to select that menu item.**
The possible options for the menu item will be in view.
- 4 Press the FF or REW button to highlight an option or setting.**
- 5 Press the REC button.**
The highlighted option will be selected and the new setting saved.
- 6 Press the FOLDER/MENU button to close the menu.**

Locking Files (LOCK)

The file lock feature is very useful to protect important data from accidental erase. Locked files are never erased except when the card is formatted (☞ P.47).

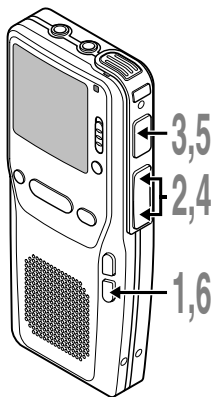

1 Select the file you want to **LOCK**, press and hold the **FOLDER/MENU** button for 1 second or longer.

The menu appears (☞ P.37).

2 Press the **FF** or **REW** button until “**LOCK**” in **SUB MENU** flashes on the display.

3 Press the **REC** button.

The file locking setup process begins.

4 Press the **FF** or **REW** button to choose between “**ON**” and “**OFF**”.

ON: Locks the file and prevents it from being edited or erased.

OFF: Unlocks the file and allows it to be edited or erased.

a Erase lock indicator

5 Press the **REC** button to select the option.

6 Press the **FOLDER/MENU** button to close the menu.

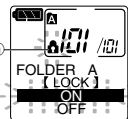
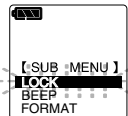

3

Locking Files (LOCK)

Notes

- You cannot append, overwrite, or insert recordings into locked files (☞ P.23).
- You cannot set index marks in locked files (☞ P.40).

Index Marks

Index marks can be placed in a file during recording or playback to provide a quick and easy to identify important sections in the file.

3

Index Marks

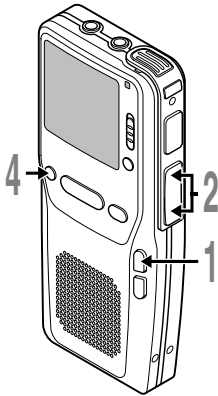

Setting an Index Mark

- 1 Press the **INDEX** button during recording or playback to set an index mark.

An index number appears on the display.



Locating an Index Mark

- 2 Hold the **FF** or **REW** button while playing a file.

The recorder stops for 1 second when it reaches the index mark.

Clearing an Index Mark

- 3 Locate the index mark you want to clear.

- 4 Press the **ERASE** button while the index number appears for approximately 2 seconds on the display.

The index mark is erased.



Notes

- Up to 16 index marks can be set in a file. Attempting to set more index marks will cause "INDEX FULL" to appear on the display.
- Index marks cannot be set or cleared in a locked file (Ⓜ P.39).



LCD Display Information

Before using the DISPLAY function, it should be programmed to CUSTOM button. The LCD screen on the recorder can display 7 different formats of information by using the DISPLAY (CUSTOM) button. This helps review and confirm different recorder settings and file information.

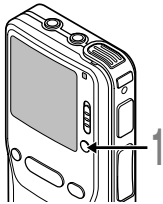

1 Use the DISPLAY (CUSTOM) button.

The LCD display will switch view every time the DISPLAY (CUSTOM) button is used.

While in Stop or Playback Mode

When using DISPLAY (CUSTOM) button, the recorder will cycle through ① to ⑦. If there is no file, only ⑤, ⑥ will display instead.

① File length

Shows how long a file is.

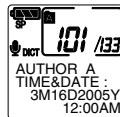
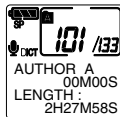

⑦ Current time and date

Shows the current time and date. (During the playback operation, the "TIME & DATE" or the counter appears.)

② Time stamp

Shows the year, month, and date that the file was recorded.

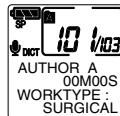
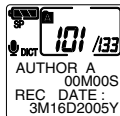

⑥ Work type ID

Shows the selected Work Type ID.

③ Time stamp

Shows the time that the file was recorded.



⑤ Memory remaining

Shows the remaining recording time.

④ File comment*

Shows a comment added to the file. (If there is no comment, "----" will appear.)

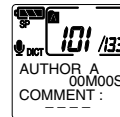

* If a comment contains many characters, it will scroll horizontally to display the complete comment.

While in Record Mode

- ① **Recording level meter**
Displays the sound input level graphically and the remaining time available for recording in countdown mode.

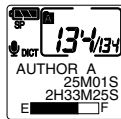

- ② **Remaining memory bars**
Displays the remaining time available for recording in bar mode and countdown mode.

3

While Recording in VCVA Mode

- ① **VCVA recording level meter**
Displays the sound input level graphically and the remaining time available for recording in countdown mode.

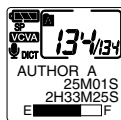
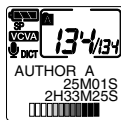

- ② **Remaining memory bars**
Displays the remaining time available for recording in bar mode and countdown mode.

("STANDBY" appears if the VCVA actuation level isn't reached.)

While in Overwrite Record Mode

- ① **Recording level meter**
Displays the sound input level graphically, the current time and the length of the file.

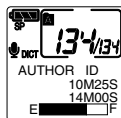

- ② **Remaining memory bars**
Displays the remaining time available for recording in bar mode, and the current time and length of the file.

While in Insert Record Mode

- ① **Recording level meter**
Displays flashing "INSERT REC", the sound input level graphically, and the current recording time.

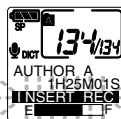

- ② **Remaining memory bars**
Displays flashing "INSERT REC", the remaining time available for recording in bar mode, and the current recording time.

Setting Priority Levels

By default, CUSTOM button is programmed with PRIORITY function.

You can set a priority level on each file recorded. You can choose between high (▲) and normal (no indication). The default is normal.

To Set a Priority Level on an Existing File

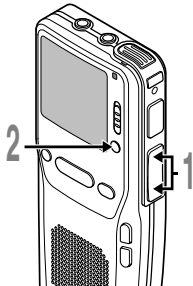

1 Select the file.

2 Press or hold the **PRIORITY (CUSTOM)** button to choose the priority level.

▲ : High level

No indication: Normal level.

Ⓐ Priority level indicator

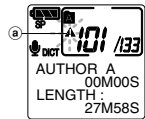
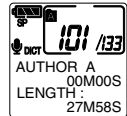

3

Setting Priority Levels

To Set a Priority on a New File

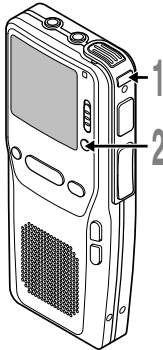

1 Press the **NEW** button.
A new file is created.

2 Press or hold the **PRIORITY (CUSTOM)** button to choose the priority level.

▲ : High level

No indication: Normal level.

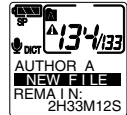

Note

Priority level cannot be changed on a locked file (P.39).

Download from www.Somanuals.com. All Manuals Search And Download.



Setting Job Data

To operate the AUTHOR ID setting (when turn on the recorder), the recorder needs to be additionally set to the dealer option item beforehand.

Every file recorded on the recorder will include the Author ID and Work Type as part of its header information. To create multiple Author IDs and Work Types on the recorder, use the bundled DSS Player software to create and upload a Job Data list (list of Author IDs and Work Types) to the recorder.

By default the Author ID is set to "DS3300".

3

Setting Job Data

Setting an Author ID

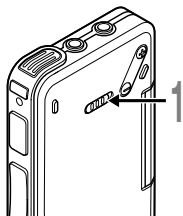

- 1 Turn ON the recorder.**
When more than one Author ID exist on the recorder, the ID list will be displayed.

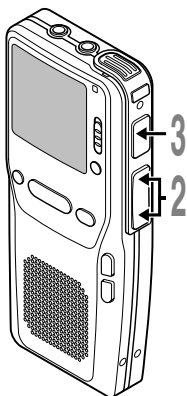
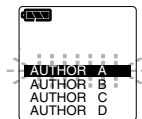

- 2 Press the FF or REW button to select the Author ID that you want to assign to the recorder from the ID list.**

- 3 Press the REC button to set the ID.**
All recordings made by the author during the session will include the set ID as part of the header information.

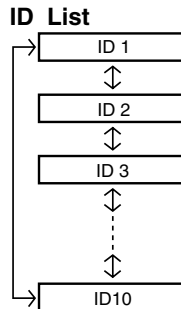

Setting a Work Type

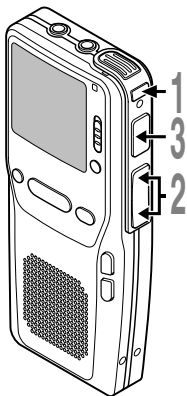

1 Press the **NEW** button while in **STOP** mode.

When more than one Work Type ID exist on the recorder, the Work Type ID list will display.

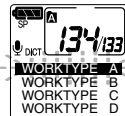

2 Press the **FF** or **REW** button to highlight a Work Type from the Work Type ID list.

3 Press the **REC** button to select the Work Type.

All recordings made with the new Work Type ID will have the new Work Type as part of the header information.

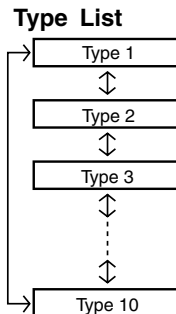



Setting Option Item

The recorder can be programmed with additional user defined fields called Option Items.

3

Setting Option Item

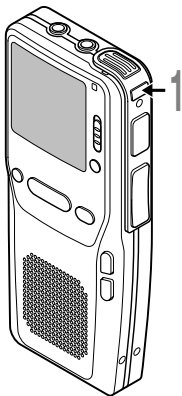

1 Press the **NEW** button while in **STOP** mode.

When programmed into the recorder, the Option Item ID displays.

2 Use the alphanumeric characters set displayed to set the Option Item ID.

Characters that can be entered are from 0 to 9, from A to Z, and _.

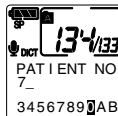

Entering method

Press the FF/REW button:

Navigate through the character set.

Press the REC button:

Enter the highlighted character and go on to the next character.

Press and hold the REC button:

Finish entering ID.

Press the ERASE button:

Erase the characters being entered.

If multiple Option Items are programmed into the recorder, each Option Item ID is entered in the same way described above. When entering the final ID is done, the recorder switches to NEW mode.

Notes

- Each Option Item ID field can accept up to 20 characters maximum.
- If more than one Work Type ID exist on the recorder, the Option Item ID displays after determining the Work Type.

Formatting the Card (FORMAT)

Cards that have been used on non-Olympus devices, or cards that are not recognized by the recorder, must be formatted before they can be used with the recorder. The Olympus xD-Picture Card delivered with the recorder is preformatted and ready for use. To familiarize yourself with the formatting process, read the steps below.

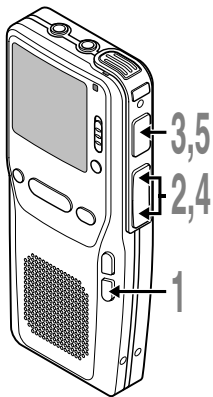

1 Press and hold the **FOLDER/MENU** button for 1 second or longer.

The menu appears (☞ P.37).

2 Press the **FF** or **REW** button until “**FORMAT**” in **SUB MENU** flashes on the display.

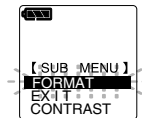

3 Press the **REC** button to select “**FORMAT**”.

The formatting process is selected.

4 Press the **FF** or **REW** button to highlight the “**START**” option.

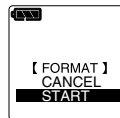

5 Press the **REC** button to confirm “**START**” selection.

“**DATA WILL BE CLEARED**” appears for approximately 2 seconds.

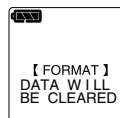

3

Formatting the Card (FORMAT)

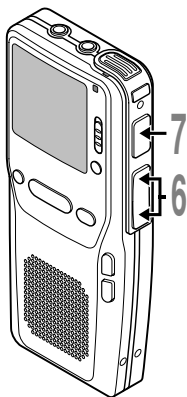

6 Press the **FF** or **REW** button again to highlight the “**START**” option.

7 Press the **REC** button again to initiate the formatting process.
Formatting begins and “**FORMAT!**” flashes on the display.

“**FORMAT DONE**” displays when formatting ends.

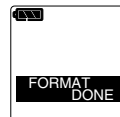
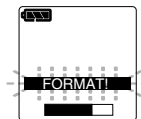
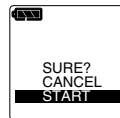

Notes

- The time required to format cards differs depending on the capacity of cards. For example, formatting may take about 1 minute for 512 MB card. Do not interrupt the formatting process by opening the card cover or the battery cover. Doing so will damage the data or card.
- When the card is formatted, all the stored data, including locked files, are erased.
- If an unformatted card is inserted, the recorder automatically displays the format option in the menu.

Hold

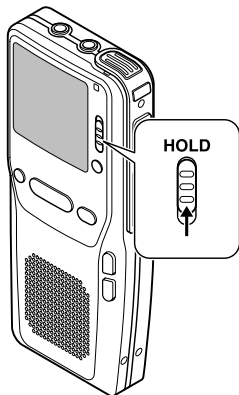

Setting the **HOLD** switch to the **HOLD** position.

If you set the recorder to HOLD status by sliding the HOLD switch in the direction of the arrow, the current conditions will be preserved, and all buttons and switches except the HOLD switch will be disabled. This feature is useful when the recorder has to be carried in a bag or pocket.

Remember to reset the HOLD switch when using the recorder.

3

HOLD

Notes

- The display will flash if the switch is moved to hold in the stop status. At this time, if any button is pressed the clock display will flash for about 2 seconds, but will not operate.
- If the switch is moved to hold during playback (or recording), the playback (recording) status will stay and cannot be operated.

(When playback has ended and the recording has ended due the remaining memory being used up, it will be in the stop state.)

DSS Player Software

The DSS Player is a fully featured software tool that provides a simple to use but sophisticated method of managing your recordings. Some of the features of the DSS Player are:

- Automatic download and backup of recordings from the recorder to a PC.
- Automatic distribution of recordings by e-mail or FTP to transcriptionists or other users.
- Automatic retrieval of typed documents, via e-mail or FTP, linking the document to the recording.
- Allows you to manage and change settings on your recorder.
- Allows you to play and edit recordings on your PC.
- When used with the recorder connected to a PC, direct recording on the PC is possible.

4

Precautions on using the recorder connected to a PC

- When you are downloading a file from the recorder or uploading a file to the recorder, do not remove the USB cable even if the screen is indicating you can. Data is still being transferred while the record/play indicator lamp is blinking. When removing the USB cable, be sure to follow the description in **☞ P.56**. If the USB cable is removed before the drive is stopped, data may not be successfully transferred.
- On a PC, do not format the drive of the recorder. Initialization is not successfully achieved on a PC. For initialization, follow the instructions in the menu screen of the recorder (**☞ P.37**).
- Folder (directory) names displayed by file management tools such as Explorer attached to Microsoft Windows and Finder attached to Mac OS are different from the folder names settable with the recorder or DSS player.
- If folders or files stored on the recorder are moved or renamed by using a file management tool such as Explorer or Finder, the order of files may be changed or files may become unrecognizable.
- Data can be written or uploaded to the recorder even though the attribute of the recorder drive is shown as Read-only by the operating system of the PC.
- As the noise may cause adverse effects on electronic devices nearby the recorder, unplug the earphone when you connect the recorder to a PC.

Operating Environment

Make sure that your computer meets the operating environment listed below. Please check with your system administrator or your Olympus Professional Dealer.

Windows

PC:	IBM PC/AT compatible PC
Operating System:	Microsoft Windows 98/ 98SE/ Me/ 2000 Professional/ XP Professional, Home Edition
CPU:	Intel Pentium II class 333 MHz processor or faster (Processor 500 MHz or faster is recommended)
RAM:	128 MB or more (256 MB or more is recommended)
Hard drive space:	50 MB or more
Drive:	2x or faster CD-ROM, CD-R, CD-RW, DVD-ROM drive
Sound card:	Creative Labs Sound Blaster 16 or 100% compatible sound card
Browser:	Microsoft Internet Explorer 4.01 SP2 or later
Display:	800 x 600 pixels or more, 256 colors or more
USB port:	One or more free ports
Audio I/O terminals:	Microphone input and earphone output or speaker

Macintosh

PC:	Power Mac G3 233 MHz class processor or faster
	iMac/ iBook/ eMac/ Power Mac/ PowerBook (The computer must support a standard USB port.)
Operating System:	Mac OS 9.0-9.2.2/ 10.1-10.3
RAM:	OS X 128 MB or more (256 MB or more is recommended)
	OS 9.x 64 MB or more (128 MB or more is recommended)
Hard drive space:	50 MB or more
Drive:	2x or faster CD-ROM, CD-R, CD-RW, DVD-ROM drive
Display:	800 x 600 pixels or more, 256 colors or more
USB port:	One or more free ports
Audio I/O terminals:	Earphone output or speakers

Notes

- Do not use the recorder as a USB Microphone/Speaker on Windows 98 as computer operation may become unstable. (Use only with Windows 98SE or later versions of the OS.)
- To use the voice recognition function with the recorder, use Windows 98SE or later versions of the OS (☞ P.68-69).
- Macintosh version does not support voice recognition software.

Download from www.Somanuals.com. All Manuals Search And Download.

Installing DSS Player Software

Before you connect your recorder to your PC, you must first install the DSS Player software. Make sure to exit all running applications, eject the floppy disk if you are using one, and logon as administrator if you are running Windows 2000/XP (Professional only) or Mac OS X on the network.

Windows

1 Insert Olympus DSS Player CD into the CD-ROM drive.

The installation program will start automatically.

If the installation program does not start automatically, browse your CD-ROM drive and execute "setup.exe".

2 The installation Language Selection dialog box appears.

Select the desired language.

3 Register user information.

Enter your name, company name, and license ID number (serial number).

The license ID number is printed on the license ID card included inside the recorder package.

Click the [Next] button. When a confirmation dialog box appears, click the [Yes] button.

4 Proceed with the installation according to the instructions on the screen.

Macintosh

1 Insert Olympus DSS Player CD into the CD-ROM drive.

2 Double-click the CD icon.

Select the folders named "Mac OS 9.x" and "Mac OS X" and start up your OS.

3 Double-click the following icon.

Select the folder of which the language is to be installed, and execute the installation program in the folder.

4 Proceed with the installation according to the instructions on the screen.

Note

Never install DSS Player in Mac OS 9.x system, when using DSS Player with Mac OS X. The device connected when using the classic environment may not be recognized.

Uninstalling DSS Player Software

Windows

- 1 **Exit DSS Player program.**
- 2 **Click the [start] button on the taskbar.**
- 3 **Select [Add/Remove programs] from the [Control Panel].**
A list of installed applications is displayed.
- 4 **Select [Olympus DSS Player Pro], then click the [Change/Remove] button.**
- 5 **Proceed with the uninstallation according to the instructions on the screen.**

Macintosh

- 1 **Exit DSS Player.**
- 2 **Delete the Preferences file.**
Delete the [DSS Preference] file in the following location.
(OS X)
Macintosh HD : User : Library : Preferences
(OS 9.x)
Macintosh HD : System Folder : Preferences
- 3 **Delete the Executable file.**
Delete the [DSS Player for Mac] (OS 9.x) / [DSS Player] (OS X) file in the location where you installed the file.
For OS X users, uninstalling has been completed. For OS 9.x users, proceed to step 4.
- 4 **Delete the Driver file.**
Delete the following files in the following location.
System folder : Function Enhancement
[DSS 10USB Driver]
[DSS 10USB Shim]
[DSS 1USB Driver]
[DSS 1USB Shim]
[DSS FSUSB Driver]
[DSS FSUSB Shim]
[DSS USB Driver]
[DSS USB Shim]
- 5 **Delete the Help file.**
Delete the [DSS Player for Mac Help] (OS9.x)/ [DSS Player Help] (OS X) file in the following location.
System folder : Help

4

Note

Uninstallation does not erase the stored dictation files.
Download from www.Somanuals.com. All Manuals Search And Download.

Using Online Help

For information on the DSS Player usage and features, refer to the online Help.

To start online Help:

Windows

- Click the [start] button, then select [All Programs], [Olympus DSS Player], [Dictation Help].
- While DSS Player is running, select the [Help] menu, [Contents].
- While DSS Player is running, press F1 on the keyboard.



4

Using Online Help

Macintosh

- While DSS Player is running, select [DSS Player for Mac Help] (OS 9.x)/ [DSS Player Help] (OS X) from the [Help] menu.



Note

Online Help is available after the DSS Player is installed.

Connection to Your PC

Be sure to install the DSS Player software before connecting the recorder to a PC. However, if you do connect the recorder before or during the software installation, the “Add New Hardware Wizard” appears. In this case, cancel the wizard by pressing the [Cancel] button in the wizard screen and then install or continue the installation of DSS Player software. You can directly connect the recorder’s USB terminal to your PC, or use the cradle included in the package (desktop holder).

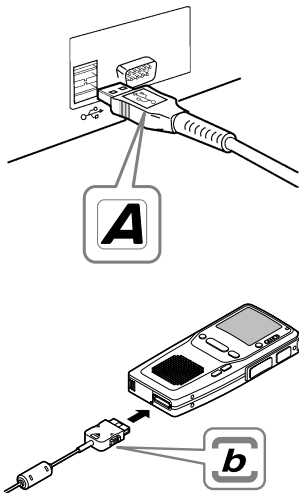

Connecting to Your PC Using the USB Cable

- 1 Turn ON the recorder (see P.17).
- 2 Insert end A of the USB cable to your PC’s USB port or USB hub.
- 3 Make sure the recorder has stopped before attaching end b of the USB cable to the terminal port of the recorder.

If “REMOTE” is displayed on the recorder, it indicates proper connections.

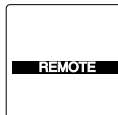

Once you connect the recorder to your PC, the recorder will be powered through the USB cable. The batteries and/or AC adapter will not be in use.

Notes

- NEVER remove the card or disconnect the USB cable while the record/play indicator lamp is flashing. If you do, the data on the card will get destroyed.
- Some PCs and USB hubs may not supply sufficient power and the recorder fails to connect. Refer to your PC User’s Manual regarding the USB port or USB hub on your PC.
- When using a USB hub to connect the recorder, always use a self-powered (AC adapter) USB hub.
- Make sure to push the cable connector all the way in. Otherwise, the recorder may not operate properly.

Disconnecting from Your PC

Windows

1 Click the  on the task bar located at the lower-right corner of the screen. Click [Safely Remove Hardware].

It will read [Stop USB Disk-Drive] for Windows Me. The drive letter will differ depending on the PC being used.

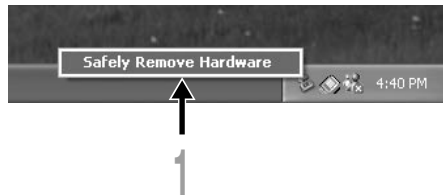

2 Disconnect the USB cable.

Macintosh

1 Move the icon of the recorder's drive displayed on desktop to trash box by drag and drop.

2 Disconnect the USB cable.

Remove the Recorder from the Cradle

To prevent damage or loss of the data, confirm that the recording/playback indicator lamp of this recorder is not on, and remove this recorder and USB connection cable from the cradle.

Notes

- NEVER remove the card or disconnect the USB cable while the record/play indicator lamp is flashing. If you do, the data on the card will get destroyed.
 - Some PCs and USB hubs may not supply sufficient power and the recorder fails to connect. Refer to your PC User's Manual regarding the USB port or USB hub on your PC.
 - When using a USB hub to connect the recorder, always use a self-powered (AC adapter) USB hub.
- 56** • Make sure to push the cable connector all the way in. Otherwise, the recorder may not operate properly.

Connecting to Your PC Using the Cradle

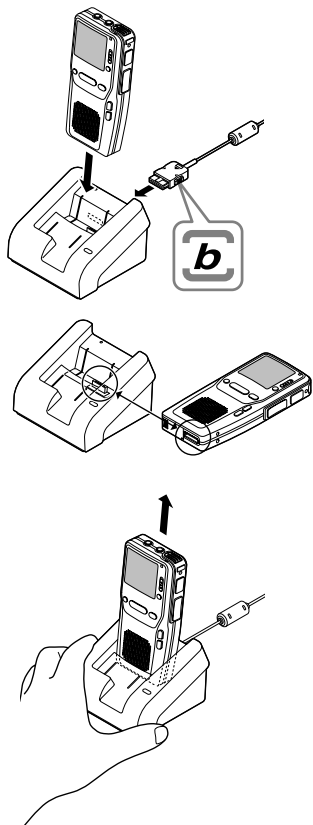

1 Insert end A of the USB cable to your PC's USB port or USB hub.

2 Connect end b of the USB cable to the cradle.

3 Turn ON the recorder, then set the recorder in the cradle.

If "REMOTE" is displayed on recorder, it indicates proper connection.

Notes

- Never touch the contact points at the bottom of the cradle, as that may cause bad connection.
- With a PC connected, the recorder cannot be operated with the foot switch (RS25/26). When connecting the recorder to a PC via the cradle, remove the foot switch.

Running DSS Player

Windows

By default, connecting the recorder to your PC, will start the application automatically.

Disabling automatic start

- 1 Right-click the Device Detector icon  in the System Tray in the lower right-hand corner of the screen, then select “Settings startup application”.
- 2 Click [DSS Player Pro].
The check mark on [DSS Player Pro] disappears.

4

Running DSS player

Manual start

- 1 Start Windows.
- 2 Click the [start] button, then select [All Programs].
All program menu will be displayed.
- 3 Select [Olympus DSS Player Pro], then click [Dictation Module].

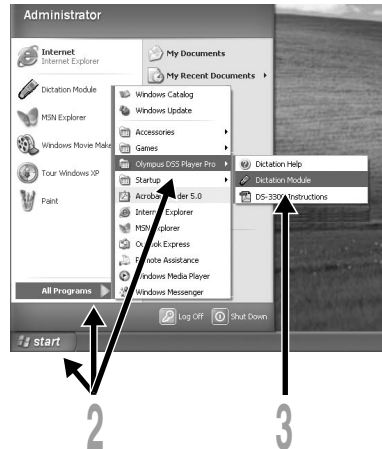

Note

If you connect the recorder before installing DSS Player, the “Add New Hardware Wizard” dialog box will open. If this happens, click [Cancel] to exit the wizard, then install the DSS Player software.

Macintosh

1 Start your Macintosh.

2 Connect the recorder to your PC.

For cable connection instructions, see “Connecting to Your PC Using the USB Cable” (P.55).

3 Double-click the [DSS Player for Mac] (OS 9.x)/[DSS Player] (OS X) folder.

The DSS Player (for Mac) folder opens.

4 Double-click DSS Player.

DSS Player for Mac (OS 9.x)/DSS Player Plus (OS X) launches.

For the OS X users: “The user’s registration screen” is displayed when first launched.

5 Register user information (OS X).

The user’s registration screen will be displayed at the time of initial startup.

Please input the serial number.

Please see the seal attached to the CD-ROM package included with the DSS Player, for the serial number.

After the input has ended, click [OK] to complete the registration.

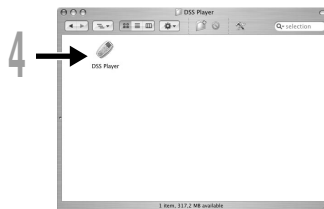
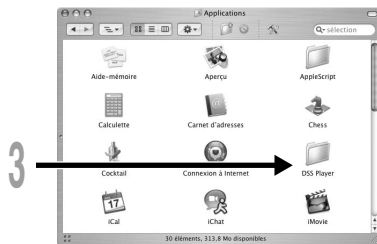

4

Running DSS Player

Note

The Mac version DSS Player does not have the automatic start function.

Window Names

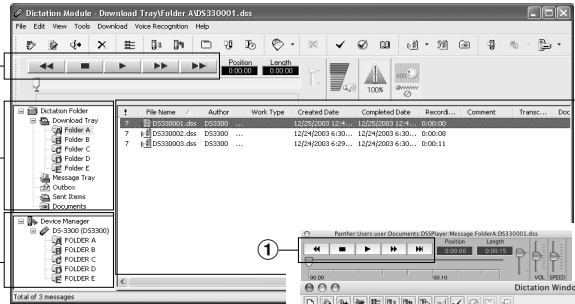

* Main screen is displayed when DSS Player is started

Windows

Macintosh

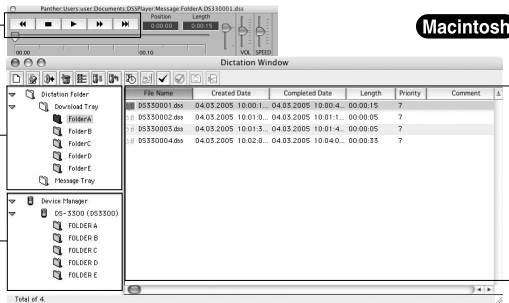

- ① **Playback Control Bar**
Provides the control buttons to play and stop dictation files.
- ② **Dictation Tree View**
Displays the directory structure of the DSS, WAVE (Windows only) and AIFF (Macintosh only)-format files stored on your PC's hard disk.
- ③ **Device Tree View**
Displays the directory structure of the folders in the recorder.
- ④ **Dictation List View**
Displays the dictation files in the folder selected in ② and ③.

Download Dictation Files from the Recorder

There are 3 download options to transfer dictation files from the recorder to the PC:

- Download Selected Files
Download one or several dictation files to your PC.
- Download Folder X (X is any of the seven folders A to G)
Download all the dictation files in one folder.
- Download All
Download all the dictation files stored on the recorder to your PC.

The following is an explanation of “Download Selected Files”. For explanations of “Download Folders” and “Download All”, refer to Online Help.

1 Select the folder.

From the Device Tree View, select the folder that contains the dictation file you would like to download. The illustration shows that Folder A is selected.

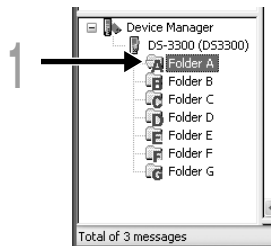

2 Select the dictation file.

Select the dictation file you would like to download from the Dictation List View. To select more than one file, hold either the [Ctrl] or [Shift] key and select desired files. The illustration shows that one dictation file is selected.

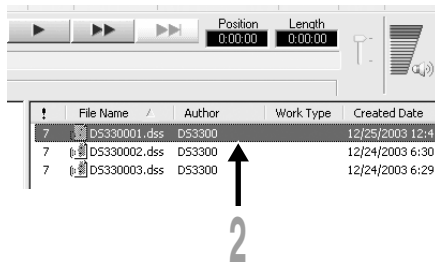

- 3** Download the dictation file.
From the [Download] menu, click [Download Selected Files].

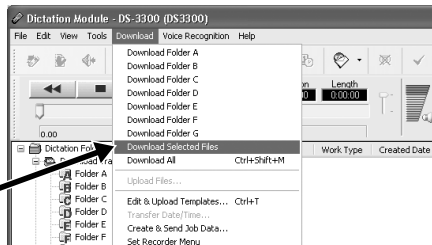

- 5** **4** Download complete.

Do not disconnect the USB cable while the record/play indicator lamp on the recorder is flashing. Disconnecting the USB cable when the recorder indicator lamp is flashing will result in data loss or corruption.

You can change the download destination folder by changing the folder properties in the Download Tray. Right-click the folder and make the necessary changes under [Properties]. To change the download options and filename format, check the [Tools] menu, [Options].

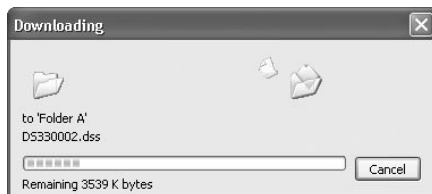

Notes

- NEVER remove the card or disconnect the USB cable while the record/play indicator lamp is flashing. If you do, the data on the card will get destroyed.
- Depending on the size of the dictation file and your PC, it may take some time to download the files.
- The downloaded files will be stored in the download tray folder that corresponds to the folder in the recorder. (Example: A dictation file downloaded from Folder A will be stored in download tray A on your PC.)
- If a dictation file already exists on your PC with the same name, date and time recorded, the new file will not be downloaded.

Download from www.Somanuals.com. All Manuals Search And Download.

Playing a Dictation File

- 1 Select the folder.**
Select the folder where the dictation file resides.
- 2 Select the dictation file.**
Select the dictation file to play from the Dictation List View.
- 3 Play the dictation file.**
Click the  (play) button in the Playback Control Bar or double-click the file.

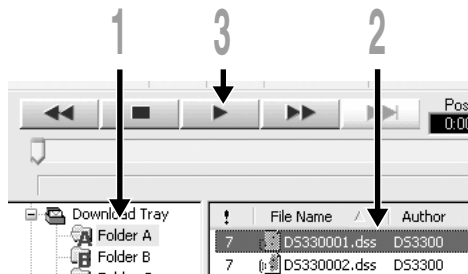

Other playback control bar such as Rewind, Fast Forward, Stop, Speed Control, Volume Control, Time Axis and Index Skip are also available on the Playback Control Bar.

The DSS Player can playback voice through the recorder speaker. The recorder must be connected to the PC, and the USB Audio feature must be enabled on the recorder. See “USB Microphone/USB Speaker” (☞ P.76).

File Name Format

File names are assigned in the following manner.

DS33 0001.dss

Extension

File number A serial number automatically assigned by the recorder.

Author ID...The ID that has been set on the recorder. The default ID is “DS3300”. The Author ID can be modified with DSS Player (☞ P.66).

Upload Dictation Files to the Recorder

DSS Player enables you to upload DSS dictation files from your PC to the recorder.

1 Select the folder.

Select the folder where the dictation file to upload resides.

2 Select the dictation file.

Select the dictation file to upload from the Dictation List View, then select [Download] menu, then [Upload Files] or click the  icon in the toolbar.

3 Select the destination upload folder on the recorder.

When the folder list box appears, select the folder then click the [OK] button.

4 Upload complete.

Once the transmission screen closes and the record/play indicator lamp on the recorder is NOT, upload is completed.

As a shortcut, you can drag and drop files from the Dictation List View to the recorder's folders displayed in the Device Tree View.

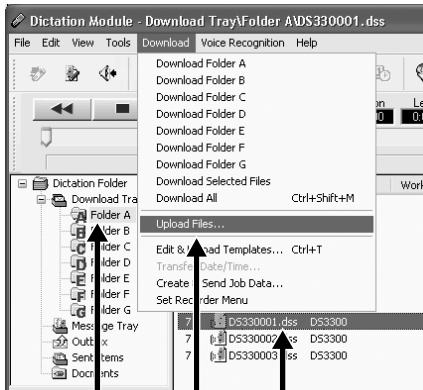

5

Upload Dictation Files to the Recorder

Note

NEVER remove the card or disconnect the USB cable while the record/play indicator lamp is flashing. If you do, the data on the card will get destroyed.

Direct Recording/Editing on PC

You can easily record on the PC directly using the recorder and the DSS Player. While the recorder is connected to the PC with the USB cable, the Remote Dictation window in the DSS Player allows you to create a new recording or edit an existing recording. The recorder will act as a sophisticated microphone with the buttons controlling the recording or editing process. See the Online Help for details.

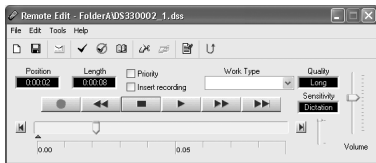

Windows

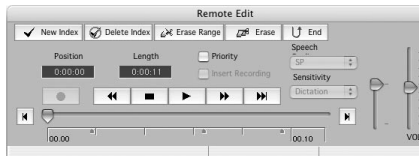

Macintosh



Recording a new file

- 1 From the DSS Player main window, click the [File] menu, then select [New File], or click the  icon. [Remote Dictation] window appears.
- 2 Press the  (record) button in the [Remote Dictation] window or press the REC button on the recorder to start recording.
- 3 Press the  (stop) button or press the STOP button on the recorder to stop recording.

Editing existing files

- 1 From the DSS Player main window, select the file you want to edit from the Dictation List View.
- 2 Click the [File] menu, then select [Edit File], or click the  icon. [Remote Dictation] window appears.
- 3 Edit the recording using the recorder buttons.
You can use the mouse connected to your PC and the Record and Playback controls to edit recordings.

Notes

- If you open the [Remote Dictation] window while the recorder is connected, the function of the recorder is changed to Audio device from Storage device automatically. The recorder as AUDIO device is not displayed as a removable drive on your PC. Closing the [Remote Dictation] window and returning to the main screen will switch the recorder back to storage class device displayed as a removable drive.
- You cannot edit WAV files.
- For DSS Player for Mac, the editing functions are partially limited.
- The maximum recording time per file is 99 hours.

Download from www.Somanuals.com. All Manuals Search And Download.

Changing User ID (Author ID)

User ID can be uploaded to the recorder using the DSS Player. Up to 10 IDs can be uploaded to the recorder.

1 From the main window, click the [Download] menu, then select [Create & Send Job Data]. The [Create & Send Job Data] window appears.

Enter your user ID in the field indicated by the arrow.

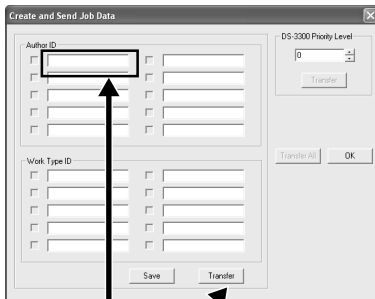

Windows

2 Click the [Transfer] button. The new user ID will be transferred to the recorder.

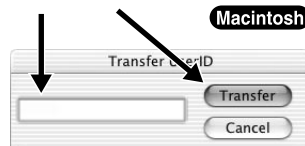

Macintosh

Note

NEVER remove the card or disconnect the USB cable while the record/play indicator lamp is flashing. If you do, the data on the card will get destroyed.

5

Changing User ID (Author ID)

Changing a Folder Name

The folders in the software and recorder can be renamed to reflect the type of recording they will contain. For example, Folder A might be used to store private information and thus be renamed PRIVATE, while Folder B might be dedicated to holding business information and thus be renamed BUSINESS.

Changing a folder name in the software

You can change a folder name in the Dictation List View using the [Rename Folder] command from the [File] menu. A folder name can be up to 20 characters long and cannot use \ / : * ? " < > |.

Changing a folder name in the recorder

Right-click the folder in the Device Tree View to be renamed, select the [Rename Folder] and input the new folder name.

The name of the folder on the recorder will be updated with the new folder name automatically. Device Window folder names consist of a string of 8 or fewer alphanumeric characters.

5

Editing File Comments

You can use your DSS Player to create/edit comments, then transfer them from the PC to the recorder. You can also edit file comments imported from the recorder to a PC.

Click the [Tools] menu, then select [Edit Comment].

File comments can use up to 100 alphanumeric characters and symbols.

Note

NEVER remove the card or disconnect the USB cable while the record/play indicator lamp is flashing. If you do, the data on the card will get destroyed.

Using Voice Recognition Software (Optional)

Audio set up

When using voice recognition software such as IBM ViaVoice with the DSS Player, it is recommended that you train your voice recognition software first to learn the characteristics of the speaker's voice and the recorder's built-in microphone for maximum accuracy.

1 Connect the recorder to your PC, and start the DSS Player.

2 Change the recorder to AUDIO device.

Follow the procedure in P.76 to change the recorder to AUDIO device.

5

3 Click the [start] button, select [All Programs], then select [IBM ViaVoice VoiceCenter].

4 From the [IBM ViaVoice VoiceCenter], select [ViaVoice], [Tool], then [Analyze My Voice]. The ViaVoice User Wizard window appears.

5 From the [Device] list box, select [Olympus DSS File] or [Olympus WMA File].

Select [Olympus DSS File] or [Olympus WMA File] in the [Device] list box, then click the [Next] button.

6 Click the [Next] button.

The [Audio Setup Wizard] window appears.

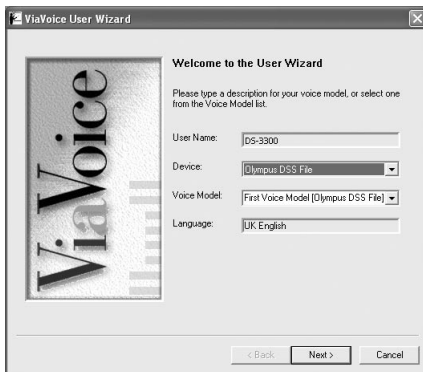

7 Select a sound card.

When the [Selecting a Sound Card] window appears, select [USB Audio Device] for [Input] and follow the instructions on screen. (Select [Microphone Control (DVR)] for Windows XP.)

8 Proceed with the AUDIO Setup according to the instruction on screen.

During audio setup, enrollment, please input voice data from the recorder.

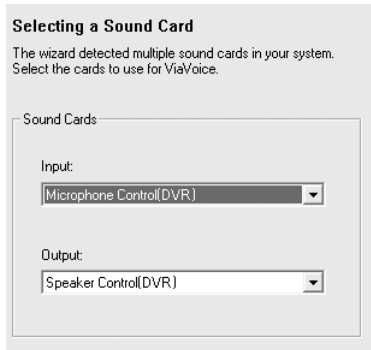

It is recommended that you enroll while in your normal surrounding environment settings. This will help improve the voice recognition by registering your voice characteristics and your environment.

Notes

- Windows 98SE or later OS is required when using voice recognition function with the recorder.
- DSS Player for Mac is not compatible with IBM ViaVoice on Macintosh.

Executing Voice Recognition

The DSS Player provides a link in the menu for IBM ViaVoice Voice Recognition software. You can easily access the menu and initiate voice recognition on any of the DSS file in the Dictation List View.

1 Select the folder.

Select the folder containing the dictation file you want to process with voice recognition from the Dictation Tree View.

2 Select the dictation file.

Select the desired dictation file to process with voice recognition from the Dictation List View.

3 Start of voice recognition.

Click the  icon. The voice recognition software window appears and voice recognition starts.

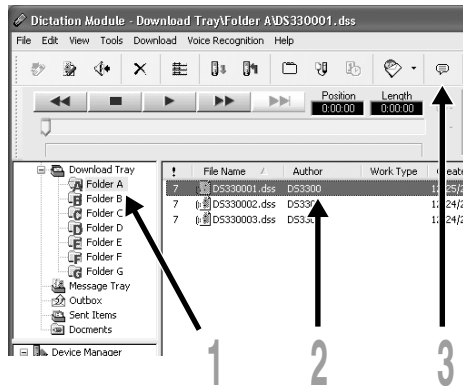

Noise Canceling Function

Check [Use Noise Cancel] in the [Voice Recognition] menu to output voice using the noise canceling function to the voice recognition software.

Check the voice recognition software operating manual for voice recognition functions such as modifying converted characters.

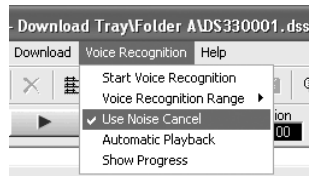

Notes on Recording For Voice Recognition

When recording voice to be processed with voice recognition, set up your DSS recorder as follows to improve recognition accuracy.

- Set the microphone sensitivity to “DICT.” (P.27).
- Set the recording mode to “SP” (P.28).
- Set the Variable Control Voice Actuator (VCVA) to “OFF” (P.29).
- Register/enroll your voice in the voice recognition software using the recorder.
- Record in a relatively quiet environment.
- Have the recorder microphone 5 to 10 cm (2 to 4 inches) away from your chin.
- Speak normally.
- It is recommended to use the noise-cancellation microphone, ME12, when recording.

Dictation files recorded under the following conditions cannot be processed by voice recognition because their recognition accuracy rates will be very low.

- A conference or meeting where many voices are recorded.
- Seminar or lecture where high-level ambient noise tends to be recorded.

Joining Files

In DSS Player, designated multiple voice files can be joined and one voice file can be created.

1 Select the folder.

From the Dictation Folder Window, select the folder which contains the files to be joined.

2 Select the voice files.

From the Voice File List Box, select more than one file to be joined.

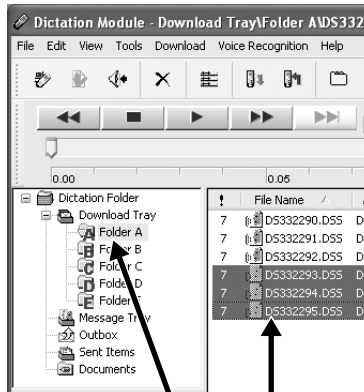

3 Select [Join] from the [Edit] menu.

The dialog to join files will be displayed, listing the files selected in step 2.

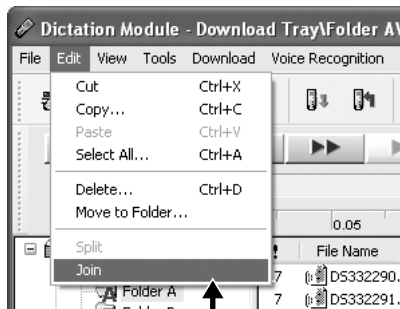

5

Joining Files

4 Set the order of files.

After joined, the playback order of the files can be changed. Select a file, and move the file to its appropriate position in the order using the [Up] and [Down] buttons.

5 Input File Names.

The file name is created automatically after joining and also, it enables input optionally.

6 Press the [Join] button.

The resulting file is saved under the name specified in step 5, and stored in the selected folder.

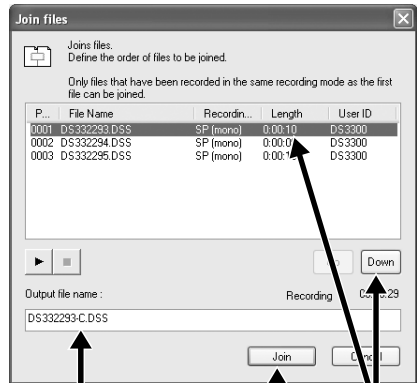

5

Joining Files

Notes

- If the files to be joined have different recording modes, the mode of the file listed at the top is selected.
- The Joining Files function is not available for the OS 9.x.

Splitting Files

One designated voice file can be split into the two files in DSS Player.

- 1 Select the folder.**
Select the folder containing the file to be split from the Dictation Folder Window.
- 2 Select the voice files.**
Select one file to split from the Voice File List Box.

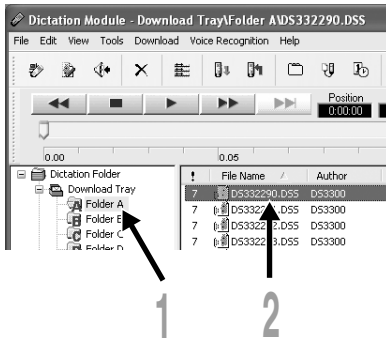

5

Splitting Files

- 3 Select [Split] from the [Edit] menu.**
The setting dialog of the file to be split will be displayed.

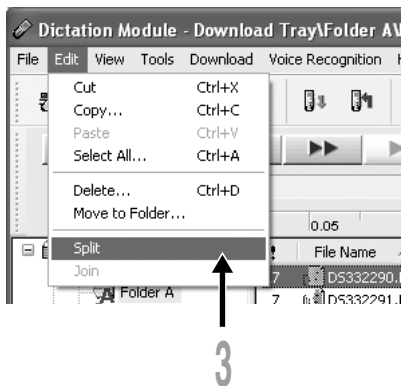

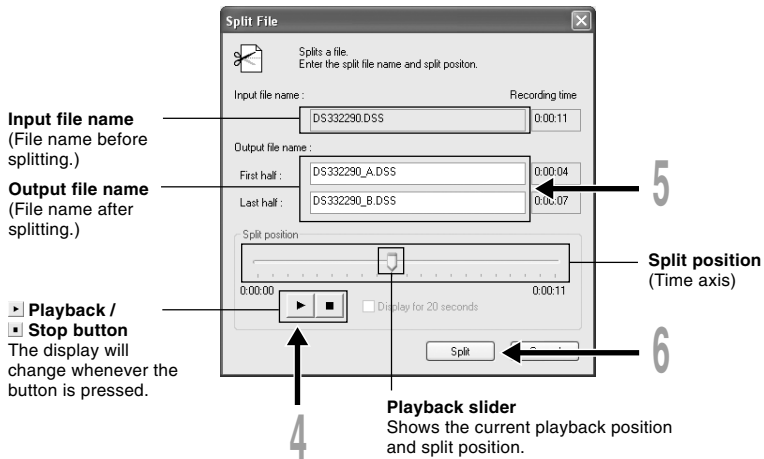

4 Set the split position.

Press the button to playback the file, and press the button in the position to be divided.

Also, the playback slider position in the time axis shows the current playback position, and also shows the split position (slide the playback slider to the right or left, which enables moving to the position to be split).

5 Input File Names.

The file name is created automatically after splitting and also, it enables input optionally.

6 Press the [Split] button.

The splitting of the file will complete, and the file name designated in procedure 5 will be saved.

Note

The Splitting Files function is not available for the OS 9.x.

USB Microphone/USB Speaker

The recorder can be used as a USB speaker or microphone when connected to a PC. If you use the recorder as a USB speaker, you can output voice through the recorder instead of using the PC speaker. When used as a microphone, you can record voice on your PC using your favorite application.

Windows

1 Click the  icon in the toolbar to change the recorder to Audio device.

Macintosh OS X

1 From the [Tools] menu, select [Change to audio device].

5

USB Microphone/USB Speaker

Notes

- USB audio function cannot be used with Windows 98 or Mac OS 9.x. The USB audio function is available only with Windows 98SE and later versions or Mac OS10.1.5 and later versions of OS.
- For Mac OS, OS10.1.5 or later versions support the USB speaker function only. Mac OS10.2.7 or later versions support the USB microphone function as well.
- If you switch the recorder to Audio device, the recorder does not function as Storage device, and it is not displayed as a removable drive.
- The recorder does not work as USB speaker when using the direct recording function with the DSS Player. When the [Remote Dictation] window opens, the PC speaker will be the output device.

Sending Dictation Files/Receiving Document Files

DSS Player software can send dictation files to a third party by e-mail or FTP.

Windows

This process can be automated by configuring the DSS Player with the recipients profile information and the sending method.

Setting the E-mail/FTP Service

E-mail/FTP service needs to be set to send/receive files.

When using E-mail and/or FTP to send dictation files attachments and/or retrieve typed documents, it is important to configure the E-mail/FTP service in the DSS Player to match the E-mail/FTP program you have configured on your PC. Please consult with you system administrator if you need help with setting your E-mail/FTP service.

1 From the DSS Player main window, click the [Tools] menu, select [Options], then click the [E-mail/FTP] tab.

2 Create a profile which specifies the destination.

A profile must be created for each account to be connected.

To create a profile, select the sending method, and click the [Setting] button.

When E-mail is used to send and/or receive files, select the type of E-mail service used on your system.

Internet E-mail

Select when using E-mail, connecting to POP3 or SMTP server via internet service provider.

Corporate or Workgroup

Select when using MAPI Compliant services such as Microsoft Exchange, Lotus Notes or Group Wise. For details on the setting procedure, see P.78.

3 Select a profile.

When the setting is complete, click the [OK] button to enable the setting.



Setting Connection for MAPI Compliant Service

- 1 Click the [start] button of Windows OS, select [Settings], then [Control Panel]. The [Control Panel] appears.
- 2 Check whether the [Mail] or [Mail and Fax] icon  is present in the Control Panel.

If the icon exists, the MAPI subsystem has already been installed on your computer. Go to the “Activating Send Mail Function (Create a Profile)” section in this manual (P.82).

If the icon does not exist, install the MAPI subsystem. The MAPI subsystem will be installed when Microsoft Exchange Client, or Microsoft Outlook is installed.

Microsoft Outlook is included in the Microsoft Office.

5 Installing MAPI Subsystem

Installing Microsoft Outlook 98

- 1 Start the Setup program for Outlook 98. When the following window appears, select [Other Mail Applications] and click the [Next] button.

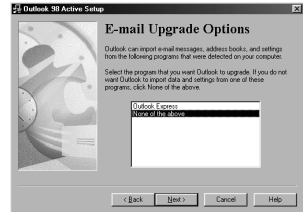

- 2 When the following window appears, select [Corporate or Workgroup] and click the [Next] button.

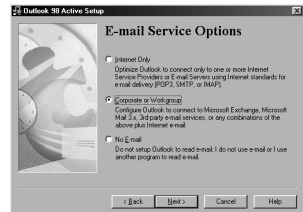

- 3 Follow the instructions on screen.

Installing Microsoft Outlook 2000

1 After installing Outlook 2000, start the program.

When the following window appears, click the [Next] button.

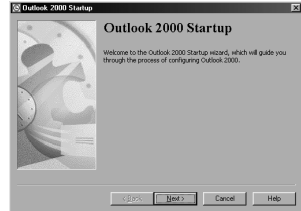

2 Select [Corporate or Workgroup] and click the [Next] button.



3 A dialog box for setting up Microsoft Outlook appears.

This is the wizard for creating a profile. For information on creating a profile, check step 3 in the “Activating Send Mail Function” (ESP P.82).

Installing Microsoft Outlook XP/2003

1 After installing Outlook XP, double-click the [Mail] icon in the [Control Panel], and then click the [Show Profiles...] button.



2 Click the [Add...] button.

3 Type the profile name and click the [OK] button.

5

Sending Dictation Files/Receiving Document Files

4 Select “Add a new e-mail account” and click the [Next] button.

5 Select your e-mail server type.
If you are going to use an MAPI compliant Workgroup system such as Lotus Notes or Novell GroupWise, select “Additional Server Types”, click the [Next] button to continue. If you are going to use an internet standard E-mail account, select “POP3” server, click the [Next] button, and skip to step 7.

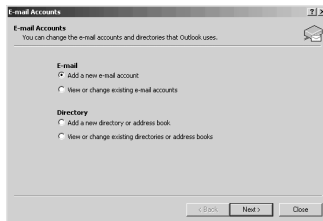
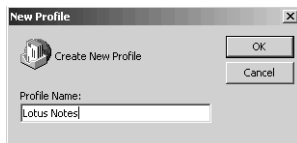
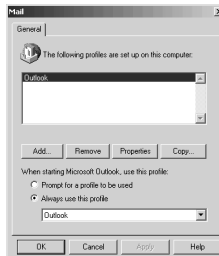

6 If you select “Additional Server Types”, you will see the following dialog box.

Click the [Next] button and follow the instructions on the screen, then skip to step 8.

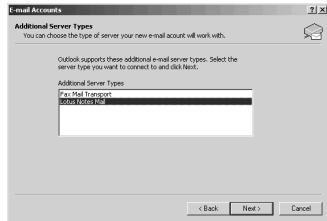

7 If you select “POP3”, you will see the following dialog box.

Enter the necessary information and click the [More Settings...] button.

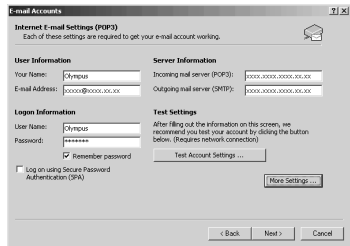

Click the [Connection] tab in the following dialog box and make sure the appropriate connection method is selected.



8 After the setup is completed, click the [Tools] menu, select [Options], then click the [E-mail/FTP] tab. Select the MAPI profile name you have created.

5

Activating Send Mail Function (Create a Profile)

The Profile is the group of information services to set up the Messaging application. The information services allow you to access the Mailbox and the Address Book. The Send Mail function will not work if there is no profile. If the profile exists and has already been used for sending E-mail, it is not necessary to create a new profile.

- 1 Start the DSS Player and click the [Tools] menu, select [Options].
- 2 In the Option Setting dialog box, click the [E-mail/FTP] tab and select the profile name you want to use.

5 Click the [Setting] button.

The Setup Wizard runs and will list the messaging applications that comply with MAPI. For example, if groupware such as Lotus Notes, Novell GroupWise, or Microsoft Exchange is installed, these applications will be listed.

- 4 Select [Use the following information services] and check one application from the list.

If you want to set up a dialup connection through an internet service provider, select [Internet E-mail] in the list. If you want to set up to use a LAN within your company, also select [Internet E-mail] in the list.

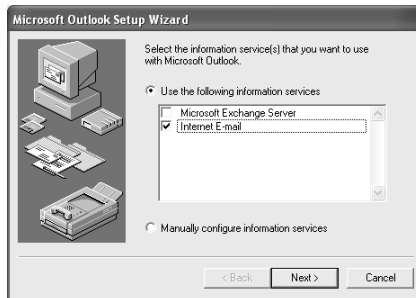

Note

The Send Mail function does not work with AOL or internet service providers that cannot open POP3 server addresses.

5 Click the [Next] button and follow the instructions on the screen.

6 When the wizard is complete, it returns to the profile in the Option Setting dialog box.

Please make sure that the profile name you have created using the Setup Wizard is displayed in the Option Setting dialog box. If a different profile name is displayed, switch to the profile you have created.

Setting the Auto-Sending Function

To send downloaded dictation files automatically, follow these steps to set the auto-sending function. This function can be individually set for the folders in the Dictation Tree View.

1 From the [Tools] menu, select [Options], then click the [Send] tab in the Option dialog box.

2 Check [Enable auto-sending function].

3 Select a folder to set the auto-sending function, and check the check box.

4 Select the sending method.

Click the [E-mail] button for selecting an E-mail address.

Click the [FTP] button for selecting an FTP profile.

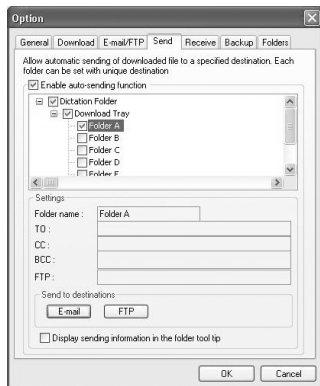

Setting the E-mail destination

- 1 Click the [E-mail] button.**
The [E-mail destination] dialog box appears.
- 2 Click the [To] button.**
The [Select recipients] dialog box appears.
- 3 Select the recipient names from the Address Book.**

At least one recipient is required in the [To:->] field. The [CC:->] and [BCC:->] selections are optional. Click the [OK] button to finish. If the recipient information is not present in the Address Book, use the [New Contact] button to add new contact information to the Address Book.

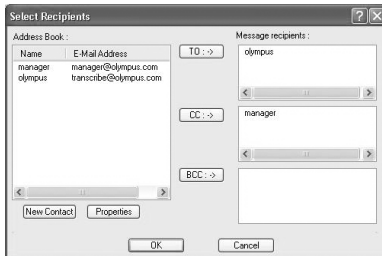
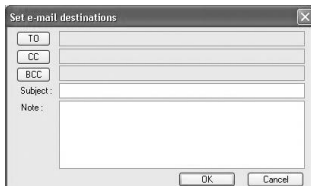

Setting the FTP destination

- 1 Click the [FTP] button.**
The [FTP destination] dialog box appears.
- 2 Click the [To] button.**
The [FTP Profiles] dialog box appears.
- 3 Select a profile from the list.**
One profile can be selected. Click the [OK] button to finish. If the correct profile does not exist, select the [E-mail/FTP] tab in the Option dialog box, and add the profile file for the FTP connection.

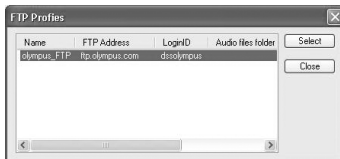
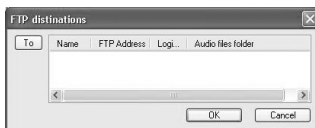

Setting the Document File Retrieve Function

1 From the [Tools] menu, select [Options], then click the [Receive] tab in the Option dialog box.

2 Check the [Use collect back documents functions] check box.

3 Select a protocol to be used for receiving a document file.

If the transmission profile setting is not configured, configure the setting in reference to P.77.

4 Register the format of a document file to receive.

When using E-mail to receive a document file, the application (software) receives the attached file if it is in the registered file format.

When using FTP to receive a document file, the application (software) receives the attached file stored in the folder of destination server if it is in the registered file format.

Any document file associated with a dictation file sent from a transcriptionist using the DSS Player Pro Transcription Module Release 4 or later is received regardless of this setting.

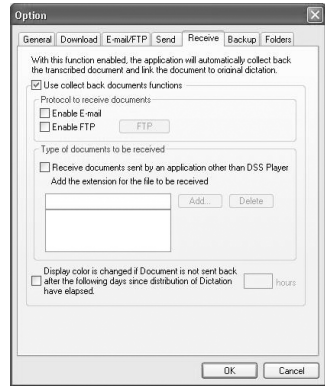

Sending Dictation Files

Windows

Sending Dictation Files Manually

- 1 Select the dictation file you want to send from the Dictation List View.**
To select more than one file, press and hold either the [Ctrl] or [Shift] key and make your selection.
- 2 Right-click the dictation file, and select [Send File].**
Select E-mail or FTP for the sending method.
- 3 Confirm the contents of the transmission template, and click the [Send] button.**

Receiving Document Files Manually

- 1 In the toolbar, click the [Send/Receive files] icon .**

According to the profile set, the application establishes a connection to the server and receives document files. The received document files are saved to the Documents folder in the Dictation Tree View.

Clicking the [Display Dictations & Documents] icon  in the toolbar displays dictation files and document files at the same time. By dragging and dropping a document file to a dictation file, the document file can be associated with the dictation file.

The document file sent as a reply from a user (transcriptionist) who uses the DSS Player Pro Transcription Module Release 4 or later will be automatically associated with the dictation file you originally sent to the user.

Sending/receiving Automatically

You can set the application to make a connection to the server at the certain interval for sending dictation files and/or receiving document files.

- 1 From the [Tools] menu, select [Options], then click the [General] tab in the Option dialog box.
- 2 Check [Auto-send/receive], and enter the time interval of automatic attempts of sending and receiving.
- 3 Set the auto-sending function and the document file retrieve function according to the instructions on P.83-85 respectively.

Macintosh

Dictation files are stored in the Message folder on the hard disk. If you want to send a dictation file by attaching it to e-mail, select the file from the Message folder.

The Message folder location can be found by selecting [Options] from the [Download] menu.

Playing Received DSS Files

When sending DSS files to a user who does not have the DSS Player software, the user will not be able to play the received DSS file. A free DSS Player from Olympus, DSS Player Lite, can be downloaded from the Olympus website at:

http://www.olympusamerica.com/cpg_section/cpg_downloads.asp

http://olympus-europa.com/consumer/2590_software.cfm

Using the Recorder as a Reader/Writer

When the recorder is connected to your PC, it will be recognized on your PC as a removable drive. You can view and access the recorder card from My Computer and download data from the card to your PC using standard windows copy/move and delete commands. You can also upload data from the PC to the card in the recorder in the same way.

- In Windows 98/ 98SE, you must have the DSS Player software installed for the recorder to be recognized.

Example: Copying Data from PC to Card Using Explorer or Finder

1 Start Windows.

2 Connecting the recorder to your PC.

For connection procedure, refer to “Connecting to Your PC Using the USB Cable” (P.55).

3 Open Windows Explorer or Finder window.

The recorder will appear as a removable drive icon.

4 Copy data to card.

While the data are being written or copied, the record/play indicator lamp on the recorder will flash.

Note

NEVER remove the card or disconnect the USB cable while the record/play indicator lamp is flashing. If you do, the data on the card will get destroyed.

Alarm Message List

Message	Meaning	Explanation	Action
BATTERY LOW	Low battery power	Battery power is getting low.	Charge the battery or replace with new batteries (☞ P.13-15).
FILE IS LOCKED	Erase-locked	Attempt to delete a locked file.	Unlock the file (☞ P.39).
INDEX FULL	Index full	The file is full of index marks (maximum of 16 marks).	Erase index marks that are no longer required (☞ P.40).
FOLDER FULL	Folder full	The folder is full of files (maximum of 199 files).	Erase unnecessary files (☞ P.33).
	Maximum number	The destination folder already has the maximum number of files (199).	Erase unnecessary files (☞ P.33).
MEMORY ERROR	Incompatible card	An incompatible card was inserted.	Insert a compatible card.
MEMORY FULL	Zero remaining memory	The card has no remaining memory.	Erase files that are no longer required or insert another card.
FORMAT ERROR	Formatting error	There was an error while formatting the card.	Reformat the card (☞ P.47).
SYSTEM ERROR	System error	System error detected in the recorder.	This is a malfunction. Contact the place of purchase or Olympus Service Center for repair.
INSERT CARD	No card	There is no card inserted.	Insert a card (☞ P.21).
CARD COVER IS OPEN	Card cover is opened	The card cover is not closed.	Close the card cover securely until it click (☞ P.21).

Troubleshooting

Symptom	Probable cause	Action
Nothing appears on the display	The batteries are not loaded properly.	Verify polarity is correct (☞ P.13-14).
	The batteries are dead.	Charge the battery or replace with new batteries (☞ P.13-15).
Won't start	The recorder is in power off mode.	Turn the recorder ON (☞ P.17).
	The recorder is in power off mode.	Turn the recorder ON (☞ P.17).
Unable to record	The batteries are dead.	Charge the battery or replace with new batteries (☞ P.13-15).
	The card does not have enough memory.	Erase unnecessary files or insert another card (☞ P.21, 33).
	The card is unformatted.	Format the card (☞ P.47).
No playback tone heard	The maximum number of files has been reached.	Check another folder.
	The earphone is connected.	Unplug the earphones to use the internal speaker.
	The VOLUME button is set to 0.	Adjust the VOLUME button.
Unable to erase	The file is locked.	Unlock the file (☞ P.39).
Noise heard during playback	The recorder was shaken during recording.	—
	The recorder was placed near a cell phone or fluorescent lamp while recording or during playback.	Move the recorder.
Recording level too low	The microphone sensitivity is too low.	Set the microphone sensitivity to CONF mode and try again (☞ P.27).
Unable to set index marks	The maximum number of index marks (16) has been reached.	Erase unnecessary index marks (☞ P.40).
	The file is locked.	Unlock the file (☞ P.39).
Cannot find the recorded voice	Wrong folder.	Switch to the right folder.
Cannot connect to PC	Some PCs and USB hubs may not provide sufficient power.	Turn the USB CHARG. "OFF" in the recorder's menu settings (☞ P.37).
Cannot connect to a PC using a cradle	Sometimes a connection cannot be made with some PCs running Windows XP.	You need to change the PC's USB settings. See DSS Player online help for details (☞ P.54).

Accessories (Optional)

PC Transcription kit: AS-4000

The AS-4000 transcription kit (sold separately) provides you with a PC-footswitch, a headset and DSS Player Pro Transcription Module for easy transcription of DSS recordings.

xD-Picture cards of 16, 32, 64, 128, 256 and 512 MB: M-XD16/32/64/128/256/512

Olympus CAMEDIA digital camera series xD-Picture Cards can be used.

Headset: E61, E102

Stereo headset for your PC. A helpful tool for PC based transcription.

Monaural binaural earphone: E20

Noise-Cancellation microphone: ME12 (Dictation microphone)

Used to get crisp recordings of your own voice by reducing the effects of ambient noise. Recommended to improve the accuracy when using voice-recognition software.

External microphone: ME15

A lavalier omnidirectional microphone that clips to clothing. Used to record your own voice or people near you.

Ni-MH Rechargeable Battery Pack: BR402

High-efficiency rechargeable long life battery.

AC adapter: A511/D-7AC

Connect to the cradle to recharge the Ni-MH battery pack.

Foot switch: RS25/26

Connect to the serial or USB port of your PC for hands-free transcription convenience.

USB Reader/Writer: MAUSB-10 (Dual-Slot xD-Picture Card & SmartMedia)

Allows data to be transferred to and from a PC.

USB Reader/Writer: MAUSB-300 (xD-Picture Card)

Allows data to be transferred to and from a PC.

PC Card adapter: MAPC-10 (xD-Picture Card/SmartMedia)

Allows data to be transferred to and from a PC that has a PC card slot.

Connecting cord: KA333

Use to connect the microphone jack of this unit to a radio or other sound source.

Specifications

Recording format

DSS (Digital Speech Standard)

Recording media

xD-Picture Card: 16 to 512 MB

Input level

-70 dBV

Sampling frequency

SP mode: 12 kHz

LP mode: 8 kHz

Overall frequency response

SP mode: 300 to 5,000 Hz

LP mode: 300 to 3,000 Hz

Recording time (32 MB Card)

SP mode: 5 hours 13 minutes

LP mode: 11 hours

Alkaline battery life

Recording: Approx. 20 hours

Playback: Approx. 12 hours

Ni-MH Rechargeable Battery life

Recording: Approx. 15 hours

Playback: Approx. 10 hours

7

Speaker

Built-in \varnothing 28 mm round dynamic speaker

MIC/EAR jack

\varnothing 3.5 mm mini-jack, impedance MIC 2 k Ω ,

EAR 8 Ω or more

Maximum working output (3 V DC)

220 mW or more (8 Ω speaker)

Input power requirement

Rated voltage: 3 V

Batteries: Ni-MH Rechargeable Battery Pack (BR402) or Two AAA batteries (LR03 or R03) or Two Ni-MH rechargeable batteries (BR401)

External dimensions

110.2 x 50.0 x 17.2 mm

(without protrusions)

Weight

101 g

(Including alkaline batteries)

* Specifications and design are subject to change without notice.

* Battery life is measured by Olympus. It varies greatly according to the type of batteries used and the conditions of use.

Technical Assistance and Support

DS-3300 is part of the Olympus Professional Dictation System. Your dealer is trained to troubleshoot and fix many common problems that you may be having with this system. If you encounter problems using your DS-3300, we recommend that you contact your Olympus Professional Dealer that sold you the system. If your dealer cannot fix your problem, please call our technical hotline number or send an E-mail.

- ◆ For customers in the U.S. and Canada
Phone: 1-888-553-4448
E-mail: distec@olympus.com
- ◆ For customers in Europe
E-mail : dss.support@olympus-europa.com

OLYMPUS®

OLYMPUS IMAGING CORP.

Shinjuku Monolith, 3-1 Nishi-Shinjuku 2-chome, Shinjuku-ku, Tokyo 163-0914, Japan. Tel. 03-3340-2111

OLYMPUS IMAGING AMERICA INC.

Two Corporate Center Drive, PO BOX 9058 Melville, NY 11747-9058, U.S.A. Tel. 1-800-622-6372

OLYMPUS IMAGING EUROPA GMBH

(Premises/Goods delivery) Wendenstrasse 14-18, 20097 Hamburg, Germany. Tel. 040-237730

(Letters) Postfach 10 49 08. 20034 Hamburg. Germany.

OLYMPUS UK LTD.

2-8 Honduras Street, London EC1Y 0TX, United Kingdom, Tel. 020-7253-2772

<http://www.olympus.com>

For customers in North and South America

Declaration of Conformity

Model Number: DS-3300
Trade Name: DIGITAL VOICE RECORDER
Responsible Party: OLYMPUS AMERICA INC.
Address: 2 Corporate Center Drive, PO BOX 9058 Melville, NY 11747-9058, U.S.A.
Telephone Number: 800-622-6372

This device Complies with Part 15 of the FCC Rules. Operation is subject to the following two conditions:
(1) This device may not cause harmful interference, and (2) this device must accept any interference received, including interference that may cause undesired operation.



Tested To Comply
With FCC Standards

FOR HOME OR OFFICE USE

Canadian RFI

This digital apparatus does not exceed the Class B limits for radio noise emissions from digital apparatus as set out in the Radio Interference Regulations of the Canadian Department of Communications.

Cet appareil numérique ne dépasse pas les limites de Catégorie B pour les émissions de bruit radio émanant d'appareils numériques, tel que prévu dans les Règlements sur l'Interférence Radio du Département Canadien des Communications.

For customers in Europe



"CE" mark indicates that this product complies with the European requirements for safety, health, environment and customer protection.



This symbol [crossed-out wheeled bin WEEE Annex IV] indicates separate collection of waste electrical and electronic equipment in the EU countries. Please use for the disposal of these types of equipment with the available return and collection systems.

Applicable Product : DS-3300, Cradle

Download from www.Somanuals.com. All Manuals Search And Download.

P2-BZ8092-01
AP0503

Free Manuals Download Website

<http://myh66.com>

<http://usermanuals.us>

<http://www.somanuals.com>

<http://www.4manuals.cc>

<http://www.manual-lib.com>

<http://www.404manual.com>

<http://www.luxmanual.com>

<http://aubethermostatmanual.com>

Golf course search by state

<http://golfingnear.com>

Email search by domain

<http://emailbydomain.com>

Auto manuals search

<http://auto.somanuals.com>

TV manuals search

<http://tv.somanuals.com>