

# OLYMPUS®

## Quick Start Guide

### SP-700

# Start Here

For more information, please refer to the Basic & Advanced Manuals or visit: [www.olympusamerica.com/support](http://www.olympusamerica.com/support)

OLYMPUS IMAGING AMERICA INC.

## BEFORE YOU BEGIN

### Gather these items (box contents)

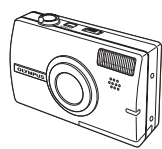

Digital Camera



Strap

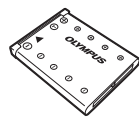

LI-40B Lithium Ion Battery



AC Adapter (S-D-1AC)



Power Cable

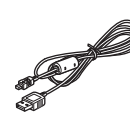

USB Cable

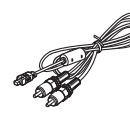

AV Cable



OLYMPUS Master Software CD-ROM

• Items not shown: Advanced Manual (CD-ROM), Basic Manual, warranty card. Contents may vary depending on purchase location.

## 1 GET STARTED

### a. Attach the strap

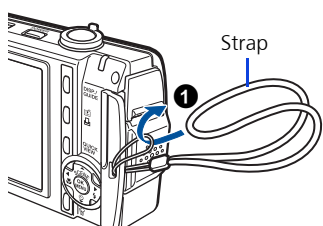

- Pull the strap tight so that it does not come loose.

### b. Insert the battery

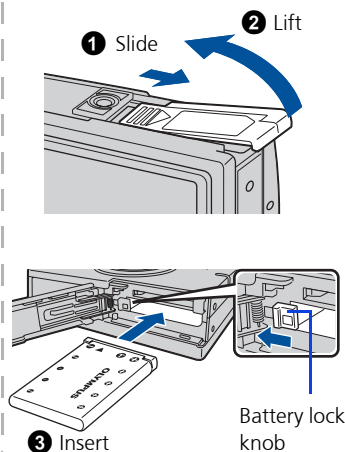

3 Insert

Battery lock knob

### c. Charge the battery (recommended\*)

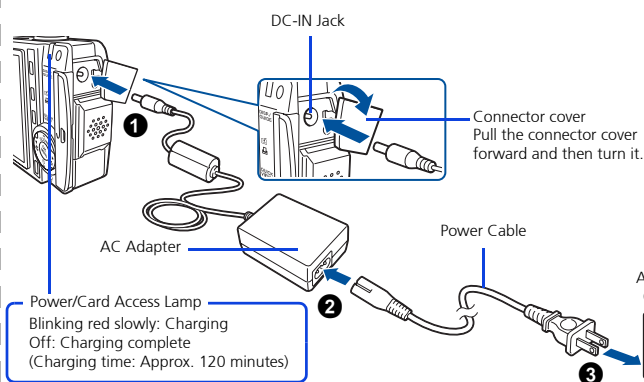

Power/Card Access Lamp  
Blinking red slowly: Charging  
Off: Charging complete  
(Charging time: Approx. 120 minutes)

\*Battery comes partially charged.

### d. Set the date and time

- 1 Set the mode switch to and press the **POWER** button to turn it on.
- 2 Press to display the top menu, and select [MODE MENU] > [SETUP] > .
- 3 Press to set an item. Press to select the next field.

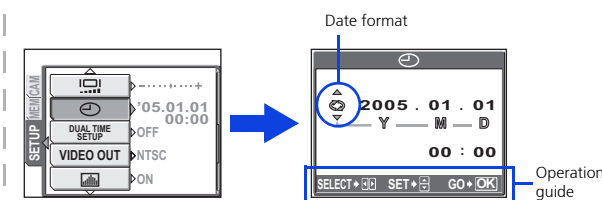
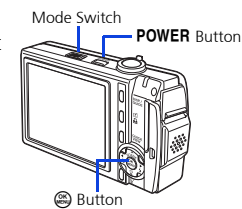

## 2 TAKE A PICTURE

### a. Zoom

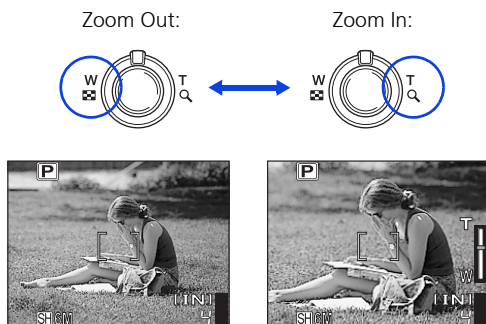

### b. Focus

- 1 Using the monitor, place the AF target mark over your subject.  
Green Lamp
- 2 Press and hold the shutter button halfway to lock the focus.  
• The green lamp indicates the focus is locked.

### c. Take the picture

- 1 Press the shutter button completely to take the picture.

## CAMERA DIAGRAM

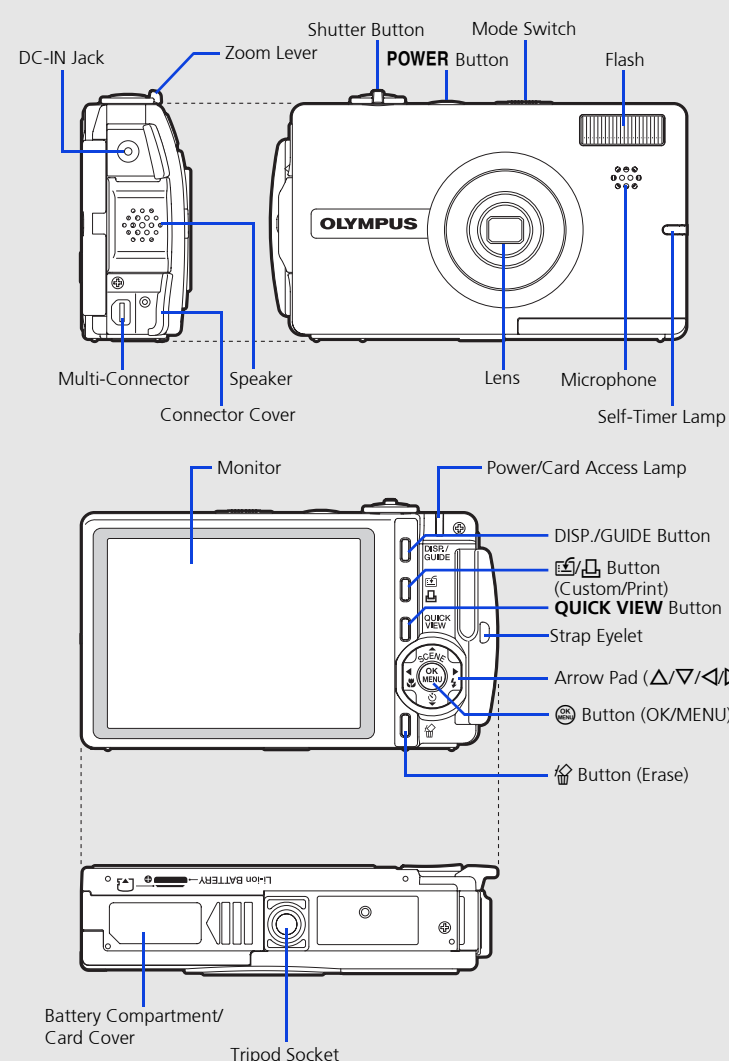

## 3 REVIEW OR ERASE A PICTURE

### a. Set the mode switch to

- The last picture taken will be displayed.

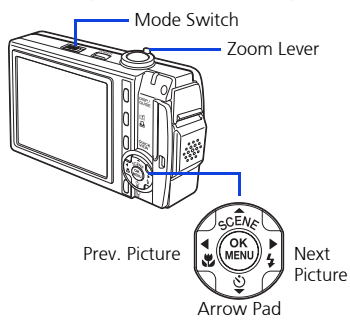

### b. Take a closer look

- Turn the zoom lever towards T to enlarge the picture 10x (closeup playback) and turn it towards W to reduce the picture.
  - Press to return to the original size.
  - Press or to scroll around.
- Set the mode switch to or to return to the shooting mode.

### c. To erase a picture

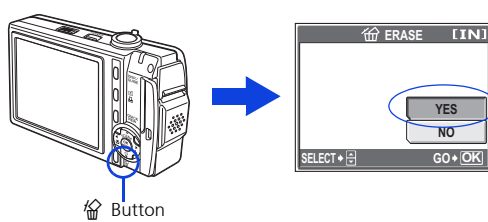

- 1 Display the picture you want to erase.
  - 2 Press the .
  - 3 Select [YES], and press .
- The picture is permanently erased.

## 4 TRANSFER IMAGES

### a. Install the software

- 1 Insert the OLYMPUS Master CD-ROM.
- 2 **Windows:** Click the "OLYMPUS Master" button.  
**Macintosh:** Double-click the "Installer" icon.
- 3 Simply follow the on-screen instructions.

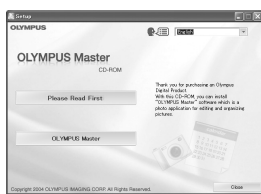

### b. Connect the camera to the computer

- 1 Connect the camera to the computer using the USB cable provided with the camera.  
• The camera monitor will turn on automatically.

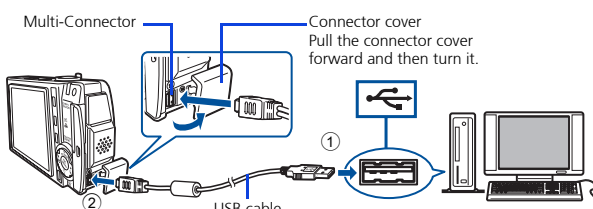

- 2 Select [PC] on the monitor, and press .

- Your PC will now recognize your camera as a removable storage drive.

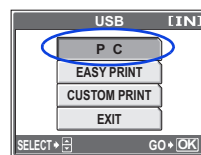

### c. Transfer images to the computer

- 1 With the camera now connected, open OLYMPUS Master.  
• The [Transfer Images] window is displayed.
- 2 Select the images you want to transfer, and click the [Transfer Images] button.

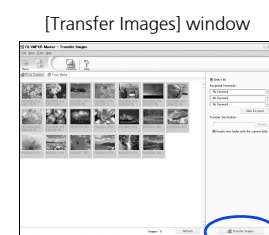

If the [Transfer Images] window is not displayed automatically:

- a. Click the "Transfer Images" icon on the OLYMPUS Master main menu.
- b. Click the "From Camera" icon.

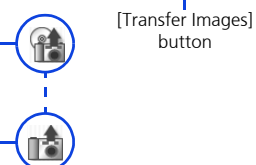

## Free Manuals Download Website

<http://myh66.com>

<http://usermanuals.us>

<http://www.somanuals.com>

<http://www.4manuals.cc>

<http://www.manual-lib.com>

<http://www.404manual.com>

<http://www.luxmanual.com>

<http://aubethermostatmanual.com>

Golf course search by state

<http://golfingnear.com>

Email search by domain

<http://emailbydomain.com>

Auto manuals search

<http://auto.somanuals.com>

TV manuals search

<http://tv.somanuals.com>