

OLYMPUS[®]

∞ Stylus

ZOOM 80 WIDE DIX



INSTRUCTIONS

Before using your camera, read this manual carefully to ensure correct use.

BASIC OPERATIONS
OPERATIONS DE BASE
OPERACIONES BASICAS

ADVANCED TECHNIQUES
TECHNIQUES AVANCEES
TECNICAS AVANZADAS

CAMERA MAINTENANCE
ENTRETIEN DE L'APPAREIL
MANTENIMIENTO DE LA
CAMARA

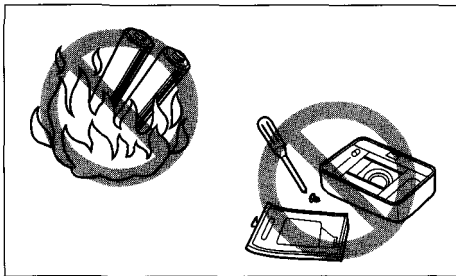

Thank you for purchasing an Olympus camera. Before you start to use your new camera, please read these instructions carefully to obtain optimum performance and a longer service life from the unit.

WARNING



Indicates circumstances under which mishandling resulting from ignoring this symbol could result in personal injury or property damage.

KEEP THE BATTERIES AWAY FROM FIRE.
NEVER TRY TO DISASSEMBLE, RECHARGE, OR
SHORT-CIRCUIT BATTERIES.

NEVER ATTEMPT TO DISASSEMBLE THE CAMERA;
IT CONTAINS A HIGH-VOLTAGE CIRCUIT.
IF THE INTERNAL PARTS OF THE CAMERA ARE
EXPOSED DUE TO DROPPING OR DAMAGE,
REMOVE THE BATTERIES IMMEDIATELY TO
PREVENT FURTHER USAGE.
IN CASE OF MALFUNCTION, CONSULT YOUR
NEAREST OLYMPUS DEALER OR OLYMPUS
SERVICE CENTER.

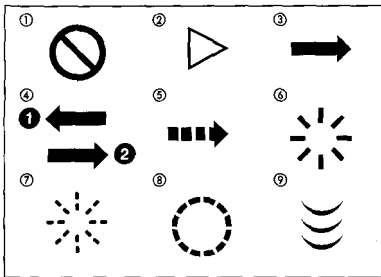

- Before using your camera, read this manual carefully to ensure correct use.
- We recommend that you take test shots to get accustomed to your camera before taking important photographs.

MAIN FEATURES

- Built-in 28 mm - 80 mm approx 3X zoom lens.
- Quartzdate or time imprinting.
- Weatherproof.
- Remote control (optional).
- Versatile, easy-to-use functions include spot metering, night scene, as well as various flash modes.

Symbols used in this manual:

- | | | |
|----------------------|-----------------------|--------------------|
| ① Incorrect | ② Next operation | ③ Manual operation |
| ④ Operation order | ⑤ Automatic operation | ⑥ Indicator on |
| ⑦ Indicator blinking | ⑧ Attention | ⑨ Depress halfway |

Pay particular attention to items in the instructions enclosed in boxes .

Product shown in the illustrations may be slightly different from the unit.

PREPARATIONS

Names and functions of parts	6
Viewfinder display/LCD panel	8
Diopter adjustment	9
Using the strap/soft case	9
Outline of operations	10
Loading the battery	13
Checking the battery	14
Points to remember	15

BASIC OPERATIONS

Loading the film	17
Taking pictures	20
Using the focus lock	25
After shooting	27
Unloading the film	28

ADVANCED TECHNIQUES

Taking panorama pictures	29
Using the flash modes	33
▣ Spot mode	41
⌚ Selftimer	43
➡ Remote control (optional)	44
Correcting the data	46
Printing the date and time	48

CAMERA MAINTENANCE

Questions and answers	49
Care and storage	50
Caring for your weatherproof camera	53
Battery handling	55
Remote control (optional) handling	57
Troubleshooting	58
Specifications	65

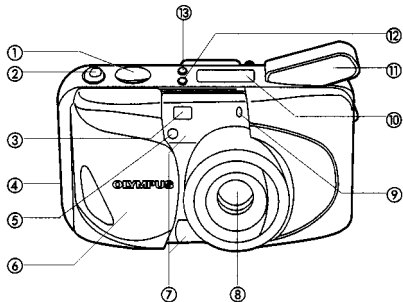

NAMES AND FUNCTIONS OF PARTS

- ① Shutter release button (p. 16)
- ② Zoom lever (p. 21)
Zooms in — telephoto.
Zooms out — wide-angle.
- ③ Viewfinder
- ④ Strap eyelet
- ⑤ Light sensor*
- ⑥ Lens barrier
- ⑦ Autotocus windows*
- ⑧ Lens*
- ⑨ Selftimer indicator
- ⑩ LCD panel (Date/time indicator) (p. 8)
- ⑪ Flash*
- ⑫ Selftimer/remote control button (p. 43/44)
- ⑬ Flash mode button (p. 33)

* Do not soil as this can cause blurred pictures.
Wipe clean with a soft cloth.

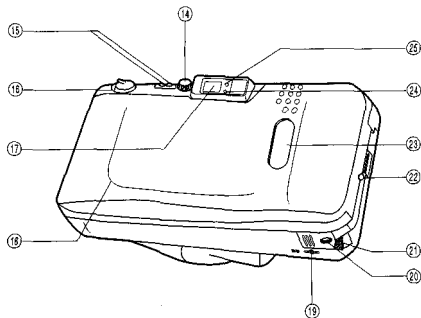

- ⑭ Diopter adjustment dial (p. 9)
- ⑮ Quartzdate mode buttons (p. 46)
- ⑯ Panorama switch (p. 29)
- ⑰ Viewfinder (p. 8)
- ⑱ Back cover
- ⑲ Mid-roll rewind button (p. 28)
- ⑳ Tripod socket
- ㉑ Battery compartment cover
- ㉒ Back cover release (p. 17)
- ㉓ Film window
- ㉔ Green lamp
- ㉕ Orange lamp

VIEWFINDER DISPLAY/LCD PANEL

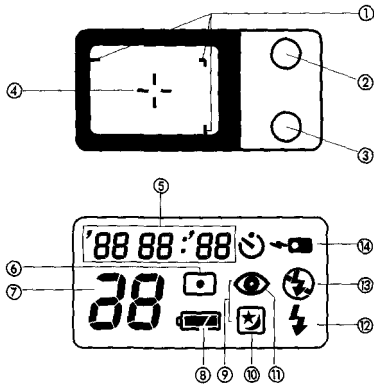

Viewfinder Display

- ① Close-up correction marks
At a close distance, your subject must be positioned within the close-up correction marks.
- ② Orange lamp
Lights when the flash is ready to fire.
Blinks while the flash is recharging.
- ③ Green lamp
Lights when the subject is in focus.
Blinks when the subject is not in focus.

④ Autofocus mark

Position your subject within the autofocus mark.

LCD Panel

- ⑤ Date/time indicator
- ⑥ Spot (p. 41)
- ⑦ Exposure counter (p. 19)
- ⑧ Battery check (p. 14)
- ⑨ Red-eye Reducing Night Scene Flash (p. 40)
- ⑩ Night Scene Flash (p. 39)
- ⑪ Red-eye Reducing Flash (p. 36)
- ⑫ Fill-In Flash (Forced Activation) (p. 38)
- ⑬ Off (Flash Override) (p. 37)
- ⑭ Selftimer/remote control (p. 43/44)

Note; The LCD panel does not actually display all indications simultaneously as shown.

DIOPTR ADJUSTMENT

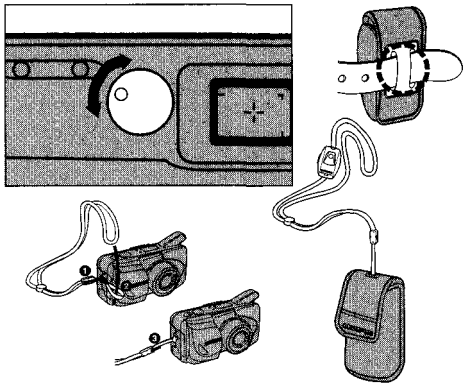

Turn the diopter adjustment dial until the viewfinder display becomes clear.

Turn to the right if you are far-sighted or to the left if you are near-sighted.

USING THE STRAP/SOFT CASE

Attach the strap as shown.

The soft case can also be carried on a belt.

OUTLINE OF OPERATIONS

Basic Shooting Procedures

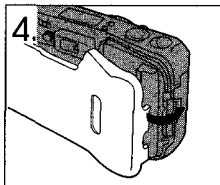
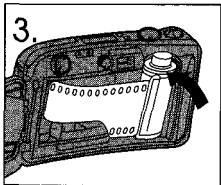
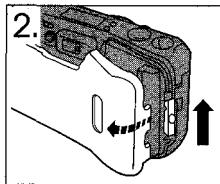
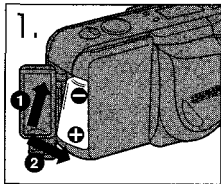

1. Load a battery (p. 13).
2. Open the back cover (p. 17).
3. Load the film (p. 17).
(Use of ISO 400 film is recommended.)
4. Close the back cover. The film automatically advances to the first frame (p. 19).

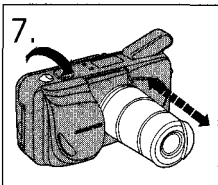
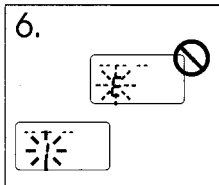
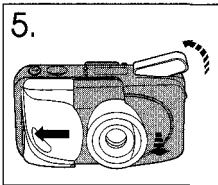

5. Open the lens barrier until you feel a click (p. 19).

6. Make sure the exposure counter on the LCD panel reads ! (p. 19).

7. Press the zoom lever for telephoto or wide-angle photography (p. 21).

8. Place the autofocus mark on the subject you want to photograph (p. 22).

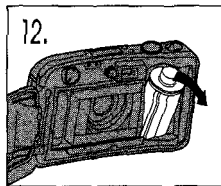
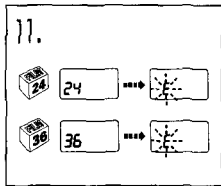
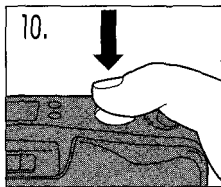
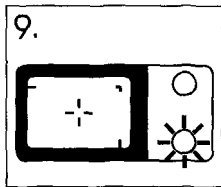

9. Depress the shutter release button halfway to make sure the green lamp lights (p. 22).

10. Depress the shutter release button fully to take a picture (p. 23).

11. When the film reaches the end, it will automatically rewind (p. 28).

12. Open the back cover to remove the rewound film (p. 28).

LOADING THE BATTERY

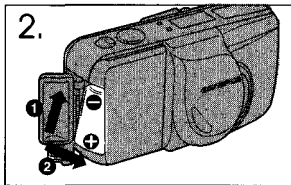
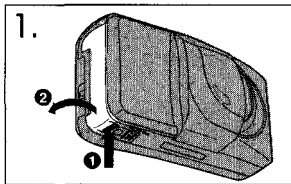



1. Close the lens barrier. Push OPEN **1** to open the battery compartment cover **2**.
 2. Insert the new battery correctly as shown and close the battery compartment cover tightly.
- Use a 3 V lithium battery (DL 123A, CR123A, or equivalent.)
 - About 15 rolls of film can be used with one new battery. (p. 49)

Read "Battery Handling" on page 55.

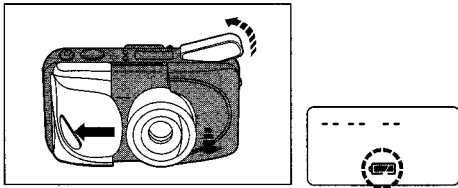
CHECKING THE BATTERY



Open the lens barrier as shown until you feel a click. Check the remaining battery power.

Display	Meaning
 lights (and turns off automatically).	Battery is OK. You can shoot.
 blinks and other indicators on the LCD panel are displayed normally.	Battery power is low and battery should be replaced.
 blinks and other indicators on the LCD panel go out.	Battery is dead and should be replaced immediately.

Note: Keep spare battery on hand when going on a long trip or a wedding or when using the camera in cold weather. Adjust the data every time the battery is replaced.

POINTS TO REMEMBER

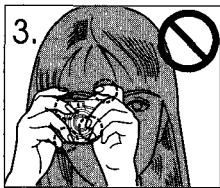
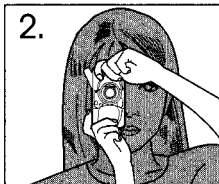
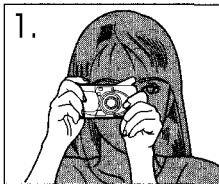

Hold the Camera Correctly.

1. Correct.
Hold the camera firmly with both hands while keeping elbows at sides to prevent the camera from shaking.
2. Correct.
In the vertical position, hold the camera with its flash positioned at the top.
3. Incorrect.

Caution:

Keep your fingers and the strap away from the lens, autofocus windows and flash. (p. 6)

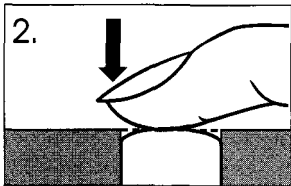
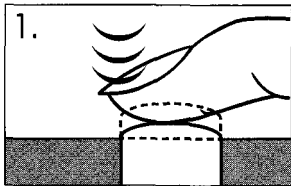

Proper Shutter Release.

Practice before loading the film.

1. Depress the shutter release button halfway to lock the focus.

Make sure

The green lamp next to the viewfinder lights.

2. Depress the shutter release button fully to release the shutter and take the picture.

Cautions:

- Press the shutter release button gently.
- Avoid shaking the camera when pressing the shutter release button to prevent blurry pictures.

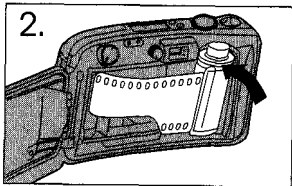
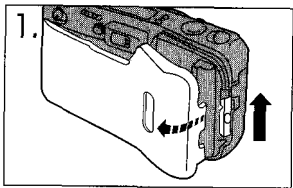

LOADING THE FILM

1. Slide the back cover release upward to open the back cover.

Do not touch the inside of the camera, especially the lens. If there is dust or dirt on the lens, remove it with a blower brush.

2. Insert the film cartridge, making sure the film is lying flat.

Notes:

- Use of ISO 400 film is recommended.
- When using non-DX-coded film, ISO 100 is automatically set.

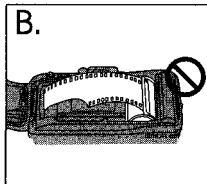
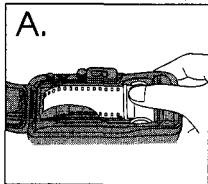

A. Correct.
Make sure the film is lying flat before closing the back cover.

B. Incorrect.

Push the film cartridge gently as shown in (A) to position the film correctly. If the film is not lying flat as shown in (B), the film may not advance to the first frame.

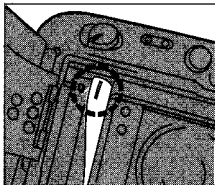

Caution:
Do not touch the plastic parts near the take-up spool.

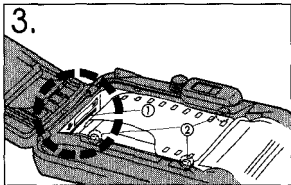

3. Align the film leader with the mark ①. Then press the right side of the back cover and close it securely.

The film automatically advances to the first frame.

Make sure

The film does not overlap any of the positioning guides ② shown on the left. Then close the back cover.

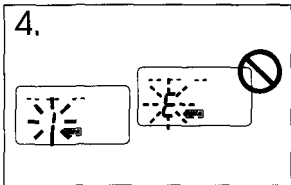

4. Open the lens barrier until you feel a click.

Make sure

The exposure counter on the LCD panel reads !.

Note:

If **E** blinks in the exposure counter, as shown on the left, the film is improperly loaded. Reload the film.

TAKING PICTURES

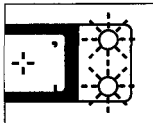
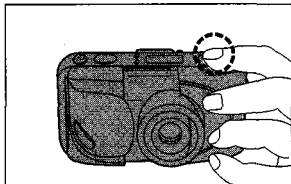
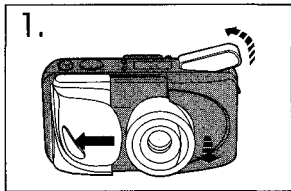

1. Open the lens barrier until you feel a click.

Make sure

The lens extends slightly, the flash pops up, and the LCD panel activates.

When the flash is held down, the two indicators next to the viewfinder blink. The camera will not activate. The display also goes out.

Release your finger from the flash to reactivate the camera.

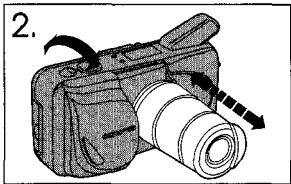

2. Aim the camera at your subject. Use the zoom lever for telephoto or wide-angle photography.

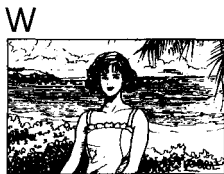

How to Use the Zoom Lever

Telephoto:

Pull the lever to the "T" side to zoom in.

Maximum telephoto focal length: 80 mm

Wide angle:

Push the lever to the "W" side to zoom out.

Maximum wide-angle focal length: 28 mm



3. Position the autofocus mark on your subject.

① Autofocus mark

⊘ Do not look directly at the sun through the viewfinder.

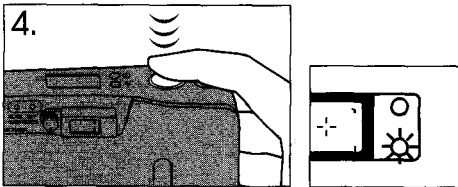

4. Depress the shutter release button halfway to adjust the focus.

Make sure

Focus has been correctly adjusted and the green lamp lights. Exposure also will be adjusted automatically.

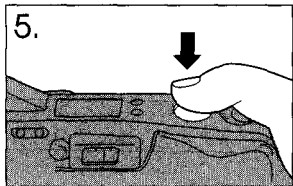

5. Depress the shutter release button fully to take the picture.
The film automatically advances to the next frame.

Working Distance

The focus range of the camera is 0.8 m (2.6 ft) to ∞ (infinity).

- When the subject is closer than 0.8 m (2.6 ft), the shutter will not release, (The green lamp blinks.)
- When the subject is extremely close to the camera, the subject will be out of focus although the shutter releases.

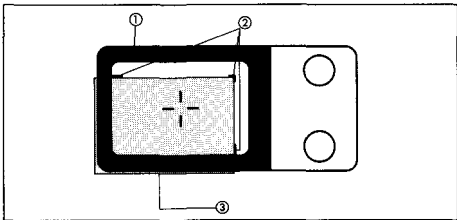

Close-up Correction

- ① Picture frame
- ② Close-up correction marks
- ③ Image area of picture at 0.8 m (2.6 ft)

The viewfinder's picture frame shows the area that can be shot for subjects at ∞ . However, the picture area will move lower in the viewfinder as you get closer to the subject. At 0.8 m (2.6 ft), the shaded area is the actual available image area. In this case, the subject should be positioned below the close-up correction marks.

USING THE FOCUS LOCK

To avoid taking out of focus pictures

When the main subject is not within the autofocus mark. Use the focus lock.

The autofocus mark must be positioned on the subject in this case. The camera will focus on the background behind the subjects and the subjects will be out of focus.

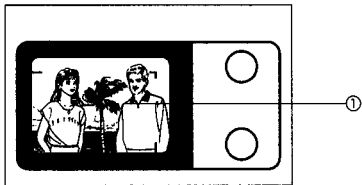

① Autofocus mark

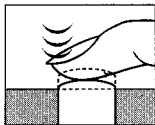
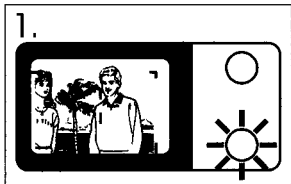

1. Position the autofocus mark  on your subject and press the shutter release button halfway.

Make sure

The green lamp lights.

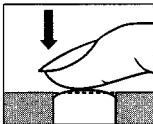
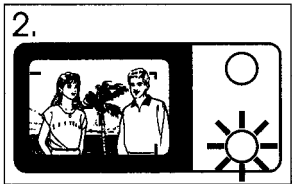

2. Reposition your subjects in the picture frame while keeping the shutter release button depressed halfway. Then press the shutter release button fully.

Difficult Autofocus Subjects

- Glossy or reflective surfaces
- Black objects
- Subjects behind glass or wire mesh
- Flames, smoke, etc.
- Sunlight or excessively bright light within the picture area

In such situations as the above, use the focus lock by focusing on a different subject at a similar distance. Then reposition the correct subject in the picture frame.

AFTER SHOOTING

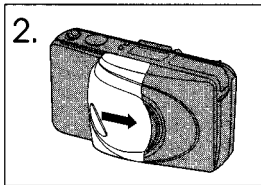
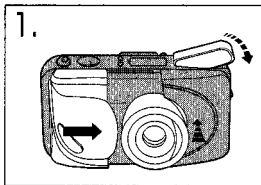

1. Close the lens barrier slowly and carefully. The lens and flash will retract automatically.
2. Close the lens barrier completely. The display goes out.

Caution:
Do not forcibly close the lens barrier as it will interfere with lens retraction.

UNLOADING THE FILM

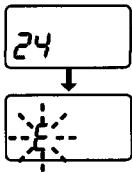
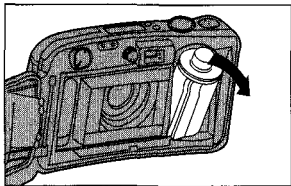

The camera automatically rewinds the film when you reach the end of a roll.

After the motor stops and **E** starts blinking on the LCD panel, open the back cover and remove the film.

Notes:

- The number of exposures remaining decreases during winding.
- The final number of exposures may sometimes exceed the number of exposures specified on the film.

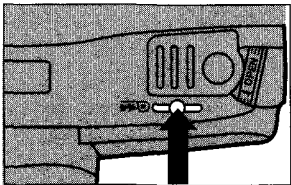

Rewinding the film before the end of the roll

Press the mid-roll rewind button gently with your nail, etc. Do not use an instrument with a sharp tip.

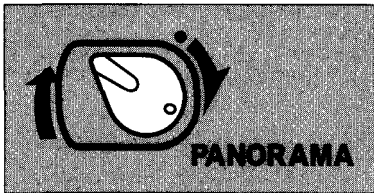

A B

Download from [Www.Somanuals.com](http://www.Somanuals.com). All Manuals Search And Download.

TAKING PANORAMA PICTURES

Set the switch to PANORAMA to engage the Panorama mode.
Set the switch back to the original position to restore the Standard mode.

Caution:

Do not touch the sliding PANORAMA borders inside the camera when the back cover is open in the Panorama mode to avoid malfunction.

Note:

Always set the panorama switch to either end, not midway between the two ends.

A. Viewfinder in the Standard mode.
B. Viewfinder in the Panorama mode.

CLOSE-UP CORRECTION IN THE PANORAMA MODE

At about 0.8 m (2.6 ft.) the shaded area in the illustration becomes the image area.

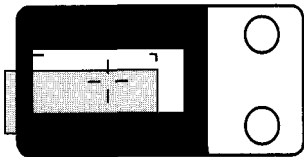

NOTES REGARDING PANORAMA FORMAT PRINTS



- **Availability of Panorama format film processing facilities varies according to area. We recommend that you consult your local film processor or camera dealer before taking pictures in the Panorama mode.**
- When pictures taken in the Panorama mode are printed in the standard size, black strips appear at top and bottom of prints as shown on the left.
- Date or time can be imprinted even in the Panorama mode. Digits on Panorama prints are larger than on standard prints.
- When you run out of the stickers for the cartridge, ask your nearest Olympus service center.

A



B

THIS ROLL CONTAINS
35MM STANDARD AND
PANORAMA FORMAT
NEGATIVES.

PLEASE PROCESS AND
PRINT AS 35MM
STANDARD FORMAT.

HOW TO GET PANORAMA PRINTS IN THE UNITED STATES

- 1. For Film Shot Only in Panorama Mode**
Please affix the sticker A and be sure to ask specifically for Panorama prints from your processing lab.
- 2. For Film Shot in Both Panorama and Standard Modes**
It is possible to have all pictures printed in standard format. In this case, the sticker B is required. When you receive your prints, the pictures taken in the Panorama mode can be identified by the black strips at the top and bottom. If you wish, you can have these pictures reprinted in Panorama format by taking the respective negatives to your processing lab.
- 3.** These prints may appear slightly overexposed. However, they will be properly exposed for Panorama-size prints.

USING THE FLASH MODES

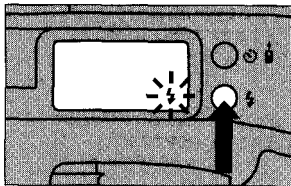

This camera has six flash modes. Select the flash mode according to your shooting conditions and needs.

How to select the flash mode:

As you press the FLASH mode button, the mode switches as shown on p. 34. The selected flash mode is displayed on the LCD panel.

⊘ Do not discharge flash too close to eyes of people or animals.

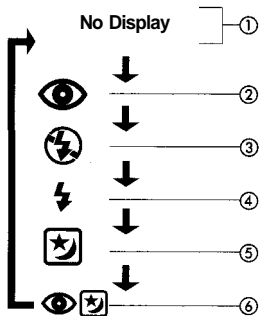

- ① **Auto Flash** mode:
Automatically fires in low-light and backlit conditions. (p. 35)
- ② **Red-eye Reducing Flash** mode:
Significantly reduces the phenomenon of "red-eye" (when a subject's eyes appear red in flash photos). (p. 36)
- ③ **Off (Flash Override)** mode:
The flash does not fire. (p. 37)
- ④ **Fill-In Flash (Forced Activation)** mode:
Fires regardless of available light. (p. 38)
- ⑤ **Night Scene Flash** mode:
Lights the subject in the foreground with a night scene in the background. (p. 39)
- ⑥ **Red-eye Reducing Night Scene Flash** mode:
Significantly reduces the "red-eye" phenomenon against a night background. (p. 40)

Note:

When firing flash, the flash strength is automatically controlled to prevent pictures from being overexposed even when the subjects are close.

AUTO FLASH

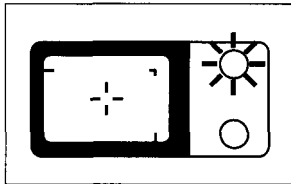

The flash fires automatically in the dark and in backlit conditions.

Make sure

The orange lamp in the upper right of the viewfinder lights when the shutter release button is depressed halfway.

Notes:

- When the orange lamp is blinking, the flash is being recharged and the shutter won't release. Release your finger from the shutter release button, and wait for several seconds.
- Maximum distance is about 70% when using positive color film.

ISO	W (28 mm)☆	T (80 mm)☆
100	0.8~4.4 m(2.6~14.4 ft)	0.8~2.3 m(2.6~7.5 ft)
200	0.8~6.2 m(2.6~20.3 ft)	0.8~3.3 m(2.6~10.8 ft)
400	0.8~8.8m(2.6~28.9 ft)	0.8~4.6 m(2.6~15.1 ft)

☆ **Flash Working Range (with color negative film)**

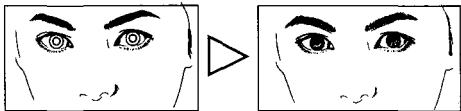

RED-EYE REDUCING FLASH

Significantly reduces the phenomenon of "red-eye" (when a subject's eyes appear red in flash photography).

In the  flash mode, the camera will fire a series of low-power pre-flashes before the regular flash. This makes the subject's pupils contract, significantly reducing red-eye. Except for the pre-flashes, this mode is the same as the Auto Flash mode.

Red-eye reduction may not be effective when the subject.

1. Is not looking at the flash from the right front.
2. Is not watching the pre-flashes.
3. Is too far from the camera.

The effectiveness of red-eye reduction varies depending on the individual characteristics of subjects.

IMPORTANT: Be sure to hold the camera still until the shutter releases. It takes approximately one second.



OFF (Flash Override)

When you don't want the flash to fire even in the dark or when you want to shoot such subjects as fireworks.

In the Flash-Off mode, the flash does not fire even in low-light conditions. Use this mode in situations where flash photography is not desired or is prohibited or in twilight or night scenes.

Note: Since a slow shutter speed (down to 4 seconds) is automatically selected in low-light situations when in the Flash-Off mode, the use of a tripod is recommended to prevent blurred pictures caused by shaking the camera. Closing the lens barrier restores the Auto Flash mode.

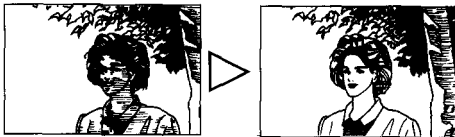

⚡ FILL-IN FLASH (Forced Activation)

When you want to fire the flash every shot.

In the ⚡ Flash mode, the flash fires regardless of available light. For example, this mode can be used to brighten up a subject's shaded face or under artificial lighting such as backlight or fluorescent light. Use this mode within the flash working range (p. 35).

It may be hard to work under excessively bright light. Closing the lens barrier restores the Auto Flash mode.



NIGHT SCENE FLASH

Both people and night scenes can be clearly photographed in this mode.

When taking pictures of people with a night background, this mode produces clear images of both.

Notes:

- Since a slow shutter speed (down to 4 seconds) is automatically selected in low-light situations, use a tripod to prevent blurred pictures caused by camera shake.
- The Spot mode cannot be used while the Night Scene Flash mode is being used.
- Closing the lens barrier restores the Auto Flash mode.



RED-EYE REDUCING NIGHT SCENE FLASH MODE

Significantly reduces the "red-eye" phenomenon often seen when people are photographed against a night background.

The camera will fire a series of low-power pre-flashes before the flash fires. This makes the subject's pupils contract, significantly reducing the red-eye. Except for the pre-flashes, this mode is the same as the Night Scene mode.





Read the precautionary remarks in "Red-eye Reducing Flash" (p. 36) and "Night Scene Flash" (p. 39). The Spot mode cannot be used while the Red-eye Reducing Night Scene Flash mode is being used.

Note: When the lens barrier is closed, the Red-eye Reducing Flash mode is restored.

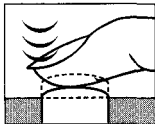
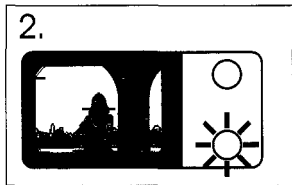
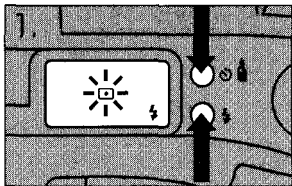
SPOT MODE

To focus and set the exposure for a selected area.



1. Press the  button and  button at the same time.
 is displayed on the LCD panel.
Press the  and the flash mode buttons at the same time or close the lens barrier to cancel the Spot mode.
2. Position the autofocus mark  on your subject, and press the shutter release button halfway.

Make sure

- The green lamp lights.
- The exposure will be locked in the center of the autofocus mark.

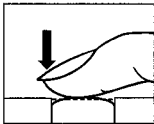
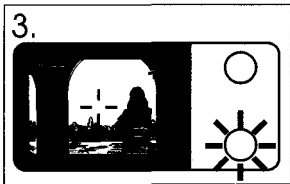

3. Reposition your subject in the picture frame while keeping the shutter release button depressed halfway. Then press the shutter release button fully.

Focus and exposure can be adjusted at different points from the autofocus frame using the Spot mode.





The use of the Spot mode is recommended in the following cases:

- When there is an object in front of the main subject.
- When the subject is on the edge of the frame.
- When the background is brighter than the subject (the subject is backlit).

SELF TIMER

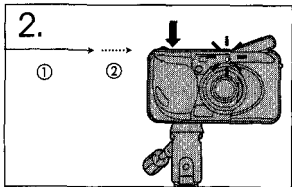
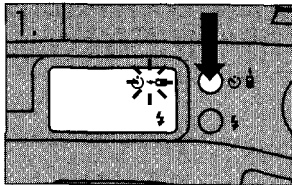
To put yourself in the picture.



1. Press the  button.
 is displayed on the LCD panel.

Make sure

The camera is fixed firmly on a tripod or other support.

2. Aim at your subject, and press the shutter release button.
 - ① 10 sec.: Selftimer indicator lights
 - ② 2 sec.: BlinksThe shutter will be released about 12 seconds after pressing the shutter release button.

Notes:

- The focus and exposure will be locked when the shutter release button is depressed halfway.
- The selftimer is disengaged when the shutter is released.
- To cancel the selftimer after it has been activated, press the  button again.

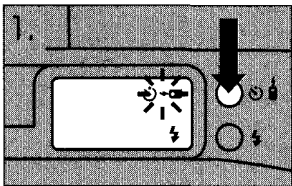

REMOTE CONTROL (optional)

The optional RC-200 Remote Control is required in the operation below.

1. Press the  button.  is displayed on the LCD panel.

After shooting, press the  button again to cancel the Selftimer/Remote Control mode. Remote control operation is canceled automatically when not in use for more than 20 minutes.

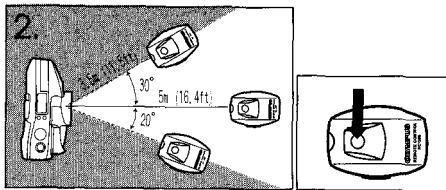

Aim the remote control at the camera, and press the button. The shutter will be released after about 3 seconds.

Notes:

- Use the remote control within the range shown at left.
- The camera will focus on the subject directly in front of it.
- The remote control may not work when the subject is backlit. In this case, use the selftimer.
- The remote control may not work when there is inverted fluorescent light near the camera.

CORRECTING THE DATA

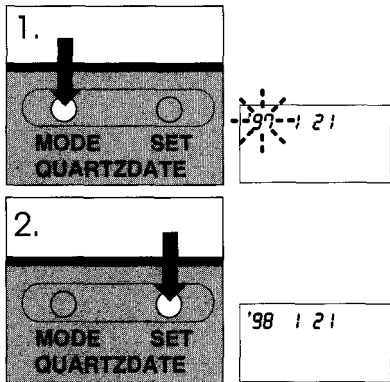

1. Press the MODE button for two seconds or longer.

The year indication will start blinking.

2. Press the SET button to correct the year.

If you press the button once, the number on the display will advance by 1. And if you keep it pressed, the numbers will run in rapid succession.

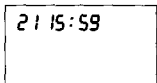
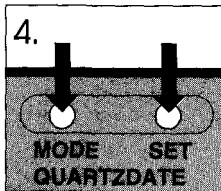
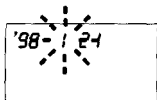
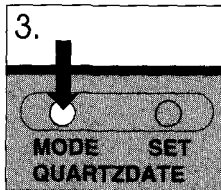

3. Press the MODE button again.
The month indication will start blinking.

4. Repeat steps 2 and 3 to set the hour and minutes.

Note: As you press the mode button, the blinking indication changes in the order of year, month, day, hour, and minute. The data correction will be finished when the mode button is pressed again.

PRINTING THE DATE AND TIME

Choose the desired mode with the MODE button.

The mode will switch in the described order by pressing the MODE button.

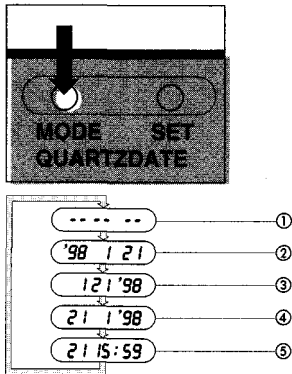

The quartzdate uses the same power source as the main unit. Make sure to correct the data after the battery is replaced.

The data is imprinted in the lower right of the picture. If there is something whitish or tinged with orange where the data is imprinted, the data may be difficult to read. The data may not be imprinted correctly on the frame(s) after the specified final exposure of the film.

- ① No data ② Year-month-day ③ Month-day-year
④ Day-month-year ⑤ Day-hour-minute

QUESTIONS AND ANSWERS

Q: How long will the battery last?

A: A new 3V lithium battery will last for roughly 15 rolls of 24-exposure film on which the flash was used on half of all the shots (determined under Olympus test conditions). If you do not use the flash and zoom very often, the battery will last much longer.

Q: Why does the flash get hot?

A: If the flash is used continuously, it may become hot. If this happens, stop using the camera for a while.

Q: Can I use infrared film?

A: No, you cannot.

Q: How should I clean the lens?

A: Wipe the lens gently with lens cleaning tissue that has been moistened with a small amount of lens cleaning fluid.

Q: Can I mount a filter or hood?

A: No, you cannot.

Q: What should I do when both the orange and green lamps are blinking and the camera doesn't work?

A: Release your finger from the flash. The camera will reactivate.

CARE AND STORAGE

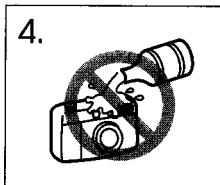
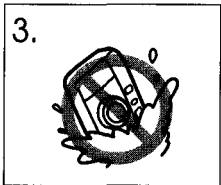
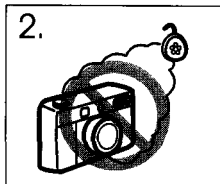
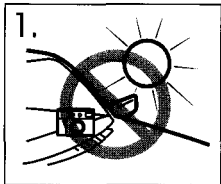

1. Do not leave the camera in any place exposed to excessive heat, humidity, or direct sunlight — for example, in a car or on the beach.
2. Do not expose the camera to formalin or naphthalene.
3. If the camera gets wet, wipe it with a dry towel as soon as possible. The salt in seawater can be especially damaging.
4. Do not use organic solvents, such as alcohol or paint thinner when cleaning the camera.

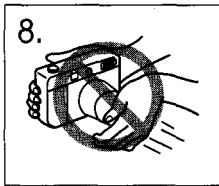
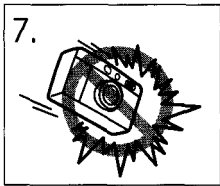
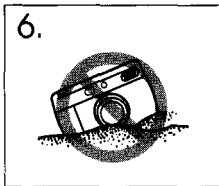
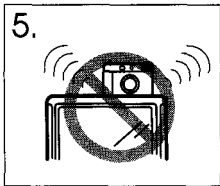

5. Do not leave the camera on or near a television, refrigerator, or other appliance with a magnetic field.
 6. Do not expose the camera to dust or sand as this could cause serious damage.
 7. Do not shake or shock the camera.
 8. Do not apply excessive force to the zoom lens.
- Keep the camera in a well-ventilated place.
 - Do not expose the camera to extreme heat (over 40°C/104°F) or to extreme cold (below -10°C/14°F). Low temperatures, even within this range, may sometimes cause deterioration in battery performance, temporarily disabling the camera.

- When transporting the camera from a cold place to a warm place or in the event of a sudden temperature change, put the camera into a plastic bag. This allows the camera's temperature to change slowly. Once the camera has adjusted to the new temperature, you can remove it from the bag and use it.
- Keep your hair, hands, strap, etc. away from the autofocus window, lens, AE sensor and flash.
- Avoid leaving the camera unused for long periods of time. This can cause mold to grow on the camera as well as other problems. Try to press the shutter release button and check the operation of camera before use.
- Some airport X-ray machines can damage the film in your camera. Try to avoid passing your camera through these machines. Give to the security officer for manual inspection.
- This camera is controlled by a microcomputer. Problems with the microcomputer can affect or stop camera operation. If this happens, remove the batteries, then reload them and try the camera again. Strong electrical fields can also interfere with the operation of this camera so try to avoid places or objects that generate such fields.
- This camera is not suitable for professional use or for use under severe conditions.

CARING FOR YOUR WEATHERPROOF CAMERA

This camera is weatherproof; however, it is not designed for underwater use. Please note the following warnings and use the camera correctly.

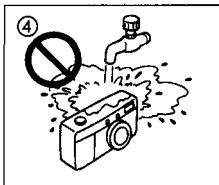
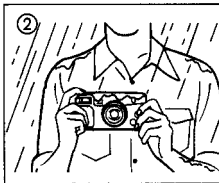

- ① The camera can withstand splashing water (e.g., seaside, poolside, etc.)
- ② The camera can be used in rain.
- ③ And in snow.
- ④ Do not wash the camera.

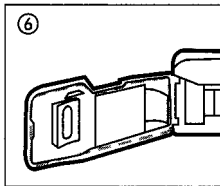

⑤ Do not submerge the camera or attempt to take pictures underwater.

⑥ Rubber gaskets are located inside the rear of the camera. Check the gaskets for wear and carefully remove any sand and dust to maintain a weatherproof seal.

- If the camera has been splashed by water, etc., clean the camera with a dry cloth as soon as possible.
- Do not touch the rubber gasket on the battery compartment cover or the rubber gasket on the camera back with excessive force. Do not remove the gaskets.
- Gaskets should be replaced after approximately three years, although they may require replacement earlier than that depending on use and wear.
- If the gaskets are damaged or need replacement, contact your nearest Olympus service center.

BATTERY HANDLING

NOTES

- When the camera is not used for an extended period of time, remove the battery.
- Keep a spare battery on hand when going on a long trip or to a cold area.
- Sweat, oil, and so on can prevent a battery's terminals from making electrical contact. To avoid this, wipe both terminals before loading a battery.
- Dispose of used batteries as general waste according to local regulations.

WARNINGS

- NEVER TRY TO DISASSEMBLE, RECHARGE, OR SHORT-CIRCUIT A BATTERY. NEVER EXPOSE A BATTERY TO EXCESSIVE HEAT OR OPEN FLAMES.
- KEEP THE BATTERY OUT OF THE REACH OF CHILDREN. IF A CHILD SWALLOWS A BATTERY, CONTACT A DOCTOR IMMEDIATELY.
- USE ONE 3V LITHIUM BATTERY (DL123A OR CR123A). NEVER TRY TO DISASSEMBLE OR MODIFY ANY BATTERY OR BATTERY PACK FOR USE IN THIS CAMERA.

REMOTE CONTROL (optional) HANDLING

- Keep the remote control out of the reach of children. If a child swallows the remote control, contact a physician immediately.
- Never try to disassemble the remote control. Never expose the remote control to excessive heat or open flame.

TROUBLESHOOTING

OPERATING PROBLEMS

The camera does not work.

- ① The lens barrier is not opened.
→ Open the lens barrier completely. (p. 20)
- ② The alignment of the battery terminals is not correct.
→ Reload the battery correctly. (p. 13)
- ③ The battery is exhausted.
→ Replace the battery with new one. (p. 14)
- ④ The battery is temporarily unable to function because of cold.
→ Keep the camera warm while using it.
- ⑤ The loaded film has been rewound.
→ Remove the film. (p. 28)
- ⑥ The film is incorrectly loaded.
→ Reload the film. (p. 17)
- ⑦ You pushed the mid-roll rewind button when the film was not loaded.
→ Open and close the back cover.
- ⑧ The flash is held with your finger.
→ Release your finger.

The LCD display goes off suddenly.

- ① If you don't use the camera, the LCD goes off after four and half minutes.
→ Close the lens barrier and open it again or operate the zoom lever to turn the LCD back on. In addition, the power is turned off automatically after 4.5 hours. When the camera is not in use, try to keep the lens barrier closed.

The shutter doesn't release when the remote control's button is pressed.

- ① The remote control hasn't been used in the 20 minutes since the Selftimer/Remote Control mode was engaged, causing the LCD panel to turn off.
→ Press the zoom lever. The LCD will light. Then press the Selftimer/Remote button again.

The green lamp blinks, and the shutter release button will not release.

- ① The camera is closer than 0.8 m (2.6 ft) to the subject.
→ Move the camera back to distance more than 0.8 m (2.6 ft) from the subject. (p. 23)

The orange lamp blinks, and the shutter will not release.

- ① The flash has not been recharged yet.
→ Remove your finger from the shutter release button and wait for several seconds until the flash is recharged before shooting. (p. 35)

The flash does not fire, even in the dark.

- ① The flash mode is set to Off.
→ Set it to a mode other than Off. (p. 37)
- ② High sensitivity film is being used.
→ Set the flash mode to Fill-In. (p. 38)

The viewfinder is out of focus.

- ① Diopter dial is not adjusted.
→ Adjust the diopter dial until image is clear. (p. 9)

PROBLEMS WITH PRINTED PICTURES

The picture is out of focus.

- ① The camera moved when the shutter release button was pressed.
→ Hold the camera correctly and press the shutter release button gently. (p. 15)
- ② The subject was not within the viewfinder's autofocus mark.
→ Position the subject in the center of the autofocus mark. (p. 22)
- ③ The lens and autofocus windows were dirty.
→ Clean the lens and autofocus windows.

- ④ The autofocus window was blocked, such as by a finger.
→ Hold the camera correctly, keeping your fingers clear of the autofocus windows. (p. 15)
- ⑤ The subject was closer than the minimum working distance to the lens (0.8 m/2.6 ft).
→ Shoot from more than 0.8 m (2.6 ft) away from the subject. (p. 23)
- ⑥ When using the selftimer, the shutter release button was pressed while standing right in front of the camera.
→ Do not stand in front of the camera. Press the shutter release button while looking through the viewfinder. (p. 43)

- ⑦ The autofocus didn't work correctly. There are some subjects that are difficult for the autofocus to lock on. These include: glossy or reflective surfaces, black objects, subjects behind glass or wire mesh, flames and smoke, excessively bright light within the picture area.
→ First focus on an object at the same distance as the desired subject. Then aim at the desired subject and press the shutter release button.
(p. 42)

The picture is too dark.

- ① The flash was blocked, (e.g. by a finger).
→ Hold the camera correctly, keeping your fingers clear of the flash. (p. 15)
- ② The subject was out of the working range of the flash.
→ Shoot within the flash working range. (p. 35)
- ③ The flash mode was set to Off.
→ Check the flash mode before shooting. (p. 33)

The data has not been printed (or looks faded).

- ① The data mode was set to no data (---).
→ Change the data mode to another setting.
(p. 48)
- ② There is a bright color like white, orange, or yellow in the area of the picture where the data is printed.
→ Avoid bright colors in the lower right corner of your photo compositions. (p. 48)
- ③ The picture was taken with black-and-white film.
→ Do not use black-and-white film if you want to print data on the pictures.

The color of a picture taken indoors is abnormal.

- ① The color of the room lighting affected the picture.
→ Set the flash to Fill-In mode.

SPECIFICATIONS

- Type: Full automatic 35 mm autofocus lens-shutter camera with built-in 28 ~ 80 mm zoom lens.
- Film format: 35 mm standard DX-coded film (24 x 36 mm)
- Lens: Olympus lens 28 ~ 80 mm F4.5 ~ 8.4, 9 elements in 8 groups.
- Shutter: Programmed electronic shutter.
- Viewfinder: Real image zoom viewfinder (with autofocus mark, close-up correction marks, autofocus indicator and flash indicator). Provided with diopter adjustment.
- Focusing: Active-type autofocus system. Focus lock possible. Focusing range: 0.8 m (2.6 ft) ~ ∞ (infinity).
- Exposure control: Programmed automatic exposure control, 2-zone light metering, switchable to spot metering. Auto exposure range: Wide-angle — EV2.4 (F4.5, 4 sec.) to EV16 (F11.4, 1/500 sec.), Telephoto — EV4.2 (F8.4, 4 sec.) to EV17 (F19.8, 1/335 sec.).
- Exposure counter: Progressive type with automatic reset, displayed on LCD panel.

Selftimer: Electronic selftimer 12-sec. delay.

Remote control (optional): Infrared remote control unit with 3-sec. delay.

Film speed range: Automatic setting with DX-coded film with ISO 50, 100, 200, 400, 800, 1600, 3200.





Film speeds other than above will be automatically set to next lower speed. For non DX-coded film and film with less than ISO 50, film speed is set to ISO 100.

Film loading: Automatic loading. (Automatically advances to first frame when camera back cover is closed.)

Film advance: Automatic film winding.

Film rewind: Automatic film rewind (automatic rewind activation at end of film, automatic rewind stop).
Rewind possible at any point with rewind button.

Flash: Built-in flash. Recycling time: Approx. 0.5 ~ 7 sec. (at normal temperature with new battery).
Flash working range: Wide-angle — 0.8 ~ 4.4 m (2.6 ~ 14.4 ft), Telephoto — 0.8 ~ 2.3 m (2.6 ~ 7.5 ft) with ISO 100 color negative film; Wide-angle — 0.8 ~ 8.8 m (2.6 ~ 28.9 ft), Telephoto — 0.8 ~ 4.6 m (2.6 ~ 15.1 ft) with ISO 400 color negative film.

Flash modes: Auto (automatic flash activation in low light and backlight,  Red-eye Reducing (otherwise same as in Auto),  Flash Off (no flash with slowest shutter speed of 4 sec.),  Fill-In (forced activation),  Night Scene (for night scenes with slowest shutter speed of 4 sec. other functions operate the same as in Auto),  Red-eye Reducing Night Scene (otherwise same as in Night Scene).

Battery check: Displayed on LCD panel.

Weatherproof: IEC Standard publication 529.

Classification of degrees of protection provided by enclosures. Degree of protection indicated by second characteristics numeral 4.

Short description: Protected against splashing water.

Definition: Water splashed against enclosure from any direction shall have no harmful effect.

Test for second numeral 4: Equipment is sprayed from all practical directions. Water pressure is adjusted to give delivery rate of 10 lit./min. Test duration shall be 1 min. per m² of calculated surface area of enclosure with minimum duration of 5 min.

Power source: 3 V lithium battery (DL123A/CR123A)

Dimensions: 120 (W) x 64 (H) x 49 (D) mm
(4.7 x 2.5 x 1.9 in) (without grip and other protrusions).

Weight: 255 g (9.0 oz) (without battery)

SPECIFICATIONS FOR DATE UNIT

Imprinting direction: Data imprinted onto film from lens side.

Data coding: No data, year-month-day, month-day-year, day-month-year and day-hour-minute.

External indication of data: Data display on LCD panel.

Film speed setting: Automatic film speed setting.

Automatic calendar system: Up to year 2030.

Power source: Ordinarily used with camera body.

SPECIFICATIONS ARE SUBJECT TO CHANGE
WITHOUT ANY NOTICE OR OBLIGATION ON THE
PART OF THE MANUFACTURER.

OLYMPUS®

OLYMPUS OPTICAL CO., LTD.

San-Ei Building, 22-2, Nishi Shinjuku 1-chome, Shinjuku-ku, Tokyo, Japan. Tel. 03-3340-2211

OLYMPUS AMERICA INC.

Two Corporate Center Drive, Melville, NY 11747-3157, U.S.A. Tel. 631-844-5000/1-800-622-6372

OLYMPUS OPTICAL CO. (EUROPA) GMBH.

(Premises/Goods delivery) Wendenstrasse 14-16, 20097 Hamburg, Germany. Tel. 040-237730
(Letters) Postfach 10 49 08, 20034 Hamburg, Germany.

OLYMPUS SINGAPORE PTE. LTD.

491B River Valley Road, #13-04 Valley Point Office Tower, Singapore 248373
Tel. 7387838/1-800-OLYMPUS(6596787)

This device complies with part 15 of the FCC Rules. Operation is subject to the conditions that this device does not cause harmful interference.

**This Class B digital apparatus meets all requirements of the Canadian Interference - Causing Equipment Regulations.
Cet appareil numérique de la classe B respecte toutes les exigences du Règlement sur le matériel brouilleur du Canada.**

CZ8976-①

B 0800 3.8MJ

Download from Www.Somanuals.com. All Manuals Search And Download.

Free Manuals Download Website

<http://myh66.com>

<http://usermanuals.us>

<http://www.somanuals.com>

<http://www.4manuals.cc>

<http://www.manual-lib.com>

<http://www.404manual.com>

<http://www.luxmanual.com>

<http://aubethermostatmanual.com>

Golf course search by state

<http://golfingnear.com>

Email search by domain

<http://emailbydomain.com>

Auto manuals search

<http://auto.somanuals.com>

TV manuals search

<http://tv.somanuals.com>