

OLYMPUS[®]

**DIGITAL VOICE
RECORDER**

WS-710M

WS-700M

WS-600S

**DETAILED
INSTRUCTIONS**

Thank you for purchasing an Olympus
Digital Voice Recorder.

Please read these instructions for information
about using the product correctly and safely.
Keep the instructions handy for future reference.

To ensure successful recordings, we recommend that
you test the record function and volume before use.

Register your product on www.olympus-consumer.com/register
and get additional benefits from Olympus!

EN

Introduction

- The contents of this document may be changed in the future without advanced notice. Contact our Customer Support Center for the latest information relating to product names and model numbers.
- The illustration of the screen and the recorder shown in this manual may differ from the actual product. The utmost care has been taken to ensure the integrity of this document but if you find a questionable item, error or omission, please contact our Customer Support Center.
- Any liability for passive damages or damage of any kind occurred due to data loss incurred by a defect of the product, repair performed by the third party other than Olympus or an Olympus authorized service station, or any other reason is excluded.

Trademarks and registered trademarks

- IBM and PC/AT are the trademarks or registered trademarks of International Business Machines Corporation.
- Microsoft, Windows and Windows Media are registered trademarks of Microsoft Corporation.
- Macintosh and iTunes are the trademarks of Apple Inc.
- microSD and microSDHC are the trademarks of SD Card Association.
- MPEG Layer-3 audio coding technology licensed from Fraunhofer IIS and Thomson.
- EUPHONY MOBILE™ is a trademark of DiMAGIC Corporation.
- DVM™ is a trademark of DiMAGIC Corporation.
- The product was developed based on noise-canceling technology under license from NEC Corporation.

Other product and brand names mentioned herein may be the trademarks or registered trademarks of their respective owners.



Table of contents

Introduction

Safe and proper usage	4
-----------------------------	---

1 Getting started

Main features	6
---------------------	---

Identification of parts	7
-------------------------------	---

Display (LCD panel)	8
---------------------------	---

Power supply	10
--------------------	----

Inserting batteries	10
---------------------------	----

Battery settings	12
------------------------	----

Charging by connecting to a computer via USB	12
--	----

Connect to the USB connecting AC adapter	
--	--

(optional) to charge	13
----------------------------	----

Turning on/off the power	15
--------------------------------	----

HOLD	16
------------	----

Setting time and date [Time & Date]	17
---	----

Changing the time and date	18
----------------------------------	----

Inserting and ejecting a microSD card	19
---	----

Inserting a microSD card	19
--------------------------------	----

Ejecting a microSD card	20
-------------------------------	----

[Home] display operations	21
---------------------------------	----

Notes on the folders	22
----------------------------	----

About the folders for voice recordings	22
--	----

About the folder for music playback	23
---	----

Selecting the folders and files	24
---------------------------------------	----

2 About recording

Recording	25
-----------------	----

Changing the recording scene [Rec Scene]	27
--	----

Recommended settings by recording condition	28
---	----

Recording from external microphone or other	
---	--

devices	29
---------------	----

3 About playback

Playback	31
----------------	----

Setting an index mark or a temp mark	35
--	----

Changing the playback speed	36
-----------------------------------	----

How to begin segment repeat playback	37
--	----

Changing the playback scene [Play Scene]	38
--	----

Erasing	39
---------------	----

Erasing files	39
---------------------	----

Erasing a folder	39
------------------------	----

4 About the FM radio (For WS-710M only)

Using the FM radio	41
--------------------------	----

FM radio mode operations	42
--------------------------------	----

Presetting radio stations automatically	
---	--

[Auto-preset]	43
---------------------	----

Changing the reception mode	44
-----------------------------------	----

Adding a radio station	45
------------------------------	----

Recording FM radio	46
--------------------------	----

5 Menu setting

Menu setting method	47
---------------------------	----

File Menu	49
-----------------	----

Rec Menu	49
----------------	----

Play Menu	53
-----------------	----

LCD/Sound Menu	56
----------------------	----

Device Menu	57
-------------------	----

FM Menu	59
---------------	----

Rearranging files [Replace]	59
-----------------------------------	----

Dividing files [File Divide]	60
------------------------------------	----

Changing the USB class[USB Settings]	61
--	----

Formatting the recorder [Format]	63
--	----

6 Using the recorder on your PC

Operating environment	65
-----------------------------	----

Connecting to your PC	67
-----------------------------	----

Disconnecting from your PC	68
----------------------------------	----

Transfer the voice files to your PC	69
---	----

Using Windows Media Player	70
----------------------------------	----

Window names	70
--------------------	----

Copying music from CD	71
-----------------------------	----

Transferring music file to the recorder	72
---	----

Copying voice file to the CD	75
------------------------------------	----

Using iTunes	77
--------------------	----

Window names	77
--------------------	----

Copying music from CD	78
-----------------------------	----

Transferring music file to the recorder	79
---	----

Copying voice file to the CD	80
------------------------------------	----

Using as external memory of the PC	81
--	----

7 Other information

Alarm message list	82
--------------------------	----

Troubleshooting	83
-----------------------	----

Accessories (optional)	86
------------------------------	----

Specifications	87
----------------------	----

Technical assistance and support	91
--	----

Safe and proper usage

Before using your new recorder, read this manual carefully to ensure that you know how to operate it safely and correctly. Keep this manual in an easily accessible location for future reference.

- **The warning symbols indicate important safety related information. To protect yourself and others from personal injury or damage to property, it is essential that you always read the warnings and information provided.**

General precautions

- **Do not leave the recorder in hot, humid locations such as inside a closed automobile under direct sunlight or on the beach in the summer.**
- **Do not store the recorder in places exposed to excessive moisture or dust.**
- **Do not use organic solvents such as alcohol and lacquer thinner to clean the unit.**
- **Do not place the recorder on top of or near electric appliances such as TVs or refrigerators.**
- **Avoid recording or playing back near cellular phones or other wireless equipment, as they may cause interference and noise. If you experience noise, move to another place, or move the recorder further away from such equipment.**
- **Avoid sand or dirt. These can cause irreparable damage.**
- **Avoid strong vibrations or shocks.**
- **Do not disassemble, repair or modify the unit yourself.**

- **Do not operate the unit while operating a vehicle (such as a bicycle, motorcycle, or go-cart).**
- **Keep the unit out of the reach of children.**

Precautions relating to reception:

- Radio reception will vary substantially depending on where you are using the radio. If the reception is poor, try moving the recorder near to a window and away from electrical products such as cellular phones, televisions, florescent lights etc.

Warning regarding data loss:

- Recorded content in memory may be destroyed or erased by operating mistakes, unit malfunction, or during repair work. It is recommended to back up and save important content to other media such as a computer hard disk.
- Any liability for passive damages or damage of any kind occurred due to data loss incurred by a defect of the product, repair performed by the third party other than Olympus or an Olympus authorized service station, or any other reasons is excluded from the Olympus's liability.

Precautions relating to recording:

- Olympus will not be held responsible for any deletion or corruption of recorded files caused by malfunction of the recorder or your PC.
- Content you have recorded cannot, under copyright law, be used for anything other than private consumption without the express consent of the copyright holder.

Batteries

Danger:

- Batteries should never be exposed to flame, heated, short-circuited or disassembled.
- Never store batteries where they will be exposed to direct sunlight, or subjected to high temperatures in a hot vehicle, near a heat source, etc.

Warning:

- Do not solder lead wires or terminals directly onto a battery or modify it.
- Do not connect the ⊕ and ⊖ terminals together. This may cause fire, overheating or electric shock.
- When carrying or storing the batteries, be sure to put it in the provided case to protect its terminals. Do not carry or store the batteries with any metal objects (such as key rings).
If this warning is not followed, fire, overheating or electric shock may occur.
- Do not connect the batteries directly to a power outlet or a cigarette lighter of an automobile.
- Do not insert the batteries with their ⊕ and ⊖ terminals reversed.
- If any liquid from a battery gets into your eyes, promptly wash it off with clean water and consult your doctor at once.
- Do not attempt to recharge alkaline, lithium or any other non-rechargeable batteries.

- Never use any batteries with a torn or cracked outer cover.
- Keep batteries out of the reach of children.
- If you notice anything unusual when using this product such as abnormal noise, heat, smoke, or a burning odor:
 - ① remove the batteries immediately while being careful not to burn yourself, and;
 - ② call your dealer or local Olympus representative for service.
- Do not expose the batteries to water. Do not allow water to contact the terminals.
- Do not remove or damage the batteries insulating sheet.
- Do not use the batteries if you find something wrong with them such as leakage, color change or deformity.
- Unplug the charger if the charging is still incomplete after the specified time it should take.
- Should any batteries liquid get on skin or clothing, promptly wash it off with clean water.
- Keep batteries away from fire.

Caution:

- Do not subject batteries to strong shocks.
- When using rechargeable batteries that have not been used for a while, be sure to recharge them before use.
- Rechargeable batteries have limited lifetime. When the operating time becomes shorter even if the rechargeable battery is fully charged under the specified condition, **replace it with a new one.**

Getting started

Main features

1

Main features

- **Built-in Stereo FM tuner.** You can use the recorder as a radio (For WS-710M only) (☞ P.41).
- **Dual function recorder as a digital voice recorder and a digital music player** (For WS-710M, WS-700M only) (☞ P.25, P.31).
- **Supports high capacity recording media.** Besides the built-in memory, you can also record into a microSD* card (☞ P.19).
* For WS-710M, WS-700M only.
- **Supports the linear PCM format, which is capable of recording sound quality equivalent to CD-level** (For WS-710M, WS-700M only) (☞ P.47, P.49).
- **Supports multiple recording formats, such as MP3 format (MPEG-1 Audio Layer 3) and Windows Media Audio (WMA) format** (☞ P.47, P.49).
- **You can playback WAV*, WMA, and MP3 format files transferred from a computer in addition to files recorded by the device itself.**
You can also enjoy using as a music player.
* For WS-710M, WS-700M only.
- **It has a built-in Variable Control Voice Actuator (VCVA) function** (☞ P.47, P.50).
- **The Low Cut Filter minimizes air conditioner noise and other similar noises while recording** (☞ P.47, P.50).
- **A directional microphone feature has been included that allows switching between broad stereo recording and recording with a highly directional quality** (For WS-710M only) (☞ P.47, P.50).
- **Has recording scene setting and playback scene setting functions to register the best setting according to different usages** (☞ P.27, P.38, P.47, P.52, P.55).
- **It features various repeat functions** (☞ P.37, P.47, P.54).
- **EUPHONY MOBILE has been included to produce a natural, realistic experience without degrading sound quality** (For WS-710M, WS-700M only) (☞ P.47, P.53).
- **You can change the playback equalizer settings** (For WS-710M, WS-700M only) (☞ P.47, P.55).
- **You can divide files that have been recorded by the recorder in MP3 or PCM* format** (☞ P.60).
* For WS-710M, WS-700M only.
- **Index mark and temp mark features allow you to quickly find desired locations** (☞ P.35).
- **The playback speed can be controlled as preferred** (☞ P.36).
- **Connecting this recorder directly to the USB port links up with your PC. The data can be transferred or saved without USB cable or driver software** (☞ P.69, P.81).
This recorder is compatible with USB 2.0, enabling fast data transfer to a computer.
- **It has a USB charging function** (For WS-710M, WS-700M only) (☞ P.12).
- **It has a backlight full-dot display (LCD panel)** (☞ P.8).

EN

6

Identification of parts

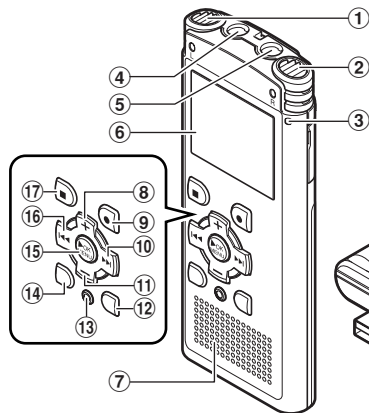

- ① Built-in stereo microphone (L)
- ② Built-in stereo microphone (R)
- ③ Recording indicator light
- ④ EAR (Earphone) jack
- ⑤ MIC (Microphone) jack
- ⑥ Display (LCD panel)
- ⑦ Built-in speaker
- ⑧ + button
- ⑨ REC (●) (Record) button
- ⑩ ►► button
- ⑪ – button
- ⑫ LIST button

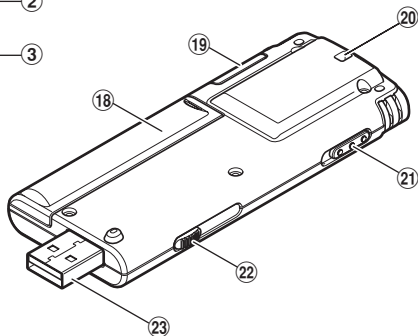

- ⑬ ERASE button
- ⑭ SCENE/INDEX button
- ⑮ OK ►/MENU button
- ⑯ ◼ STOP button
- ⑰ ►► button
- ⑱ – button
- ⑲ LIST button
- ⑳ ERASE button
- ㉑ SCENE/INDEX button
- ㉒ OK ►/MENU button
- ㉓ ◼ STOP button
- ㉔ ►► button
- ㉕ – button
- ㉖ LIST button
- ㉗ ERASE button
- ㉘ SCENE/INDEX button
- ㉙ OK ►/MENU button
- ㉚ ◼ STOP button
- ㉛ ►► button
- ㉜ – button
- ㉝ LIST button
- ㉞ ERASE button
- ㉟ SCENE/INDEX button
- ㊱ OK ►/MENU button
- ㊲ ◼ STOP button
- ㊳ ►► button
- ㊴ – button
- ㊵ LIST button
- ㊶ ERASE button
- ㊷ SCENE/INDEX button
- ㊸ OK ►/MENU button
- ㊹ ◼ STOP button
- ㊺ ►► button
- ㊻ – button
- ㊼ LIST button
- ㊽ ERASE button
- ㊾ SCENE/INDEX button
- ㊿ OK ►/MENU button
- 18 Battery cover
- 19 Card cover
- 20 Strap hole
- 21 POWER/HOLD switch
- 22 USB connector slide lever
- 23 USB connector

1

Identification of parts

EN

Display (LCD panel)

Folder list display

! For WS-710M:

When [Recorder] mode is selected:

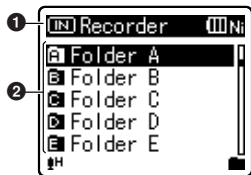

! For WS-700M:

When [Recorder] mode is selected:

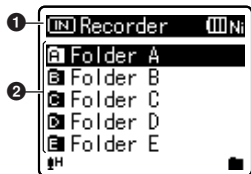

! For WS-710M/WS-700M:

When [Music] mode is selected:



! For WS-600S:

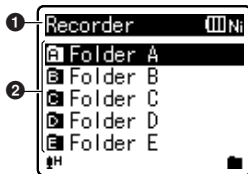

- 1** Recording media indicator*1, [Recorder] mode indicator, Battery indicator
- 2** Folder name
- 3** Recording media indicator*1, [Music] mode indicator, Battery indicator
- 4** Folder name

*1 For WS-710M, WS-700M only

File list display

! For WS-710M/WS-700M:

When [Recorder] mode is selected:

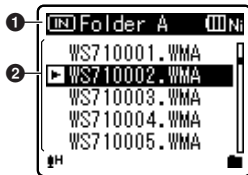

When [Music] mode is selected:

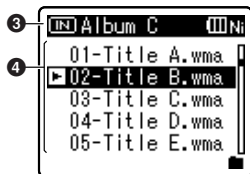

When [Music] mode is selected:



1

Identification of parts

! For WS-600S:



! For WS-600S:



- 1 Recording media indicator*1, Folder name, Battery indicator
- 2 File name
- 3 Recording media indicator*1, Folder name, Battery indicator
- 4 File name

*1 For WS-710M, WS-700M only

- 1 Recording media indicator*1, File name, Battery indicator
- 2 Folder indicator, Recording mode indicator
- 3 During recording mode:
Remaining memory bar indicator
During playback mode:
Playback position bar indicator
- 4 Record/ Playback status indicator
- 5 Recording date and time
- 6 [H] Microphone Sensitivity indicator,

File display

! For WS-710M/WS-700M:

When [Recorder] mode is selected:

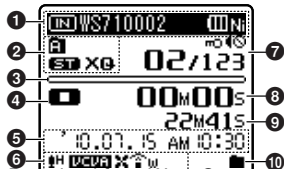

- [UCVA] VCVA indicator,
- [XG] Voice sync indicator,
- [NF] Noise Cancel indicator*1,
- [W] Voice Filter indicator,
- [L] Low Cut Filter indicator,
- [w] Zoom Mic indicator*2

- 7 [m] Erase lock indicator,
[4] Speaker muting indicator,
Current file number/ Total
number of recorded files in the
folder
 - 8 **During recording mode:**
Elapsed recording time
During playback mode:
Elapsed playback time
 - 9 **During recording mode:**
Remaining recording time
During playback or stop mode:
File length
 - 10 **Playback mode indicator**
 - 11 **Title name**
 - 12 **Artist name**
 - 13 **Album name**
 - 14 **Elapsed playback time**
 - 15 [A] **EUPHONY indicator*1**
[EQ] **Equalizer indicator*1**
 - 16 **Current file number/ Total
number of recorded files in the
folder**
[m] Erase lock indicator,
[4] Speaker muting indicator
 - 17 **File length**
 - 18 **Playback mode indicator**
- *1 For WS-710M, WS-700M only
*2 For WS-710M only

Inserting batteries

This recorder can be used with either Ni-MH Rechargeable Batteries or AAA Alkaline Batteries.



For WS-710M/WS-700M:

- When charging the recorder, be sure to use the supplied specified Ni-MH rechargeable (BR401) batteries.
- The supplied rechargeable batteries are not fully charged. Before using the unit or after long periods of disuse, it is recommended that you continuously charge them until full (P.12).



For WS-600S:

- This recorder cannot charge rechargeable batteries.

- 1 **Lightly press down on the arrow and slide the battery cover open.**

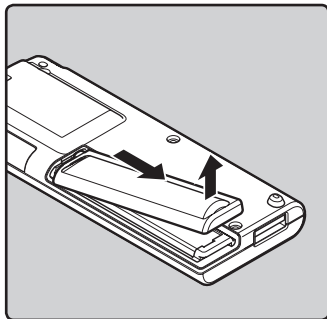

- 2** Insert size-AAA battery, observing the correct \oplus and \ominus polarities.

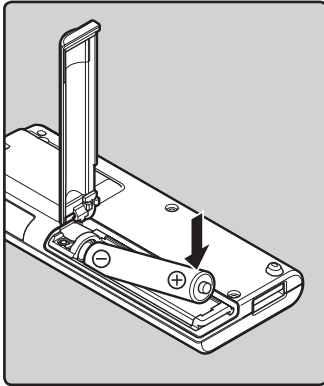

- 3** Close the battery cover completely by pressing to the direction **A**, then sliding to the direction **B**.

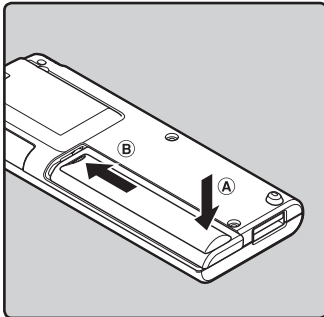

Notes

- Manganese batteries may not be used in this recorder.
- When changing batteries, AAA alkaline batteries or Olympus Ni-MH rechargeable batteries are recommended.
- Be sure to stop the recorder before replacing the batteries. Unloading the batteries while the recorder is in use may cause a malfunction such as corrupting the file, etc. If you are recording into a file and the batteries run out, you will lose your currently recorded file because the file header will not be able to close. It is crucial to change the batteries once you see only one Hash mark in the battery indicator.
- If it takes longer than 1 minute to replace the dead batteries or if you take the batteries in and out repeatedly at short intervals, you may have to redo the battery and time settings. In this case, the [Battery] screen will appear. For more details, refer to "Battery settings" (P.12).
- Remove the batteries if you are not going to use the recorder for an extended period of time.
- When replacing rechargeable batteries, be sure to use Ni-MH rechargeable batteries (optional). The use of other manufacturers' products can damage the recorder and should be avoided.

Battery settings

Select to match the battery you are using.

- 1 **Replace the battery and switch on the recorder.**
- 2 **Press the + or – button to change the setting.**

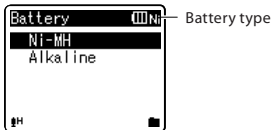

[Ni-MH] (||||):

Select when using the Olympus Ni-MH rechargeable battery (BR401).

[Alkaline] (||||):

Select when using a commercially available alkaline battery.

- 3 **Press the OK ►/MENU button to complete the setting.**
 - If the "Hour" indicator flashes in the display, see "Setting time and date [Time & Date]" (P.17).

Battery indicator

The battery indicator on the display changes as the batteries loose power.



- When [] appears on the display, replace the batteries as soon as possible. When the batteries are too weak, [] and [Battery Low] appears on the display and the recorder shuts down.

Note

- When playing a voice/music file, the recorder may be reset due to the reduction of the voltage output of the batteries depending on the volume level even if [] is displayed in the battery indicator. In this case, lower the volume of the recorder.

Charging by connecting to a computer via USB

! For WS-710M/WS-700M:

You can charge the batteries by connecting to a PC's USB port. When charging, be sure to correctly place the rechargeable batteries (supplied) into the recorder (P.10).

Do not charge primary batteries such as alkaline or lithium batteries. It may cause battery leakage heating and recorder malfunction.

- 1 **Boot the PC.**
- 2 **Slide the USB connector slide lever in the direction indicated by the arrow to eject the USB connector out of the recorder.**

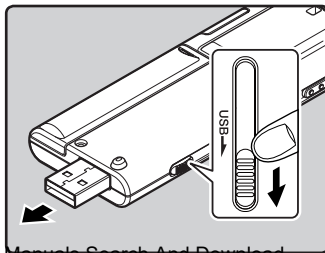

- 3** Make sure that the recorder is stopped, and connect to the PC's USB port.

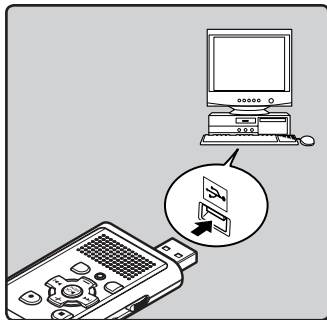

- 4** Press the OK ►/MENU button to start charging.



- 5** Charging is completed when battery indication becomes to [F].

Charging time: approximately 3 hours *

* It shows the approximate time when charging the rechargeable battery fully from no remaining power at the room temperature. The charging time will be changed depending on the remaining amount and the state of batteries.



Connect to the USB connecting AC adapter (optional) to charge

! For WS-710M/WS-700M:

It can be charged by connecting to the USBconnecting AC adapter (A514) (optional).

- 1** Connect the recorder to the AC adapter's USB port.

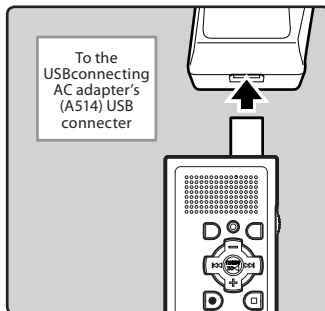

- 2** Connect the AC adapter to a household power outlet.

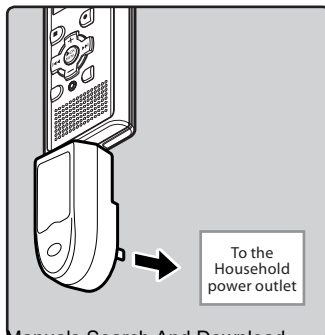

1

Power supply

EN

13

3 Press the **OK ►/MENU** button to start charging.



- If **[USB Connect]** has not been set to **[AC Adapter]**, **[Please wait]** will continue to be displayed (☞ P.61).

4 Charging is completed when battery indication becomes to **[F]**.

Notes

- The recorder cannot be charged when the PC is not turned on. Also, it may not be charged when the PC is not switched on, or when it is in the standby, hibernate or sleep mode.
- Do not charge the recorder with the USB hub connected.
- Insert the supplied rechargeable battery and set **[Battery]** to **[Ni-MH]**. If **[Battery]** is set to **[Alkaline]**, you cannot recharge (☞ P. 12).
- You cannot charge when **[C]***1 or **[H]***2 blinks. Charge the batteries at the temperature from 5°C to 35°C (41°F to 95°F).
 - *1 **[C]**: When surrounding temperature is low.
 - *2 **[H]**: When surrounding temperature is high.
- When using time becomes notably short even after the batteries are fully charged, replace them with new ones.
- Be sure to push the USB connector all the way in. Otherwise, the recorder may not operate properly.
- Use the supplied USB extension cable depending on situations.

- Do not use USB extension cables other than the supplied cable. Using cables from other manufacturers could result in damage to the recorder. Do not use the supplied USB extension cable with devices from other manufacturers.

Cautions concerning the rechargeable batteries

Read the following descriptions carefully when you use the Ni-MH rechargeable batteries.

Discharging:

The rechargeable batteries self-discharge while this is not in use. Be sure to charge them regularly before use.

Operating temperature:

The rechargeable batteries are chemical products. The rechargeable batteries efficiency may fluctuate even when operating within the recommended temperature range. This is an inherent nature of such products.

Recommended temperature range:

When operating appliance:

0°C - 42°C / 32°F - 107.6°F

Charging:

5°C - 35°C / 41°F - 95°F

Storage for a long period:

-20°C - 30°C / -4°F - 86°F

Using the rechargeable batteries outside the above temperature range may result in declining efficiency and shorter battery life. In order to prevent battery leakage or rust, remove the rechargeable batteries from the products when you will not be using them for a long time, and store them separately.

Notes

- This recorder is designed to fully charge batteries regardless of their energy level. However, for best results when charging newly purchased rechargeable batteries or batteries that have not been used for a long time (more than one month), it is recommended to fully charge the batteries then discharge repeatedly for 2 to 3 times.
- When disposing rechargeable batteries, always observe the local laws and regulations. Contact your local recycling center for proper disposal methods.
- If Ni-MH rechargeable batteries are not fully discharged, protect against short-circuiting (e.g. by taping the contacts) before disposing.

For customers in Germany:

Olympus has a contract with the GRS (Joint Battery Disposal Association) in Germany to ensure environmentally friendly disposal.

Turning on/off the power

When the recorder is not being used, turn the power off to reduce battery consumption to a minimum. Even if the power is turned off, existing data, mode settings, and clock settings will be maintained.

Turning on the power

While the recorder's power is off, slide the POWER/HOLD switch in the direction indicated by the arrow.

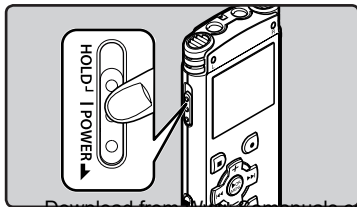

- The display will turn on, and the power will be turned on.
- The resume function will bring the recorder back to the stop position in memory before power was turned off.

Turning off the power

Slide the POWER/HOLD switch in the direction indicated by the arrow for 0.5 seconds or longer.

- The display shuts off, and the power will be turned off.
- The resume function remembers the stop position before the power is turned off.

Power save mode

If the recorder is on and stops for 10 minutes or longer (default), the display shuts off and it goes into power save mode (P.57).

- To exit power save mode, press any button.

HOLD

If you bring the recorder is set to HOLD mode, the running conditions will be preserved, and all buttons will be disabled. This feature is useful when the recorder has to be carried in a bag or pocket. Also, you can stop to prevent accident during recording.

Set the recorder to HOLD mode

1

HOLD

Slide the **POWER/HOLD** switch to the **[HOLD]** position.

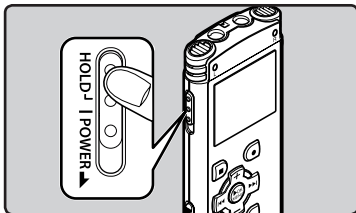

Exit HOLD mode

Slide the **POWER/HOLD** switch to the **(A)** position.

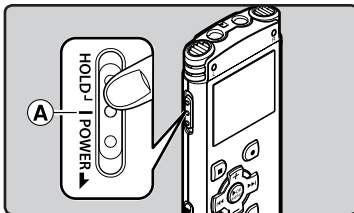

- After **[Hold]** appears on the display, the recorder is set to HOLD mode.

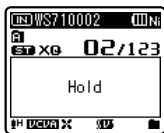

Notes

- If you press any button in HOLD mode, the clock display flashes for 2 seconds, but it will not operate the recorder.
- If HOLD is applied during playback (recording), operation is disabled with the playback (recording) state unchanged (When playback has ended and the recording has ended due to the remaining memory being used up, it will stop).

Setting time and date [Time & Date]

If you set the time and date beforehand, the information when the file is recorded is automatically stored for each file. Setting the time and date beforehand enables easier file management.

When you use the recorder for the first time after purchasing it, or when the batteries have been inserted without the device having been used in a long time, the [Set Time & Date] will appear. When the "Hour" is flashing, conduct the setup from Step 1.

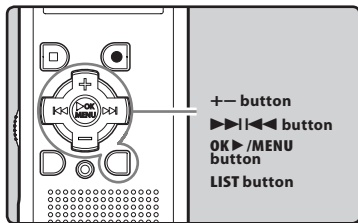

1 Press the >>>| or |<<< button to select the item to set.

- Select the item from the "Hour", "Minute", "Year", "Month" and "Day" with a flashing point.



2 Press the + or - button to set.

- Follow the same steps by pressing the >>>| or |<<< button to select the next item, and press the + or - button to set.
- You can select between 12 and 24 hour display by pressing the LIST button while setting the hour and minute.

Example: 10:38 P.M

10:38 PM (Initial setting) ←→ 22:38

- You can select the order of the "Month", "Day" and "Year" by pressing the LIST button while setting them.

Example: July 15, 2010

7M 15D 2010Y (Initial setting)

↓
15D 7M 2010Y

↓
2010Y 7M 15D

3 Press the OK >/MENU button to complete the setting.

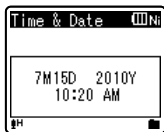

- The clock will start from the set date and time. Press the OK >/MENU button according to the time signal.

Note

- If you press the OK >/MENU button during the setup operation, the recorder will save the items that were set to that point.

Changing the time and date

While the recorder is during stop mode, press and hold the **STOP** (■) button to display the **[Time & Date]** and **[Remain]**. If the current time and date is not correct, set it using the procedure below.

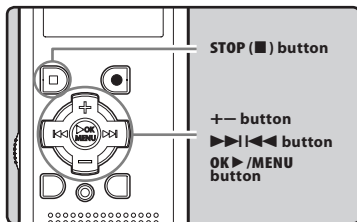
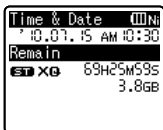

1 While the recorder is during stop mode, press and hold the **OK ►/MENU** button.

- The menu will appear on the display (☞ P.47).

2 Press the **+** or **-** button to select **[Device Menu]** tab.

- You can change the menu display by moving the settings tab cursor.



3 Press the **OK ►/MENU** or **▶▶▶** button to move the cursor to the item to set.

- [Device Menu]** will appear on the display.

4 Press the **+** or **-** button to select **[Time & Date]**.



5 Press the **OK ►/MENU** or **▶▶▶** button.

- [Time & Date]** will appear on the display.
- The "Hour" will flash on the display, indicating the start of the Time and Date setup process.



The following steps are the same as Step 1 through Step 3 of "Setting time and date [Time & Date]" (☞ P.17).

6 Press the **STOP** (■) button to close the menu screen.

Inserting and ejecting a microSD card

! For WS-710M/WS-700M:

The “microSD” indicated in the instruction manual refers to both microSD and microSDHC. This recorder can be used with commercially available microSD cards as well as the built-in memory.

Inserting a microSD card

- 1** While the recorder is during stop mode, open the card cover.

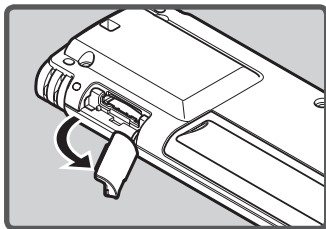

- 2** Face the microSD card the correct way and insert it into the card slot as shown in the diagram.

- Insert the microSD card keeping it straight.

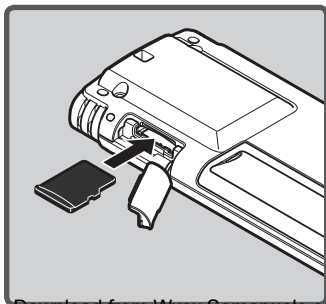

- Inserting the microSD card the wrong way or at an angle could damage the contact area or cause the microSD card to jam.
- If the microSD card is not inserted all the way, data may not be written to the microSD card.

- 3** Close the card cover securely.

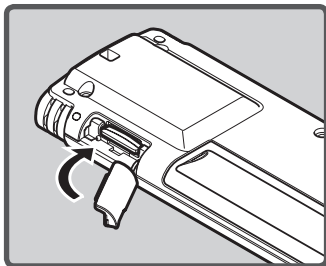

- When you insert the microSD card, the recording media changeover display will appear.

- 4** When you are recording to a microSD card, press the + or - button and select [Yes].



- 5** Press the OK ►/MENU button to complete the setting.

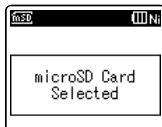

1

Inserting and ejecting a microSD card

EN

19

Notes

- It is possible to switch the recording media over to the built-in memory (P.47, P.57).
- In some cases microSD card which have been formatted (initialized) by another device, such as a computer, cannot be recognized. Be sure to format them with this recorder before using (P.63).

1

Inserting and ejecting a microSD card

Ejecting a microSD card

- 1 While the recorder is during stop mode, open the card cover.
- 2 Push the microSD card inward to unlock it, and let it eject partially.

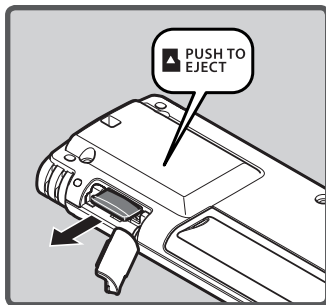

- The microSD card is visibly out of the slot and can be removed safely.
- If you eject the microSD card when the memory is selected to [microSD Card], it will automatically changed to [Built-in Memory Selected].



3 Close the card cover securely.

Notes

- Releasing your finger quickly after pushing the microSD card inward may cause it to eject forcefully out of the slot.
- Before inserting the microSD card, turn off the write protection function. Check the Olympus website regarding microSD cards which are confirmed operation with this recorder.
- This recorder may not recognize correctly on some microSD cards which are not compatible with this recorder.
- In the case when the microSD card cannot be recognized, remove the microSD card then put it in again to see if this recorder recognizes the microSD card.
- The processing performance reduces in a microSD card when you repeat writing and delete. In this case, format the microSD card (P.63).

[Home] display operations

! For WS-710M/WS-700M:

As well as an voice recorder and a music player, you can also use the recorder as a radio*.

* For WS-710M only.

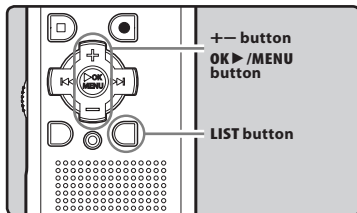

1 Press the LIST button repeatedly to set the [Home] display.

- [Home] will appear on the display.



2 Press the + or – button to select the mode.



3 Press the OK ►/MENU button.



When [Recorder] is selected:

The recorder will go into [Recorder] mode. You will be able to record and playback files recorded by the recorder (e.g. P.25, P.31).

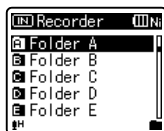

When [Music] is selected:

The recorder will go into [Music] mode, and you will be able to playback music files transferred to the recorder (e.g. P.31).



When [FM Radio]* is selected:

The recorder will go into [FM Radio] mode, and you will be able to receive FM radio (e.g. P.41, P.42).

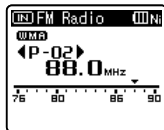

* For WS-710M only

Note

- During recording, you cannot switch the mode without stopping the recorder.

Notes on the folders

The built-in memory or the microSD card can be used for the recording media (For WS-710M, WS-700M only). The voice files and the music files are separated into folders for voice recordings and folders for music playback that are organized in a branching tree-style and saved.

About the folders for voice recordings

[Folder A] - [Folder E] within the [Recorder] folder are the folders for voice recordings. When recording with this recorder, select any one of the five folders and then record.

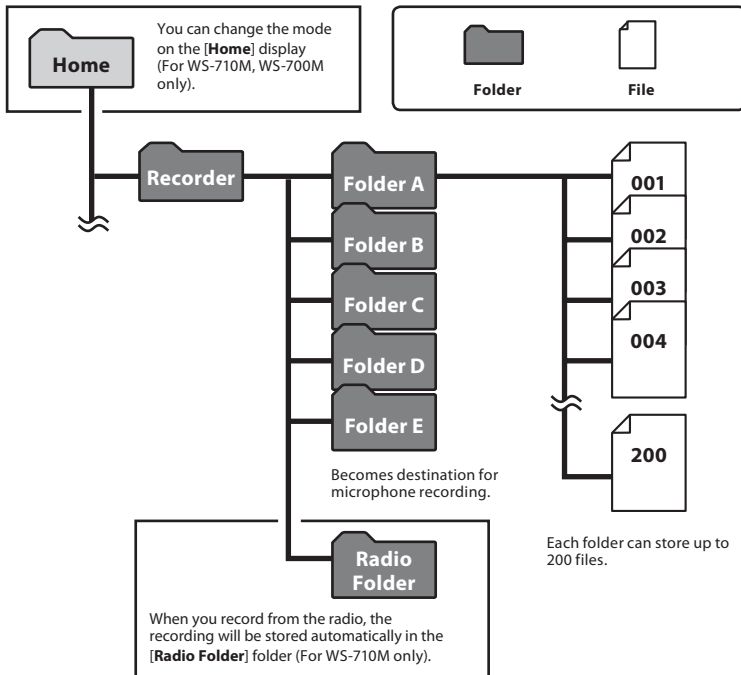

About the folder for music playback

! For WS-710M/WS-700M:

When transferring music files to the device using Windows Media Player, a folder is automatically created within the music playback folder which has a layered structure as shown in the diagram below. Music files that are in the same folder can be rearranged in preferential order and replayed (see P.59).

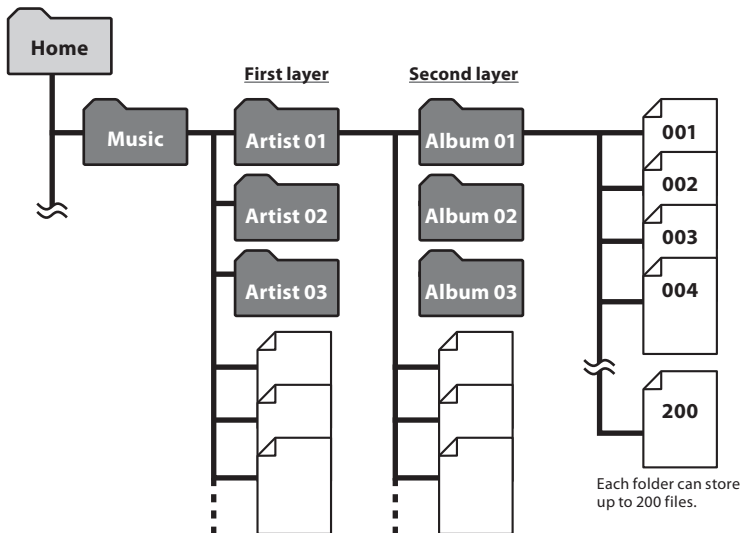

Up to 300 folders can be created under the [Music] folder, including [Music].

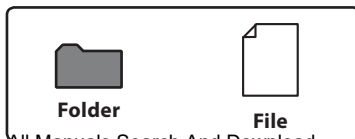

Selecting the folders and files

Change folders while the operation is stopped or played back. For information on the layered structure of the folders, see the section entitled "Notes on the folders" (P.22, P.23).

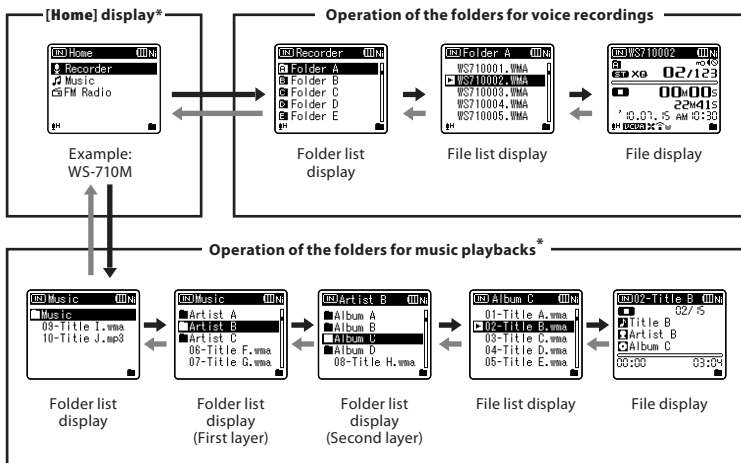

Moving through the levels

← Return: LIST button

Each time you press this it returns up one level. The list display can be operated by the **LIST** button.

- When you press and hold the **LIST** button while moving in a hierarchy of folders, it will return to the file display.

→ Proceed: OK / MENU button

Each time you press this it opens the folder or file selected in the list display and proceeds down one level.

- The list display screen can be operated by the **OK** button.

+ or - button

Select the folder or file.

[Home] display*:

Allows the mode of the recorder to be changed (P.21).

File display:

Information of the selected file is displayed. Enters in playback standby mode.

List display:

The folders and files recorded in this recorder are displayed.

* For WS-710M, WS-700M only

About recording

Recording

Before starting recording, select a folder between [A] to [E]. These five folders can be selectively used to distinguish the kind of recording; for example, Folder [A] might be used to store private information, while Folder [E] might be dedicated to holding business information.

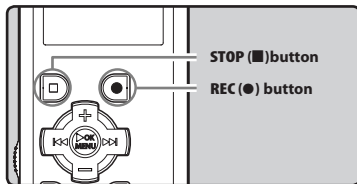

! For WS-710M/WS-700M:

- In modes other than [Recorder] mode, [Cannot record in this folder] will appear if you press the REC (●) button. Only record after you have set the mode to [Recorder] mode on the [Home] display (☞ P.21).
- With the WS-710M, you can record FM radio in [FM Radio] mode (☞ P.46).

1 Select the recording folder (☞ P.22 to P.24).

2 Press the REC (●) button to start recording.

- The recording indicator light glows and [●] will appear on the display.
- Turn the microphone in the direction of the source to be recorded.



- a) Recording mode
 - b) Remaining memory bar indicator
 - c) Elapsed recording time
 - d) Remaining recording time
 - e) Level meter (change according to the recording level and recording function settings)
- [Rec Mode] cannot be changed in the recording standby mode or while recording. Configure this while the recorder is stopped (☞ P.47, P.49).

3 Press the STOP (■) button to stop recording.

- [■] will appear on the display.



f) File length

Notes

- To ensure that you do not lose the beginning of the recording, only record after confirming that the recording indicator light is lit and checking the mode indicator on the display.
- When remaining recording time is less than 60 seconds, the recording indicator light starts flashing. When the recording time is decreasing to 30 or 10 seconds, the light flashes faster.
- [Folder Full] will appear when the recording cannot be made any further. Select on other folder or delete any unnecessary files before recording (☞ P.39).
- [Memory Full] will appear when the memory is full. Delete any unnecessary files before recording any further

For WS-710M, WS-700M only:

- We recommend formatting the record media in the recorder before recording (see P.63).
- When a microSD card is inserted in the recorder, be sure to confirm the recording media as either **[Built-in Memory]** or **[microSD Card]** so that there is no mistake (see P.47, P.57).
- If the **REC (●)** button is pressed when a function other than the record function is specified, **[Cannot record in this folder]** is displayed. Select a folder from **[Folder A]** through **[Folder E]** and start recording again.

Settings relating to Recording

[Mic Sense] (see P.47, P.49)	Sets the recording sensitivity.
[Rec Mode] *1 (see P.47, P.49)	Sets the recording rate for each recording format.
[Zoom Mic] *2 (see P.47, P.50)	Sets the directivity of the builtin stereo microphone
[Low Cut Filter] (see P.47, P.50)	This function can reduce noise from air conditioners, projectors and other similar noises.
[VCVA] (see P.47, P.50)	Sets the threshold level for the Variable Control Voice Actuator (VCVA).
[V-Sync. Rec] (see P.47, P.51)	Sets the start level for voice sync recording.
[Rec Scene] (see P.47, P.52)	Sets the recording settings which matches the recording condition or environment.

*1 For WS-710M (In **[FM Radio]** mode, the only setting of the **[Rec Mode]** settings you can change is the recording file format).

*2 For WS-710M only.

Pause

While the recorder is during recording mode, press the REC (●) button.

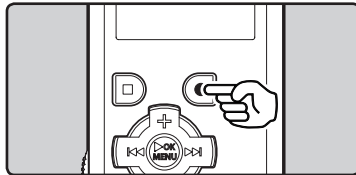

- **[⏸]** will appear on the display.
- The recorder will time out after 60 minutes when left in **[Rec Pause]**.

Resume Recording:

Press the REC (●) button again.

- Recording will resume at the point of interruption.

To quickly check on the recorded contents

While the recorder is during recording mode, press the OK ►/MENU button.

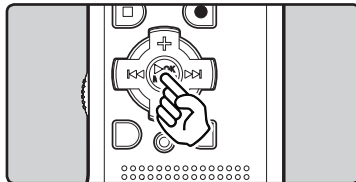

- **[▶]** will appear on the display.
- When operating in **[Recorder]** mode, the last file recorded using the microphone will be play back.
- When operating in **[FM Radio]** mode, the recorder will automatically enter **[Recorder]** mode, and the last file recorded from the FM radio will play back.

Listening while audio is recorded

If you start recording after inserting the earphone into the **EAR** jack on the recorder, you can hear the sound being recorded. The recording monitor volume can be adjusted by pressing the + or – button.

Connect the earphone to the EAR jack on the recorder.

- After recording has started, you can hear the sound being recorded through the earphone.

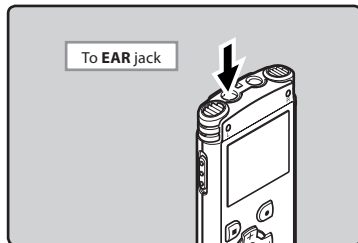
**Notes**

- Recording level cannot be controlled using the volume button.
- When using the earphones, do NOT set the volume too high. Listening at very high volume may lead to hearing loss.
- Do not place earphones near a microphone as this may cause feedback.
- When the external speaker is connected while recording, there is a risk that audio feedback will occur.

Changing the recording scene
[Rec Scene]

You can easily change the recording settings by selecting the scene which best matches your usage (P.47, P.52).

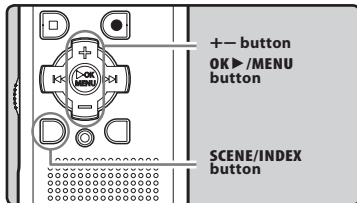

- While the recorder is during stop mode, press and hold the **SCENE/INDEX** button.
- Press the + or – button to select **[Rec Scene]**.



- Press the **OK >/MENU** button.
- Press the + or – button to select the recording scene.



- Press the **OK >/MENU** button.

Recommended settings by recording condition

The recorder is initially set to [ST XQ] (WMA format) mode so that you can make high quality stereo recordings immediately after purchasing it. The various functions relating to recording can be configured in detail to suit the recording conditions. The following table shows the recommended settings for some example recording conditions.

Recording condition	Recommended settings			
	[Rec Mode] ([Ⓔ] P.47, P.49)	[Mic Sense] ([Ⓔ] P.47, P.49)	[Low Cut Filter] ([Ⓔ] P.47, P.50)	[Zoom Mic]*1 ([Ⓔ] P.47, P.50)
Lectures in large rooms.	[PCM]: [44.1kHz/16bit]*2 [MP3]: [128kbps] or more [WMA]: [ST XQ]	[Hight]		[+6]
Conferences with large crowds.				
Meetings and business negotiations with a small number of people.	[MP3]: [128kbps] [WMA]: [ST XQ]	[Middle]	[On]	[Off]
Dictation with a lot of background noise.	[WMA]: [HQ]	[Low]		
Music playing, wild birds singing, and railway sounds.	[PCM]: [44.1kHz/16bit]*2	Set the microphone sensitivity according to the volume being recorded.	[Off]	

*1 For WS-710M only. *2 For WS-710M, WS-700M only. *3 For WS-600S only.

File names will be automatically created for files recorded by this recorder.

WS71 0001 .WMA

①

②

③

① User ID:

The user ID name that has been set on the Digital Voice Recorder.

② File number:

A file number is consecutively assigned regardless of the changes in the recording media.

③ Extension:

These are the file name extensions for the recording format when recording with this device.

- Linear PCM format* .WAV
- MP3 format .MP3
- WMA format .WMA

* For WS-710M, WS-700M only.

Recording from external microphone or other devices

The external microphone and other devices can be connected and the sound can be recorded. Connect as follows by the device to be used.

- Do not plug and unplug devices into the recorder's jack while it is recording.

Recording with external microphone: Connect an external microphone to the MIC jack of the recorder.

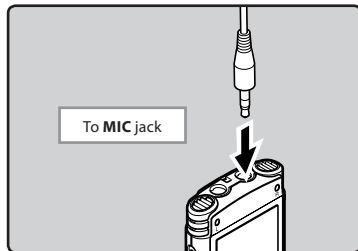

Applicable external microphones (optional) (E38 P.86)

Stereo microphone: ME51S

The built-in large-diameter microphone enables sensitive stereo recording.

2 channel microphone (omni-directional): ME30W

These are highly sensitive omni-directional microphones supported by plug-in power which are well-suited to recording musical performances.

Compact Gun Microphone (unidirectional): ME31

The directional microphones useful for recordings such as outdoor recording of wild birds singing.

Compact zoom microphone (unidirectional): ME32

The microphone is integrated with a tripod, making it suitable to place on a table and record conferences or lecture from a distance.

Highly sensitive noise-cancellation monaural microphone (unidirectional): ME52W

This microphone is used to record sound at a distance while minimizing surrounding noise.

Tie clip microphone (omni-directional): ME15

Small concealing microphone with a tie-clip.

Telephone pickup: TP7

Earphone type microphone can be plugged into your ear while phoning. The voice or conversation over the phone can be clearly recorded.

Notes

- The built-in microphone will become inoperable when an external microphone is plugged into the recorder's MIC jack.
- Microphones supported by plug-in power can also be used.
- When the external stereo microphone is used while **[Rec Mode]** is set to a monaural recording mode, audio will be recorded to the L channel only (E38 P.47, P.49).
- When an external monaural microphone is used while **[Rec Mode]** is set to a stereo recording mode, it enables recording only with the L channel microphone (E38 P.47, P.49).

Recording the sound of other devices with this recorder:

The sound can be recorded when connecting to the audio output terminal (earphone jack) of the other device, and the **MIC** jack of the recorder with the connecting cord KA333 (optional) for dubbing.

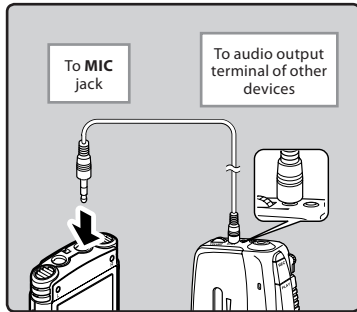

Note

- The detailed input levels cannot be adjusted with this recorder. When external devices are connected, perform a test recording and then adjust the output level for the external devices.

Recording the sound of this recorder with other devices:

The sound of this recorder can be recorded to other devices when connected to the audio input terminal (microphone jack) of other devices and the **EAR** jack of this recorder, with the connecting cord KA333 (optional) for dubbing.

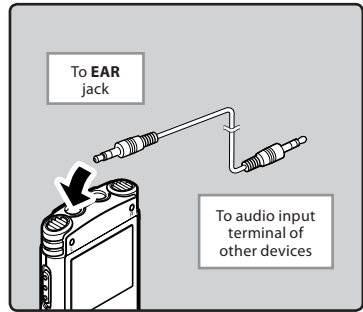

Note

- When you adjust the various sound quality settings related to playback on the recorder, the audio output signal sent out from the **EAR** jack will change as well (P.47, P.53, P.54, P.55).

About playback

Playback

The recorder can playback WAV*, MP3 and WMA format files. To playback a file recorded with other machines, you need to transfer (copy) it from a computer.

* For WS-710M, WS-700M only.

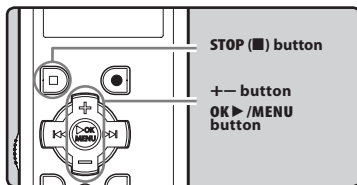

! For WS-710M/WS-700M:

- When you want to playback a file transferred from your PC, set the recorder in [Recorder] or [Music] mode based on where you have transferred the file.
- If you want to playback the file you recorded, set the recorder to [Recorder] mode (P.21).

- 1 Select the folder which contains the files to be played back (P.22 to P.24).**

- 2 Press the OK ►/MENU button to start playback.**

- [▶] will appear on the display.

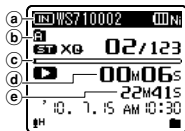

- Recording media indicator*, File name
- Folder indicator
- Playback position bar indicator
- Elapsed playback time
- File length

* For WS-710M, WS-700M only.

- 3 Press the + or – button to adjust to a comfortable listening volume.**

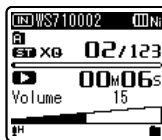

- The volume can be adjusted within a range from [00] to [30].

- 4 Press the STOP (■) button at any point you want to stop the playback.**

- [■] will appear on the display.
- This will stop the file being played back midway. When the resume function is activated the stopped location will be registered, even if the power is turned off. The next time the power is turned on, playback may be resumed from the registered stopped

Settings relating to playback

 For WS-710M/WS-700M:

[Noise Cancel]*1 (<small>ESP</small> P.47, P.53)	If recorded audio is difficult to understand because of noisy surroundings, adjust the Noise Cancel setting level.
[EUPHONY]*2 (<small>ESP</small> P.47, P.53)	The EUPHONY setting can be set to one of 4 levels according to your preference.
[Play Mode] (<small>ESP</small> P.47, P.54)	You can select the playback mode that fits your preference.
[Voice Filter]*1 (<small>ESP</small> P.47, P.54)	The recorder has a Voice Filter Function to cut low and high frequency tones during normal, fast, or slow playback, and enable clear audio playback.
[Equalizer]*2 (<small>ESP</small> P.47, P.55)	If you change the equalizer setting, you can enjoy the music with your favorite sound quality.
[Skip Space] (<small>ESP</small> P.47, P.55)	The skip interval length can be set.
[Play Scene] (<small>ESP</small> P.47, P.55)	Playback settings of your choice can be saved to suit different sound qualities and playback methods.

*1 Can be operated only in **[Recorder]** mode.

*2 Can be operated only in **[Music]** mode.

 For WS-600S:

[Play Mode] (<small>ESP</small> P.47, P.54)	You can select the playback mode that fits your preference.
[Voice Filter] (<small>ESP</small> P.47, P.54)	The recorder has a Voice Filter Function to cut low and high frequency tones during normal, fast, or slow playback, and enable clear audio playback.
[Skip Space] (<small>ESP</small> P.47, P.55)	The skip interval length can be set.
[Play Scene] (<small>ESP</small> P.47, P.55)	Playback settings of your choice can be saved to suit different sound qualities and playback methods.

Playback through earphone

An earphone can be connected to the **EAR** jack of the recorder for listening.

- When the earphone is used, the recorder speaker will be switched-off.

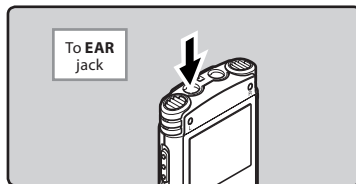

Notes

- To avoid irritation to the ear, insert the earphone after turning down the volume level.
- When you listen with the earphone during playback, do not raise the volume too much. It may cause hearing impairment and decrease in hearing ability.

Forwarding

While the recorder is during stop mode in the file display, press and hold the **▶▶** button.

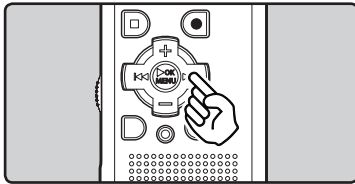

- [▶▶] will appear on the display.
- If you release the ▶▶ button, it will stop. Press the OK ▶/MENU button to start playback from where it was stopped.

While the recorder is during playback mode, press and hold the ▶▶ button.

- When you release the ▶▶ button the recorder will resume normal playback.
- If there is an index mark or temp mark in the middle of the file, the recorder will stop at that location (☞ P.35).
- The recorder stops when it reaches the end of the file. Continue pressing the ▶▶ button to proceed with the cue from the beginning of the next file.

Rewinding

While the recorder is during stop mode in the file display, press and hold the **◀◀** button.

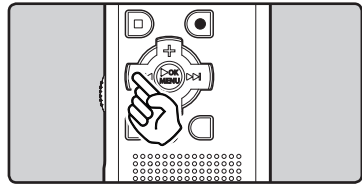

- [◀◀] will appear on the display.
- If you release the ◀◀ button, it will stop. Press the OK ▶/MENU button to start playback from where it was stopped.

While the recorder is during playback mode, press and hold the ◀◀ button.

- When you release the ◀◀ button the recorder will resume normal playback.
- If there is an index mark or temp mark in the middle of the file, the recorder will stop at that location (☞ P.35).
- The recorder stops when it reaches the beginning of the file. Continue pressing the ◀◀ button to proceed with the review from the end of the previous file.

Locating the beginning of the file

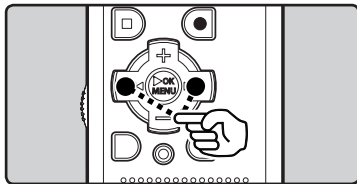

While the recorder is during stop mode or playback mode, press the **SKIP** button.

- The recorder skips to the beginning of the next file.

While the recorder is during playback mode, press the **SKIP** button.

- The recorder skips to the beginning of the current file.

While the recorder is during stop mode, press the **SKIP** button.

- The recorder skips to the beginning of the previous file. If the recorder stop the midway of the file, return to the beginning of the file.

While the recorder is during playback mode, press the **SKIP** button twice.

- The recorder skips to the beginning of the previous file.

Notes

- When you skip to the beginning of the file during playback, the recorder will stop at the position of the index mark and temp mark. The index mark and temp mark will be skipped when you perform the operation in stop mode (P. 35).
- When [Skip Space] set to other than [File Skip], the recorder will skip forward/reverse the specified time, then will start playback from the beginning of the file.

About music file

In cases where the recorder is unable to playback music files that have been transferred to it, check to make sure that the sampling rate and bit rate are in the range where playback is possible. Combinations of sampling rates and bit rates for music files which the recorder can playback are given below.

File format	Sampling frequency	Bit rate
WAV* format	44.1 kHz	16 bit
MP3 format	MPEG1 Layer3: 32 kHz, 44.1 kHz, 48 kHz MPEG2 Layer3: 16 kHz, 22.05 kHz, 24 kHz	From 8 kbps up to 320 kbps
WMA format	8 kHz, 11 kHz, 16 kHz, 22 kHz, 32 kHz, 44.1 kHz, 48 kHz	From 5 kbps up to 320 kbps

- * For WS-710M, WS-700M only.
- Variable bitrate MP3 files (in which conversion bitrates can vary) may not playback properly.
- For WAV files, this recorder can only playback those in the linear PCM format. WAV files other than these cannot be played back.
- This recorder is compatible with Microsoft Corporation DRM9, but not with DRM10.
- Even if the file is a compatible format to playback on the recorder, the recorder does not support every encoder.

Setting an index mark or a temp mark

If index marks and temp marks are placed, you can quickly find a location you want to listen to in fast forward and fast rewind and when cuing a file. Index marks can only be placed on files created by Olympus voice recorders, but temp marks can be placed instead to temporarily remember desired locations.

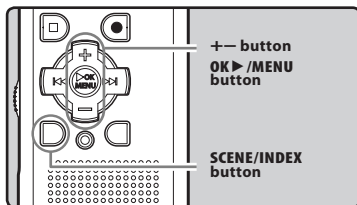

1 While the recorder is during recording mode or playback mode, press the SCENE/INDEX button.

- A number appears on the display and an index mark or temp mark will be placed.



- Even after an index or temp mark is placed, recording or playback will continue so you can place index or temp marks in other locations in a similar manner.

Clearing an index mark or a temp mark

- 1 Locate the index or temp mark you want to clear.
- 2 Press the **▶▶** or **◀◀** button to select the index or temp mark to erase.

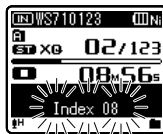

- 3 While the index or temp number appears for approximately 2 seconds on the display, press the **ERASE** button.

- The index or temp mark is erased.



- Index or temp numbers after the erased index or temp number will automatically move up.

Notes

- Temp marks are temporary markings, so if you transmit a file to the PC, or move it with a PC, they will be automatically erased.
- Up to 16 index and temp marks can be set in a file. If you try to place more than 16 index or temp marks, **[Index Full]** message will appear for index marks, and **[Temp Mark Full]** for temp marks.
- Index or temp marks cannot be set or erased in a locked file (see P.47, P.49).

Changing the playback speed

Change the speed according to need such as listening to meeting content at a fast speed or reviewing spots that you couldn't catch in a language lesson at a slow speed. The tone will be automatically adjusted digitally without changing the voice so it sounds natural.

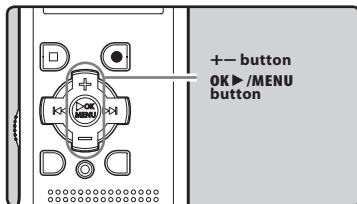

3
Playback

- 1 While the recorder is during playback mode, press the **OK ►/MENU** button.



- 2 Press the **+** or **-** button to select playback speed.



- 3 Press the **OK ►/MENU** button.

- a Playback speed indicator



- Even if playback is stopped, the changed playback speed will be retained. The next playback will be at that speed.

About the limits of fast playback

When the sampling frequency of the playback file is 48 kHz or 32 kHz, you cannot play back at 3-times speed. For these frequencies, the maximum fast playback speed is 2-times*.

* On the WS-600S, the maximum fast playback is 2-times.

Notes

- As in normal playback mode, you can stop playback, cue a file, or insert an index mark in slow playback and fast playback modes as well (☞ P.35).
- The slow playback or fast playback is available even if either [Voice Filter] or [Equalizer] is set (☞ P.47, P.54, P.55).

For WS-710M, WS-700M only:

- The slow playback or fast playback is not available if either [Noise Cancel] or [EUPHONY] effect is set (☞ P.47, P.53).

How to begin segment repeat playback

This function enables repeated playback of part of the file being played.

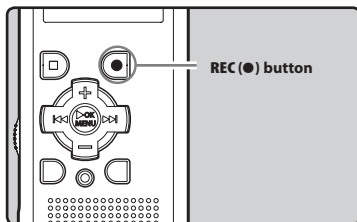

- 1 Select a file that has a segment you would like to playback repeatedly, and start playback.
- 2 Press the REC (●) button at the point you want to start segment repeat playback.

- [A] will flash on the display.

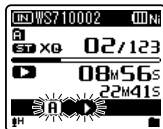

- You can fast forward, rewind, or change playback speed as you can operate in normal mode, when [A] is flashing to find the end position (see P.33, P.36).
- When it reaches to the end of the file while [A] is flashing, the point will become the end position, and repeat playback will start.

- 3 Press the REC (●) button again at the position where you want to end segment repeat playback.

- The recorder repeatedly plays back the segment until the segment repeat playback is cancelled.



Note

- As in normal playback mode, playback speed can be changed during segment repeat playback as well (see P.36). If an index mark and temp mark are inserted or eliminated during segment repeat playback, segment repeat playback will be canceled and it will return to normal playback mode (see P.35).

Cancel the segment repeat playback function

Pressing any of the following buttons will release the segment repeat playback.

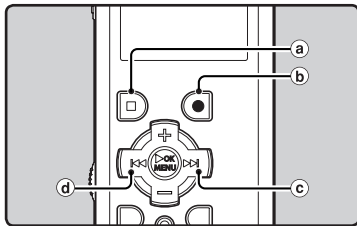

- a **Press the STOP (■) button**
Pressing the **STOP (■)** button will release segment repeat playback, and stop playback.
- b **Press the REC (●) button**
Pressing the **REC (●)** button will release segment repeat playback, and playback continues without repeating.
- c **Press the ►► button**
Pressing the **►►** button will release segment repeat playback, and fast forward and cue to the beginning of the next file.
- d **Press the ◀◀ button**
Pressing the **◀◀** button will release segment repeat playback, and reverse to the beginning of the current file.

Changing the playback scene [Play Scene]

When you register playback settings for preferred playback scenes, you can easily change between playback functions (see P.47, P.55).

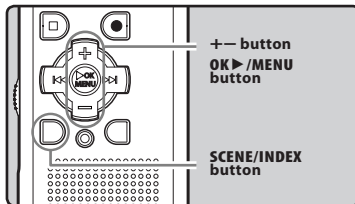

- 1 **While the recorder is during stop mode or playback mode, press and hold the SCENE/INDEX button.**
- 2 **Press the + or – button to select [Play Scene].**

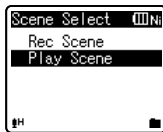

- 3 **Press the OK ►/MENU button.**
- 4 **Press the + or – button to select the playback scene.**



Example:
WS-710M, WS-700M

- For WS-600S, you can select from [Voice 1] to [Voice 5].

- 5 **Press the OK ►/MENU button.**

Erasing

Erasing files

A selected file can be erased from a folder. Also, all files in a folder can be erased simultaneously.

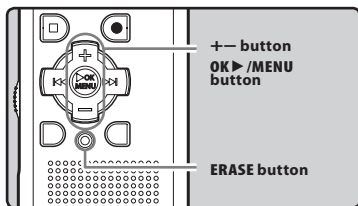

- 1 Select the file you want to erase (see P.22 to P.24).
- 2 While the recorder is during stop mode in the file display, press the ERASE button.
- 3 Press the + or – button to select [Erase in Folder] or [File Erase].

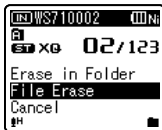

- 4 Press the OK ►/MENU button.
- 5 Press the + button to select [Start].



- 6 Press the OK ►/MENU button.

- The display changes to [Erase!] and erasing will start.
- [Erase Done] is displayed when the file is erased. File numbers will be reassigned automatically.



Erasing a folder



For WS-710M/WS-700M:

You can erase files by deleting folders.

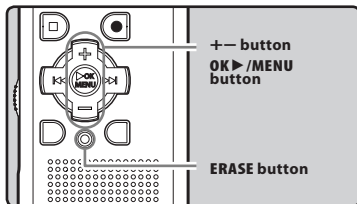

- 1 Select the folder you want to erase (see P.22 to P.24).
- 2 While the recorder is during stop mode in the folder list display, press the ERASE button.

3 Press the + button to select [Start].



4 Press the OK ►/MENU button.

- The display changes to [Erase!] and erasing will start.
- [Erase Done] is displayed when the file is erased. File numbers will be reassigned automatically.

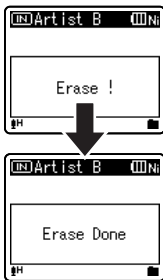

Notes

- You cannot recover a file once it has been erased. Please check carefully before erasing.
- The locked files and files set as read-only cannot be erased (P.47, P.49).
- If an action is not selected within 8 seconds, the recorder will return to stop status.
- If there is a file that cannot be recognized by the recorder, the file and the folder which contains that file will not be erased. Please connect the record to your PC to erase.

For WS-710M, WS-700M only:

- When a microSD card is inserted in the recorder, be sure to confirm the recording media as either [Built-in Memory] or [microSD Card] so that there is no mistake (P.47, P.57).
- It may take over 10 seconds to complete processing. Never perform operations such as the following while processing, as they may damage the data. In addition, replace the battery with a new one in order to ensure that the battery will not run out while processing.
 - ① Disconnecting the AC Adapter while processing.
 - ② Removing the battery while processing.
 - ③ Remove the microSD card during processing when [microSD Card] is being used as the recording media.
- The default folders of the recorder, namely [Recorder], including [Folder A] to [Folder E] and [Radio Folder]) and [Music] cannot be erased.
- In the [Music] folder, all folders except [Music] can be deleted.

For WS-600S only:

- It may take over 10 seconds to complete processing. Never perform operations such as the following while processing, as they may damage the data. In addition, replace the battery with a new one in order to ensure that the battery will not run out while processing.
 - ① Disconnecting the AC Adapter while processing.
 - ② Removing the battery while processing.
- You cannot delete folders through the recorder.

About the FM radio (For WS-710M only)

Using the FM radio

! For WS-710M:

Radio reception will vary substantially depending on where you are using the radio. If the reception is poor, adjust the antenna position or orientation, or place the recorder in a location where a radio signal can be easily received, such as by a window.

The recorder may not be able to receive the FM signal within or close to buildings



Move to a location where the signal can be easily received. Inside a building, broadcast signals will be more easily received near windows.

Connecting the earphones

The supplied earphones function as an FM antenna. You will not be able to receive FM radio signals if the earphones are not connected.

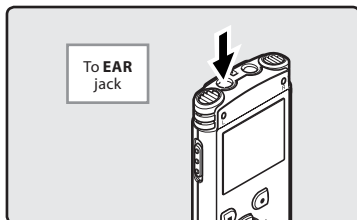

- Also note that you will not be able to receive radio signals in locations not reached by radio waves, such as areas outside the broadcast region and areas surrounded by mountains.

Notes

- Even within the broadcast region, radio signals may be difficult to receive in tunnels or underground roads, inside or in the shadow of buildings and apartment blocks covered with a concrete structures, and other similar locations. You may not be able to get radio reception in these locations.
- For best reception, avoid using the radio at the same time as a cellular phone, PC, television or other electrical product. Such products may cause noise.
- If you use the radio while connected to the AC adapter (A514 etc.), noise may be generated. When using the FM radio, be sure to use the battery.

FM radio mode operations

4

FM radio mode operations

! For WS-710M:

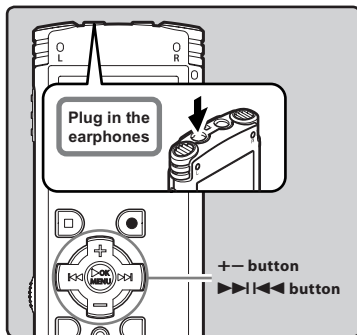

1 Set to [FM Radio] mode (☞ P.21).

- Change the mode to [FM Radio] mode.

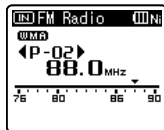

- To stop FM radio reception, press the **LIST** button to go to the [**Home**] display. From the [**Home**] display, you can change to a different mode.

2 Presetting radio stations.

Presetting radio stations automatically:

Automatically preset stations to make it easy to tune. For details, see "**Presetting radio stations automatically [Auto-preset]**" (☞ P.43).

Adding a radio station to the presets:

Change the reception mode to manual reception, and adjust the frequency. The station you are tuned to can then be added (☞ P.44, P.45).

3 Press the >>> or <<< button to select a station.

- You can select a preset station.

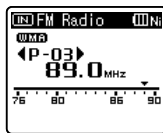

- You can also select a station which have not been preset. For details, see "**Changing the reception mode**" (☞ P.44).

4 Press the + or - button to adjust to a comfortable listening volume.

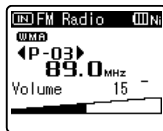

- The volume can be adjusted within a range from [00] to [30].

Settings relating to FM radio

[Auto-preset] (☞ P.43)	Automatically adds receivable stations to the presets.
[Scan sense] (☞ P.47, P.59)	Allows you to set the scan sensitivity for auto preset.
[Output] (☞ P.47, P.59)	Allows you to set the audio output of the FM radio.

EN

42

Presetting radio stations automatically [Auto-preset]

Presetting stations makes it easy to find your desired station.

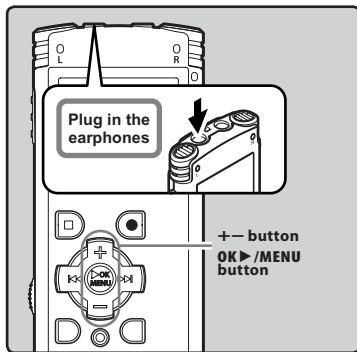

1 Set to [FM Radio] mode (☞ P.21).

2 Press and hold the OK >/MENU button.

- The menu will appear on the display (☞ P.47)



3 Press the OK >/MENU or >>> button to move the cursor to the item to set.



4 Press the + or - button to select [Auto-preset].



5 Press the OK >/MENU button.

- [Auto-preset] will appear on the display.

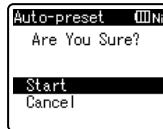

- Select [Cancel] and press the OK >/MENU button to return to the previous display.

6 Press the OK >/MENU button again.

- [Scanning] will appear on the display and scanning will start. When [Preset complete] appears, the scan is complete.

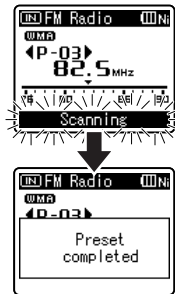

Note

- The preset numbers will be automatically assigned according to frequency.

Changing the reception mode

Select the reception mode according to reception conditions. If the signal from the station you are looking for is weak and cannot be detected using Auto Preset, change to manual reception and fine tune the frequency.

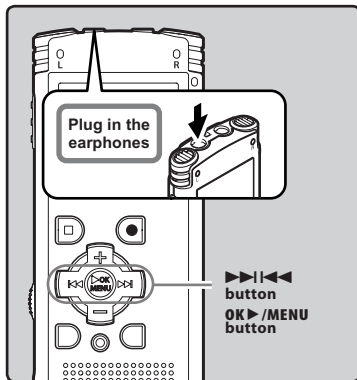

4

FM radio mode operations

1 Perform Steps 1 through 3 from “FM radio mode operations” (P.42).

2 Press the OK ►/MENU button to select a reception mode.

- The reception mode will change on each press of the **OK ►/MENU** button

Preset call mode:

- Press the ►► or ◀◀ button to select a preset station.

Ⓐ Preset number

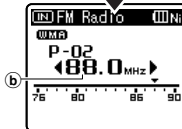
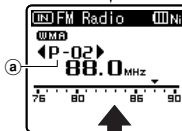

Auto/Manual mode:

- Press the ►► or ◀◀ button to adjust the frequency and receive a signal (Manual reception).
- Repeatedly press the ►► or ◀◀ buttons to scan through the receivable stations (Auto reception).

Ⓑ Tuning frequency

Adding a radio station

You can add stations from Auto/Manual reception to the presets.

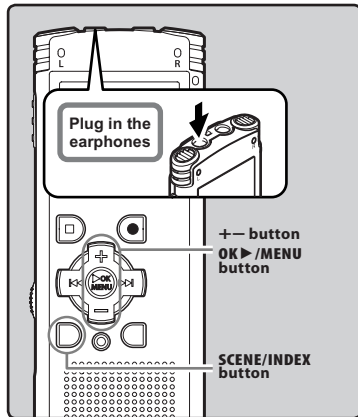

1 Receive a radio station to preset.

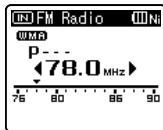

2 Press the SCENE/INDEX button.

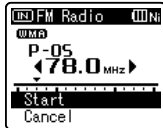

- Select [**Cancel**] and press the **OK >/MENU** button to return to the previous display.

3 Press the OK >/MENU button.

- Up to 30 stations can be preset.



Deleting a radio station

1 Receive the preset station you wish to erase.

2 Press the ERASE button.



- Select [**Cancel**] and press the **OK >/MENU** button to return to the previous display.

3 Press the OK >/MENU button.



Note

- The preset numbers will be automatically assigned according to frequency.

Recording FM radio

! For WS-710M:

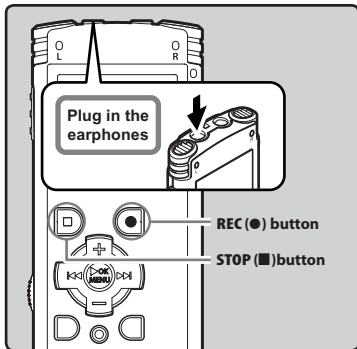

4

Recording FM radio

- 1 Receive the broadcast program you wish to record (see P.21, P.42).
- 2 In menu settings relating to FM radio, set [Output] to [Earphones] (see P.47, P.59).
 - If [Output] is set to [Speaker], you will not be able to record.
- 3 Press the REC (●) button to start recording.

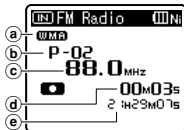

- The recording indicator light glows and  will appear on the display.
- a Recording format
 - b Preset number
 - c Tuning frequency
 - d Elapsed recording time
 - e Remaining recording time

When recording FM radio:

Even if the FM radio sounds good, certain reception conditions may cause noise once the recording has started. To ensure that there are no mistakes with the recording, make a test recording. Also, be sure to record in a location with the best possible reception.

4 Press the STOP (■) button to stop recording.

-  will disappear and the reception display will return.

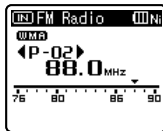

- When you record FM radio, the recording will be stored automatically in the [FM Radio] folder in the [Recorder] folder.

Notes

- When recording FM radio, be sure to connect the earphones to the **EAR** jack.
- When recording FM radio, the file name assigned when recording (see P.32) will be appended with a date and time.

WS710001_100715_0915.WMA

Date: [100715] (2010, July 15)

Time: [0915] (9.15 am)

EN

46

Menu setting

Menu setting method

Items in menus are categorized by tabs, so select a tab first and move to a desired item to quickly set it. You can set each menu item as follows.

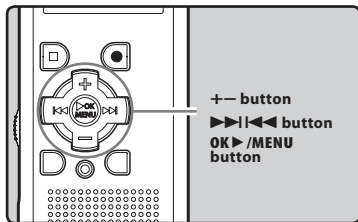

- 1 While the recorder is during stop mode, press and hold the **OK >/MENU** button.

- The menu will appear on the display.



- Menu items can be set during a recording or playback (☞ P.48).

- 2 Press the **+ or -** button to move to the tab that contains the item you want to set (☞ P.49 to P.64).

- You can change the menu display by moving the settings tab cursor.



- 3 Press the **OK >/MENU** or **>>>|<<<** button to move the cursor to the item to set.



- 4 Press the **+ or -** button to move to the item you want to set.



- 5 Press the **OK >/MENU** or **>>>|<<<** button.

- Moves to the setting of the selected item.

- 6 Press the **+ or -** button to change the setting (☞ P.49 to P.64).

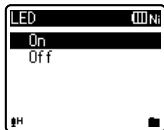

- 7 Press the **OK >/MENU** button to complete the setting.

- You will be informed that the settings have been established via the screen.

5

Menu setting method

EN

47



- Pressing the **◀◀** button without pressing the **OK▶/MENU** button will cancel the settings and return you to the previous screen.

8 Press the **STOP (■)** button to close the menu screen.

- When in the menu screen during recording or playback, pressing the **◀◀** or **STOP (■)** button will allow you to return to the playback screen without interrupting recording or playback.

5

Menu setting method

Notes

- The recorder will stop if you leave it idle for 3 minutes during a menu setup operation, when a selected item is not applied.
- When entering menu settings during recording or playback, the menu settings will be cancelled if 8 seconds elapse with no buttons being pressed.

■ Setting menu during recording:

Function	Setting
[Mic Sense]	
[Zoom Mic]*1	
[Low Cut Filter]	To menu item options
[VCVA]	
[Backlight]	
[LED]	

■ Setting menu during playback:

Function	Setting
[Property]	
[Noise Cancel]*2	
[EUPHONY]*3	
[Voice Filter]*4	
[Play Mode]	To menu item options
[Equalizer]*3	
[Skip Space]	
[Backlight]	
[LED]	

■ Setting menu during FM radio reception (For WS-710M only):

- During recording in [FM Radio] mode, only the [Backlight] and [LED] settings are possible.

Function	Setting
[Rec Mode]	
[Auto-preset]	
[Scan sense]	To menu item options
[Backlight]	
[LED]	
[Output]	

*1 For WS-710M only.

*2 For WS-710M, WS-700M only (It only works in [Recorder] mode).

*3 For WS-710M, WS-700M only (It only works in [Music] mode).

*4 It only works in [Recorder] mode.

File Menu

Erase Lock

Locking a file keeps important data from being accidentally erased. Locked files are not erased when you select to erase all files from a folder (☞ P.39).

[On]:

Locks the file and prevents it from being erased.

[Off]:

Unlocks the file and allows it to be erased.

Replace

Refer to "**Rearranging files [Replace]**" (☞ P.59).

File Divide

Refer to "**Dividing Files [File Divide]**" (☞ P.60).

Property

File and folder information can be confirmed from the menu screen.

When the file is selected:

[Name] (File name), **[Date]** (Time stamp), **[Size]** (File size), **[Bit Rate]*1** (File format), **[Artist]*2** (Artist name) and **[Album]*2** (Album name) will appear on the display.

*1 When a linear PCM format file has been selected, **[Bit Rate]** area displays the sampling frequency and bit rate.

*2 When a file contains no tag information, the display contents of this area are blank. When **[Recorder]** is selected, **[Artist]** and **[Album]** will not appear on the display.

When the folder is selected:

[Name] (File name), **[Folder]*1** (Number of folder) and **[File]*2** (Number of file) will appear on the display.

*1 When **[Recorder]** is selected, **[Folder]** will not appear on the display.

*2 Files which cannot be recognized by this recorder are not included in the number of files.

- Select the files for which you would like to confirm information in advance before operating the menu.

Rec Menu

Mic Sense

Microphone sensitivity is adjustable to meet recording needs.

[High]: Highest recording sensitivity suitable for recording at a distance or low volume, such as at conferences with a large number of people.

[Middle]: Suitable for recording meetings and seminars with a small number of people.

[Low]: Lowest recording sensitivity suitable for dictation.

- When you would like to clearly record a speaker's voice, set **[Mic Sense]** to **[Low]** and hold recorder's built-in stereo microphone close to the speaker's mouth (5-10 cm) when recording.

Rec Mode

The recorder can record in the linear PCM format (For WS-710M, WS-700M only). High resolution recording at a high sampling rate and high bit rate equivalent or superior to that of a music CD is possible. Moreover, it also supports the MP3 and WMA formats.

1 Select the recording format.

[PCM]*: This is an uncompressed audio format which is used for music CDs and the like.

[MP3]: MPEG is the international standard established by a working group of the ISO (International Organization for Standardization).

[WMA]: This is an audio compression encoding method that was developed by the Microsoft Corporation in the US.

* For WS-710M, WS-700M only.

2 Select the recording rate.**When [PCM] is selected:**

[44.1 kHz/16 bit]*1

When [MP3] is selected:[256 kbps]*1, [192 kbps]*2,
[128 kbps]**When [WMA] is selected:**

[ST XQ], [ST HQ], [ST SP], [HQ], [SP], [LP]

*1 For WS-710M, WS-700M only.

*2 For WS-600S only.

- To record a meeting and lecture clearly, set other than [LP] in [Rec Mode].
- When the external monaural microphone is used while [Rec Mode] is set to a stereo recording mode, it enables recording only with the L channel microphone.

Zoom Mic**5****For WS-710M:**

The directional microphone function utilizes DiMAGIC's (DiMAGIC Co., Ltd.) DiMAGIC Virtual Microphone (DVM) technology. DVM is an audio pickup system which allows you to record by focusing on sound from any direction. From expansive stereo recording to high directivity recording, DVM represents the latest in directional control methods that allow you to switch to a single exclusive microphone.

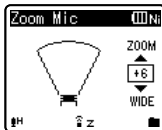

- When you increase the value, the directivity will narrow.
- Decreasing the value widens the directivity, enables you to record in a expansive stereo sound.
- If you reduce the directivity and widen the recording range, you can record in a sound

Low Cut Filter

The recorder has a Low Cut Filter function to minimize low-frequency sounds and record voices more clearly. This function can reduce noise from air conditioners, projectors and other similar noises.

[On]:

Enables the Low Cut Filter function.

[Off]:

Disables this function.

VCVA

When the microphone senses that sounds have reached a preset threshold volume level, the built-in Variable Control Voice Actuator (VCVA) starts recording automatically, and stops when the volume drops below the threshold level. The VCVA feature extends recording time and conserves memory by stopping recording during silent periods, which helps the playback to be more efficient.

[On]:

Enables the VCVA function. Will start recording in VCVA mode.

[Off]:

Disables this function. Will resume recording in normal mode.

- When [V-Sync. Rec] is set to [On], [VCVA] is disabled. To use this function, set [V-Sync. Rec] to [Off] (P.51).

Adjust the start/stop actuation level:**1 Press the REC (●) button to start recording.**

- When the sound volume is lower than the preset threshold sound level, recording automatically stops after 1 sec approximately, and [Standby] flashes on the display. The recording indicator light glows when recording starts and flashes when recording pauses.

2 Press the **▶▶▶** or **◀◀◀** button adjust the start/stop actuation level.

- The VCVA level can be set to any of 15 different values.
- The higher the value, the more sensitive the recorder to sounds. At the highest value, even the faintest sound will activate recording.



① Level meter (varies according to the sound volume being recorded)

② Start level (moves to the right/left according to the set level)

- The start/stop actuation level also varies depending on the selected microphone sensitivity mode (P.49).
- If the starting level is not adjusted within 2 seconds, the display will return to the previous.
- If the surrounding noise is loud, the starting sensitivity of the VCVA can be adjusted according to the recording situation.
- To ensure successful recordings, prior testing and adjustment of the start/stop actuation level is recommended.

V-Sync. Rec

Voice sync recording starts when a voice louder than the voice sync level (detection level) is detected. When the voice becomes quiet, recording will automatically stop. When voice sync recording is on and the input level falls below the voice sync level (detection level) for a period of at least the specified detection time, the recorder will stop.

1 Select the **[On]** or **[Off]**.

[On]: Enables the Voice sync recording function.

[Off]: Disables this function.

- If you select **[On]**, proceed to the operation of Step 2.

2 Sets the detection time.

[1 second] **[2 seconds]** **[3 seconds]**

[5 seconds] **[10 seconds]**:

If the input (recording level) is equal to or below the specified level for longer than the specified detection time, the recorder stops.

Adjust the voice sync level:

1 Press the **REC (●)** button to start recording.

- To use voice sync recording, set **[V-Sync. Rec]** to **[On]** and specify a detection time.

2 Press the **▶▶▶** or **◀◀◀** button adjust the voice sync level.

- The voice sync level can be set to any of 15 different values.
- The higher the value, the more sensitive the recorder to sounds. At the highest value, even the faintest sound will activate recording.

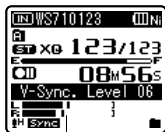

a

- a) Voice sync level (moves to the right/left according to the set level)

3 Press the REC (●) button again.

- The recorder will go into standby. **[Standby]** will flash on the display and the recording indicator light will flash.
- When the input is at or above the voice sync level, recording will start automatically.

5

4 Voice sync recording stops automatically.

- If sound at a volume below the voice sync level continues for the specified time, voice sync recording will end automatically, and the recorder will return to the standby mode of Step 3. Every time the recorder enters standby mode, the file will be closed and recording will continue in a different file.
- To stop the recorder during voice sync recording, press the **STOP** (■) button.
- When **[VCVA]** is set to **[On]**, **[V-Sync. Rec]** is disabled. To use this function, set **[VCVA]** to **[Off]** (P.50).

RecScene

The recording setting can be selected from the **[Lecture]**, **[Conference]**, **[Meeting]**, **[Dictation]** templates to suit the recording scene or situation. You can also save a recording setting of your choice.

1 Select **[Scene Select]** or **[Scene Save]**.

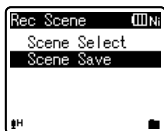

[Scene Select]: Select a recording scene from the templates to suit the recording scene and conditions. For details, see “**Template settings**” (P.53). Alternatively, select recording scene customized for a particular purpose.

[Scene Save]: You can save up to 3 sets of menu settings relating to a current recording.

- If you select **[Scene Select]**, proceed to the operation of Step 4.

When [Scene Save] is selected:

2 Set the recording settings according to your preferences.



3 Specify a save destination.

- You can select the save destination from **[User Setting 1]**, **[User Setting 2]** and **[User Setting 3]**.

When [Scene Select] is selected:

4 Select the recording scene.



Template settings:**[Lecture]:**

[Mic Sense]	[High]
[Rec Mode]	[MP3]: [128 kbps]
[Zoom Mic]*	[+6]
[Low Cut Filter]	[On]
[VCVA]	[Off]
[V-Sync. Rec]	[Off]

[Conference]:

[Mic Sense]	[High]
[Rec Mode]	[MP3]: [128 kbps]
[Zoom Mic]*	[Off]
[Low Cut Filter]	[On]
[VCVA]	[Off]
[V-Sync. Rec]	[Off]

[Meeting]:

[Mic Sense]	[Middle]
[Rec Mode]	[MP3]: [128 kbps]
[Zoom Mic]*	[Off]
[Low Cut Filter]	[On]
[VCVA]	[Off]
[V-Sync. Rec]	[Off]

[Dictation]:

[Mic Sense]	[Low]
[Rec Mode]	[WMA]: [HQ]
[Zoom Mic]*	[Off]
[Low Cut Filter]	[On]
[VCVA]	[Off]
[V-Sync. Rec]	[Off]

[DNS]:

For Dragon Naturally Speaking
(Nuance Communications Inc.)

* For WS-710M only

- If you select a recording scene, you will not be able change the above-described menu settings relating recording. If you wish to use these functions, set **[Rec Scene]** to **[Off]**.

To check the settings:

On the **[Scene Select]** display, select a recording scene using the + and - buttons, and press the **[Play]** button.

Press the **[Left Arrow]** button to return to the **[Scene Select]** display.

▶ Play Menu**Noise Cancel****! For WS-710M/WS-700M:**

If recorded audio is difficult to understand because of noisy surroundings, adjust the Noise Cancel setting level.

[High] **[Low]**: Enables the Noise Cancel function. Noise will be reduced in the file when it's played back for better sound quality.

[Off]: Disables this function.

- When **[Noise Cancel]** is set to **[Low]** or **[High]**, slow/high speed playback and **[Voice Filter]** will not function. To use these functions, set **[Noise Cancel]** to **[Off]** (see P.36, P.54).
- [Noise Cancel]** only works in **[Recorder]** mode.

EUPHONY**! For WS-710M/WS-700M:**

This recorder is equipped with "EUPHONY MOBILE", the latest in surround sound systems which combines bandwidth correction, expansion technology, and virtual acoustical source processing technology. In addition to its natural, expansive feel, the recorder is equipped with the exceptional feature wherein listeners are less prone to developing an compressed or closed-in feel, or to growing tired over extended listening. On top of this, listeners are less prone to developing an oppressed or closed-in feel, or to growing tired over extended listening. Level adjustments of the EUPHONY setting can be set to four stages according to preference.

Download from www.Sonmanuals.com. All Manuals Search And Download.

[Power]:

This mode focuses more on lower sound registers.

[Wide]:

This mode has an even more expansive feel.

[Natural]:

This mode achieves natural bandwidth correction and acoustical field expansion.

[Off]:

Disables this function.

- When **[EUPHONY]** is set to **[Power]**, **[Wide]** or **[Natural]**, slow/high speed playback will not function. To use these functions, set **[EUPHONY]** to **[Off]** (☞ P.36).
- **[EUPHONY]** only works in **[Music]** mode.
- When playing back using the built-in speaker, the EUPHONY function is disabled.

5

Voice Filter

The recorder has a Voice Filter Function to cut low and high frequency tones during normal, fast, or slow playback, and enable clear audio playback.

[On]:

Enables the Voice Filter function.

[Off]:

Disables this function.

For WS-710M, WS-700M only:

- When **[Voice Filter]** is set to **[On]**, **[Noise Cancel]** will not function. To use this function, set **[Voice Filter]** to **[Off]** (☞ P.53).
- **[Voice Filter]** only works in **[Recorder]** mode.

Play Mode

You can select the playback mode that fits your preference.

! For WS-710M/WS-700M:

- Set to **[Music]** mode.

Select the desired playback range:**1 Select [Play Area].****2 Select [File], [Folder] or [All].**

[File]: Selects the current file.

[Folder] Selects the current folder.

[All]: Selects all files in the internal memory.

Select the desired playback mode:**1 Select [Repeat] or [Random].**

[Repeat]: Sets to repeat playback mode.

[Random]: Sets to random playback mode.

2 Select [On] or [Off].

[On]: Sets the playback range to be played back repeatedly or randomly.

[Off]: Disables this function.

! For WS-710M/WS-700M:

- Set to **[Recorder]** mode.

! For WS-600S:

[File]: Stop after playing back the current file.

[Folder]: Play files continuously in the current folder until the last file and stop.

- In **[File]** mode, when the recorder comes to the end of the last file in the folder, **[End]** flashes for two seconds on the display and the recorder stops at the start of the last file.

- In [**Folder**] mode, when the recorder comes to the end of the last file in the folder, [**End**] flashes for two seconds on the display and the recorder stops at the start of the first file in the folder.
- In [**All**] mode, after playing the last file in the folder, the recorder will start playing from the first file in the next folder. When it comes to the end of the last file in the recorder, [**End**] flashes for two seconds on the display and the recorder stops at the start of the first file in the recorder.

Equalizer

If you change the equalizer setting, you can enjoy the music with your favorite sound quality.



For WS-710M/WS-700M:

1 Select the desired equalizer characteristics.

[**Off**]: Disables the equalizer function.

[**Rock**] [**Pop**] [**Jazz**]: Enables the equalizer function.

[**User**]: Select [**User**] to save your own custom equalizer settings. If [**User**] is selected, proceed to Step 2.

2 Select the frequency band.

[**60 Hz**] [**250 Hz**] [**1 kHz**] [**4 kHz**] [**12 kHz**]:

Select the frequency bandwidth setting.

3 Select the equalizer level.

- You can select the equalizer level from [-6] to [+6] in 1dB increments.
- The higher the decibel value, the louder the sound.
- To change the settings again, press the **▶▶** or **◀◀** button and repeat the procedure from step 2.
- [**Equalizer**] only works in [**Music**] mode.

Skip Space

This function enables you to skip (forward) or reverse skip (rewind) a file being played for a set period. This function is convenient for quickly skipping to another playback position or repeatedly playing back short phrases.

1 Select [**Forward Skip**] or [**Reverse Skip**].

2 Set the skip space.

When [**Forward Skip**] is selected:

[**File Skip**] [**10sec. Skip**] [**30sec. Skip**]

[**1min. Skip**] [**5min. Skip**]

[**10min. Skip**]

When [**Reverse Skip**] is selected:

[**File Skip**] [**1sec. Skip**] – [**5sec. Skip**]

[**10sec. Skip**] [**30sec. Skip**]

[**1min. Skip**] [**5min. Skip**]

[**10min. Skip**]

Forward/Reverse Skip Playback:

1 Press the **OK** / **MENU** button to start playback.

2 Press the **▶▶** or **◀◀** button.

- The recorder will skip (forward) or reverse skip (rewind) a set space and start playing back.
- If there is an index mark/temp mark or a cue closer than the skip space, the recorder will forward skip/reverse skip to that position.

Play Scene

Voice files recorded in the recorder and music files downloaded from the PC can be saved in the playback settings of your choice to suit the different sound qualities and playback methods.

1 Select [**Scene Select**] or [**Scene Save**].

[**Scene Select**]:

Select a playback scene customized

[Scene Save]:

You can save up to 5 sets of menu settings relating to a current playback.

- If you select **[Scene Select]**, proceed to the operation of Step 4.

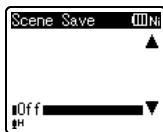
When [Scene Save] is selected:**2 Set the playback settings according to your preferences.**

Example:
WS-710M, WS-700M

3 Specify a save destination for the settings.**For WS-710M, WS-700M only:**

- You can select the save destination from among **[Voice 1]** to **[Music 3]**.

For WS-600S only:

- You can select the save destination from among **[Voice 1]** to **[Voice 5]**.

When [Scene Select] is selected:**4 Select the playback scene.****To check the settings:**

On the **[Scene Select]** display, select a playback scene using the + and - buttons, and press the ►► button. Press the ◀◀ button to return to the **[Scene Select]** display.

LCD/Sound Menu**Backlight**

The display will remain lit for about 10 (Initial setting) seconds when a button on the recorder is pressed.

[Off]:

Disables this function.

[5seconds] [10seconds] [30seconds] [1minute]:

Enables the Backlight function.

Contrast

Display contrast can be adjusted in 12 levels.

- You can adjust the LCD display contrast level from **[01]** to **[12]**.

LED

You can set it so the LED indicator light does not turn on.

[On]:

LED light will be set.

[Off]:

LED light will be cancelled.

Beep

The recorder beeps to alert you to button operations or warn you of errors. System sounds may be turned off.

[On]:

Enables the Beep function.

[Off]:

Disables this function.

Language(Lang)

You can select the display language for this recorder.

[English] [Français] [Español] [Português (BR)]:

Speaker

You can use the built-in speaker when the earphones are unplugged.

[On]: Output sound from the built-in speakers. If the earphones are plugged in, sound will not be output from the built-in speaker.

[Off]: Do not output sound from the built-in speaker.

- Ⓐ Speaker muting indicator (Appears when **[Speaker]** is set to **[Off]**.)

**For WS-710M only:**

- This is different function to **[Output]** of **[FM Menu]**. Irrespective of the **[Speaker]** setting, in the case that you have set **[Output]** to **[Speaker]** when listening to the FM radio, sound from the radio will still be output from the speaker (☞ P.59).

Device Menu**Memory Select**

For WS-710M/WS-700M:

When a microSD card is inserted you can select to record to either the built-in memory or to the microSD card (☞ P.19).

[Built-in Memory]: Built-in memory.

[microSD Card]: microSD card.

Power Save

Forgetting to turn the power off can be prevented. If the recorder remains in stop mode for over 10 minutes (Initial setting) while the power is turned on, the power will be turned off.

[5minutes] [10minutes] [30minutes] [1hour]:

Set the length of time before the power will be turned off.

[Off]: Disables this function.

- If any button is pressed, the elapsed time count before the power turns off will start over again.

Battery

Select to match the battery you are using.

[Ni-MH]:

Select when using the Olympus Ni-MH rechargeable battery (BR401).

[Alkaline]:

Select when using a commercially available alkaline dry battery.

USB Settings

Refer to “**Changing the USB class [USB Settings]**” (☞ P.61).

Time & Date

Refer to “**Setting time and date [Time & Date]**” (☞ P.17).

Reset Settings

This returns the functions back to their initial settings (factory default).

[Start]:

Returns the settings to their initial values.

[Cancel]:

Takes you back to **[Device Menu]**.

- After resetting the settings, the time settings and file numbers will be preserved from before the reset and will not return to their initial settings.

Menu settings after setting reset (initial settings):

🔊 Rec Menu:

[Mic Sense]	[Middle]
[Rec Mode]	
[WMA]	[ST XQ]
[Zoom Mic]*1	[Off]
[Low Cut Filter]	[Off]
[VCVA]	[Off]
[V-Sync. Rec]	[Off]

🔊 Play Menu:

[Noise Cancel]*2	[Off]
[EUPHONY]*3	[Off]
[Voice Filter]	[Off]
[Play Mode]*3	
[Play Area]	[Folder]
[Repeat]	[Off]
[Random]	[Off]
[Play Mode]*4	[File]
[Equalizer]*3	[Off]
[Skip Space]	[File Skip]

🔊 LCD/Sound Menu:

[Backlight]	[10seconds]
[Contrast]	[Level 06]
[LED]	[On]
[Beep]	[On]
[Language(Lang)]	[English]
[Speaker]	[On]

🔊 Device Menu:

[Memory Select]*5	[Built-in Memory]
[Power Save]	[10minutes]
[Battery]	[Ni-MH]*5
	[Alkaline]*6
[USB Setting]	
[USB Connect]	[PC]
[USB Class]	[Storage Class]

🔊 FM Menu (For WS-710M only):

[Rec Mode]	[WMA]
[Scan sense]	[Off]
[Output]	[Earphone]

*1 For WS-710M only.

*2 For WS-710M, WS-700M only (It only works in [Recorder] mode).

*3 For WS-710M, WS-700M only (It only works in [Music] mode).

*4 For WS-600S.

For WS-710M, WS-700M (It only works in [Recorder] mode).

*5 For WS-710M, WS-700M only.

*6 For WS-600S only.

Download from Www.Somanuals.com. All Manuals Search And Download.

Format

Refer to "Formatting the recorder [Format]" (P.63).

Memory Info.

The recordable capacity remaining and overall capacity of the recording media can be seen from the menu.

- The recorder will use some capacity of the memory to keep the management file. For microSD card, the remaining capacity will be shown less than the total capacity of the card due to characteristic of the microSD card, but this is not a malfunction.

System Info.

You can check the recorder's information on the menu screen. [Model] (Model Name), [Capacity] (Built-in flash memory size), [Version] (System version) and [Serial No.] (Serial Number) appears on the display.

FM Menu

! For WS-710M:

Rec Mode

You can change the recording mode when recording from the FM radio. Select a recording mode to suit your purpose.

[PCM]: The recording rate will be automatically set to **[44.1 kHz/16 bit]**.

[MP3]: The recording rate will be automatically set to **[128 kbps]**.

[WMA]: The recording rate will be automatically set to **[ST HQ]**.

Auto-preset

Refer to **"Presetting radio stations automatically [Auto-preset]"** (P.43).

Scan sense

You change the scan sensitivity when scanning for radio stations with auto preset. Select the sensitivity to suit the reception conditions.

[High]: Receive radio station signals using high sensitivity. You should normally select this setting.

[Low]: Receive radio station signal using reduced sensitivity. Try this setting when there is interference by signals from unwanted stations.

Output

You can change the audio output of the FM radio.

[Earphone]: Output sound from earphones. Sound will not be output from the built-in speaker even if you unplug the earphones.

[Speaker]: Always output sound from built-in speaker. Sound will not be output from earphones even if you plug them in.

- This is different function to **[LCD/Sound Menu]** of **[Speaker]**. Irrespective of the **[Speaker]** setting, in the case that you have set **[Output]** to **[Speaker]** when listening to the FM radio, sound from the radio will still be output from the speaker (P.57).

Rearranging files [Replace]

You can move a file in a folder to change the order of playback. First select the folder (file) for which you want to change the playback order.

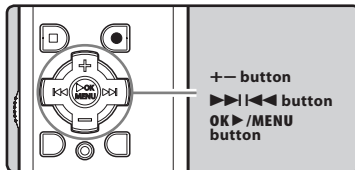

1 Select the folder for which you would like to rearrange the song order (P.22 to P.24).

2 While the recorder is during stop mode, select **[Replace]** from the menu on the **[File Menu]**.

- For details on how to enter the menu settings, see **"Menu setting method"** (P.47).

3 Press the **+ or –** button to select the file you want to move.

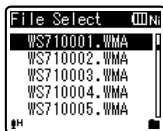

4 Press the **OK ►/MENU** or **►►►** button.

- The cursor will flash to confirm that the file can be moved.

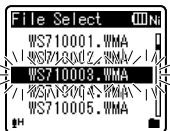

5 Press the **+** or **-** button to select the location to move it to.

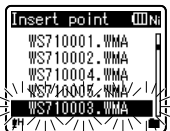

6 Press the **OK ►/MENU** button to complete the setting.

- If there are more files to move, repeat Steps 3 through 4.
- Pressing the **◀◀** button without pressing the **OK ►/MENU** button will cancel the settings and return you to the previous screen.

7 Press the **STOP (■)** button to close the menu screen.

Dividing files [File Divide]

Files with large capacities and long recording times can be divide so that they are easier to manage and edit.

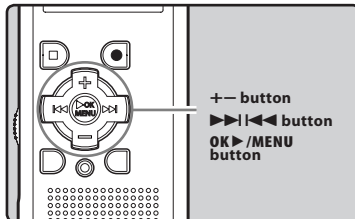

Only MP3 files and PCM* files recorded on this recorder can be divided.

* For WS-710M, WS-700M only.

1 Stop playback at the divide position.

- In the file display, the stop position becomes the divide position.
- While the recorder is during playback mode, press and hold the **►►►** or **◀◀** button to fast-forward or rewind (☞ P.33).
- It is useful to set index marks on marking in advance at the divide position (☞ P.35).

2 Select [File Divide] from the menu on the [File Menu].

- For details on how to enter the menu settings, see "Menu setting method" (☞ P.47).



- 3 Press the + button to select [Start].**



- 4 Press the OK ►/MENU button.**

- **[Dividing!]** will appear and file dividing will start.
- File dividing is completed when **[File divide completed]** appears.

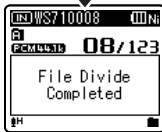
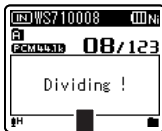

Notes

- The file divide cannot be done when the file list is displayed.
- The recorder cannot divide files when the number of files in the folder exceeds 199.
- Locked files cannot be divide (P.49).
- After a file has been divided, the original file will be renamed **[File name_1.wav]** and the new file will be named **[File name_2.wav]**.
- If a file has an extremely short recording time, it may not be divided even if it is a MP3 file or PCM file.
- Do not remove the battery during dividing file. This may damage the data.

Download from www.Somanuals.com. All Manuals Search And Download.

Changing the USB class [USB Settings]

Besides setting to **[PC]** (Connect to PC to transfer files) or **[AC Adapter]** (Connect to AC adapter to recharge the battery), you can switch the USB class according to your usage.

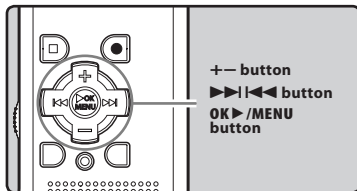

- 1 While the recorder is during stop mode, select [USB Settings] from the menu on the [Device Menu].**

- For details on how to enter the menu settings, see "Menu setting method" (P.47).

- 2 Press the + or – button to select [USB Connect] or [USB Class].**



[USB Connect]:

Setting for connecting to the PC.

[USB Class]:

Setting for USB class.

- 3 Press the OK ►/MENU or ►►► button.**

- If you select **[USB Class]**, proceed to the operation of Step 6.

When [USB Connect] is selected:

- 4 Press the + or – button to change the setting.**



[PC]: Setting for when the recorder is connected to the PC and used as a storage device or composite device. Connected as storage or composite.

[AC Adapter]: Setting for when the recorder is connected to the PC for charging or to the AC Adapter (A514) (optional).

[Optional]: Setting to confirm the connection method each time a USB connection is made.

- 5 Press the OK ►/MENU button to complete the setting.**

- If you select **[USB Connect]**, proceed to the operation of Step 8.

When [USB Class] is selected:

- 6 Press the + or – button to change the setting.**



[Storage Class]: Recognized as an external memory device from the PC.

[Composite]: Setting when connected to the PC and used as an external memory device, USB speaker or microphone.

- 7 Press the OK ►/MENU button to complete the setting.**
- 8 Press the STOP (■) button to close the menu screen.**

Notes

- When you first connect the recorder to your PC as an external storage device, the driver for the recorder will be automatically installed in your PC.
- The PC cannot recognize when the recorder is connected to the PC when setting for the **[USB Connect]** is set to **[AC Adapter]**.
- When the recorder is not recognized by the PC as an external storage device, change the **[USB Class]** setting to **[Storage Class]**.
- If you connect the recorder to the USB AC adapter with the **[USB Connect]** setting still set to **[PC]**, **[Please wait]** will appear on the recorder display.

Formatting the recorder [Format]

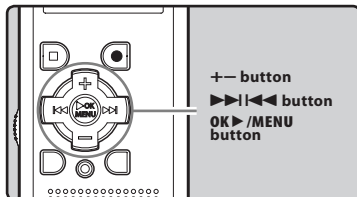

! If you format the recorder, all files will be removed and all function settings will return to defaults except date and time settings. Transfer any important files to a computer before formatting the recorder.

1 While the recorder is during stop mode, select [Format] from the menu on the [Device Menu].

- For details on how to enter the menu settings, see "Menu setting method" (P.47).
- If you are using the WS-600S, proceed to the operation of Step 5.

2 Press the + or – button to select the recording media to format.



Example:
WS-710M, WS-700M

3 Press the OK ▶/MENU or ▶▶▶ button.

4 Press the + button to select [Start].



5 Press the OK ▶/MENU button.

- After [Data will be cleared] message is on for two seconds, [Start] and [Cancel] will turn on.



6 Press the + button again to select [Start].

7 Press the OK ►/MENU button.

- Formatting begins and [Format !] flashes on the display.

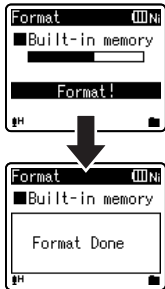

- [Format Done] appears when formatting ends.

5

Menu setting method

Notes

- Never format the recorder from a PC.
- Once the recorder is formatted, the music files with DRM may not be transferred to the recorder again.
- When the recorder is formatted, all the saved data, including locked files and read-only files, are erased.
- After formatting, recorded voice file names may start from [0001].
- When returning the settings for the functions to their initial settings, use [Reset Settings] (P.47, P.57).

For WS-710M, WS-700M only:

- When an microSD card is inserted in the recorder, be sure to confirm the recording media as either [Built-in Memory] or [microSD Card] so that there is no mistake (P.47, P.57).
- It may take over 10 seconds to complete processing. Never perform operations such as the following while processing, as they may damage the data. In addition, replace the battery with a new one in order to ensure that the battery will not run out while processing.
 - ① Disconnecting the AC Adapter while processing.
 - ② Removing the battery while processing.
 - ③ Remove the microSD card during processing when [microSD Card] is being used as the recording media.
- Formatting on the recorder will be Quick Format. If you format the microSD card, information of file management is refreshed and the data inside the microSD card is not deleted completely. When handing over and disposing the microSD card, be careful about the data leakage from the microSD card. We recommend the microSD card to be destroyed when you dispose the microSD card (P.19).

For WS-600S only:

- It may take over 10 seconds to complete processing. Never perform operations such as the following while processing, as they may damage the data. In addition, replace the battery with a new one in order to ensure that the battery will not run out while processing.
 - ① Disconnecting the AC Adapter while processing.
 - ② Removing the battery while processing.

Using the recorder on your PC

By being connected to a PC, the recorder enables you to do the following:

- You can transfer files recorded with this recorder to a computer, play them back, and manage them by using Windows Media Player or iTunes (® P.70, P.77).
- The recorder is compatible with WMA, MP3 and WAV* language content.
* For WS-710M, WS-700M only.
- In addition to its uses as a voice recorder and a music player, this recorder can also be used as external memory for a computer by storing data from a computer and reading it back out (® P.69, P.81).

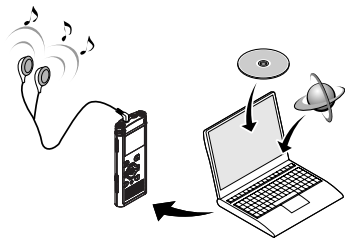

Operating environment

Windows

Operating System:

Microsoft Windows XP/Vista/7 (Standard Installation)

Compatible PC's:

Windows PC's equipped with more than one free USB port

Macintosh

Operating System:

Mac OS X 10.4.11 - 10.6 (Standard Installation)

Compatible PC's:

Apple Macintosh series equipped with more than one free USB port

6

Operating environment

Notes

- This is an operational environment for saving the files recorded by this recorder to your PC with USB connection.
 - Even if operational environment is satisfied, we do not support such as upgraded OS, the multi-boot environment and self-modified PC's.
- Download from www.Sonmanuals.com. All Manuals Search And Download.

EN

65

Precautions on using the recorder connected to a PC

- When you are downloading a file from the recorder or uploading a file to the recorder, do not remove the USB cable even if the screen is indicating you can. Data is still being transferred while the recording indicator light is blinking. When removing the USB cable, be sure to follow the description in **☞** P.68. If the USB cable is removed before the drive is stopped, data may not be successfully transferred.
- On a PC, do not format the drive of the recorder. Initialization is not successfully achieved on a PC. For initialization, follow the instructions in **[Format]** screen of the recorder (**☞** P.63).
- Folder (directory) names appeared by file management tools such as Explorer in Microsoft Windows and Finder in Macintosh are different from the folder names that can be set with the recorder.
- If folders or files stored on the recorder are moved or renamed using a file management tool in Windows or Macintosh, the order of files may be changed or files may become unrecognizable.
- Data can be written or uploaded to the recorder even though the attribute of the recorder drive is shown as Read-only by the operating system of the PC.
- As the noise may cause adverse effects on electronics devices nearby the recorder, unplug the external microphone and earphone when you connect the recorder to a PC.

Copyright and copyright protection feature (DRM)

By the Copyright Act, any voice/music files and music CDs downloaded from the Internet without the copyright holder's permission may not be reproduced, distributed, publicized/re-publicized on the Internet, or converted into WAV, WMA or MP3 files for the purpose of commercial business or sale.

A WMA file may be provided with DRM (Digital Right Management) for copyright protection. DRM limits the file to copy or distribute music files that are converted (ripped) from a music CD or downloaded from music distribution services. To transfer a WMA file with DRM to the recorder, you need to use appropriate methods such as Windows Media Player. Copying the music files with DRM purchased from online music distribution service to a portable device such as this recorder may be restricted.

Note

- This recorder is compatible with Microsoft Corporation DRM9, but not with DRM10.

Connecting to your PC

- 1 **Boot the PC.**
- 2 **Slide the USB connector slide lever in the direction indicated by the arrow to eject the USB connector out of the recorder.**

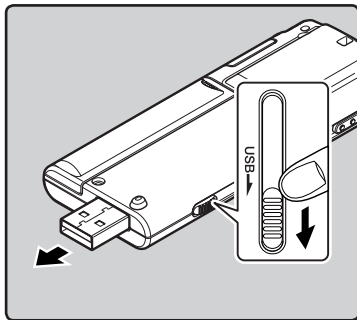

- 3 **Make sure that the recorder is stopped, and connect to the PC's USB port.**

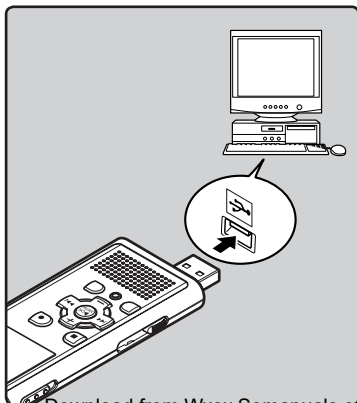

Windows:

When you open **[My Computer]**, it will be recognized by the drive name of the product name.

Macintosh:

When you connect the recorder to a Mac OS, it will be recognized by the drive name of the product name on the desktop.

- **[Remote (Storage)]** is appeared on recorder if the USB cable is connected.



For WS-710M,
WS-700M only



For WS-600S only

Notes

- Refer to the user's manual for your PC regarding the USB port on your PC.
- Be sure to push the cable connector all the way in. Otherwise, the recorder may not operate properly.
- Use the supplied USB extension cable depending on situations.
- When connecting the recorder through an USB hub the operation may become unstable. In such cases, refrain from using a USB hub.
- Do not use USB extension cables other than the supplied cable.

Using cables from other manufacturers could result in damage to the recorder. Do not use the supplied USB extension cable with devices from other manufacturers.

Disconnecting from your PC

Windows

- 1 Click [] on the task bar located at the lower-right corner of the screen. Click [Safely remove USB Mass Storage Device].



- The drive letter will differ depending on the PC being used.
- When the window indicating that it is safe to remove hardware window appears, close the window.

- 2 Make sure that the recording indicator light is off, and disconnect the recorder from the PC.

Macintosh

- 1 Move the drive icon for this recorder that is appear on the desktop to the garbage bin by Drag & Drop it.



- When you connect the recorder to a Mac OS, it will be recognized by the drive name of the product name on the desktop.

- 2 Make sure that the recording indicator light is off, and disconnect the recorder from the PC.

Note

- NEVER disconnect the USB while the recording indicator light is flashing. If you do, the data will be destroyed.

Transfer the voice files to your PC

The 5 voice folders of this recorder are appeared as [Folder A], [Folder B], [Folder C], [Folder D] and [Folder E], and the recorded voice files are saved in these folders (When using the WS-710M, FM radio recordings will be saved in [FLD_FM]).

Windows

1 Connecting the recorder to your PC (P.67).

2 Open the Explorer window.

- When you open [My Computer], it will be recognized by the drive name of the product name (When an microSD card is inserted it will be recognized by the drive name [Removable Disk] *1).

3 Open the product name folder.

4 Copy the data.

5 Disconnect the recorder from the PC (P.68).

Macintosh

1 Connecting the recorder to your PC (P.67).

- When you connect the recorder to a Mac OS, it will be recognized by the drive name of the product name on the desktop (When an SD card is inserted it will be recognized by the drive name [Untitled] *1).

2 Double-click the product name icon on the desktop.

3 Copy the data.

4 Disconnect the recorder from the PC (P.68).

Drive name and folder name when a personal computer is connected:

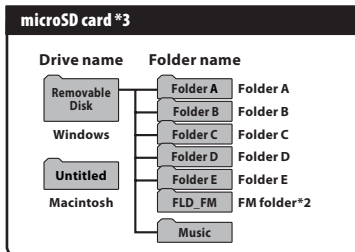
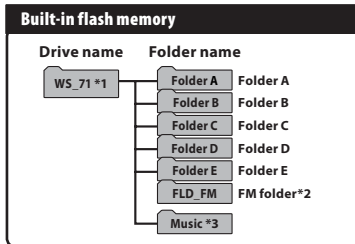

*1 Recognized by the drive name of the product name.

*2 For WS-710M only

*3 For WS-710M, WS-700M only.

Notes

- While transmitting data, [Busy] is appeared, and the recording indicator light flashes. NEVER disconnect the USB while the recording indicator light is flashing. If you do, the data will be destroyed.
- In the Mac OS operational environment, WMA format files cannot be played back.

Using Windows Media Player

Music files that have been imported to your computer from music CDs and acquired over the Internet can be transferred to and played back with this recorder. It supports WAV, MP3, and WMA format music files.

By using Windows Media Player, music files from music CDs can be converted (ripped) (✎ P.71) and music files that you have bought from any music distribution sites can be easily transferred to the recorder (✎ P.72, P.75).

Window names

Windows Media Player 12

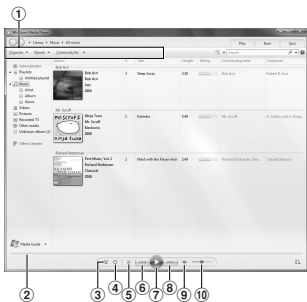

- 1 Features taskbar
- 2 Seek slider
- 3 Shuffle button
- 4 Repeat button
- 5 Stop button

Windows Media Player 11



- 6 Previous button
- 7 Playback button
- 8 Next button
- 9 Mute button
- 10 Volume slider

Copying music from CD

1 Insert CD into the CD-ROM drive, and start Windows Media Player.

2 From the Features taskbar, click [Rip CD] menu.

- For Windows Media Player 11 Click [Rip].
- If Internet connectivity is available, CD information is searched.

3 Put a check mark on the music file that you want to copy.

4 Click [Start Rip].

- Files copied to a PC are stored in WMA format. Music files copied are categorized by artist, album, genre, etc. and added to the play list.

Windows Media Player 12

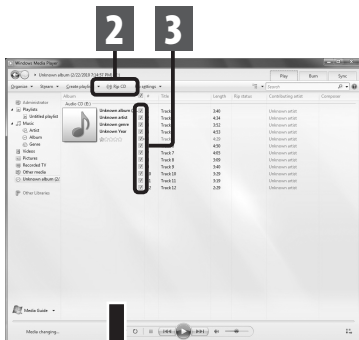

6

Using Windows Media Player

Windows Media Player 11



4

Transferring music file to the recorder

You can transfer the music files saved in your PC to this recorder. For how to copy the music files from the CD to your PC, see **"Copying music from CD"** (P.71).

Windows Media Player 12

1 Connect the recorder to a PC, and start Windows Media Player.

2 From the **[Organize]** menu, click **[Options]**. At the Options dialog box, click the **[Devices]** tab.

3 Select the recorder product name from among the devices, and click **[Properties]**.

- Click on the **[Create folder hierarchy on device]** to check.

If you uncheck and synchronize the file, it will be transferred under the folder **[Home]**, and the file will not be indicated. *1 *2

- The folder with artist name or album name is automatically created. This will make you find the file you want to listen to more easily.

*1 If **[Create folder hierarchy on device]** is checked by default, click to uncheck the box once, and click it again to check.

*2 After the synchronous transfer to the recorder, a file named "WMPInfo.xml" is created. If you delete this file, the *1 may need to be set again.

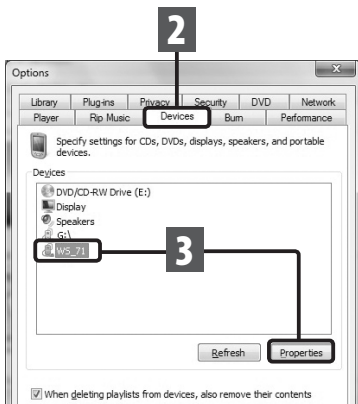
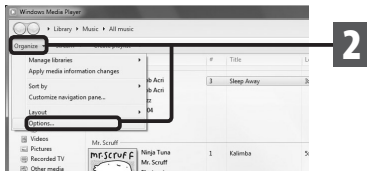

4 Select the desired category from [Library] on the left, and select music files or albums to transfer to the recorder, and Drag & Drop them in [Sync list] on the right.

5 Click [Start sync].

- The file is transferred to the recorder.

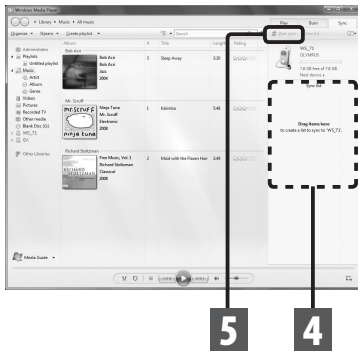

Note

- Refer to the online help of Windows Media Player for details.

Windows Media Player 11

1 Connect the recorder to a PC, and start Windows Media Player.

2 From the Features taskbar, click [Sync].

3 Click [Sync] menu again to select [DVR] → [Advanced Options] → [Set Up Sync], and set as follows.

- Click on [Create folder hierarchy on device] to check. *1 *2



- The folder with artist name or album name is automatically created. This will make you find the file you want to listen to more easily.
- *1** If [**Create folder hierarchy on device**] is checked by default, click to uncheck the box once, and click it again to check.
- *2** After the synchronous transfer to the recorder, a file named “WMPInfo.xml” is created. If you delete this file, the ***1** may need to be set again.



4 Select the desired category from [**Library**] on the left, and select music files or albums to transfer to the recorder, and Drag & Drop them in [**Sync List**] on the right.

5 Click [**Start Sync**].

- The file is transferred to the recorder.



Notes

- Copying the music files with DRM purchased online music distribution service to a portable device such as this recorder may be restricted.
- To transfer the files by using Windows Media Player 9 or Windows Media Player 10, check the Olympus website.
- If the music files are transferred to the recorder until it reaches to the maximum memory, the message [**Can't make the system file. Connect to PC and delete unnecessary file**] may appear on this recorder's display. In such a case, erase the files to make free space (hundreds of KB to dozens of MB depending on the music file sizes) for the management file (The more capacity for the management file will be necessary as the number of the music files increases).

Download from www.Somanuals.com. All Manuals Search And Download.

Copying voice file to the CD

You can transfer the voice files in the recorder to your PC and copy them to CD. For how to copy the voice files from the recorder to your PC, see **“Transfer the voice files to your PC”** (P.69).

Windows Media Player 12

- 1 Insert the blank CD-R/RW into the CD-R/RW drive, and start Windows Media Player.
- 2 From the Features taskbar, click the [Burn] menu.
- 3 Select the desired category from [Library] on the left, and select voice files or albums to copy to the CD-R/RW, and Drag & Drop them in [Burn list] on the right.

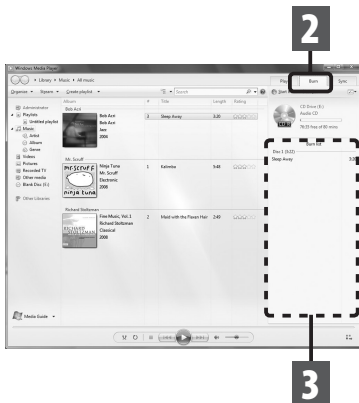

- 4 Click the [Burn] tab, and select [Data CD or DVD] or [Audio CD].

When [Audio CD] is selected:

A file is converted and copied in CD in order to play it by the audio equipment which can play CD-R/RW.

When [Data CD or DVD] is selected:

Copying files with the format to be recorded.

- 5 Click [Start burn].



6

Using Windows Media Player

EN

75

Windows Media Player 11

- 1 Insert the blank CD-R/RW into the CD-R/RW drive, and start Windows Media Player.
- 2 From the Features taskbar, click [Burn] menu.
- 3 Select the desired category from [Library] on the left, and select voice files or albums to copy to the CD-R/RW, and Drag & Drop them in [Burn List] on the right.
- 4 Click [Burn] menu again, and select [Audio CD] or [Data CD].

When [Audio CD] is selected:

A file is converted and copied in music CD in order to play it by the audio equipment which can play CD-R/RW.

When [Data CD] is selected:

Copying files with the format to be recorded.

- 5 Click [Start Burn].

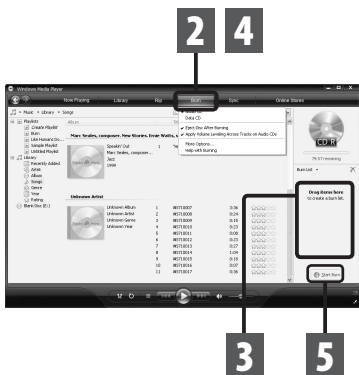

Notes

- Copying the music files with DRM purchased online music distribution service to a portable device such as this recorder may be restricted.
- Refer to the online help of Windows Media Player for details.
Download from Www.Somanuals.com. All Manuals Search And Download.

Using iTunes

Music files that have been imported to your computer from music CDs and acquired over the Internet can be transferred to and played back with this recorder. It supports MP3 format music files.

By using iTunes, music files from music CDs can be converted (ripped) (☞ P.78) and music files that you have bought from any music distribution sites can be easily transferred to the recorder (☞ P.79, P.80).

Window names



① Features taskbar

② Rewind button/
Playback, Pause button/
Fast Forward button

③ Volume slide

④ Playlist addition button

⑤ Shuffle button

⑥ Repeat button

⑦ Display change button

⑧ Disc create button

⑨ Browse button

⑩ Disc eject button

Download from www.Somanuals.com. All Manuals Search And Download.

Copying music from CD

- 1 Insert the CD into the CD-ROM drive, and start iTunes.
 - 2 Click [iTunes] → [Preferences].
 - 3 Click [Advanced] tag.
 - 4 Click [Importing].
 - 5 Set the file format and bit rate for copying music files to your PC, and click [OK].
 - This recorder supports MP3 and WAV* format music files (☞ P.34).
 - * For WS-710M, WS-700M only.
- [Import Using]:**
Set the file format for copying music file from a CD. Please select [MP3 Encoder] or [WAV Encoder].
- [Setting]:**
Set the bit rate for copying music file from a CD.

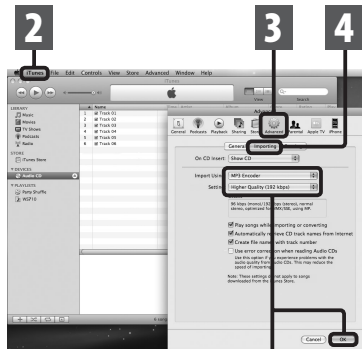

- 6 Put a check mark on the music files that you want to copy.
- 7 Click [Import CD].



6

Using iTunes

EN

78

Transferring music file to the recorder

You can transfer the music files saved in your PC to this recorder. For how to copy the music files from the CD to your PC, see **"Copying music from CD"** (P.78).

1 Connect the recorder to a PC, and start iTunes.

2 Select the play list to be transferred to the recorder, and put the check marks on the music files that you want to transfer.

- The order of music pieces can be changed by Drag & Drop of the music file in the play list displayed.

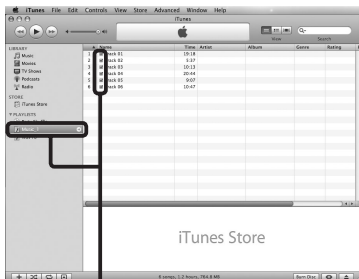

6

Using iTunes

3 Double-click the corresponding drive with the recorder, and open [Music] folder.

- When you connect the recorder to a Mac OS, it will be recognized by the drive name of the product name on the desktop.
- Copy to [Music] folder of the recorder when transferring the music file.
- You can create up to 2 hierarchies in [Music] folder. And up to 128 folders can be made including [Music] folder.
- Up to 200 files can be stored in each folder.

4 Select the desired files, and Drag & Drop them to [Music] folder.

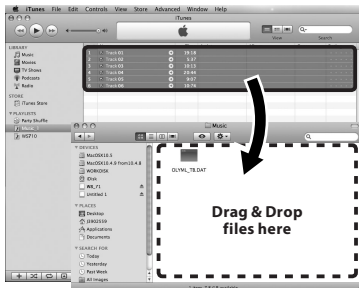

Copying voice file to the CD

You can transfer the voice files in the recorder to your PC and copy them to CD. For how to copy the voice files from the recorder to your PC, see **“Transfer the voice files to your PC”** (e38 P.69).

- 1 Insert the CD-R/RW into the CD-R/RW drive, and start iTunes.
- 2 Select the desired playlist, and put a check mark on the voice files to copy to the CD-R/RW.
- 3 Click **[Burn Disc]**.

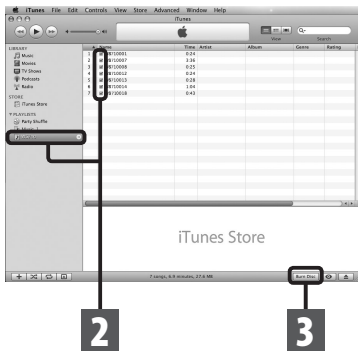

6

Using iTunes

- 4 Set the CD format for copying voice files to CD-R/RW, and click **[OK]**.

When [Audio CD] is selected:

A file is converted and copied in music CD in order to play it by the audio equipment which can play CD-R/RW.

When [MP3 CD] is selected:

Copying in MP3 format.

When [Data CD] is selected:

Copying files with the format to be recorded.



4

Using as external memory of the PC

In addition to its uses as a voice recorder and a music player, this recorder can also be used as external memory for a computer by storing data from a computer and reading it back out. With the recorder connected to your PC, you can download data from the memory to your PC and upload data stored on your PC to the memory.

Windows

- 1 Connecting the recorder to your PC (P.67).**
- 2 Open the Explorer window.**
 - When you open **[My Computer]**, it will be recognized by the drive name of the product name.
- 3 Open the product name folder.**
- 4 Copy the data.**
- 5 Disconnect the recorder from the PC (P.68).**

Macintosh

- 1 Connecting the recorder to your PC (P.67).**
 - When you connect the recorder to a Mac OS, it will be recognized by the drive name of the product name on the desktop.
- 2 Double-click the product name icon on the desktop.**
- 3 Copy the data.**
- 4 Disconnect the recorder from the PC (P.68).**

Note

- While transmitting data, **[Busy]** is displayed, and the recording indicator light flashes. NEVER disconnect the USB while the recording indicator light is flashing. If you do, the data will be destroyed.
- Download from www.Somanuals.com. All Manuals Search And Download.

Other information

Alarm message list

Message	Meaning	Explanation	Action
[Battery Low]	Low battery power.	Battery power is getting low.	Charge the battery (For WS-710M, WS-700M only) or replace with new battery (☞ P.10, P.12).
[File Protected]	Erase-locked.	Tried to delete a locked file.	Unlock the file (☞ P.47, P.49).
For WS-710M, WS-700M only:			
[Cannot record in this folder]	Not an audio-recording folder.	Tried to record in the [Radio Folder] (For WS-710M only) or in a mode other than [Recorder] mode.	Set [Recorder] mode, re-select from [Folder A] through [Folder E] and record (☞ P.21, P.24).
[Index Full]	Index full.	The file is full of index marks (maximum of 16 marks).	Erase index marks that are no longer required (☞ P.35).
[Temp Mark Full]	Tempmark full.	The file is full of Tempmarks (maximum of 16 marks).	Erase Tempmarks that are no longer required (☞ P.35).
[Folder Full]	Folder full.	The folder is full of files (maximum of 200 files).	Erase unnecessary files (☞ P.39).
[Memory Error]	Error in the memory.	Error in the memory.	This is a malfunction, so go to the store where you purchased the recorder or an Olympus service station for repair (☞ P.91).
For WS-710M, WS-700M only:			
[Card Error]	Error in the memory.	microSD card is not recognized correctly.	Remove the microSD card, and put it again (☞ P.19 to P.20).
[Licence Mismatch]	Illegally copied file.	The music files copied illegally.	Erase the file (☞ P.39).
[Memory Full]	Zero remaining memory.	No remaining memory.	Erase unnecessary files (☞ P.39).
[No File]	No file.	No files were found in the folder.	Select another folder (☞ P.22 to P.24).
[Format Error]	Formatting error.	There was an error while formatting the recorder's memory.	Reformat the memory (☞ P.63).

Message	Meaning	Explanation	Action
[Can't make the system file. Connect to PC and delete unnecessary file]	The management file cannot be created.	The file for management cannot be created due to a shortage of capacity for remaining memory.	Connect the recorder to a computer and delete any unnecessary files.
[Cannot play this file]	File which cannot be played.	Incompatible format.	Please confirm the file that can be played on this recorder (☞ P.34).
[This file can't be divided]	File which cannot be split.	Attempting to split a file besides the MP3 or PCM files recorded in this recorder.	Please select another file.

Troubleshooting

Symptom	Probable cause	Action
Nothing appears on the display	The batteries are not loaded properly.	Verify that the batteries' polarities ⊕ and ⊖ are correct (☞ P.10).
	Battery power is getting low.	Charge the battery (For WS-710M, WS-700M only) or replace with new battery (☞ P.10, P.12).
	The power is off.	Turn the power on (☞ P.15).
Won't start	Battery power is getting low.	Charge the battery (For WS-710M, WS-700M only) or replace with new battery (☞ P.10, P.12).
	The power is off.	Turn the power on (☞ P.15).
	The recorder is in HOLD mode.	Release the recorder from HOLD (☞ P.16).
Unable to record	Low remaining memory.	Erase unnecessary files (☞ P.39).
	The maximum number of files has been reached.	Change to the another folder (☞ P.22 to P.24).
No playback tone heard	The earphone is connected.	Unplug the earphones to use the internal speaker.
	[Speaker] is set to [Off].	To play back using the built-in speaker, set [Speaker] to [On] (☞ P.47, P.57).
	The volume level is set to [00].	Adjust the volume level (☞ P.31).

Symptom	Probable cause	Action
Recording level too low	The microphone sensitivity is too low.	Set [Mic Sense] to [High] or [Middle] (☞ P.47, P.49).
	This could potentially be because the output level for the connected external devices are too low.	Adjust the output level for the connected devices.
Voice files are not recorded in stereo	The connected external microphone is monaural.	When recording while an external monaural microphone is connected, sound will only be recorded by the L-channel.
	[Rec Mode] is set to a monaural recording mode.	Set [Rec Mode] to the stereo recording mode (☞ P.47, P.49).
	[Zoom Mic] is set to the + side.	Set [Zoom Mic] to [Off] (☞ P.47, P.50).
Cannot find the recorded Voice File	Wrong folder.	Switch to the correct folder (☞ P.22 to P.24).
Noise heard during playback	The recorder was shaken during recording.	_____
	The recorder was placed near a cell phone or fluorescent lamp while recording or during playback.	Move the recorder.
Unable to erase the file	The file is locked.	Unlock the file (☞ P.47, P.49).
	The file is read-only.	Unlock the file or cancel the read-only setting of the file on the PC.
Unable to erase the folders	There is a file which cannot be recognized by the recorder in the folder.	Connect the recorder to your PC and erase a folder (☞ P.67, P.69).
Noise is audible through the recording monitor	Acoustic feedback is occurring.	When the built-in speaker amps and the like are connected there is a risk that audio feedback will occur while recording. It is recommended that you use earphones for the recording monitor.
		Conduct adjustments like separating the earphones from the microphone further, do not point the microphone at the earphones, lower the volume on the recording monitor, and so on.
Unable to set index marks, tempmarks	The maximum number of marks has been reached.	Erase unnecessary marks (☞ P.35).
	The file is locked.	Unlock the file (☞ P.47, P.49).
	The file is read-only.	Unlock the file or cancel the read-only setting of the file on the PC.

Symptom	Probable cause	Action
Cannot receive FM radio signal	For WS-710M only:	
	The earphones are not plugged into the EAR jack.	The supplied earphones also function as an antenna. When using the recorder as a radio, be sure to plug in the earphones.
	[Output] is set to [Earphones] .	To play back using the built-in speaker, set [Output] to [Speaker] (☞ P.47, P.59).
Cannot recharge	For WS-710M, WS-700M only:	
	[Battery] is set to [Alkaline] .	When using the supplied rechargeable battery, set the battery setting to [Ni-MH] . Also, please avoid using the battery outside the recommended temperature range (☞ P.12).
	You have not pressed the OK ►/MENU button.	When using the USB connection, follow the confirmation display and press the OK ►/MENU button.
The PC is unable to recognize the recorder	[USB Connect] is set to [AC Adapter] .	Set [USB Connect] to [PC] (☞ P.61).

Accessories (optional)

Accessories exclusive to the Olympus voice recorder can be purchased directly from Online Shop on our company's website. Sales of accessories are different according to the country.

- **Stereo microphone: ME51S**

The built-in large-diameter microphone enables sensitive stereo recording.

- **2 channel microphone (omni-directional): ME30W**

Two ME30 monaural microphones come in a set with a miniature tripod and a connection adapter. These are highly sensitive omni-directional microphones supported by plug-in power which are well-suited to recording musical performances.

- **Compact Gun Microphone (unidirectional): ME31**

The directional microphones useful for recordings such as outdoor recording of wild birds singing. The metal body provides a sturdiness to the high rigidity.

- **Compact zoom microphone (unidirectional): ME32**

The microphone is integrated with a tripod, making it suitable for when you wish to record from a distance, such as from your table at a meeting or conference.

- **Highly sensitive noise-cancellation monaural microphone (unidirectional): ME52W**

This microphone is used to record sound at a distance while minimizing surrounding noise.

- **Tie clip microphone (omni-directional): ME15**

Small concealing microphone with a tie-clip.

- **Telephone pickup: TP7**

Earphone type microphone can be plugged into your ear while phoning.

The voice or conversation over the phone can be clearly recorded.

- **Ni-MH rechargeable battery and charger set: BC400 (For Europe)**

BC400 comes with an Ni-MH rechargeable battery charger (BU-400) and 4 Ni-MH rechargeable batteries (BR401) as a pack. This charger can quick charge Olympus AA or AAA Ni-MH rechargeable batteries.

- **Ni-MH rechargeable battery: BR401**

High-efficiency rechargeable long life batteries.

- **USB connecting AC adapter: A514**

DC5V AC Adapter for USB connection.

- **Connecting cord: KA333**

Connecting cord which has stereo mini-plugs (ø3.5) with resistance at both ends. Use to connect from the earphone jack output of the recorder to the microphone input jack when recording. Converting plug adapters (PA331/PA231) which convert to the monaural mini plug (ø3.5) or monaural mini plug (ø2.5) are also enclosed.

Specifications

General points

Recording format:

Linear PCM* (Pulse Code Modulation)
MP3 (MPEG-1 Audio Layer3)
WMA (Windows Media Audio)
* For WS-710M, WS-700M only.

Input level:

- 70 dBv

Sampling frequency:

Linear PCM format

[44.1 kHz/16 bit] *1	44.1 kHz
----------------------	----------

MP3 format

[256 kbps] *1	44.1 kHz
[192 kbps] *2	44.1 kHz
[128 kbps]	44.1 kHz

WMA format

[ST XQ]	44.1 kHz
[ST HQ]	44.1 kHz
[ST SP]	22 kHz
[HQ]	44.1 kHz
[SP]	22 kHz
[LP]	8 kHz

*1 For WS-710M, WS-700M only

*2 For WS-600S only

Maximum working output:

80 mW (8 Ω speaker)

Maximum headphone output:

≤ 150 mV (according to EN 50332-2)

Wide band characteristic headphone output:

75 mV ≤ (according to EN 50332-2)

Recording medium:

Built-in NAND FLASH memory:

WS-710M: 8 GB/**WS-700M:** 4 GB/
WS-600S: 2 GB

microSD card (For WS-710M, WS-700M only):

512 MB to 16 GB

Download from www.Somanuals.com. All Manuals Search And Download.

Speaker:

Built-in ø 18 mm round dynamic speaker

MIC jack:

ø 3.5 mm mini-jack, impedance 2 kΩ

EAR jack:

ø 3.5 mm mini-jack, impedance 8 Ω or more

Input power requirement:

Batteries:

AAA battery (LR03) or Olympus Ni-MH rechargeable battery

External power supply:

USB connecting AC adapter(A514) 5 V

External dimensions:

98.5 mm × 40 mm × 11 mm
(without protrusions)

Weight:

51 g (including battery)

Operating temperature:

0°C - 42°C/ 32°F - 107.6°F

Tuning frequency range:

FM radio: 87.50 MHz to 108.00 MHz

Frequency response:

During recording mode (Microphone jack):

Linear PCM format

[44.1 kHz/16 bit] *1	40 Hz to 21 kHz
----------------------	-----------------

MP3 format

[256 kbps] *1	40 Hz to 20 kHz
[192 kbps] *2	40 Hz to 19 kHz
[128 kbps]	40 Hz to 17 kHz

WMA format

[ST XQ]	40 Hz to 19 kHz
[ST HQ]	40 Hz to 16 kHz
[ST SP]	40 Hz to 9 kHz
[HQ]	40 Hz to 13 kHz
[SP]	40 Hz to 8 kHz
[LP]	40 Hz to 3 kHz

*1 For WS-710M, WS-700M only

*2 For WS-600S only

■ During recording mode (Built-in stereo microphone):

70 Hz to 20 kHz (However, when recording by the MP3 format or the WMA format, the upper limit value of the frequency response depends on each recording mode)

■ During playback mode:

20 Hz to 20 kHz

Guide to battery life

The following values are strictly rough guides.

■ During recording mode (Built-in memory):

Recording mode	Built-in stereo microphones	
	*1	*2
[44.1 kHz/16 bit] *3	18 h.	18 h.
[128 kbps]	18 h. 30 min.	18 h. 30 min.
[ST XQ]	19 h.	19 h.
[LP]	25 h.	24 h.

■ During voice file playback mode (All Playback Mode):

Recording mode	Built-in speaker	
	*1	*2
[44.1 kHz/16 bit] *3	12 h.	12 h.
[128 kbps]	15 h.	15 h.
[ST XQ]	15 h.	15 h.
[LP]	15 h.	15 h.

Recording mode	Earphone playback	
	*1	*2
[44.1 kHz/16 bit] *3	22 h.	21 h.
[128 kbps]	29 h.	27 h.
[ST XQ]	30 h.	28 h.
[LP]	30 h.	28 h.

*1 Alkaline battery

*2 Ni-MH Rechargeable battery

*3 For WS-710M, WS-700M only

■ During FM radio mode (Built-in memory) (For WS-710M only):

Recorder status	Earphone playback	
	*1	*2
During FM radio reception	13 h. 30 min.	13 h. 30 min.
During FM radio recording	9 h.	9 h.

*1 Alkaline battery

*2 Ni-MH Rechargeable battery

Note

- Battery life is measured by Olympus. It varies greatly according to the type of batteries used and the conditions of use.

Guide to recording times

The following values are strictly rough guides.

■ Linear PCM format:

Recording medium		Recording mode	
		[44.1 kHz/16 bit]	
Built-in memory	WS-710M (8 GB)	12 h. 30 min.	
	WS-700M (4 GB)	6 h. 10 min.	
microSD card*	8 GB	12 h. 15 min.	
	4 GB	6 h.	
	2 GB	2 h. 50 min.	

■ MP3 format:

Recording medium		Recording mode		
		[256 kbps]	[192 kbps]	[128 kbps]
Built-in memory	WS-710M (8 GB)	69 h.	—	138 h.
	WS-700M (4 GB)	34 h.	—	69 h.
	WS-600S (2 GB)	—	22 h.	34 h.
microSD card*	8 GB	68 h.	—	137 h.
	4 GB	33 h. 30 min.	—	67 h.
	2 GB	16 h. 30 min.	—	33 h.

■ WMA format:

Recording medium		Recording mode					
		[ST XQ]	[ST HQ]	[ST SP]	[HQ]	[SP]	[LP]
Built-in memory	WS-710M (8 GB)	135 h.	270 h.	542 h.	542 h.	1067 h.	2122 h.
	WS-700M (4 GB)	67 h.	134 h.	270 h.	270 h.	532 h.	1058 h.
	WS-600S (2 GB)	33 h.	67 h.	135 h.	135 h.	266 h.	529 h.
microSD card*	8 GB	134 h.	268 h.	537 h.	537 h.	1058 h.	2105 h.
	4 GB	66 h.	133 h.	267 h.	267 h.	526 h.	1046 h.
	2 GB	32 h.	66 h.	132 h.	132 h.	261 h.	520 h.

* For WS-710M, WS-700M only.

Notes

- Available recording time may be shorter if many short recordings are made (The displayed available recording time and recorded time are approximate indications).
- Variations in the available recording time will arise as there may be differences in the available memory depending on the microSD card.

Download from www.semanuals.com. All Manuals Search And Download.

Maximum recording time per file

- The maximum capacity for a single file is limited to approx. 4 GB for WMA and MP3, and approx. 2 GB for Linear PCM format (WAV).
- Regardless of the memory remaining amount, the longest sound recording time per file is restricted to the following value.

Linear PCM format

[44.1 kHz/16 bit]*1	approx. 3 h. 20 min.
---------------------	----------------------

MP3 format

[256 kbps] *1	approx. 37 h. 10 min.
[192 kbps] *2	approx. 49 h. 30 min.
[128 kbps]	approx. 74 h. 30 min.

WMA format

[ST XQ]	approx. 26 h. 40 min.
[ST HQ]	approx. 26 h. 40 min.
[ST SP]	approx. 53 h. 40 min.
[HQ]	approx. 26 h. 40 min.
[SP]	approx. 53 h. 40 min.
[LP]	approx. 148 h. 40 min.

*1 For WS-710M, WS-700M only

*2 For WS-600S only

It is possible to record exceeding 2GB:

The recording will continue even if the volume of a single file exceeds 2 GB in the linear PCM format recording.

- The file is saved every 2 GB in separate files. It will be treated as multiple files when playing back.
- When the recording exceeds 2 GB, the number of files in the folder may exceed 200 files. The 201 file and later will not be recognized by the recorder, so check by connecting the recorder to a PC.

Guide to recordable number of songs

WS-710M: 2,000 songs

WS-700M: 1,000 songs

(At 128 kbps, 4 minutes per song)

Specifications and design are subject to change without notice.

Technical assistance and support

The following are contact information for technical support for Olympus recorders and software only.

- **Technical Hotline Number in the U.S. and Canada**

1-888-553-4448

- **User Support E-mail address in the U.S. and Canada**

distec@olympus.com

- **Technical Hotline Number in Europe**

Toll free number: 00800 67 10 83 00

available for Austria, Belgium, Denmark, Finland, France, Germany, Italy, Luxemburg, Netherlands, Norway, Portugal, Spain, Sweden, Switzerland, United Kingdom

Charged numbers for the Rest of Europe

+ 49 180 567 1083

+ 49 40 23773 4899

- **User Support E-mail address in Europe**

dss.support@olympus-europa.com

Declaration of Conformity:

Model Number: WS-710M/WS-700M/WS-600S

Trade Name: DIGITAL VOICE RECORDER

Responsible Party: OLYMPUS IMAGING AMERICA INC.

Address: 3500 Corporate Parkway, P.O. Box 610, Center Valley, PA
18034-0610, U.S.A.

Telephone Number: 1-888-553-4448

This device Complies with Part 15 of the FCC Rules. Operation is subject to the following two conditions: (1) This device may not cause harmful interference, and (2) this device must accept any interference received, including interference that may cause undesired operation.



**Tested To Comply
With FCC Standards
FOR HOME OR OFFICE USE**

Canadian RFI:

This digital apparatus does not exceed the Class B limits for radio noise emissions from digital apparatus as set out in the Radio Interference Regulations of the Canadian Department of Communications.

Cet appareil numérique ne dépasse pas les limites de la Catégorie B pour les émissions de bruit radio émanant d'appareils numériques, tel que prévu dans les Règlements sur l'Interférence Radio du Département Canadien des Communications.

OLYMPUS[®]

OLYMPUS IMAGING CORP.

Shinjuku Monolith, 3-1 Nishi-Shinjuku 2-chome, Shinjyuku-ku, Tokyo 163-0914, Japan. Tel. +81 (0)3-3340-2111

<http://www.olympus.com>

OLYMPUS IMAGING AMERICA INC.

3500 Corporate Parkway, P.O. Box 610, Center Valley, PA 18034-0610, U.S.A. Tel. 1-888-553-4448

<http://www.olympusamerica.com>

Free Manuals Download Website

<http://myh66.com>

<http://usermanuals.us>

<http://www.somanuals.com>

<http://www.4manuals.cc>

<http://www.manual-lib.com>

<http://www.404manual.com>

<http://www.luxmanual.com>

<http://aubethermostatmanual.com>

Golf course search by state

<http://golfingnear.com>

Email search by domain

<http://emailbydomain.com>

Auto manuals search

<http://auto.somanuals.com>

TV manuals search

<http://tv.somanuals.com>