

DIGITAL VOICE RECORDER

**VN-120  
VN-240  
VN-480  
VN-120PC  
VN-240PC  
VN-480PC**

**EN INSTRUCTIONS**

Thank you for purchasing an Olympus Digital Voice Recorder. Please read these instructions for information about using the product correctly and safely. Keep the instructions handy for future reference.

To ensure successful recordings, we recommend that you test the record function and volume before use.

OLYMPUS CORPORATION  
Shinjuku Monolith, 3-1 Nishi-Shinjuku 2-chome, Shinjuku-ku, Tokyo 163-0914, Japan. Tel. 03-3340-2111  
OLYMPUS AMERICA INC.  
Two Corporate Center Drive, Melville, NY 11747-3157, U.S.A. Tel. 1-800-622-6372  
OLYMPUS EUROPA GMBH  
(Premises/Goods delivery) Wendenstrasse 14-18, 20097 Hamburg, Germany. Tel. 040-237730  
(Letters) Postfach 10 49 08, 20034 Hamburg, Germany.  
OLYMPUS UK LTD.  
2-8 Honduras Street, London EC1W 0TX, United Kingdom, Tel. 020-7253-2772  
http://www.olympus.com

**Identification of Parts**

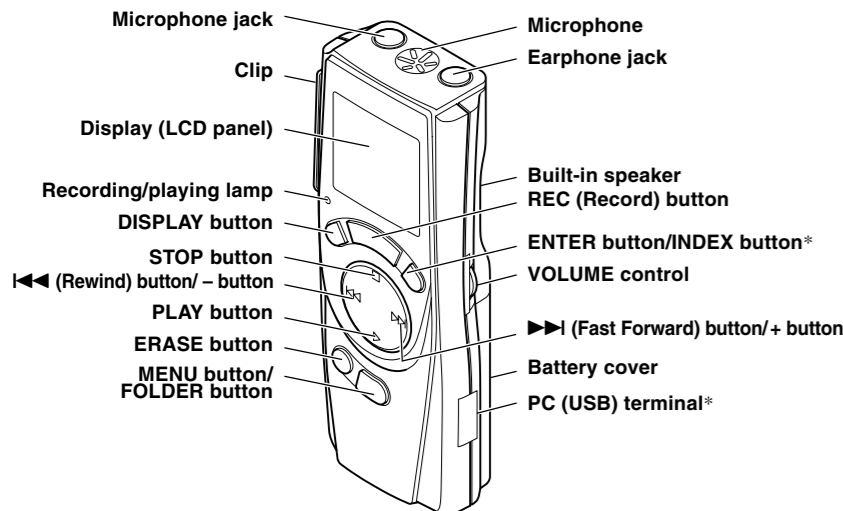

\* INDEX button....VN-240/VN-240PC/VN-480/VN-480PC  
PC (USB) terminal....VN-120PC/VN-240PC/VN-480PC

**Getting Started**

**Inserting Batteries**

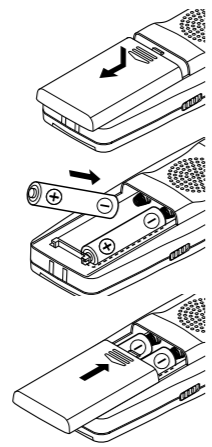

- 1 Lightly press down on the arrow and slide the battery cover open.
- 2 Insert two size-AAA alkaline batteries, observing the correct polarity.
- 3 Close the battery cover completely. Time/Date screen appears. The hour indicator flashes, indicating the start of the Time/Date setup process. (See "Setting Time/Date" for details)

An optional Ni-MH Rechargeable Battery from Olympus can be used for the recorder.

**Replacing Batteries**

When appears on the display, replace the batteries as soon as possible. Size-AAA alkaline batteries are recommended. When the batteries are depleted, appears on the display, and the recorder shuts off. It is recommended to set the HOLD switch to the HOLD position before you replace batteries to maintain the current settings (time/date, etc.). For your convenience, the recorder also logs the current settings in nonvolatile memory at hourly intervals.

**Standby Mode and Display Shut Off**

If the recorder is stopped or paused for 60 minutes or longer during recording or playing, it goes into Standby (power-save) mode, and the display shuts off. To exit Standby mode and turn on the display, press any button.

**Setting Time/Date (TIME)**

If you have set the time and date, information as to when a sound file was recorded is stored automatically with that file. The time and date must be set to enable management of files in folder S (VN-240/VN-240PC/VN-480/VN-480PC), for the alarm playback function, and for the timer recording (VN-480/VN-480PC).

When you install batteries for the first time or each time you replace the batteries, the hour indication will flash. In such a case, be sure to set the time and date by following steps 5 through 9 described below.

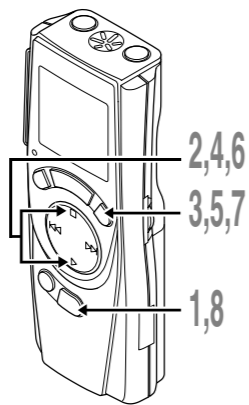

- 1 Press and hold the MENU button for 1 second or longer.
- 2 Press the STOP or PLAY button until "TIME" flashes on the display.
- 3 Press the ENTER button. The hour indicator flashes.
- 4 Press the STOP or PLAY button to set the hour.
- 5 Press the ENTER button to accept the minute. The minute indicator flashes. Pressing the - button enables the hour setting again.
- 6 Press the STOP or PLAY button to set the minute. Repeat steps 5 and 6 to continue to set the year, month and date in the same way.
- 7 After setting the date, press the ENTER button. This completes the time/date setup procedure.
- 8 Press the MENU button.

- You can switch the time indication between the 12-hour system and the 24-hour system by pressing the DISPLAY button while you are setting the hour or minute.
- You can change the order of the date indication by pressing the DISPLAY button while you are setting the year, month, or day. (Example: February 14, 2004)

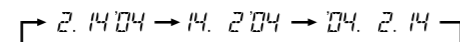

**Hold**

Set the HOLD switch to the HOLD position. All operation buttons are disabled. This feature is useful when the recorder has to be carried in a handbag or pocket. Remember to reset the HOLD switch before attempting to use the recorder.

- Notes**
- The alarm will sound at the scheduled time even if the recorder is set to HOLD. The recorder will then begin to play the file associated with the alarm once you press any button.
  - The recorder functions as follows with the HOLD switch set to the HOLD position:
    - If the recorder is playing, the display goes dark when playback of the current file has completed.
    - When you set the HOLD switch to the HOLD position while playing back, you can still adjust the volume using the VOLUME control.
    - If the recorder is recording, the display goes dark when the recorder stops recording automatically upon running out of free memory.

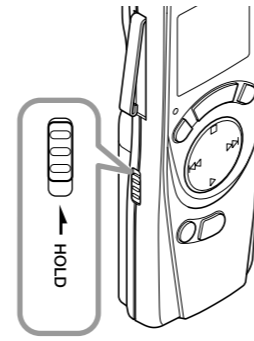

**Clip**

**How to Use the Clip**

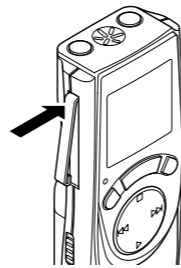

- Press the area that the arrow points to.
- Do not force the clip wider, as it may break.

**Notes on the Folders**

The recorder has four folders: A, B, C, and S. To change the folder selection, press the FOLDER button while the recorder is stopped.

- Folders A, B, and C
- Each recorded file is stored in a folder. Using folders to classify files makes it convenient to find files you want to access later.
- Folder S (VN-240/VN-240PC/VN-480/VN-480PC) This folder has date subfolders\* from January 1 to December 31. Up to 10 files can be stored in each date subfolder, a useful feature for schedule management by storing a certain day's schedule for future reference. To switch between date subfolders, select the S folder, then press the + or - button while the recorder is stopped. Up to a total of 100 files can be recorded in folder S. \* There is one subfolder for each day of the year.

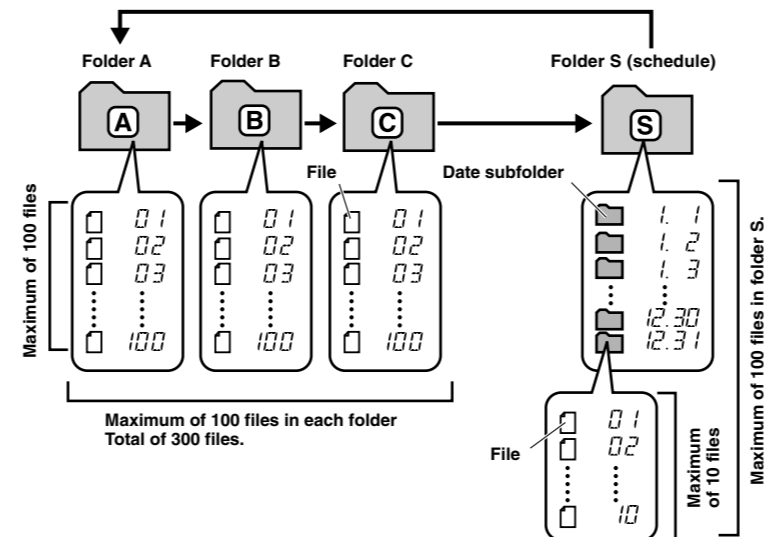
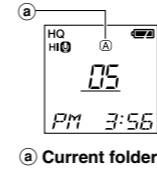

**Recording**

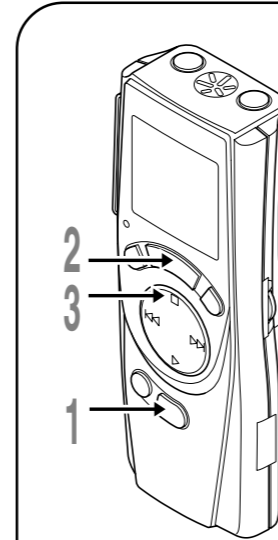

- 1 Press the FOLDER button to select the desired folder (A, B, C or S). When you select folder S, the current date subfolder appears on the display.
  - If you select folder S, press the + or - button to select the desired date subfolder.
- 2 Press the REC button to start recording. The Recording/playing lamp turns red, and recording starts.
- 3 To stop recording, press the STOP button. New recordings are saved as the last file in the folder.

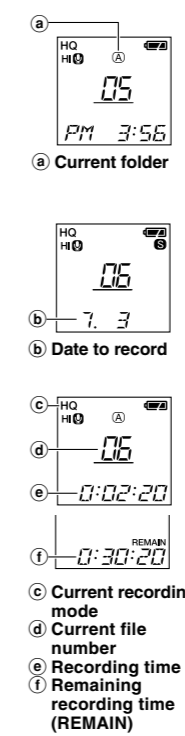

**To Pause Recording**

**To pause**  
Press the REC button during recording. "PAUSE" appears on the display and the Recording/playing lamp flashes.

**To resume recording**  
Press the REC button again. Recording will resume at the point of interruption.

**Notes**

- If "FULL" appears on the display, you cannot record in the selected folder. In such a case, erase unnecessary files or download to PC (VN-120PC/VN-240PC/VN-480PC).
- If the recorder is placed directly on a table when recording a meeting, it tends to pick up table vibrations. Put a notebook or other item between the table and the recorder for clearer recording.
- Even if you press the DISPLAY button, the display will not change to current recording time if the remaining recording time is 5 minutes or less.
- When remaining recording time falls to 1 minute or less, the Recording/playing lamp flashes red.
- The recorder will enter Stop mode if it has been left paused for 10 minutes or longer.
- In case of difficult acoustic conditions or low speaker's voice, recording in HQ or SP is recommended. Also, usage of an external microphone (sold separately) could improve the quality of recordings.

**LCD Display Information**

You can select an option for the display of the recorder. This help review and confirm different recorder settings and file information.

State of the recorder	Operation	Display
While in Stop mode	Press and hold the STOP button	The total number of files recorded in the folder and remaining recording time appears on the display.
	Press the DISPLAY button	Time → Remaining recording time → Date → Time . . . (with folder A, B or C selected) The selected indication appears on the display each time the recorder is stopped.
While in record mode	Press the DISPLAY button	The display switches between current recording time and remaining recording time.
While in playback mode	Press the DISPLAY button	Playing time → Remaining playing time → Recording date of the file → Recording time of the file → Playing time . . .

**Playing Back**

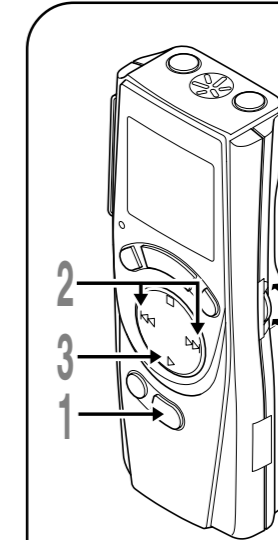

- 1 Press the FOLDER button to select the desired folder (A, B, C or S).
- 2 Press the + or - button to select the file to play back. If you select folder S, select the desired date subfolder.
  - When you select the desired date subfolder, it is useful to press and hold the + or - button for 1 second or longer. The recorder locates the next date subfolder that contains recorded files.
- 3 Press the PLAY button to start playback. The Recording/playing lamp turns green, and the elapsed playing time is indicated on the display.
- 4 Use the VOLUME control to adjust the volume to your liking.

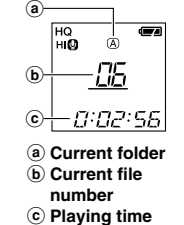

**Canceling Playback**

- To stop**  
Press the STOP button. The recorder stops in the middle of the file being played.
- To resume playback**  
Press the PLAY button again. Playback will resume at the point of interruption.

When you play back a file in the date subfolder without choosing a specified file, the recorder will play back all the files in the selected date subfolder from filename "01". When you play back a file immediately after recording the file, only the most recently recorded file will be played back.

**Forwarding and Rewinding**

- Fast Forward**  
Press and hold the button while playing a file. When you release the button, the recorder will resume normal playback.
- Rewind**  
Press and hold the button while playing a file. When you release the button, the recorder will resume normal playback.

- No sound is heard from the built-in speaker during fast forwarding or rewinding.
- The end of the file is located by pressing and holding the button during fast forwarding. The recorder will pause at the end of the file. If you do not release the button, the recorder will continue fast forward.
- The beginning of the file is located by pressing and holding the button during rewinding. The recorder will pause at the beginning of the file. If you do not release the button, the recorder will continue rewinding.

**Changing Playing Speed**

You can change the playing speed by pressing the PLAY button while the recorder is playing back.

Normal speed → Slow playback (-20%) → Fast playback (+30%)

- When the slow playback mode is selected, the "SLOW" appears and, for the fast playback mode, "FAST" appears on the display while the recorder is playing back.
- The recorder stops playing when you press the STOP button while playing back in the slow/fast mode, or when it reaches to the end of the file. If you once press the STOP button and start playback again, the recorder will play back files in normal speed as well.

**Locating the beginning of the file**

While the recorder is playing back in the slow/fast mode, pressing the + or - button forwards or rewinds to the beginning of the previous or next file respectively. If an index mark is encountered midway, playback begins at that point. (See "Index Marks" for details)

**Listening with earphones**

You can listen to files by connecting earphones to the earphone jack. If an earphone is connected, the speaker doesn't emit sound. Sound will be played back monaurally.

\* An earphone is not provided with VN-120, VN-120PC, VN-240 and VN-480. You can use any standard 3.5mm monaural earphone or headphone.



## Free Manuals Download Website

<http://myh66.com>

<http://usermanuals.us>

<http://www.somanuals.com>

<http://www.4manuals.cc>

<http://www.manual-lib.com>

<http://www.404manual.com>

<http://www.luxmanual.com>

<http://aubethermostatmanual.com>

Golf course search by state

<http://golfingnear.com>

Email search by domain

<http://emailbydomain.com>

Auto manuals search

<http://auto.somanuals.com>

TV manuals search

<http://tv.somanuals.com>